

Electromagnetic Emission
FCC MEASUREMENT REPORT
CERTIFICATION OF COMPLIANCE
FCC Part 15 Certification Measurement

PRODUCT : GPS combined Radar detector
MODEL/TYPE NO : P-01-01 / Proto-type
FCC ID : VVV-P0101
BRAND NAME : -
APPLICANT : Adaptiv Technologies, LLC
1639 11th Street, Suite 156, Santa Monica, CA 90404, U.S.A.
Attn. : Adam Gold / Director
MANUFACTURER : Willtronics Co., Ltd.
301 Kwanlidong, KwangMyung Industrial Complex, 201 Haan-3-Dong,
KwangMyung, Kyungki, Korea, 423-063
EQUIPMENT CLASS : DSC (Part 15 Security/Remote Control Transmitter)
TYPE OF MODULATION : ASK
FREQUENCY CHANNEL : 418.00 MHz (1 CH)
ANTENNA TYPE : PCB Pattern Loop Antenna (Unique Type)
FCC RULE PART(S) : FCC Part 15 Subpart C
FCC PROCEDURE : ANSI C63.10-2013
TEST REPORT No. : ETLT161017.0115
DATES OF TEST : November 02, 2016 to November 03, 2016
REPORT ISSUE DATE : November 17, 2016
TEST LABORATORY : ETL Inc. (FCC Designation Number : KR0022)

This is GPS combined Radar detector, Model P-01-01 Version has been tested in accordance with the measurement procedures specified in ANSI C63.10-2013 at the ETL Test Laboratory and has been shown to be complied with the electromagnetic radiated emission limits specified in FCC Rule Part15 Subpart C section 15.231.

I attest to the accuracy of data. All measurement herein was performed by me or was made under my supervision and is correct to the best of my knowledge and belief. I assume full responsibility for the completeness of these measurements and vouch for the qualifications of all persons taking them.

The results of testing in this report apply to the product/system which was tested only. Other similar equipment will not necessarily produce the same results due to production tolerance and measurement uncertainties.

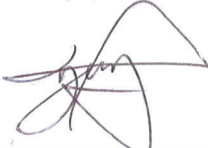
Prepared by: 
Seok Lyong, Choi (Test Engineer)
November 17, 2016

Reviewed by: 
Kug Kyoung, Yoon (Chief Engineer)
November 17, 2016

ETL Inc.

Head office: #371-51, Gasan-dong, Geumcheon-gu, Seoul, 153-803, Korea
Open site: #499-1, Sagot-ri, Seosin-myeon, Hwaseong-si, Gyeonggi-do, 445-882, Korea
Tel: 82-2-858-0786 Fax: 82-2-858-0788

Table of Contents

FCC Measurement Report

- 1. Introduction**
- 2. Product Information**
- 3. Description of Tests**
- 4. Test Condition**
- 5. Test Results**
 - 5.1 Summary of Test Results**
 - 5.2 20 dB Bandwidth**
 - 5.3 Radiated Emissions for Periodic radiators**
 - 5.4 Fundamental Radiated Emission**
 - 5.5 Harmonic Radiated Emission**
 - 5.6 Periodic Operation Measurement Plot**
- 6. Sample Calculation**
- 7. List of test Equipment used for Measurement**

FCC MEASUREMENT REPORT

Scope – Measurement and determination of electromagnetic emission(EME) of radio frequency devices including intentional radiators and/or unintentional radiators for compliance with the technical rules and regulations of the U.S Federal Communications Commission(FCC)

General Information

Applicant Name	: Adaptiv Technologies, LLC
Address	: 1639 11th Street, Suite 156, Santa Monica, CA 90404, U.S.A.
Attention	: Adam Gold / Director

- **EUT Type** : GPS combined Radar detector
 - **Model Number** : P-01-01
 - **FCC ID** : VWV-P0101
 - **S/N** : Proto-type
 - **Freq. Range** : 418 MHz
 - **Number of Channels** : 1 CH
 - **Modulation Technique** : ASK
 - **Antenna Type** : PCB Pattern Loop Antenna (Unique Type)
 - **Environmental of Tests** : Temperature: (19.3 ± 6.4) °C
 - : Humidity: (39 ± 4) % R.H.
 - : Atmospheric Pressure: (102.4 ± 0.2) kPa
 - **FCC Rule Part(s)** : FCC Part 15 Subpart C
 - **Test Procedure** : ANSI C63.10-2013
 - **Equipment Class** : DSC (Part 15 Security/Remote Control Transmitter)
 - **Place of Tests** : ETL Inc. Testing Lab. (FCC Designation Number : KR0022)
- Radiated Emission test 1;
#499-1, Sagot-ri, Seosin-myeon, Hwaseong-si,
Gyeonggi-do, 445-882, Korea
- Radiated Emission test 2 and Conducted Emission test;
#371-51, Gasan-dong, Geumcheon-gu, Seoul, 153-803, Korea

1. INTRODUCTION

The measurement test for radiated and conducted emission test was conducted at the ETL Inc. The site is constructed in conformance with the requirements of the ANSI C63.10-2013 and CISPR Publication 16. The ETL has site descriptions on file with the FCC for 3 m and 10 m site configurations. Detailed description of test facility was found to be in compliance with FCC Rules according to the ANSI C63.10-2013 and registered to the Federal Communications Commission (FCC Designation Number : KR0022).

The measurement procedure described in American National Standard for Method of Measurement of Radio-Noise Emission from Low-Voltage Electrical and Electronic Equipment in the Range of 9 kHz to 40 GHz (ANSI C63.10-2013) was used in determining radiated and conducted emissions from the Adaptiv Technologies, LLC
Model: P-01-01

2. PRODUCT INFORMATION

2.1 Equipment Description

The Equipment Under Test (EUT) is the GPS combined Radar detector (model: P-01-01).

2.2 General Specification

General		
Dimensions	75 mm (W) x 115 mm (L) x 48 mm (H)	
Weight	198 g	
Power Requirement	CAR Battery 12 V DC	
Temperature Range	Operating	(30 ± 50) °C
	Storage	(30 ± 70) °C
High Internal Frequency	X-tal → 24 MHz	
Laser Detector		
Receiver Type	Pulse Laser Signal Receiver	
Sensor Front End	Convex Condenser Lens	
Detector Type	Pulse Width Discriminator	
Receiver Bandwidth	30 MHz	
Spectral Response	800 nm – 1 100 nm	
Radar Detector		
Receiver Type	Double Conversion Super heterodyne	
Detector Type	Scanning Frequency Discriminator	
Antenna Type	Linear Polarization	
Frequency of Operation	10.525 GHz ± 50 MHz (X Band)	
	24.150 GHz ± 100 MHz (K Band)	
	34.700 GHz ± 1 300 MHz (Ka Band)	
GPS Detector		
Receiver Type & Freq.L1 Freq C/A code	1 575.42 MHz	
GPS Chipset	ublox chipset ver. 8.0	
Antenna Type	PATCH Antenna (Linear Polarization)	
Transmitter Frequency (Tx)		
Transmitter	Manual Tx & Semi Auto	
	418.00 MHz ± 75 kHz	
Modulation	ASK (Amplitude shift keying)	
Transmitter used in device	SAW (surface acoustic wave) RESONATOR	
	ITF4180	
Transmission power	Typ. -25 dBm (< -20 dBm)	
Tolerance of transmission frequency	± 20 ppm	
Modulation contents	Digital data	
Data rate	16 bit/70 ms	

3. DESCRIPTION OF TESTS

The tests documented in this report were performed in accordance with ANSI C63.10-2013 and FCC CFR 47 15.207, 15.209 and 15.231.

3.1 Radiated Emission Measurement

Radiated emission measurements were made in accordance with § 13 in ANSI C63.10-2013 "Measurement of Intentional radiators" The measurements were performed over the frequency range of 30 MHz to 40 GHz using antenna as the input transducer to a Spectrum analyzer or a Field Intensity Meter. The measurements were made with the detector set for "Peak, Quasi-peak, Average" within a bandwidth of 120 kHz and above 1 GHz is 1 MHz.

Preliminary measurements were made at 3 m using broadband antennas, and spectrum analyzer to determine the frequency producing the maximum emission in shielded room. Appropriate precaution was taken to ensure that all emission from the EUT were maximized and investigated. The system configuration, mode of operation, turntable azimuth and height with respect to the antenna were noted for each frequency found. The spectrum was scanned from 30 MHz to 1 000 MHz using Log-Bicon antenna. Above 1 GHz, linearly polarized double ridge horn antennas were used. Final measurements were made open site or SVSWR chamber at 3 m. The test equipment was placed on a styrofoam table. Sufficient time for the EUT, support equipment, and test equipment was allowed in order for them to warm up to their normal operating condition. Each frequency found during pre-scan measurements was re-examined by manual. The EUT, support equipment and interconnecting cables were re-configured to the set-up producing the maximum emission for the frequency and were placed on top of a table height for below 1GHz is 0.8 m, and for above 1GHz is 1.5 m. nonmetallic 1.0 m x 1.5 m table. The EUT, support equipment, and interconnecting cables were re-arranged and manipulated to maximize each emission. The turntable containing the system was rotated; the antenna height was varied 1 m to 4 m and stopped at the azimuth or height producing the maximum emission.

Varying the mode of operating frequencies of the EUT maximized each emission. The system was tested in all the three orthogonal planes and changing the polarity of the antenna. The worst-case emissions are recorded in the data tables. If necessary, the radiated emission measurement could be performed at a closer distance to ensure higher accuracy and the results were extrapolated to the specified distance using an inverse linear distance extrapolation factor (20 dB/decade) as per section 15.31(f).

Photographs of the worst-case emission can be seen in Photographs of the worst-case emission test setup can be seen in Appendix B.

3.2 FCC Part 15.205 Restricted Bands of Operations

(a) Except as shown in paragraph (d) of this section, only spurious emissions are permitted in any of the frequency bands listed below:

MHz	MHz	MHz	GHz
0.090 - 0.110	16.42 - 16.423	399.9 - 410	4.5 - 5.15
¹ 0.495 - 0.505	16.694 75 - 16.695 25	608 - 614	5.35 - 5.46
2.173 5 - 2.190 5	16.804 25 - 16.804 75	960 - 1 240	7.25 - 7.75
4.125 - 4.128	25.5 - 25.67	1 300 - 1 427	8.025 - 8.5
4.177 25 - 4.177 75	37.5 - 38.25	1 435 - 1 626.5	9.0 - 9.2
4.207 25 - 4.207 75	73 - 74.6	1 645.5 - 1 646.5	9.3 - 9.5
6.215 - 6.218	74.8 - 75.2	1 660 - 1 710	10.6 - 12.7
6.267 75 - 6.268 25	108 - 121.94	1 718.8 - 1 722.2	13.25 - 13.4
6.311 75 - 6.312 25	123 - 138	2 200 - 2 300	14.47 - 14.5
8.291 - 8.294	149.9 - 150.05	2 310 - 2 390	15.35 - 16.2
8.362 - 8.366	156.524 75 - 156.525 25	2 483.5 - 2 500	17.7 - 21.4
8.376 25 - 8.386 75	156.7 - 156.9	2 690 - 2 900	22.01 - 23.12
8.414 25 - 8.414 75	162.012 5 - 167.17	3 260 - 3 267	23.6 - 24.0
12.29 - 12.293	167.72 - 173.2	3 332 - 3 339	31.2 - 31.8
12.519 75 - 12.520 25	240 - 285	3 345.8 - 3 358	36.43 - 36.5
12.576 75 - 12.577 25	322 - 335.4	3 600 - 4 400	(²)
13.36 - 13.41			

¹ Until February 1, 1999, this restricted band shall be 0.490 MHz - 0.510 MHz.

² Above 38.6

(b) Except as provided in paragraphs (d) and (e), the field strength of emissions appearing within these frequency bands shall not exceed the limits shown in Section 15.209. At frequencies equal to or less than 1 000 MHz, compliance with the limits in Section 15.209 shall be demonstrated using measurement instrumentation employing a CISPR quasi-peak detector. Above 1 000 MHz, compliance with the emission limits in Section 15.209 shall be demonstrated based on the average value of the measured emissions. The provisions in Section 15.35 apply to these measurements.

3.3 Antenna requirement

(1) According to §15.203

An intentional radiator shall be designed to ensure that no antenna other than that furnished by the responsible party shall be used with the device. The use of a permanently attached antenna or of an antenna that uses a unique coupling to the intentional radiator shall be considered sufficient to comply with the provisions of this Section. The manufacturer may design the unit so that a broken antenna can be replaced by the user, but the use of a standard antenna jack or electrical connector is prohibited. This requirement does not apply to carrier current devices or to devices operated under the provisions of Sections 15.211, 15.213, 15.217, 15.219, or 15.221. Further, this requirement does not apply to intentional radiators that must be professionally installed, such as perimeter protection systems and some field disturbance sensors, or to other intentional radiators which, in accordance with Section 15.31(d), must be measured at the installation site. However, the installer shall be responsible for ensuring that the proper antenna is employed so that the limits in this Part are not exceeded.

Antenna Type: PCB Pattern Loop Antenna (Unique Type)

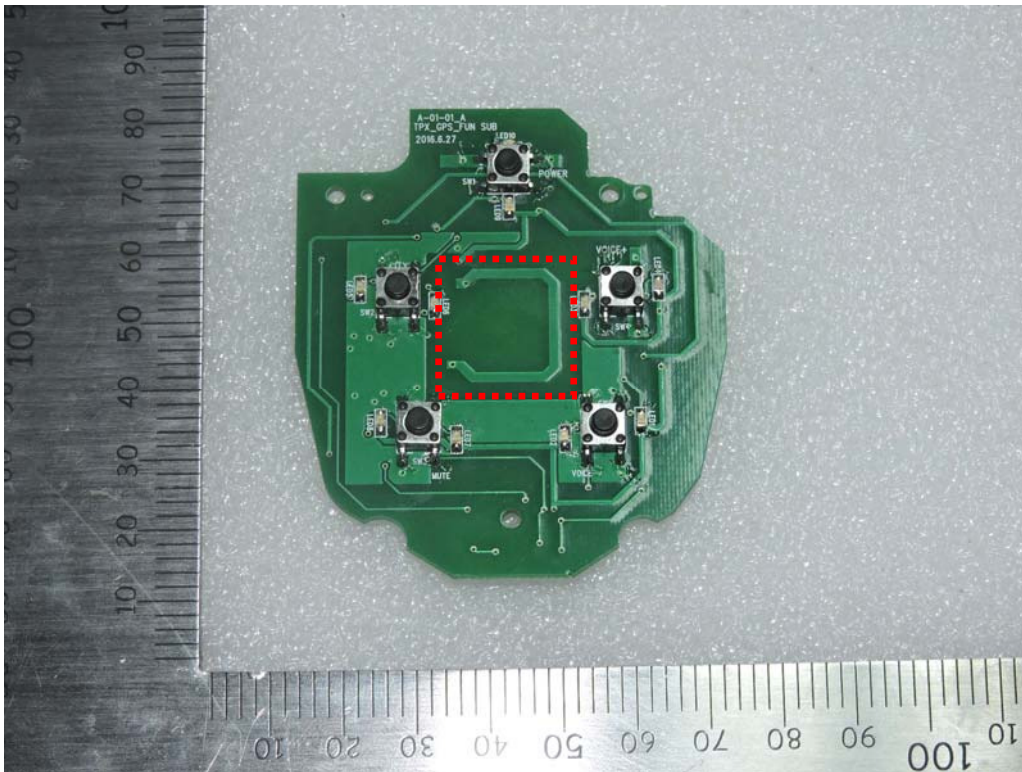

4. TEST CONDITION

4.1 Test Configuration

The device was configured for testing in a typical fashion (as a customer would normally use it). During the tests, the following conditions and configurations were used.

4.2 EUT operation

The EUT was connected as user's guide. And during the test executed EUT is operating on the following

- Function of transmitter

The EUT (model: P-01-01) has been tested under operating condition.
Fixed Channel (418.00 MHz) was chosen for testing.

* Measurements were performed with the EUT oriented in 3 orthogonal(X, Y, Z) axis and rotated 360 degrees worst-case orientation for maximum emissions.

4.3 The setup drawing(s)

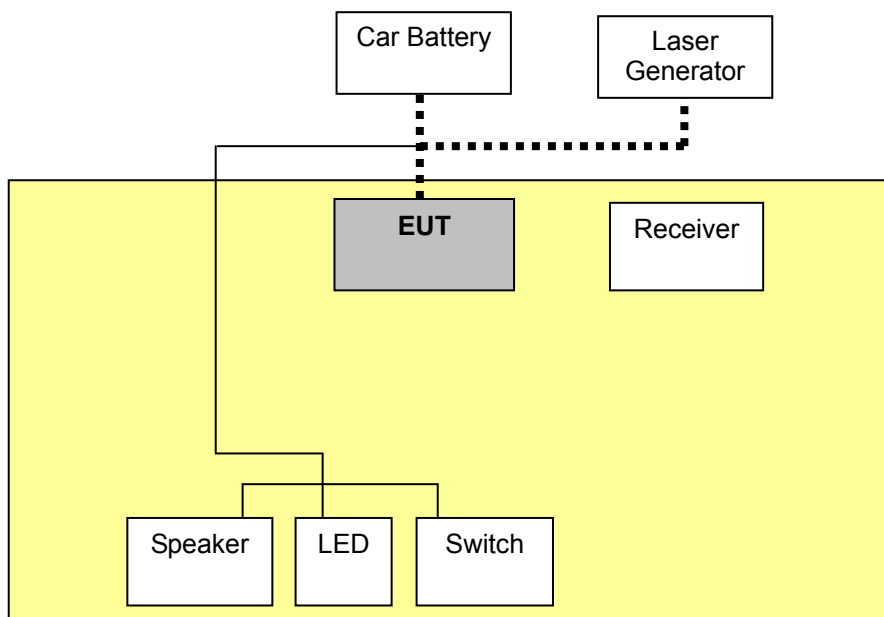

- : Signal line
- : AC Power line
- : DC Power line
- : Adapter

5. TEST RESULTS

5.1 Summary of Test Results

The measurement results were obtained with the EUT tested in the conditions described in this report. Detailed measurement data and plots showing the maximum emission of the EUT are reported.

Applied Standard : 47 CFR Part 15, Subpart C			
FCC Rule	Measurement Required	Result	Remarks
15.207(a)	Power line Conducted Emissions	N/A	1)
15.231(a)(1)	Manually operated transmitter	Pass	
15.231(a)(2)	Automatically activated transmitter	N/A	
15.231(a)(3)	Periodic transmissions at regular predetermined intervals	Pass	
15.231(a)(4)	Radiators used in cases of emergency	N/A	
15.231(a)(5)	Set-up information for security systems	Pass	
15.209(a),231(b)	Radiated Emissions	Pass	
15.231(c)	20 dB Bandwidth	Pass	
15.231(d)	Devices operating within the frequency band 40.66 MHz - 40.70 MHz	N/A	2)
15.231(e)	Radiated emissions for Periodic radiators	N/A	2)

Notes:

- 1) The EUT is powered by DC power supply that uses car battery only.
- 2) The frequency range of EUT is 418.00 MHz fixed.

The data collected shows that the **Adaptiv Technologies, LLC / GPS combined Radar detector / P-01-01** complied with technical requirements of above rules part 15.209 and 15.231 limits.

The equipment is not modified anything, mechanical or circuits to improve EMI status during a measurement. No EMI suppression device(s) was added and/or modified during testing.

5.2 20 dB Bandwidth

EUT	GPS combined Radar detector / P-01-01
Limit apply to	FCC Part 15. 231(c)
Test Date	November 02, 2016
Environmental of Test	(18.3 ± 0.3) °C, (40 ± 0) % R.H., (102.6 ± 0.0) kPa
Operating Condition	Continues transmitter (418.00 MHz)
Result	Passed

Limit

The bandwidth of the emission shall be no wider than 0.25% of the center frequency for devices operating above 70 MHz and below 900 MHz. For devices operating above 900 MHz, the emission shall be no wider than 0.5% of the center frequency. Bandwidth is determined at the points 20 dB down from the modulated carrier.

Test Data

Center Frequency [MHz]	Measured occupied bandwidth [MHz]	Limit [MHz]	Result
418.00	0.430	1.045 (0.25%)	Pass

NOTES:

1. Please see the measured bandwidth plot in next page.
2. The bandwidth is determined at the points 20 dB down from the modulated carrier.

20 dB Bandwidth

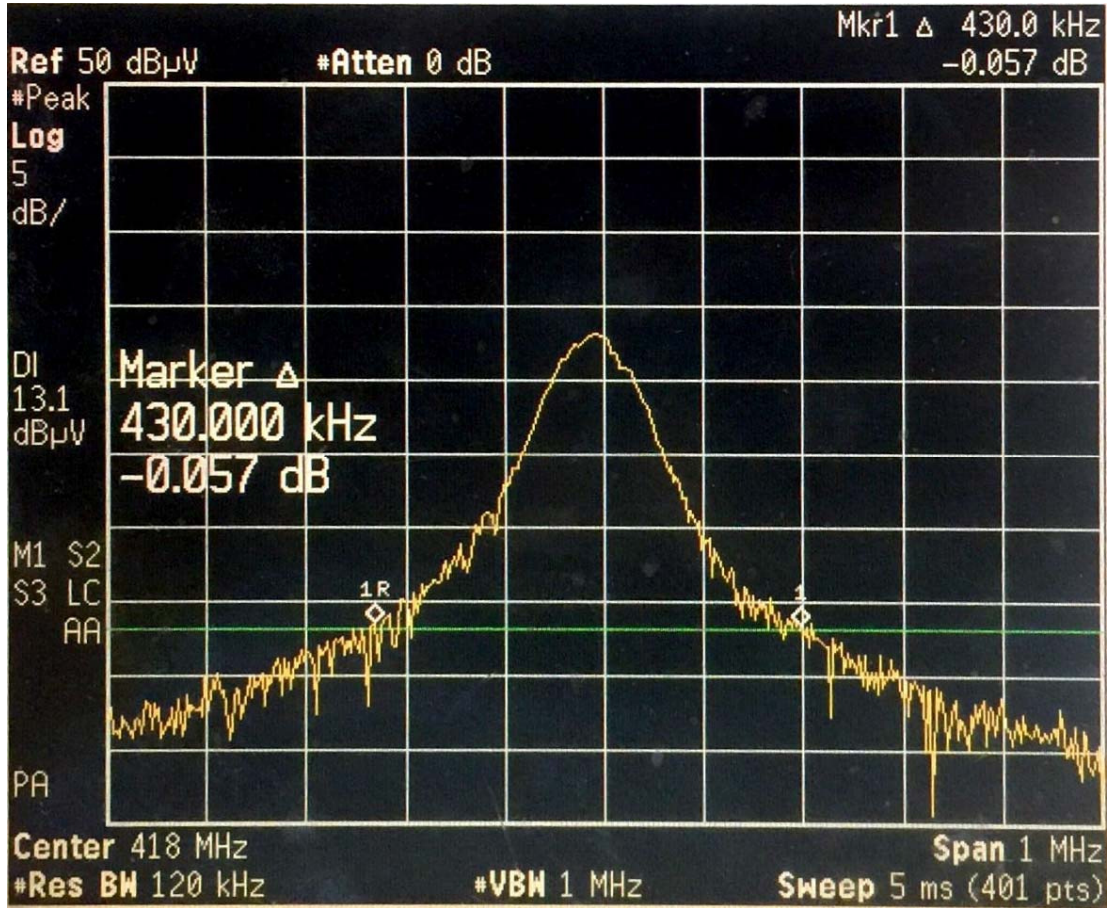

5.3 Radiated Emissions for Periodic radiators

EUT	GPS combined Radar detector / P0101
Limit apply to	FCC Part 15.209(a) & 15.231(b)
Operating Condition	Continues transmitter (418.00 MHz)
Result	Passed

Part 15.209(a) except as provided elsewhere in this Subpart, the emissions from an intentional radiator shall not exceed the field strength levels specified in the following table:

Frequencies [MHz]	Field Strength [$\mu\text{V/m}$]	Measurement Distance [m]
0.009 - 0.490	2 400/F(kHz)	300
0.490 - 1.705	24 000/F(kHz)	30
1.705 - 30.0	30	30
30 - 88	100	3
88 - 216	150	3
216 - 960	200	3
Above 960	500	3

Part 15.231(b) In addition to the provisions of Section 15.205, the field strength of emissions from intentional radiators operated under this Section shall not exceed the following:

Fundamental Frequency [MHz]	Field Strength of Fundamental [$\mu\text{V/m}$]	Field Strength of Spurious Emission [$\mu\text{V/m}$]
40.66 - 40.70	2 250	225
70 - 130	1 250	125
130 - 174	1 250 to 3 750**	125 to 375**
174 - 260	3 750	375
260 - 470	3 750 to 12 500**	375 to 1 250**
Above 470	12 500	1 250

** linear interpolations

[Where F is the frequency in MHz, the formulas for calculating the maximum permitted fundamental field strengths are as follows: for the band 130 MHz - 174 MHz, $\mu\text{V/m}$ at 3 m = $56.818 \log(F) - 6.136363$; for the band 260 MHz - 470 MHz, $\mu\text{V/m}$ at 3 m = $41.6667 \log(F) - 7.083333$. The maximum permitted unwanted emission level is 20 dB below the maximum permitted fundamental level.]

Fundamental: $\mu\text{V/m}$ at 3 m = $41.6667(418.00) - 7.083333 = 10.3333473 = 20 \log 10.3333473$
= **80.28 dB($\mu\text{V/m}$)**

Spurious emissions: $\mu\text{V/m}$ at 3 m = **20 dB below of fundamental level**
= **60.28 dB($\mu\text{V/m}$)**

Test Results

- Refer to see the measured plot in next page.

Radiated Emissions Test data

- 9 kHz to 30 MHz

Test Date	November 02, 2016
Environmental of Test	(13.7 ± 0.8) °C, (36 ± 1) % R.H., (102.5 ± 0.0) kPa

The following table shows the highest levels of radiated emissions on both polarizations of horizontal and vertical.
Detector mode: CISPR Quasi-Peak mode (100 Hz, 9 kHz)

Frequency [MHz]	Reading [dB(μV)]	Polarization (*H/**V)	Ant. Factor [dB/m]	Cable Loss [dB]	Result [dB(μV/m)]	Limit [dB(μV/m)]	Margin [dB]
	Emission attenuated more than 20 dB below the limit are not reported.						

Result: All emissions below noise floor of 20 dB(μV/m).

NOTES:

1. * H : Horizontal polarization, ** V : Vertical polarization
2. The cable loss value was included the Amp. Gain.
3. Result = Reading + Antenna factor + Cable loss
4. Margin = Limit - Result
5. The measurement was performed for the frequency range 9 kHz to 30 MHz according to FCC Part 15.209.

- Below 1 GHz (30 MHz to 1 GHz)

Test Date	November 02, 2016
Environmental of Test	(14.5 ± 0.8) °C, (39 ± 2) % R.H., (102.5 ± 0.0) kPa

The following table shows the highest levels of radiated emissions on both polarizations of horizontal and vertical. Detector mode: CISPR Quasi-Peak mode (6 dB Bandwidth: 120 kHz)

Frequency [MHz]	Reading [dB(μV)]	Polarization (*H/**V)	Ant. Factor [dB/m]	Cable Loss [dB]	Height [cm]	Result [dB(μV/m)]	Limit [dB(μV/m)]	Margin [dB]
35.45	48.42	V	12.13	-30.85	100	29.70	40.00	10.30
44.99	45.54	V	13.15	-30.69	102	28.00	40.00	12.00
216.11	48.70	V	10.13	-28.73	110	30.10	46.00	15.90
287.70	45.62	V	13.08	-28.10	117	30.60	46.00	15.40
337.11	51.07	H	14.43	-27.70	392	37.80	46.00	8.20
360.09	48.03	H	14.98	-27.51	390	35.50	46.00	10.50

NOTES:

1. * H : Horizontal polarization, ** V : Vertical polarization
2. The cable loss value was included the Amp. Gain.
3. Result = Reading + Antenna factor + Cable loss
4. Margin value = Limit - Result
5. The measurement was performed for the frequency range above 30 MHz according to FCC Part 15.209.

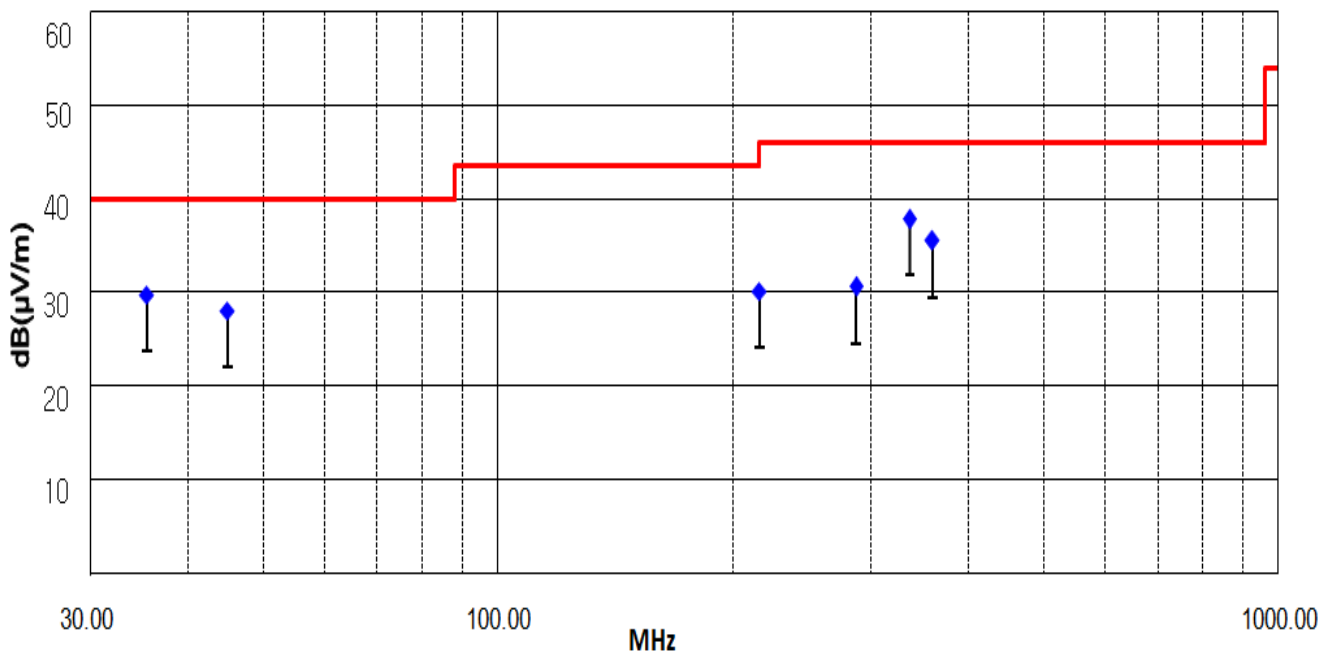

- Above 1 GHz (1 GHz to 4.4 GHz)

Test Date	November 03, 2016
Environmental of Test	(25.1 ± 0.5) °C, (40 ± 2) % R.H., (102.2 ± 0.0) kPa

Frequency [MHz]	Reading [dB(μV)]		Polarity (*H/**V)	Ant. Factor [dB/m]	Cable - Amp. Gain [dB]	Result [dB(μV/m)]		Limit [dB(μV/m)]		Margin [dB]	
	Peak	Average				Peak	Average	Peak	Average	Peak	Average
1 016.16	60.60	56.94	V	25.03	-40.17	45.46	41.80	73.97	53.97	28.51	12.17
1 670.64	53.32	59.31	V	25.81	-39.27	39.86	45.85	73.97	53.97	34.11	8.12
2 143.32	53.62	56.36	V	26.53	-38.68	41.47	44.21	73.97	53.97	32.50	9.76
2 470.56	54.61	56.35	V	27.32	-38.37	43.56	45.30	73.97	53.97	30.41	8.67
2 688.72	54.01	57.39	V	27.87	-38.02	43.86	47.24	73.97	53.97	30.11	6.73
2 862.44	52.88	52.59	H	28.30	-37.72	43.46	43.17	73.97	53.97	30.51	10.80

NOTES:

1. * H : Horizontal polarization, ** V : Vertical polarization
2. Factor = Antenna factor + Cable loss - Amp. Gain
3. Result = Reading + Factor
4. Margin value = Limit - Result
5. Measuring frequencies from 1 GHz to the 10th harmonic of highest fundamental frequency.
6. Measurements above show only up to 6 maximum emissions noted, or would be lesser if no specific emissions from the EUT are recorded (ie: margin > 20 dB from the applicable limit) and considered that's already beyond the background noise floor.
7. Spectrum setting:
 - a. Peak Setting 1 GHz to 10th harmonics of fundamental, RBW = 1 MHz, VBW = 1 MHz, Sweep = Auto
 - b. AV Setting 1 GHz to 10th harmonics of fundamental, RBW = 1 MHz, VBW = 10 kHz, Sweep = Auto

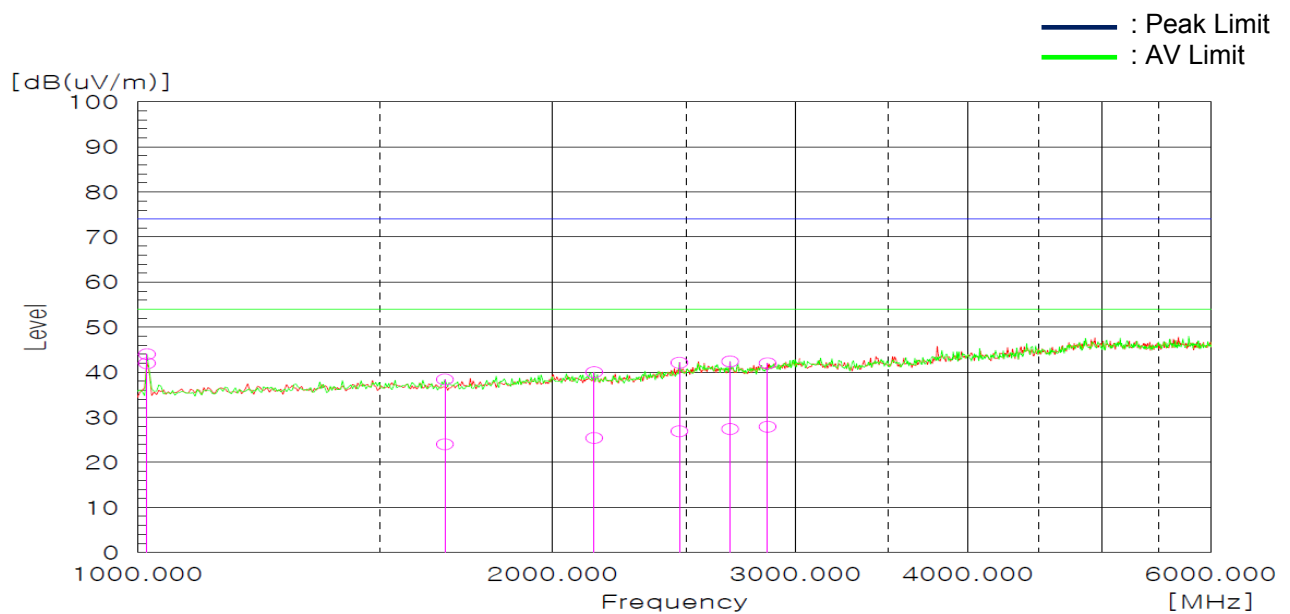

5.4 Fundamental Radiated Emission

EUT	GPS combined Radar detector / P-01-01
Limit apply to	FCC Part 15.231(b)
Test Date	November 02, 2016
Environmental of Test	(15.7 ± 0.4) °C, (37 ± 2) % R.H., (102.5 ± 0.0) kPa
Operating Condition	Continues transmitter (418.00 MHz)
Result	Passed

Part 15.231(b) In addition to the provisions of Section 15.205, the field strength of emissions from intentional radiators operated under this Section shall not exceed the following:

Fundamental Frequency [MHz]	Field Strength of Fundamental [microvolts/meter]	Field Strength of Spurious Emission [microvolts/meter]
40.66 - 40.70	2 250	225
70 - 130	1 250	125
130 - 174	1 250 to 3 750**	125 to 375**
174 - 260	3 750	375
260 - 470	3 750to 12 500**	375 to 1 250**
Above 470	12 500	1 250

** linear interpolations

[Where F is the frequency in MHz, the formulas for calculating the maximum permitted fundamental field strengths are as follows: for the band 130 MHz - 174 MHz, $\mu\text{V}/\text{m}$ at 3 meters = $56.818 \log(F) - 6136.3636$; for the band 260 MHz - 470 MHz, $\mu\text{V}/\text{m}$ at 3 meters = $41.6667(F) - 7083.3333$. The maximum permitted unwanted emission level is 20 dB below the maximum permitted fundamental level.]

Fundamental: $\mu\text{V}/\text{m}$ at 3 meters = $41.6667(418.00) - 7083.3333 = 10333.347 = 20\log * 10333.347$
= **80.28 dB($\mu\text{V}/\text{m}$)**

Spurious emissions: $\mu\text{V}/\text{m}$ at 3 meters = **20 dB below of fundamental level**
= **60.28 dB($\mu\text{V}/\text{m}$)**

Fundamental Radiated Emission Test Data

The following table shows the highest levels of radiated emissions on both polarizations of horizontal and vertical.

- Detector mode: Peak mode

Frequency [MHz]	Polarization (*H/**V)	Peak Result [dB(μV/m)]	Peak Limit [dB(μV/m)]	Peak Margin [dB]
418.00	H	51.20	100.28	49.08

- Detector mode: Average mode

Frequency [MHz]	Polarization (*H/**V)	Duty Cycle Factor [dB]	Peak Result [dB(μV/m)]	AV Limit [dB(μV/m)]	AV Margin [dB]
418.00	H	-25.15	51.20	80.28	54.23

NOTES:

1. * H : Horizontal polarization, ** V : Vertical polarization
2. Result = Reading + Antenna factor + Cable loss
3. Margin value:
 - a. Peak Margin = Peak Limit - Peak Result
 - b. AV Margin = AV Limit - (Peak Result + Duty Cycle Factor)
4. Spectrum setting:
 - a. Peak Setting 1 GHz to fundamental, RBW = 1 MHz, VBW = 1 MHz, Sweep = Auto

5.5 Harmonic Radiated Emission

EUT	GPS combined Radar detector / P-01-01
Limit apply to	FCC Part 15.231(b)
Test Date	November 02, 2016
Environmental of Test	(16.1 ± 0.2) °C, (38 ± 1) % R.H., (102.5 ± 0.0) kPa
Operating Condition	Continues transmitter (418.00 MHz)
Result	Passed

Harmonic Radiated Emission Test Data

The following table shows the highest levels of radiated emissions on both polarizations of horizontal and vertical.

- Detector mode: Peak and Average mode

Frequency [MHz]	Polarization (*H/**V)	Result [dB(μV/m)]	Limit [dB(μV/m)]	Margin [dB]
		No signal detect Harmonic		

NOTES:

1. * H : Horizontal polarization, ** V : Vertical polarization
2. Result = Reading + Antenna factor + Cable loss - Amp. Gain
3. Margin value
 - a. Peak Margin = Limit - Result
 - b. AV Margin = Limit - Result + Duty Cycle Factor
4. Measuring frequencies from 1 GHz to the 10th harmonic of highest fundamental frequency.
5. Spectrum setting:
 - a. Peak Setting 1 GHz to 10th harmonics of fundamental, RBW = 1 MHz, VBW = 1 MHz, Sweep = Auto
 - b. AV Setting 1 GHz to 10th harmonics of fundamental, RBW = 1 MHz, VBW = 10 Hz, Sweep = Auto
6. Pulse Desensitization Correction Factor
 Pulse Width (PW) = 0.1 ms * 7 = 0.7 ms
 2/PW = 2/0.7 ms = 2.86 kHz
 RBW (100 kHz) > 2/PW (2.86 kHz)
 Therefore PDCF is not needed

5.6 Periodic Operation Measurement Plot

Test Date	November 02, 2016
Environmental of Test	(18.9 ± 0.4) °C, (41 ± 2) % R.H., (102.6 ± 0.0) kPa
Result	Passed

TX on time = 12.67 ms

Limit(s) = 5 s

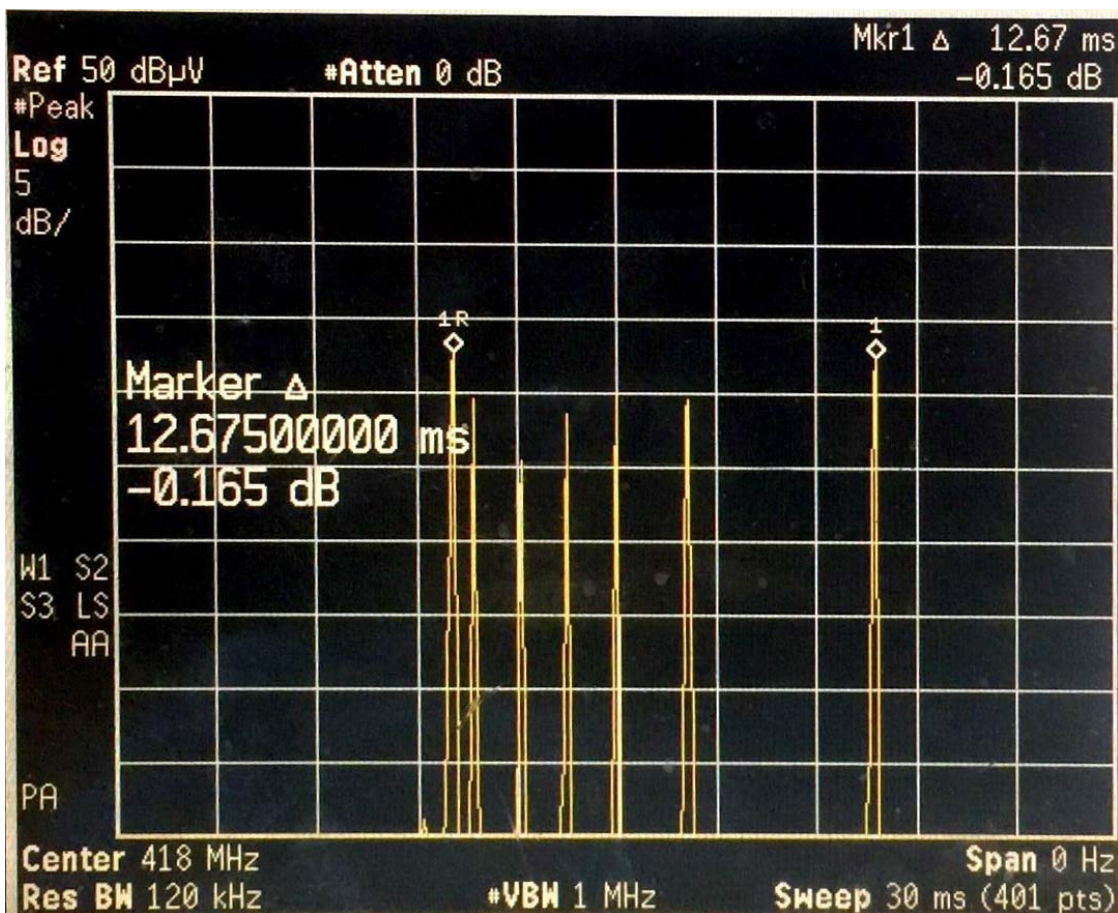

5.6.1 Duty cycle

Calculation;

Duty cycle factor = $20\log(\text{on time/period})$

$$20\log(0.7 \text{ ms}/12.67 \text{ ms}) = -25.15 \text{ dB}$$

On time = $0.1 \text{ ms} * 7 = 0.7 \text{ ms}$

Period = 12.67 ms

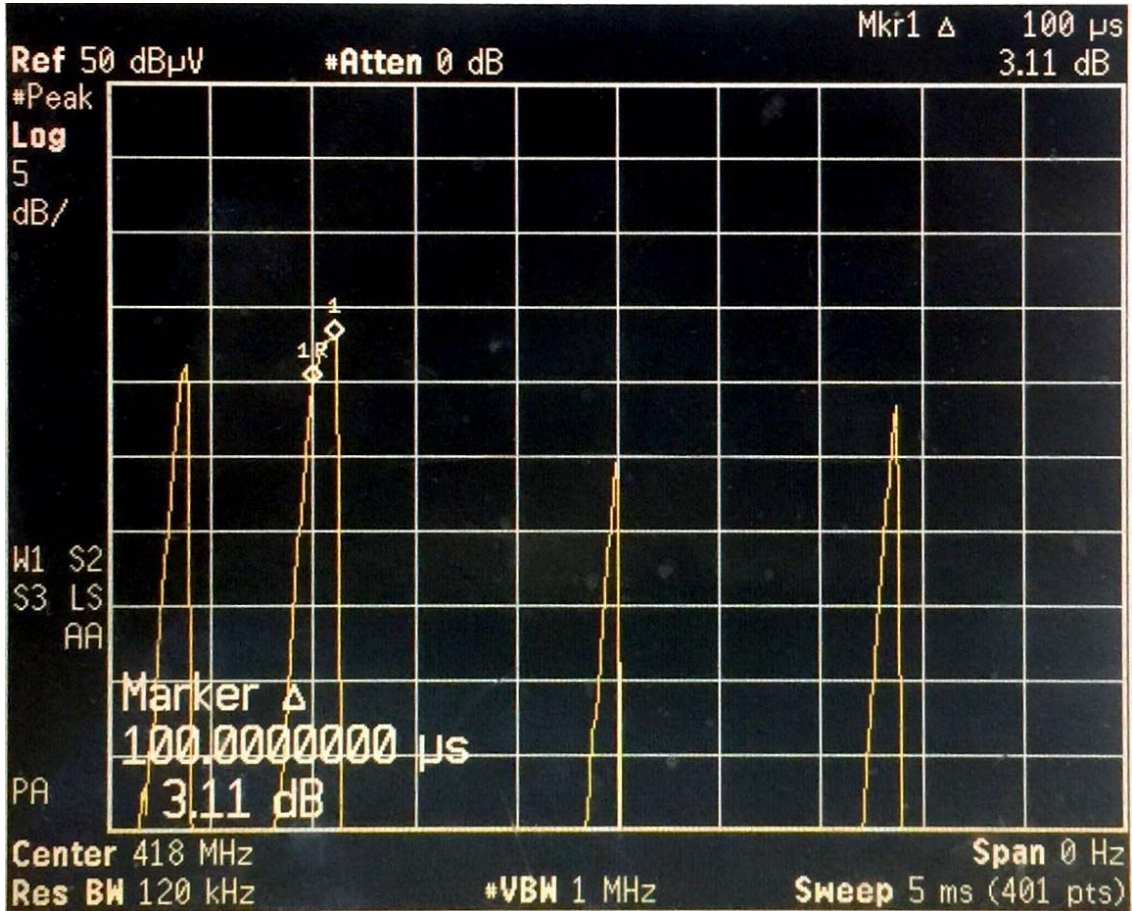

6. SAMPLE CALCULATION

Sample Field Strength Calculation

The field strength is calculated by adding the Antenna Factor and Cable Factor.
The basic equation with a sample calculation is as follows:

$$FS = RA + AF + CF$$

Where FS = Field Strength

RA = Receiver Amplitude

AF = Antenna Factor

CF = Cable Attenuation Factor - Pre-amplifier Factor

$$dB(\mu V) = 20 \log_{10} (\mu V) : \text{Equation}$$

$$dB(\mu V) = dBm + 107$$

Example: @ 1 670.64 MHz

$$\text{Limit} = 53.97 \text{ dB}(\mu V/m)$$

$$\text{Reading} = 59.31 \text{ dB}(\mu V)$$

$$\text{Antenna Factor} + (\text{Cable Loss} - \text{Amp. Gain}) = 25.81 + (-39.27) = -13.46 \text{ dB}(\mu V/m)$$

$$\text{Total} = 59.31 + (-13.46) = 45.85 \text{ dB}(\mu V/m)$$

$$\text{Margin} = 53.97 - 45.85 = 8.12 \text{ dB}$$

$$= 8.12 \text{ dB below Limit}$$

7. List of test equipments used for measurements

	Test Equipment	Model	Mfg.	Serial No.	Cal. Date	Cal. Due Date
<input checked="" type="checkbox"/>	EMI TEST RECEIVER	ESPI3	ROHDE & SCHWARZ.	100478	16.09.01	17.09.01
<input checked="" type="checkbox"/>	EMI TEST RECEIVER	ESCI7	ROHDE & SCHWARZ.	100851	16.09.01	17.09.01
<input checked="" type="checkbox"/>	Loop Antenna	6502	EMCO	00033743	16.09.05	18.09.05
<input checked="" type="checkbox"/>	LogBicon Antenna(FCC)	VULB9160	Schwarzbeck	3164	15.06.08	17.06.08
<input checked="" type="checkbox"/>	Horn Antenna(FCC)	BBHA 9120D	Schwarzbeck	826	16.03.23	18.03.23
<input checked="" type="checkbox"/>	PSA Series Spectrum Analyzer	E4440A	Agilent	US40420382	16.09.05	17.09.05
<input checked="" type="checkbox"/>	AMPLIFIER	TK-PA18	TESTEK	120020	16.09.01	17.09.01
<input checked="" type="checkbox"/>	AMPLIFIER	310N	SONOMA INSTRUMENT	284750	16.09.02	17.09.02
<input checked="" type="checkbox"/>	Controller	HD2000	HD GmbH	C/125	N/A	N/A
<input checked="" type="checkbox"/>	Turn-Table	DS1200-S	Innco Systems GmbH	2740311	N/A	N/A
<input checked="" type="checkbox"/>	Antenna Master	MA4000	AUDIX	N/A	N/A	N/A
<input checked="" type="checkbox"/>	Turn-Table	TT 1.35 SI	SES	-	N/A	N/A
<input checked="" type="checkbox"/>	Antenna Master	AM 4.5	SES	-	N/A	N/A