



Test Mode: TX / IEEE 802. 11ac 80 / 5290MHz /(CH High)

Tested by: Darry Wu

Ambient temperature: 24°C Relative humidity: 52% RH

Date: May 10, 2017

Frequency (MHz)	Reading (dBuV)	Correction Factor (dB/m)	Result (dBuV/m)	Limit (dBuV/m)	Margin (dB)	Antenna Pole (V/H)	Remark
7872.000	33.08	9.40	42.48	68.23	-25.75	V	peak
8148.000	33.33	9.57	42.90	68.23	-25.33	V	peak
9912.000	32.16	11.73	43.89	68.23	-24.34	V	peak
10104.000	31.70	12.30	44.00	68.23	-24.23	V	peak
11136.000	33.36	15.02	48.38	68.23	-19.85	V	peak
12600.000	32.05	16.63	48.68	68.23	-19.55	V	peak
6864.000	33.32	7.48	40.80	68.23	-27.43	H	Peak
7380.000	32.89	8.44	41.33	68.23	-26.90	H	Peak
8148.000	32.99	9.57	42.56	68.23	-25.67	H	Peak
10092.000	32.36	12.27	44.63	68.23	-23.60	H	peak
11148.000	32.43	15.01	47.44	68.23	-20.79	H	peak
12624.000	31.75	16.71	48.46	68.23	-19.77	H	peak

Remark:

1. Measuring frequencies from 1 GHz to the 10th harmonic of highest fundamental frequency.
2. Radiated emissions measured in frequency above 1000MHz were made with an instrument using peak/average detector mode.
3. Average test would be performed if the peak result were greater than the average limit.
4. Data of measurement within this frequency range shown " --- " in the table above means the reading of emissions are attenuated more than 20dB below the permissible limits or the field strength is too small to be measured.
5. Measurements above show only up to 6 maximum emissions noted, or would be lesser, with " N/A " remark, if no specific emissions from the EUT are recorded (ie: margin>20dB from the applicable limit) and considered that's already beyond the background noise floor.
6. Margin (dB) = Remark result (dBuV/m) – Average limit (dBuV/m).



Test Mode: TX / IEEE 802.11ac 80 / 5530MHz

Tested by: Darry Wu

Ambient temperature: 24°C Relative humidity: 52% RH

Date: May 10, 2017

Frequency (MHz)	Reading (dBuV)	Correction Factor (dB/m)	Result (dBuV/m)	Limit (dBuV/m)	Margin (dB)	Antenna Pole (V/H)	Remark
6804.000	33.59	7.38	40.97	68.23	-27.26	V	peak
7920.000	33.44	9.49	42.93	68.23	-25.30	V	peak
9336.000	32.99	10.07	43.06	68.23	-25.17	V	peak
10680.000	32.03	14.09	46.12	68.23	-22.11	V	peak
11160.000	32.86	15.01	47.87	68.23	-20.36	V	peak
12732.000	31.56	17.06	48.62	68.23	-19.61	V	peak
8148.000	33.72	9.57	43.29	68.23	-24.94	H	Peak
9564.000	32.59	10.72	43.31	68.23	-24.92	H	Peak
10596.000	32.09	13.83	45.92	68.23	-22.31	H	Peak
11148.000	32.86	15.01	47.87	68.23	-20.36	H	peak
12624.000	31.65	16.71	48.36	68.23	-19.87	H	peak
13032.000	31.02	18.03	49.05	68.23	-19.18	H	peak

Remark:

1. Measuring frequencies from 1 GHz to the 10th harmonic of highest fundamental frequency.
2. Radiated emissions measured in frequency above 1000MHz were made with an instrument using peak/average detector mode.
3. Average test would be performed if the peak result were greater than the average limit.
4. Data of measurement within this frequency range shown " --- " in the table above means the reading of emissions are attenuated more than 20dB below the permissible limits or the field strength is too small to be measured.
5. Measurements above show only up to 6 maximum emissions noted, or would be lesser, with " N/A " remark, if no specific emissions from the EUT are recorded (ie: margin>20dB from the applicable limit) and considered that's already beyond the background noise floor.
6. Margin (dB) = Remark result (dBuV/m) – Average limit (dBuV/m).



Test Mode: TX / IEEE 802.11ac 80 / 5775MHz

Tested by: Darry Wu

Ambient temperature: 24°C Relative humidity: 52% RH

Date: May 10, 2017

Frequency (MHz)	Reading (dBuV)	Correction Factor (dB/m)	Result (dBuV/m)	Limit (dBuV/m)	Margin (dB)	Antenna Pole (V/H)	Remark
6492.000	34.04	6.88	40.92	68.23	-27.31	V	peak
7692.000	33.65	9.05	42.70	68.23	-25.53	V	peak
9588.000	32.17	10.79	42.96	68.23	-25.27	V	peak
10176.000	32.11	12.53	44.64	68.23	-23.59	V	peak
11148.000	32.82	15.01	47.83	68.23	-20.40	V	peak
13020.000	30.58	18.00	48.58	68.23	-19.65	V	peak
7092.000	32.99	7.88	40.87	68.23	-27.36	H	Peak
8112.000	33.31	9.59	42.90	68.23	-25.33	H	Peak
10236.000	31.66	12.71	44.37	68.23	-23.86	H	Peak
10596.000	32.40	13.83	46.23	68.23	-22.00	H	peak
11280.000	32.61	14.96	47.57	68.23	-20.66	H	peak
13248.000	30.82	18.60	49.42	68.23	-18.81	H	peak

**Remark:**

1. Measuring frequencies from 1 GHz to the 10th harmonic of highest fundamental frequency.
2. Radiated emissions measured in frequency above 1000MHz were made with an instrument using peak/average detector mode.
3. Average test would be performed if the peak result were greater than the average limit.
4. Data of measurement within this frequency range shown " --- " in the table above means the reading of emissions are attenuated more than 20dB below the permissible limits or the field strength is too small to be measured.
5. Measurements above show only up to 6 maximum emissions noted, or would be lesser, with " N/A " remark, if no specific emissions from the EUT are recorded (ie: margin>20dB from the applicable limit) and considered that's already beyond the background noise floor.
6. Margin (dB) = Remark result (dBuV/m) – Average limit (dBuV/m).



## 6.8 CONDUCTED UNDESIRABLE EMISSION

### 6.8.1 LIMIT

According to 15.407(b),

- (1) For transmitters operating in the 5.15-5.25 GHz band: all emissions outside of the 5.15-5.35 GHz band shall not exceed an EIRP of -27 dBm/MHz.
- (2) All emissions shall be limited to a level of -27 dBm/MHz at 75 MHz or more above or below the band edge increasing linearly to 10 dBm/MHz at 25 MHz above or below the band edge, and from 25 MHz above or below the band edge increasing linearly to a level of 15.6 dBm/MHz at 5 MHz above or below the band edge, and from 5 MHz above or below the band edge increasing linearly to a level of 27 dBm/MHz at the band edge.
- (3) The provisions of §15.205 apply to intentional radiators operating under this section.

### 6.8.2 MEASUREMENT EQUIPMENT USED

Name of Equipment	Manufacturer	Model	Serial Number	Last Calibration	Due Calibration
Spectrum Analyzer	Agilent	N9010A	MY52221469	02/21/2017	02/20/2018

*Remark: Each piece of equipment is scheduled for calibration once a year.*

### 6.8.3 TEST CONFIGURATION

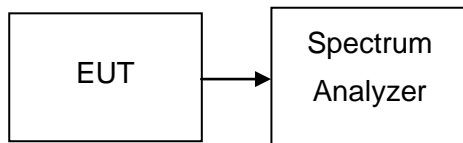

### 6.8.4 TEST PROCEDURE

Conducted RF measurements of the transmitter output were made to confirm that the EUT antenna port conducted emissions meet the specified limit and to identify any spurious signals that require further investigation or measurements on the radiated emissions site.

The transmitter output is connected to the spectrum analyzer. The resolution bandwidth is set to 1MHz. The video bandwidth is set to 3MHz. Peak detection measurements are compared to the average EIRP limit, adjusted for the maximum antenna gain. If necessary, additional average detection measurements are made.

Measurements are made over the 30 MHz to 40 GHz range with the transmitter set to the lowest, middle, and highest channels.



6.8.5 TEST RESULTS

No non-compliance noted

**Test Plot**

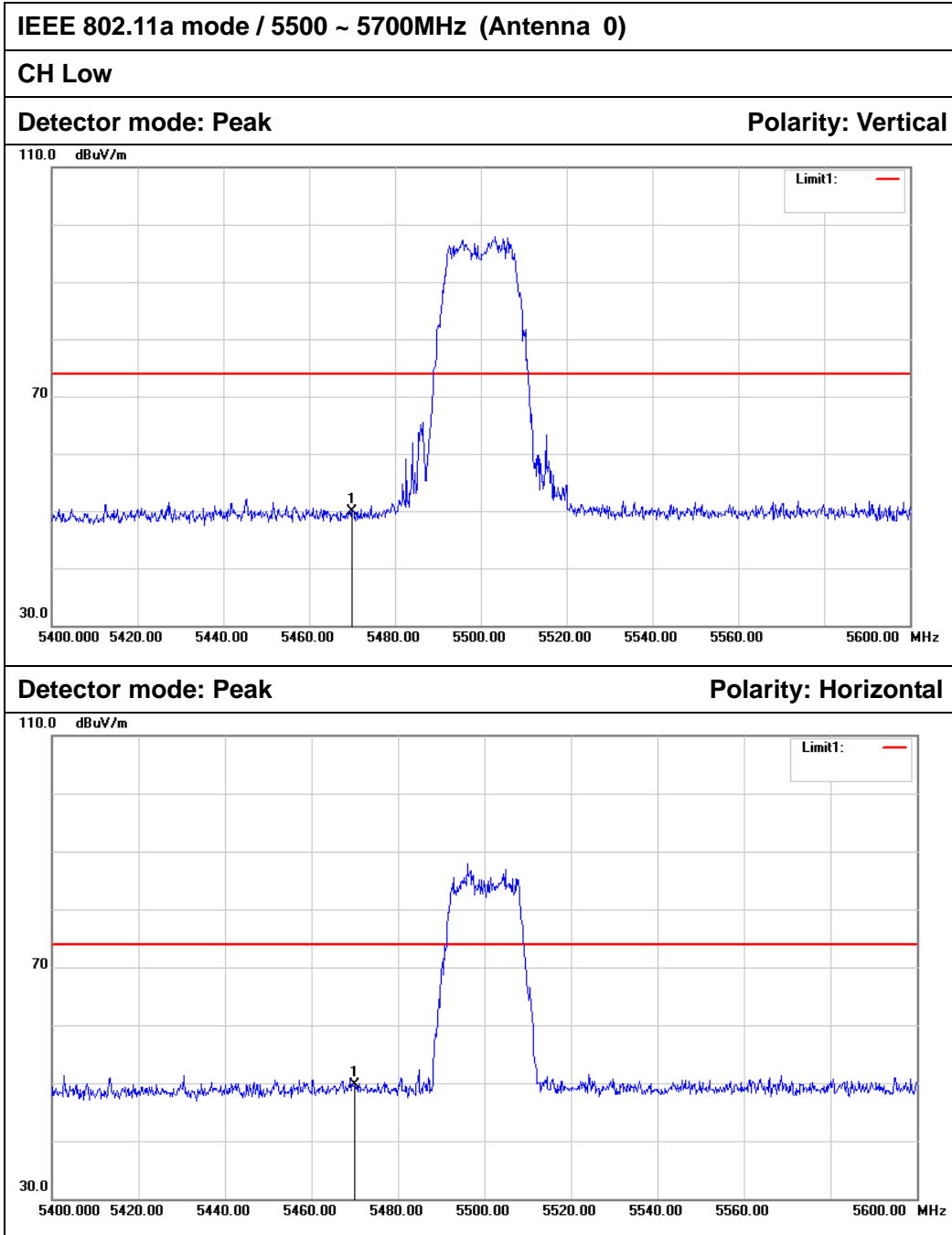

No.	Frequency (MHz)	Reading (dB)	Factor (dB/m)	Result (dB/m)	Limit (dB/m)	Margin (dB)	Remark	Antenna Polar
1	5470.000	44.16	5.82	49.98	74.00	-24.02	Peak	Vertical
2	5470.000	43.90	5.82	49.72	74.00	-24.28	Peak	Horizontal

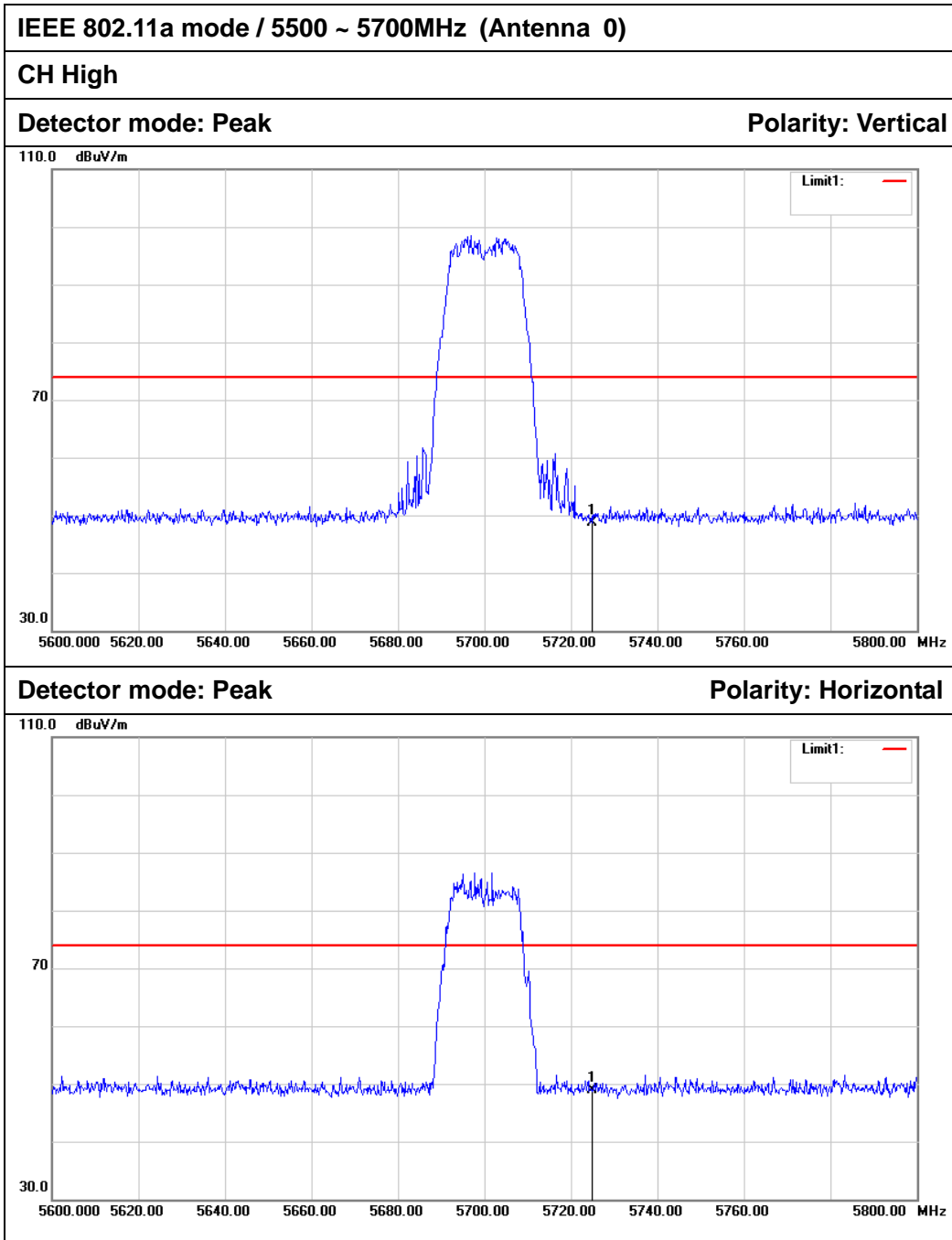

No.	Frequency (MHz)	Reading (dB)	Factor (dB/m)	Result (dB/m)	Limit (dB/m)	Margin (dB)	Remark	Antenna Polar
1	5725.000	42.77	5.96	48.73	74.00	-25.27	Peak	Vertical
2	5725.000	42.91	5.96	48.87	74.00	-25.13	Peak	Horizontal

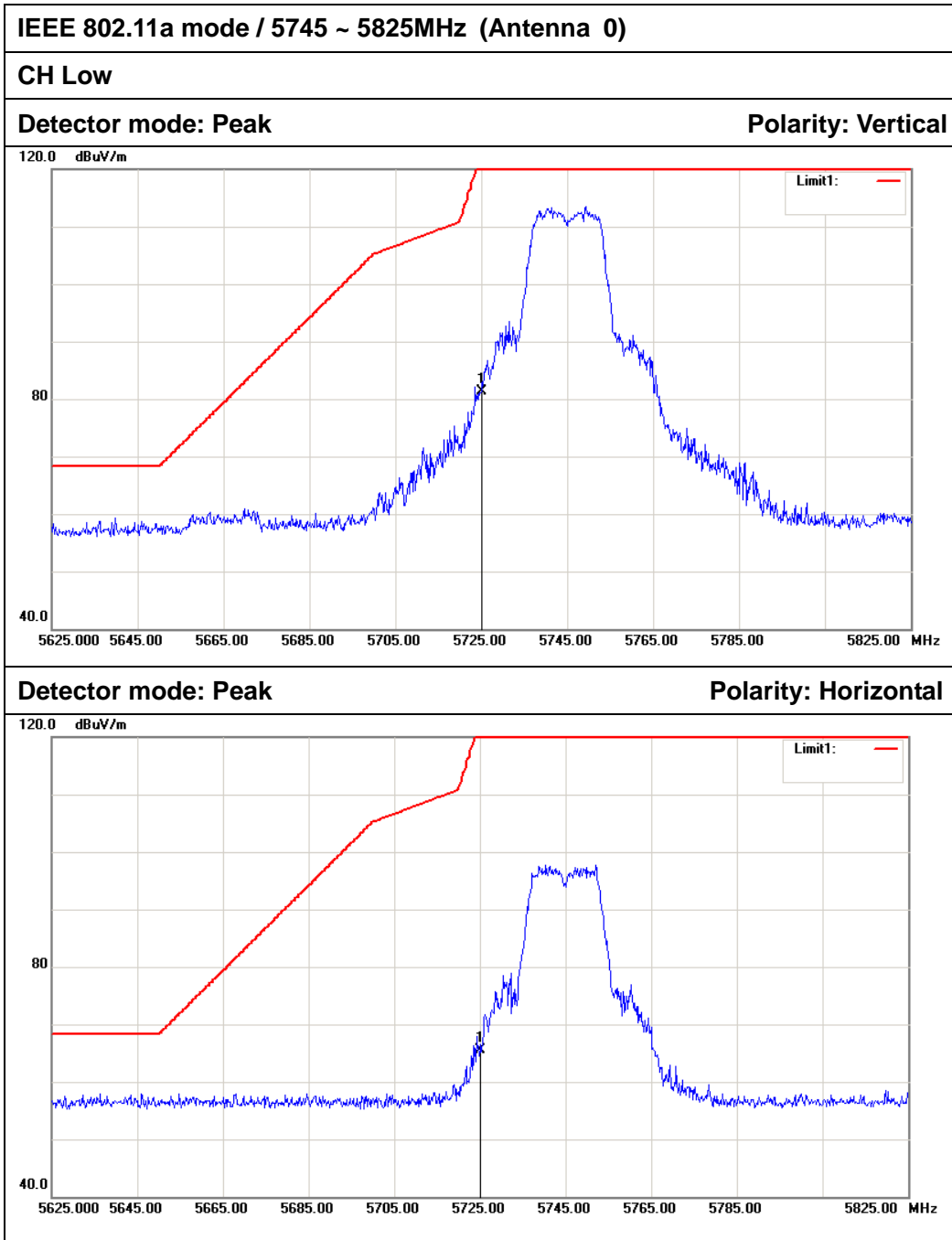

No.	Frequency (MHz)	Reading (dB)	Factor (dB/m)	Result (dB/m)	Limit (dB/m)	Margin (dB)	Remark	Antenna Polar
1	5725.000	75.30	5.96	81.26	122.20	-40.94	Peak	Vertical
2	5725.000	59.63	5.96	65.59	122.20	-56.61	Peak	Horizontal

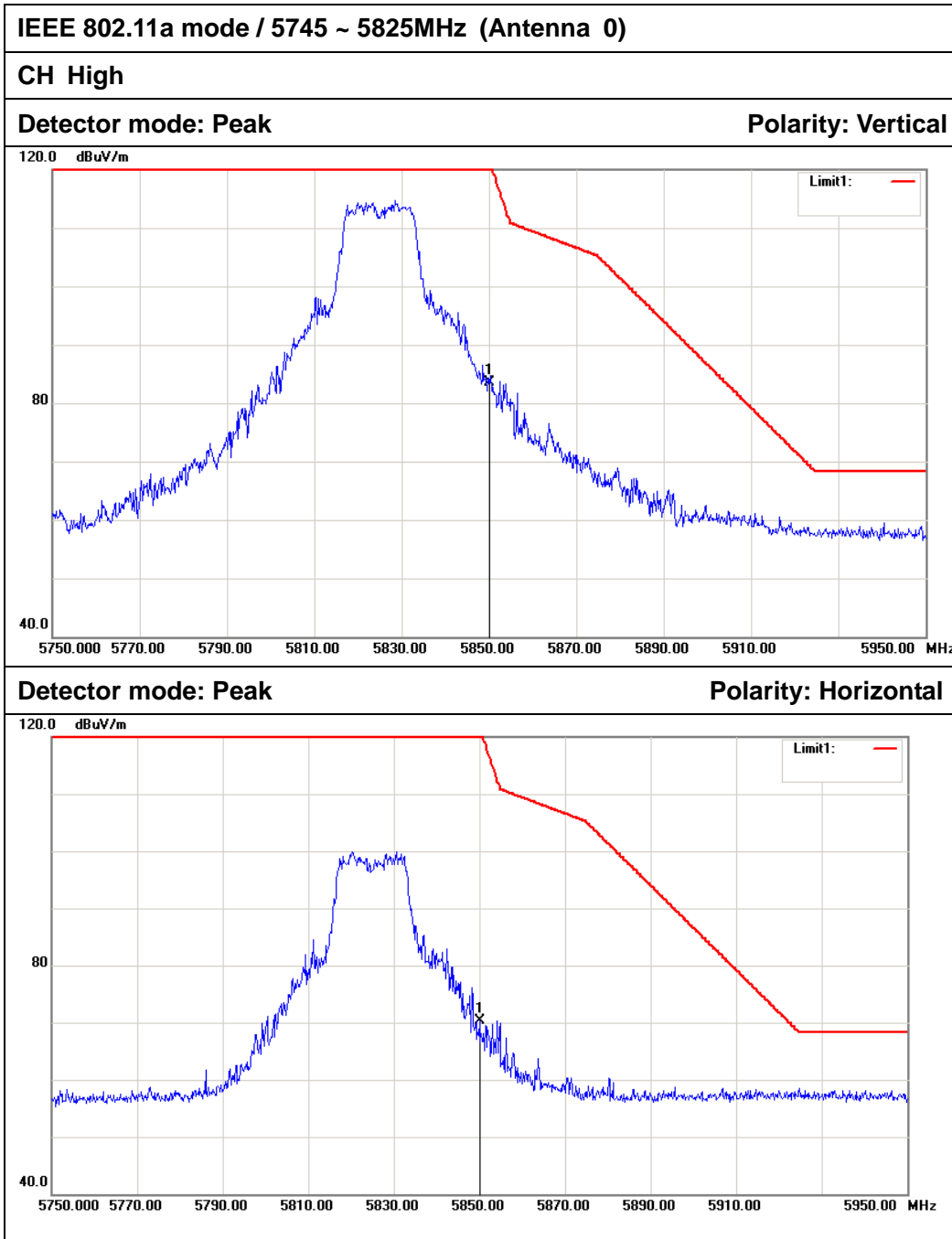

No.	Frequency (MHz)	Reading (dB)	Factor (dB/m)	Result (dB/m)	Limit (dB/m)	Margin (dB)	Remark	Antenna Polar
1	5850.000	77.58	6.02	83.60	122.20	-38.60	Peak	Vertical
2	5850.000	64.19	6.02	70.21	122.20	-51.99	Peak	Horizontal



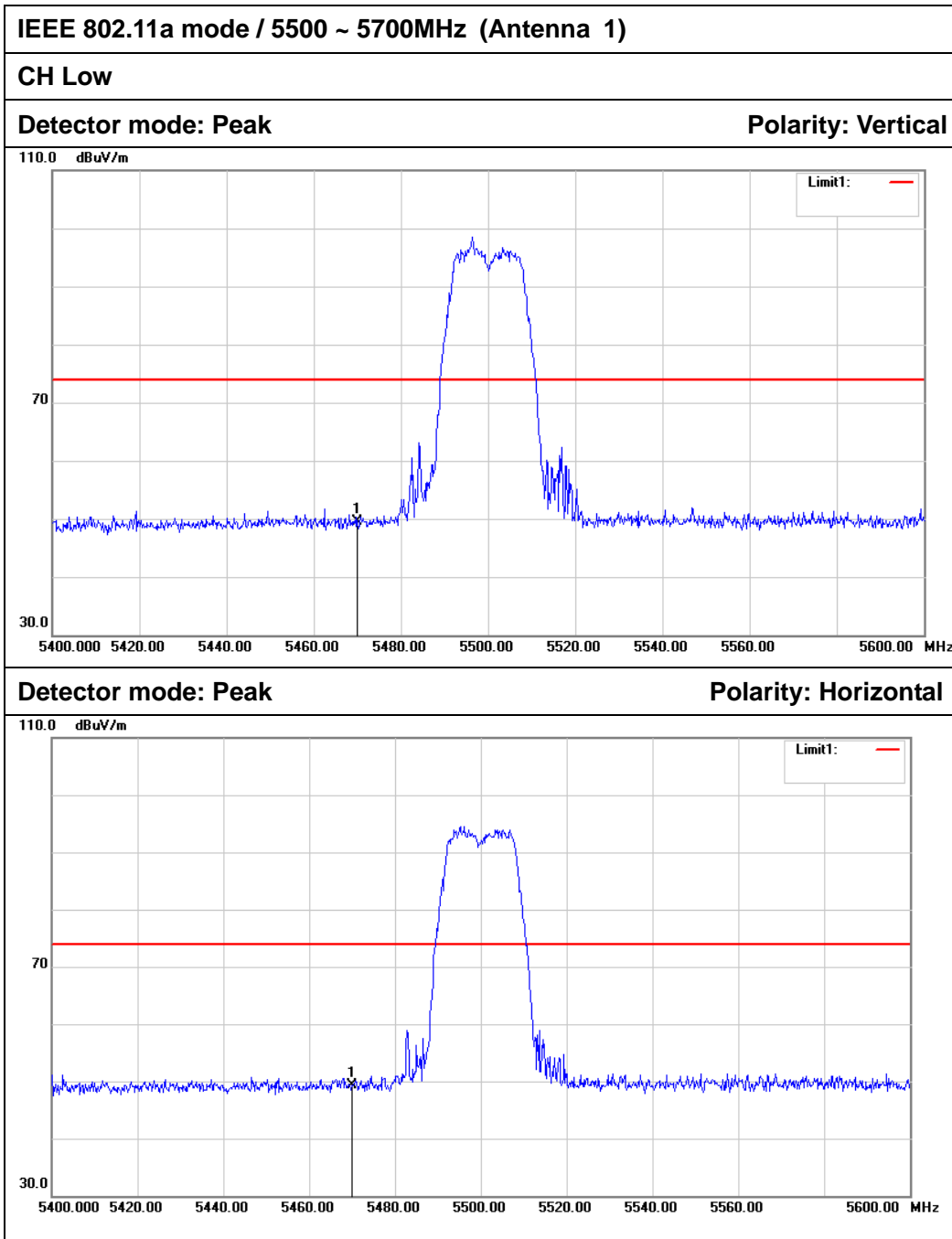

No.	Frequency (MHz)	Reading (dB)	Factor (dB/m)	Result (dB/m)	Limit (dB/m)	Margin (dB)	Remark	Antenna Polar
1	5470.000	43.77	5.82	49.59	74.00	-24.41	Peak	Vertical
2	5470.000	43.50	5.82	49.32	74.00	-24.68	Peak	Horizontal

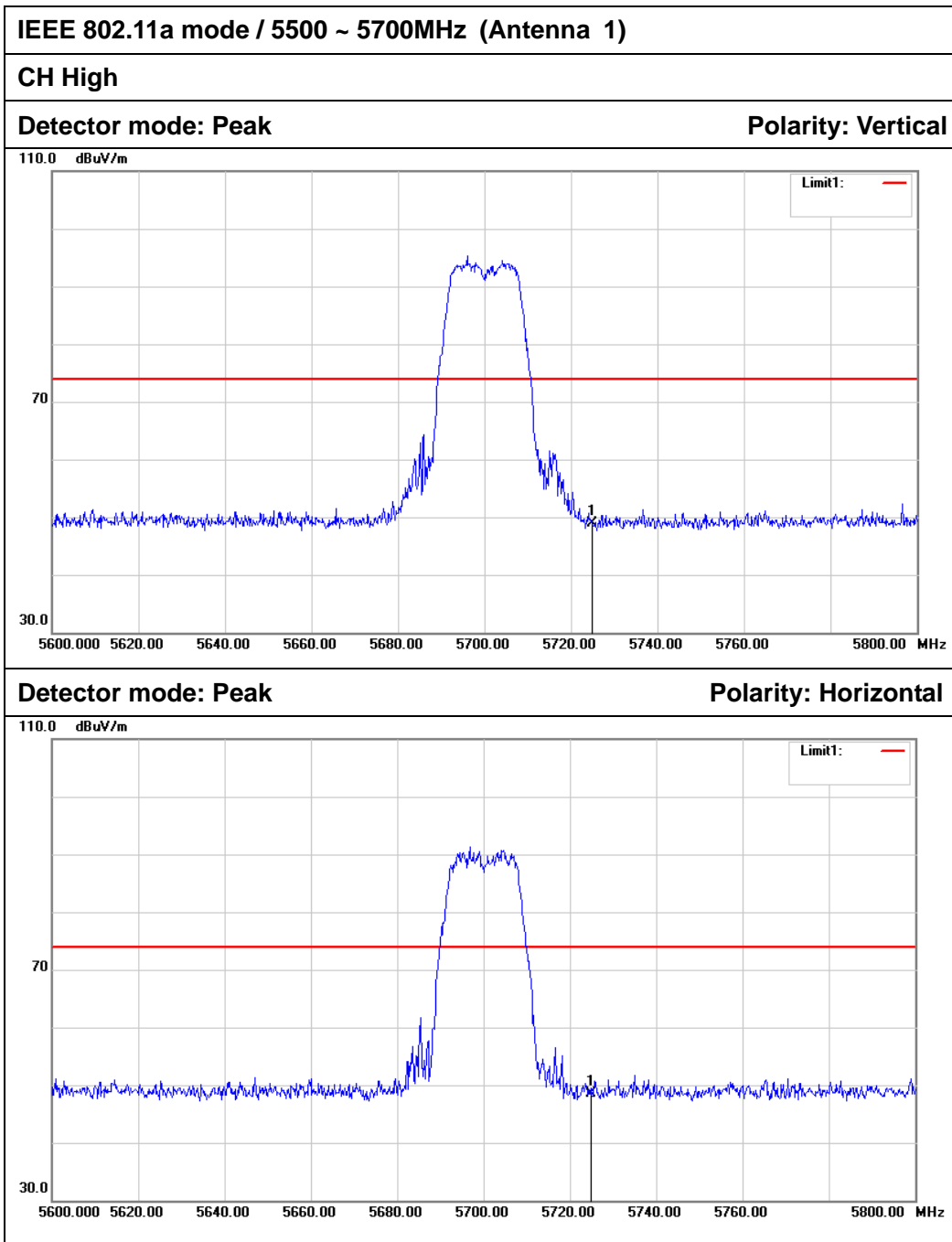

No.	Frequency (MHz)	Reading (dB)	Factor (dB/m)	Result (dB/m)	Limit (dB/m)	Margin (dB)	Remark	Antenna Polar
1	5725.000	42.91	5.96	48.87	74.00	-25.13	Peak	Vertical
2	5725.000	42.48	5.96	48.44	74.00	-25.56	Peak	Horizontal

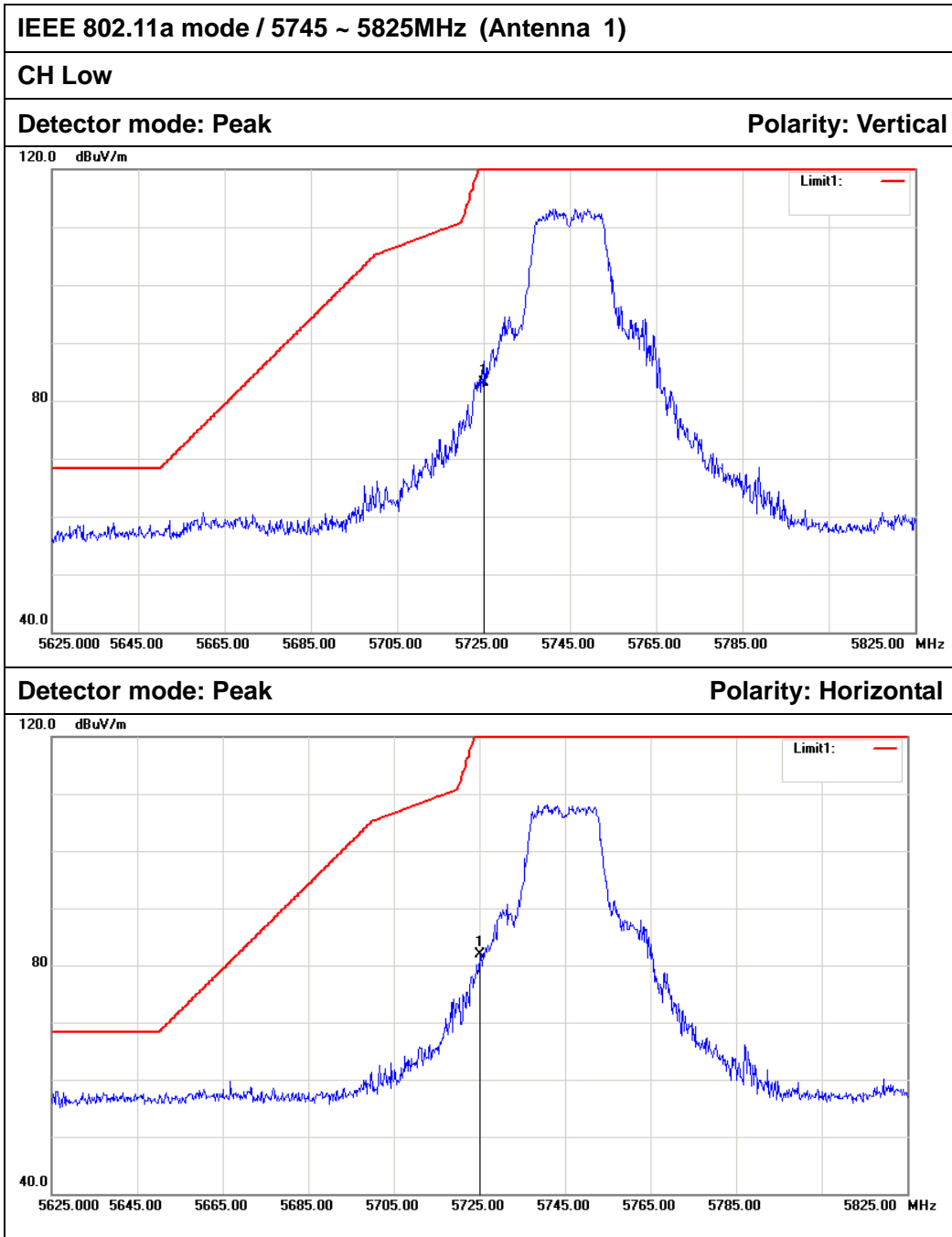

No.	Frequency (MHz)	Reading (dB)	Factor (dB/m)	Result (dB/m)	Limit (dB/m)	Margin (dB)	Remark	Antenna Polar
1	5725.000	77.14	5.96	83.10	122.20	-39.10	Peak	Vertical
2	5725.000	75.88	5.96	81.84	122.20	-40.36	Peak	Horizontal

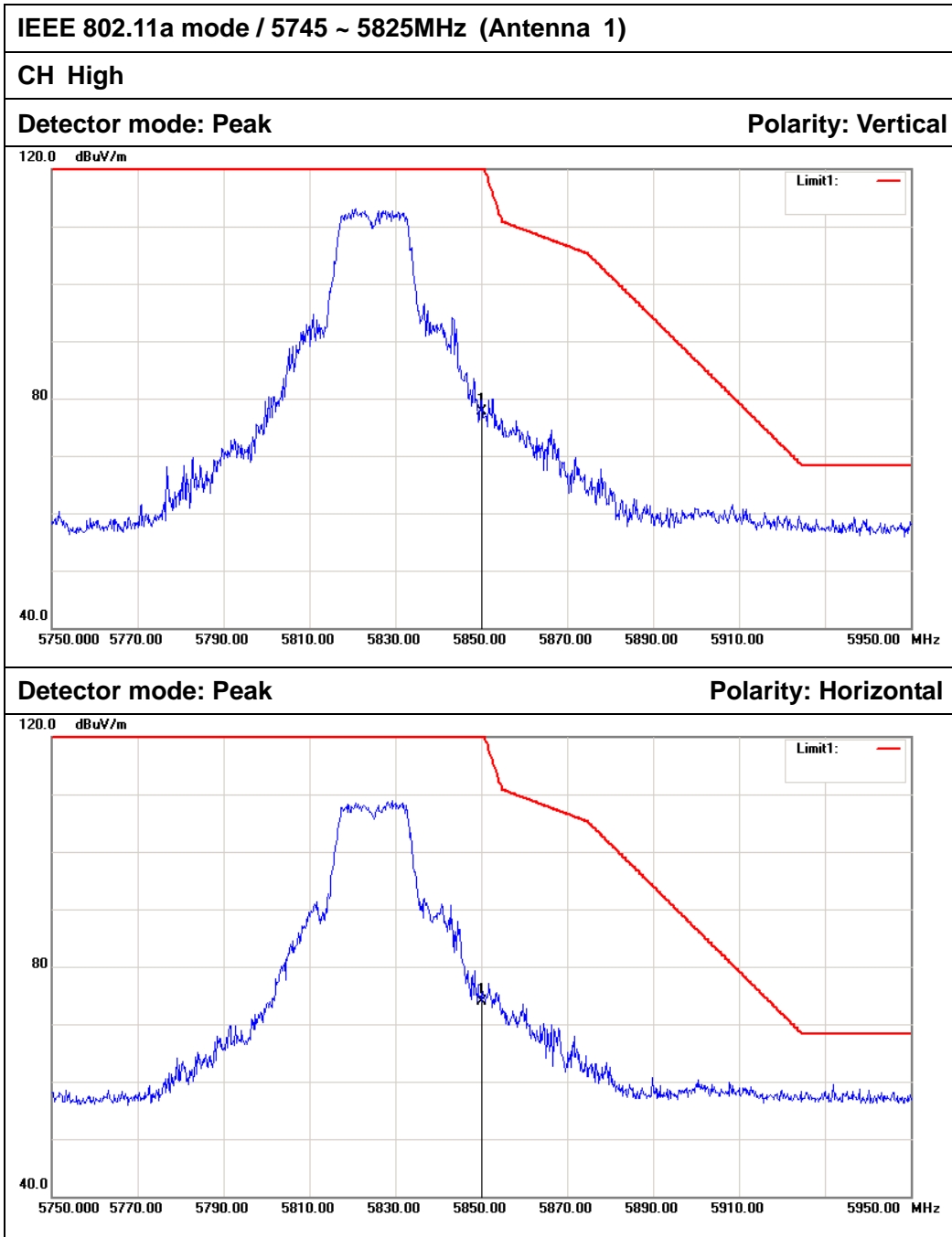

No.	Frequency (MHz)	Reading (dB)	Factor (dB/m)	Result (dB/m)	Limit (dB/m)	Margin (dB)	Remark	Antenna Polar
1	5850.000	71.67	6.02	77.69	122.20	-44.51	Peak	Vertical
2	5850.000	67.85	6.02	73.87	122.20	-48.33	Peak	Horizontal

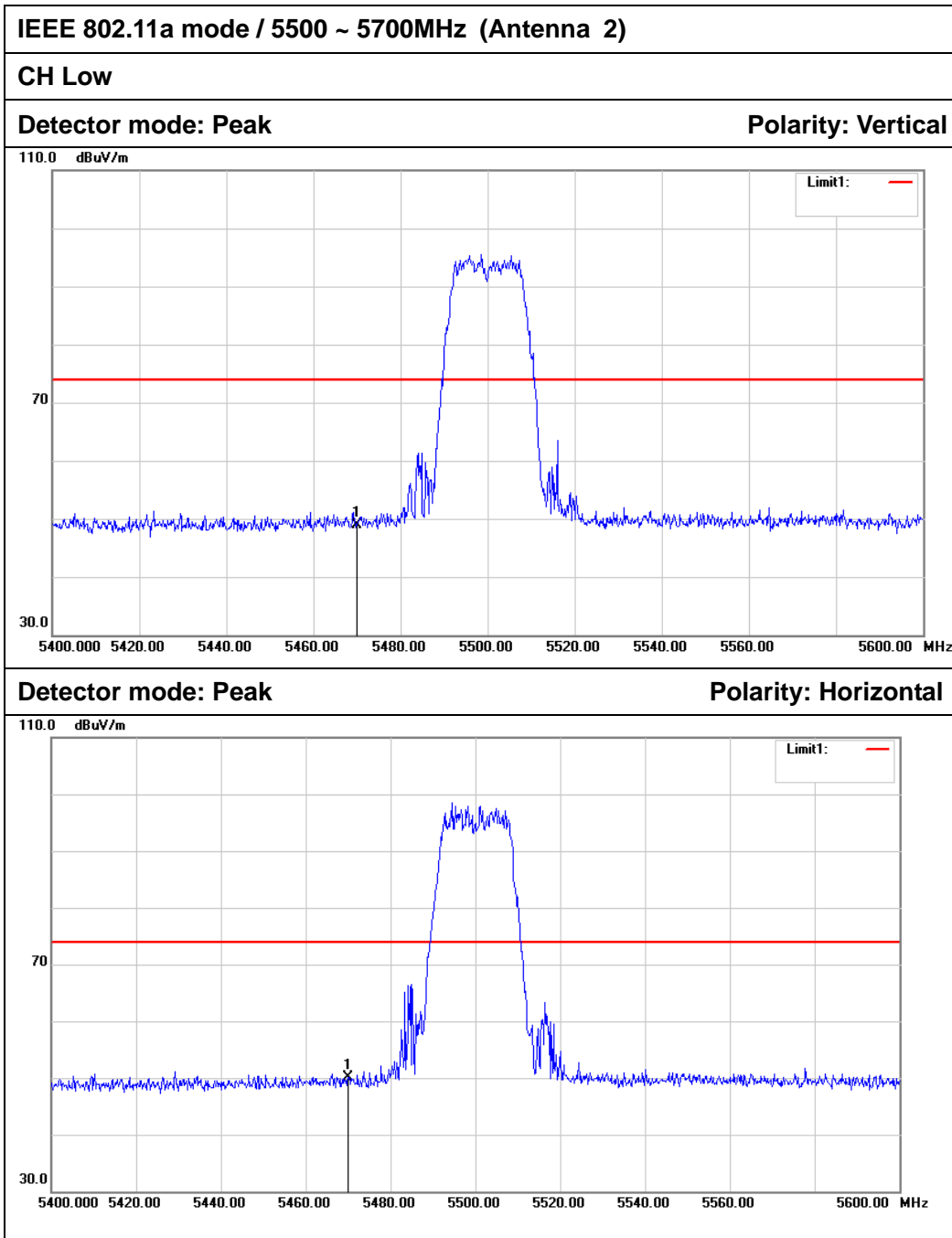

No.	Frequency (MHz)	Reading (dB)	Factor (dB/m)	Result (dB/m)	Limit (dB/m)	Margin (dB)	Remark	Antenna Polar
1	5470.000	43.03	5.82	48.85	74.00	-25.15	Peak	Vertical
2	5470.000	44.34	5.82	50.16	74.00	-23.84	Peak	Horizontal

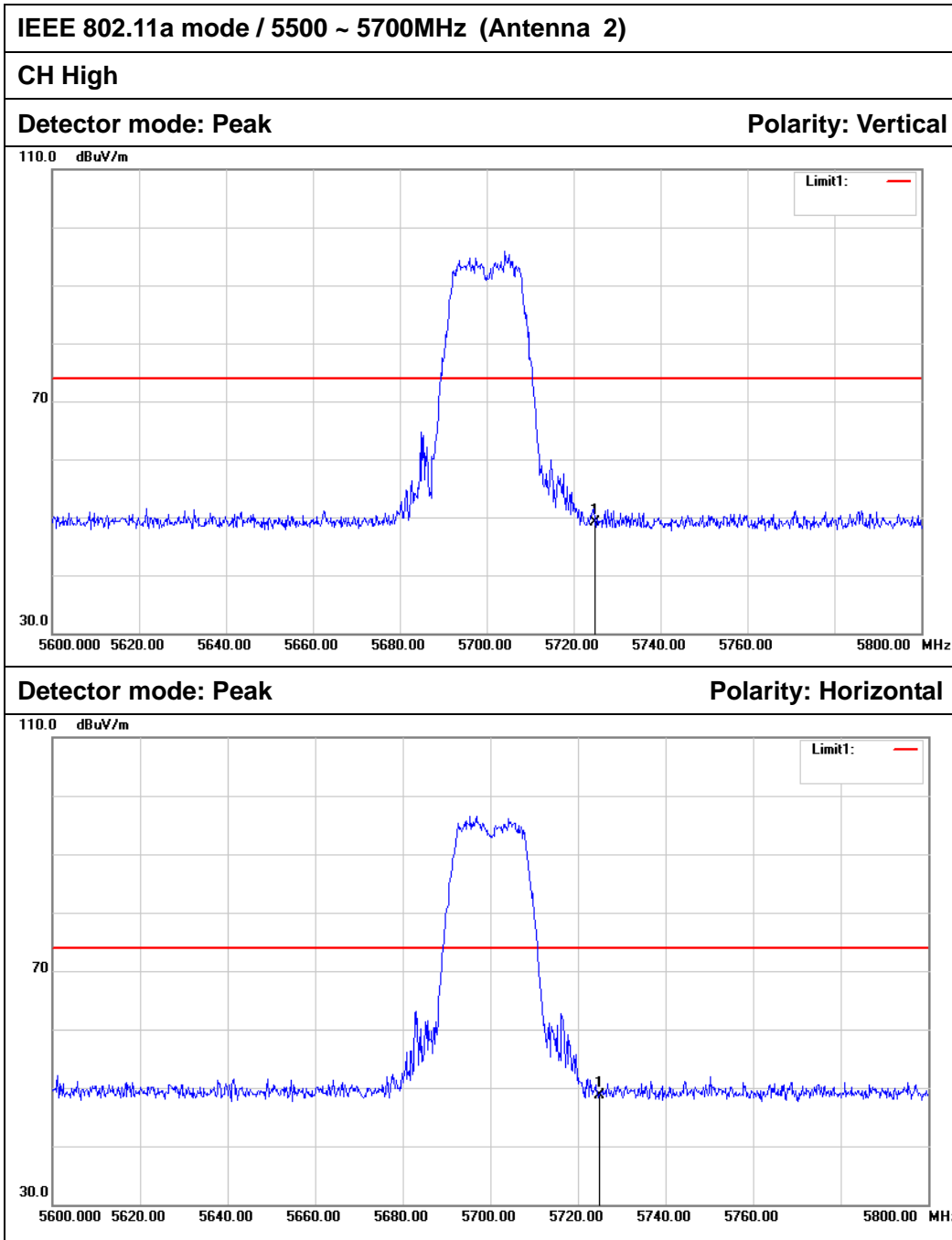

No.	Frequency (MHz)	Reading (dB)	Factor (dB/m)	Result (dB/m)	Limit (dB/m)	Margin (dB)	Remark	Antenna Polar
1	5725.000	43.21	5.96	49.17	74.00	-24.83	Peak	Vertical
2	5725.000	42.75	5.96	48.71	74.00	-25.29	Peak	Horizontal

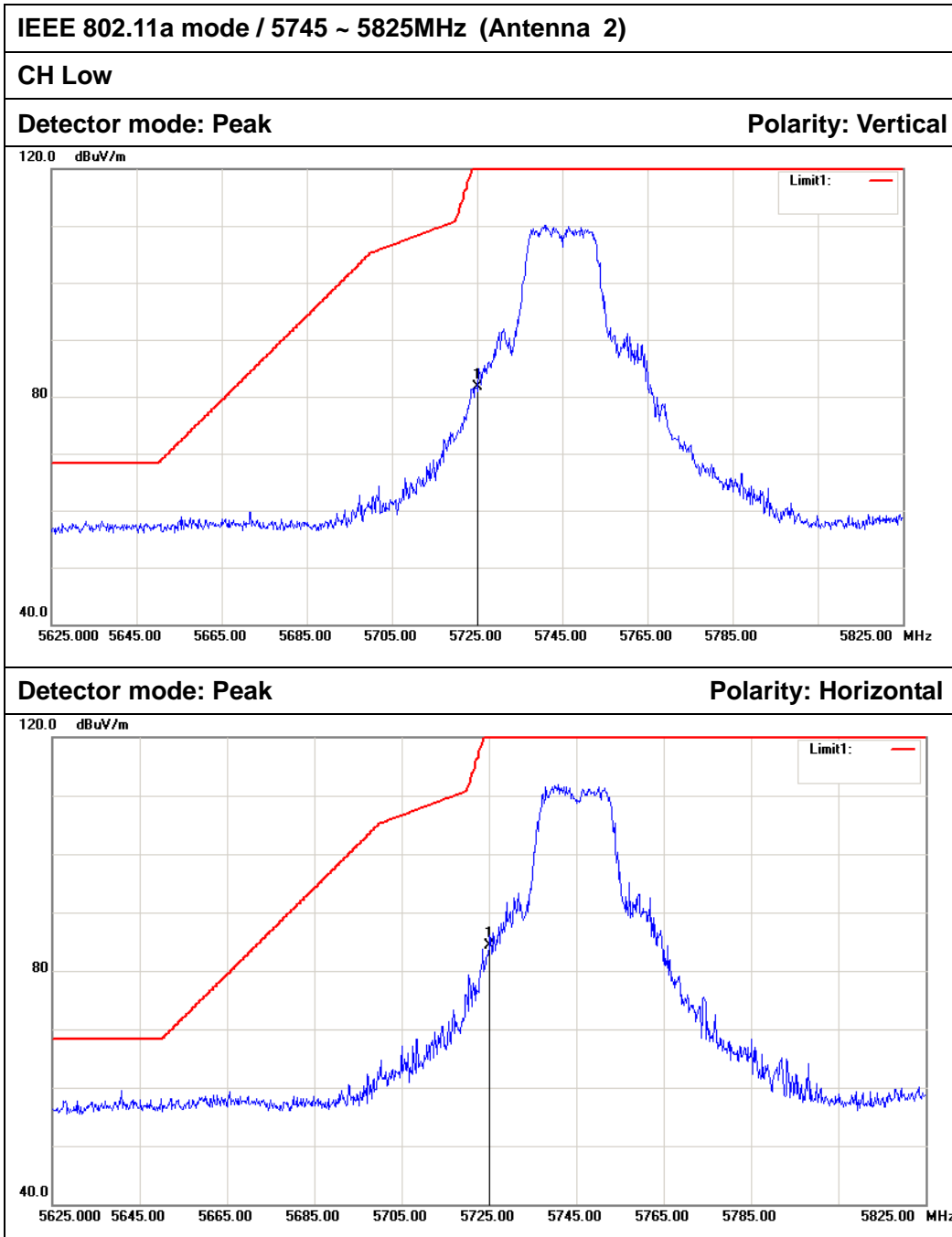

No.	Frequency (MHz)	Reading (dB)	Factor (dB/m)	Result (dB/m)	Limit (dB/m)	Margin (dB)	Remark	Antenna Polar
1	5725.000	75.72	5.96	81.68	122.20	-40.52	Peak	Vertical
2	5725.000	78.33	5.96	84.29	122.20	-37.91	Peak	Horizontal

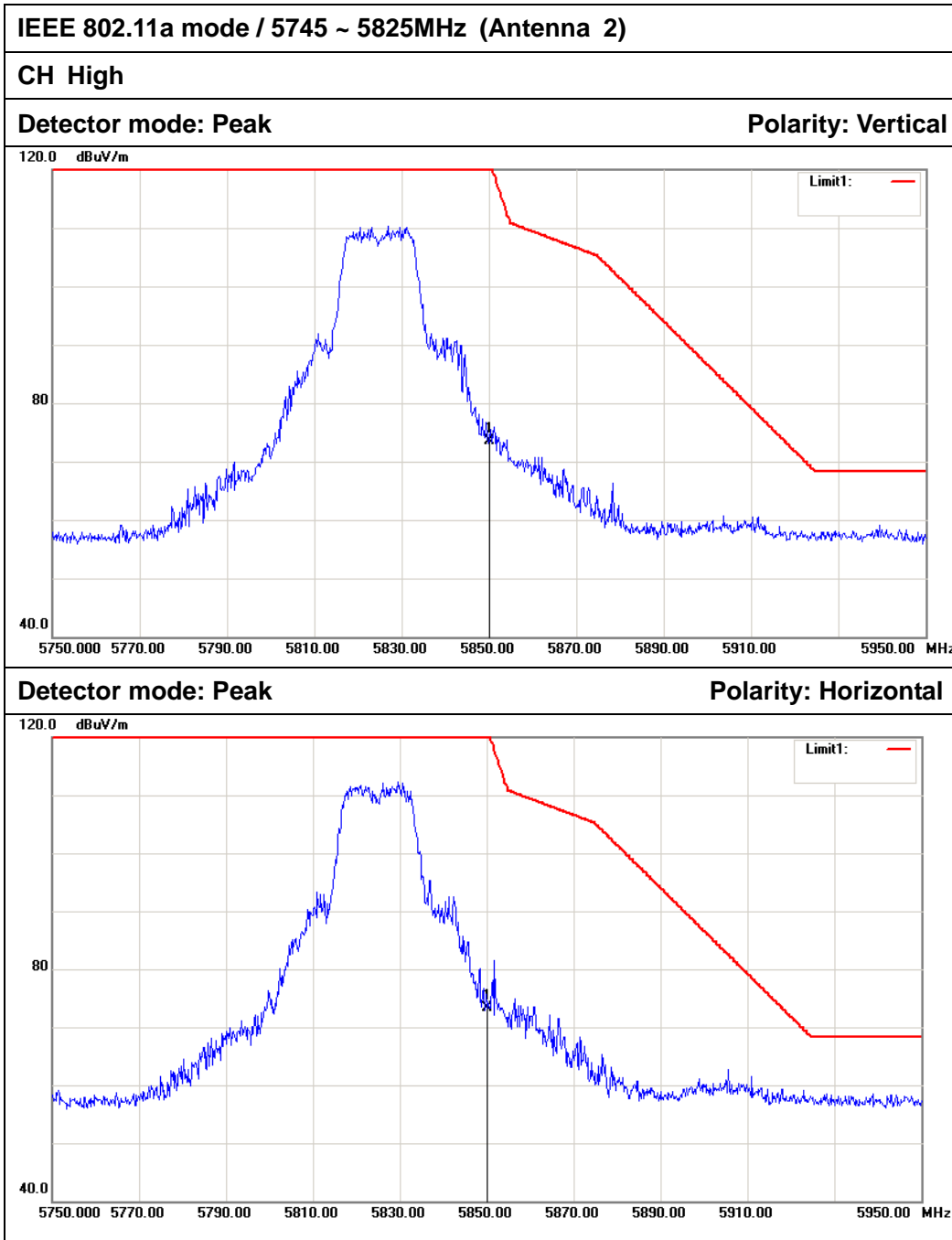

No.	Frequency (MHz)	Reading (dB)	Factor (dB/m)	Result (dB/m)	Limit (dB/m)	Margin (dB)	Remark	Antenna Polar
1	5850.000	67.58	6.02	73.60	122.20	-48.60	Peak	Vertical
2	5850.000	67.21	6.02	73.23	122.20	-48.97	Peak	Horizontal



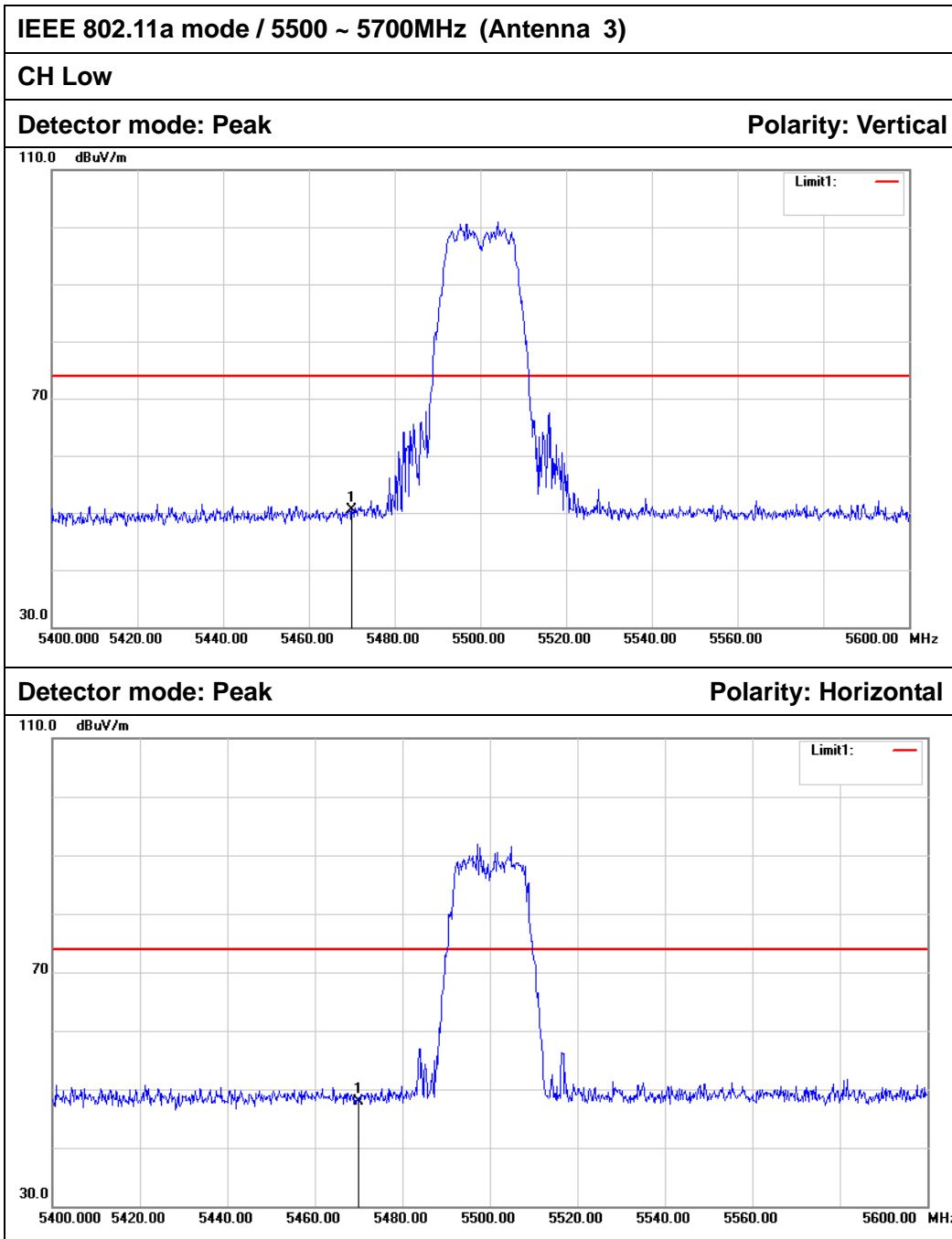

No.	Frequency (MHz)	Reading (dB)	Factor (dB/m)	Result (dB/m)	Limit (dB/m)	Margin (dB)	Remark	Antenna Polar
1	5470.000	44.72	5.82	50.54	74.00	-23.46	Peak	Vertical
2	5470.000	42.13	5.82	47.95	74.00	-26.05	Peak	Horizontal

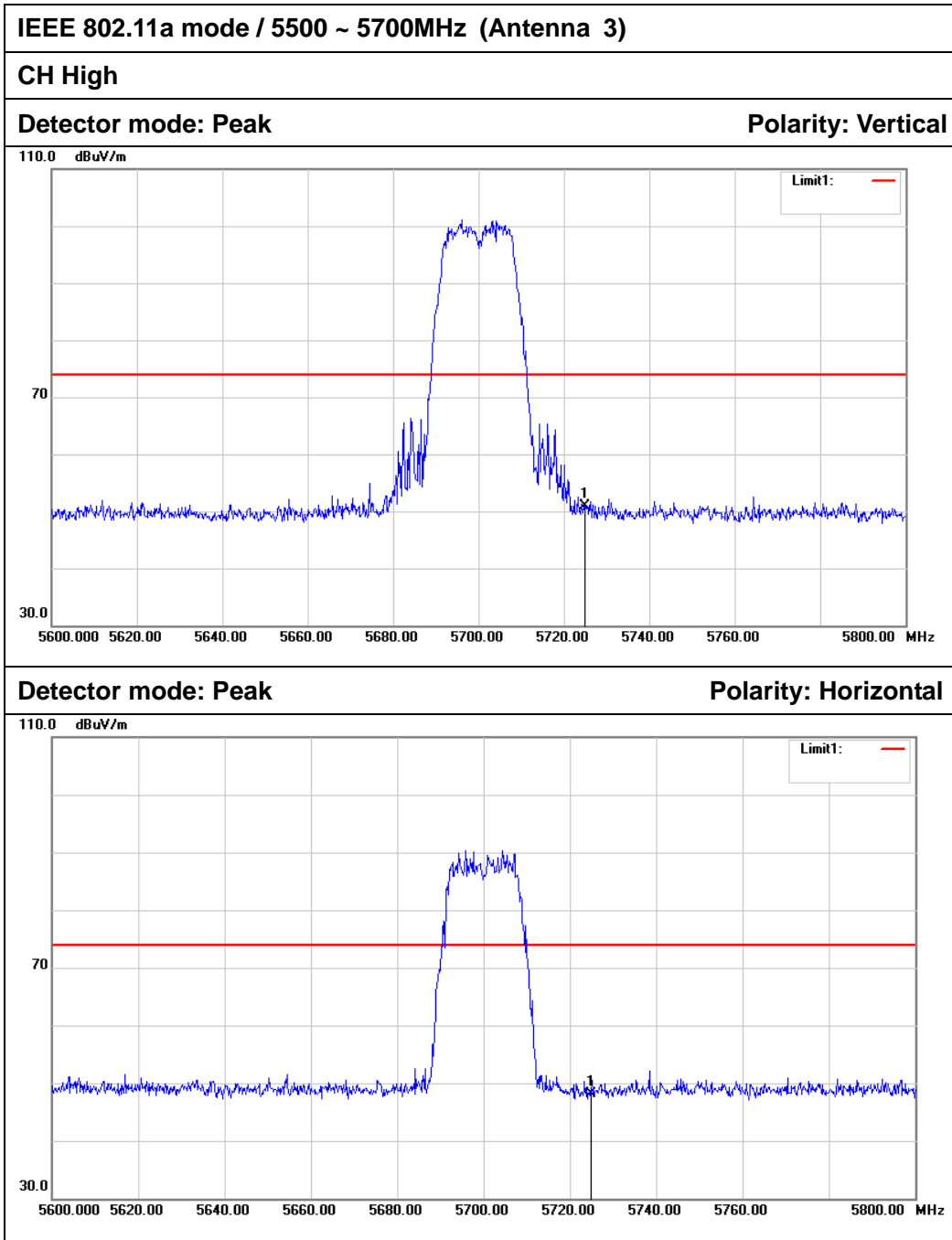

No.	Frequency (MHz)	Reading (dB)	Factor (dB/m)	Result (dB/m)	Limit (dB/m)	Margin (dB)	Remark	Antenna Polar
1	5725.000	44.99	5.96	50.95	74.00	-23.05	Peak	Vertical
2	5725.000	42.14	5.96	48.10	74.00	-25.90	Peak	Horizontal

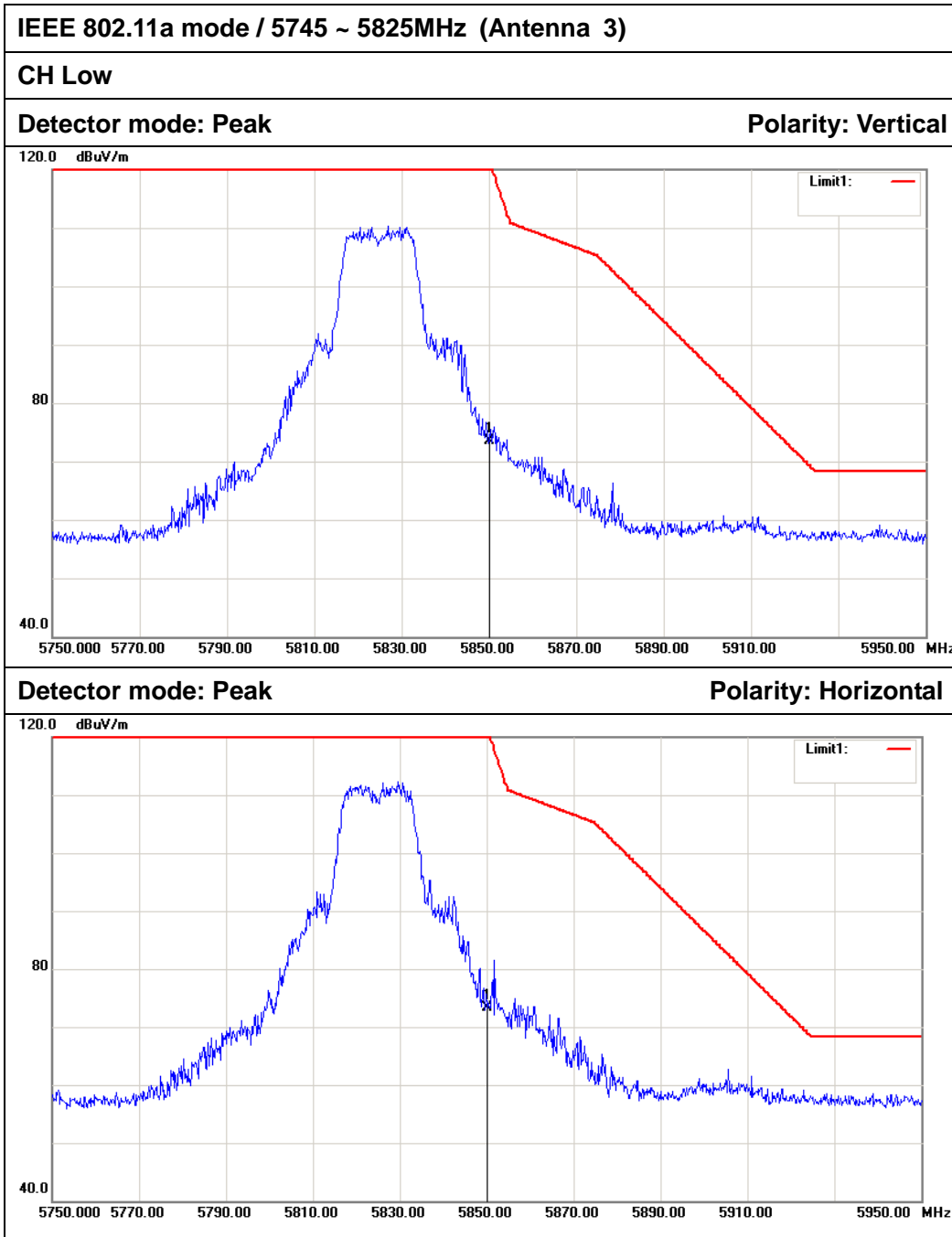

No.	Frequency (MHz)	Reading (dB)	Factor (dB/m)	Result (dB/m)	Limit (dB/m)	Margin (dB)	Remark	Antenna Polar
1	5725.000	76.42	5.96	82.38	122.20	-39.82	Peak	Vertical
2	5725.000	68.62	5.96	74.58	122.20	-47.62	Peak	Horizontal

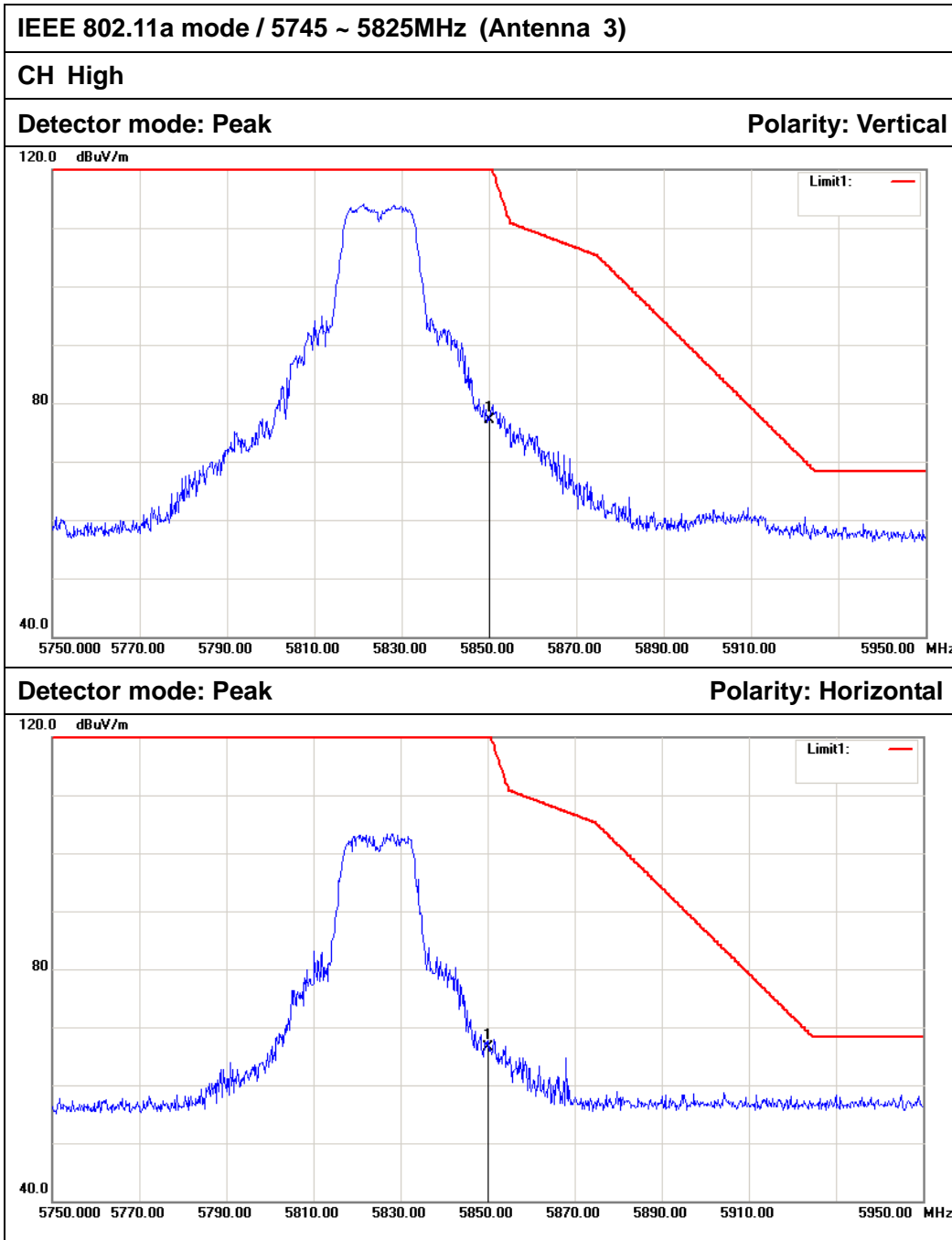

No.	Frequency (MHz)	Reading (dB)	Factor (dB/m)	Result (dB/m)	Limit (dB/m)	Margin (dB)	Remark	Antenna Polar
1	5850.000	71.04	6.02	77.06	122.20	-45.14	Peak	Vertical
2	5850.000	60.51	6.02	66.53	122.20	-55.67	Peak	Horizontal

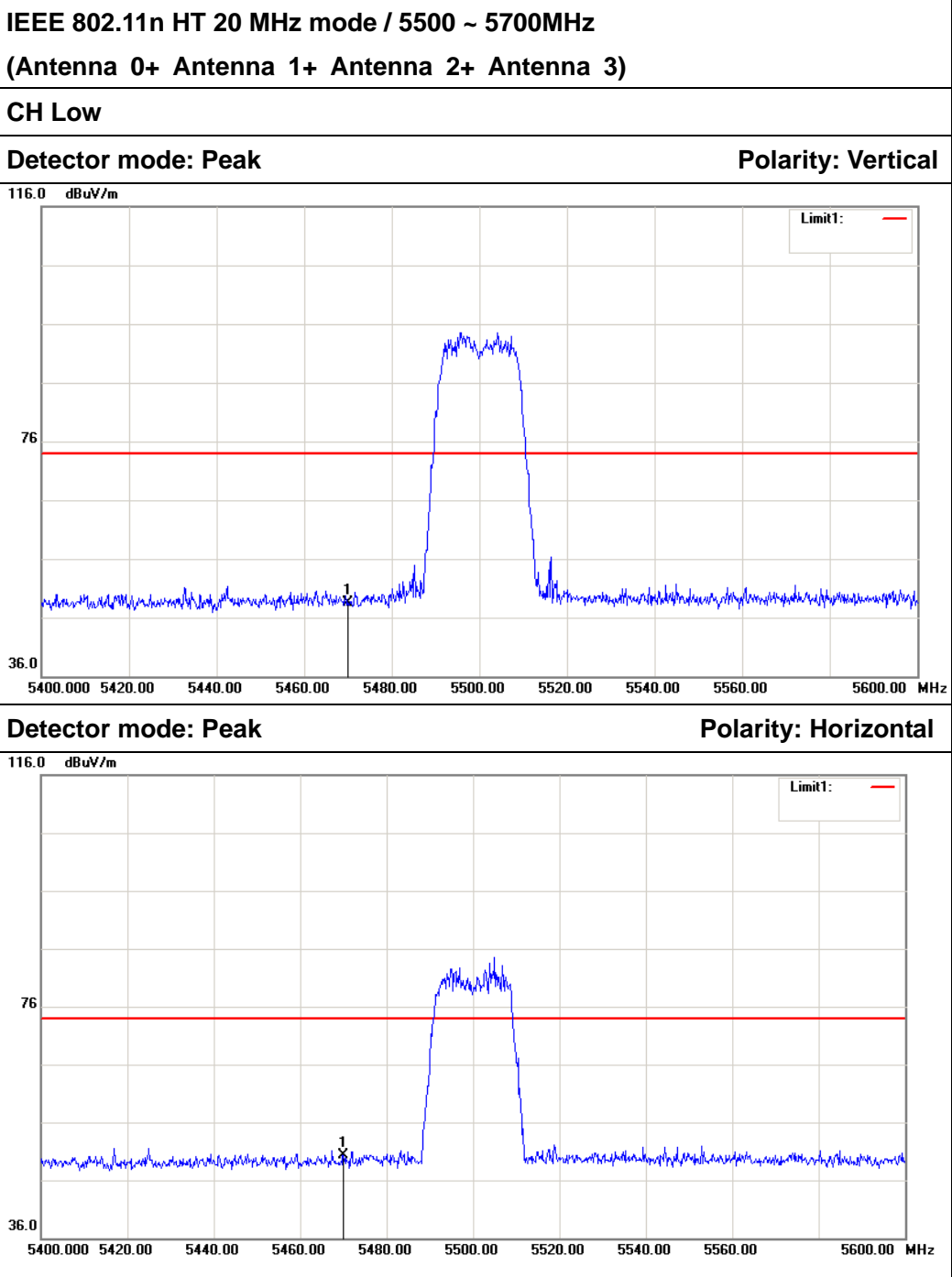

No.	Frequency (MHz)	Reading (dB)	Factor (dB/m)	Result (dB/m)	Limit (dB/m)	Margin (dB)	Remark	Antenna Polar
1	5470.000	42.61	5.82	48.43	74.00	-25.57	Peak	Vertical
2	5470.000	44.43	5.82	50.25	74.00	-23.75	Peak	Horizontal



IEEE 802.11n HT 20 MHz mode / 5500 ~ 5700MHz  
 (Antenna 0+ Antenna 1+ Antenna 2+ Antenna 3)

CH High

Detector mode: Peak

Polarity: Vertical

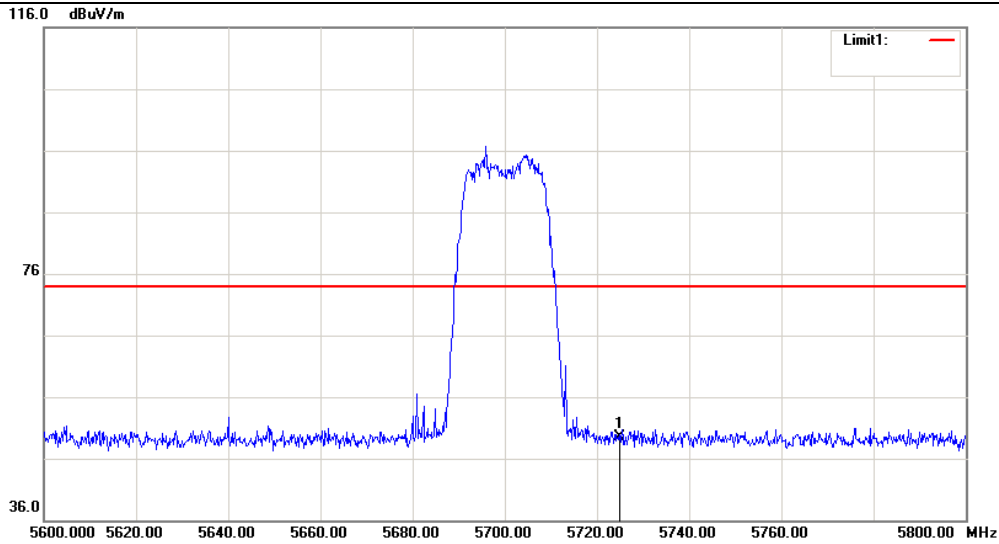

Detector mode: Peak

Polarity: Horizontal

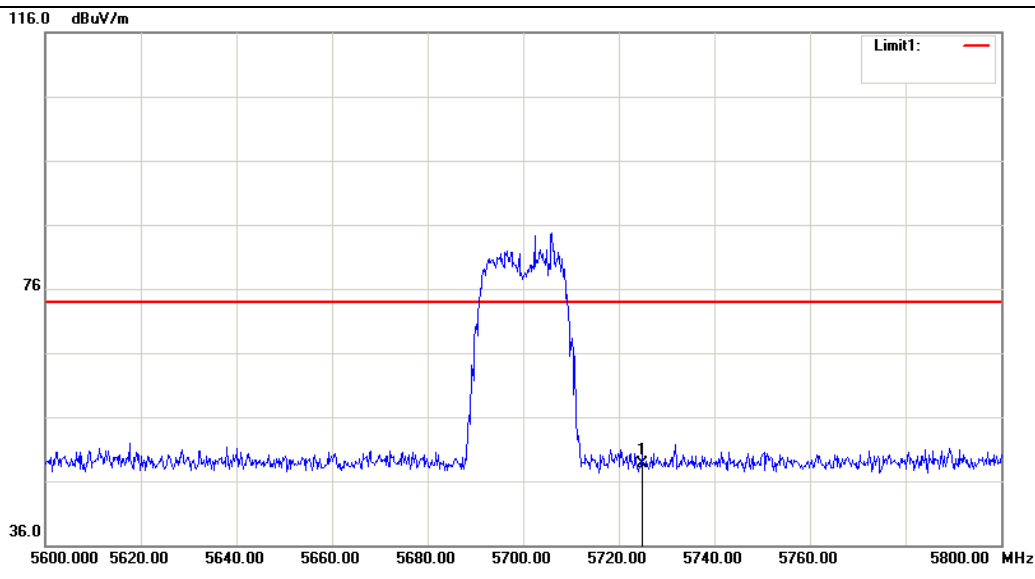

No.	Frequency (MHz)	Reading (dB)	Factor (dB/m)	Result (dB/m)	Limit (dB/m)	Margin (dB)	Remark	Antenna Polar
1	5725.000	43.57	5.96	49.53	74.00	-24.47	Peak	Vertical
2	5725.000	42.81	5.96	48.77	74.00	-25.23	Peak	Horizontal



IEEE 802.11n HT 20 MHz mode / 5745 ~ 5825MHz  
 (Antenna 0+ Antenna 1+ Antenna 2+ Antenna 3)

CH Low

Detector mode: Peak

Polarity: Vertical

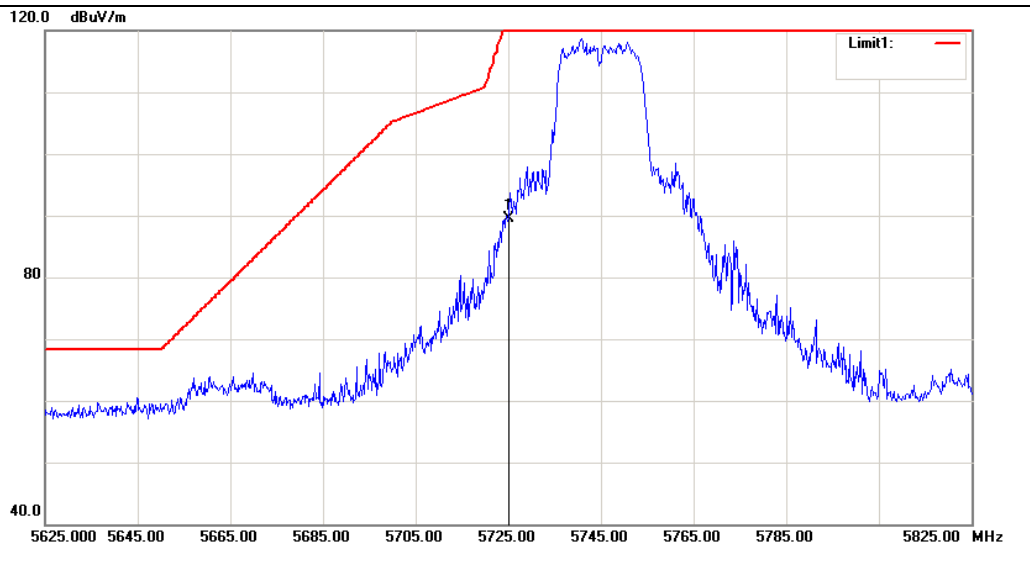

Detector mode: Peak

Polarity: Horizontal

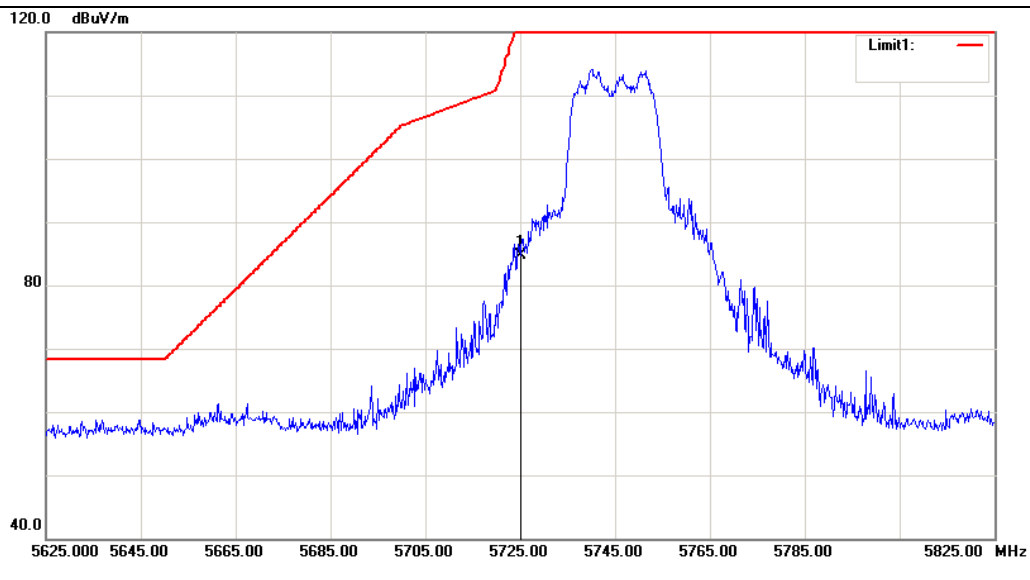

No.	Frequency (MHz)	Reading (dB)	Factor (dB/m)	Result (dB/m)	Limit (dB/m)	Margin (dB)	Remark	Antenna Polar
1	5725.000	83.54	5.96	89.50	122.20	-32.70	Peak	Vertical
2	5725.000	78.83	5.96	84.79	122.20	-37.41	Peak	Horizontal



IEEE 802.11n HT 20 MHz mode / 5745 ~ 5825MHz  
 (Antenna 0+ Antenna 1+ Antenna 2+ Antenna 3)

CH High

Detector mode: Peak

Polarity: Vertical

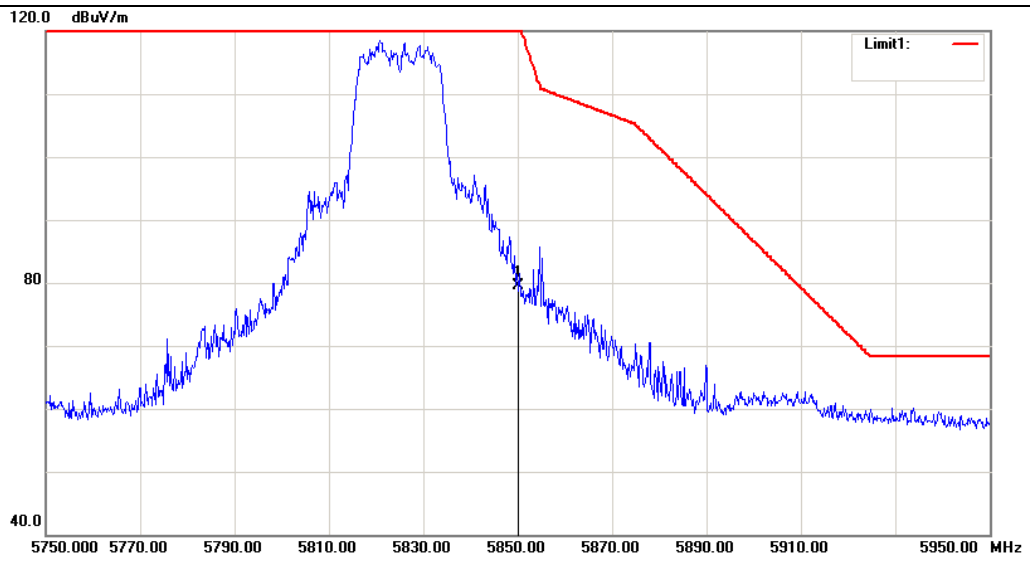

Detector mode: Peak

Polarity: Horizontal

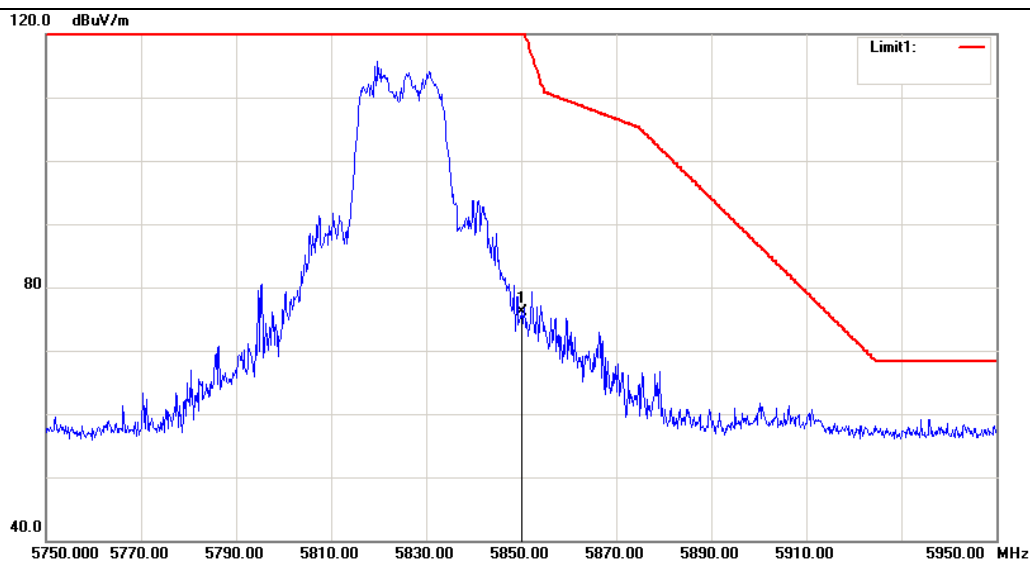

No.	Frequency (MHz)	Reading (dB)	Factor (dB/m)	Result (dB/m)	Limit (dB/m)	Margin (dB)	Remark	Antenna Polar
1	5850.000	73.46	6.02	79.48	122.20	-42.72	Peak	Vertical
2	5850.000	70.06	6.02	76.08	122.20	-46.12	Peak	Horizontal





IEEE 802.11n HT 40 MHz mode / 5510 ~ 5670MHz  
(Antenna 0+ Antenna 1+ Antenna 2+ Antenna 3)

CH Low

Detector mode: Peak

Polarity: Vertical

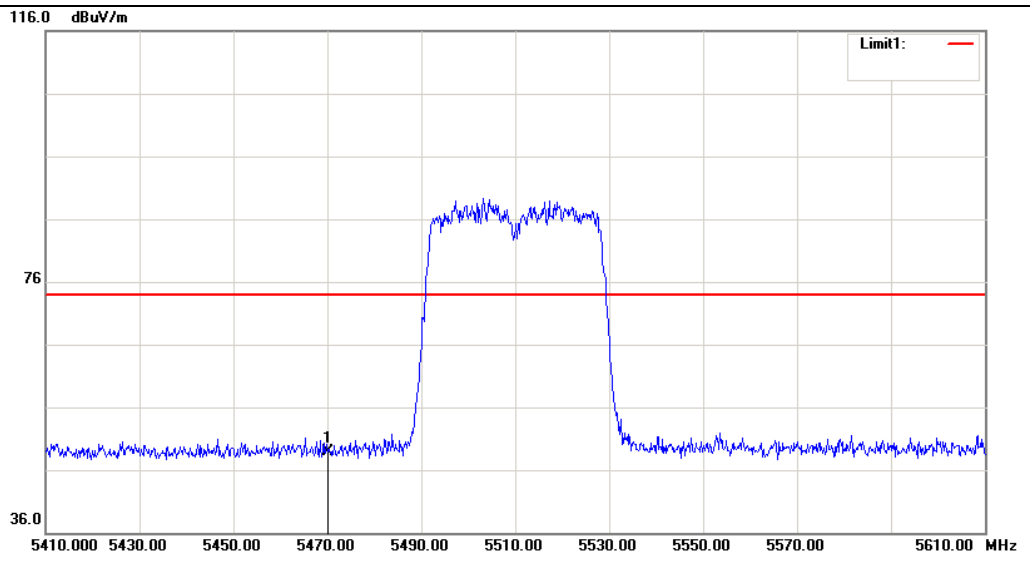

Detector mode: Peak

Polarity: Horizontal

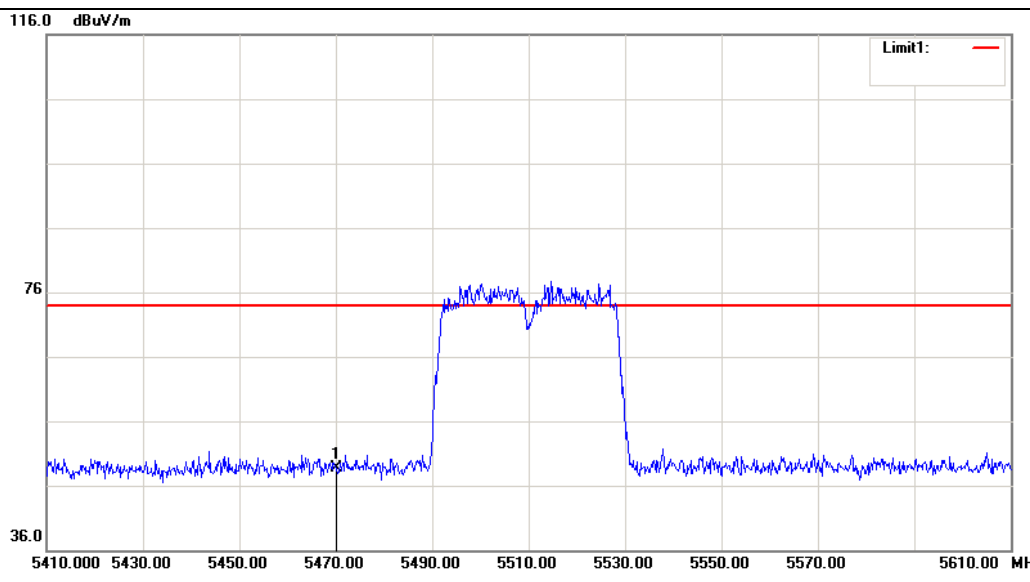

No.	Frequency (MHz)	Reading (dB)	Factor (dB/m)	Result (dB/m)	Limit (dB/m)	Margin (dB)	Remark	Antenna Polar
1	5470.000	43.16	5.82	48.98	74.00	-25.02	Peak	Vertical
2	5470.000	42.80	5.82	48.62	74.00	-25.38	Peak	Horizontal



IEEE 802.11n HT 40 MHz mode / 5510 ~ 5670MHz  
 (Antenna 0+ Antenna 1+ Antenna 2+ Antenna 3)

CH High

Detector mode: Peak Polarity: Vertical

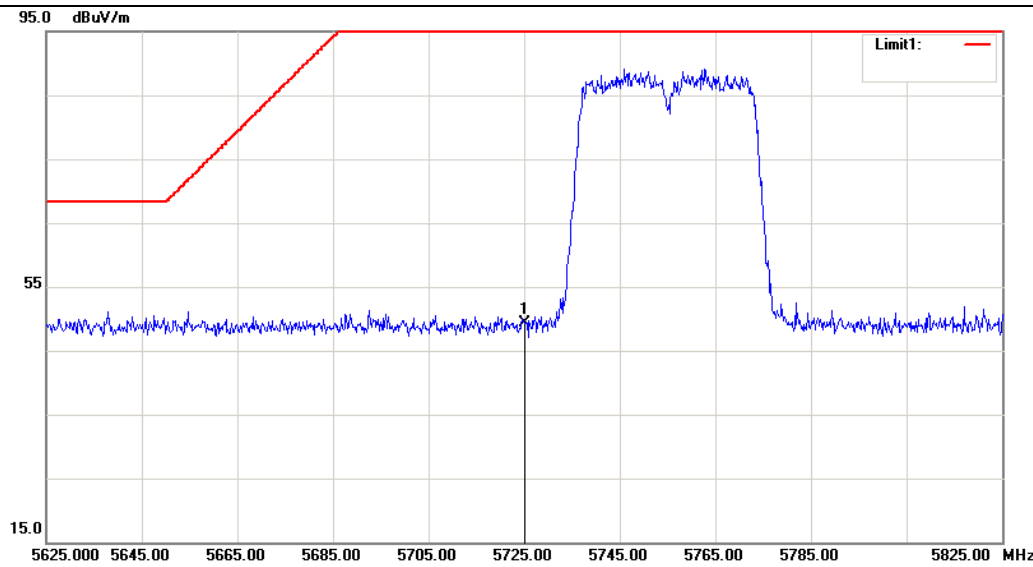

Detector mode: Peak Polarity: Horizontal

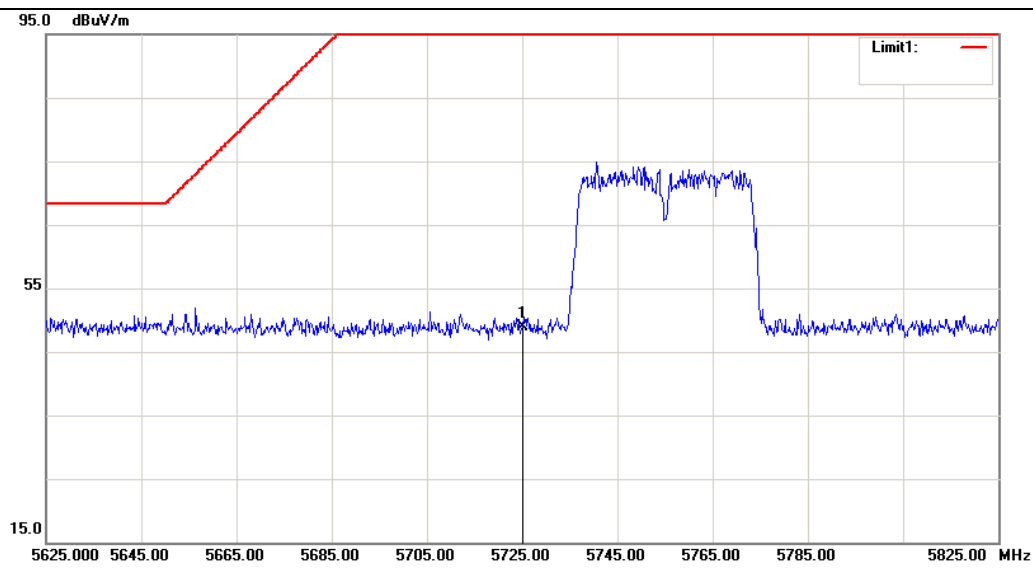

No.	Frequency (MHz)	Reading (dB)	Factor (dB/m)	Result (dB/m)	Limit (dB/m)	Margin (dB)	Remark	Antenna Polar
1	5725.000	43.60	5.96	49.56	74.00	-24.44	Peak	Vertical
2	5725.000	43.36	5.96	49.32	74.00	-24.68	Peak	Horizontal



IEEE 802.11n HT 40 MHz mode / 5755 ~ 5795MHz  
(Antenna 0+ Antenna 1+ Antenna 2+ Antenna 3)

CH Low

Detector mode: Peak

Polarity: Vertical

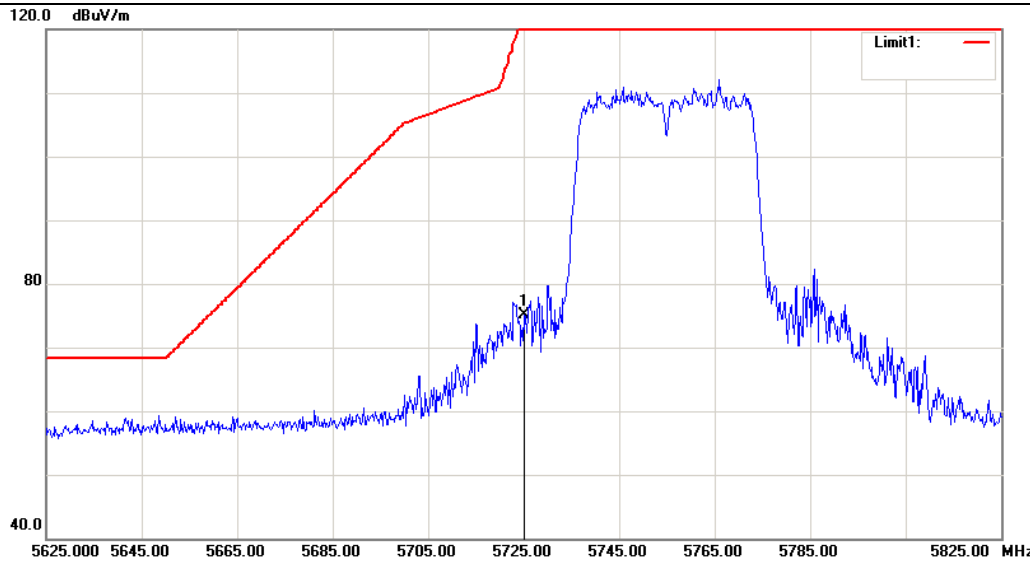

Detector mode: Peak

Polarity: Horizontal

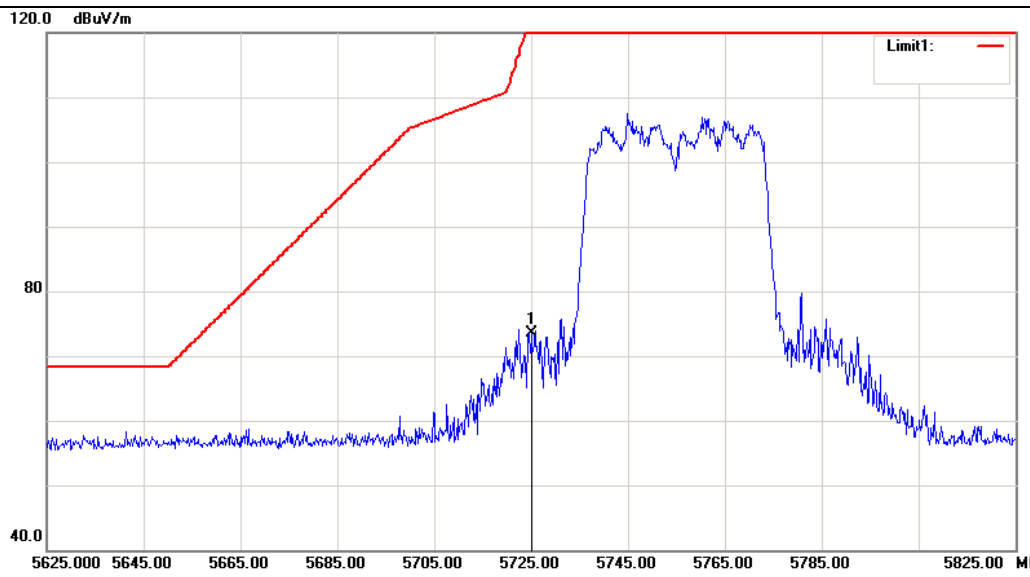

No.	Frequency (MHz)	Reading (dB)	Factor (dB/m)	Result (dB/m)	Limit (dB/m)	Margin (dB)	Remark	Antenna Polar
1	5725.000	69.18	5.96	75.14	122.20	-47.06	Peak	Vertical
2	5725.000	67.49	5.96	73.45	122.20	-48.75	Peak	Horizontal

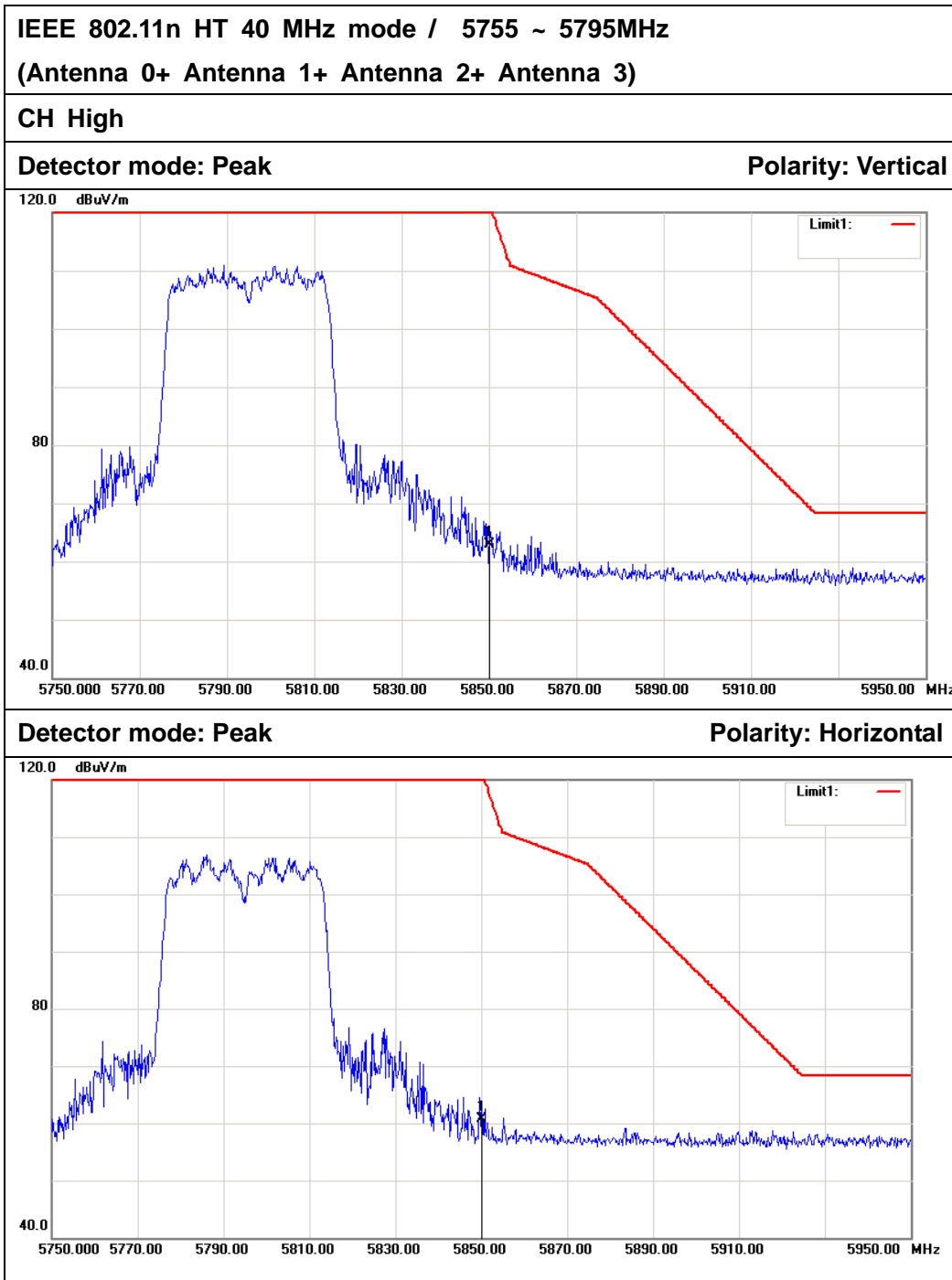

No.	Frequency (MHz)	Reading (dB)	Factor (dB/m)	Result (dB/m)	Limit (dB/m)	Margin (dB)	Remark	Antenna Polar
1	5850.000	56.83	6.02	62.85	122.20	-59.35	Peak	Vertical
2	5850.000	54.63	6.02	60.65	122.20	-61.55	Peak	Horizontal



IEEE 802.11ac 80 mode / 5530MHz

(Antenna 0+ Antenna 1+ Antenna 2+ Antenna 3)

Detector mode: Peak

Polarity: Vertical

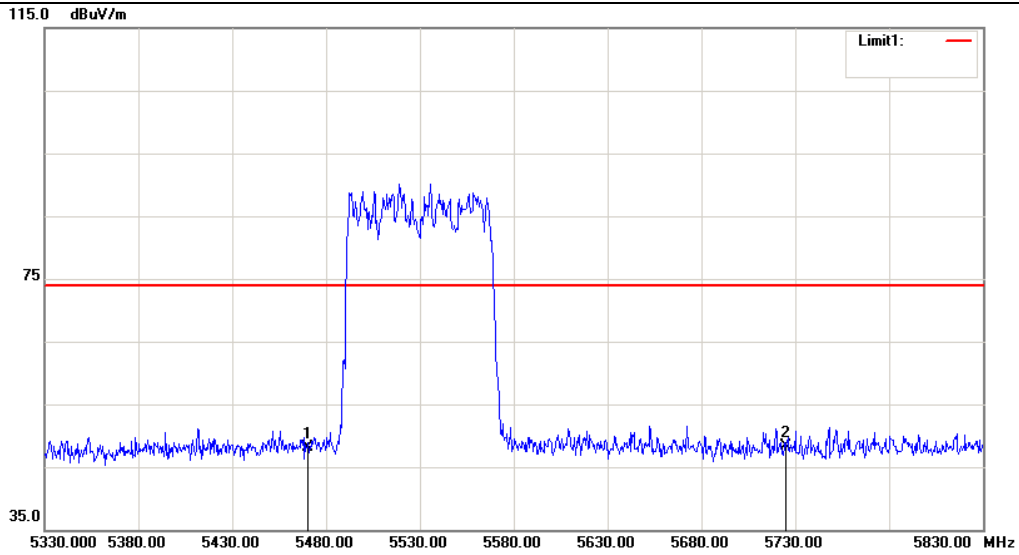

Detector mode: Peak

Polarity: Horizontal

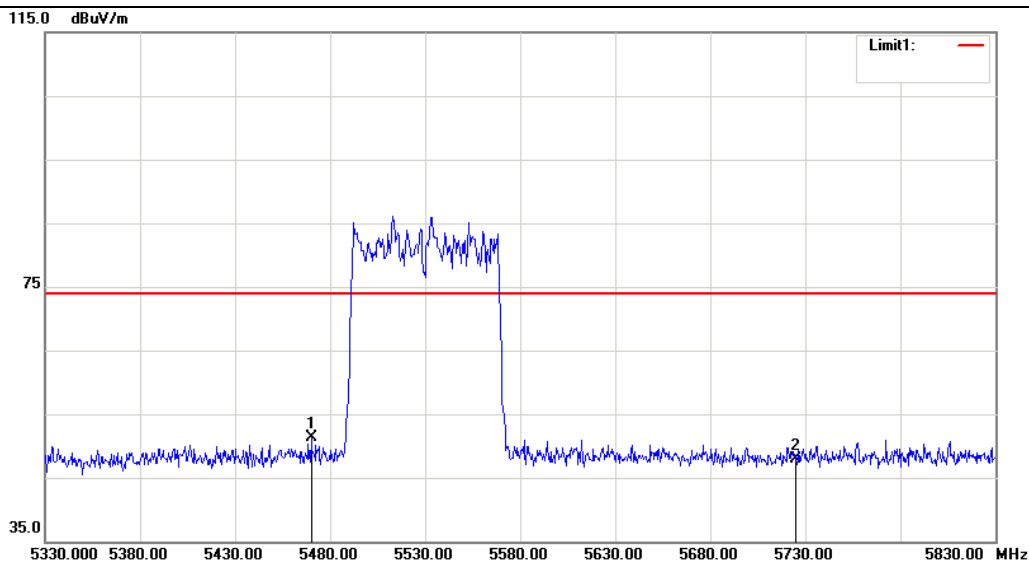

No.	Frequency (MHz)	Reading (dB)	Factor (dB/m)	Result (dB/m)	Limit (dB/m)	Margin (dB)	Remark	Antenna Polar
1	5470.000	42.29	5.82	48.11	74.00	-25.89	Peak	Vertical
2	5725.000	42.32	5.96	48.28	74.00	-25.72	Peak	Vertical
3	5470.000	45.50	5.82	51.32	74.00	-22.68	Peak	Horizontal
4	5725.000	41.86	5.96	47.82	74.00	-26.18	Peak	Horizontal

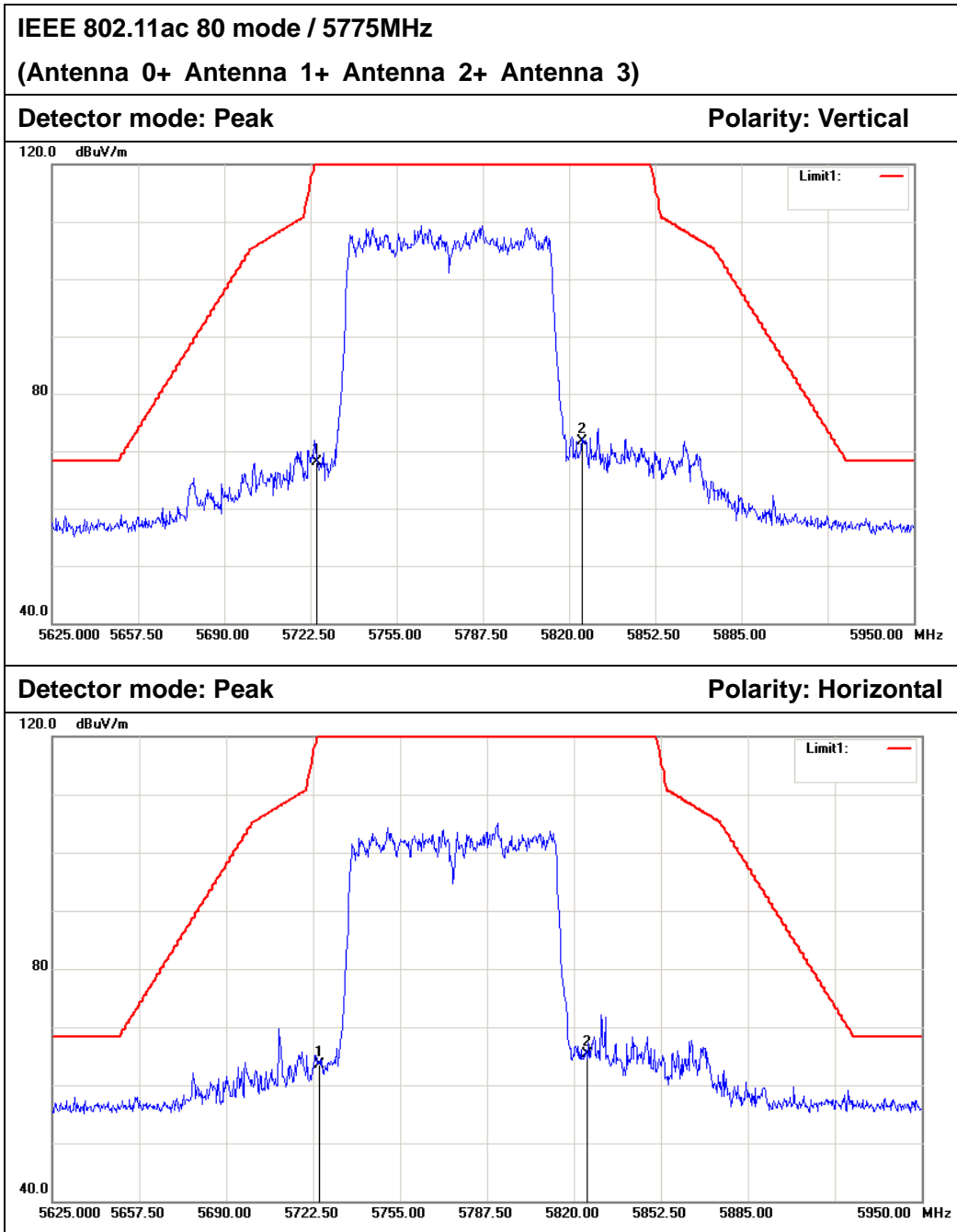

No.	Frequency (MHz)	Reading (dB)	Factor (dB/m)	Result (dB/m)	Limit (dB/m)	Margin (dB)	Remark	Antenna Polar
1	5725.000	62.15	5.96	68.11	122.20	-54.09	Peak	Vertical
2	5825.000	65.73	6.01	71.74	122.20	-50.46	Peak	Vertical
3	5725.000	57.49	5.96	63.45	122.20	-58.75	Peak	Horizontal
4	5825.000	59.30	6.01	65.31	122.20	-56.89	Peak	Horizontal



## 6.9 POWERLINE CONDUCTED EMISSIONS

### 6.9.1 LIMIT

According to §15.207(a), except as shown in paragraphs (b) and (c) of this section, for an intentional radiator that is designed to be connected to the public utility (AC) power line, the radio frequency voltage that is conducted back onto the AC power line on any frequency or frequencies within the band 150 kHz to 30 MHz shall not exceed the limits in the following table, as measured using a 50  $\mu$ H/50 ohms line impedance stabilization network (LISN). Compliance with the provisions of this paragraph shall be based on the measurement of the radio frequency voltage between each power line and ground at the power terminal. The lower limit applies at the boundary between the frequency ranges.

Frequency Range (MHz)	Limits (dB $\mu$ V)	
	Quasi-peak	Average
0.15 to 0.50	66 to 56*	56 to 46*
0.50 to 5	56	46
5 to 30	60	50

\* Decreases with the logarithm of the frequency.

### 6.9.2 TEST INSTRUMENTS

Conducted Emission Test Site					
Name of Equipment	Manufacturer	Model Number	Serial Number	Last Calibration	Due Calibration
EMI TEST RECEIVER	ROHDE&SCHWARZ	ESCI	100783	02/21/2017	02/20/2018
LISN(EUT)	ROHDE&SCHWARZ	ENV216	101543-WX	02/21/2017	02/20/2018
LISN	EMCO	3825/2	8901-1459	02/21/2017	02/20/2018
Temp. / Humidity Meter	VICTOR	HTC-1	N/A	02/21/2017	02/20/2018
Test S/W	FARAD	EZ-EMC/ CCS-3A1-CE			

- NOTE:** 1. The calibration interval of the above test instruments is 12 months and the calibrations are traceable to NML/ROC and NIST/USA.  
2. N.C.R = No Calibration Request.



### 6.9.3 TEST CONFIGURATION

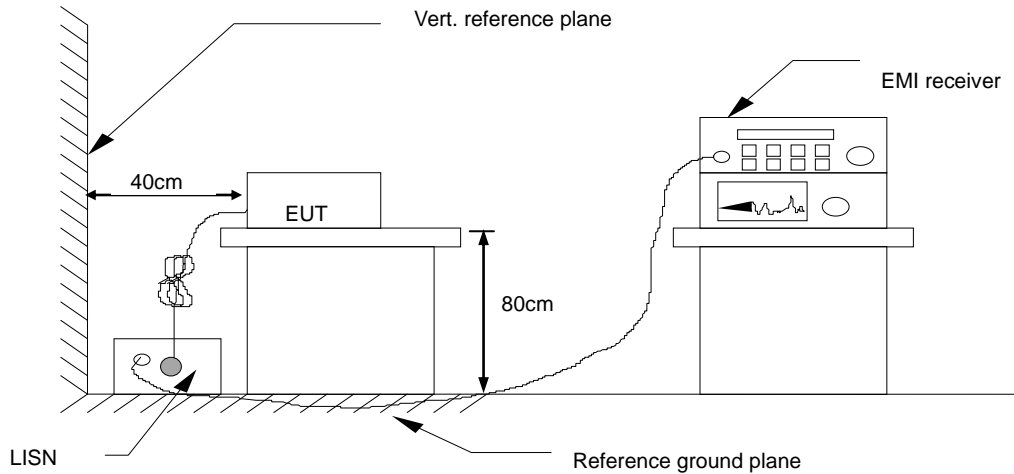

### 6.9.4 TEST PROCEDURE

1. The EUT was placed on a table, which is 0.8m above ground plane.
2. Maximum procedure was performed on the six highest emissions to ensure EUT compliance.
3. Repeat above procedures until all frequency measured were complete.

### 6.9.5 DATA SAMPLE

Frequency (MHz)	QuasiPeak Reading (dBuV)	Average Reading (dBuV)	Correction Factor (dB)	QuasiPeak Result (dBuV)	Average Result (dBuV)	QuasiPeak Limit (dBuV)	Average Limit (dBuV)	QuasiPeak Margin (dB)	Average Margin (dB)	Remark (Pass/Fail)
X.XXXX	32.69	25.65	11.52	44.21	37.17	65.78	55.79	-21.57	-18.62	Pass

Factor = Insertion loss of LISN + Cable Loss  
Result = Quasi-peak Reading/ Average Reading + Factor  
Limit = Limit stated in standard  
Margin = Result (dBuV) – Limit (dBuV)





6.9.6 TEST RESULTS

<b>Model No.</b>	SR570ac	<b>RBW,VBW</b>	9 kHz
<b>Environmental Conditions</b>	22°C, 45% RH	<b>Test Mode</b>	Mode 1
<b>Tested by</b>	Darry Wu	<b>Line</b>	L1
<b>Test Date</b>	March 26, 2017	<b>Test Voltage</b>	AC120V/60Hz

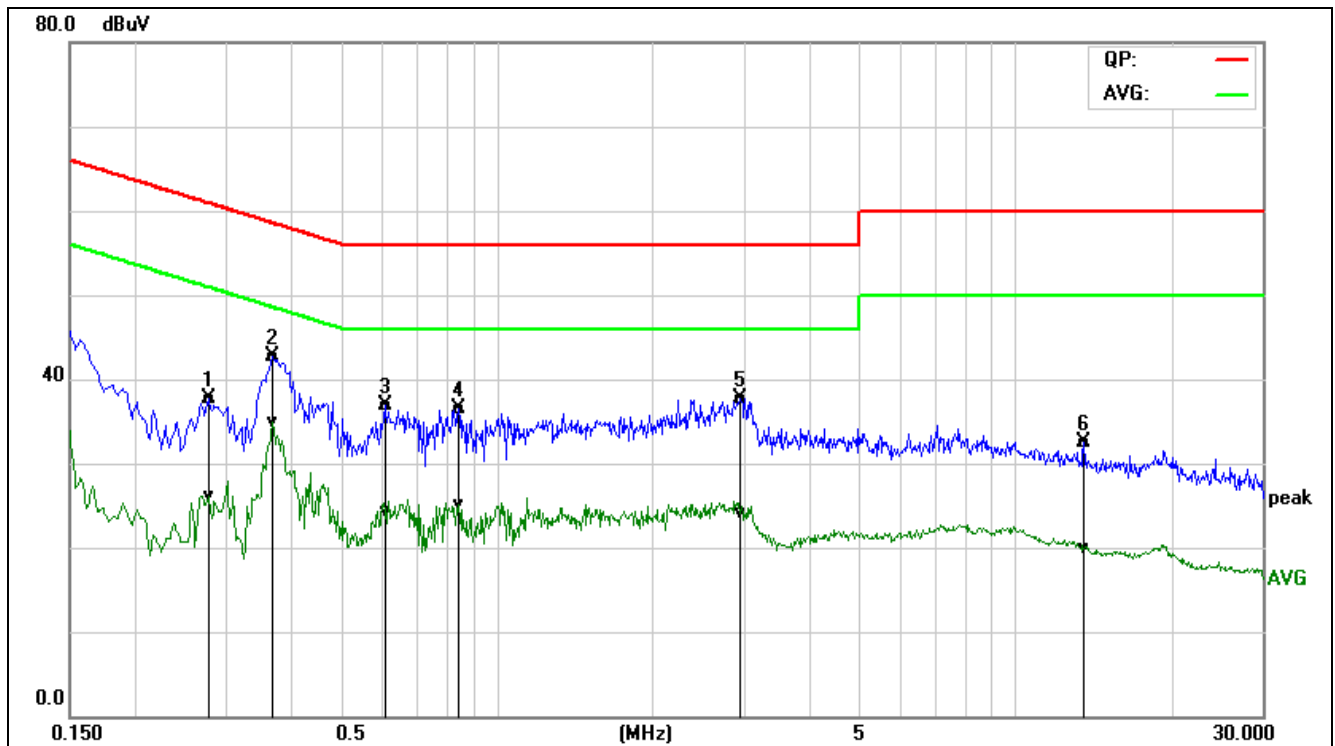

Frequency (MHz)	QuasiPeak Reading (dBuV)	Average Reading (dBuV)	Correction Factor (dB)	QuasiPeak Result (dBuV)	Average Result (dBuV)	QuasiPeak Limit (dBuV)	Average Limit (dBuV)	QuasiPeak Margin (dB)	Average Margin (dB)	Remark (Pass/Fail)	Line (L1/L2)
0.2779	18.01	6.50	19.64	37.65	26.14	60.88	50.88	-23.23	-24.74	Pass	L1
0.3700	22.99	15.31	19.63	42.62	34.94	58.50	48.50	-15.88	-13.56	Pass	L1
0.6100	17.16	4.51	19.72	36.88	24.23	56.00	46.00	-19.12	-21.77	Pass	L1
0.8460	16.86	5.40	19.73	36.59	25.13	56.00	46.00	-19.41	-20.87	Pass	L1
2.9580	18.07	4.40	19.69	37.76	24.09	56.00	46.00	-18.24	-21.91	Pass	L1
13.5940	12.50	-0.08	19.98	32.48	19.90	60.00	50.00	-27.52	-30.10	Pass	L1

REMARKS: L1 = Line One (Live Line)



<b>Model No.</b>	SR570ac	<b>RBW,VBW</b>	9 kHz
<b>Environmental Conditions</b>	22°C, 45% RH	<b>Test Mode</b>	Mode 1
<b>Tested by</b>	Darry Wu	<b>Line</b>	L2
<b>Test Date</b>	March 26, 2017	<b>Test Voltage</b>	AC120V/60Hz

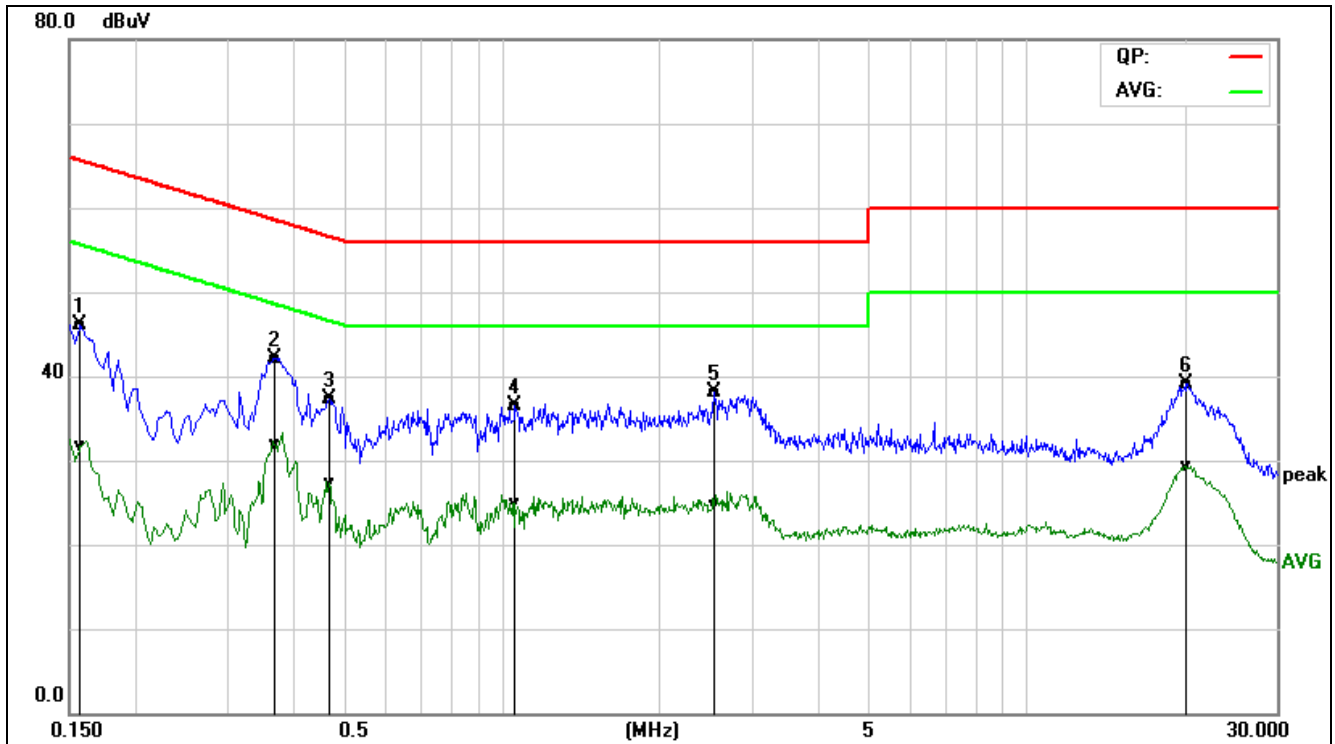

Frequency (MHz)	QuasiPeak Reading (dBuV)	Average Reading (dBuV)	Correction Factor (dB)	QuasiPeak Result (dBuV)	Average Result (dBuV)	QuasiPeak Limit (dBuV)	Average Limit (dBuV)	QuasiPeak Margin (dB)	Average Margin (dB)	Remark (Pass/Fail)	Line (L1/L2)
0.1580	26.46	11.98	19.72	46.18	31.70	65.56	55.57	-19.38	-23.87	Pass	L2
0.3700	22.52	12.31	19.67	42.19	31.98	58.50	48.50	-16.31	-16.52	Pass	L2
0.4700	17.73	7.67	19.64	37.37	27.31	56.51	46.51	-19.14	-19.20	Pass	L2
1.0620	16.73	5.15	19.74	36.47	24.89	56.00	46.00	-19.53	-21.11	Pass	L2
2.5460	18.45	4.98	19.72	38.17	24.70	56.00	46.00	-17.83	-21.30	Pass	L2
20.0580	19.28	9.55	19.82	39.10	29.37	60.00	50.00	-20.90	-20.63	Pass	L2

**REMARKS:** L2 = Line Two (Neutral Line)



<b>Model No.</b>	SR570ac	<b>RBW,VBW</b>	9 kHz
<b>Environmental Conditions</b>	22°C, 45% RH	<b>Test Mode</b>	Mode 1
<b>Tested by</b>	Darry Wu	<b>Line</b>	L1
<b>Test Date</b>	March 26, 2017	<b>Test Voltage</b>	AC240V/50Hz

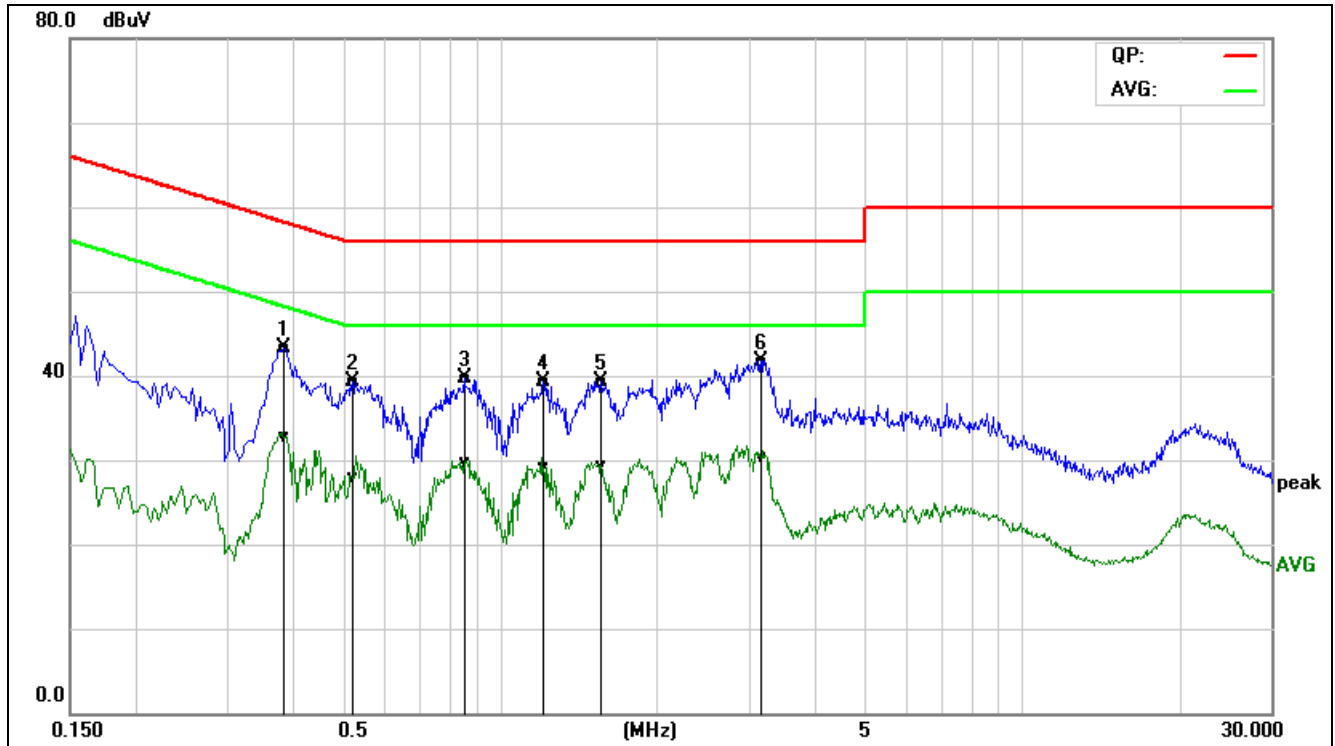

Frequency (MHz)	QuasiPeak Reading (dBuV)	Average Reading (dBuV)	Correction Factor (dB)	QuasiPeak Result (dBuV)	Average Result (dBuV)	QuasiPeak Limit (dBuV)	Average Limit (dBuV)	QuasiPeak Margin (dB)	Average Margin (dB)	Remark (Pass/Fail)	Line (L1/L2)
0.3860	23.64	13.17	19.63	43.27	32.80	58.15	48.15	-14.88	-15.35	Pass	L1
0.5220	19.63	8.21	19.65	39.28	27.86	56.00	46.00	-16.72	-18.14	Pass	L1
0.8540	19.92	10.02	19.73	39.65	29.75	56.00	46.00	-16.35	-16.25	Pass	L1
1.2100	19.64	9.36	19.66	39.30	29.02	56.00	46.00	-16.70	-16.98	Pass	L1
1.5620	19.60	9.71	19.69	39.29	29.40	56.00	46.00	-16.71	-16.60	Pass	L1
3.1700	22.08	10.70	19.68	41.76	30.38	56.00	46.00	-14.24	-15.62	Pass	L1

**REMARKS:** L1 = Line One (Live Line)



<b>Model No.</b>	SR570ac	<b>RBW,VBW</b>	9 kHz
<b>Environmental Conditions</b>	22°C, 45% RH	<b>Test Mode</b>	Mode 1
<b>Tested by</b>	Darry Wu	<b>Line</b>	L2
<b>Test Date</b>	March 26, 2017	<b>Test Voltage</b>	AC240V/50Hz

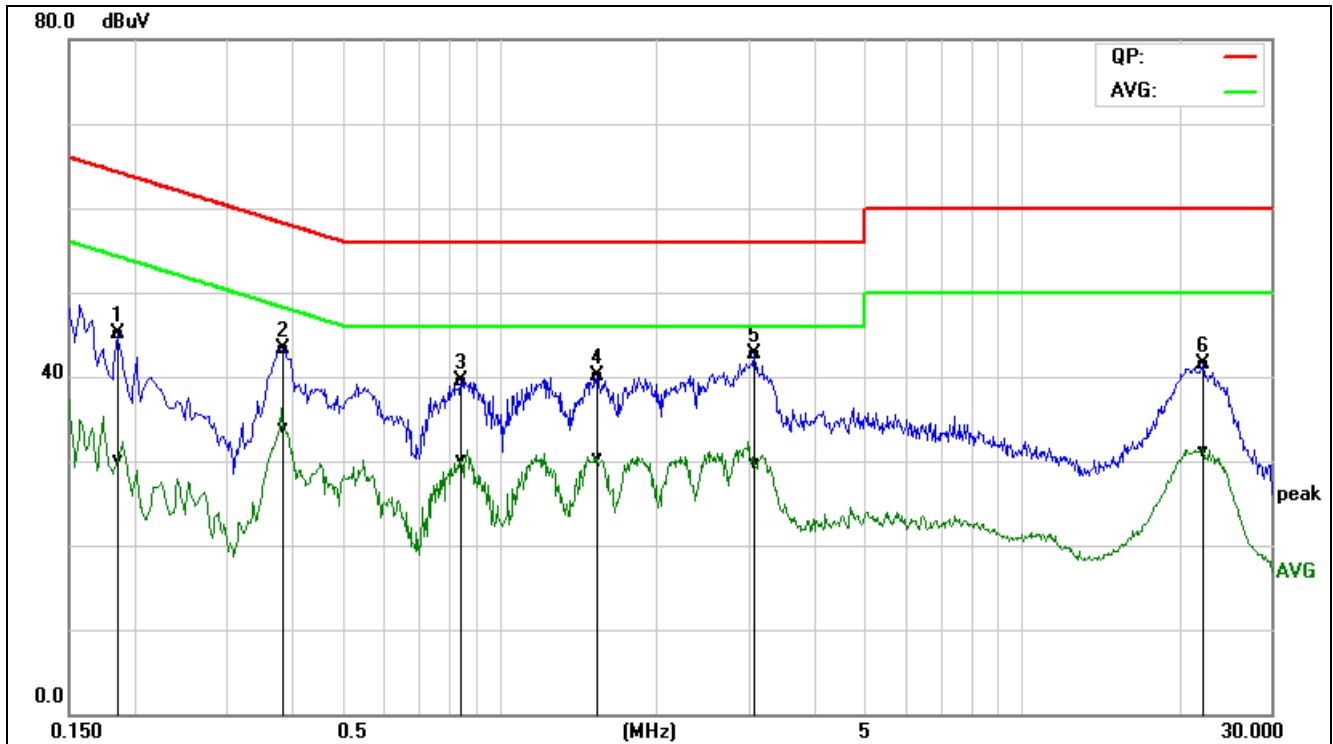

Frequency (MHz)	QuasiPeak Reading (dBuV)	Average Reading (dBuV)	Correction Factor (dB)	QuasiPeak Result (dBuV)	Average Result (dBuV)	QuasiPeak Limit (dBuV)	Average Limit (dBuV)	QuasiPeak Margin (dB)	Average Margin (dB)	Remark (Pass/Fail)	Line (L1/L2)
0.1860	25.45	10.32	19.73	45.18	30.05	64.21	54.21	-19.03	-24.16	Pass	L2
0.3860	23.62	14.25	19.67	43.29	33.92	58.15	48.15	-14.86	-14.23	Pass	L2
0.8460	19.79	10.32	19.73	39.52	30.05	56.00	46.00	-16.48	-15.95	Pass	L2
1.5420	20.30	10.47	19.74	40.04	30.21	56.00	46.00	-15.96	-15.79	Pass	L2
3.0740	22.91	10.06	19.72	42.63	29.78	56.00	46.00	-13.37	-16.22	Pass	L2
22.2620	21.65	11.31	19.83	41.48	31.14	60.00	50.00	-18.52	-18.86	Pass	L2

**REMARKS:** L2 = Line Two (Neutral Line)



## 6.10 FREQUENCY STABILITY

### 6.10.1 LIMIT

According to §15.407(g), manufacturers of U-NII devices are responsible for ensuring frequency stability such that an emission is maintained within the band of operation under all conditions of normal operation as specified in the operational description.

### 6.10.2 TEST INSTRUMENTS

Name of Equipment	Manufacturer	Model Number	Serial Number	Last Calibration	Due Calibration
Spectrum Analyzer	Agilent	N9010A	MY52221469	02/21/2017	02/20/2018
DC Power Supply	DAZHENG	PS-605D	20018978	N.C.R	N.C.R
AC POWER SOUCE	UMART	HPA1010	N/A	N.C.R	N.C.R
Power Meter	Anritsu	ML2495A	1204003	02/21/2017	02/20/2018
Power Sensor	Anritsu	MA2411B	1126150	02/21/2017	02/20/2018
Temperature Chamber	TERCHY	MHG-800N	E21104	11/18/2015	11/17/2016
Temp. / Humidity Meter	Anymetre	JR913	N/A	02/21/2017	02/20/2018

### 6.10.3 TEST CONFIGURATION

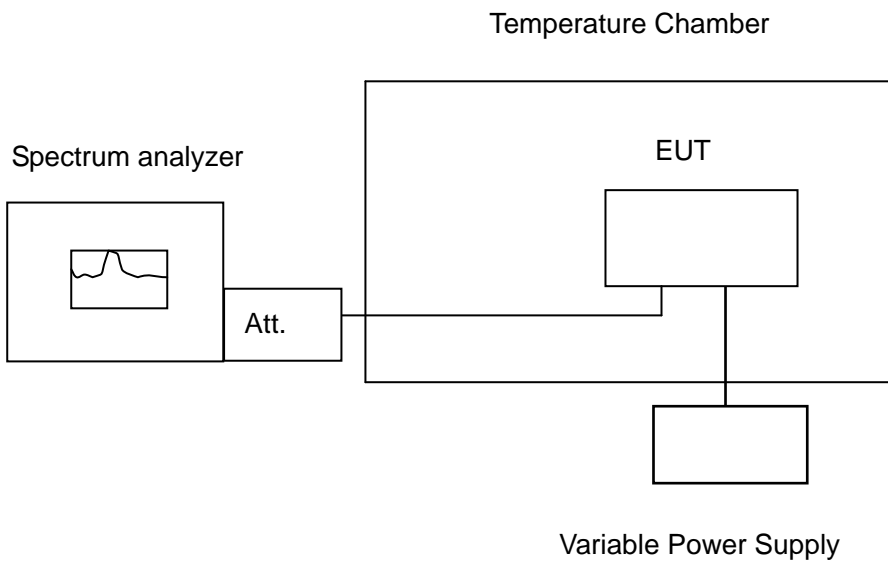

**Remark:** Measurement setup for testing on Antenna connector



#### 6.10.4 TEST PROCEDURE

The equipment under test was connected to an external AC or DC power supply and input rated voltage. RF output was connected to a frequency counter or spectrum analyzer via feed through attenuators. The EUT was placed inside the temperature chamber. Set the spectrum analyzer RBW low enough to obtain the desired frequency resolution and measure EUT 20°C operating frequency as reference frequency. Turn EUT off and set the chamber temperature to -20°C. After the temperature stabilized for approximately 30 minutes recorded the frequency. Repeat step measure with 10°C increased per stage until the highest temperature of +50°C reached.

#### 6.10.5 TEST RESULTS

*No non-compliance noted.*



Test Data  
Antenna 0

IEEE 802.11a MHz mode / 5180 ~ 5240MHz (Low)

Environment Temperature (°C)	Volage (V)	Measured Frequency (MHz)	limit Range	Test Result
50	120	5179.960145	5150-5250	PASS
40	120	5179.957179	5150-5250	PASS
30	120	5179.981861	5150-5250	PASS
20	120	5179.997950	5150-5250	PASS
10	120	5179.996203	5150-5250	PASS
0	120	5179.954864	5150-5250	PASS
-10	120	5179.961070	5150-5250	PASS
-20	120	5179.965590	5150-5250	PASS

Environment Temperature (°C)	Volage (V)	Measured Frequency (MHz)	limit Range	Test Result
20	108	5179.988841	5150-5250	PASS
	120	5179.996000	5150-5250	PASS
	132	5179.996233	5150-5250	PASS

IEEE 802.11a MHz mode / 5180 ~ 5240MHz (High)

Environment Temperature (°C)	Volage (V)	Measured Frequency (MHz)	limit Range	Test Result
50	120	5239.991174	5150-5250	PASS
40	120	5239.972838	5150-5250	PASS
30	120	5239.985520	5150-5250	PASS
20	120	5239.992000	5150-5250	PASS
10	120	5239.954573	5150-5250	PASS
0	120	5239.953797	5150-5250	PASS
-10	120	5239.990132	5150-5250	PASS
-20	120	5239.998665	5150-5250	PASS

Environment Temperature (°C)	Volage (V)	Measured Frequency (MHz)	limit Range	Test Result
20	108	5239.992555	5150-5250	PASS
	120	5239.999200	5150-5250	PASS
	132	5239.950494	5150-5250	PASS



**IEEE 802.11a mode / 5260 ~ 5320MHz (Low)**

Environment Temperature (°C)	Volage (V)	Measured Frequency (MHz)	limit Range	Test Result
50	120	5259.960815	5250-5350	PASS
40	120	5259.977677	5250-5350	PASS
30	120	5259.955394	5250-5350	PASS
20	120	5260.003000	5250-5350	PASS
10	120	5259.966263	5250-5350	PASS
0	120	5259.971933	5250-5350	PASS
-10	120	5259.974045	5250-5350	PASS
-20	120	5259.967618	5250-5350	PASS

Environment Temperature (°C)	Volage (V)	Measured Frequency (MHz)	limit Range	Test Result
20	108	5259.985488	5250-5350	PASS
	120	5259.995200	5250-5350	PASS
	132	5259.987338	5250-5350	PASS

**IEEE 802.11a mode / 5260 ~ 5320MHz (High)**

Environment Temperature (°C)	Volage (V)	Measured Frequency (MHz)	limit Range	Test Result
50	120	5319.952513	5250-5350	PASS
40	120	5319.966902	5250-5350	PASS
30	120	5319.973721	5250-5350	PASS
20	120	5320.005000	5250-5350	PASS
10	120	5319.994383	5250-5350	PASS
0	120	5319.998874	5250-5350	PASS
-10	120	5319.95038	5250-5350	PASS
-20	120	5319.974688	5250-5350	PASS

Environment Temperature (°C)	Volage (V)	Measured Frequency (MHz)	limit Range	Test Result
20	108	5319.965881	5250-5350	PASS
	120	5320.001000	5250-5350	PASS
	132	5319.970744	5250-5350	PASS





**IEEE 802.11a mode / 5500 ~ 5700MHz (Low)**

Environment Temperature (°C)	Volage (V)	Measured Frequency (MHz)	limit Range	Test Result
50	120	5499.974753	5475-5725	PASS
40	120	5499.956853	5475-5725	PASS
30	120	5499.973605	5475-5725	PASS
20	120	5500.006000	5475-5725	PASS
10	120	5499.976673	5475-5725	PASS
0	120	5499.985808	5475-5725	PASS
-10	120	5499.978766	5475-5725	PASS
-20	120	5499.965150	5475-5725	PASS

Environment Temperature (°C)	Volage (V)	Measured Frequency (MHz)	limit Range	Test Result
20	108	5499.962487	5475-5725	PASS
	120	5500.002000	5475-5725	PASS
	132	5499.950809	5475-5725	PASS

**IEEE 802.11a mode / 5500 ~ 5700MHz (High)**

Environment Temperature (°C)	Volage (V)	Measured Frequency (MHz)	limit Range	Test Result
50	120	5699.976115	5475-5725	PASS
40	120	5699.956656	5475-5725	PASS
30	120	5699.986079	5475-5725	PASS
20	120	5699.996300	5475-5725	PASS
10	120	5699.957438	5475-5725	PASS
0	120	5699.958179	5475-5725	PASS
-10	120	5699.979497	5475-5725	PASS
-20	120	5699.953252	5475-5725	PASS

Environment Temperature (°C)	Volage (V)	Measured Frequency (MHz)	limit Range	Test Result
20	108	5699.985737	5475-5725	PASS
	120	5699.999700	5475-5725	PASS
	132	5699.975843	5475-5725	PASS



**IEEE 802.11a mode / 5745 ~ 5825MHz (Low)**

Environment Temperature (°C)	Volage (V)	Measured Frequency (MHz)	limit Range	Test Result
50	120	5744.984355	5725-5850	PASS
40	120	5744.959772	5725-5850	PASS
30	120	5744.998960	5725-5850	PASS
20	120	5744.998500	5725-5850	PASS
10	120	5744.997979	5725-5850	PASS
0	120	5744.985299	5725-5850	PASS
-10	120	5744.973105	5725-5850	PASS
-20	120	5744.983852	5725-5850	PASS

Environment Temperature (°C)	Volage (V)	Measured Frequency (MHz)	limit Range	Test Result
20	108	5744.970049	5725-5850	PASS
	120	5744.998690	5725-5850	PASS
	132	5744.986533	5725-5850	PASS

**IEEE 802.11a mode / 5745 ~ 5825MHz (High)**

Environment Temperature (°C)	Volage (V)	Measured Frequency (MHz)	limit Range	Test Result
50	120	5824.967245	5725-5850	PASS
40	120	5824.955471	5725-5850	PASS
30	120	5824.983490	5725-5850	PASS
20	120	5824.997200	5725-5850	PASS
10	120	5824.981343	5725-5850	PASS
0	120	5824.953143	5725-5850	PASS
-10	120	5824.974455	5725-5850	PASS
-20	120	5824.969068	5725-5850	PASS

Environment Temperature (°C)	Volage (V)	Measured Frequency (MHz)	limit Range	Test Result
20	108	5824.950104	5725-5850	PASS
	120	5824.996820	5725-5850	PASS
	132	5824.976297	5725-5850	PASS



Antenna 1

IEEE 802.11a MHz mode / 5180 ~ 5240MHz (Low)

Environment Temperature (°C)	Volage (V)	Measured Frequency (MHz)	limit Range	Test Result
50	120	5179.987087	5150-5250	PASS
40	120	5179.962568	5150-5250	PASS
30	120	5179.967402	5150-5250	PASS
20	120	5179.993100	5150-5250	PASS
10	120	5179.979810	5150-5250	PASS
0	120	5179.964440	5150-5250	PASS
-10	120	5179.965674	5150-5250	PASS
-20	120	5179.975653	5150-5250	PASS

Environment Temperature (°C)	Volage (V)	Measured Frequency (MHz)	limit Range	Test Result
20	108	5179.985423	5150-5250	PASS
	120	5179.997500	5150-5250	PASS
	132	5179.959262	5150-5250	PASS

IEEE 802.11a MHz mode / 5180 ~ 5240MHz (High)

Environment Temperature (°C)	Volage (V)	Measured Frequency (MHz)	limit Range	Test Result
50	120	5239.959801	5150-5250	PASS
40	120	5239.983292	5150-5250	PASS
30	120	5239.992030	5150-5250	PASS
20	120	5240.005000	5150-5250	PASS
10	120	5239.984058	5150-5250	PASS
0	120	5239.995851	5150-5250	PASS
-10	120	5239.993953	5150-5250	PASS
-20	120	5239.968463	5150-5250	PASS

Environment Temperature (°C)	Volage (V)	Measured Frequency (MHz)	limit Range	Test Result
20	108	5239.953217	5150-5250	PASS
	120	5240.002000	5150-5250	PASS
	132	5239.962744	5150-5250	PASS



**IEEE 802.11a mode / 5260 ~ 5320MHz (Low)**

Environment Temperature (°C)	Volage (V)	Measured Frequency (MHz)	limit Range	Test Result
50	120	5259.985491	5250-5350	PASS
40	120	5259.951668	5250-5350	PASS
30	120	5259.994790	5250-5350	PASS
20	120	5260.007000	5250-5350	PASS
10	120	5259.950101	5250-5350	PASS
0	120	5259.967861	5250-5350	PASS
-10	120	5259.971158	5250-5350	PASS
-20	120	5259.972382	5250-5350	PASS

Environment Temperature (°C)	Volage (V)	Measured Frequency (MHz)	limit Range	Test Result
20	108	5259.976898	5250-5350	PASS
	120	5260.007000	5250-5350	PASS
	132	5259.990450	5250-5350	PASS

**IEEE 802.11a mode / 5260 ~ 5320MHz (High)**

Environment Temperature (°C)	Volage (V)	Measured Frequency (MHz)	limit Range	Test Result
50	120	5319.970733	5250-5350	PASS
40	120	5319.983744	5250-5350	PASS
30	120	5319.953138	5250-5350	PASS
20	120	5320.004000	5250-5350	PASS
10	120	5319.975900	5250-5350	PASS
0	120	5319.963786	5250-5350	PASS
-10	120	5319.972937	5250-5350	PASS
-20	120	5319.987435	5250-5350	PASS

Environment Temperature (°C)	Volage (V)	Measured Frequency (MHz)	limit Range	Test Result
20	108	5319.979617	5250-5350	PASS
	120	5320.008000	5250-5350	PASS
	132	5319.976039	5250-5350	PASS



IEEE 802.11a mode / 5500 ~ 5700MHz (Low)

Environment Temperature (°C)	Volage (V)	Measured Frequency (MHz)	limit Range	Test Result
50	120	5499.991063	5475-5725	PASS
40	120	5499.964291	5475-5725	PASS
30	120	5499.949791	5475-5725	PASS
20	120	5500.003000	5475-5725	PASS
10	120	5499.964593	5475-5725	PASS
0	120	5499.963949	5475-5725	PASS
-10	120	5499.979052	5475-5725	PASS
-20	120	5499.984243	5475-5725	PASS

Environment Temperature (°C)	Volage (V)	Measured Frequency (MHz)	limit Range	Test Result
20	108	5499.997645	5475-5725	PASS
	120	5500.008000	5475-5725	PASS
	132	5499.992769	5475-5725	PASS

IEEE 802.11a mode / 5500 ~ 5700MHz (High)

Environment Temperature (°C)	Volage (V)	Measured Frequency (MHz)	limit Range	Test Result
50	120	5699.971892	5475-5725	PASS
40	120	5699.958511	5475-5725	PASS
30	120	5699.998687	5475-5725	PASS
20	120	5699.992300	5475-5725	PASS
10	120	5699.961869	5475-5725	PASS
0	120	5699.952266	5475-5725	PASS
-10	120	5699.952232	5475-5725	PASS
-20	120	5699.963570	5475-5725	PASS

Environment Temperature (°C)	Volage (V)	Measured Frequency (MHz)	limit Range	Test Result
20	108	5699.966249	5475-5725	PASS
	120	5699.996500	5475-5725	PASS
	132	5699.993889	5475-5725	PASS



**IEEE 802.11a mode / 5745 ~ 5825MHz (Low)**

Environment Temperature (°C)	Volage (V)	Measured Frequency (MHz)	limit Range	Test Result
50	120	5744.994676	5725-5850	PASS
40	120	5744.985057	5725-5850	PASS
30	120	5744.985372	5725-5850	PASS
20	120	5744.998720	5725-5850	PASS
10	120	5744.964560	5725-5850	PASS
0	120	5744.989712	5725-5850	PASS
-10	120	5744.989809	5725-5850	PASS
-20	120	5744.977183	5725-5850	PASS

Environment Temperature (°C)	Volage (V)	Measured Frequency (MHz)	limit Range	Test Result
20	108	5744.988624	5725-5850	PASS
	120	5744.998370	5725-5850	PASS
	132	5744.973756	5725-5850	PASS

**IEEE 802.11a mode / 5745 ~ 5825MHz (High)**

Environment Temperature (°C)	Volage (V)	Measured Frequency (MHz)	limit Range	Test Result
50	120	5824.977402	5725-5850	PASS
40	120	5824.968581	5725-5850	PASS
30	120	5824.960756	5725-5850	PASS
20	120	5825.009000	5725-5850	PASS
10	120	5824.973748	5725-5850	PASS
0	120	5824.961625	5725-5850	PASS
-10	120	5824.973133	5725-5850	PASS
-20	120	5824.969004	5725-5850	PASS

Environment Temperature (°C)	Volage (V)	Measured Frequency (MHz)	limit Range	Test Result
20	108	5824.975680	5725-5850	PASS
	120	5825.002000	5725-5850	PASS
	132	5824.979010	5725-5850	PASS



Antenna 2

IEEE 802.11a MHz mode / 5180 ~ 5240MHz (Low)

Environment Temperature (°C)	Volage (V)	Measured Frequency (MHz)	limit Range	Test Result
50	120	5179.987849	5150-5250	PASS
40	120	5179.977118	5150-5250	PASS
30	120	5179.961597	5150-5250	PASS
20	120	5179.992500	5150-5250	PASS
10	120	5179.954901	5150-5250	PASS
0	120	5179.961763	5150-5250	PASS
-10	120	5179.956245	5150-5250	PASS
-20	120	5179.998919	5150-5250	PASS

Environment Temperature (°C)	Volage (V)	Measured Frequency (MHz)	limit Range	Test Result
20	108	5179.999824	5150-5250	PASS
	120	5179.993100	5150-5250	PASS
	132	5179.994531	5150-5250	PASS

IEEE 802.11a MHz mode / 5180 ~ 5240MHz (High)

Environment Temperature (°C)	Volage (V)	Measured Frequency (MHz)	limit Range	Test Result
50	120	5239.982332	5150-5250	PASS
40	120	5239.993781	5150-5250	PASS
30	120	5239.957831	5150-5250	PASS
20	120	5240.007000	5150-5250	PASS
10	120	5239.949367	5150-5250	PASS
0	120	5239.991472	5150-5250	PASS
-10	120	5239.964723	5150-5250	PASS
-20	120	5239.962531	5150-5250	PASS

Environment Temperature (°C)	Volage (V)	Measured Frequency (MHz)	limit Range	Test Result
20	108	5239.955269	5150-5250	PASS
	120	5240.003000	5150-5250	PASS
	132	5239.951284	5150-5250	PASS



**IEEE 802.11a mode / 5260 ~ 5320MHz (Low)**

Environment Temperature (°C)	Volage (V)	Measured Frequency (MHz)	limit Range	Test Result
50	120	5259.966014	5250-5350	PASS
40	120	5259.984008	5250-5350	PASS
30	120	5259.995823	5250-5350	PASS
20	120	5260.002000	5250-5350	PASS
10	120	5259.970423	5250-5350	PASS
0	120	5259.994435	5250-5350	PASS
-10	120	5259.987935	5250-5350	PASS
-20	120	5259.957390	5250-5350	PASS

Environment Temperature (°C)	Volage (V)	Measured Frequency (MHz)	limit Range	Test Result
20	108	5259.958429	5250-5350	PASS
	120	5260.006000	5250-5350	PASS
	132	5259.967234	5250-5350	PASS

**IEEE 802.11a mode / 5260 ~ 5320MHz (High)**

Environment Temperature (°C)	Volage (V)	Measured Frequency (MHz)	limit Range	Test Result
50	120	5319.952562	5250-5350	PASS
40	120	5319.951506	5250-5350	PASS
30	120	5319.950723	5250-5350	PASS
20	120	5320.001000	5250-5350	PASS
10	120	5319.950441	5250-5350	PASS
0	120	5319.952074	5250-5350	PASS
-10	120	5319.985571	5250-5350	PASS
-20	120	5319.980562	5250-5350	PASS

Environment Temperature (°C)	Volage (V)	Measured Frequency (MHz)	limit Range	Test Result
20	108	5319.975624	5250-5350	PASS
	120	5320.008000	5250-5350	PASS
	132	5319.998958	5250-5350	PASS





**IEEE 802.11a mode / 5500 ~ 5700MHz (Low)**

Environment Temperature (°C)	Volage (V)	Measured Frequency (MHz)	limit Range	Test Result
50	120	5499.985320	5475-5725	PASS
40	120	5499.986959	5475-5725	PASS
30	120	5499.962606	5475-5725	PASS
20	120	5500.002000	5475-5725	PASS
10	120	5499.950417	5475-5725	PASS
0	120	5499.967732	5475-5725	PASS
-10	120	5499.970088	5475-5725	PASS
-20	120	5499.977760	5475-5725	PASS

Environment Temperature (°C)	Volage (V)	Measured Frequency (MHz)	limit Range	Test Result
20	108	5499.974232	5475-5725	PASS
	120	5500.007000	5475-5725	PASS
	132	5499.958644	5475-5725	PASS

**IEEE 802.11a mode / 5500 ~ 5700MHz (High)**

Environment Temperature (°C)	Volage (V)	Measured Frequency (MHz)	limit Range	Test Result
50	120	5699.995258	5475-5725	PASS
40	120	5699.972954	5475-5725	PASS
30	120	5699.976848	5475-5725	PASS
20	120	5699.994900	5475-5725	PASS
10	120	5699.988833	5475-5725	PASS
0	120	5699.978888	5475-5725	PASS
-10	120	5699.997694	5475-5725	PASS
-20	120	5699.978778	5475-5725	PASS

Environment Temperature (°C)	Volage (V)	Measured Frequency (MHz)	limit Range	Test Result
20	108	5699.949099	5475-5725	PASS
	120	5699.996100	5475-5725	PASS
	132	5699.974387	5475-5725	PASS



**IEEE 802.11a mode / 5745 ~ 5825MHz (Low)**

Environment Temperature (°C)	Volage (V)	Measured Frequency (MHz)	limit Range	Test Result
50	120	5744.981266	5725-5850	PASS
40	120	5744.955971	5725-5850	PASS
30	120	5744.996669	5725-5850	PASS
20	120	5744.998435	5725-5850	PASS
10	120	5744.960301	5725-5850	PASS
0	120	5744.987533	5725-5850	PASS
-10	120	5744.996371	5725-5850	PASS
-20	120	5744.962530	5725-5850	PASS

Environment Temperature (°C)	Volage (V)	Measured Frequency (MHz)	limit Range	Test Result
20	108	5744.989925	5725-5850	PASS
	120	5744.998286	5725-5850	PASS
	132	5744.983181	5725-5850	PASS

**IEEE 802.11a mode / 5745 ~ 5825MHz (High)**

Environment Temperature (°C)	Volage (V)	Measured Frequency (MHz)	limit Range	Test Result
50	120	5824.959639	5725-5850	PASS
40	120	5824.954981	5725-5850	PASS
30	120	5824.954139	5725-5850	PASS
20	120	5824.996510	5725-5850	PASS
10	120	5824.986326	5725-5850	PASS
0	120	5824.958708	5725-5850	PASS
-10	120	5824.975249	5725-5850	PASS
-20	120	5824.999128	5725-5850	PASS

Environment Temperature (°C)	Volage (V)	Measured Frequency (MHz)	limit Range	Test Result
20	108	5824.952244	5725-5850	PASS
	120	5824.997590	5725-5850	PASS
	132	5824.967891	5725-5850	PASS



Antenna 3

IEEE 802.11a MHz mode / 5180 ~ 5240MHz (Low)

Environment Temperature (°C)	Volage (V)	Measured Frequency (MHz)	limit Range	Test Result
50	120	5179.990152	5150-5250	PASS
40	120	5179.959485	5150-5250	PASS
30	120	5179.989896	5150-5250	PASS
20	120	5179.997200	5150-5250	PASS
10	120	5179.982634	5150-5250	PASS
0	120	5179.975491	5150-5250	PASS
-10	120	5179.991033	5150-5250	PASS
-20	120	5179.958457	5150-5250	PASS

Environment Temperature (°C)	Volage (V)	Measured Frequency (MHz)	limit Range	Test Result
20	108	5179.950822	5150-5250	PASS
	120	5179.993900	5150-5250	PASS
	132	5179.979144	5150-5250	PASS

IEEE 802.11a MHz mode / 5180 ~ 5240MHz (High)

Environment Temperature (°C)	Volage (V)	Measured Frequency (MHz)	limit Range	Test Result
50	120	5239.990153	5150-5250	PASS
40	120	5239.990665	5150-5250	PASS
30	120	5239.986585	5150-5250	PASS
20	120	5239.991900	5150-5250	PASS
10	120	5239.965757	5150-5250	PASS
0	120	5239.965119	5150-5250	PASS
-10	120	5239.999803	5150-5250	PASS
-20	120	5239.997717	5150-5250	PASS

Environment Temperature (°C)	Volage (V)	Measured Frequency (MHz)	limit Range	Test Result
20	108	5239.975316	5150-5250	PASS
	120	5240.000000	5150-5250	PASS
	132	5239.975713	5150-5250	PASS



**IEEE 802.11a mode / 5260 ~ 5320MHz (Low)**

Environment Temperature (°C)	Volage (V)	Measured Frequency (MHz)	limit Range	Test Result
50	120	5259.983352	5250-5350	PASS
40	120	5259.967110	5250-5350	PASS
30	120	5259.996135	5250-5350	PASS
20	120	5260.007000	5250-5350	PASS
10	120	5259.985675	5250-5350	PASS
0	120	5259.959244	5250-5350	PASS
-10	120	5259.964915	5250-5350	PASS
-20	120	5259.987659	5250-5350	PASS

Environment Temperature (°C)	Volage (V)	Measured Frequency (MHz)	limit Range	Test Result
20	108	5259.957900	5250-5350	PASS
	120	5259.995100	5250-5350	PASS
	132	5259.959064	5250-5350	PASS

**IEEE 802.11a mode / 5260 ~ 5320MHz (High)**

Environment Temperature (°C)	Volage (V)	Measured Frequency (MHz)	limit Range	Test Result
50	120	5319.99935	5250-5350	PASS
40	120	5319.951816	5250-5350	PASS
30	120	5319.971832	5250-5350	PASS
20	120	5320.008000	5250-5350	PASS
10	120	5319.998504	5250-5350	PASS
0	120	5319.964573	5250-5350	PASS
-10	120	5319.999316	5250-5350	PASS
-20	120	5319.960724	5250-5350	PASS

Environment Temperature (°C)	Volage (V)	Measured Frequency (MHz)	limit Range	Test Result
20	108	5319.956453	5250-5350	PASS
	120	5320.002000	5250-5350	PASS
	132	5319.987085	5250-5350	PASS



**IEEE 802.11a mode / 5500 ~ 5700MHz (Low)**

Environment Temperature (°C)	Volage (V)	Measured Frequency (MHz)	limit Range	Test Result
50	120	5499.984808	5475-5725	PASS
40	120	5499.973103	5475-5725	PASS
30	120	5499.959297	5475-5725	PASS
20	120	5500.007000	5475-5725	PASS
10	120	5499.955869	5475-5725	PASS
0	120	5499.956798	5475-5725	PASS
-10	120	5499.961496	5475-5725	PASS
-20	120	5499.968749	5475-5725	PASS

Environment Temperature (°C)	Volage (V)	Measured Frequency (MHz)	limit Range	Test Result
20	108	5499.972420	5475-5725	PASS
	120	5500.009000	5475-5725	PASS
	132	5499.993843	5475-5725	PASS

**IEEE 802.11a mode / 5500 ~ 5700MHz (High)**

Environment Temperature (°C)	Volage (V)	Measured Frequency (MHz)	limit Range	Test Result
50	120	5699.979833	5475-5725	PASS
40	120	5699.977344	5475-5725	PASS
30	120	5699.998158	5475-5725	PASS
20	120	5699.996820	5475-5725	PASS
10	120	5699.961931	5475-5725	PASS
0	120	5699.950964	5475-5725	PASS
-10	120	5699.979209	5475-5725	PASS
-20	120	5699.978116	5475-5725	PASS

Environment Temperature (°C)	Volage (V)	Measured Frequency (MHz)	limit Range	Test Result
20	108	5699.963361	5475-5725	PASS
	120	5699.999300	5475-5725	PASS
	132	5699.963169	5475-5725	PASS



IEEE 802.11a mode / 5745 ~ 5825MHz (Low)

Environment Temperature (°C)	Volage (V)	Measured Frequency (MHz)	limit Range	Test Result
50	120	5744.988537	5725-5850	PASS
40	120	5744.984579	5725-5850	PASS
30	120	5744.995638	5725-5850	PASS
20	120	5744.998720	5725-5850	PASS
10	120	5744.968812	5725-5850	PASS
0	120	5744.995944	5725-5850	PASS
-10	120	5744.970587	5725-5850	PASS
-20	120	5744.964437	5725-5850	PASS

Environment Temperature (°C)	Volage (V)	Measured Frequency (MHz)	limit Range	Test Result
20	108	5744.979387	5725-5850	PASS
	120	5744.998581	5725-5850	PASS
	132	5744.978338	5725-5850	PASS

IEEE 802.11a mode / 5745 ~ 5825MHz (High)

Environment Temperature (°C)	Volage (V)	Measured Frequency (MHz)	limit Range	Test Result
50	120	5824.956352	5725-5850	PASS
40	120	5824.974405	5725-5850	PASS
30	120	5824.962684	5725-5850	PASS
20	120	5824.997930	5725-5850	PASS
10	120	5824.986216	5725-5850	PASS
0	120	5824.953260	5725-5850	PASS
-10	120	5824.995049	5725-5850	PASS
-20	120	5824.990560	5725-5850	PASS

Environment Temperature (°C)	Volage (V)	Measured Frequency (MHz)	limit Range	Test Result
20	108	5824.966153	5725-5850	PASS
	120	5824.996530	5725-5850	PASS
	132	5824.994302	5725-5850	PASS



Antenna 0

IEEE 802.11n HT 20 MHz mode / 5180 ~ 5240MHz (Low)

Environment Temperature (°C)	Volage (V)	Measured Frequency (MHz)	limit Range	Test Result
50	120	5179.993511	5150-5250	PASS
40	120	5179.979166	5150-5250	PASS
30	120	5179.961340	5150-5250	PASS
20	120	5179.998570	5150-5250	PASS
10	120	5179.993817	5150-5250	PASS
0	120	5179.951853	5150-5250	PASS
-10	120	5179.987465	5150-5250	PASS
-20	120	5179.987349	5150-5250	PASS

Environment Temperature (°C)	Volage (V)	Measured Frequency (MHz)	limit Range	Test Result
20	108	5179.971607	5150-5250	PASS
	120	5179.983700	5150-5250	PASS
	132	5179.977462	5150-5250	PASS

IEEE 802.11n HT 20 MHz mode / 5180 ~ 5240MHz (High)

Environment Temperature (°C)	Volage (V)	Measured Frequency (MHz)	limit Range	Test Result
50	120	5239.953896	5150-5250	PASS
40	120	5239.975654	5150-5250	PASS
30	120	5239.958086	5150-5250	PASS
20	120	5239.997890	5150-5250	PASS
10	120	5239.977397	5150-5250	PASS
0	120	5239.975873	5150-5250	PASS
-10	120	5239.962554	5150-5250	PASS
-20	120	5239.972453	5150-5250	PASS

Environment Temperature (°C)	Volage (V)	Measured Frequency (MHz)	limit Range	Test Result
20	108	5239.954314	5150-5250	PASS
	120	5239.993700	5150-5250	PASS
	132	5239.989361	5150-5250	PASS



**IEEE 802.11n HT 20 MHz mode / 5260 ~ 5320MHz (Low)**

Environment Temperature (°C)	Volage (V)	Measured Frequency (MHz)	limit Range	Test Result
50	120	5259.985472	5250-5350	PASS
40	120	5259.970412	5250-5350	PASS
30	120	5259.979788	5250-5350	PASS
20	120	5259.995720	5250-5350	PASS
10	120	5259.958347	5250-5350	PASS
0	120	5259.977406	5250-5350	PASS
-10	120	5259.993142	5250-5350	PASS
-20	120	5259.961577	5250-5350	PASS

Environment Temperature (°C)	Volage (V)	Measured Frequency (MHz)	limit Range	Test Result
20	108	5259.951735	5250-5350	PASS
	120	5259.992600	5250-5350	PASS
	132	5259.970846	5250-5350	PASS

**IEEE 802.11n HT 20 MHz mode / 5260 ~ 5320MHz (High)**

Environment Temperature (°C)	Volage (V)	Measured Frequency (MHz)	limit Range	Test Result
50	120	5319.956567	5250-5350	PASS
40	120	5319.994527	5250-5350	PASS
30	120	5319.991475	5250-5350	PASS
20	120	5319.998650	5250-5350	PASS
10	120	5319.986396	5250-5350	PASS
0	120	5319.977486	5250-5350	PASS
-10	120	5319.972900	5250-5350	PASS
-20	120	5319.964648	5250-5350	PASS

Environment Temperature (°C)	Volage (V)	Measured Frequency (MHz)	limit Range	Test Result
20	108	5319.974385	5250-5350	PASS
	120	5319.993700	5250-5350	PASS
	132	5319.999250	5250-5350	PASS





**IEEE 802.11n HT 20 MHz mode / 5500 ~ 5700MHz (Low)**

Environment Temperature (°C)	Volage (V)	Measured Frequency (MHz)	limit Range	Test Result
50	120	5499.960947	5475-5725	PASS
40	120	5499.992563	5475-5725	PASS
30	120	5499.964336	5475-5725	PASS
20	120	5499.994820	5475-5725	PASS
10	120	5499.998947	5475-5725	PASS
0	120	5499.985052	5475-5725	PASS
-10	120	5499.953463	5475-5725	PASS
-20	120	5499.977853	5475-5725	PASS

Environment Temperature (°C)	Volage (V)	Measured Frequency (MHz)	limit Range	Test Result
20	108	5499.997234	5475-5725	PASS
	120	5499.997000	5475-5725	PASS
	132	5499.967285	5475-5725	PASS

**IEEE 802.11n HT 20 MHz mode / 5500 ~ 5700MHz (High)**

Environment Temperature (°C)	Volage (V)	Measured Frequency (MHz)	limit Range	Test Result
50	120	5699.977001	5475-5725	PASS
40	120	5699.974282	5475-5725	PASS
30	120	5699.966327	5475-5725	PASS
20	120	5699.991900	5475-5725	PASS
10	120	5699.976080	5475-5725	PASS
0	120	5699.956018	5475-5725	PASS
-10	120	5699.972176	5475-5725	PASS
-20	120	5699.965220	5475-5725	PASS

Environment Temperature (°C)	Volage (V)	Measured Frequency (MHz)	limit Range	Test Result
20	108	5699.949927	5475-5725	PASS
	120	5699.998350	5475-5725	PASS
	132	5699.955371	5475-5725	PASS



**IEEE 802.11n HT 20 MHz mode / 5745 ~ 5825MHz (Low)**

Environment Temperature (°C)	Volage (V)	Measured Frequency (MHz)	limit Range	Test Result
50	120	5744.976550	5725-5850	PASS
40	120	5744.954433	5725-5850	PASS
30	120	5744.965598	5725-5850	PASS
20	120	5744.998290	5725-5850	PASS
10	120	5744.994917	5725-5850	PASS
0	120	5744.969628	5725-5850	PASS
-10	120	5744.951732	5725-5850	PASS
-20	120	5744.985086	5725-5850	PASS

Environment Temperature (°C)	Volage (V)	Measured Frequency (MHz)	limit Range	Test Result
20	108	5744.999634	5725-5850	PASS
	120	5744.998420	5725-5850	PASS
	132	5744.965173	5725-5850	PASS

**IEEE 802.11n HT 20 MHz mode / 5745 ~ 5825MHz (High)**

Environment Temperature (°C)	Volage (V)	Measured Frequency (MHz)	limit Range	Test Result
50	120	5824.984259	5725-5850	PASS
40	120	5824.986585	5725-5850	PASS
30	120	5824.994843	5725-5850	PASS
20	120	5824.997810	5725-5850	PASS
10	120	5824.988171	5725-5850	PASS
0	120	5824.991842	5725-5850	PASS
-10	120	5824.969520	5725-5850	PASS
-20	120	5824.983152	5725-5850	PASS

Environment Temperature (°C)	Volage (V)	Measured Frequency (MHz)	limit Range	Test Result
20	108	5824.951778	5725-5850	PASS
	120	5824.995700	5725-5850	PASS
	132	5824.990090	5725-5850	PASS



Antenna 1

IEEE 802.11n HT 20 MHz mode / 5180 ~ 5240MHz (Low)

Environment Temperature (°C)	Volage (V)	Measured Frequency (MHz)	limit Range	Test Result
50	120	5179.998916	5150-5250	PASS
40	120	5179.953151	5150-5250	PASS
30	120	5179.970630	5150-5250	PASS
20	120	5179.994200	5150-5250	PASS
10	120	5179.977993	5150-5250	PASS
0	120	5179.992323	5150-5250	PASS
-10	120	5179.963292	5150-5250	PASS
-20	120	5179.977449	5150-5250	PASS

Environment Temperature (°C)	Volage (V)	Measured Frequency (MHz)	limit Range	Test Result
20	108	5179.953148	5150-5250	PASS
	120	5179.995300	5150-5250	PASS
	132	5179.965485	5150-5250	PASS

IEEE 802.11n HT 20 MHz mode / 5180 ~ 5240MHz (High)

Environment Temperature (°C)	Volage (V)	Measured Frequency (MHz)	limit Range	Test Result
50	120	5239.954174	5150-5250	PASS
40	120	5239.989966	5150-5250	PASS
30	120	5239.982702	5150-5250	PASS
20	120	5240.003600	5150-5250	PASS
10	120	5239.989448	5150-5250	PASS
0	120	5239.995648	5150-5250	PASS
-10	120	5239.953710	5150-5250	PASS
-20	120	5239.972345	5150-5250	PASS

Environment Temperature (°C)	Volage (V)	Measured Frequency (MHz)	limit Range	Test Result
20	108	5239.952575	5150-5250	PASS
	120	5240.008000	5150-5250	PASS
	132	5239.987544	5150-5250	PASS



**IEEE 802.11n HT 20 MHz mode / 5260 ~ 5320MHz (Low)**

Environment Temperature (°C)	Volage (V)	Measured Frequency (MHz)	limit Range	Test Result
50	120	5259.958403	5250-5350	PASS
40	120	5259.951352	5250-5350	PASS
30	120	5259.957428	5250-5350	PASS
20	120	5260.004000	5250-5350	PASS
10	120	5259.973966	5250-5350	PASS
0	120	5259.985516	5250-5350	PASS
-10	120	5259.962750	5250-5350	PASS
-20	120	5259.972063	5250-5350	PASS

Environment Temperature (°C)	Volage (V)	Measured Frequency (MHz)	limit Range	Test Result
20	108	5259.965523	5250-5350	PASS
	120	5260.007000	5250-5350	PASS
	132	5259.970490	5250-5350	PASS

**IEEE 802.11n HT 20 MHz mode / 5260 ~ 5320MHz (High)**

Environment Temperature (°C)	Volage (V)	Measured Frequency (MHz)	limit Range	Test Result
50	120	5319.981302	5250-5350	PASS
40	120	5319.974058	5250-5350	PASS
30	120	5319.964338	5250-5350	PASS
20	120	5320.006000	5250-5350	PASS
10	120	5319.987069	5250-5350	PASS
0	120	5319.996194	5250-5350	PASS
-10	120	5319.979898	5250-5350	PASS
-20	120	5319.995475	5250-5350	PASS

Environment Temperature (°C)	Volage (V)	Measured Frequency (MHz)	limit Range	Test Result
20	108	5319.996856	5250-5350	PASS
	120	5320.001000	5250-5350	PASS
	132	5319.999987	5250-5350	PASS



**IEEE 802.11n HT 20 MHz mode / 5500 ~ 5700MHz (Low)**

Environment Temperature (°C)	Volage (V)	Measured Frequency (MHz)	limit Range	Test Result
50	120	5499.995880	5475-5725	PASS
40	120	5499.974666	5475-5725	PASS
30	120	5499.968109	5475-5725	PASS
20	120	5500.005000	5475-5725	PASS
10	120	5499.984089	5475-5725	PASS
0	120	5499.953605	5475-5725	PASS
-10	120	5499.950779	5475-5725	PASS
-20	120	5499.959624	5475-5725	PASS

Environment Temperature (°C)	Volage (V)	Measured Frequency (MHz)	limit Range	Test Result
20	108	5499.996437	5475-5725	PASS
	120	5500.005000	5475-5725	PASS
	132	5499.975477	5475-5725	PASS

**IEEE 802.11n HT 20 MHz mode / 5500 ~ 5700MHz (High)**

Environment Temperature (°C)	Volage (V)	Measured Frequency (MHz)	limit Range	Test Result
50	120	5699.978695	5475-5725	PASS
40	120	5699.992075	5475-5725	PASS
30	120	5699.954800	5475-5725	PASS
20	120	5699.998300	5475-5725	PASS
10	120	5699.951854	5475-5725	PASS
0	120	5699.971561	5475-5725	PASS
-10	120	5699.966370	5475-5725	PASS
-20	120	5699.969362	5475-5725	PASS

Environment Temperature (°C)	Volage (V)	Measured Frequency (MHz)	limit Range	Test Result
20	108	5699.956070	5475-5725	PASS
	120	5699.992700	5475-5725	PASS
	132	5699.964939	5475-5725	PASS



**IEEE 802.11n HT 20 MHz mode / 5745 ~ 5825MHz (Low)**

Environment Temperature (°C)	Volage (V)	Measured Frequency (MHz)	limit Range	Test Result
50	120	5744.979577	5725-5850	PASS
40	120	5744.957777	5725-5850	PASS
30	120	5744.986142	5725-5850	PASS
20	120	5744.996200	5725-5850	PASS
10	120	5744.962939	5725-5850	PASS
0	120	5744.955935	5725-5850	PASS
-10	120	5744.998287	5725-5850	PASS
-20	120	5744.982775	5725-5850	PASS

Environment Temperature (°C)	Volage (V)	Measured Frequency (MHz)	limit Range	Test Result
20	108	5744.976465	5725-5850	PASS
	120	5744.994100	5725-5850	PASS
	132	5744.995195	5725-5850	PASS

**IEEE 802.11n HT 20 MHz mode / 5745 ~ 5825MHz (High)**

Environment Temperature (°C)	Volage (V)	Measured Frequency (MHz)	limit Range	Test Result
50	120	5824.950290	5725-5850	PASS
40	120	5824.958876	5725-5850	PASS
30	120	5824.996899	5725-5850	PASS
20	120	5824.997200	5725-5850	PASS
10	120	5824.987824	5725-5850	PASS
0	120	5824.950620	5725-5850	PASS
-10	120	5824.964881	5725-5850	PASS
-20	120	5824.953995	5725-5850	PASS

Environment Temperature (°C)	Volage (V)	Measured Frequency (MHz)	limit Range	Test Result
20	108	5824.975190	5725-5850	PASS
	120	5824.992900	5725-5850	PASS
	132	5824.993912	5725-5850	PASS



Antenna 2

IEEE 802.11n HT 20 MHz mode / 5180 ~ 5240MHz (Low)

Environment Temperature (°C)	Volage (V)	Measured Frequency (MHz)	limit Range	Test Result
50	120	5179.958367	5150-5250	PASS
40	120	5179.988724	5150-5250	PASS
30	120	5179.962894	5150-5250	PASS
20	120	5179.993300	5150-5250	PASS
10	120	5179.962370	5150-5250	PASS
0	120	5179.970615	5150-5250	PASS
-10	120	5179.978196	5150-5250	PASS
-20	120	5179.987891	5150-5250	PASS

Environment Temperature (°C)	Volage (V)	Measured Frequency (MHz)	limit Range	Test Result
20	108	5179.967818	5150-5250	PASS
	120	5179.996200	5150-5250	PASS
	132	5179.990484	5150-5250	PASS

IEEE 802.11n HT 20 MHz mode / 5180 ~ 5240MHz (High)

Environment Temperature (°C)	Volage (V)	Measured Frequency (MHz)	limit Range	Test Result
50	120	5239.966881	5150-5250	PASS
40	120	5239.953583	5150-5250	PASS
30	120	5239.950041	5150-5250	PASS
20	120	5239.995000	5150-5250	PASS
10	120	5239.990337	5150-5250	PASS
0	120	5239.963733	5150-5250	PASS
-10	120	5239.973406	5150-5250	PASS
-20	120	5239.989646	5150-5250	PASS

Environment Temperature (°C)	Volage (V)	Measured Frequency (MHz)	limit Range	Test Result
20	108	5239.989374	5150-5250	PASS
	120	5239.998310	5150-5250	PASS
	132	5239.954671	5150-5250	PASS



**IEEE 802.11n HT 20 MHz mode / 5260 ~ 5320MHz (Low)**

Environment Temperature (°C)	Volage (V)	Measured Frequency (MHz)	limit Range	Test Result
50	120	5259.972042	5250-5350	PASS
40	120	5259.989229	5250-5350	PASS
30	120	5259.977608	5250-5350	PASS
20	120	5259.998200	5250-5350	PASS
10	120	5259.970969	5250-5350	PASS
0	120	5259.981596	5250-5350	PASS
-10	120	5259.972033	5250-5350	PASS
-20	120	5259.983343	5250-5350	PASS

Environment Temperature (°C)	Volage (V)	Measured Frequency (MHz)	limit Range	Test Result
20	108	5259.962460	5250-5350	PASS
	120	5259.993700	5250-5350	PASS
	132	5259.961822	5250-5350	PASS

**IEEE 802.11n HT 20 MHz mode / 5260 ~ 5320MHz (High)**

Environment Temperature (°C)	Volage (V)	Measured Frequency (MHz)	limit Range	Test Result
50	120	5319.987061	5250-5350	PASS
40	120	5319.975158	5250-5350	PASS
30	120	5319.958362	5250-5350	PASS
20	120	5319.995200	5250-5350	PASS
10	120	5319.971312	5250-5350	PASS
0	120	5319.983312	5250-5350	PASS
-10	120	5319.998128	5250-5350	PASS
-20	120	5319.987096	5250-5350	PASS

Environment Temperature (°C)	Volage (V)	Measured Frequency (MHz)	limit Range	Test Result
20	108	5319.965127	5250-5350	PASS
	120	5319.994600	5250-5350	PASS
	132	5319.978776	5250-5350	PASS





**IEEE 802.11n HT 20 MHz mode / 5500 ~ 5700MHz (Low)**

Environment Temperature (°C)	Volage (V)	Measured Frequency (MHz)	limit Range	Test Result
50	120	5499.965550	5475-5725	PASS
40	120	5499.977838	5475-5725	PASS
30	120	5499.961479	5475-5725	PASS
20	120	5499.997200	5475-5725	PASS
10	120	5499.974685	5475-5725	PASS
0	120	5499.956591	5475-5725	PASS
-10	120	5499.962072	5475-5725	PASS
-20	120	5499.967284	5475-5725	PASS

Environment Temperature (°C)	Volage (V)	Measured Frequency (MHz)	limit Range	Test Result
20	108	5499.970344	5475-5725	PASS
	120	5499.995300	5475-5725	PASS
	132	5499.978716	5475-5725	PASS

**IEEE 802.11n HT 20 MHz mode / 5500 ~ 5700MHz (High)**

Environment Temperature (°C)	Volage (V)	Measured Frequency (MHz)	limit Range	Test Result
50	120	5699.984745	5475-5725	PASS
40	120	5699.994572	5475-5725	PASS
30	120	5699.968587	5475-5725	PASS
20	120	5699.994200	5475-5725	PASS
10	120	5699.987866	5475-5725	PASS
0	120	5699.987745	5475-5725	PASS
-10	120	5699.993260	5475-5725	PASS
-20	120	5699.960479	5475-5725	PASS

Environment Temperature (°C)	Volage (V)	Measured Frequency (MHz)	limit Range	Test Result
20	108	5699.975151	5475-5725	PASS
	120	5699.994600	5475-5725	PASS
	132	5699.970049	5475-5725	PASS



**IEEE 802.11n HT 20 MHz mode / 5745 ~ 5825MHz (Low)**

Environment Temperature (°C)	Volage (V)	Measured Frequency (MHz)	limit Range	Test Result
50	120	5744.962135	5725-5850	PASS
40	120	5744.989740	5725-5850	PASS
30	120	5744.977862	5725-5850	PASS
20	120	5744.998260	5725-5850	PASS
10	120	5744.959733	5725-5850	PASS
0	120	5744.958808	5725-5850	PASS
-10	120	5744.992270	5725-5850	PASS
-20	120	5744.975749	5725-5850	PASS

Environment Temperature (°C)	Volage (V)	Measured Frequency (MHz)	limit Range	Test Result
20	108	5744.971003	5725-5850	PASS
	120	5744.998720	5725-5850	PASS
	132	5744.966150	5725-5850	PASS

**IEEE 802.11n HT 20 MHz mode / 5745 ~ 5825MHz (High)**

Environment Temperature (°C)	Volage (V)	Measured Frequency (MHz)	limit Range	Test Result
50	120	5824.986972	5725-5850	PASS
40	120	5824.983873	5725-5850	PASS
30	120	5824.958746	5725-5850	PASS
20	120	5824.997280	5725-5850	PASS
10	120	5824.955037	5725-5850	PASS
0	120	5824.967155	5725-5850	PASS
-10	120	5824.973399	5725-5850	PASS
-20	120	5824.984590	5725-5850	PASS

Environment Temperature (°C)	Volage (V)	Measured Frequency (MHz)	limit Range	Test Result
20	108	5824.960440	5725-5850	PASS
	120	5824.997780	5725-5850	PASS
	132	5824.985453	5725-5850	PASS



Antenna 3

IEEE 802.11n HT 20 MHz mode / 5180 ~ 5240MHz (Low)

Environment Temperature (°C)	Volage (V)	Measured Frequency (MHz)	limit Range	Test Result
50	120	5179.997797	5150-5250	PASS
40	120	5179.996685	5150-5250	PASS
30	120	5179.961936	5150-5250	PASS
20	120	5179.998280	5150-5250	PASS
10	120	5179.998057	5150-5250	PASS
0	120	5179.997520	5150-5250	PASS
-10	120	5179.965156	5150-5250	PASS
-20	120	5179.994220	5150-5250	PASS

Environment Temperature (°C)	Volage (V)	Measured Frequency (MHz)	limit Range	Test Result
20	108	5179.995157	5150-5250	PASS
	120	5179.998300	5150-5250	PASS
	132	5179.988812	5150-5250	PASS

IEEE 802.11n HT 20 MHz mode / 5180 ~ 5240MHz (High)

Environment Temperature (°C)	Volage (V)	Measured Frequency (MHz)	limit Range	Test Result
50	120	5239.953774	5150-5250	PASS
40	120	5239.951864	5150-5250	PASS
30	120	5239.997439	5150-5250	PASS
20	120	5239.997692	5150-5250	PASS
10	120	5239.984926	5150-5250	PASS
0	120	5239.965273	5150-5250	PASS
-10	120	5239.997447	5150-5250	PASS
-20	120	5239.982757	5150-5250	PASS

Environment Temperature (°C)	Volage (V)	Measured Frequency (MHz)	limit Range	Test Result
20	108	5239.970188	5150-5250	PASS
	120	5239.995800	5150-5250	PASS
	132	5239.986032	5150-5250	PASS



**IEEE 802.11n HT 20 MHz mode / 5260 ~ 5320MHz (Low)**

Environment Temperature (°C)	Volage (V)	Measured Frequency (MHz)	limit Range	Test Result
50	120	5259.968322	5250-5350	PASS
40	120	5259.966639	5250-5350	PASS
30	120	5259.966934	5250-5350	PASS
20	120	5259.995820	5250-5350	PASS
10	120	5259.976717	5250-5350	PASS
0	120	5259.987744	5250-5350	PASS
-10	120	5259.952515	5250-5350	PASS
-20	120	5259.981062	5250-5350	PASS

Environment Temperature (°C)	Volage (V)	Measured Frequency (MHz)	limit Range	Test Result
20	108	5259.980245	5250-5350	PASS
	120	5259.996000	5250-5350	PASS
	132	5259.956655	5250-5350	PASS

**IEEE 802.11n HT 20 MHz mode / 5260 ~ 5320MHz (High)**

Environment Temperature (°C)	Volage (V)	Measured Frequency (MHz)	limit Range	Test Result
50	120	5319.999750	5250-5350	PASS
40	120	5319.987624	5250-5350	PASS
30	120	5319.984481	5250-5350	PASS
20	120	5319.998360	5250-5350	PASS
10	120	5319.956197	5250-5350	PASS
0	120	5319.973851	5250-5350	PASS
-10	120	5319.969393	5250-5350	PASS
-20	120	5319.971995	5250-5350	PASS

Environment Temperature (°C)	Volage (V)	Measured Frequency (MHz)	limit Range	Test Result
20	108	5319.971636	5250-5350	PASS
	120	5319.998200	5250-5350	PASS
	132	5319.969433	5250-5350	PASS



**IEEE 802.11n HT 20 MHz mode / 5500 ~ 5700MHz (Low)**

Environment Temperature (°C)	Volage (V)	Measured Frequency (MHz)	limit Range	Test Result
50	120	5499.956496	5475-5725	PASS
40	120	5499.954118	5475-5725	PASS
30	120	5499.961690	5475-5725	PASS
20	120	5499.994690	5475-5725	PASS
10	120	5499.999619	5475-5725	PASS
0	120	5499.982128	5475-5725	PASS
-10	120	5499.982618	5475-5725	PASS
-20	120	5499.963460	5475-5725	PASS

Environment Temperature (°C)	Volage (V)	Measured Frequency (MHz)	limit Range	Test Result
20	108	5499.954541	5475-5725	PASS
	120	5499.995200	5475-5725	PASS
	132	5499.966665	5475-5725	PASS

**IEEE 802.11n HT 20 MHz mode / 5500 ~ 5700MHz (High)**

Environment Temperature (°C)	Volage (V)	Measured Frequency (MHz)	limit Range	Test Result
50	120	5699.982699	5475-5725	PASS
40	120	5699.994698	5475-5725	PASS
30	120	5699.970831	5475-5725	PASS
20	120	5699.998170	5475-5725	PASS
10	120	5699.989216	5475-5725	PASS
0	120	5699.987473	5475-5725	PASS
-10	120	5699.967788	5475-5725	PASS
-20	120	5699.988246	5475-5725	PASS

Environment Temperature (°C)	Volage (V)	Measured Frequency (MHz)	limit Range	Test Result
20	108	5699.990786	5475-5725	PASS
	120	5699.998370	5475-5725	PASS
	132	5699.949420	5475-5725	PASS



**IEEE 802.11n HT 20 MHz mode / 5745 ~ 5825MHz (Low)**

Environment Temperature (°C)	Volage (V)	Measured Frequency (MHz)	limit Range	Test Result
50	120	5744.987472	5725-5850	PASS
40	120	5744.979429	5725-5850	PASS
30	120	5744.988563	5725-5850	PASS
20	120	5744.998460	5725-5850	PASS
10	120	5744.987950	5725-5850	PASS
0	120	5744.972161	5725-5850	PASS
-10	120	5744.961211	5725-5850	PASS
-20	120	5744.991859	5725-5850	PASS

Environment Temperature (°C)	Volage (V)	Measured Frequency (MHz)	limit Range	Test Result
20	108	5744.970497	5725-5850	PASS
	120	5744.998270	5725-5850	PASS
	132	5744.968255	5725-5850	PASS

**IEEE 802.11n HT 20 MHz mode / 5745 ~ 5825MHz (High)**

Environment Temperature (°C)	Volage (V)	Measured Frequency (MHz)	limit Range	Test Result
50	120	5824.977183	5725-5850	PASS
40	120	5824.989279	5725-5850	PASS
30	120	5824.950758	5725-5850	PASS
20	120	5824.997820	5725-5850	PASS
10	120	5824.992306	5725-5850	PASS
0	120	5824.985603	5725-5850	PASS
-10	120	5824.981417	5725-5850	PASS
-20	120	5824.984726	5725-5850	PASS

Environment Temperature (°C)	Volage (V)	Measured Frequency (MHz)	limit Range	Test Result
20	108	5824.960838	5725-5850	PASS
	120	5824.995280	5725-5850	PASS
	132	5824.978871	5725-5850	PASS



Antenna 0

IEEE 802.11n HT 40 MHz mode / 5190 ~ 5230MHz (Low)

Environment Temperature (°C)	Volage (V)	Measured Frequency (MHz)	limit Range	Test Result
50	120	5189.955387	5150-5250	PASS
40	120	5189.955052	5150-5250	PASS
30	120	5189.966658	5150-5250	PASS
20	120	5189.998200	5150-5250	PASS
10	120	5189.994891	5150-5250	PASS
0	120	5189.979976	5150-5250	PASS
-10	120	5189.987736	5150-5250	PASS
-20	120	5189.972893	5150-5250	PASS

Environment Temperature (°C)	Volage (V)	Measured Frequency (MHz)	limit Range	Test Result
20	108	5189.962193	5150-5250	PASS
	120	5189.998290	5150-5250	PASS
	132	5189.997417	5150-5250	PASS

IEEE 802.11n HT 40 MHz mode / 5190 ~ 5230MHz (High)

Environment Temperature (°C)	Volage (V)	Measured Frequency (MHz)	limit Range	Test Result
50	120	5229.999999	5150-5250	PASS
40	120	5229.969732	5150-5250	PASS
30	120	5229.989135	5150-5250	PASS
20	120	5230.002000	5150-5250	PASS
10	120	5229.973123	5150-5250	PASS
0	120	5229.981945	5150-5250	PASS
-10	120	5229.969565	5150-5250	PASS
-20	120	5229.988903	5150-5250	PASS

Environment Temperature (°C)	Volage (V)	Measured Frequency (MHz)	limit Range	Test Result
20	108	5229.951266	5150-5250	PASS
	120	5230.009000	5150-5250	PASS
	132	5229.992246	5150-5250	PASS



**IEEE 802.11n HT 40 MHz mode / 5270 ~ 5310MHz (Low)**

Environment Temperature (°C)	Volage (V)	Measured Frequency (MHz)	limit Range	Test Result
50	120	5269.966005	5250-5350	PASS
40	120	5269.955268	5250-5350	PASS
30	120	5269.992803	5250-5350	PASS
20	120	5270.007000	5250-5350	PASS
10	120	5269.977552	5250-5350	PASS
0	120	5269.973473	5250-5350	PASS
-10	120	5269.958929	5250-5350	PASS
-20	120	5269.989890	5250-5350	PASS

Environment Temperature (°C)	Volage (V)	Measured Frequency (MHz)	limit Range	Test Result
20	108	5269.972383	5250-5350	PASS
	120	5270.003000	5250-5350	PASS
	132	5269.959459	5250-5350	PASS

**IEEE 802.11n HT 40 MHz mode / 5270 ~ 5310MHz (High)**

Environment Temperature (°C)	Volage (V)	Measured Frequency (MHz)	limit Range	Test Result
50	120	5309.970996	5250-5350	PASS
40	120	5309.951185	5250-5350	PASS
30	120	5309.993239	5250-5350	PASS
20	120	5310.004000	5250-5350	PASS
10	120	5309.993220	5250-5350	PASS
0	120	5309.962558	5250-5350	PASS
-10	120	5309.958972	5250-5350	PASS
-20	120	5309.966649	5250-5350	PASS

Environment Temperature (°C)	Volage (V)	Measured Frequency (MHz)	limit Range	Test Result
20	108	5309.968259	5250-5350	PASS
	120	5310.001600	5250-5350	PASS
	132	5309.966055	5250-5350	PASS





**IEEE 802.11n HT 40 MHz mode / 5510 ~ 5670MHz (Low)**

Environment Temperature (°C)	Volage (V)	Measured Frequency (MHz)	limit Range	Test Result
50	120	5509.953479	5475-5725	PASS
40	120	5509.982526	5475-5725	PASS
30	120	5509.973469	5475-5725	PASS
20	120	5510.008000	5475-5725	PASS
10	120	5509.963603	5475-5725	PASS
0	120	5509.983271	5475-5725	PASS
-10	120	5509.960379	5475-5725	PASS
-20	120	5509.999365	5475-5725	PASS

Environment Temperature (°C)	Volage (V)	Measured Frequency (MHz)	limit Range	Test Result
20	108	5509.999102	5475-5725	PASS
	120	5510.002800	5475-5725	PASS
	132	5509.992119	5475-5725	PASS

**IEEE 802.11n HT 40 MHz mode / 5510 ~ 5670MHz (High)**

Environment Temperature (°C)	Volage (V)	Measured Frequency (MHz)	limit Range	Test Result
50	120	5669.967722	5475-5725	PASS
40	120	5669.968932	5475-5725	PASS
30	120	5669.962425	5475-5725	PASS
20	120	5670.007000	5475-5725	PASS
10	120	5669.959637	5475-5725	PASS
0	120	5669.982666	5475-5725	PASS
-10	120	5669.981236	5475-5725	PASS
-20	120	5669.991668	5475-5725	PASS

Environment Temperature (°C)	Volage (V)	Measured Frequency (MHz)	limit Range	Test Result
20	108	5669.984706	5475-5725	PASS
	120	5670.006000	5475-5725	PASS
	132	5669.954642	5475-5725	PASS



**IEEE 802.11n HT 40 MHz mode / 5755 ~ 5795MHz (Low)**

Environment Temperature (°C)	Volage (V)	Measured Frequency (MHz)	limit Range	Test Result
50	120	5754.970987	5725-5850	PASS
40	120	5754.966244	5725-5850	PASS
30	120	5754.978291	5725-5850	PASS
20	120	5754.996580	5725-5850	PASS
10	120	5754.994292	5725-5850	PASS
0	120	5754.953729	5725-5850	PASS
-10	120	5754.992598	5725-5850	PASS
-20	120	5754.982189	5725-5850	PASS

Environment Temperature (°C)	Volage (V)	Measured Frequency (MHz)	limit Range	Test Result
20	108	5754.974141	5725-5850	PASS
	120	5754.997420	5725-5850	PASS
	132	5754.989907	5725-5850	PASS

**IEEE 802.11n HT 40 MHz mode / 5755 ~ 5795MHz (High)**

Environment Temperature (°C)	Volage (V)	Measured Frequency (MHz)	limit Range	Test Result
50	120	5794.982202	5725-5850	PASS
40	120	5794.997847	5725-5850	PASS
30	120	5794.971003	5725-5850	PASS
20	120	5794.997100	5725-5850	PASS
10	120	5794.990400	5725-5850	PASS
0	120	5794.957521	5725-5850	PASS
-10	120	5794.988395	5725-5850	PASS
-20	120	5794.982473	5725-5850	PASS

Environment Temperature (°C)	Volage (V)	Measured Frequency (MHz)	limit Range	Test Result
20	108	5794.954500	5725-5850	PASS
	120	5794.997260	5725-5850	PASS
	132	5794.958806	5725-5850	PASS



Antenna 1

IEEE 802.11n HT 40 MHz mode / 5190 ~ 5230MHz (Low)

Environment Temperature (°C)	Volage (V)	Measured Frequency (MHz)	limit Range	Test Result
50	120	5189.989363	5150-5250	PASS
40	120	5189.951833	5150-5250	PASS
30	120	5189.970673	5150-5250	PASS
20	120	5190.003000	5150-5250	PASS
10	120	5189.988526	5150-5250	PASS
0	120	5189.985330	5150-5250	PASS
-10	120	5189.975640	5150-5250	PASS
-20	120	5189.975030	5150-5250	PASS

Environment Temperature (°C)	Volage (V)	Measured Frequency (MHz)	limit Range	Test Result
20	108	5189.979494	5150-5250	PASS
	120	5190.002000	5150-5250	PASS
	132	5189.952345	5150-5250	PASS

IEEE 802.11n HT 40 MHz mode / 5190 ~ 5230MHz (High)

Environment Temperature (°C)	Volage (V)	Measured Frequency (MHz)	limit Range	Test Result
50	120	5229.957348	5150-5250	PASS
40	120	5229.984187	5150-5250	PASS
30	120	5229.959956	5150-5250	PASS
20	120	5230.006000	5150-5250	PASS
10	120	5229.994192	5150-5250	PASS
0	120	5229.972516	5150-5250	PASS
-10	120	5229.992191	5150-5250	PASS
-20	120	5229.989142	5150-5250	PASS

Environment Temperature (°C)	Volage (V)	Measured Frequency (MHz)	limit Range	Test Result
20	108	5229.997742	5150-5250	PASS
	120	5230.002000	5150-5250	PASS
	132	5229.976057	5150-5250	PASS



**IEEE 802.11n HT 40 MHz mode / 5270 ~ 5310MHz (Low)**

Environment Temperature (°C)	Volage (V)	Measured Frequency (MHz)	limit Range	Test Result
50	120	5269.988169	5250-5350	PASS
40	120	5269.983375	5250-5350	PASS
30	120	5269.966076	5250-5350	PASS
20	120	5270.008000	5250-5350	PASS
10	120	5269.984824	5250-5350	PASS
0	120	5269.998402	5250-5350	PASS
-10	120	5269.976284	5250-5350	PASS
-20	120	5269.958211	5250-5350	PASS

Environment Temperature (°C)	Volage (V)	Measured Frequency (MHz)	limit Range	Test Result
20	108	5269.985270	5250-5350	PASS
	120	5270.003000	5250-5350	PASS
	132	5269.977030	5250-5350	PASS

**IEEE 802.11n HT 40 MHz mode / 5270 ~ 5310MHz (High)**

Environment Temperature (°C)	Volage (V)	Measured Frequency (MHz)	limit Range	Test Result
50	120	5309.980962	5250-5350	PASS
40	120	5309.982625	5250-5350	PASS
30	120	5309.998726	5250-5350	PASS
20	120	5310.007000	5250-5350	PASS
10	120	5309.953444	5250-5350	PASS
0	120	5309.950580	5250-5350	PASS
-10	120	5309.961790	5250-5350	PASS
-20	120	5309.960381	5250-5350	PASS

Environment Temperature (°C)	Volage (V)	Measured Frequency (MHz)	limit Range	Test Result
20	108	5309.960527	5250-5350	PASS
	120	5310.004100	5250-5350	PASS
	132	5309.973429	5250-5350	PASS



**IEEE 802.11n HT 40 MHz mode / 5510 ~ 5670MHz (Low)**

Environment Temperature (°C)	Volage (V)	Measured Frequency (MHz)	limit Range	Test Result
50	120	5509.986963	5475-5725	PASS
40	120	5509.966561	5475-5725	PASS
30	120	5509.954153	5475-5725	PASS
20	120	5509.992800	5475-5725	PASS
10	120	5509.997866	5475-5725	PASS
0	120	5509.984639	5475-5725	PASS
-10	120	5509.991403	5475-5725	PASS
-20	120	5509.977853	5475-5725	PASS

Environment Temperature (°C)	Volage (V)	Measured Frequency (MHz)	limit Range	Test Result
20	108	5509.951062	5475-5725	PASS
	120	5510.003690	5475-5725	PASS
	132	5509.979022	5475-5725	PASS

**IEEE 802.11n HT 40 MHz mode / 5510 ~ 5670MHz (High)**

Environment Temperature (°C)	Volage (V)	Measured Frequency (MHz)	limit Range	Test Result
50	120	5669.957429	5475-5725	PASS
40	120	5669.978862	5475-5725	PASS
30	120	5669.972120	5475-5725	PASS
20	120	5669.993700	5475-5725	PASS
10	120	5669.958497	5475-5725	PASS
0	120	5669.957998	5475-5725	PASS
-10	120	5669.973927	5475-5725	PASS
-20	120	5669.998446	5475-5725	PASS

Environment Temperature (°C)	Volage (V)	Measured Frequency (MHz)	limit Range	Test Result
20	108	5669.963875	5475-5725	PASS
	120	5670.007000	5475-5725	PASS
	132	5669.961292	5475-5725	PASS



**IEEE 802.11n HT 40 MHz mode / 5755 ~ 5795MHz (Low)**

Environment Temperature (°C)	Volage (V)	Measured Frequency (MHz)	limit Range	Test Result
50	120	5754.966499	5725-5850	PASS
40	120	5754.952749	5725-5850	PASS
30	120	5754.970692	5725-5850	PASS
20	120	5754.997100	5725-5850	PASS
10	120	5754.966911	5725-5850	PASS
0	120	5754.966571	5725-5850	PASS
-10	120	5754.995209	5725-5850	PASS
-20	120	5754.993246	5725-5850	PASS

Environment Temperature (°C)	Volage (V)	Measured Frequency (MHz)	limit Range	Test Result
20	108	5754.983386	5725-5850	PASS
	120	5754.996300	5725-5850	PASS
	132	5754.958534	5725-5850	PASS

**IEEE 802.11n HT 40 MHz mode / 5755 ~ 5795MHz (High)**

Environment Temperature (°C)	Volage (V)	Measured Frequency (MHz)	limit Range	Test Result
50	120	5794.998119	5725-5850	PASS
40	120	5794.958895	5725-5850	PASS
30	120	5794.965710	5725-5850	PASS
20	120	5794.996200	5725-5850	PASS
10	120	5794.952649	5725-5850	PASS
0	120	5794.998870	5725-5850	PASS
-10	120	5794.998565	5725-5850	PASS
-20	120	5794.974791	5725-5850	PASS

Environment Temperature (°C)	Volage (V)	Measured Frequency (MHz)	limit Range	Test Result
20	108	5794.995830	5725-5850	PASS
	120	5794.997100	5725-5850	PASS
	132	5794.954529	5725-5850	PASS



Antenna 2

IEEE 802.11n HT 40 MHz mode / 5190 ~ 5230MHz (Low)

Environment Temperature (°C)	Volage (V)	Measured Frequency (MHz)	limit Range	Test Result
50	120	5189.966948	5150-5250	PASS
40	120	5189.980981	5150-5250	PASS
30	120	5189.964343	5150-5250	PASS
20	120	5189.997200	5150-5250	PASS
10	120	5189.974072	5150-5250	PASS
0	120	5189.981442	5150-5250	PASS
-10	120	5189.955696	5150-5250	PASS
-20	120	5189.971271	5150-5250	PASS

Environment Temperature (°C)	Volage (V)	Measured Frequency (MHz)	limit Range	Test Result
20	108	5189.998261	5150-5250	PASS
	120	5189.992800	5150-5250	PASS
	132	5189.988633	5150-5250	PASS

IEEE 802.11n HT 40 MHz mode / 5190 ~ 5230MHz (High)

Environment Temperature (°C)	Volage (V)	Measured Frequency (MHz)	limit Range	Test Result
50	120	5229.995315	5150-5250	PASS
40	120	5229.972510	5150-5250	PASS
30	120	5229.976524	5150-5250	PASS
20	120	5230.005100	5150-5250	PASS
10	120	5229.988123	5150-5250	PASS
0	120	5229.953606	5150-5250	PASS
-10	120	5229.967003	5150-5250	PASS
-20	120	5229.976858	5150-5250	PASS

Environment Temperature (°C)	Volage (V)	Measured Frequency (MHz)	limit Range	Test Result
20	108	5229.954214	5150-5250	PASS
	120	5230.007000	5150-5250	PASS
	132	5229.975089	5150-5250	PASS



**IEEE 802.11n HT 40 MHz mode / 5270 ~ 5310MHz (Low)**

Environment Temperature (°C)	Volage (V)	Measured Frequency (MHz)	limit Range	Test Result
50	120	5269.994680	5250-5350	PASS
40	120	5269.974986	5250-5350	PASS
30	120	5269.996549	5250-5350	PASS
20	120	5270.004000	5250-5350	PASS
10	120	5269.959890	5250-5350	PASS
0	120	5269.977208	5250-5350	PASS
-10	120	5269.967582	5250-5350	PASS
-20	120	5269.964390	5250-5350	PASS

Environment Temperature (°C)	Volage (V)	Measured Frequency (MHz)	limit Range	Test Result
20	108	5269.958129	5250-5350	PASS
	120	5270.007000	5250-5350	PASS
	132	5269.977644	5250-5350	PASS

**IEEE 802.11n HT 40 MHz mode / 5270 ~ 5310MHz (High)**

Environment Temperature (°C)	Volage (V)	Measured Frequency (MHz)	limit Range	Test Result
50	120	5309.991730	5250-5350	PASS
40	120	5309.977613	5250-5350	PASS
30	120	5309.989044	5250-5350	PASS
20	120	5310.002000	5250-5350	PASS
10	120	5309.961672	5250-5350	PASS
0	120	5309.994145	5250-5350	PASS
-10	120	5309.990048	5250-5350	PASS
-20	120	5309.999940	5250-5350	PASS

Environment Temperature (°C)	Volage (V)	Measured Frequency (MHz)	limit Range	Test Result
20	108	5309.995803	5250-5350	PASS
	120	5310.001000	5250-5350	PASS
	132	5309.984808	5250-5350	PASS





**IEEE 802.11n HT 40 MHz mode / 5510 ~ 5670MHz (Low)**

Environment Temperature (°C)	Volage (V)	Measured Frequency (MHz)	limit Range	Test Result
50	120	5509.972043	5475-5725	PASS
40	120	5509.980067	5475-5725	PASS
30	120	5509.988952	5475-5725	PASS
20	120	5510.008000	5475-5725	PASS
10	120	5509.986695	5475-5725	PASS
0	120	5509.952542	5475-5725	PASS
-10	120	5509.975374	5475-5725	PASS
-20	120	5509.975098	5475-5725	PASS

Environment Temperature (°C)	Volage (V)	Measured Frequency (MHz)	limit Range	Test Result
20	108	5509.992323	5475-5725	PASS
	120	5510.000000	5475-5725	PASS
	132	5509.959429	5475-5725	PASS

**IEEE 802.11n HT 40 MHz mode / 5510 ~ 5670MHz (High)**

Environment Temperature (°C)	Volage (V)	Measured Frequency (MHz)	limit Range	Test Result
50	120	5669.989308	5475-5725	PASS
40	120	5669.977221	5475-5725	PASS
30	120	5669.955025	5475-5725	PASS
20	120	5670.005000	5475-5725	PASS
10	120	5669.998041	5475-5725	PASS
0	120	5669.967940	5475-5725	PASS
-10	120	5669.968561	5475-5725	PASS
-20	120	5669.969128	5475-5725	PASS

Environment Temperature (°C)	Volage (V)	Measured Frequency (MHz)	limit Range	Test Result
20	108	5669.988738	5475-5725	PASS
	120	5670.007000	5475-5725	PASS
	132	5669.986505	5475-5725	PASS



**IEEE 802.11n HT 40 MHz mode / 5755 ~ 5795MHz (Low)**

Environment Temperature (°C)	Volage (V)	Measured Frequency (MHz)	limit Range	Test Result
50	120	5754.995941	5725-5850	PASS
40	120	5754.961260	5725-5850	PASS
30	120	5754.965846	5725-5850	PASS
20	120	5754.997830	5725-5850	PASS
10	120	5754.980452	5725-5850	PASS
0	120	5754.980351	5725-5850	PASS
-10	120	5754.961402	5725-5850	PASS
-20	120	5754.983489	5725-5850	PASS

Environment Temperature (°C)	Volage (V)	Measured Frequency (MHz)	limit Range	Test Result
20	108	5754.974920	5725-5850	PASS
	120	5754.997590	5725-5850	PASS
	132	5754.988417	5725-5850	PASS

**IEEE 802.11n HT 40 MHz mode / 5755 ~ 5795MHz (High)**

Environment Temperature (°C)	Volage (V)	Measured Frequency (MHz)	limit Range	Test Result
50	120	5794.976601	5725-5850	PASS
40	120	5794.993343	5725-5850	PASS
30	120	5794.995945	5725-5850	PASS
20	120	5794.992710	5725-5850	PASS
10	120	5794.987228	5725-5850	PASS
0	120	5794.990476	5725-5850	PASS
-10	120	5794.957861	5725-5850	PASS
-20	120	5794.958333	5725-5850	PASS

Environment Temperature (°C)	Volage (V)	Measured Frequency (MHz)	limit Range	Test Result
20	108	5794.968484	5725-5850	PASS
	120	5794.992900	5725-5850	PASS
	132	5794.955927	5725-5850	PASS



Antenna 3

IEEE 802.11n HT 40 MHz mode / 5190 ~ 5230MHz (Low)

Environment Temperature (°C)	Volage (V)	Measured Frequency (MHz)	limit Range	Test Result
50	120	5189.952326	5150-5250	PASS
40	120	5189.976594	5150-5250	PASS
30	120	5189.952068	5150-5250	PASS
20	120	5189.993700	5150-5250	PASS
10	120	5189.985603	5150-5250	PASS
0	120	5189.976084	5150-5250	PASS
-10	120	5189.966136	5150-5250	PASS
-20	120	5189.953388	5150-5250	PASS

Environment Temperature (°C)	Volage (V)	Measured Frequency (MHz)	limit Range	Test Result
20	108	5189.976431	5150-5250	PASS
	120	5189.998490	5150-5250	PASS
	132	5189.960262	5150-5250	PASS

IEEE 802.11n HT 40 MHz mode / 5190 ~ 5230MHz (High)

Environment Temperature (°C)	Volage (V)	Measured Frequency (MHz)	limit Range	Test Result
50	120	5229.974591	5150-5250	PASS
40	120	5229.998937	5150-5250	PASS
30	120	5229.955487	5150-5250	PASS
20	120	5230.009000	5150-5250	PASS
10	120	5229.995028	5150-5250	PASS
0	120	5229.990438	5150-5250	PASS
-10	120	5229.960836	5150-5250	PASS
-20	120	5229.982390	5150-5250	PASS

Environment Temperature (°C)	Volage (V)	Measured Frequency (MHz)	limit Range	Test Result
20	108	5229.989149	5150-5250	PASS
	120	5230.002000	5150-5250	PASS
	132	5229.972361	5150-5250	PASS



IEEE 802.11n HT 40 MHz mode / 5270 ~ 5310MHz (Low)

Environment Temperature (°C)	Volage (V)	Measured Frequency (MHz)	limit Range	Test Result
50	120	5269.960337	5250-5350	PASS
40	120	5269.976207	5250-5350	PASS
30	120	5269.974523	5250-5350	PASS
20	120	5270.005000	5250-5350	PASS
10	120	5269.986228	5250-5350	PASS
0	120	5269.977476	5250-5350	PASS
-10	120	5269.958705	5250-5350	PASS
-20	120	5269.964382	5250-5350	PASS

Environment Temperature (°C)	Volage (V)	Measured Frequency (MHz)	limit Range	Test Result
20	108	5269.982957	5250-5350	PASS
	120	5270.002000	5250-5350	PASS
	132	5269.970002	5250-5350	PASS

IEEE 802.11n HT 40 MHz mode / 5270 ~ 5310MHz (High)

Environment Temperature (°C)	Volage (V)	Measured Frequency (MHz)	limit Range	Test Result
50	120	5309.993945	5250-5350	PASS
40	120	5309.997353	5250-5350	PASS
30	120	5309.995561	5250-5350	PASS
20	120	5310.003000	5250-5350	PASS
10	120	5309.978855	5250-5350	PASS
0	120	5309.978251	5250-5350	PASS
-10	120	5309.972859	5250-5350	PASS
-20	120	5309.994788	5250-5350	PASS

Environment Temperature (°C)	Volage (V)	Measured Frequency (MHz)	limit Range	Test Result
20	108	5309.999996	5250-5350	PASS
	120	5310.003000	5250-5350	PASS
	132	5309.973812	5250-5350	PASS



**IEEE 802.11n HT 40 MHz mode / 5510 ~ 5670MHz (Low)**

Environment Temperature (°C)	Volage (V)	Measured Frequency (MHz)	limit Range	Test Result
50	120	5509.994815	5475-5725	PASS
40	120	5509.998269	5475-5725	PASS
30	120	5509.963565	5475-5725	PASS
20	120	5510.002700	5475-5725	PASS
10	120	5509.981856	5475-5725	PASS
0	120	5509.981692	5475-5725	PASS
-10	120	5509.962581	5475-5725	PASS
-20	120	5509.995690	5475-5725	PASS

Environment Temperature (°C)	Volage (V)	Measured Frequency (MHz)	limit Range	Test Result
20	108	5509.966168	5475-5725	PASS
	120	5510.005000	5475-5725	PASS
	132	5509.990846	5475-5725	PASS

**IEEE 802.11n HT 40 MHz mode / 5510 ~ 5670MHz (High)**

Environment Temperature (°C)	Volage (V)	Measured Frequency (MHz)	limit Range	Test Result
50	120	5669.953411	5475-5725	PASS
40	120	5669.958710	5475-5725	PASS
30	120	5669.980384	5475-5725	PASS
20	120	5670.008000	5475-5725	PASS
10	120	5669.997426	5475-5725	PASS
0	120	5669.958955	5475-5725	PASS
-10	120	5669.963343	5475-5725	PASS
-20	120	5669.963177	5475-5725	PASS

Environment Temperature (°C)	Volage (V)	Measured Frequency (MHz)	limit Range	Test Result
20	108	5669.966898	5475-5725	PASS
	120	5670.006000	5475-5725	PASS
	132	5669.976503	5475-5725	PASS



**IEEE 802.11n HT 40 MHz mode / 5755 ~ 5795MHz (Low)**

Environment Temperature (°C)	Volage (V)	Measured Frequency (MHz)	limit Range	Test Result
50	120	5754.959959	5725-5850	PASS
40	120	5754.985557	5725-5850	PASS
30	120	5754.966258	5725-5850	PASS
20	120	5754.996460	5725-5850	PASS
10	120	5754.987697	5725-5850	PASS
0	120	5754.956755	5725-5850	PASS
-10	120	5754.957867	5725-5850	PASS
-20	120	5754.957660	5725-5850	PASS

Environment Temperature (°C)	Volage (V)	Measured Frequency (MHz)	limit Range	Test Result
20	108	5754.954281	5725-5850	PASS
	120	5754.997620	5725-5850	PASS
	132	5754.952651	5725-5850	PASS

**IEEE 802.11n HT 40 MHz mode / 5755 ~ 5795MHz (High)**

Environment Temperature (°C)	Volage (V)	Measured Frequency (MHz)	limit Range	Test Result
50	120	5794.973809	5725-5850	PASS
40	120	5794.975175	5725-5850	PASS
30	120	5794.956192	5725-5850	PASS
20	120	5794.992900	5725-5850	PASS
10	120	5794.985767	5725-5850	PASS
0	120	5794.961918	5725-5850	PASS
-10	120	5794.987434	5725-5850	PASS
-20	120	5794.953645	5725-5850	PASS

Environment Temperature (°C)	Volage (V)	Measured Frequency (MHz)	limit Range	Test Result
20	108	5794.953093	5725-5850	PASS
	120	5794.997350	5725-5850	PASS
	132	5794.983557	5725-5850	PASS



Antenna 0

IEEE 802.11ac 80 mode / 5210MHz

Environment Temperature (°C)	Volage (V)	Measured Frequency (MHz)	limit Range	Test Result
50	120	5209.963721	5150-5250	PASS
40	120	5209.981164	5150-5250	PASS
30	120	5209.974117	5150-5250	PASS
20	120	5209.993700	5150-5250	PASS
10	120	5209.967970	5150-5250	PASS
0	120	5209.967356	5150-5250	PASS
-10	120	5209.978562	5150-5250	PASS
-20	120	5209.994342	5150-5250	PASS

Environment Temperature (°C)	Volage (V)	Measured Frequency (MHz)	limit Range	Test Result
20	108	5209.999060	5150-5250	PASS
	120	5209.992200	5150-5250	PASS
	132	5209.962918	5150-5250	PASS

IEEE 802.11ac 80 mode / 5290MHz

Environment Temperature (°C)	Volage (V)	Measured Frequency (MHz)	limit Range	Test Result
50	120	5289.966354	5250-5350	PASS
40	120	5289.973172	5250-5350	PASS
30	120	5289.995670	5250-5350	PASS
20	120	5289.994100	5250-5350	PASS
10	120	5289.978435	5250-5350	PASS
0	120	5289.963862	5250-5350	PASS
-10	120	5289.971614	5250-5350	PASS
-20	120	5289.975859	5250-5350	PASS

Environment Temperature (°C)	Volage (V)	Measured Frequency (MHz)	limit Range	Test Result
20	108	5289.997741	5250-5350	PASS
	120	5289.987000	5250-5350	PASS
	132	5289.965313	5250-5350	PASS



**IEEE 802.11ac 80 mode / 5530MHz (Low)**

Environment Temperature (°C)	Volage (V)	Measured Frequency (MHz)	limit Range	Test Result
50	120	5529.987726	5475-5725	PASS
40	120	5529.996237	5475-5725	PASS
30	120	5529.984132	5475-5725	PASS
20	120	5529.993500	5475-5725	PASS
10	120	5529.982748	5475-5725	PASS
0	120	5529.997239	5475-5725	PASS
-10	120	5529.998379	5475-5725	PASS
-20	120	5529.959462	5475-5725	PASS

Environment Temperature (°C)	Volage (V)	Measured Frequency (MHz)	limit Range	Test Result
20	108	5529.964996	5475-5725	PASS
	120	5529.994630	5475-5725	PASS
	132	5529.968051	5475-5725	PASS

**IEEE 802.11ac 80 mode / 5775MHz**

Environment Temperature (°C)	Volage (V)	Measured Frequency (MHz)	limit Range	Test Result
50	120	5774.986491	5725-5850	PASS
40	120	5774.977796	5725-5850	PASS
30	120	5774.956254	5725-5850	PASS
20	120	5774.991500	5725-5850	PASS
10	120	5774.972854	5725-5850	PASS
0	120	5774.997004	5725-5850	PASS
-10	120	5774.991675	5725-5850	PASS
-20	120	5774.976128	5725-5850	PASS

Environment Temperature (°C)	Volage (V)	Measured Frequency (MHz)	limit Range	Test Result
20	108	5774.993295	5725-5850	PASS
	120	5774.997430	5725-5850	PASS
	132	5774.952643	5725-5850	PASS





Antenna 1

IEEE 802.11ac 80 mode / 5210MHz

Environment Temperature (°C)	Volage (V)	Measured Frequency (MHz)	limit Range	Test Result
50	120	5209.964215	5150-5250	PASS
40	120	5209.960965	5150-5250	PASS
30	120	5209.991922	5150-5250	PASS
20	120	5209.993800	5150-5250	PASS
10	120	5209.964573	5150-5250	PASS
0	120	5209.998817	5150-5250	PASS
-10	120	5209.956533	5150-5250	PASS
-20	120	5209.950618	5150-5250	PASS

Environment Temperature (°C)	Volage (V)	Measured Frequency (MHz)	limit Range	Test Result
20	108	5209.967724	5150-5250	PASS
	120	5209.994200	5150-5250	PASS
	132	5209.974667	5150-5250	PASS

IEEE 802.11ac 80 mode / 5290MHz

Environment Temperature (°C)	Volage (V)	Measured Frequency (MHz)	limit Range	Test Result
50	120	5289.990974	5250-5350	PASS
40	120	5289.999402	5250-5350	PASS
30	120	5289.981419	5250-5350	PASS
20	120	5290.003000	5250-5350	PASS
10	120	5289.978819	5250-5350	PASS
0	120	5289.989223	5250-5350	PASS
-10	120	5289.998939	5250-5350	PASS
-20	120	5289.983693	5250-5350	PASS

Environment Temperature (°C)	Volage (V)	Measured Frequency (MHz)	limit Range	Test Result
20	108	5289.990954	5250-5350	PASS
	120	5290.003000	5250-5350	PASS
	132	5289.999157	5250-5350	PASS



**IEEE 802.11ac 80 mode / 5530MHz (Low)**

Environment Temperature (°C)	Volage (V)	Measured Frequency (MHz)	limit Range	Test Result
50	120	5529.979018	5475-5725	PASS
40	120	5529.981703	5475-5725	PASS
30	120	5529.965160	5475-5725	PASS
20	120	5529.998100	5475-5725	PASS
10	120	5529.988417	5475-5725	PASS
0	120	5529.955508	5475-5725	PASS
-10	120	5529.960422	5475-5725	PASS
-20	120	5529.961322	5475-5725	PASS

Environment Temperature (°C)	Volage (V)	Measured Frequency (MHz)	limit Range	Test Result
20	108	5529.954074	5475-5725	PASS
	120	5529.992700	5475-5725	PASS
	132	5529.953563	5475-5725	PASS

**IEEE 802.11ac 80 mode / 5775MHz**

Environment Temperature (°C)	Volage (V)	Measured Frequency (MHz)	limit Range	Test Result
50	120	5774.993996	5725-5850	PASS
40	120	5774.954651	5725-5850	PASS
30	120	5774.997865	5725-5850	PASS
20	120	5774.995200	5725-5850	PASS
10	120	5774.989213	5725-5850	PASS
0	120	5774.989727	5725-5850	PASS
-10	120	5774.977880	5725-5850	PASS
-20	120	5774.982670	5725-5850	PASS

Environment Temperature (°C)	Volage (V)	Measured Frequency (MHz)	limit Range	Test Result
20	108	5774.949014	5725-5850	PASS
	120	5774.998000	5725-5850	PASS
	132	5774.998673	5725-5850	PASS



Antenna 2

IEEE 802.11ac 80 mode / 5210MHz

Environment Temperature (°C)	Volage (V)	Measured Frequency (MHz)	limit Range	Test Result
50	120	5209.999291	5150-5250	PASS
40	120	5209.968281	5150-5250	PASS
30	120	5209.970258	5150-5250	PASS
20	120	5209.993800	5150-5250	PASS
10	120	5209.991249	5150-5250	PASS
0	120	5209.964298	5150-5250	PASS
-10	120	5209.977648	5150-5250	PASS
-20	120	5209.971057	5150-5250	PASS

Environment Temperature (°C)	Volage (V)	Measured Frequency (MHz)	limit Range	Test Result
20	108	5209.988283	5150-5250	PASS
	120	5209.994900	5150-5250	PASS
	132	5209.972511	5150-5250	PASS

IEEE 802.11ac 80 mode / 5290MHz

Environment Temperature (°C)	Volage (V)	Measured Frequency (MHz)	limit Range	Test Result
50	120	5289.996816	5250-5350	PASS
40	120	5289.968132	5250-5350	PASS
30	120	5289.985248	5250-5350	PASS
20	120	5289.992700	5250-5350	PASS
10	120	5289.991287	5250-5350	PASS
0	120	5289.979848	5250-5350	PASS
-10	120	5289.968269	5250-5350	PASS
-20	120	5289.950358	5250-5350	PASS

Environment Temperature (°C)	Volage (V)	Measured Frequency (MHz)	limit Range	Test Result
20	108	5289.990657	5250-5350	PASS
	120	5289.993800	5250-5350	PASS
	132	5289.950823	5250-5350	PASS



**IEEE 802.11ac 80 mode / 5530MHz (Low)**

Environment Temperature (°C)	Volage (V)	Measured Frequency (MHz)	limit Range	Test Result
50	120	5529.975312	5475-5725	PASS
40	120	5529.971480	5475-5725	PASS
30	120	5529.956460	5475-5725	PASS
20	120	5529.992800	5475-5725	PASS
10	120	5529.992519	5475-5725	PASS
0	120	5529.950317	5475-5725	PASS
-10	120	5529.978348	5475-5725	PASS
-20	120	5529.956799	5475-5725	PASS

Environment Temperature (°C)	Volage (V)	Measured Frequency (MHz)	limit Range	Test Result
20	108	5529.957070	5475-5725	PASS
	120	5529.992900	5475-5725	PASS
	132	5529.998206	5475-5725	PASS

**IEEE 802.11ac 80 mode / 5775MHz**

Environment Temperature (°C)	Volage (V)	Measured Frequency (MHz)	limit Range	Test Result
50	120	5774.952318	5725-5850	PASS
40	120	5774.964800	5725-5850	PASS
30	120	5774.998289	5725-5850	PASS
20	120	5774.998520	5725-5850	PASS
10	120	5774.996537	5725-5850	PASS
0	120	5774.949286	5725-5850	PASS
-10	120	5774.974495	5725-5850	PASS
-20	120	5774.952995	5725-5850	PASS

Environment Temperature (°C)	Volage (V)	Measured Frequency (MHz)	limit Range	Test Result
20	108	5774.987995	5725-5850	PASS
	120	5774.992800	5725-5850	PASS
	132	5774.957683	5725-5850	PASS



Antenna 3

IEEE 802.11ac 80 mode / 5210MHz

Environment Temperature (°C)	Volage (V)	Measured Frequency (MHz)	limit Range	Test Result
50	120	5209.954514	5150-5250	PASS
40	120	5209.950481	5150-5250	PASS
30	120	5209.976463	5150-5250	PASS
20	120	5209.993800	5150-5250	PASS
10	120	5209.982616	5150-5250	PASS
0	120	5209.994159	5150-5250	PASS
-10	120	5209.986300	5150-5250	PASS
-20	120	5209.984084	5150-5250	PASS

Environment Temperature (°C)	Volage (V)	Measured Frequency (MHz)	limit Range	Test Result
20	108	5209.976543	5150-5250	PASS
	120	5209.994200	5150-5250	PASS
	132	5209.997855	5150-5250	PASS

IEEE 802.11ac 80 mode / 5290MHz

Environment Temperature (°C)	Volage (V)	Measured Frequency (MHz)	limit Range	Test Result
50	120	5289.986762	5250-5350	PASS
40	120	5289.989492	5250-5350	PASS
30	120	5289.956195	5250-5350	PASS
20	120	5289.995800	5250-5350	PASS
10	120	5289.974644	5250-5350	PASS
0	120	5289.999690	5250-5350	PASS
-10	120	5289.963655	5250-5350	PASS
-20	120	5289.980059	5250-5350	PASS

Environment Temperature (°C)	Volage (V)	Measured Frequency (MHz)	limit Range	Test Result
20	108	5289.954570	5250-5350	PASS
	120	5289.992700	5250-5350	PASS
	132	5289.981016	5250-5350	PASS



IEEE 802.11ac 80 mode / 5530MHz (Low)

Environment Temperature (°C)	Volage (V)	Measured Frequency (MHz)	limit Range	Test Result
50	120	5529.954265	5475-5725	PASS
40	120	5529.975894	5475-5725	PASS
30	120	5529.988736	5475-5725	PASS
20	120	5529.994100	5475-5725	PASS
10	120	5529.949898	5475-5725	PASS
0	120	5529.954558	5475-5725	PASS
-10	120	5529.962730	5475-5725	PASS
-20	120	5529.951520	5475-5725	PASS

Environment Temperature (°C)	Volage (V)	Measured Frequency (MHz)	limit Range	Test Result
20	108	5529.974316	5475-5725	PASS
	120	5529.994370	5475-5725	PASS
	132	5529.982383	5475-5725	PASS

IEEE 802.11ac 80 mode / 5775MHz

Environment Temperature (°C)	Volage (V)	Measured Frequency (MHz)	limit Range	Test Result
50	120	5774.966539	5725-5850	PASS
40	120	5774.987419	5725-5850	PASS
30	120	5774.957233	5725-5850	PASS
20	120	5774.998710	5725-5850	PASS
10	120	5774.982360	5725-5850	PASS
0	120	5774.979730	5725-5850	PASS
-10	120	5774.975973	5725-5850	PASS
-20	120	5774.960578	5725-5850	PASS

Environment Temperature (°C)	Volage (V)	Measured Frequency (MHz)	limit Range	Test Result
20	108	5774.956724	5725-5850	PASS
	120	5774.997490	5725-5850	PASS
	132	5774.977589	5725-5850	PASS