



# FCC 47 CFR PART 15 SUBPART C

for

**POWERLINE WIFI EXTENDER**

**Model: PL62AC**

**Brand: SmartRG**

**Test Report Number:**

**C161114Z02-RP1-3**

**Issued Date: December 16, 2016**

Issued for

**SmartRG Inc.**

**501 SE Columbia Shores Boulevard, Suite 500 Vancouver, Washington  
98661 United States**

Issued by:

**Compliance Certification Services (Shenzhen) Inc.**

No.10-1 Mingkeda Logistics park, No.18, Huanguan South Rd.,  
Guan Lan Town, Baoan District, Shenzhen, China

TEL: 86-755-28055000

FAX: 86-755-28055221



中国认可  
国际互认  
检测  
TESTING  
CNAS L4818



**Note:** This report shall not be reproduced except in full, without the written approval of Compliance Certification Services (Shenzhen) Inc. This document may be altered or revised by Compliance Certification Services (Shenzhen) Inc. personnel only, and shall be noted in the revision section of the document. The client should not use it to claim product endorsement by TAF, A2LA, NVLAP, NIST or any government agencies. The test results in the report only apply to the tested sample.



Revision History

Rev.	Issue Date	Revisions	Effect Page	Revised By
00	December 16, 2016	Initial Issue	ALL	Sabrina Wang



**TABLE OF CONTENTS**

**1 TEST CERTIFICATION ..... 4**

**2 TEST RESULT SUMMARY ..... 5**

**3 EUT DESCRIPTION..... 6**

**4 TEST METHODOLOGY..... 7**

    4.1. DESCRIPTION OF TEST MODES ..... 7

**5 SETUP OF EQUIPMENT UNDER TEST ..... 8**

    5.1. DESCRIPTION OF SUPPORT UNITS..... 8

    5.2. CONFIGURATION OF SYSTEM UNDER TEST ..... 8

**6 FACILITIES AND ACCREDITATIONS ..... 9**

    6.1. FACILITIES ..... 9

    6.2. ACCREDITATIONS ..... 9

    6.3. MEASUREMENT UNCERTAINTY..... 9

**7 FCC PART 15.247 REQUIREMENTS ..... 10**

    7.1. POWER LINE CONDUCTED EMISSIONS MEASUREMENT ..... 10

    7.2. SPURIOUS EMISSIONS MEASUREMENT..... 15

    7.3. 6dB BANDWIDTH MEASUREMENT ..... 51

    7.4. ANTENNA GAIN ..... 61

    7.5. PEAK OUTPUT POWER ..... 62

    7.6. BAND EDGES MEASUREMENT..... 64

    7.7. PEAK POWER SPECTRAL DENSITY MEASUREMENT..... 66



# 1 TEST CERTIFICATION

<b>Product</b>	POWERLINE WIFI EXTENDER
<b>Model</b>	PL62AC
<b>Brand</b>	SmartRG
<b>Tested</b>	November 14~December 15, 2016
<b>Applicant</b>	<b>SmartRG Inc.</b> 501 SE Columbia Shores Boulevard, Suite 500 Vancouver, Washington 98661 United States
<b>Manufacturer</b>	<b>SmartRG Inc.</b> 501 SE Columbia Shores Boulevard, Suite 500 Vancouver, Washington 98661 United States

APPLICABLE STANDARDS			
Standard	Test Type	Standard	Test Type
15.207(a)	Power Line Conducted Emissions	15.247(d) 15.209(a)	<ul style="list-style-type: none"> <li>● Spurious Emissions</li> <li>● Conducted Measurement</li> <li>● Radiated Emissions</li> </ul>
15.247(a)(2)	6dB Bandwidth Measurement	15.247(b)(3) 15.247(b)(4)	Peak Power Measurement
15.247(d)	Band Edges Measurement	15.247(e)	Peak Power Spectral Density

### We hereby certify that:

The above equipment was tested by Compliance Certification Services (Shenzhen) Inc. The test data, data evaluation, test procedures, and equipment configurations shown in this report were made in accordance with the procedures given in **ANSI C63.10: 2013** and the energy emitted by the sample EUT tested as described in this report is in compliance with the requirements of FCC Rules Part 15.207, 15.209, 15.247.

The test results of this report relate only to the tested sample EUT identified in this report.

**Approved by:**

**Reviewed by:**

---

**Sunday Hu**  
Supervisor of EMC Dept.  
Compliance Certification Services (Shenzhen) Inc.

---

**Ruby Zhang**  
Supervisor of Report Dept.  
Compliance Certification Services (Shenzhen) Inc.



## 2 TEST RESULT SUMMARY

APPLICABLE STANDARDS			
Standard	Test Type	Result	Remark
15.247(a)(2)	6dB Bandwidth Measurement	Pass	Meet the requirement of limit.
15.247(b)(3) 15.247(b)(4)	Peak Power Measurement	Pass	Meet the requirement of limit.
15.247(d)	Band Edges Measurement	Pass	Meet the requirement of limit.
15.247(e)	Peak Power Spectral Density	Pass	Meet the requirement of limit.
15.247(d) 15.209(a)	<ul style="list-style-type: none"><li>● Spurious Emissions</li><li>● Conducted Measurement</li><li>● Radiated Emissions</li></ul>	Pass	Meet the requirement of limit.
15.207(a)	Power line Conducted Emissions	Pass	Meet the requirement of limit.

Note: 1. The statements of test result on the above are decided by the request of test standard only; the measurement uncertainties are not factored into this compliance determination.  
2. The information of measurement uncertainty is available upon the customer's request.



### 3 EUT DESCRIPTION

<b>Product</b>	POWERLINE WIFI EXTENDER
<b>Model Number</b>	PL62AC
<b>Brand</b>	SmartRG
<b>Model Discrepancy</b>	N/A
<b>Identify Number</b>	C161114Z02-RP1-1
<b>Received Date</b>	November 14, 2016
<b>Power Supply</b>	AC100-240V, 50/60Hz, 0.5A
<b>Transmit Power</b>	IEEE 802.11b mode: 20.64dBm IEEE 802.11g mode: 25.64dBm IEEE 802.11n HT20 MHz mode: 24.57dBm IEEE 802.11n HT40 MHz mode: 23.89dBm
<b>Modulation Technique</b>	IEEE 802.11b mode: DSSS(CCK,QPSK, BPSK) IEEE 802.11g mode: OFDM (BPSK/QPSK/16QAM/64QAM) IEEE 802.11n HT20 MHz mode: OFDM (BPSK/QPSK/16QAM/64QAM) IEEE 802.11n HT40 MHz mode: OFDM (BPSK/QPSK/16QAM/64QAM)
<b>Transmit Data Rate</b>	IEEE 802.11b: 11Mbps(CCK) with fall back rates of 5.5/2/1Mbps IEEE 802.11g: 54Mbps with fall back rates of 48/36/24/18/12/9 /6Mbps IEEE 802.11n HT20: 65Mbps with fall back rates of 65.0/58.5/52.0/ 39.0/26.0/19.5/13.0/6.5Mbps IEEE 802.11n HT40:135Mbps with fall back rates of 135/121.5/108/ 81/54/40.5/27/13.5Mbps
<b>Number of Channels</b>	IEEE 802.11b mode: 11 Channels IEEE 802.11g mode: 11 Channels IEEE 802.11n HT20 MHz mode: 11 Channels IEEE 802.11n HT40 MHz mode: 7 Channels
<b>Antenna Specification</b>	Dipole Antenna with 2dBi gain (Max)
<b>Channels Spacing</b>	IEEE 802.11b/g ,802.11n HT20/HT40 : 5MHz
<b>Temperature Range</b>	0°C ~ +40°C
<b>Hardware Version</b>	A0
<b>Software Version</b>	1.0.0.2

- Note:** 1. The sample selected for test was engineering sample that approximated to production product and was provided by manufacturer.
2. This submittal(s) (test report) is intended for FCC ID: VW7PL62 filing to comply with Section 15.207, 15.209 and 15.247 of the FCC Part 15, Subpart C Rules.



## 4 TEST METHODOLOGY

### 4.1. DESCRIPTION OF TEST MODES

The EUT has been tested under operating condition.

Software used to control the EUT for staying in continuous transmitting and receiving mode is programmed.

Test Item	Test mode	Worse mode
Conducted Emission	<b>Mode 1: RJ45 1000Mbps 10%</b>	<b>Mode 1</b>
Radiated Emission	<b>Mode 1: TX</b>	<b>Mode 1</b>

After verification, all tests were carried out with the worst case test modes as shown below except radiated spurious emission below 1GHz, which worst case was in normal link mode only, and power line conducted emission below 30MHz, which worst case was in normal link mode.

IEEE802.11b mode: Channel Low (2412MHz), Channel Mid (2437MHz) and Channel High (2462MHz) with 1Mbps data rate were chosen for full testing.

IEEE802.11g mode: Channel Low (2412MHz), Channel Mid (2437MHz) and Channel High (2462MHz) with 6Mbps data rate were chosen for full testing.

IEEE 802.11n HT20 MHz mode: Channel Low (2412MHz), Channel Mid(2437MHz) and Channel High (2462MHz) with 6.5Mbps data rate were chosen for full testing.

IEEE 802.11n HT40 MHz mode: Channel Low (2422MHz), Channel Mid(2437MHz) and Channel High (2452MHz) with 13.5Mbps data rate were chosen for full testing.



## 5 SETUP OF EQUIPMENT UNDER TEST

### 5.1. DESCRIPTION OF SUPPORT UNITS

The EUT has been tested as an independent unit together with other necessary accessories or support units. The following support units or accessories were used to form a representative test configuration during the tests.

No.	Equipment	Model No.	Serial No.	FCC ID	Brand	Data Cable	Power Cord
1	Notebook	Probook 5310M	N/A	DoC	HP	Unshielded 1.80m	Shielded 1.80m (AC cable) Unshielded 1.70m (DC cable)

**Note:**

Grounding was established in accordance with the manufacturer's requirements and conditions for the intended use.

### 5.2. CONFIGURATION OF SYSTEM UNDER TEST

See test photographs attached in Appendix II for the actual connections between EUT and support equipment.





## 6 FACILITIES AND ACCREDITATIONS

### 6.1. FACILITIES

All measurement facilities used to collect the measurement data are located at **No.10-1 Mingkeda Logistics park, No.18, Huanguan South Rd., Guan Lan Town, Baoan District, Shenzhen, China**

The sites are constructed in conformance with the requirements of ANSI C63.10, ANSI C63.7 and CISPR Publication 22. All receiving equipment conforms to CISPR Publication 16-1, "Radio Interference Measuring Apparatus and Measurement Methods."

### 6.2. ACCREDITATIONS

Our laboratories are accredited and approved by the following accreditation body according to ISO/IEC 17025.

<b>USA</b>	<b>A2LA</b>
<b>China</b>	<b>CNAS</b>

The measuring facility of laboratories has been authorized or registered by the following approval agencies.

<b>USA</b>	<b>FCC</b>
<b>Japan</b>	<b>VCCI (C-4815,R-4320,T-2317, G-10624)</b>
<b>Canada</b>	<b>INDUSTRY CANADA</b>

Copies of granted accreditation certificates are available for downloading from our web site, <http://www.ccssz.com>

### 6.3. MEASUREMENT UNCERTAINTY

Where relevant, the following measurement uncertainty levels have been estimated for tests performed on the EUT as specified in CISPR 16-4-2:

Parameter	Uncertainty
Radiated Emission, 30 to 200 MHz Test Site : 966(2)	+/-3.6880dB
Radiated Emission, 200 to 1000 MHz Test Site : 966(2)	+/-3.6695dB
Radiated Emission, 1 to 8 GHz	+/-5.1782dB
Radiated Emission, 8 to 18 GHz	+/-5.2173dB
Conducted Emissions	+/-3.6836dB
Band Width	178kHz
Peak Output Power MU	+/-1.906dB
Band Edge MU	+/-0.182dB
Channel Separation MU	416.178Hz
Duty Cycle MU	0.054ms
Frequency Stability MU	226Hz

This uncertainty represents an expanded uncertainty expressed at approximately the 95% confidence level using a coverage factor of k=2.

The measured result is above (below) the specification limit by a margin less than the measurement uncertainty; it is therefore not possible to state compliance based on the 95% level of confidence. However, the result indicates that compliance (non-compliance) is more probable than non-compliance) with the specification limit.



## 7 FCC PART 15.247 REQUIREMENTS

### 7.1. POWER LINE CONDUCTED EMISSIONS MEASUREMENT

#### 7.1.1. LIMITS OF CONDUCTED EMISSIONS MEASUREMENT

According to §15.207(a), except as shown in paragraphs (b) and (c) of this section, for an intentional radiator that is designed to be connected to the public utility (AC) power line, the radio frequency voltage that is conducted back onto the AC power line on any frequency or frequencies within the band 150 kHz to 30 MHz shall not exceed the limits in the following table, as measured using a 50  $\mu$ H/50 ohms line impedance stabilization network (LISN). Compliance with the provisions of this paragraph shall be based on the measurement of the radio frequency voltage between each power line and ground at the power terminal. The lower limit applies at the boundary between the frequency ranges.

Frequency Range (MHz)	Limits (dB $\mu$ V)	
	Quasi-peak	Average
0.15 to 0.50	66 to 56*	56 to 46*
0.50 to 5	56	46
5 to 30	60	50

**NOTE:**

- (1) The lower limit shall apply at the transition frequencies.
- (2) The limit decreases in line with the logarithm of the frequency in the range of 0.15 to 0.50 MHz.
- (3) All emanations from a class A/B digital device or system, including any network of conductors and apparatus connected thereto, shall not exceed the level of field strengths specified above.

#### 7.1.2. TEST INSTRUMENTS

Conducted Emission Test Site					
Name of Equipment	Manufacturer	Model Number	Serial Number	Last Calibration	Due Calibration
EMI TEST RECEIVER	ROHDE&SCHWARZ	ESCI	100783	02/21/2016	02/20/2017
LISN(EUT)	ROHDE&SCHWARZ	ENV216	101543-WX	02/21/2016	02/20/2017
LISN	EMCO	3825/2	8901-1459	02/21/2016	02/20/2017
Temp. / Humidity Meter	VICTOR	HTC-1	N/A	02/21/2016	02/20/2017
Test S/W	FARAD	EZ-EMC/ CCS-3A1-CE			

- NOTE:**
1. The calibration interval of the above test instruments is 12 months and the calibrations are traceable to NML/ROC and NIST/USA.
  2. N.C.R = No Calibration Request.



### 7.1.3. TEST PROCEDURES (please refer to measurement standard)

- The EUT and Support equipment, if needed, was placed on a non-conducted table, which is 0.8m above the ground plane and 0.4m away from the conducted wall.
- The test equipment EUT installed received AC main power, through a Line Impedance Stabilization Network (LISN), which supplied power source and was grounded to the ground plane. All support equipment power received from a second LISN. The two LISNs provide 50 ohm/ 50uH of coupling impedance for the measuring instrument.
- The EUT test program was started. Emissions were measured on each current carrying line of the EUT using an EMI Test Receiver connected to the LISN powering the EUT.
- The frequency range from 150 kHz to 30 MHz was searched. The test data of the worst-case condition(s) was recorded. Emission levels under limit 20dB were not recorded.



### 7.1.4. TEST SETUP

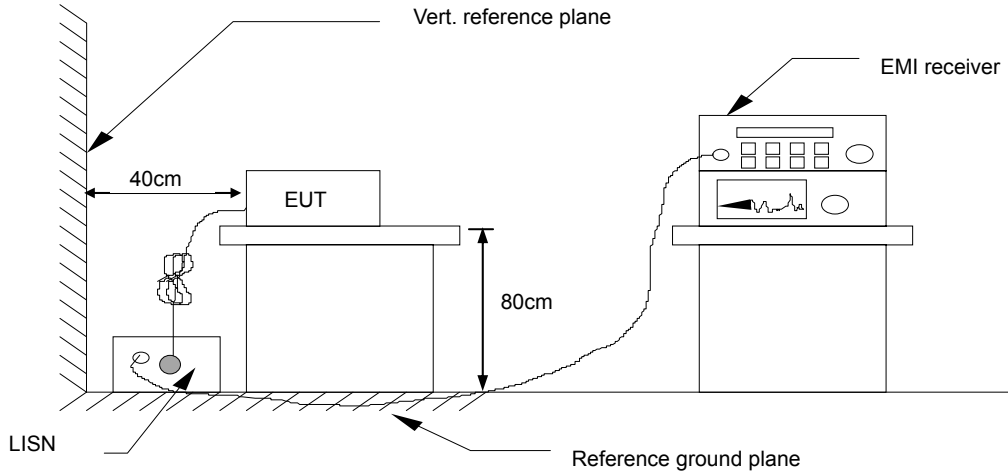

For the actual test configuration, please refer to the related item - Photographs of the Test Configuration.

### 7.1.5. DATA SAMPLE

Frequency (MHz)	QuasiPeak Reading (dBuV)	Average Reading (dBuV)	Correction Factor (dB)	QuasiPeak Result (dBuV)	Average Result (dBuV)	QuasiPeak Limit (dBuV)	Average Limit (dBuV)	QuasiPeak Margin (dB)	Average Margin (dB)	Remark (Pass/Fail)
X.XXXX	32.69	25.65	11.52	44.21	37.17	65.78	55.79	-21.57	-18.62	Pass

- Factor = Insertion loss of LISN + Cable Loss
- Result = Quasi-peak Reading/ Average Reading + Factor
- Limit = Limit stated in standard
- Margin = Result (dBuV) – Limit (dBuV)



7.1.6. TEST RESULTS

<b>Model No.</b>	PL62AC	<b>RBW,VBW</b>	9 kHz
<b>Environmental Conditions</b>	22°C, 45% RH	<b>Test Mode</b>	Mode 1
<b>Tested by</b>	Jackson Luo	<b>Line</b>	L1
<b>Test Date</b>	December 16, 2016		

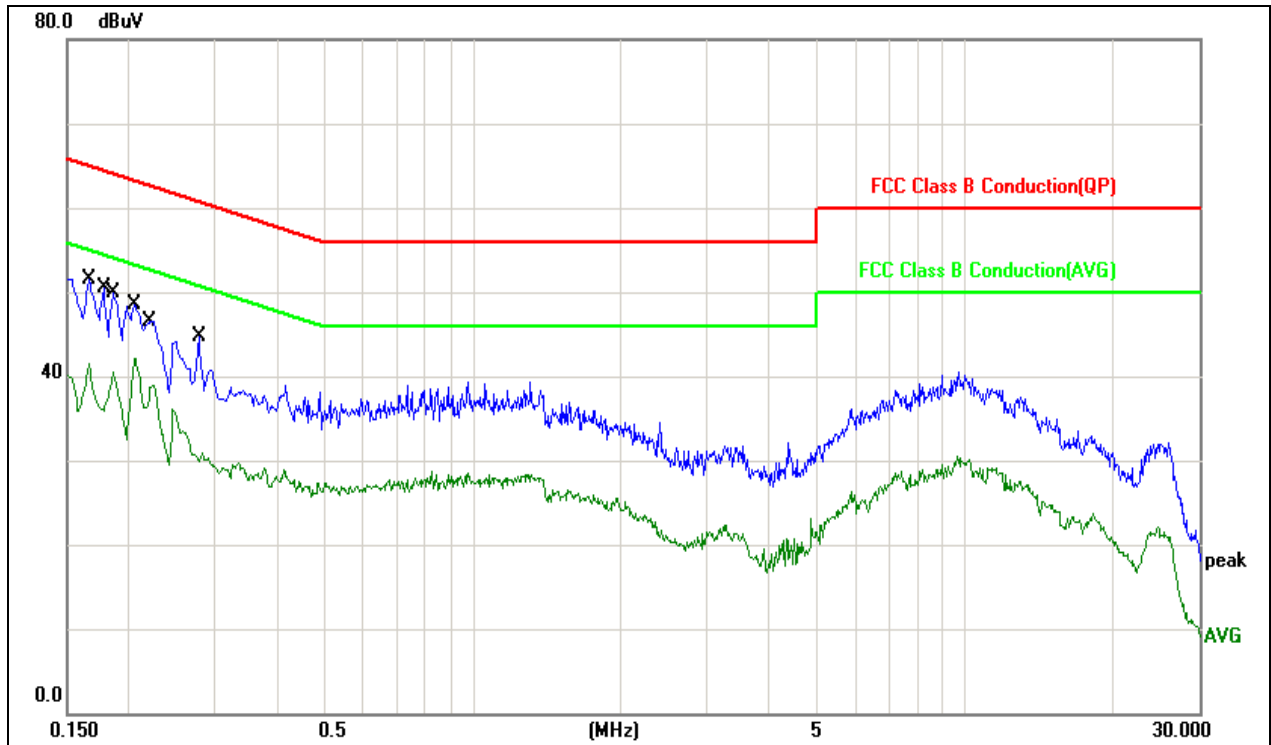

Frequency (MHz)	QuasiPeak Reading (dBuV)	Average Reading (dBuV)	Correction Factor (dB)	QuasiPeak Result (dBuV)	Average Result (dBuV)	QuasiPeak Limit (dBuV)	Average Limit (dBuV)	QuasiPeak Margin (dB)	Average Margin (dB)	Remark (Pass/Fail)
0.1660	33.57	24.41	10.06	43.63	34.47	65.15	55.15	-21.52	-20.68	Pass
0.1780	34.48	26.09	10.06	44.54	36.15	64.57	54.57	-20.03	-18.42	Pass
0.1860	34.06	26.99	10.06	44.12	37.05	64.21	54.21	-20.09	-17.16	Pass
0.2060	35.93	31.92	10.06	45.99	41.98	63.36	53.36	-17.37	-11.38	Pass
0.2220	33.32	28.42	10.05	43.37	38.47	62.74	52.74	-19.37	-14.27	Pass
0.2779	24.69	19.30	10.02	29.32	29.32	60.88	50.88	-26.17	-21.56	Pass

REMARKS: L1 = Line One (Live Line)



<b>Model No.</b>	PL62AC	<b>RBW,VBW</b>	9 kHz
<b>Environmental Conditions</b>	22°C, 45% RH	<b>Test Mode</b>	Mode 1
<b>Tested by</b>	Jackson Luo	<b>Line</b>	L2
<b>Test Date</b>	December 16, 2016		

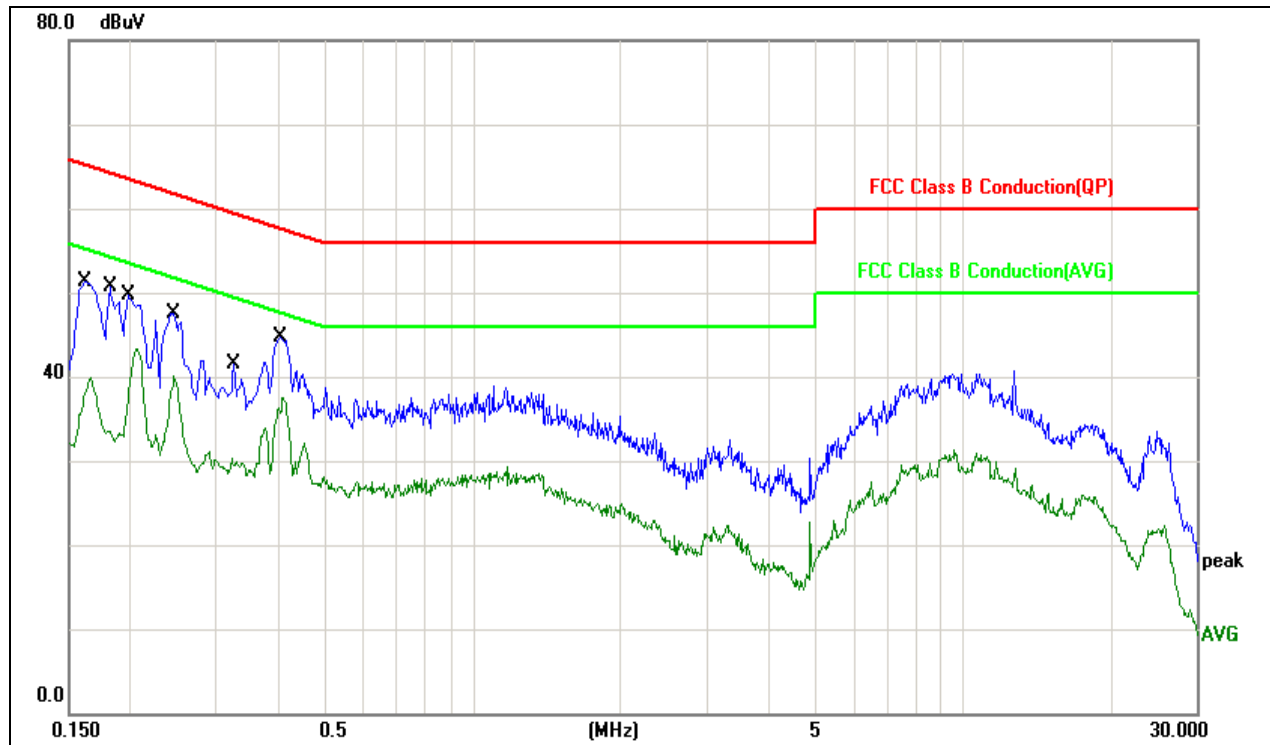

Frequency (MHz)	QuasiPeak Reading (dBuV)	Average Reading (dBuV)	Correction Factor (dB)	QuasiPeak Result (dBuV)	Average Result (dBuV)	QuasiPeak Limit (dBuV)	Average Limit (dBuV)	QuasiPeak Margin (dB)	Average Margin (dB)	Remark (Pass/Fail)
0.1620	31.37	23.24	10.06	41.43	33.30	65.36	55.36	-23.93	-22.06	Pass
0.1825	35.56	28.18	10.06	45.62	38.24	64.37	54.37	-18.75	-16.13	Pass
0.1980	34.73	26.08	10.06	44.79	36.14	63.69	53.69	-18.90	-17.55	Pass
0.2460	32.68	27.48	10.03	42.71	37.51	61.89	51.89	-19.18	-14.38	Pass
0.3260	25.16	19.58	9.99	35.15	29.57	59.55	49.55	-24.40	-19.98	Pass
0.4060	32.02	26.70	9.94	41.96	36.64	57.73	47.73	-15.77	-11.09	Pass

**REMARKS:** L2 = Line Two (Neutral Line)



## 7.2. SPURIOUS EMISSIONS MEASUREMENT

### 7.2.1. CONDUCTED EMISSIONS MEASUREMENT

#### 7.2.1.1. LIMITS OF CONDUCTED EMISSIONS MEASUREMENT

§15.247(d) specifies that in any 100 kHz bandwidth outside of the authorized frequency band, the power shall be attenuated according to the following conditions:

If the peak output power procedure is used to measure the fundamental emission power to demonstrate compliance to 15.247(b)(3) requirements, then the peak conducted output power measured within any 100 kHz outside the authorized frequency band shall be attenuated by at least 20 dB relative to the maximum measured in-band peak PSD level.

If the average output power procedure is used to measure the fundamental emission power to demonstrate compliance to 15.247(b) (3) requirements, then the power in any 100 kHz outside of the authorized frequency band shall be attenuated by at least 30 dB relative to the maximum measured in-band average PSD level.

In addition, radiated emissions which fall in the restricted bands, as defined in §15.205(a), must also comply with the radiated emission limits specified in 15.209(a) (see Section 15.205(c)).

#### 7.2.1.2. TEST INSTRUMENTS

Name of Equipment	Manufacturer	Model	Serial Number	Last Calibration	Due Calibration
Spectrum Analyzer	Agilent	N9010A	MY55370330	02/21/2016	02/20/2017

#### 7.2.1.3. TEST PROCEDURE (please refer to measurement standard)

Conducted RF measurements of the transmitter output were made to confirm that the EUT antenna port conducted emissions meet the specified limit and to identify any spurious signals that require further investigation or measurements on the radiated emissions site.

The transmitter output is connected to the spectrum analyzer. The resolution bandwidth is set to 100 kHz. The video bandwidth is set to 300 kHz.

Measurements are made over the 10MHz to 26GHz range with the transmitter set to the lowest, middle, and highest channels. No emission found between lowest internal used/generated frequency to 10MHz, it is only recorded 10MHz to 26GHz.



### 7.2.1.4. TEST RESULTS

#### Test Plot IEEE 802.11b mode

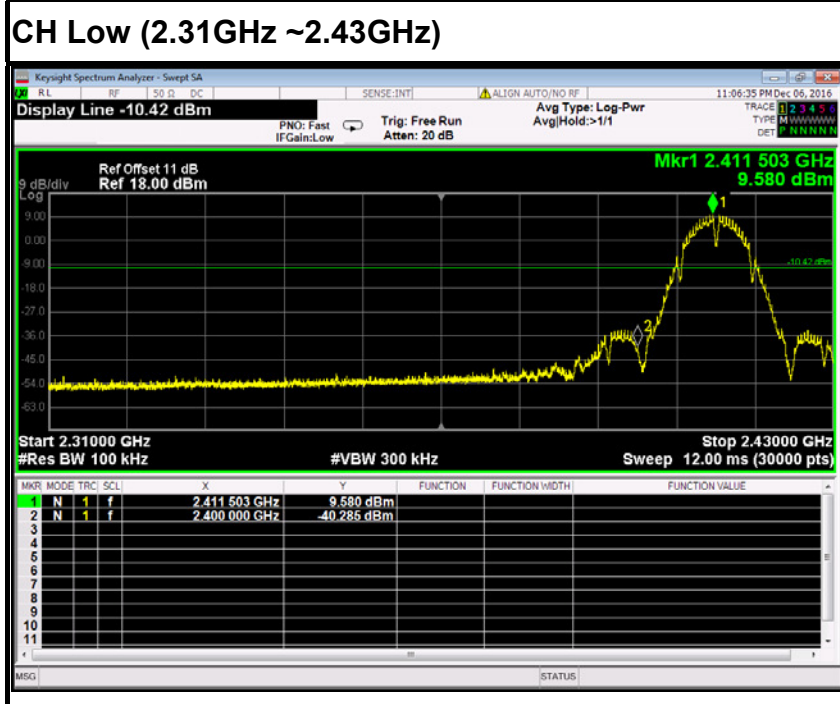
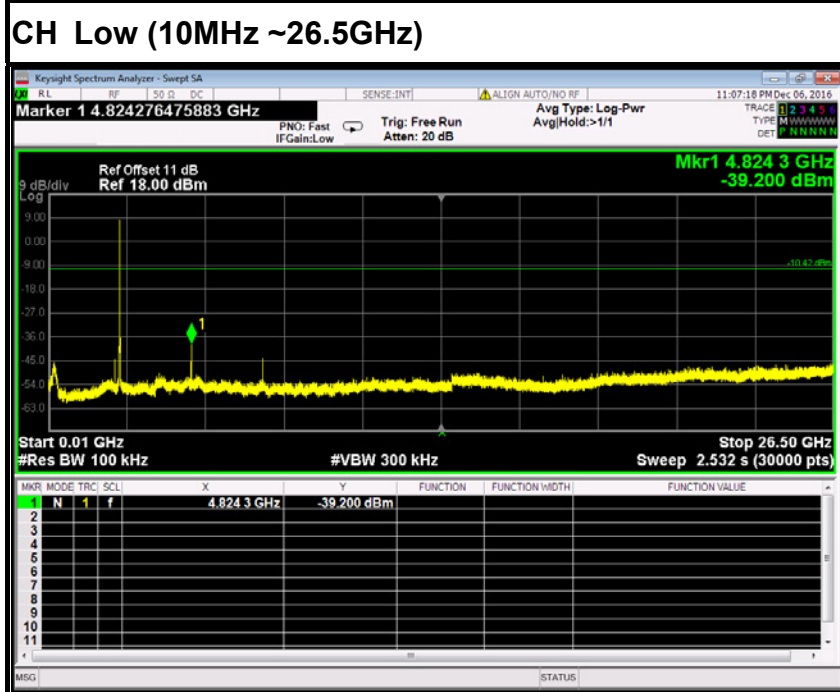



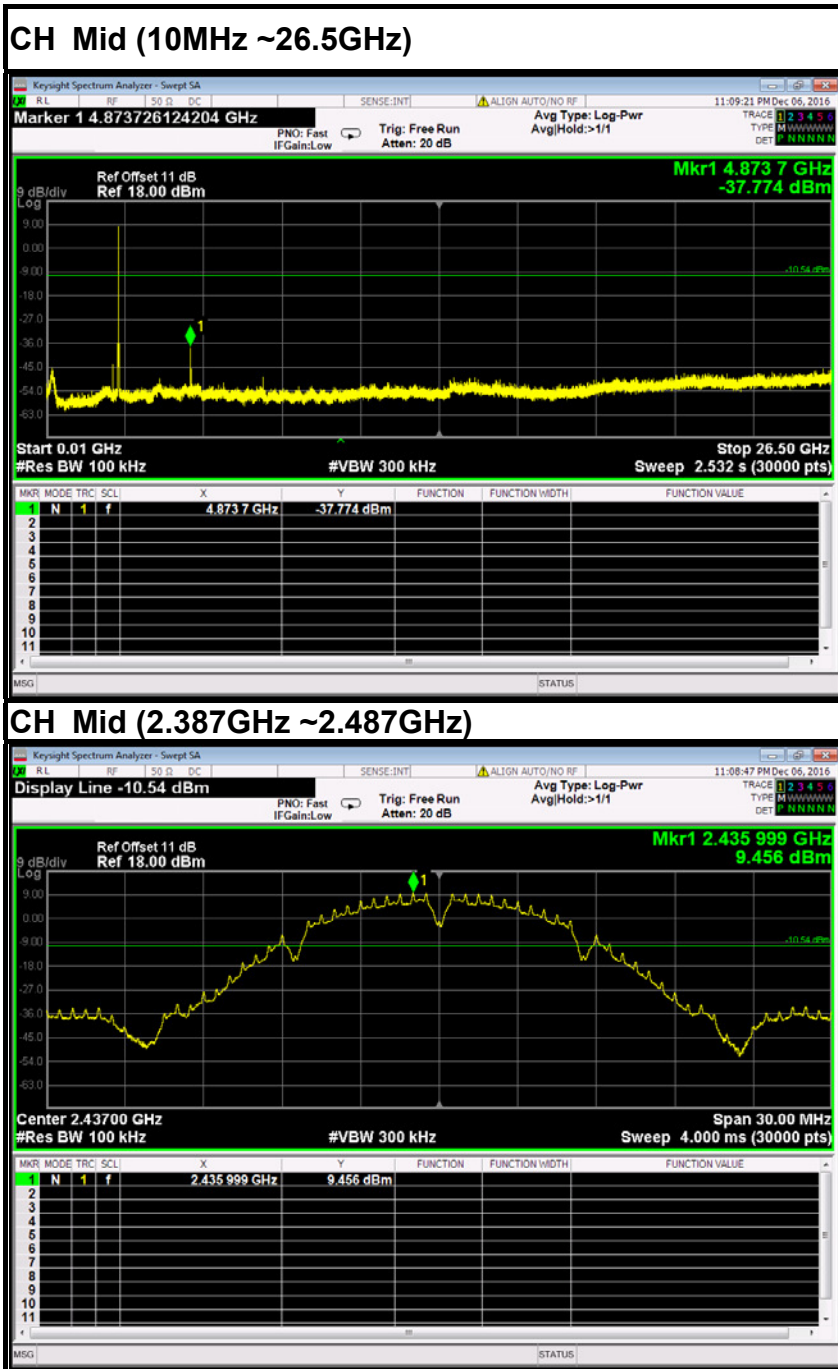



### CH High (10MHz ~26.5GHz)

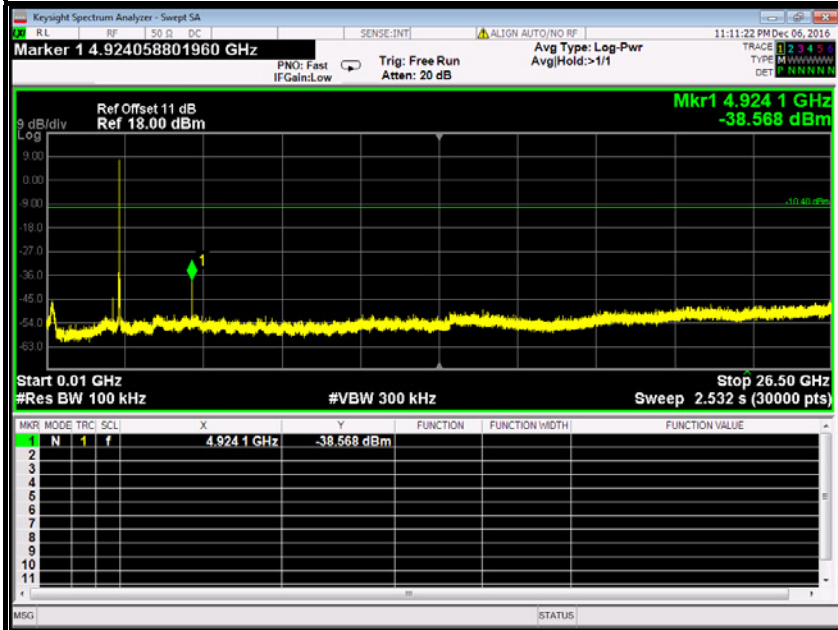

### CH High (2.45GHz ~2.5GHz)





IEEE 802.11g mode

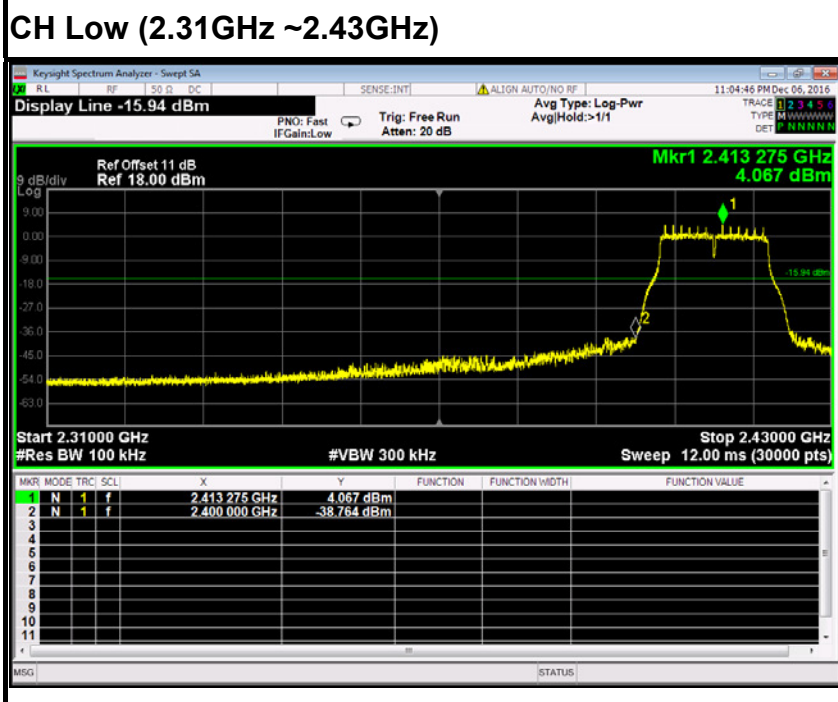
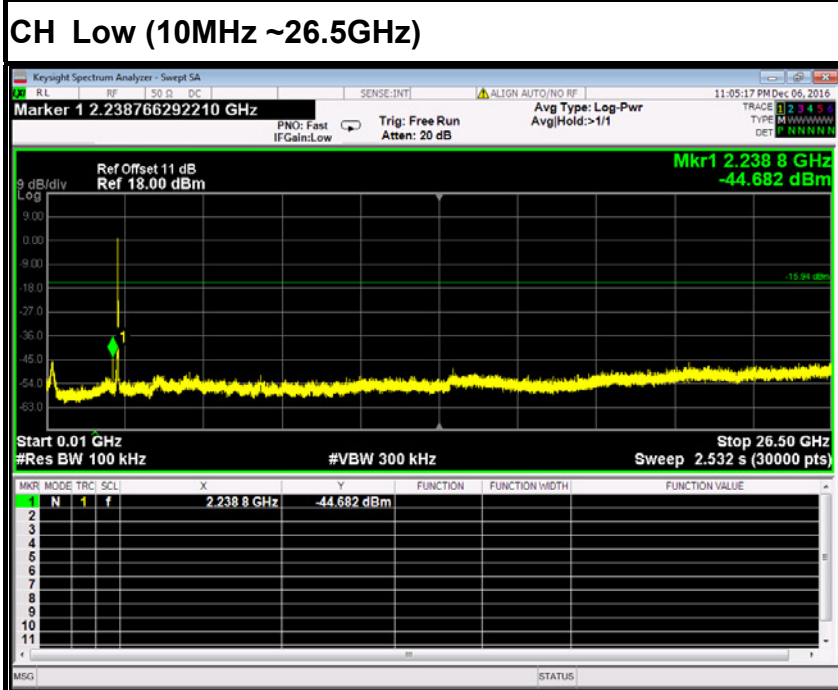



### CH Mid (10MHz ~26.5GHz)

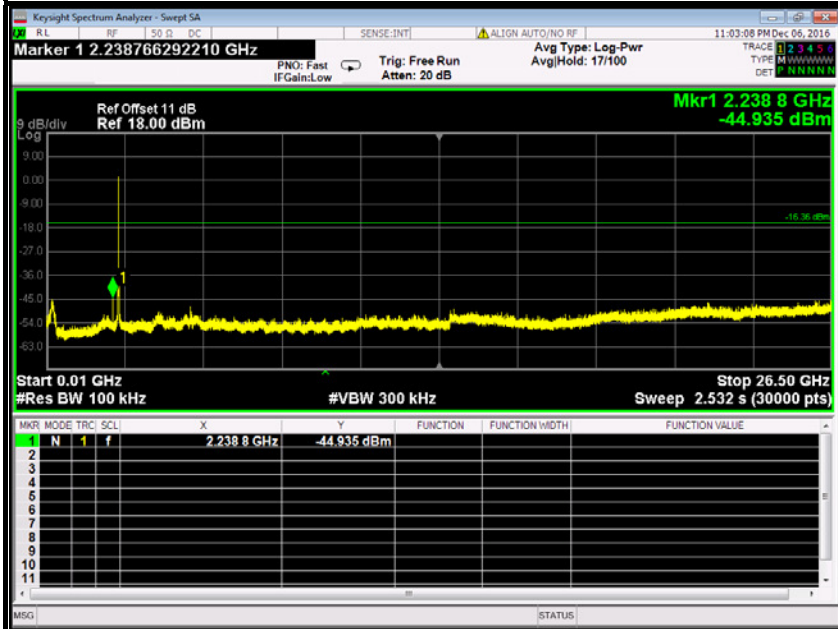

### CH Mid (2.387GHz ~2.487GHz)

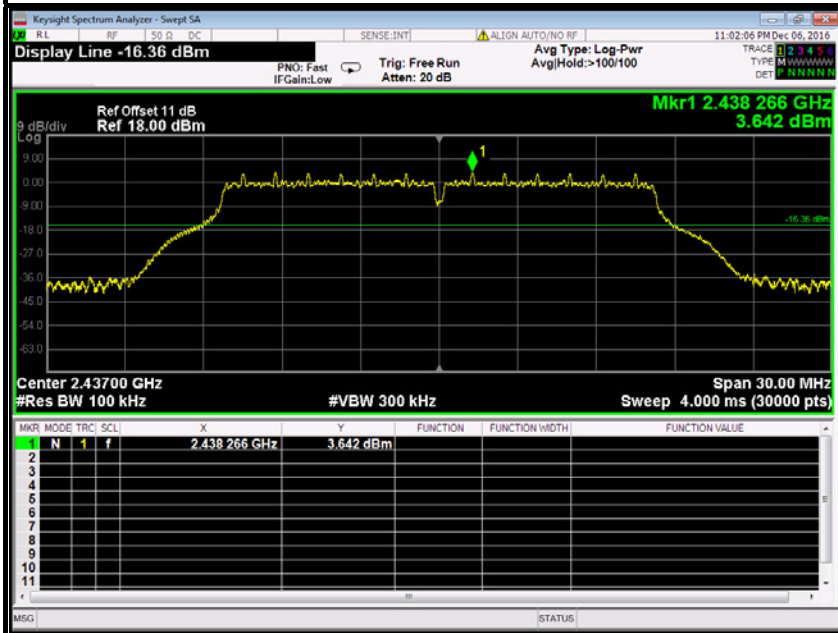

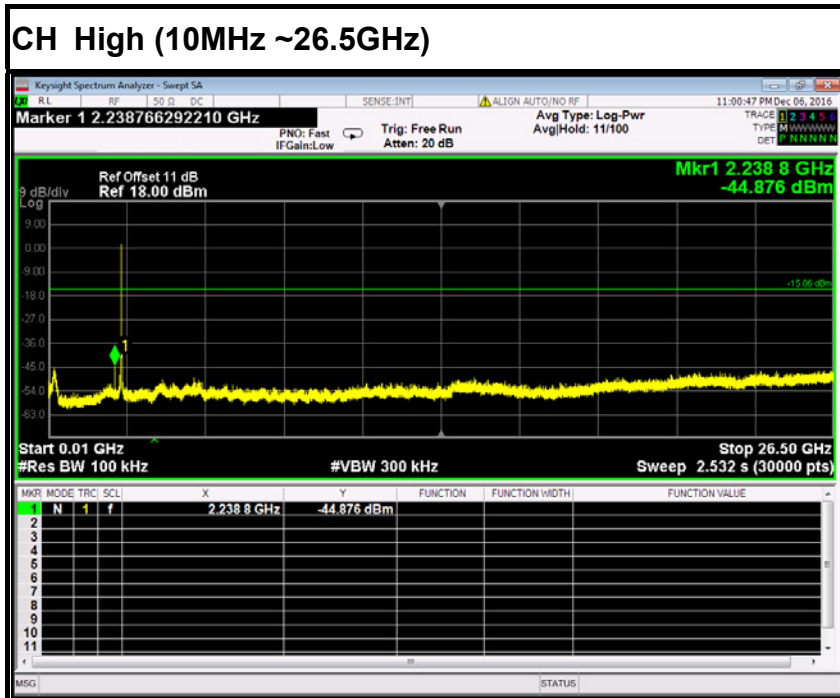



**IEEE 802.11n HT20 MHz mode**

**CH Low (10MHz ~26.5GHz)**

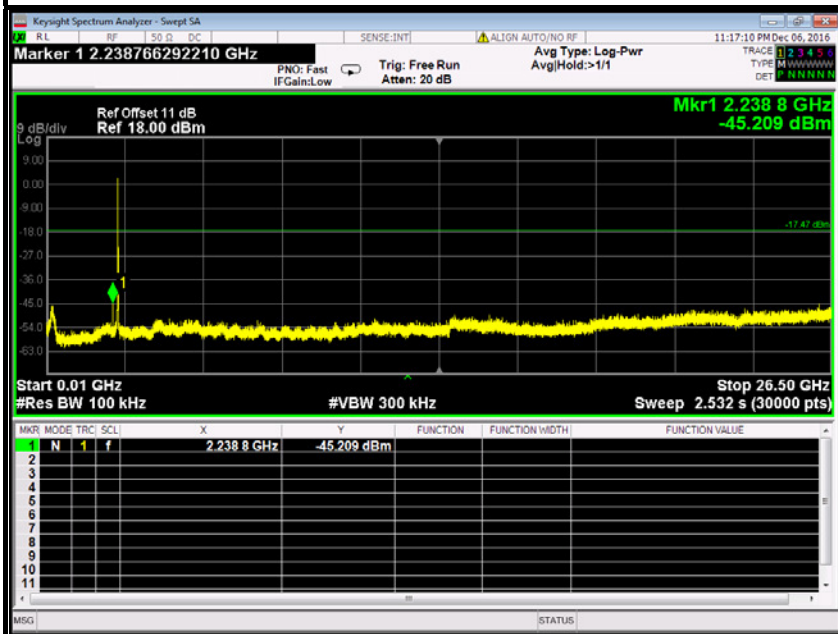

**CH Low (2.31GHz ~2.43GHz)**

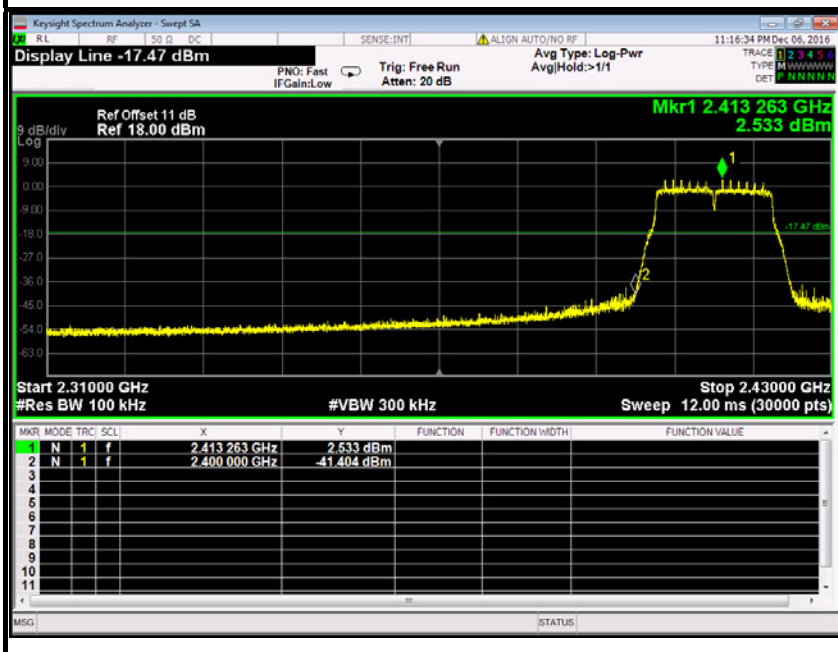





### CH High (10MHz ~26.5GHz)

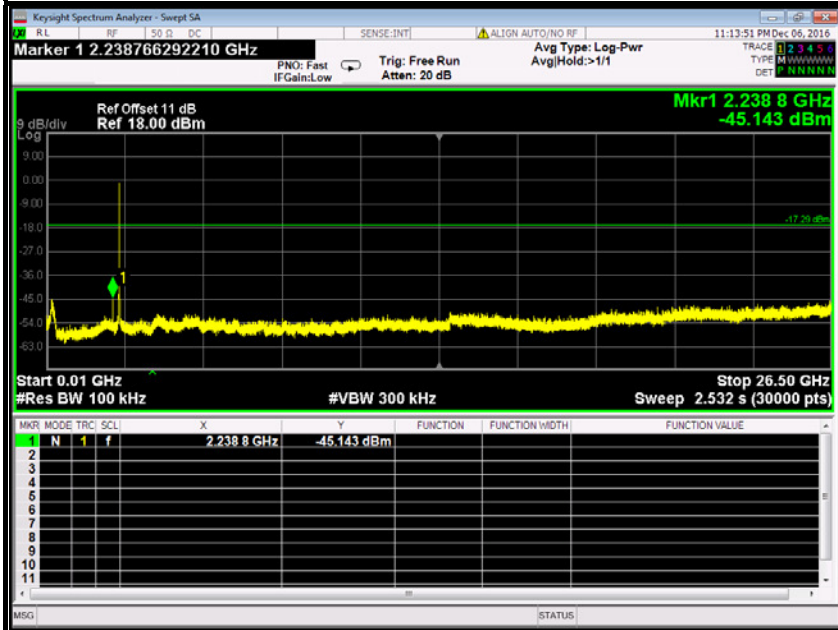

### CH High (2.45GHz ~2.5GHz)

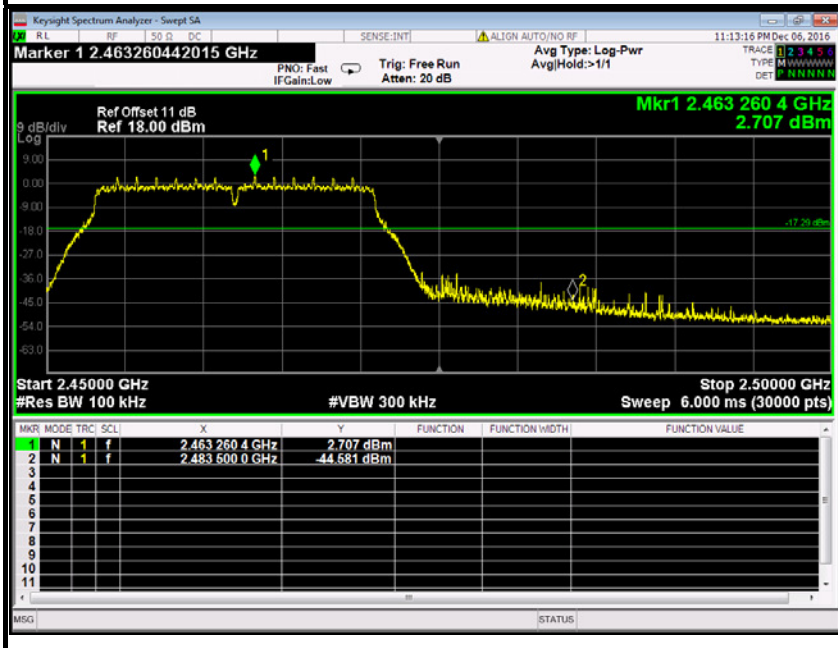





IEEE 802.11n HT40 MHz mode

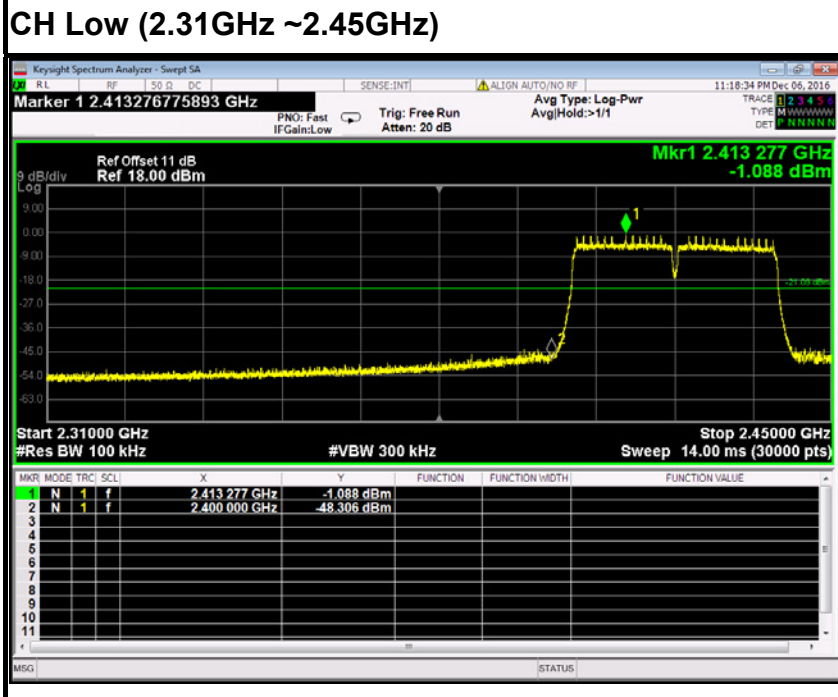
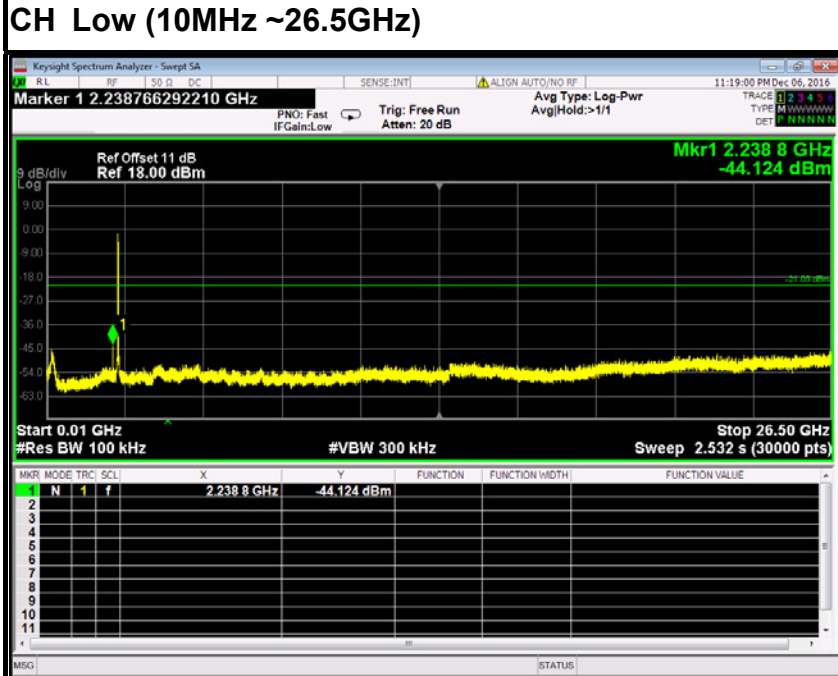

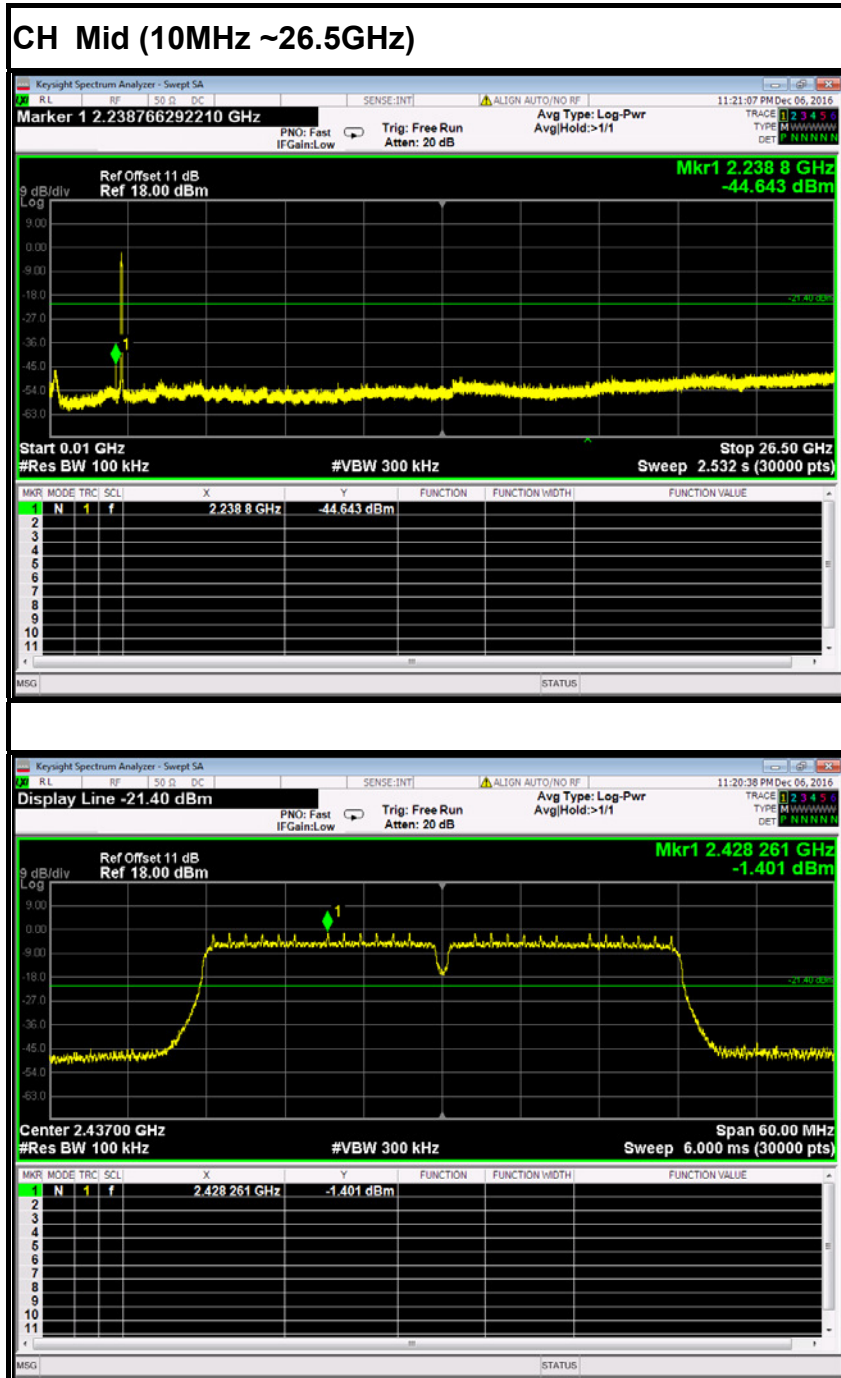



### CH High (10MHz ~26.5GHz)

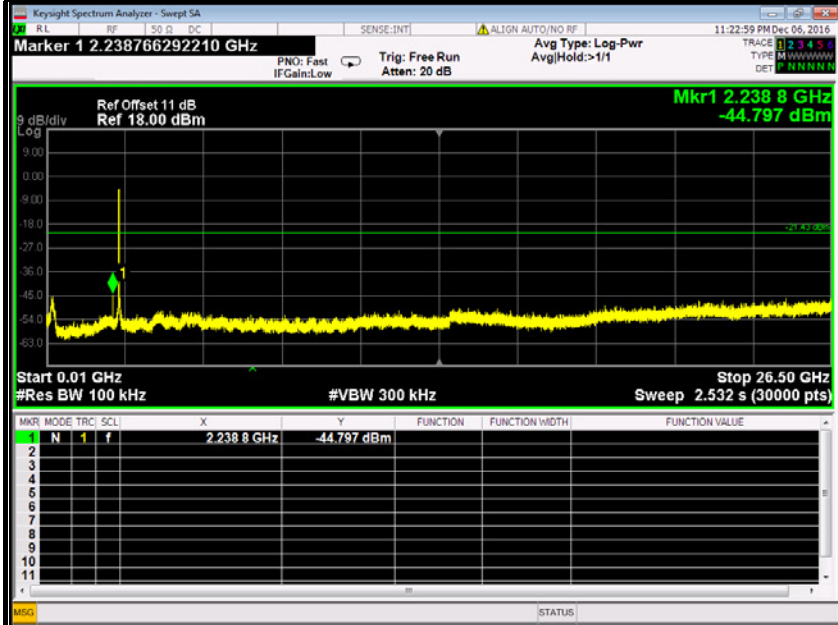

### CH High (2.43GHz ~2.5GHz)

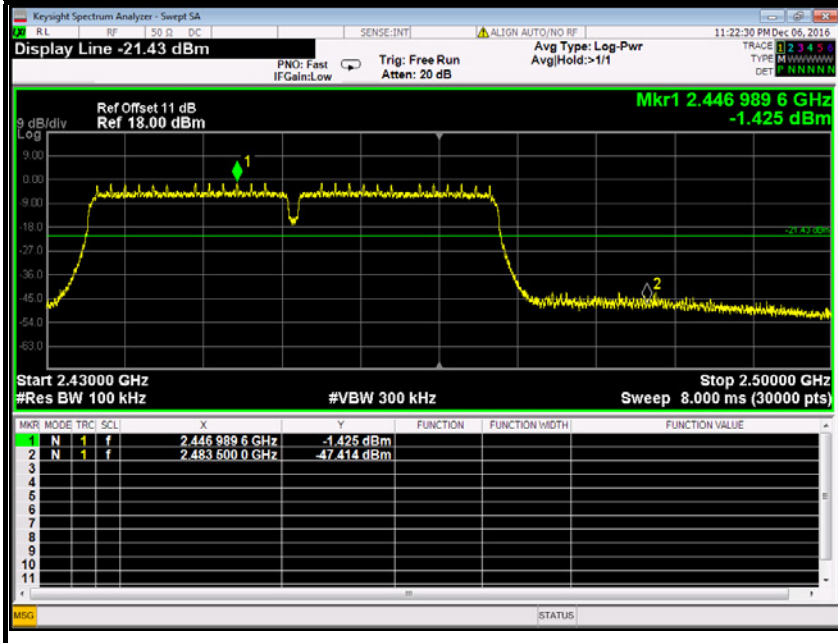



7.2.2. RADIATED EMISSIONS MEASUREMENT

7.2.2.1. LIMITS OF RADIATED EMISSIONS MEASUREMENT

According to §15.209(a), except as provided elsewhere in this Subpart, the emissions from an intentional radiator shall not exceed the field strength levels specified in the following table:

Frequency (MHz)	Field Strength (mV/m)	Measurement Distance (m)
0.009-0.490	2400/F(kHz)	300
0.490-1.705	24000/F(kHz)	30
1.705-30.0	30	30
30-88	100*	3
88-216	150*	3
216-960	200*	3
Above 960	500	3

**Remark:** Except as provided in paragraph (g), fundamental emissions from intentional radiators operating under this Section shall not be located in the frequency bands 54-72 MHz, 76-88 MHz, 174-216 MHz or 470-806 MHz. However, operation within these frequency bands is permitted under other sections of this Part, e.g., Sections 15.231 and 15.241.

1. In the emission table above, the tighter limit applies at the band edges.

Frequency (MHz)	Field Strength (µV/m at 3-meter)	Field Strength (dBµV/m at 3-meter)
30-88	100	40
88-216	150	43.5
216-960	200	46
Above 960	500	54

**NOTE:**(1) The lower limit shall apply at the transition frequencies.  
(2) Emission level (dBuV/m) = 20 log Emission level (uV/m).



**7.2.2.2. TEST INSTRUMENTS**

Radiated Emission Test Site 966(2)					
Name of Equipment	Manufacturer	Model Number	Serial Number	Last Calibration	Due Calibration
PSA Series Spectrum Analyzer	Agilent	E4446A	US44300399	02/21/2016	02/20/2017
EMI TEST RECEIVER	ROHDE&SCHWARZ	ESCI	100783	02/21/2016	02/20/2017
Amplifier	EMEC	EM330	060661	03/18/2016	03/17/2017
High Noise Amplifier	Agilent	8449B	3008A01838	02/21/2016	02/20/2017
Loop Antenna	COM-POWER	AL-130	121044	09/25/2016	09/24/2017
Bilog Antenna	SCHAFFNER	CBL6143	5082	02/21/2016	02/20/2017
Horn Antenna	SCHWARZBECK	BBHA9120	D286	02/28/2016	02/27/2017
Board-Band Horn Antenna	Schwarzbeck	BBHA 9170	9170-497	02/28/2016	02/27/2017
Turn Table	N/A	N/A	N/A	N.C.R	N.C.R
Antenna Tower	SUNOL	TLT2	N/A	N.C.R	N.C.R
Controller	Sunol Sciences	SC104V	022310-1	N.C.R	N.C.R
Controller	CT	N/A	N/A	N.C.R	N.C.R
Temp. / Humidity Meter	Anymetre	JR913	N/A	02/21/2016	02/20/2017
Test S/W	FARAD	LZ-RF / CCS-SZ-3A2			

- NOTE:** 1. The calibration interval of the above test instruments is 12 months and the calibrations are traceable to NML/ROC and NIST/USA.  
 2. The FCC Site Registration number is 101879.  
 3. N.C.R = No Calibration Required.



### 7.2.2.3. Measuring Instruments and Setting

The following table is the setting of spectrum analyzer and receiver.

Spectrum Parameter	Setting
Attenuation	Auto
Start Frequency	1000 MHz
Stop Frequency	10th carrier harmonic
RB / VB (Emission in restricted band)	1MHz / 1MHz for Peak, 1 MHz / 10Hz for Average
RB / VB (Emission in non-restricted band)	1MHz / 1MHz for Peak, 1 MHz / 10Hz for Average

Receiver Parameter	Setting
Attenuation	Auto
Start ~ Stop Frequency	9kHz~150kHz / RB 200Hz for QP/AVG
Start ~ Stop Frequency	150kHz~30MHz / RB 9kHz for QP/AVG
Start ~ Stop Frequency	30MHz~1000MHz / RB 100kHz for QP

### 7.2.2.4. TEST PROCEDURE (please refer to measurement standard)

#### 1) Sequence of testing 9 kHz to 30 MHz

##### Setup:

- The equipment was set up to simulate a typical usage like described in the user manual or described by manufacturer.
- If the EUT is a tabletop system, a rotatable table with 0.8 m height is used.
- If the EUT is a floor standing device, it is placed on the ground.
- Auxiliary equipment and cables were positioned to simulate normal operation conditions.
- The AC power port of the EUT (if available) is connected to a power outlet below the turntable.
- The measurement distance is 3 meter.
- The EUT was set into operation.

##### Pre measurement:

- The turntable rotates from 0° to 315° using 45° steps.
- The antenna height is 0.8 meter.
- At each turntable position the analyzer sweeps with peak detection to find the maximum of all emissions



**Final measurement:**

--- Identified emissions during the pre measurement the software maximizes by rotating the turntable position (0° to 360°) and by rotating the elevation axes (0° to 360°).

--- The final measurement will be done in the position (turntable and elevation) causing the highest emissions with QPK detector.

--- The final levels, frequency, measuring time, bandwidth, turntable position, correction factor, margin to the limit and limit will be recorded. Also a plot with the graph of the pre measurement and the limit will be stored.

**2) Sequence of testing 30 MHz to 1 GHz**

**Setup:**

--- The equipment was set up to simulate a typical usage like described in the user manual or described by manufacturer.

--- If the EUT is a tabletop system, a table with 0.8 m height is used, which is placed on the ground plane.

--- If the EUT is a floor standing device, it is placed on the ground plane with insulation between both.

--- Auxiliary equipment and cables were positioned to simulate normal operation conditions

--- The AC power port of the EUT (if available) is connected to a power outlet below the turntable.

--- The measurement distance is 3 meter.

--- The EUT was set into operation.

**Pre measurement:**

--- The turntable rotates from 0° to 315° using 45° steps.

--- The antenna is polarized vertical and horizontal.

--- The antenna height changes from 1 to 3 meter.

--- At each turntable position, antenna polarization and height the analyzer sweeps three times in peak to find the maximum of all emissions.



**Final measurement:**

- The final measurement will be performed with minimum the six highest peaks.
- According to the maximum antenna and turntable positions of premeasurement the software maximize the peaks by changing turntable position ( $\pm 45^\circ$ ) and antenna movement between 1 and 4 meter.
- The final measurement will be done with QP detector with an EMI receiver.
- The final levels, frequency, measuring time, bandwidth, antenna height, antenna polarization, turntable angle, correction factor, margin to the limit and limit will be recorded. Also a plot with the graph of the premeasurement with marked maximum final measurements and the limit will be stored.

**3) Sequence of testing 1 GHz to 18 GHz**

**Setup:**

- The equipment was set up to simulate a typical usage like described in the user manual or described by manufacturer.
- If the EUT is a tabletop system, a rotatable table with 1.5 m height is used.
- If the EUT is a floor standing device, it is placed on the ground plane with insulation between both.
- Auxiliary equipment and cables were positioned to simulate normal operation conditions
- The AC power port of the EUT (if available) is connected to a power outlet below the turntable.
- The measurement distance is 3 meter.
- The EUT was set into operation.

**Pre measurement:**

- The turntable rotates from  $0^\circ$  to  $315^\circ$  using  $45^\circ$  steps.
- The antenna is polarized vertical and horizontal.
- The antenna height scan range is 1 meter to 2.5 meter.
- At each turntable position and antenna polarization the analyzer sweeps with peak detection to find the maximum of all emissions.





**Final measurement:**

--- The final measurement will be performed with minimum the six highest peaks.

--- According to the maximum antenna and turntable positions of premeasurement the software maximize the peaks by changing turntable position ( $\pm 45^\circ$ ) and antenna movement between 1 and 4 meter. This procedure is repeated for both antenna polarizations.

--- The final measurement will be done in the position (turntable, EUT-table and antenna polarization) causing the highest emissions with Peak and Average detector.

--- The final levels, frequency, measuring time, bandwidth, turntable position, EUT-table position, antenna polarization, correction factor, margin to the limit and limit will be recorded. Also a plot with the graph of the pre measurement with marked maximum final measurements and the limit will be stored.

**4) Sequence of testing above 18 GHz**

**Setup:**

--- The equipment was set up to simulate a typical usage like described in the user manual or described by manufacturer.

--- If the EUT is a tabletop system, a rotatable table with 1.5 m height is used.

--- If the EUT is a floor standing device, it is placed on the ground plane with insulation between both.

--- Auxiliary equipment and cables were positioned to simulate normal operation conditions

--- The AC power port of the EUT (if available) is connected to a power outlet below the turntable.

--- The measurement distance is 1 meter.

--- The EUT was set into operation.

**Pre measurement:**

--- The antenna is moved spherical over the EUT in different polarisations of the antenna.

**Final measurement:**

--- The final measurement will be performed at the position and antenna orientation for all detected emissions that were found during the premeasurements with Peak and Average detector.

--- The final levels, frequency, measuring time, bandwidth, correction factor, margin to the limit and limit will be recorded. Also a plot with the graph of the premeasurement and the limit will be stored.



### 7.2.2.5. TEST SETUP

#### Below 30MHz

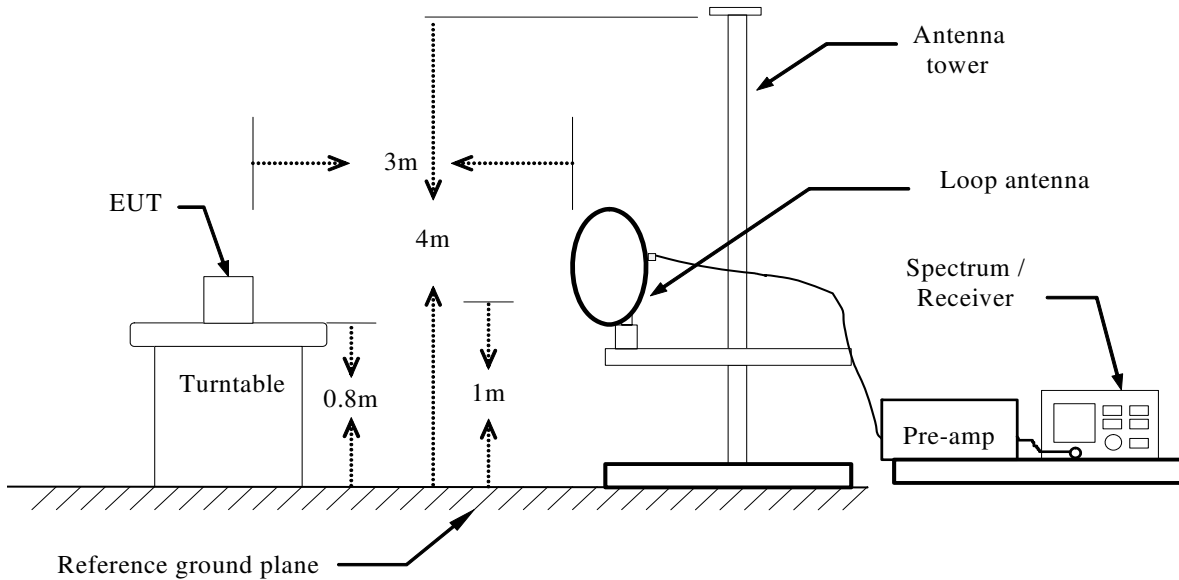

#### Below 1 GHz

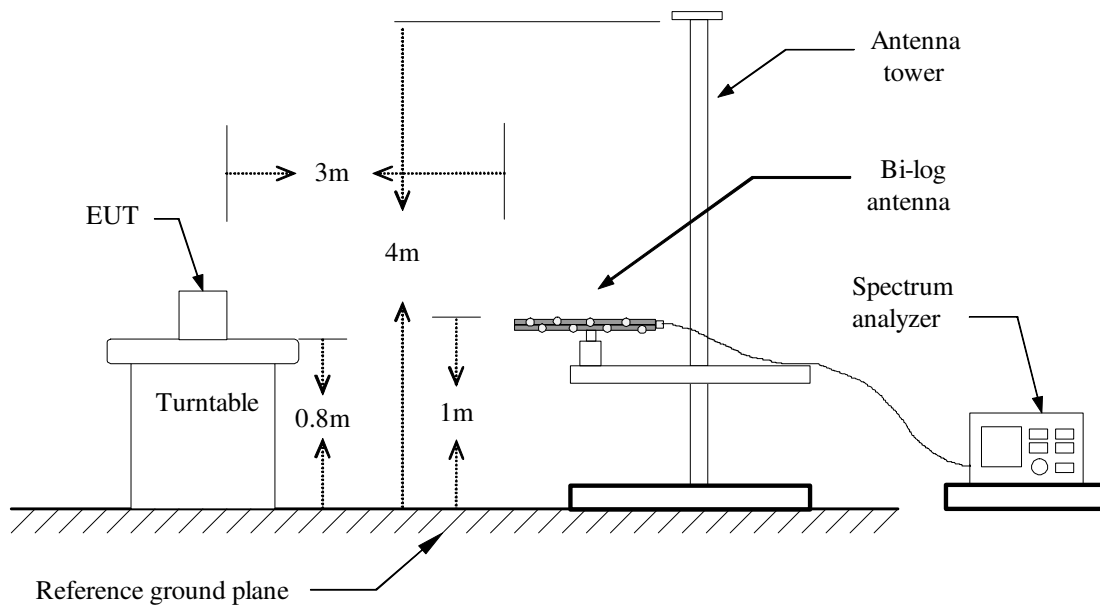



**Above 1 GHz**

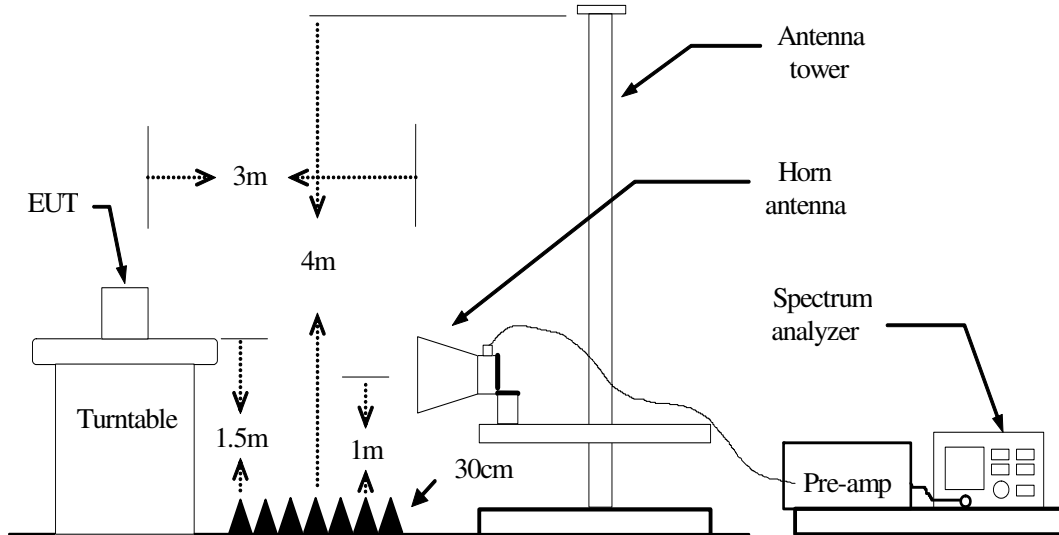

For the actual test configuration, please refer to the related item – Photographs of the Test Configuration.



7.2.2.6. DATA SAPLE

Below 1GHz

Frequency (MHz)	Reading (dBuV)	Correct Factor (dB/m)	Result (dBuV/m)	Limit (dBuV/m)	Margin (dB)	Antenna Pole (V/H)	Remark
XXX.XXXX	36.37	-12.20	24.17	40.00	-15.83	V	QP

- Frequency (MHz) = Emission frequency in MHz
- Reading (dBuV) = Uncorrected Analyzer / Receiver reading
- Correct Factor (dB/m) = Antenna factor + Cable loss – Amplifier gain
- Result (dBuV/m) = Reading (dBuV) + Corr. Factor (dB/m)
- Limit (dBuV/m) = Limit stated in standard
- Margin (dB) = Result (dBuV/m) – Limit (dBuV/m)
- Q.P. = Quasi-peak Reading

Above 1GHz

Frequency (MHz)	Reading (dBuV)	Correction Factor (dB/m)	Result (dBuV/m)	Limit (dBuV/m)	Margin (dB)	Antenna Pole (V/H)	Remark
XXXX.XXXX	62.09	-11.42	50.67	74.00	-23.33	V	Peak
XXXX.XXXX	49.78	-11.42	38.36	54.00	-15.64	V	AVG

- Frequency (MHz) = Emission frequency in MHz
- Reading (dBuV) = Uncorrected Analyzer / Receiver reading
- Correction Factor (dB/m) = Antenna factor + Cable loss – Amplifier gain
- Result (dBuV/m) = Reading (dBuV) + Corr. Factor (dB/m)
- Limit (dBuV/m) = Limit stated in standard
- Margin (dB) = Result (dBuV/m) – Limit (dBuV/m)
- Peak = Peak Reading
- AVG = Average Reading

**Calculation Formula**

Margin (dB) = Result (dBuV/m) – Limits (dBuV/m)  
 Result (dBuV/m) = Reading (dBuV) + Correction Factor



**7.2.2.7. TEST RESULTS**

**Below 1 GHz**

**Test Mode:** TX

**Tested by:** Jacksan Luo

**Ambient temperature:** 24°C **Relative humidity:** 52% RH

**Date:** December 5, 2016

Frequency (MHz)	Reading (dBuV)	Correction Factor (dB/m)	Result (dBuV/m)	Limit (dBuV/m)	Margin (dB)	Antenna Pole (V/H)	Remark
174.5300	52.81	-22.93	29.88	43.50	-13.62	V	QP
333.6100	54.02	-18.31	35.71	46.00	-10.29	V	QP
500.4500	50.86	-14.35	36.51	46.00	-9.49	V	QP
533.4300	55.25	-13.68	41.57	46.00	-4.43	V	QP
600.3600	42.98	-12.86	30.12	46.00	-15.88	V	QP
874.8700	40.47	-10.14	30.33	46.00	-15.67	V	QP
174.5300	52.24	-22.93	29.31	43.50	-14.19	H	QP
333.6100	54.67	-18.31	36.36	46.00	-9.64	H	QP
449.0400	48.43	-15.48	32.95	46.00	-13.05	H	QP
533.4300	52.99	-13.68	39.31	46.00	-6.69	H	QP
624.6100	40.19	-12.73	27.46	46.00	-18.54	H	QP
874.8700	39.96	-10.14	29.82	46.00	-16.18	H	QP

**\*\*Remark:** No emission found between lowest internal used/generated frequency to 30MHz.  
Pre-scan all mode and recorded the worst case results in this report (802.11b (Low Channel)).

**Notes:**

1. Radiated emissions measured in frequency range from 9kHz to 1GHz were made with an instrument using Quasi-peak detector mode.
2. Data of measurement within this frequency range shown " --- " in the table above means the reading of emissions are attenuated more than 20dB below the permissible limits or the field strength is too small to be measured.
3. The IF bandwidth of Receiver between 30MHz to 1GHz was 120kHz.
4. Frequency (MHz) = Emission frequency in MHz  
 Reading (dBuV/m) = Receiver reading  
 Correction Factor (dB) = Antenna factor + Cable loss – Amplifier gain  
 Limit (dBuV/m) = Limit stated in standard  
 Margin (dB) = Measured (dBuV/m) – Limits (dBuV/m)  
 Antenna Pole (H/V) = Current carrying line of reading



### Vertical

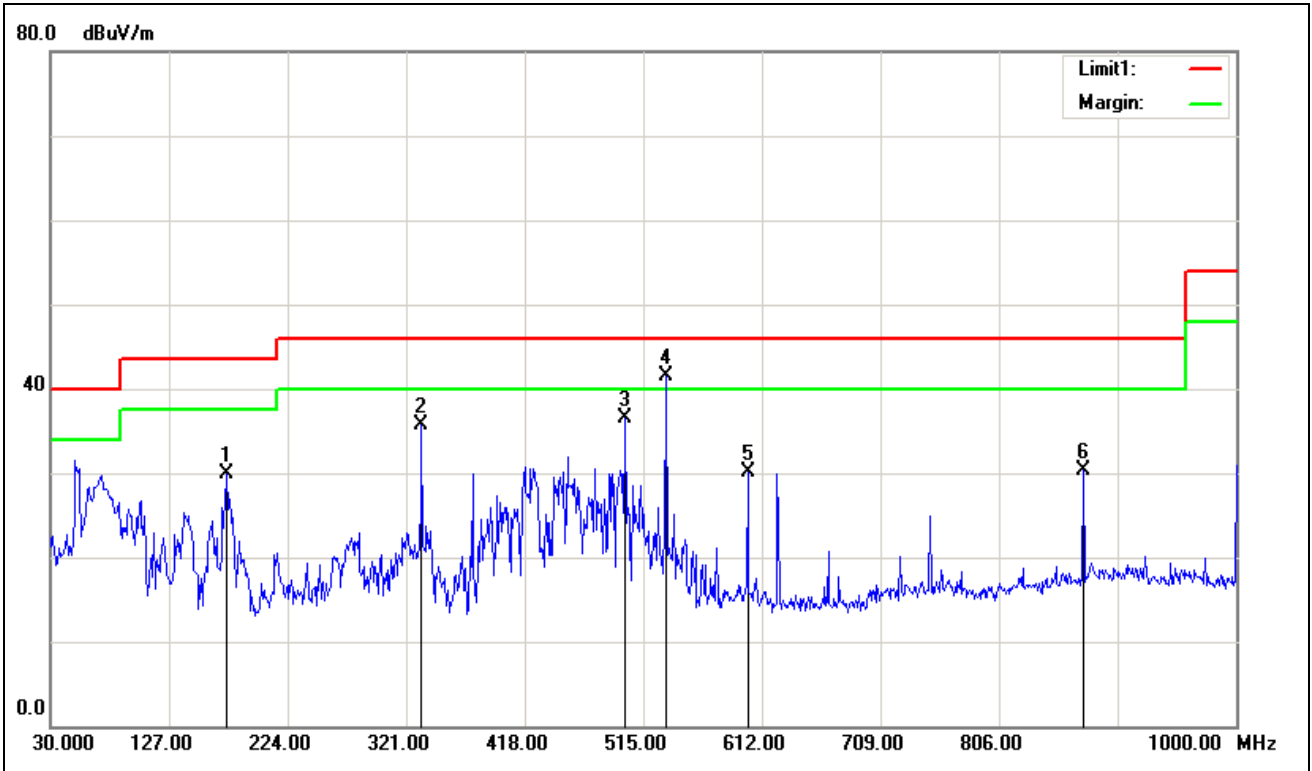

### Horizontal

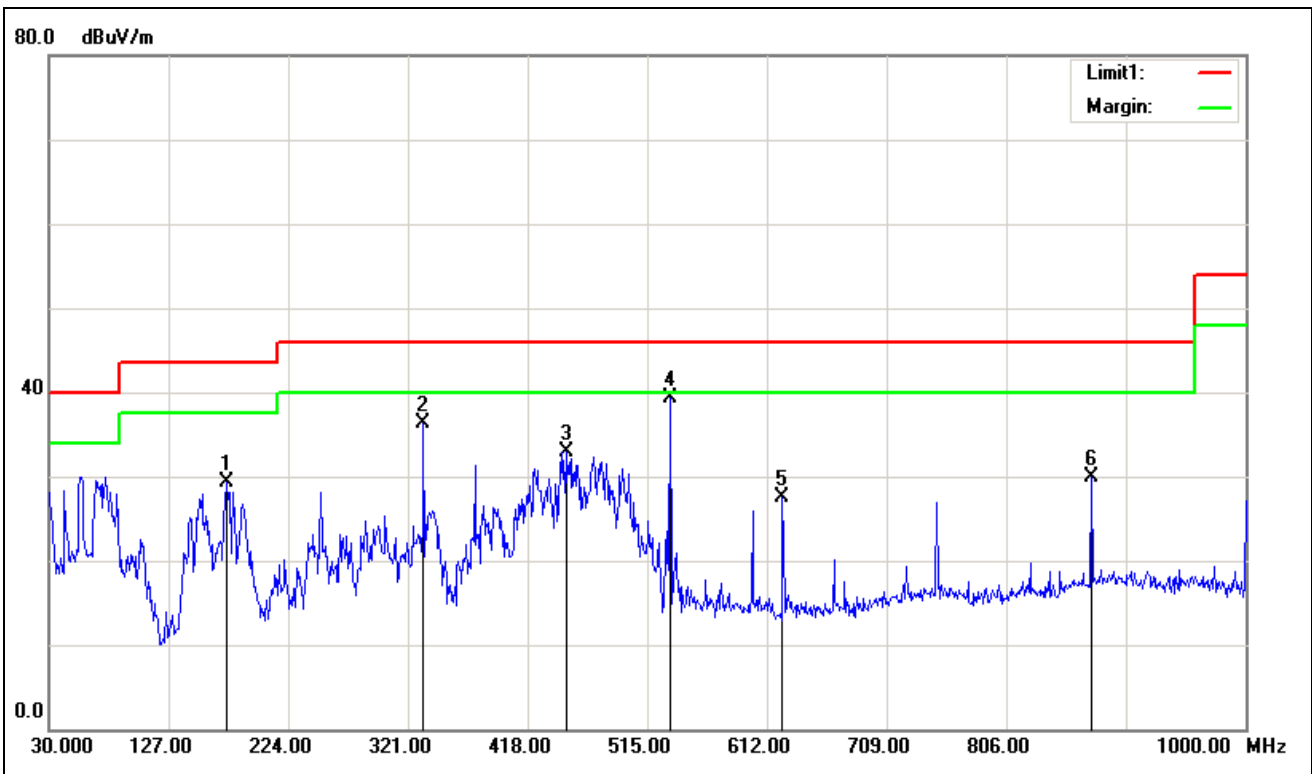



**Above 1 GHz**

**Test Mode:** TX / IEEE 802.11b(CH Low)

**Tested by:** Jacksan Luo

**Ambient temperature:** 24°C **Relative humidity:** 52% RH

**Date:** December 5, 2016

Frequency (MHz)	Reading (dBuV)	Correction Factor (dB/m)	Result (dBuV/m)	Limit (dBuV/m)	Margin (dB)	Antenna Pole (V/H)	Remark
1126.000	52.07	-8.07	44.00	74.00	-30.00	V	peak
2134.000	46.19	-4.27	41.92	74.00	-32.08	V	peak
2494.000	46.92	-2.29	44.63	74.00	-29.37	V	peak
3736.000	44.40	0.48	44.88	74.00	-29.12	V	peak
5482.000	42.07	5.84	47.91	74.00	-26.09	V	peak
7309.000	46.85	8.30	55.15	74.00	-18.85	V	peak
7309.000	41.82	8.30	50.12	54.00	-3.88	V	AVG
1126.000	52.41	-8.07	44.34	74.00	-29.66	H	Peak
2224.000	46.42	-3.77	42.65	74.00	-31.35	H	Peak
2539.000	45.46	-2.19	43.27	74.00	-30.73	H	Peak
3844.000	43.29	0.93	44.22	74.00	-29.78	H	peak
5464.000	41.07	5.81	46.88	74.00	-27.12	H	peak
7309.000	43.87	8.30	52.17	74.00	-21.83	H	Peak
7309.000	35.74	8.30	44.04	54.00	-9.96	H	AVG

**REMARKS:**

1. Measuring frequencies from 1 GHz to the 10th harmonic of highest fundamental frequency.
2. Radiated emissions measured in frequency above 1000MHz were made with an instrument using peak/average detector mode.
3. Average test would be performed if the peak result were greater than the average limit or as required by the applicant.
4. Data of measurement within this frequency range shown " --- " in the table above means the reading of emissions are attenuated more than 20dB below the permissible limits or the field strength is too small to be measured.
5. Measurements above show only up to 6 maximum emissions noted, or would be lesser, with " N/A " remark, if no specific emissions from the EUT are recorded (ie: margin>20dB from the applicable limit) and considered that's already beyond the background noise floor.
6. Margin (dB) = Remark result (dBuV/m) – Average limit (dBuV/m).



Test Mode: TX / IEEE 802.11b(CH Mid)

Tested by: Jacksan Luo

Ambient temperature: 24°C Relative humidity: 52% RH

Date: December 5, 2016

Frequency (MHz)	Reading (dBuV)	Correction Factor (dB/m)	Result (dBuV/m)	Limit (dBuV/m)	Margin (dB)	Antenna Pole (V/H)	Remark
1603.000	52.21	-6.69	45.52	74.00	-28.48	V	peak
2134.000	49.12	-4.27	44.85	74.00	-29.15	V	peak
2503.000	47.33	-2.25	45.08	74.00	-28.92	V	peak
3583.000	43.31	-0.17	43.14	74.00	-30.86	V	peak
4861.000	42.12	4.53	46.65	74.00	-27.35	V	peak
5599.000	40.99	5.91	46.90	74.00	-27.10	V	peak
1126.000	52.96	-8.07	44.89	74.00	-29.11	H	Peak
2242.000	47.01	-3.67	43.34	74.00	-30.66	H	Peak
2539.000	45.51	-2.19	43.32	74.00	-30.68	H	Peak
3223.000	44.39	-0.99	43.40	74.00	-30.60	H	peak
4231.000	42.84	2.40	45.24	74.00	-28.76	H	peak
5041.000	41.47	5.05	46.52	74.00	-27.48	H	Peak

**REMARKS:**

1. Measuring frequencies from 1 GHz to the 10th harmonic of highest fundamental frequency.
2. Radiated emissions measured in frequency above 1000MHz were made with an instrument using peak/average detector mode.
3. Average test would be performed if the peak result were greater than the average limit or as required by the applicant.
4. Data of measurement within this frequency range shown " --- " in the table above means the reading of emissions are attenuated more than 20dB below the permissible limits or the field strength is too small to be measured.
5. Measurements above show only up to 6 maximum emissions noted, or would be lesser, with " N/A " remark, if no specific emissions from the EUT are recorded (ie: margin>20dB from the applicable limit) and considered that's already beyond the background noise floor.
6. Margin (dB) = Remark result (dBuV/m) – Average limit (dBuV/m).





Test Mode: TX / IEEE 802.11b (CH High)

Tested by: Jacksan Luo

Ambient temperature: 24°C Relative humidity: 52% RH

Date: December 5, 2016

Frequency (MHz)	Reading (dBuV)	Correction Factor (dB/m)	Result (dBuV/m)	Limit (dBuV/m)	Margin (dB)	Antenna Pole (V/H)	Remark
1126.000	52.07	-8.07	44.00	74.00	-30.00	V	Peak
1603.000	48.84	-6.69	42.15	74.00	-31.85	V	Peak
2512.000	46.04	-2.24	43.80	74.00	-30.20	V	Peak
3970.000	42.50	1.46	43.96	74.00	-30.04	V	Peak
5023.000	41.46	5.02	46.48	74.00	-27.52	V	Peak
7381.000	44.41	8.44	52.85	74.00	-21.15	V	Peak
7381.000	39.49	8.44	47.93	54.00	-6.07	V	AVG
1126.000	52.19	-8.07	44.12	74.00	-29.88	H	Peak
2251.000	47.13	-3.62	43.51	74.00	-30.49	H	Peak
2512.000	46.50	-2.24	44.26	74.00	-29.74	H	Peak
3394.000	44.38	-0.70	43.68	74.00	-30.32	H	Peak
4348.000	42.50	2.81	45.31	74.00	-28.69	H	Peak
5014.000	42.27	5.00	47.27	74.00	-26.73	H	Peak

**REMARKS:**

1. Measuring frequencies from 1 GHz to the 10th harmonic of highest fundamental frequency.
2. Radiated emissions measured in frequency above 1000MHz were made with an instrument using peak/average detector mode.
3. Average test would be performed if the peak result were greater than the average limit or as required by the applicant.
4. Data of measurement within this frequency range shown " --- " in the table above means the reading of emissions are attenuated more than 20dB below the permissible limits or the field strength is too small to be measured.
5. Measurements above show only up to 6 maximum emissions noted, or would be lesser, with " N/A " remark, if no specific emissions from the EUT are recorded (ie: margin>20dB from the applicable limit) and considered that's already beyond the background noise floor.
6. Margin (dB) = Remark result (dBuV/m) – Average limit (dBuV/m).



Test Mode: TX / IEEE 802.11g(CH Low)

Tested by: Jacksan Luo

Ambient temperature: 24°C Relative humidity: 52% RH

Date: December 5, 2016

Frequency (MHz)	Reading (dBuV)	Correction Factor (dB/m)	Result (dBuV/m)	Limit (dBuV/m)	Margin (dB)	Antenna Pole (V/H)	Remark
1126.000	50.89	-8.07	42.82	74.00	-31.18	V	Peak
2494.000	46.10	-2.29	43.81	74.00	-30.19	V	Peak
3196.000	44.25	-1.03	43.22	74.00	-30.78	V	Peak
4582.000	42.45	3.62	46.07	74.00	-27.93	V	Peak
5086.000	42.35	5.13	47.48	74.00	-26.52	V	Peak
7228.000	46.21	8.14	54.35	74.00	-19.65	V	Peak
7228.000	38.64	8.14	46.78	54.00	-7.22	V	AVG
1126.000	52.29	-8.07	44.22	74.00	-29.78	H	Peak
1891.000	51.37	-5.69	45.68	74.00	-28.32	H	Peak
2539.000	46.06	-2.19	43.87	74.00	-30.13	H	Peak
3358.000	43.95	-0.76	43.19	74.00	-30.81	H	Peak
4123.000	42.08	2.02	44.10	74.00	-29.90	H	Peak
4798.000	42.85	4.32	47.17	74.00	-26.83	H	Peak

**REMARKS:**

1. Measuring frequencies from 1 GHz to the 10th harmonic of highest fundamental frequency.
2. Radiated emissions measured in frequency above 1000MHz were made with an instrument using peak/average detector mode.
3. Average test would be performed if the peak result were greater than the average limit or as required by the applicant.
4. Data of measurement within this frequency range shown “ --- ” in the table above means the reading of emissions are attenuated more than 20dB below the permissible limits or the field strength is too small to be measured.
5. Measurements above show only up to 6 maximum emissions noted, or would be lesser, with “ N/A ” remark, if no specific emissions from the EUT are recorded (ie: margin>20dB from the applicable limit) and considered that's already beyond the background noise floor.
6. Margin (dB) = Remark result (dBuV/m) – Average limit (dBuV/m).



Test Mode: TX / IEEE 802.11g (CH Mid)

Tested by: Jacksan Luo

Ambient temperature: 24°C

Relative humidity: 52% RH

Date: November 3, 2016

Frequency (MHz)	Reading (dBuV)	Correction Factor (dB/m)	Result (dBuV/m)	Limit (dBuV/m)	Margin (dB)	Antenna Pole (V/H)	Remark
1126.000	51.83	-8.07	43.76	74.00	-30.24	V	Peak
2512.000	47.82	-2.24	45.58	74.00	-28.42	V	Peak
3223.000	45.19	-0.99	44.20	74.00	-29.80	V	Peak
3961.000	43.30	1.43	44.73	74.00	-29.27	V	Peak
7309.000	45.30	8.30	53.60	74.00	-20.40	V	Peak
7309.000	36.53	8.30	44.83	54.00	-9.17	V	Peak
1126.000	52.43	-8.07	44.36	74.00	-29.64	H	Peak
2530.000	46.33	-2.21	44.12	74.00	-29.88	H	Peak
2818.000	45.91	-1.69	44.22	74.00	-29.78	H	Peak
3340.000	43.88	-0.79	43.09	74.00	-30.91	H	Peak
4510.000	41.89	3.38	45.27	74.00	-28.73	H	Peak
7318.000	43.11	8.32	51.43	74.00	-22.57	H	Peak

REMARKS:

1. Measuring frequencies from 1 GHz to the 10th harmonic of highest fundamental frequency.
2. Radiated emissions measured in frequency above 1000MHz were made with an instrument using peak/average detector mode.
3. Average test would be performed if the peak result were greater than the average limit or as required by the applicant.
4. Data of measurement within this frequency range shown " --- " in the table above means the reading of emissions are attenuated more than 20dB below the permissible limits or the field strength is too small to be measured.
5. Measurements above show only up to 6 maximum emissions noted, or would be lesser, with " N/A " remark, if no specific emissions from the EUT are recorded (ie: margin>20dB from the applicable limit) and considered that's already beyond the background noise floor.
6. Margin (dB) = Remark result (dBuV/m) – Average limit (dBuV/m).



Test Mode: TX / IEEE 802.11g (CH High)

Tested by: Jacksan Luo

Ambient temperature: 24°C Relative humidity: 52% RH

Date: November 3, 2016

Frequency (MHz)	Reading (dBuV)	Correction Factor (dB/m)	Result (dBuV/m)	Limit (dBuV/m)	Margin (dB)	Antenna Pole (V/H)	Remark
1126.000	50.41	-8.07	42.34	74.00	-31.66	V	Peak
2233.000	46.01	-3.72	42.29	74.00	-31.71	V	Peak
2512.000	46.50	-2.24	44.26	74.00	-29.74	V	Peak
4150.000	43.12	2.12	45.24	74.00	-28.76	V	Peak
5338.000	41.71	5.58	47.29	74.00	-26.71	V	Peak
7390.000	43.20	8.46	51.66	74.00	-22.34	V	Peak
1126.000	52.33	-8.07	44.26	74.00	-29.74	H	Peak
2080.000	48.09	-4.56	43.53	74.00	-30.47	H	Peak
2539.000	45.97	-2.19	43.78	74.00	-30.22	H	Peak
3196.000	44.84	-1.03	43.81	74.00	-30.19	H	Peak
3907.000	42.75	1.20	43.95	74.00	-30.05	H	Peak
5401.000	41.49	5.69	47.18	74.00	-26.82	H	Peak

**REMARKS:**

1. Measuring frequencies from 1 GHz to the 10th harmonic of highest fundamental frequency.
2. Radiated emissions measured in frequency above 1000MHz were made with an instrument using peak/average detector mode.
3. Average test would be performed if the peak result were greater than the average limit or as required by the applicant.
4. Data of measurement within this frequency range shown " --- " in the table above means the reading of emissions are attenuated more than 20dB below the permissible limits or the field strength is too small to be measured.
5. Measurements above show only up to 6 maximum emissions noted, or would be lesser, with " N/A " remark, if no specific emissions from the EUT are recorded (ie: margin>20dB from the applicable limit) and considered that's already beyond the background noise floor.
6. Margin (dB) = Remark result (dBuV/m) – Average limit (dBuV/m).



Test Mode: TX / IEEE 802.11n HT20 MHz (CH Low)

Tested by: Jackson Luo

Ambient temperature: 24°C

Relative humidity: 52% RH

Date: November 3, 2016

Frequency (MHz)	Reading (dBuV)	Correction Factor (dB/m)	Result (dBuV/m)	Limit (dBuV/m)	Margin (dB)	Antenna Pole (V/H)	Remark
1126.000	50.92	-8.07	42.85	74.00	-31.15	V	Peak
2143.000	46.56	-4.22	42.34	74.00	-31.66	V	Peak
2512.000	47.06	-2.24	44.82	74.00	-29.18	V	Peak
3205.000	44.60	-1.02	43.58	74.00	-30.42	V	Peak
4042.000	42.92	1.74	44.66	74.00	-29.34	V	Peak
7237.000	45.46	8.16	53.62	74.00	-20.38	V	Peak
7237.000	37.78	8.16	45.94	54.00	-8.06	V	AVG
1126.000	53.15	-8.07	45.08	74.00	-28.92	H	Peak
2242.000	46.63	-3.67	42.96	74.00	-31.04	H	Peak
2503.000	46.51	-2.25	44.26	74.00	-29.74	H	Peak
3340.000	44.05	-0.79	43.26	74.00	-30.74	H	Peak
4006.000	43.74	1.61	45.35	74.00	-28.65	H	Peak
5176.000	41.07	5.29	46.36	74.00	-27.64	H	Peak

**REMARKS:**

1. Measuring frequencies from 1 GHz to the 10th harmonic of highest fundamental frequency.
2. Radiated emissions measured in frequency above 1000MHz were made with an instrument using peak/average detector mode.
3. Average test would be performed if the peak result were greater than the average limit or as required by the applicant.
4. Data of measurement within this frequency range shown " --- " in the table above means the reading of emissions are attenuated more than 20dB below the permissible limits or the field strength is too small to be measured.
5. Measurements above show only up to 6 maximum emissions noted, or would be lesser, with " N/A " remark, if no specific emissions from the EUT are recorded (ie: margin>20dB from the applicable limit) and considered that's already beyond the background noise floor.
6. Margin (dB) = Remark result (dBuV/m) – Average limit (dBuV/m).



Test Mode: TX / IEEE 802.11n HT20 MHz (CH Mid)

Tested by: Jackson Luo

Ambient temperature: 24°C

Relative humidity: 52% RH

Date: November 3, 2016

Frequency (MHz)	Reading (dBuV)	Correction Factor (dB/m)	Result (dBuV/m)	Limit (dBuV/m)	Margin (dB)	Antenna Pole (V/H)	Remark
1126.000	50.71	-8.07	42.64	74.00	-31.36	V	Peak
1900.000	48.71	-5.63	43.08	74.00	-30.92	V	Peak
2539.000	46.36	-2.19	44.17	74.00	-29.83	V	Peak
3088.000	44.29	-1.21	43.08	74.00	-30.92	V	Peak
4330.000	42.60	2.75	45.35	74.00	-28.65	V	Peak
7309.000	43.45	8.30	51.75	74.00	-22.25	V	Peak
1126.000	51.79	-8.07	43.72	74.00	-30.28	H	Peak
2485.000	46.48	-2.34	44.14	74.00	-29.86	H	Peak
3079.000	44.42	-1.23	43.19	74.00	-30.81	H	Peak
3727.000	42.81	0.44	43.25	74.00	-30.75	H	Peak
5077.000	41.43	5.12	46.55	74.00	-27.45	H	Peak
5581.000	41.24	5.90	47.14	74.00	-26.86	H	Peak

**REMARKS:**

1. *Measuring frequencies from 1 GHz to the 10th harmonic of highest fundamental frequency.*
2. *Radiated emissions measured in frequency above 1000MHz were made with an instrument using peak/average detector mode.*
3. *Average test would be performed if the peak result were greater than the average limit or as required by the applicant.*
4. *Data of measurement within this frequency range shown " --- " in the table above means the reading of emissions are attenuated more than 20dB below the permissible limits or the field strength is too small to be measured.*
5. *Measurements above show only up to 6 maximum emissions noted, or would be lesser, with " N/A " remark, if no specific emissions from the EUT are recorded (ie: margin>20dB from the applicable limit) and considered that's already beyond the background noise floor.*
6. *Margin (dB) = Remark result (dBuV/m) – Average limit (dBuV/m).*



**Test Mode:** TX / EEE 802.11n HT20 MHz (CH High)

**Tested by:** Jacksan Luo

**Ambient temperature:** 24°C **Relative humidity:** 52% RH

**Date:** December 5, 2016

Frequency (MHz)	Reading (dBuV)	Correction Factor (dB/m)	Result (dBuV/m)	Limit (dBuV/m)	Margin (dB)	Antenna Pole (V/H)	Remark
1126.000	50.40	-8.07	42.33	74.00	-31.67	V	Peak
1378.000	47.64	-7.14	40.50	74.00	-33.50	V	Peak
2503.000	47.16	-2.25	44.91	74.00	-29.09	V	Peak
3349.000	44.26	-0.77	43.49	74.00	-30.51	V	Peak
4888.000	42.02	4.61	46.63	74.00	-27.37	V	Peak
7381.000	43.88	8.44	52.32	74.00	-21.68	V	Peak
7381.000	36.13	8.44	44.57	54.00	-9.43	V	AVG
1126.000	54.13	-8.07	46.06	74.00	-27.94	H	Peak
1900.000	47.46	-5.63	41.83	74.00	-32.17	H	Peak
2512.000	46.49	-2.24	44.25	74.00	-29.75	H	Peak
3349.000	44.38	-0.77	43.61	74.00	-30.39	H	Peak
3961.000	43.00	1.43	44.43	74.00	-29.57	H	Peak
5329.000	41.69	5.57	47.26	74.00	-26.74	H	Peak

**REMARKS:**

1. Measuring frequencies from 1 GHz to the 10th harmonic of highest fundamental frequency.
2. Radiated emissions measured in frequency above 1000MHz were made with an instrument using peak/average detector mode.
3. Average test would be performed if the peak result were greater than the average limit or as required by the applicant.
4. Data of measurement within this frequency range shown " --- " in the table above means the reading of emissions are attenuated more than 20dB below the permissible limits or the field strength is too small to be measured.
5. Measurements above show only up to 6 maximum emissions noted, or would be lesser, with " N/A " remark, if no specific emissions from the EUT are recorded (ie: margin>20dB from the applicable limit) and considered that's already beyond the background noise floor.
6. Margin (dB) = Remark result (dBuV/m) – Average limit (dBuV/m).



Test Mode: TX / IEEE 802.11n HT40 MHz (CH Low)

Tested by: Jackson Luo

Ambient temperature: 24°C Relative humidity: 52% RH

Date: November 3, 2016

Frequency (MHz)	Reading (dBUV)	Correction Factor (dB/m)	Result (dBUV/m)	Limit (dBUV/m)	Margin (dB)	Antenna Pole (V/H)	Remark
1126.000	50.77	-8.07	42.70	74.00	-31.30	V	Peak
2494.000	46.26	-2.29	43.97	74.00	-30.03	V	Peak
3340.000	43.79	-0.79	43.00	74.00	-31.00	V	Peak
3781.000	42.88	0.67	43.55	74.00	-30.45	V	Peak
4663.000	41.75	3.88	45.63	74.00	-28.37	V	Peak
5428.000	41.34	5.74	47.08	74.00	-26.92	V	Peak
1126.000	51.31	-8.07	43.24	74.00	-30.76	H	Peak
1891.000	49.06	-5.69	43.37	74.00	-30.63	H	Peak
2521.000	46.33	-2.22	44.11	74.00	-29.89	H	Peak
2800.000	45.34	-1.72	43.62	74.00	-30.38	H	Peak
4096.000	42.42	1.93	44.35	74.00	-29.65	H	Peak
5041.000	42.01	5.05	47.06	74.00	-26.94	H	Peak

**REMARKS:**

1. Measuring frequencies from 1 GHz to the 10th harmonic of highest fundamental frequency.
2. Radiated emissions measured in frequency above 1000MHz were made with an instrument using peak/average detector mode.
3. Average test would be performed if the peak result were greater than the average limit or as required by the applicant.
4. Data of measurement within this frequency range shown " --- " in the table above means the reading of emissions are attenuated more than 20dB below the permissible limits or the field strength is too small to be measured.
5. Measurements above show only up to 6 maximum emissions noted, or would be lesser, with " N/A " remark, if no specific emissions from the EUT are recorded (ie: margin>20dB from the applicable limit) and considered that's already beyond the background noise floor.
6. Margin (dB) = Remark result (dBUV/m) – Average limit (dBUV/m).





Test Mode: TX / IEEE 802.11n HT40 MHz (CH Mid)

Tested by: Jackson Luo

Ambient temperature: 24°C Relative humidity: 52% RH

Date: November 3, 2016

Frequency (MHz)	Reading (dBuV)	Correction Factor (dB/m)	Result (dBuV/m)	Limit (dBuV/m)	Margin (dB)	Antenna Pole (V/H)	Remark
1126.000	52.10	-8.07	44.03	74.00	-29.97	V	Peak
2503.000	46.67	-2.25	44.42	74.00	-29.58	V	Peak
3196.000	44.88	-1.03	43.85	74.00	-30.15	V	Peak
4267.000	42.29	2.53	44.82	74.00	-29.18	V	Peak
4879.000	41.63	4.59	46.22	74.00	-27.78	V	Peak
7309.000	43.43	8.30	51.73	74.00	-22.27	V	Peak
1126.000	52.21	-8.07	44.14	74.00	-29.86	H	Peak
1504.000	47.99	-6.87	41.12	74.00	-32.88	H	Peak
2512.000	46.87	-2.24	44.63	74.00	-29.37	H	Peak
3088.000	44.48	-1.21	43.27	74.00	-30.73	H	Peak
4159.000	42.76	2.15	44.91	74.00	-29.09	H	Peak
5014.000	41.91	5.00	46.91	74.00	-27.09	H	Peak

**REMARKS:**

1. Measuring frequencies from 1 GHz to the 10th harmonic of highest fundamental frequency.
2. Radiated emissions measured in frequency above 1000MHz were made with an instrument using peak/average detector mode.
3. Average test would be performed if the peak result were greater than the average limit or as required by the applicant.
4. Data of measurement within this frequency range shown " --- " in the table above means the reading of emissions are attenuated more than 20dB below the permissible limits or the field strength is too small to be measured.
5. Measurements above show only up to 6 maximum emissions noted, or would be lesser, with " N/A " remark, if no specific emissions from the EUT are recorded (ie: margin>20dB from the applicable limit) and considered that's already beyond the background noise floor.
6. Margin (dB) = Remark result (dBuV/m) – Average limit (dBuV/m).



Test Mode: TX / EEE 802.11n HT40 MHz (CH High)

Tested by: Jackson Luo

Ambient temperature: 24°C    Relative humidity: 52% RH

Date: November 3, 2016

Frequency (MHz)	Reading (dBuV)	Correction Factor (dB/m)	Result (dBuV/m)	Limit (dBuV/m)	Margin (dB)	Antenna Pole (V/H)	Remark
1126.000	51.35	-8.07	43.28	74.00	-30.72	V	Peak
2242.000	46.87	-3.67	43.20	74.00	-30.80	V	Peak
2512.000	45.96	-2.24	43.72	74.00	-30.28	V	Peak
3880.000	43.72	1.08	44.80	74.00	-29.20	V	Peak
4834.000	42.03	4.44	46.47	74.00	-27.53	V	Peak
5734.000	40.71	5.97	46.68	74.00	-27.32	V	Peak
1126.000	51.86	-8.07	43.79	74.00	-30.21	H	Peak
1891.000	46.25	-5.69	40.56	74.00	-33.44	H	Peak
2521.000	46.33	-2.22	44.11	74.00	-29.89	H	Peak
3214.000	44.32	-1.00	43.32	74.00	-30.68	H	Peak
4321.000	42.80	2.72	45.52	74.00	-28.48	H	Peak
4600.000	42.36	3.68	46.04	74.00	-27.96	H	Peak

**REMARKS:**

1. Measuring frequencies from 1 GHz to the 10th harmonic of highest fundamental frequency.
2. Radiated emissions measured in frequency above 1000MHz were made with an instrument using peak/average detector mode.
3. Average test would be performed if the peak result were greater than the average limit or as required by the applicant.
4. Data of measurement within this frequency range shown “ --- ” in the table above means the reading of emissions are attenuated more than 20dB below the permissible limits or the field strength is too small to be measured.
5. Measurements above show only up to 6 maximum emissions noted, or would be lesser, with “ N/A ” remark, if no specific emissions from the EUT are recorded (ie: margin>20dB from the applicable limit) and considered that's already beyond the background noise floor.
6. Margin (dB) = Remark result (dBuV/m) – Average limit (dBuV/m).



### 7.3. 6dB BANDWIDTH MEASUREMENT

#### 7.3.1. LIMITS

According to §15.247(a)(2), systems using digital modulation techniques may operate in the 902 - 928 MHz, 2400 - 2483.5 MHz. The minimum 6 dB bandwidth shall be at least 500 kHz.

#### 7.3.2. TEST INSTRUMENTS

Name of Equipment	Manufacturer	Model	Serial Number	Last Calibration	Calibration Due
Spectrum Analyzer	Agilent	N9010A	MY52221469	02/21/2016	02/20/2017

#### 7.3.3. TEST PROCEDURES (please refer to measurement standard)

##### 8.1 Option 2:

The automatic bandwidth measurement capability of an instrument may be employed using the X dB bandwidth mode with X set to 6 dB, if the functionality described above (i.e., RBW = 100 kHz, VBW ≥ 3 RBW, peak detector with maximum hold) is implemented by the instrumentation function. When using this capability, care shall be taken so that the bandwidth measurement is not influenced by any intermediate power nulls in the fundamental emission that might be ≥ 6 dB.

#### 7.3.4. TEST SETUP

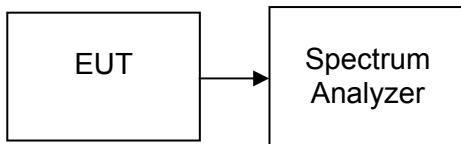



**7.3.5. TEST RESULTS**

*No non-compliance noted*

**Test Data**

**Test mode: IEEE 802.11b**

Channel	Frequency (MHz)	Bandwidth (kHz)	Limit (kHz)	Test Result
Low	2412	7112	>500	PASS
Mid	2437	7579		PASS
High	2462	7574		PASS

**Test mode: IEEE 802.11g**

Channel	Frequency (MHz)	Bandwidth (kHz)	Limit (kHz)	Test Result
Low	2412	16390	>500	PASS
Mid	2437	16390		PASS
High	2462	16360		PASS

**Test mode: IEEE 802.11n HT20 MHz**

Channel	Frequency (MHz)	Bandwidth (kHz)	Limit (kHz)	Test Result
Low	2412	17630	>500	PASS
Mid	2437	17620		PASS
High	2462	17620		PASS

**Test mode: IEEE 802.11n HT40 MHz**

Channel	Frequency (MHz)	Bandwidth (kHz)	Limit (kHz)	Test Result
Low	2412	35550	>500	PASS
Mid	2437	35670		PASS
High	2462	35720		PASS



Test Plot

IEEE 802.11b mode

6dB Bandwidth (CH Low)

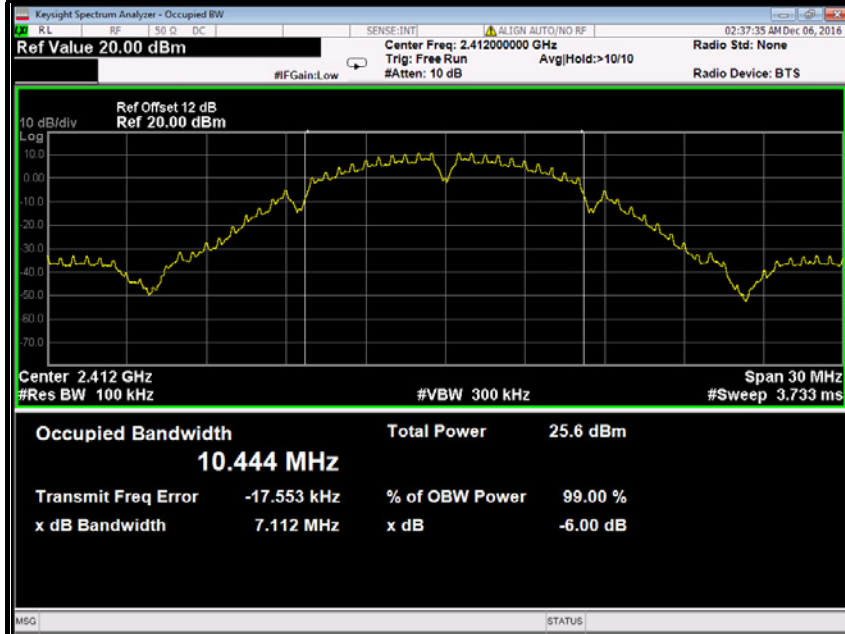

6dB Bandwidth (CH Mid)

