



Test report no. : 140235-11

Item tested : A09-0490

**Type of equipment : IEEE 802.15.4, 2.4 GHz
Evaluation Module**

FCC ID : VW4A09-0490

Client : Atmel Norway AS

FCC Part 15.247
Digital Transmission System

RSS-210 Issue 7 & RSS Gen Issue 2
Low Power Licence-Exempt
Radio communication Devices

11 February 2010

Authorized by :

Frode Sveinsen
Technical Verificator



CONTENTS

1	GENERAL INFORMATION	3
1.1	Testhouse Info	3
1.2	Client Information.....	3
1.3	Manufacturer.....	3
2	Test Information.....	4
2.1	Test Item.....	4
2.2	Test Environment.....	5
2.2.1	Normal test condition	5
2.3	Test Period.....	5
3	TEST REPORT SUMMARY	6
3.1	General	6
3.2	Test Summary.....	7
3.3	Description of modification for Modification Filing.....	7
3.4	Comments	7
3.5	Family List Rationale	7
4	TEST RESULTS	8
4.1	Power-line Conducted Emissions	8
4.2	Minimum 6 dB Bandwidth	10
4.3	Peak Power Output.....	14
4.4	Spurious Emissions (Radiated)	18
4.5	Power Spectral Density (PSD).....	35
5	LIST OF TEST EQUIPMENT.....	39
6	BLOCK DIAGRAM	40
6.1	System set up for radiated measurements	40
6.2	Test Site Radiated Emission.....	41

1 GENERAL INFORMATION

1.1 Testhouse Info

Name : Nemko AS
Address : Nemko Kjeller
Instituttveien 6, Box 96
N-2027 Kjeller, NORWAY
Telephone : +47 64 84 57 00
Fax : +47 64 84 57 05
E-mail: post@comlab.no
FCC test firm registration # : 994405
IC OATS registration # : 2040D-1
Total Number of Pages: 41

1.2 Client Information

Name : Atmel Norway AS
Address : Vestre Rosten 79,
N-7075 Trondheim, Norway
Telephone : +47 72 88 43 88
Fax : --

Contact:

Name : Ronny F. Larsen
Telephone : +47 72 89 75 54
E-mail : ronny.f.larsen@atmel.com

1.3 Manufacturer

Same as client

2 Test Information

2.1 Test Item

Name :	RZ600
Model/version :	A09-0490
Serial number :	MAC 0004251CA00100BE
Hardware identity and/or version:	A09-0490
Software identity and/or version :	V1.0
Frequency Range :	2405 – 2480 MHz
Number of Channels :	16
Operating Modes :	TX & RX
Type of Modulation :	DSSS/O-QPSK
Emissions Designator :	G1D
User Frequency Adjustment :	None, Software controlled
Rated Output Power :	2mW (3dBm)
Type of Power Supply :	Power from USB port
Antenna Connector :	SMA
Antenna type:	whip
Antenna Diversity Supported :	None

Theory of Operation

The A09-0490 is a part of a development kit RZ600 that consists of USB card (A09-0831), radio card (A09-0490) and RF chip (ATRF231). This kit is designed to aid development of wireless applications, such as IEEE 802.15.4 and ZigBee, using the AVR microcontroller and ATRF231 radio transceiver. This board is targeted as a sink node in the network that can be connected to and powered from a PC using USB..

Description of Test Item

The A09-0490 is an USB dongle with dimension of 6 cm X 1,5 cm.

2.2 Test Environment

2.2.1 Normal test condition

Temperature:	20 - 22 °C
Relative humidity:	20 - 40 %
Normal test voltage:	Power from USB

The values are the limit registered during the test period.

2.3 Test Period

Item received date:	2009-12-18
Test period :	from 2009-12-18 to 2010-01-04

3 TEST REPORT SUMMARY

3.1 General

Manufacturer: Atmel Norway AS
Model No.: A09-0490
Serial No.: MAC 0004251CA00100BE

All measurements are traceable to national standards.

The tests were conducted for the purpose of demonstrating compliance with FCC CFR 47 Part 15.247.

Radiated tests were conducted in accordance with ANSI C63.4-2003. The radiated tests were made in a semi-anechoic chamber at measuring distances of 3 and 10 meters.

- | | |
|---|---|
| <input checked="" type="checkbox"/> New Submission | <input checked="" type="checkbox"/> Production Unit |
| <input type="checkbox"/> Class II Permissive Change | <input type="checkbox"/> Pre-production Unit |
| DTS Equipment Code | <input type="checkbox"/> Family Listing |

THIS TEST REPORT RELATES ONLY TO THE ITEM (S) TESTED.

Deviations from, additions to, or exclusions from the test specifications are described in "Summary of Test Data".

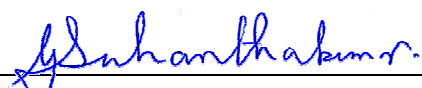

TEST REPORT #: 140235-11

TESTED BY: 
G.Suhanthakumar, Test engineer

DATE: 2010-03-09

Nemko AS authorizes the above named company to reproduce this report provided it is reproduced in its entirety and for use by the company's employees only. Any reproduction of parts of this report requires approval in writing from Nemko AS.

Any use which a third party makes of this report, or any reliance on or decisions to be made based on it, are the responsibility of such third parties. Nemko AS accepts no responsibility for damages suffered by any third party as a result of decisions made or actions based on this report.

This test report applies only to the items and configurations tested.

3.2 Test Summary

Name of test	FCC Part 15 reference	RSS210 Issue 7 & RSS Gen Issue 2	Result
Supply voltage variations	15.31 (e)	8 (RSS-GEN)	N/A ²
Number of operating frequencies	15.31 (m)	A8.1	Complies
Power-line Conducted Emissions (Receiver)	15.107(a)	7.2.2 (RSS-GEN)	Complies
Radiated Emissions limits (receiver)	15.109(a)	6 (RSS-GEN)	ref. 15.209(a)
Antenna requirement	15.203	7.1.4 (RSS-GEN)	Complies ¹
Radiated emissions limits for restricted bands	15.205(a)		Complies
Power Line Conducted Emissions	15.207(a)	7.2.2 (RSS-GEN)	Complies
Radiated emission limits	15.209(a)	A8.5	Complies
Bandwidth	15.247(a)(2)	A8.2	Complies
Peak Power Output	15.247(b)(3)	A8.4	Complies
Power Spectral Density	15.247(d)	A8.2	Complies
Out-of-band emissions (Antenna Conducted)	15.247(c)	A8.5	Complies ¹
Out-of-band emissions (Radiated)	15.247(c)	A8.5	Complies
Lower band edge radiated emission	15.247(c)	A8.5	Complies
Upper band edge radiated emission	15.247(c)	A8.5	Complies

¹ standard SMA connector (for laboratory use).

² The power is taken from USB port.

3.3 Description of modification for Modification Filing

Not applicable.

3.4 Comments

The channels are selected with a computer connected to the EUT. The computer is only used for selection of channels. The measurements are performed at channels near top Ch 26, near middle Ch 18 and near bottom Ch 11. And the output level is set to maximum in the software. The EUT complies at these channels.

During radiated tests the selection of channels are done by manufacturer outside the test chamber. The computer (a Dell Latitude D610) is used during the test as power source for USB port.

The radiated measurements are tested on three axis.

An antenna connector is used only for making conducted RF measurements for evaluation purposes.

The same computer is used to power the EUT during the power-line conducted emissions tests.

3.5 Family List Rationale

Not Applicable.

4 TEST RESULTS

4.1 Power-line Conducted Emissions

Para. No.: 15.207 (a)

Test Performed By: G.Suwanthakumar	Date of Test: 18-Dec-2009
------------------------------------	---------------------------

Measurement procedure: ANSI C63.4-2003 using 50 μ H/50 ohms LISN.

Test Results: **Complies**

For host a Dell Latitude D610 Computer is used.

Dell AC Adapter: S/N: CN-0F8834-48661-5AG-J579, Model: ADP-65JB B

Highest measured value (L1 and N):

Frequency	Detector	Measured value	Limit	Margin
MHz	QP/AV	dB μ V	dB μ V	dB
0,2	QP	53	63,6	10,6
0,2	AV	49	53,6	4,6
0,265	QP	47	61,3	14,3
0,265	AV	39	51,3	12,3
3,3	QP	33	56	23
3,3	AV	12	46	34

The measured power line conducted emission for computer alone and with USB card (EUT) is identical, the power line conducted emission is not changed due to the USB card.

See the attached graphs for peak scan..

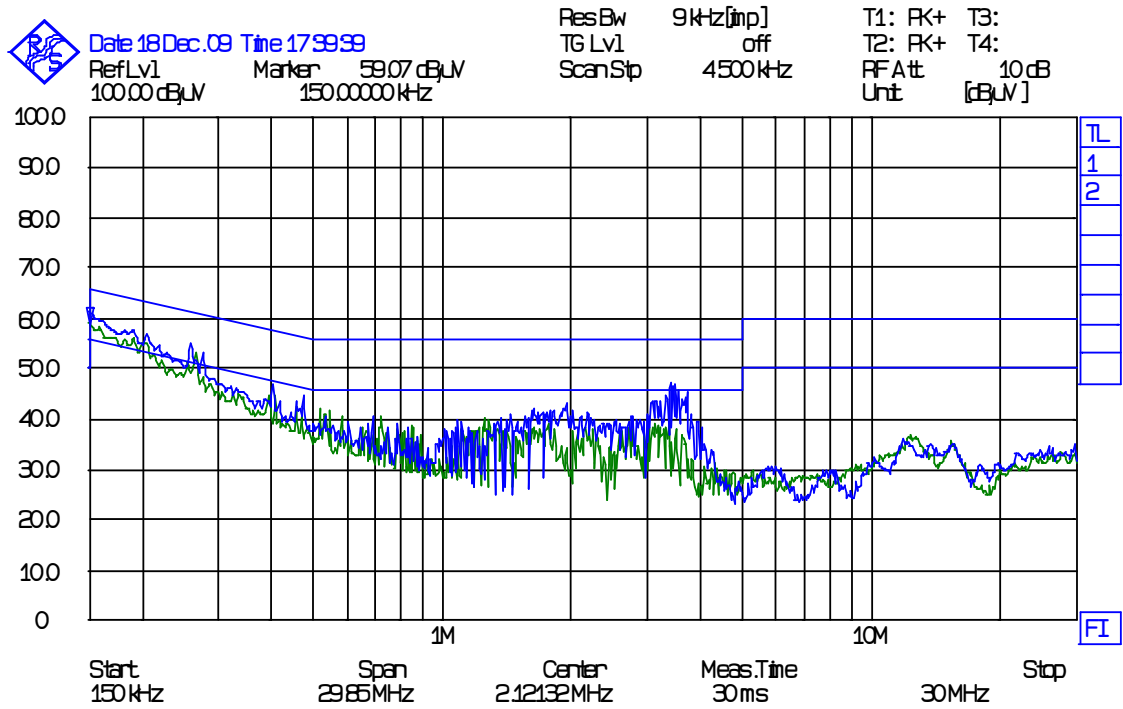

L1 & n polarity - power line conducted emission

4.2 Minimum 6 dB Bandwidth

Para. No.: 15.247 (a)(2)

Test Performed By: G.Suwanthakumar	Date of Test: 04-Jan-2010
------------------------------------	---------------------------

Test Results: Complies

Measurement Data:

6 dB Bandwidth (MHz)		
Ch 11 2405MHz	Ch 18 2440MHz	Ch 26 2480MHz
1.60	1.60	1.62

Requirements:

For Digital Transmission Systems in the 2400-2483.5 MHz band the minimum 6 dB bandwidth shall be at least 500 KHz.

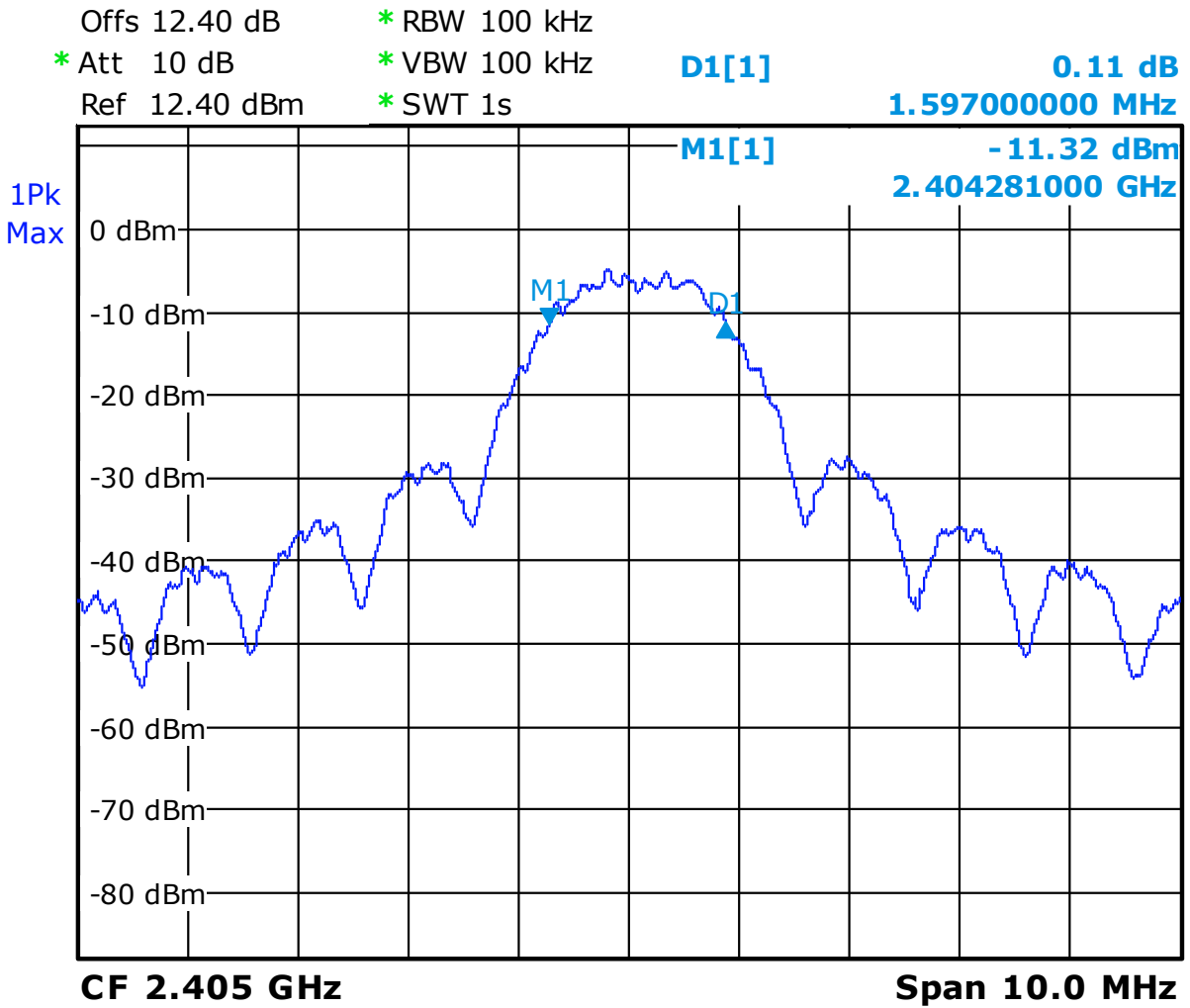

Date: 4.JAN.2010 09:29:16

Ch11 – 6 dB bandwidth – 1.60MHz

4.3 Peak Power Output

Para. No.: 15.247 (b)

Test Performed By: G.Suhanthakumar	Date of Test: 18-Dec-2009
------------------------------------	---------------------------

Test Results: Complies

Measurement Data:

Maximum Conducted Peak Output Power

RF channel	Ch 11	Ch 18	Ch 26
Measured value (mW)	0.515	0.526	0.53

Wide band power meter from Agilent U2000A is used to measure the conducted out-put power.

Maximum Field strength

RF channel	Ch 11	Ch 18	Ch 26
Measured value (dBµV/m)	93.95	95.33	96.34

Maximum EIRP

RF channel	Ch 11	Ch 18	Ch 26
Measured EIRP (mW)	0.228	0.345	0.445
Antenna gain dBi	-3.5	-1.83	-0.76

Antenna gain = $10 \cdot \log(\text{EIRP}/\text{Conducted Power})$ dBi

The EIRP is measured using substitution method. The maximum eirp is obtained at horizontal polarization.

Detachable antenna?

Yes No

If detachable, is the antenna connector non-standard?

Yes No

SMA connector

Requirements:

The maximum peak output power shall not exceed the following limits:

For Digital Transmission Systems in the 2400 - 2483.5 MHz band: 1 Watt

If transmitting antennas of directional gain greater than 6 dBi are used, the peak output power from the intentional radiator shall be reduced below the stated value above by the amount in dB that the directional gain of the antenna exceeds 6 dBi.

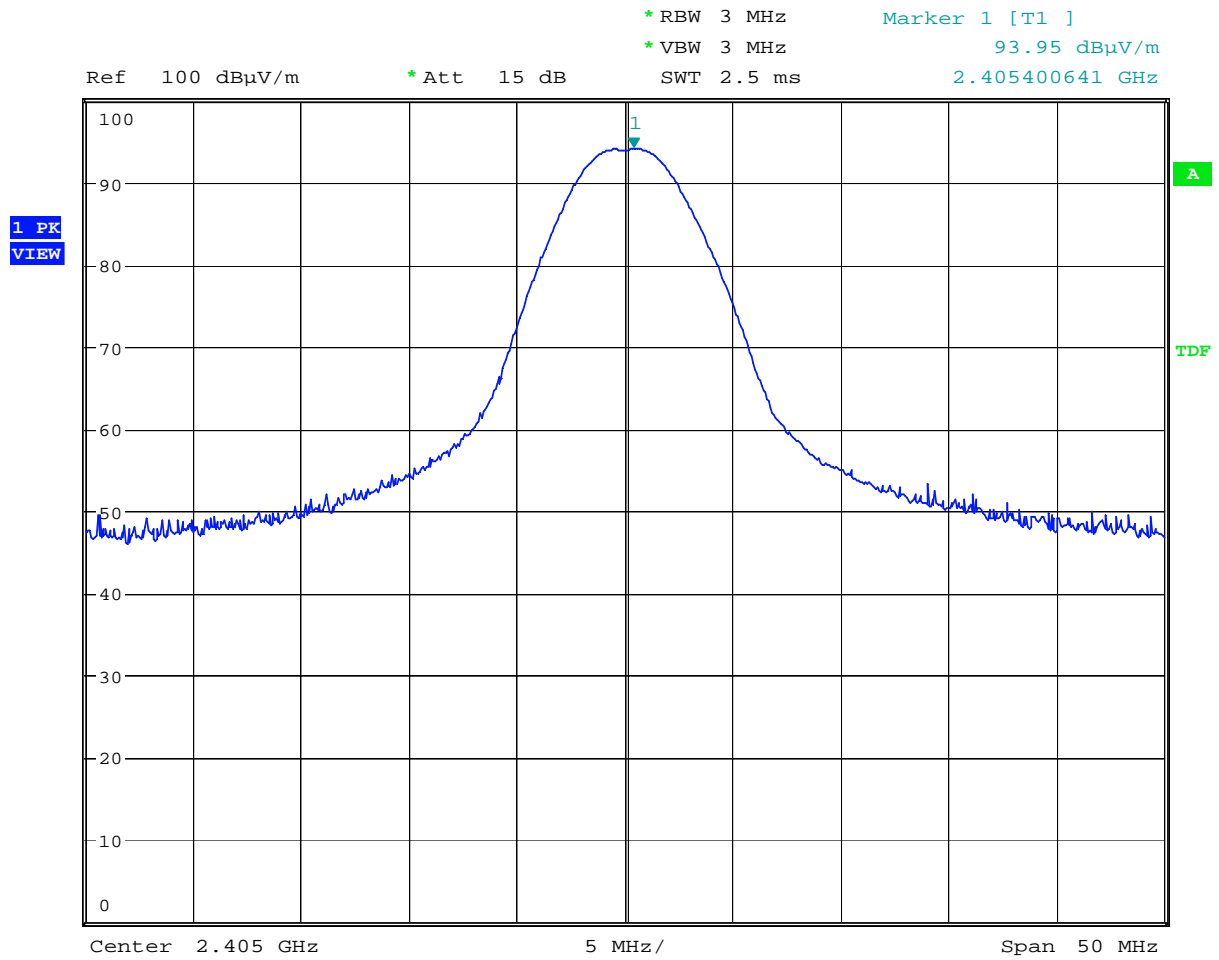

Date: 18.DEC.2009 14:18:23

Ch11 – Field strength

MARKER 1
2.440560897 GHz
Ref 100 dB μ V/m * Att 5 dB * RBW 3 MHz * VBW 3 MHz SWT 2.5 ms
Marker 1 [T1]
95.33 dB μ V/m
2.440560897 GHz

1 PK
VIEW

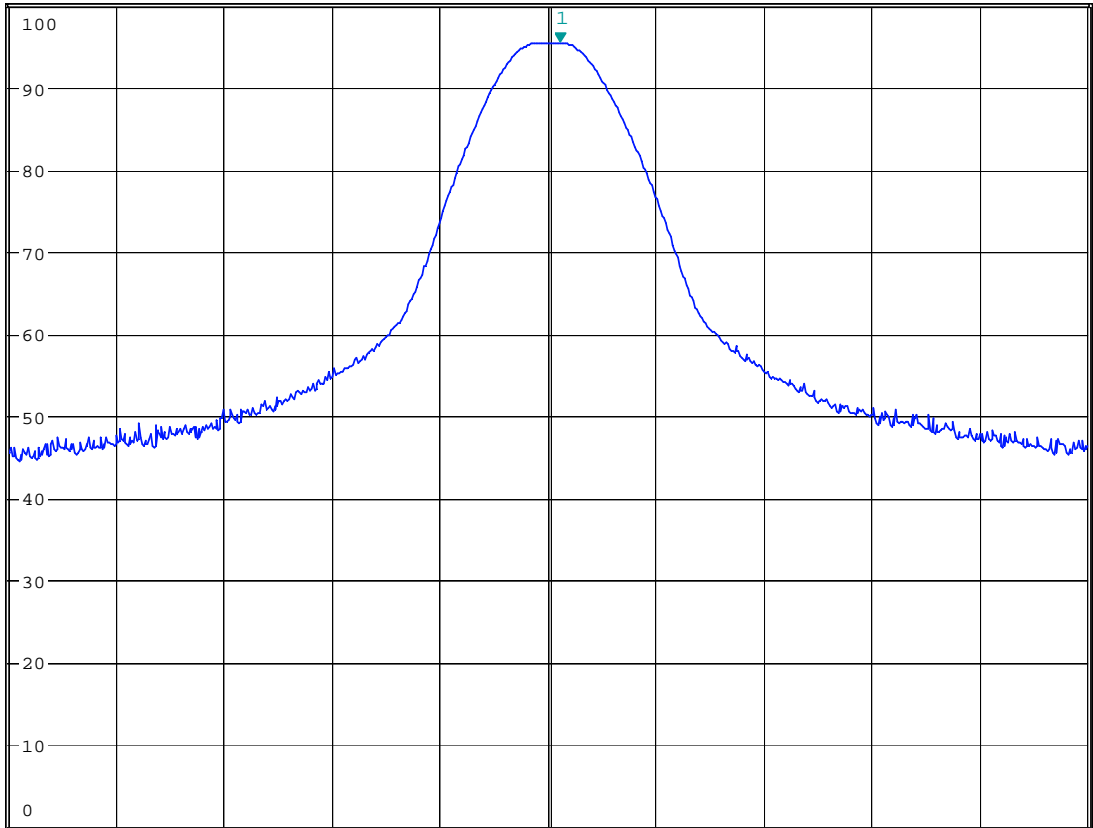

Center 2.44 GHz 5 MHz/ Span 50 MHz

Date: 18.DEC.2009 14:34:48

Ch18 – Field strength

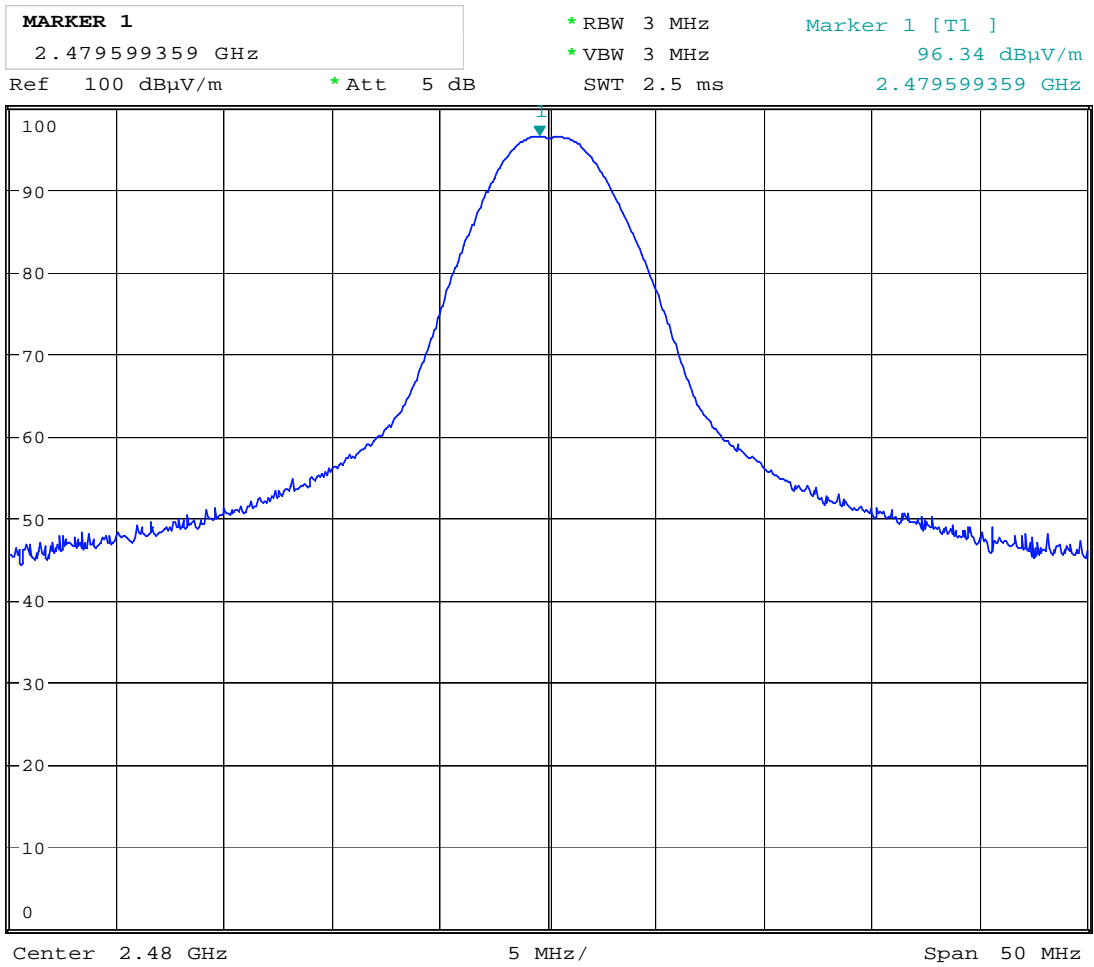

Date: 18.DEC.2009 14:42:32

Ch26 – Field strength

4.4 Spurious Emissions (Radiated)

Para. No.: 15.247 (c)

Test Performed By: G.Suwanthakumar	Date of Test: 18-Dec-2009
------------------------------------	---------------------------

Test Results: Complies

Measurement Data:

Lower Band-edge radiated measurements

Frequency	Power below nearest channel, dB		Limit	Margin
GHz	RF ch 11	DSS	dB	dB
2.4	40.11		-20	20.11

Band-edge field strength 2.4 GHz:

Marker Delta 100kHz RBW: 40.11dB

Peak Field Strength 93.95– 40.11 = 53.84 dB μ V/m

Average Field Strength: 53.84 dB μ V/m – 20* dB = 33.84 dB μ V/m

Upper Band-edge radiated measurements

Frequency	Power below nearest channel, dB		Limit	Margin
GHz	RF ch 26	DSS	dB	dB
2.4835	40.39		-20	20.39

Band-edge field strength 2.4835 GHz:

Marker Delta 100kHz RBW: 40.39dB

Peak Field Strength: 96.34– 40.39 = 55.95 dB μ V/m

Average Field Strength: 55.95 dB μ V/m – 20* dB = 35.95 dB μ V/m

* duty cycle correction

RF conducted emissions to 25 GHz

Maximum RF level outside operating band:

RF ch 11: 34.26 dBC, margin > 20 dB

RF ch 19: 37.58 dBC, margin > 20 dB

RF ch 26: 44.12 dBC, margin > 20 dB

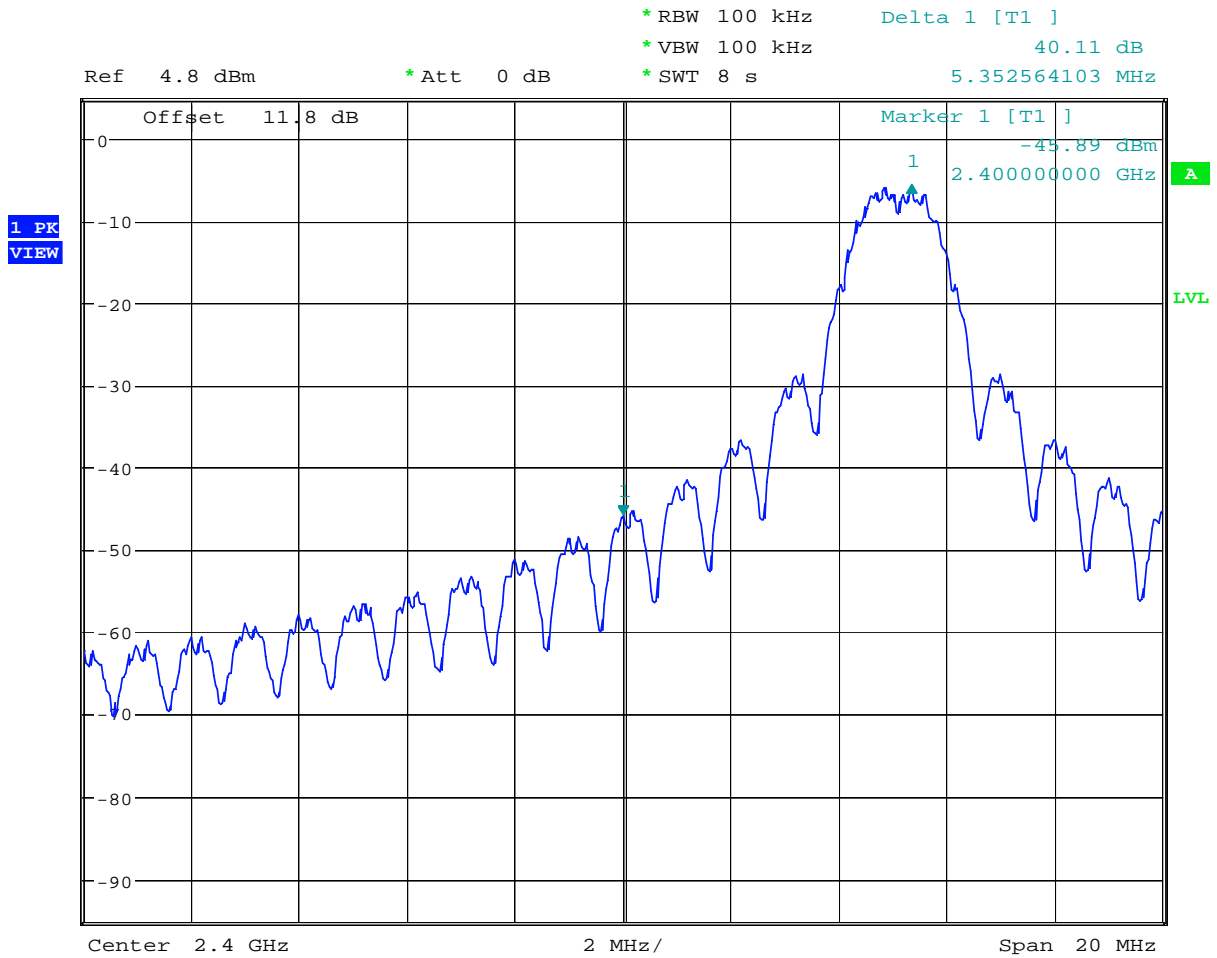

Date: 18.DEC.2009 12:15:01

Ch11 – Lower-band-edge – Delta-marker



*RBW 100 kHz Delta 1 [T1]
 *VBW 100 kHz 40.39 dB
 *SWT 8 s -3.680000000 MHz

Ref 0.9 dBm *Att 10 dB

1 PK
 VIEW

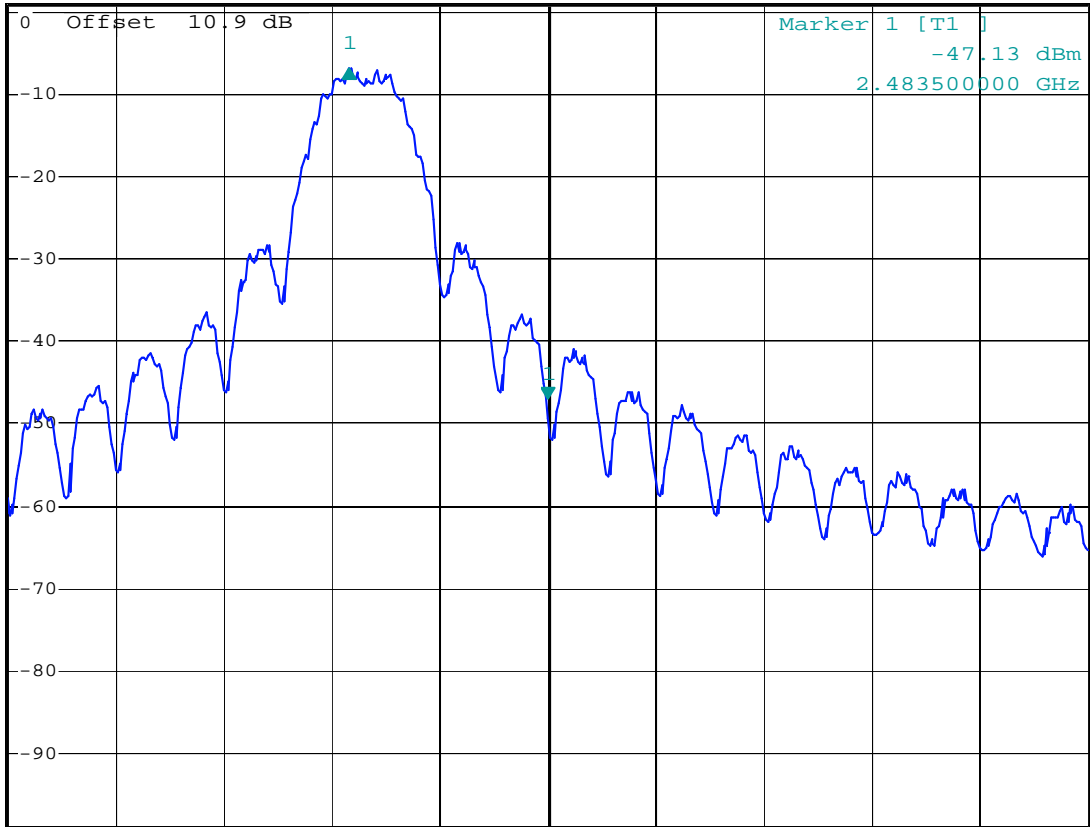

Center 2.4835 GHz 2 MHz/ Span 20 MHz

Date: 17.DEC.2009 14:13:16

Ch26 – Upper-band-edge – Delta-Marker



MARKER 1
 2.400008136 GHz
 Ref 0.9 dBm * Att 10 dB

* RBW 100 kHz Marker 1 [T1]
 * VBW 100 kHz -8.06 dBm
 * SWT 8 s 2.400008136 GHz

1 PK
 MAXH

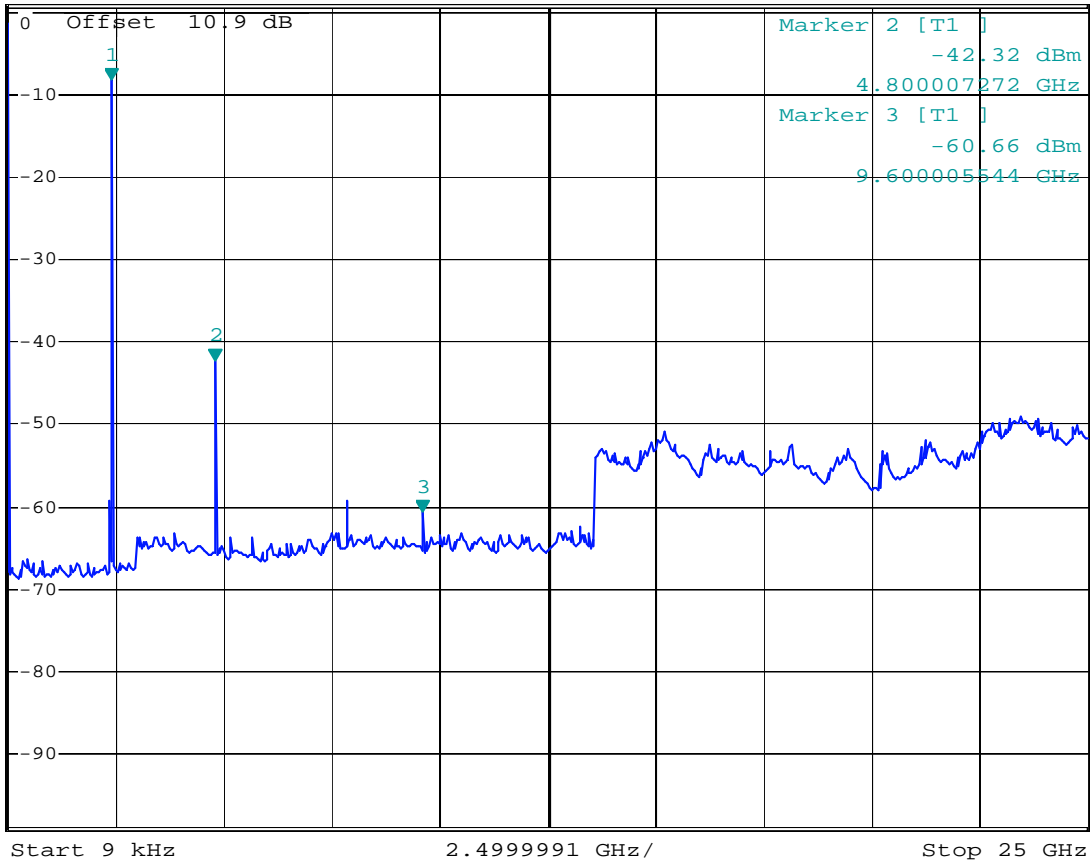

Date: 17.DEC.2009 14:18:02

Ch11 – Conducted Spurious – 9kHz – 25GHz



Ref 0.9 dBm * Att 10 dB * RBW 100 kHz Marker 1 [T1]
 * VBW 100 kHz -8.24 dBm
 * SWT 8 s 2.400008136 GHz

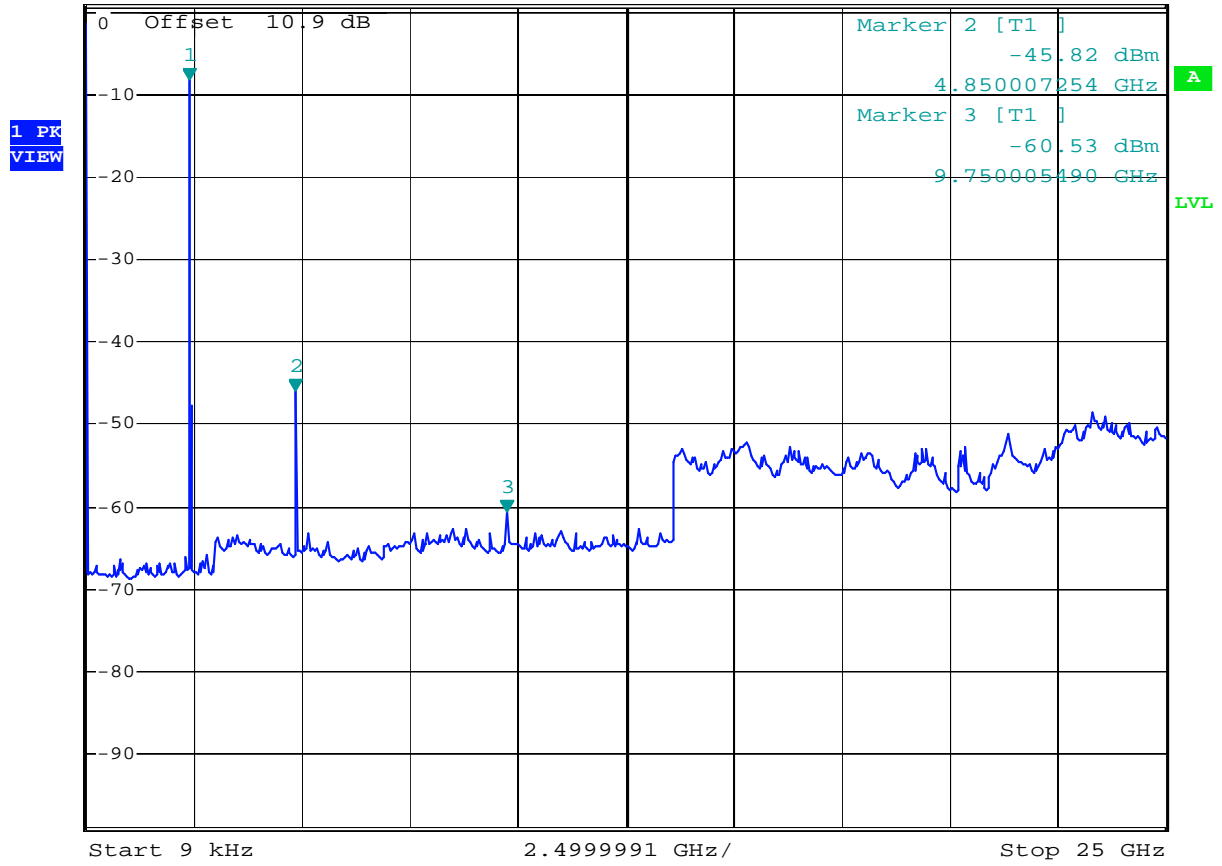

Date: 17.DEC.2009 14:16:54

Ch19 – Conducted Spurious – 9kHz – 25GHz



*RBW 100 kHz Marker 1 [T1]
 *VBW 100 kHz -8.71 dBm
 *SWT 8 s 2.450008118 GHz

Ref 0.9 dBm

*Att 10 dB

1 PK
VIEW

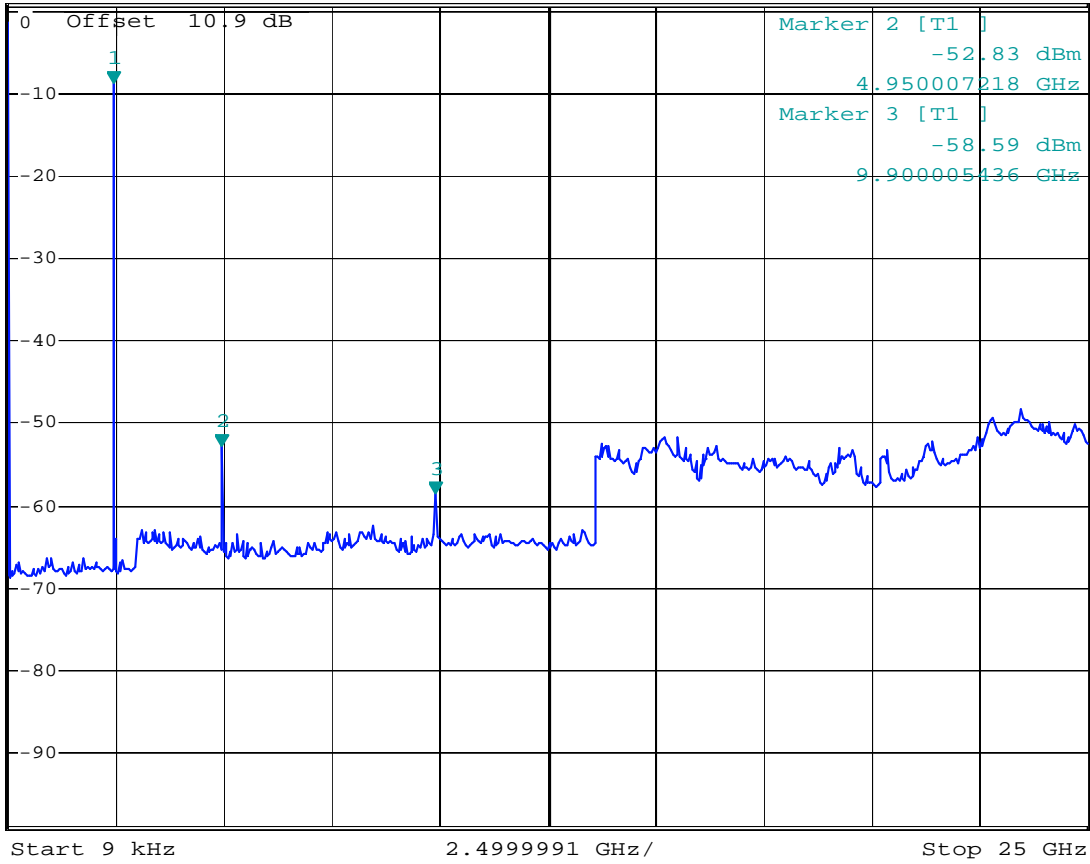

A

LVL

Date: 17.DEC.2009 14:14:27

Ch26 – Conducted Spurious – 9kHz – 25GHz

Duty Cycle Calculation:

RF duty cycle: Calculation according to RF burst Para 15.35 (c)

$$-20 \cdot \log(0.970\text{ms}/100\text{ms}) = 40.3 \text{ dB}$$

Maximum duty cycle according to Para 15.35 (b): 20 dB

This value is used to calculate Average field strength above 1 GHz from measured Peak value.

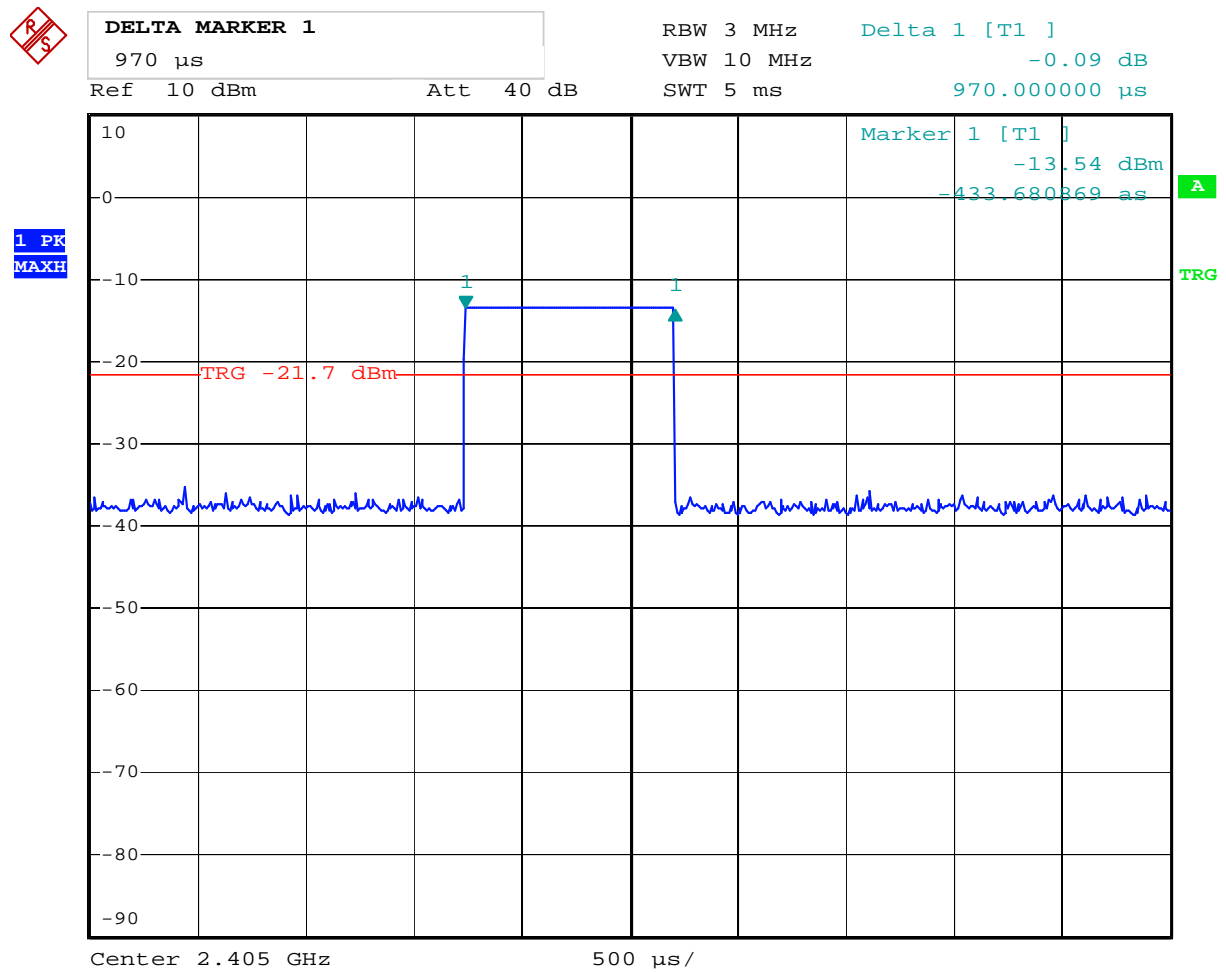

Date: 17.DEC.2009 12:58:28

Duty Cycle – ON-time



DELTA MARKER 1
 100 ms
 Ref 10 dBm Att 40 dB

RBW 3 MHz Delta 1 [T1]
 VBW 10 MHz 0.03 dB
 SWT 200 ms 100.000000 ms

1 PK
 MAXH

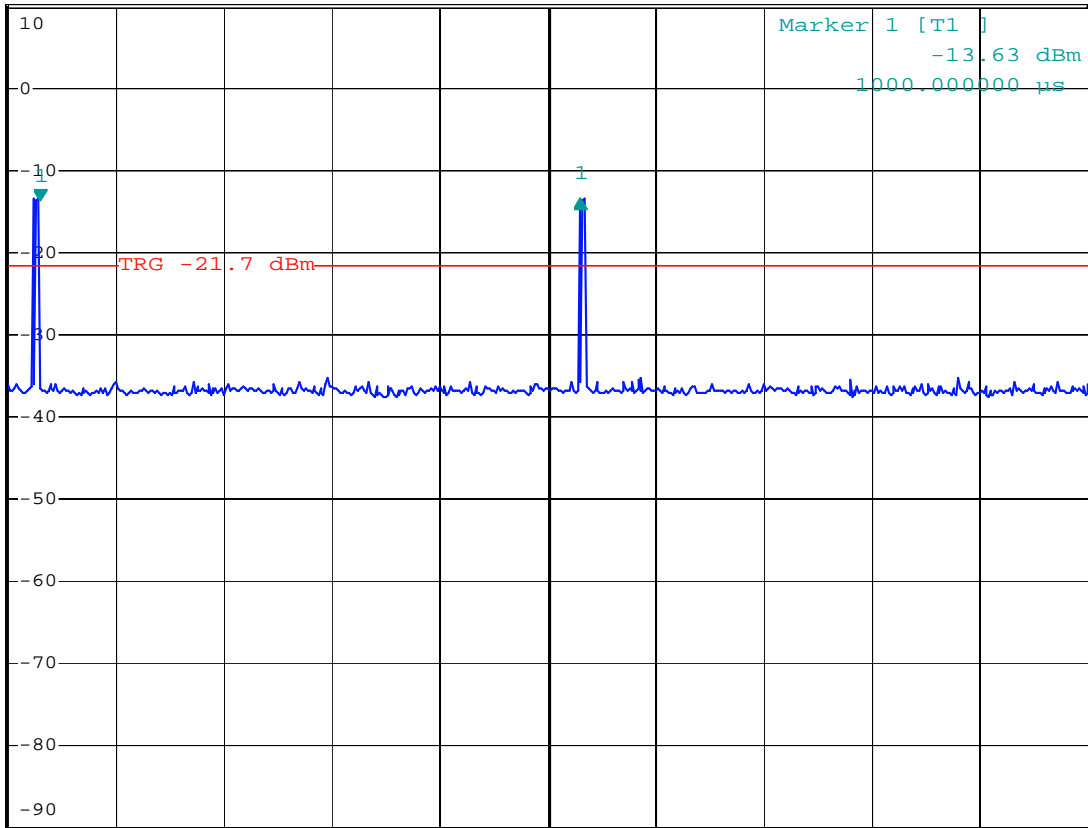

Center 2.405 GHz 20 ms /

Date: 17.DEC.2009 12:56:23

Duty Cycle – OFF time

Radiated Emissions with antenna, 1-25 GHz, peak

1-18 GHz measured at a distance of 3m, 18-25 GHz measured at 1m.

Measured with Peak Detector

Frequency	RF channel	Dist. corr. factor	Field strength, Peak, 3m	Duty cycle corr. factor	Limit	Margin
GHz	11-26	dB	dB μ V/m	dB	dB μ V/m	dB
4.811	11	0	55.60	-	74	18.4
4.879	18	0	56.19	-	74	17.81
4.959	26	0	59.28	-	74	14.72
5 - 25	11,18,26	0	None detected	-	-	-

Radiated emission with antenna, 1- 25 GHz, Average

Calculated value from Peak Detector

Frequency	RF channel	Dist. corr. factor	Field strength, Peak, 3 meters	Duty Cycle correction factor	Limit	Margin
GHz	11-26	dB	dB μ V/m	dB	dB μ V/m	dB
4.811	11	0	55.60	20	54	18.4
4.879	18	0	56.19	20	54	17.81
4.959	26	0	59.28	20	54	14.72
5 - 25	11,18,26	0	None detected	-	-	-

The maximum is observed in vertical polarization

Antenna factor, amplifier gain and cable loss are included in spectrum analyzer "Transducer factor".

Also radiated spurious emissions are checked with 50 ohm load and no spurious emissions detected.

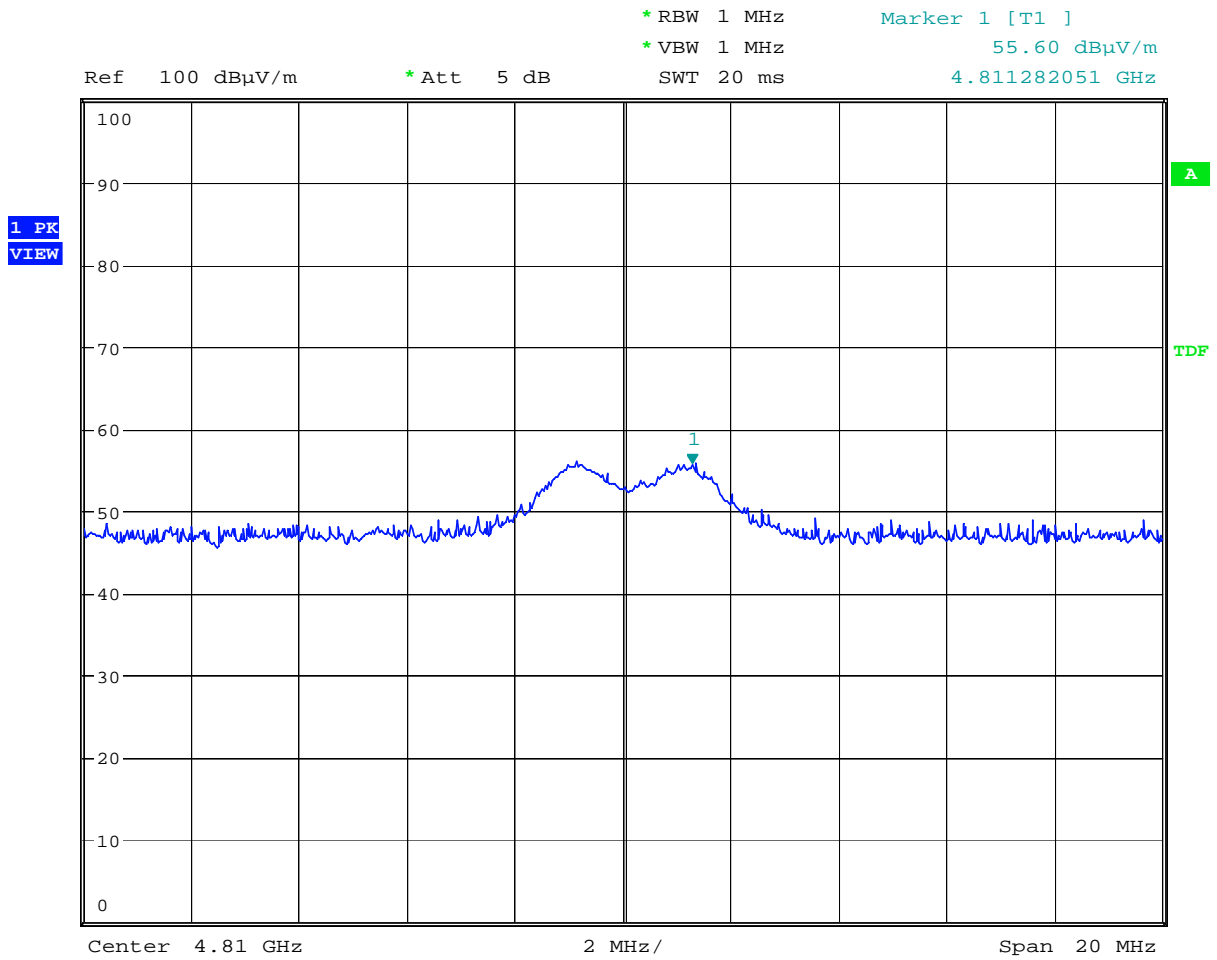

Date: 18.DEC.2009 14:32:34

Ch11 – 2nd harmonic

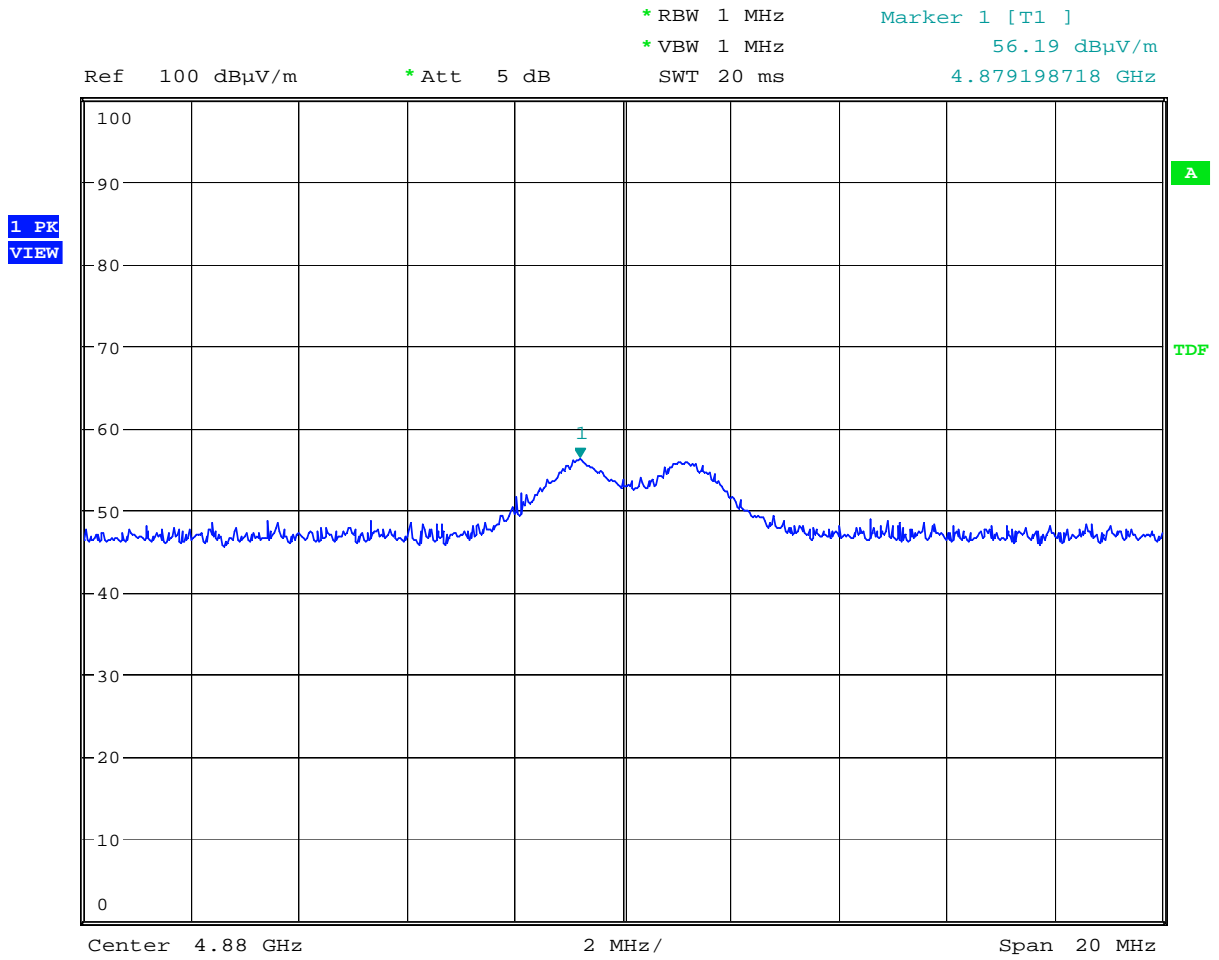

Date: 18.DEC.2009 14:40:38

Ch18 – 2nd Harmonic

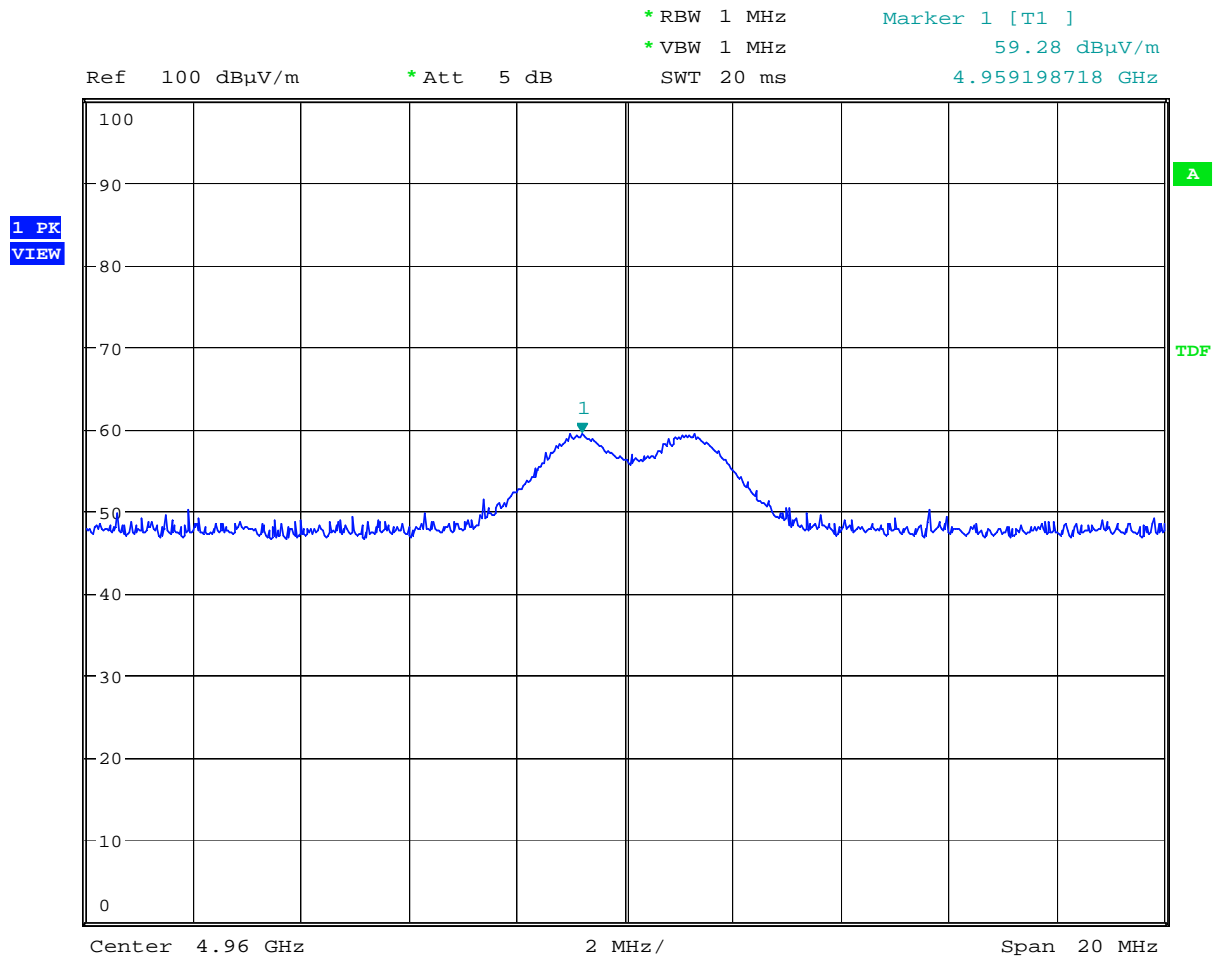

Date: 18.DEC.2009 14:48:20

Ch26 – 2nd Harmonic

Radiated emissions 30 – 1000 MHz.

Detector: Quasi-Peak

Measuring distance 3 m.

QP detector

Frequency	Operational condition	Field strength	Measuring distance	Polarization	Limit FCC15.209	Margin
MHz		dB μ V/m	m	-	dB μ V/m	dB
50.9	TX ON	13	3	VP	40.5	27.5
71.5	TX on	11	3	HP	40.5	29.5
112.1	TX ON	22	3	VP	43.5	21.5
135.9	TX on	20	3	VP	43.5	23.5
366.15	TX ON	35.8	3	VP	46	10.2

Nemko AS

18. Dec 09 10:28

Peak

Operator: gns
 Comment: 0490
 Atmel
 1m VP 3m distance
 FCC part:15.209

Scan Settings (1 Range)

Frequencies			Receiver Settings					
Start	Stop	Step	IF BW	Detector	M-T	In e Atten	Pream p	OpRge
30M	200M	50k	120k	PK	50ms	AUTO	LN ON	60dB

Transducer No.	Start	Stop	Name
11	30M	200M	HK116

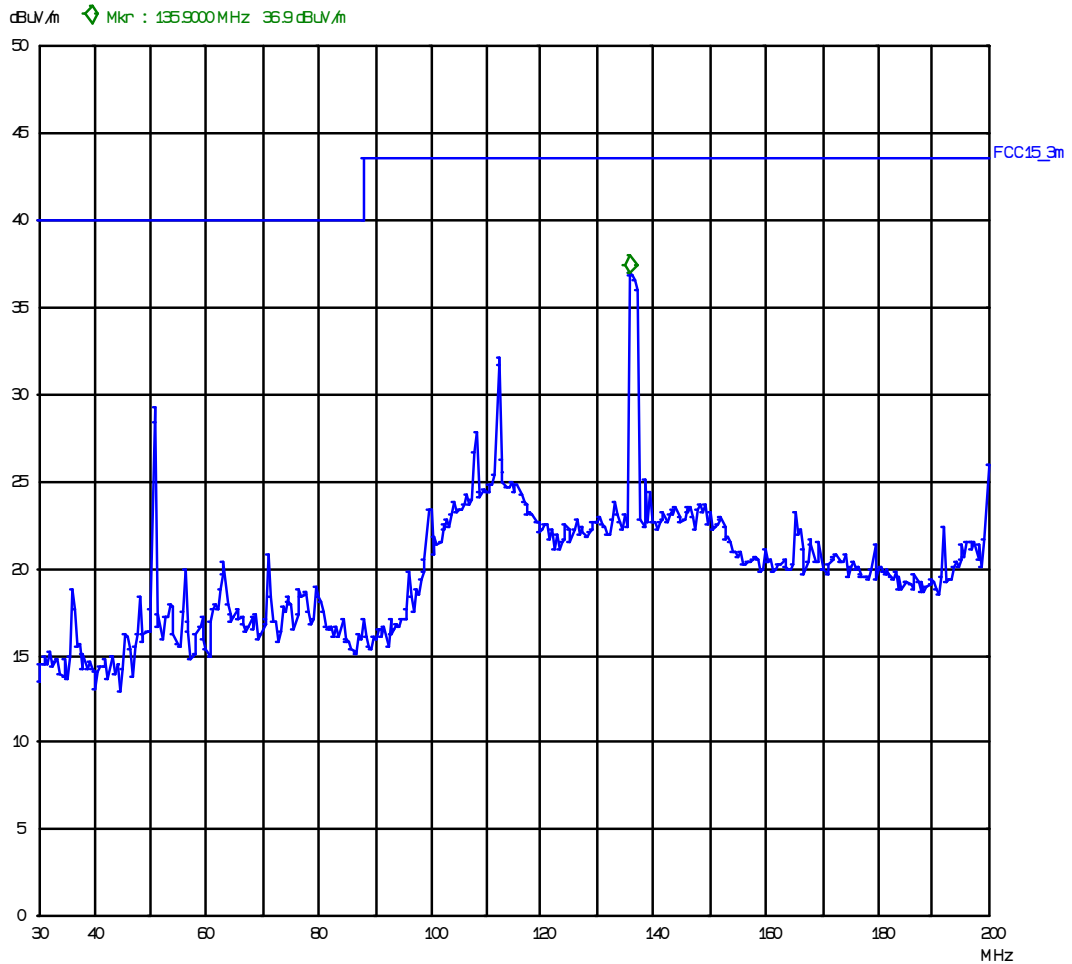

VP – 30 – 200 MHz

Nemko AS

18. Dec 09 10:37

Peak

Operator: gns
 Comment: 0490
 Atmel
 4m HP 3m distance
 FCC part:15.209

Scan Settings (1 Range)

Frequencies			Receiver Settings					
Start	Stop	Step	IF BW	Detector	M-T	In e Atten	Pream p	OpRge
30M	200M	50k	120k	PK	50ms	AUTO	LN ON	60dB

Transducer No.	Start	Stop	Name
11	30M	200M	HK116

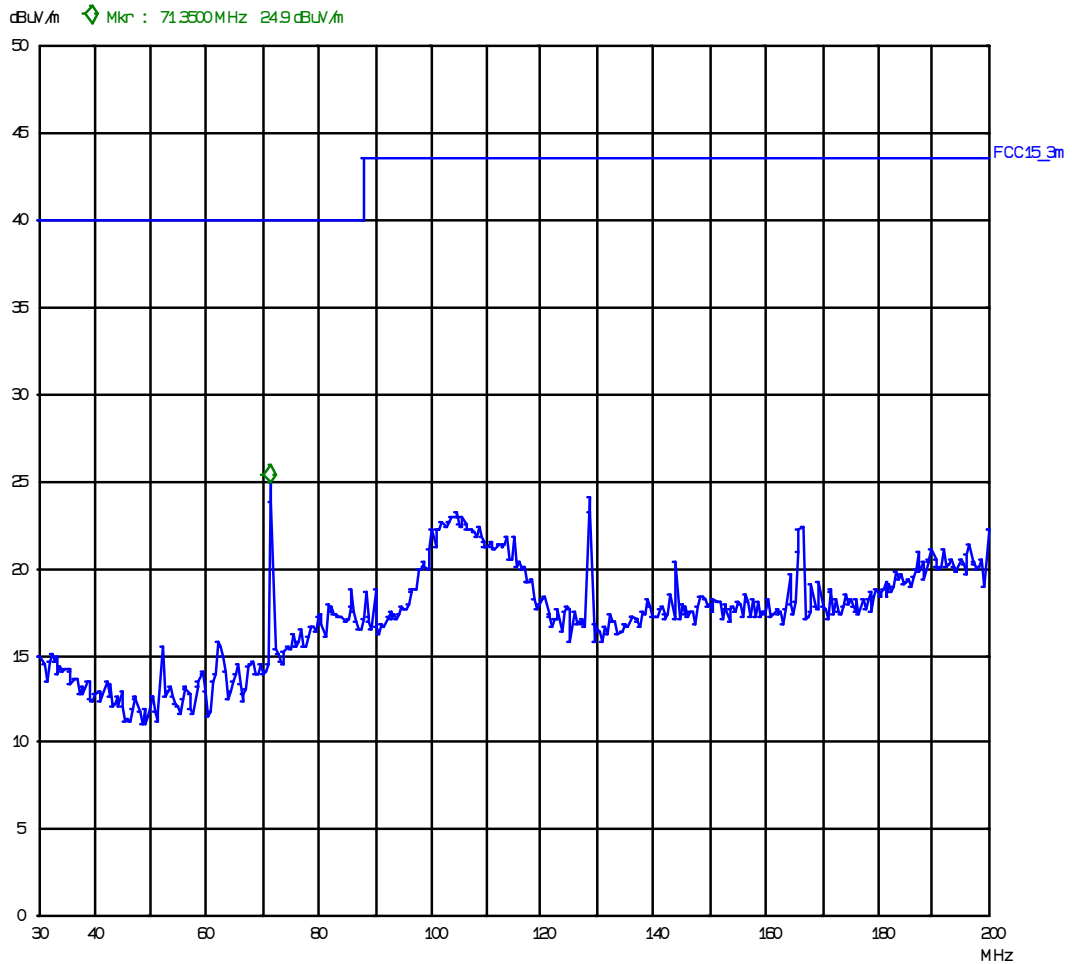

HP – 30 – 200MHz

Nemko AS

18. Dec 09 13:43

Peak

Operator: gns
 Comment: 0490
 Atmel
 1m VP 3m distance
 FCC part:15.209

Scan Settings (1 Range)

Frequencies			Receiver Settings					
Start	Stop	Step	IF BW	Detector	M-T	In e Atten	Pream p	OpRge
200M	1000M	200k	120k	PK	50ms	AUTO	LN ON	60dB

Transducer No.	Start	Stop	Name
21	200M	1000M	HL223HP

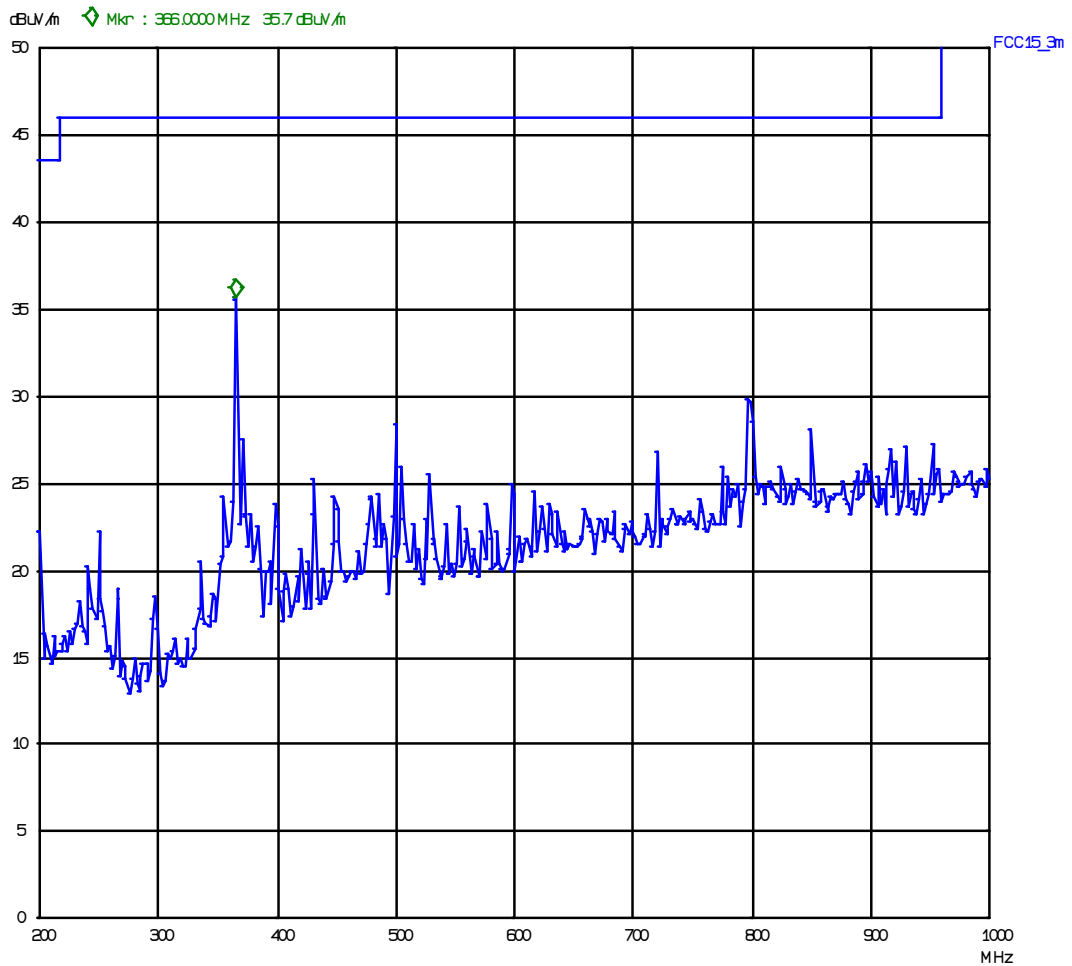

VP – 200 – 1000GHz

Nemko AS

18. Dec 09 12:34

Peak

Operator: gns
 Comment: 0490
 Atmel
 4m HP 3m distance
 FCC part:15.209

Scan Settings (1 Range)

Frequencies			Receiver Settings						
Start	Stop	Step	IF BW	Detector	M-T	Line	Atten	Preamp	OPRge
200M	1000M	50k	120k	PK	50ms	AUTO	LN	ON	60dB

Transducer No.	Start	Stop	Name
21	200M	1000M	HL223HP

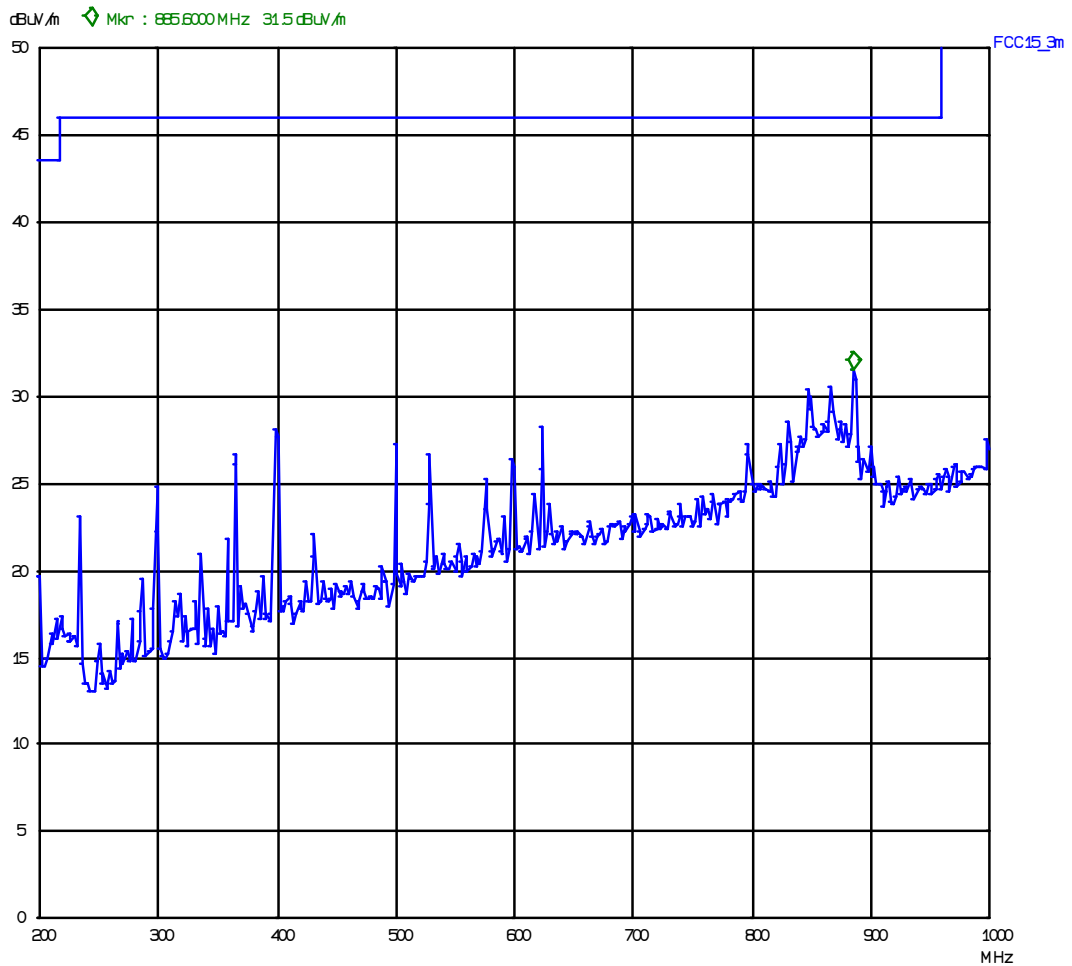

HP 200 – 1000MHz

4.5 Power Spectral Density (PSD)

Para. No.: 15.247 (d)

Test Performed By: G.Suwanthakumar

Date of Test: 18-Dec-2009

Test Results: Passed

Measured and Calculated Data:

Measured Conducted Values:

Ch11 - Lower Channel:

$$\text{PSD} = 35 - 53.76\text{dBm/Hz} = -18.76 \text{ dBm}$$

Ch18 - Middle Channel:

$$\text{PSD} = 35 - 52.89\text{dBm/Hz} = -17.89 \text{ dBm}$$

Ch 26 - Upper Channel:

$$\text{PSD} = 35 - 52.65\text{dBm/Hz} = -17.65 \text{ dBm}$$

The spectrum line spacing is less than 3kHz, therefore used noise power density and corrected 35 dB for 3kHz

Requirements:

The Power Spectral Density of a Digital Transmission System shall be no greater than +8 dBm in any 3kHz band

No requirements for Frequency Hopping Systems.

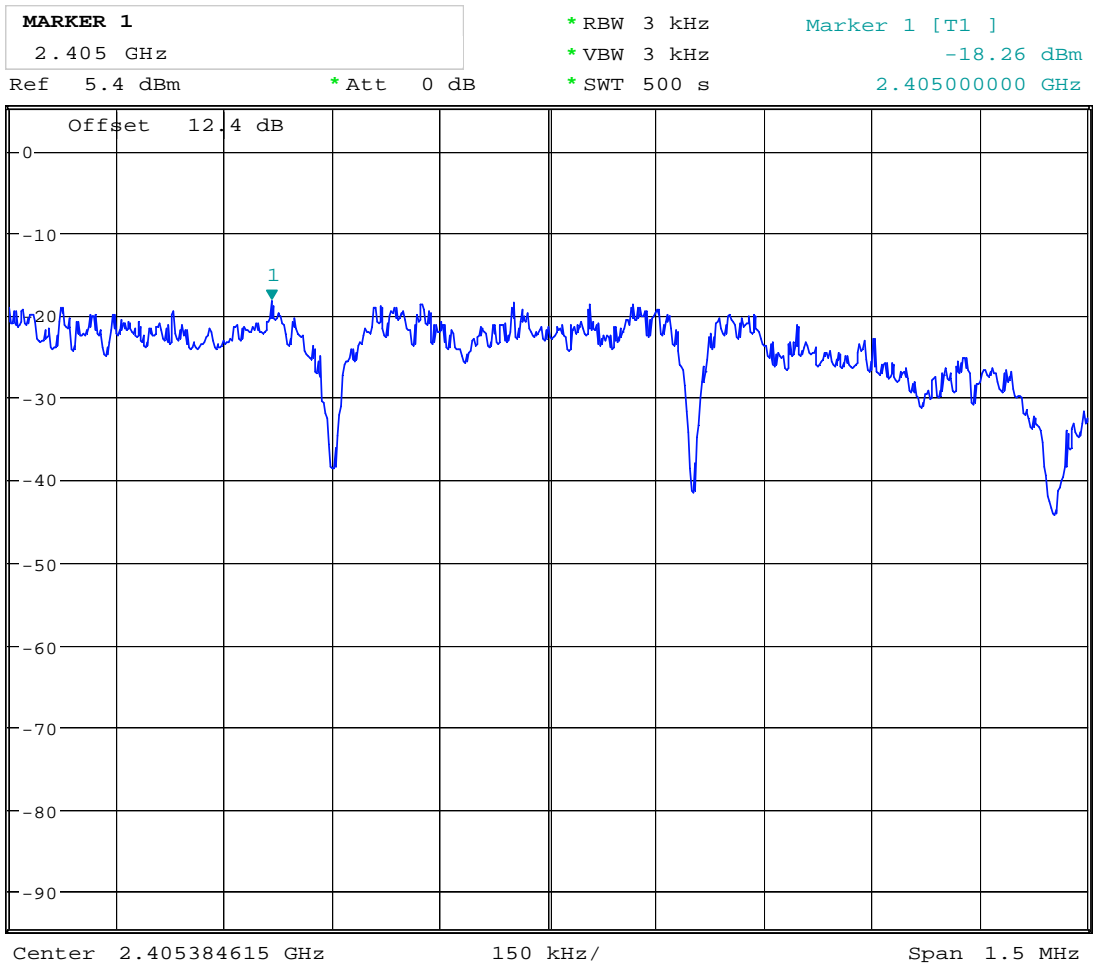

Date: 18.DEC.2009 12:25:06

Ch11 – Power Density – Conducted measurement

MARKER 1		* RBW 3 kHz	Marker 1 [T1]
2.44018109 GHz		* VBW 3 kHz	-17.89 dBm
Ref 5.4 dBm	* Att 0 dB	* SWT 500 s	2.440181090 GHz

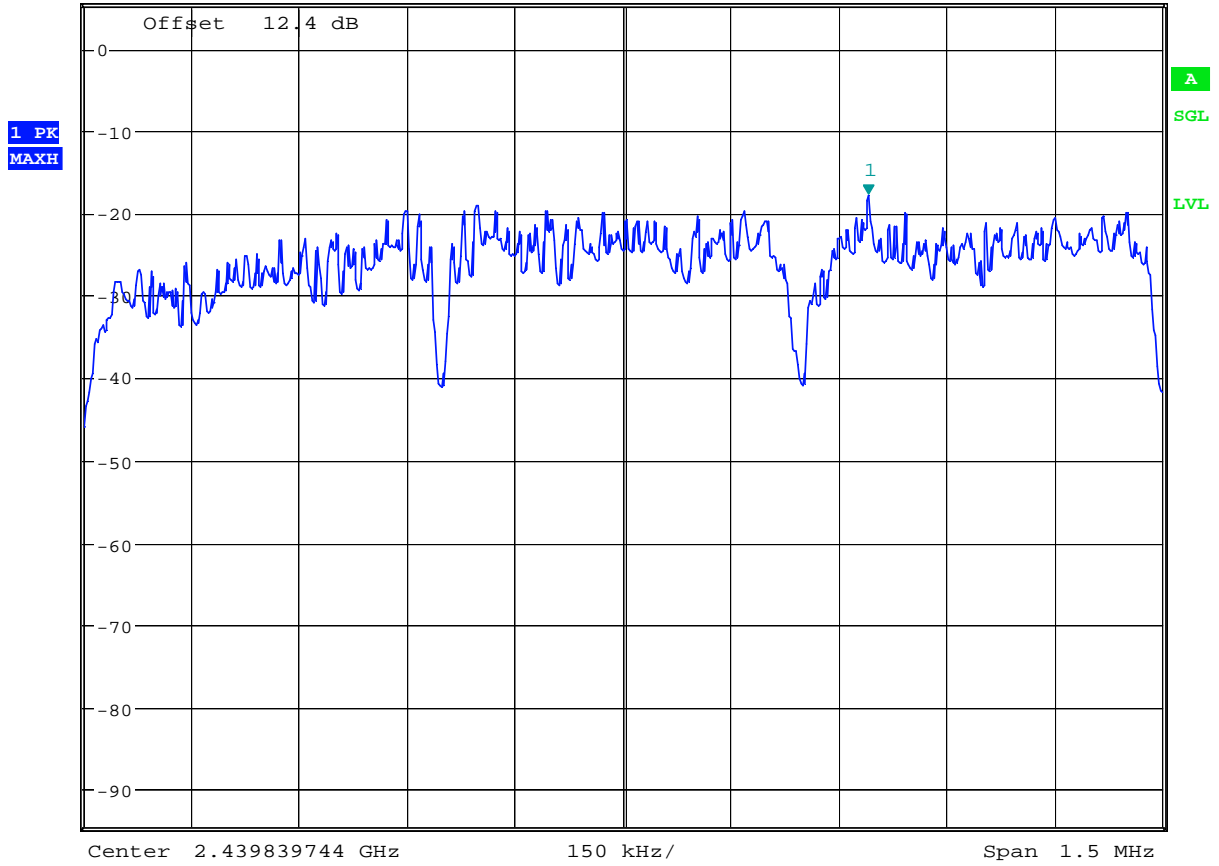

Date: 18.DEC.2009 12:34:37

Ch18 – Power Density – Conducted measurement

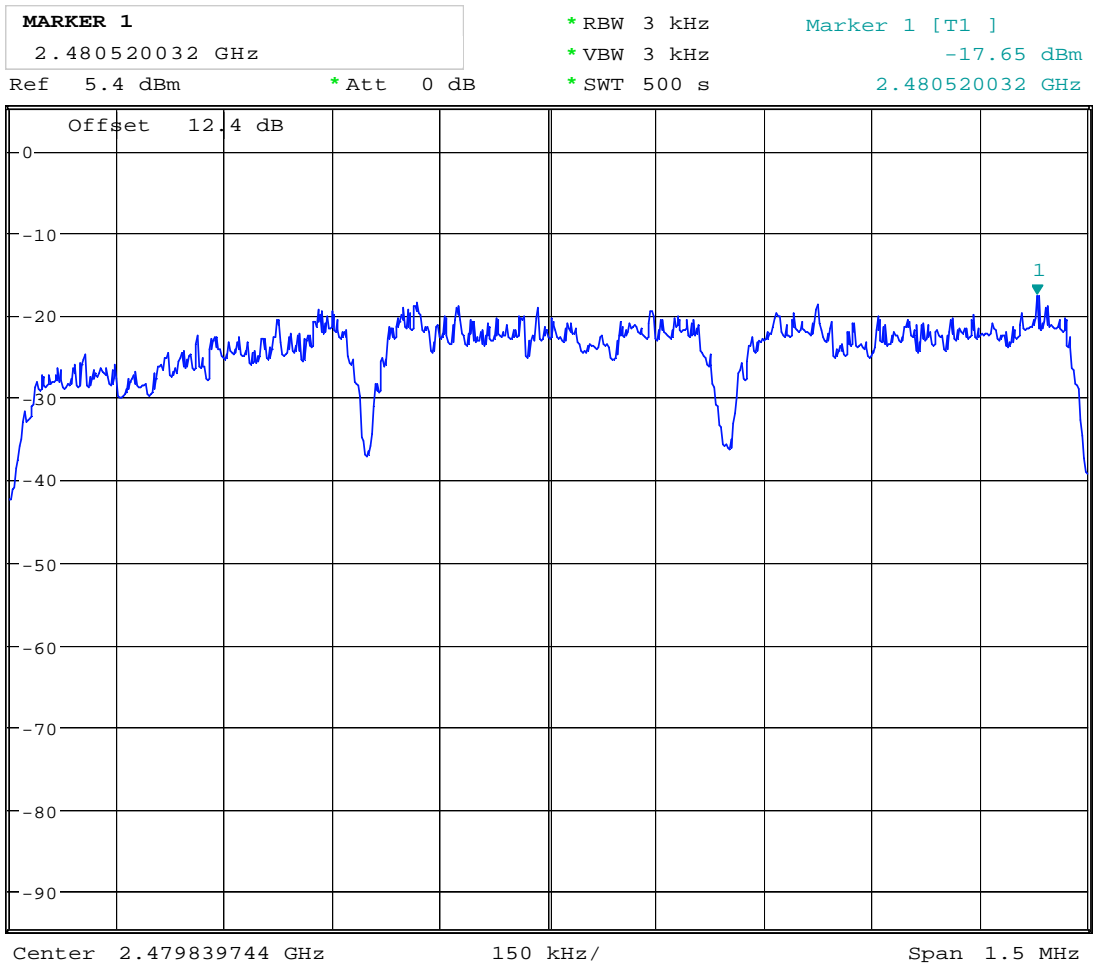

Date: 18.DEC.2009 12:44:57

Ch26 – Power Density – Conducted measurement

5 LIST OF TEST EQUIPMENT

To facilitate inclusion on each page of the test equipment used for related tests, each item of test equipment and ancillaries are identified (numbered) by the Test Laboratory.

No.	Instrument/ancillary	Type of instrument/ancillary	Manufacturer	Ref. no.
1	FSU26	Spectrum Analyzer	Rohde & Schwarz	LR 1504
2	ESN	EMI Receiver	Rohde & Schwarz	LR 1237
3	3115	Antenna horn	EMCO	LR 1330
4	643	Antenna horn	Narda	LR 093
5	642	Antenna horn	Narda	LR 220
6	PM7320X	Antenna horn	Sivers lab	LR 103
7	DBF-520-20	Antenna horn	Systron Donner	LR 101
8	638	Antenna horn	Narda	LR 098
9	Sucoflex 102E	Cable microwave	Suhner	LR 1370
10	6032A	Power supply	HP	LR 1062
11	ESH3-Z3	LISN	Rohde & Schwarz	LR 1076
12	8449B	Amplifier	Hewlett Packard	LR 1322
13	R3271	Spectrum Analyzer	Advantest	LR 1123
14	HFH2-Z2	Antenna loop	Rohde and Schwarz	LR 285
15	10855A	Amplifier	Hewlett Packard	LR 1445
16	HL223	Antenna log.per	Rohde & Schwarz	LR 1261
17	HK116	Antenna biconic	Rohde & Schwarz	LR 1260
18	ESVS 30	Test Receiver	Rohde & Schwarz	LR 1101
19	B32-10R	Power supply	Oltronix	LR 126
20	FSU26	Spectrum Analyzer	Rohde & Schwarz	LR 1504
21	U2000A	USB power meter	Agilent Technology	LR 1523

6 BLOCK DIAGRAM

6.1 System set up for radiated measurements

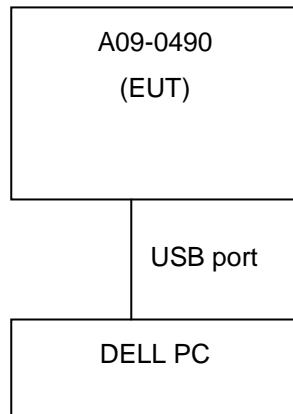

System set-up for power line conducted measurements

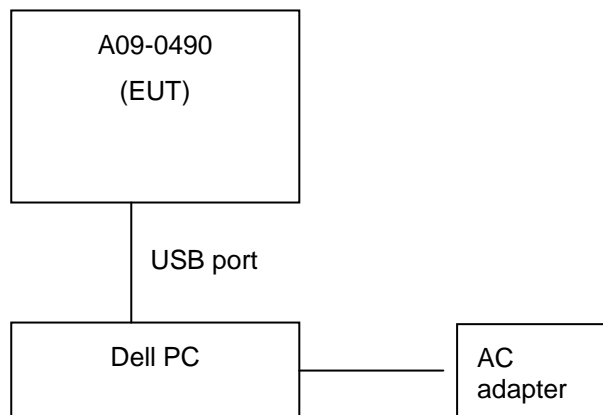

6.2 Test Site Radiated Emission

