



## TEST REPORT

Test report no.: 23-1-0061401T004a

BNetzA-CAB-02/21-102

### Testing laboratory

**cetecom advanced GmbH**  
Untertuerkheimer Strasse 6 – 10  
66117 Saarbruecken / Germany  
Phone: + 49 681 5 98 - 0  
Fax: + 49 681 5 98 - 9075  
Internet: <https://cetecomadvanced.com>  
e-mail: [mail@cetecomadvanced.com](mailto:mail@cetecomadvanced.com)

#### Accredited Testing Laboratory:

The testing laboratory (area of testing) is accredited according to DIN EN ISO/IEC 17025 (2018-03) by the Deutsche Akkreditierungsstelle GmbH (DAkkS). The accreditation is valid for the scope of testing procedures as stated in the accreditation certificate starting with the registration number: D-PL-12076-01.

### Applicant

**SAGEMCOM BROADBAND SAS**  
250, route de l' Empereur  
92848 Rueil-Malmaison Cedex / FRANCE  
Phone: -/-  
Contact: Benjamin Murindangabo  
e-mail: [benjamin.murindangabo-ext@sagemcom.com](mailto:benjamin.murindangabo-ext@sagemcom.com)

### Manufacturer

**SAGEMCOM BROADBAND SAS**  
250, route de l' Empereur  
92848 Rueil-Malmaison Cedex / FRANCE

### Test standard/s

FCC - Title 47 CFR Part 15    FCC - Title 47 of the Code of Federal Regulations; Chapter I; Part 15 - Radio frequency devices

For further applied test standards please refer to section 3 of this test report.

### Test Item

|                           |  |
|---------------------------|--|
| <b>Kind of test item:</b> | <b>Video Sound Box</b>   |
| <b>Model name:</b>        | <b>VSB3918 DISH</b>  |
| <b>FCC ID:</b>            | <b>VW3VSB3918D</b>   |
| <b>Frequency:</b>         | UNII bands: 5150 MHz to 5250 MHz; 5250 MHz to 5350 MHz; 5470 MHz to 5725 MHz; 5725 MHz to 5850 MHz |
| <b>Technology tested:</b> | WLAN   |
| <b>Antenna:</b>           | Two integrated antennas  |
| <b>Power supply:</b>      | 115 V AC by mains  |
| <b>Temperature range:</b> | 0°C to 40°C  |

This test report is electronically signed and valid without handwritten signature. For verification of the electronic signatures, the public keys can be requested at the testing laboratory.

### Test report authorized:

Michael Dorongovski  
Lab Manager  
Radio Labs

### Test performed:

Andreas Kurzkurt  
Testing Manager  
Radio Labs

## 1 Table of contents

|        |   |    |
|--------|---|----|
| 1      | Table of contents.....  | 2  |
| 2      | General information.....  | 4  |
| 2.1    | Notes and disclaimer .....  | 4  |
| 2.2    | Application details .....   | 4  |
| 2.3    | Test laboratories sub-contracted .....  | 4  |
| 3      | Test standard/s, references and accreditations .....                                    | 5  |
| 4      | Reporting statements of conformity – decision rule .....                                | 6  |
| 5      | Test environment.....   | 7  |
| 6      | Test item .....   | 7  |
| 6.1    | General description .....   | 7  |
| 6.2    | Additional information .....  | 7  |
| 7      | Description of the test setup.....  | 8  |
| 7.1    | Shielded semi anechoic chamber .....  | 9  |
| 7.2    | Shielded fully anechoic chamber.....  | 11 |
| 7.3    | Radiated measurements > 18 GHz .....  | 12 |
| 7.4    | AC conducted.....   | 13 |
| 7.5    | Conducted measurements with peak power meter & spectrum analyzer .....                  | 14 |
| 8      | Sequence of testing.....  | 15 |
| 8.1    | Sequence of testing radiated spurious 9 kHz to 30 MHz .....                             | 15 |
| 8.2    | Sequence of testing radiated spurious 30 MHz to 1 GHz.....                              | 16 |
| 8.3    | Sequence of testing radiated spurious 1 GHz to 18 GHz.....                              | 17 |
| 8.4    | Sequence of testing radiated spurious above 18 GHz.....                                 | 18 |
| 9      | Measurement uncertainty.....  | 19 |
| 10     | Summary of measurement results.....   | 20 |
| 11     | Additional comments.....  | 21 |
| 12     | Measurement results .....   | 28 |
| 12.1   | Identify worst case data rate.....  | 28 |
| 12.2   | Antenna gain .....  | 28 |
| 12.3   | Duty cycle.....   | 29 |
| 12.4   | Maximum output power.....   | 30 |
| 12.4.1 | Maximum output power according to FCC requirements.....                                 | 30 |
| 12.5   | Power spectral density .....  | 33 |
| 12.5.1 | Power spectral density according to FCC requirements.....                               | 33 |
| 12.6   | Minimum emission bandwidth for the band 5.725-5.85 GHz.....                             | 36 |
| 12.7   | Spectrum bandwidth / 26 dB bandwidth .....  | 39 |
| 12.8   | Occupied bandwidth / 99% emission bandwidth .....                                       | 42 |
| 12.9   | Undesirable emissions for transmitters operating in the 5725 MHz to 5850 MHz band ..... | 45 |
| 12.10  | Band edge compliance radiated .....   | 54 |
| 12.11  | Spurious emissions radiated below 30 MHz .....  | 69 |
| 12.12  | Spurious emissions radiated 30 MHz to 1 GHz .....                                       | 84 |
| 12.13  | Spurious emissions radiated 1 GHz to 40 GHz.....  | 88 |

|       |  |     |
|-------|--|-----|
| 12.14 | Spurious emissions conducted < 30 MHz .....        | 109 |
| 13    | Observations .....                                 | 112 |
| 14    | Glossary .....                                     | 112 |
| 15    | Document history .....                             | 113 |
| 16    | Accreditation Certificate – D-PL-12076-01-05 ..... | 113 |

## 2 General information

### 2.1 Notes and disclaimer

The test results of this test report relate exclusively to the test item specified in this test report. cetecom advanced GmbH does not assume responsibility for any conclusions and generalizations drawn from the test results with regard to other specimens or samples of the type of the equipment represented by the test item.

The test report may only be reproduced or published in full. Reproduction or publication of extracts from the report requires the prior written approval of cetecom advanced GmbH.

The testing service provided by cetecom advanced GmbH has been rendered under the current "General Terms and Conditions for cetecom advanced GmbH".

cetecom advanced GmbH will not be liable for any loss or damage resulting from false, inaccurate, inappropriate or incomplete product information provided by the customer.

Under no circumstances does the cetecom advanced GmbH test report include any endorsement or warranty regarding the functionality, quality or performance of any other product or service provided.

Under no circumstances does the cetecom advanced GmbH test report include or imply any product or service warranties from cetecom advanced GmbH, including, without limitation, any implied warranties of merchantability, fitness for purpose, or non-infringement, all of which are expressly disclaimed by cetecom advanced GmbH.

All rights and remedies regarding vendor's products and services for which cetecom advanced GmbH has prepared this test report shall be provided by the party offering such products or services and not by cetecom advanced GmbH.

In no case this test report can be considered as a Letter of Approval.

This test report is electronically signed and valid without handwritten signature. For verification of the electronic signatures, the public keys can be requested at the testing laboratory.

### 2.2 Application details

|                                    |            |
|------------------------------------|------------|
| Date of receipt of test item:      | 2023-06-21 |
| Start of test:*                    | 2023-07-17 |
| End of test:*                      | 2023-08-02 |
| Person(s) present during the test: | -/-        |

\*Date of each measurement, if not shown in the plot, can be requested. Dates are stored in the measurement software.

### 2.3 Test laboratories sub-contracted

None

### 3 Test standard/s, references and accreditations

| Test standard              | Date | Description   |
|----------------------------|------|---|
| FCC - Title 47 CFR Part 15 |      | FCC - Title 47 of the Code of Federal Regulations; Chapter I; Part 15 - Radio frequency devices |

| Guidance         | Version | Description   |
|------------------|---------|---|
| KDB 789033 D02   | v02r01  | Guidelines for Compliance Testing of Unlicensed National Information Infrastructure (U-NII) Devices - Part 15, Subpart E  |
| ANSI C63.4-2014  | -/-     | American National Standard for Methods of Measurement of Radio-Noise Emissions from Low-Voltage Electrical and Electronic Equipment in the Range of 9 kHz to 40 GHz |
| ANSI C63.10-2013 | -/-     | American National Standard of Procedures for Compliance Testing of Unlicensed Wireless Devices  |
| KDB 662911 D01   | v02r01  | Emissions Testing of Transmitters with Multiple Outputs in the Same Band  |

| Accreditation | Description |
|---------------|-------------|
|---------------|-------------|

D-PL-12076-01-05

Telecommunication FCC requirements  
<https://www.dakks.de/as/ast/d/D-PL-12076-01-05e.pdf>



ISED Testing Laboratory Recognized Listing Number: DE0001  
 FCC designation number: DE0002

#### 4 Reporting statements of conformity – decision rule

Only the measured values related to their corresponding limits will be used to decide whether the equipment under test meets the requirements of the test standards listed in chapter 3. The measurement uncertainty is mentioned in this test report, see chapter 9 but is not taken into account - neither to the limits nor to the measurement results. Measurement results with a smaller margin to the corresponding limits than the measurement uncertainty have a potential risk of more than 5% that the decision might be wrong."

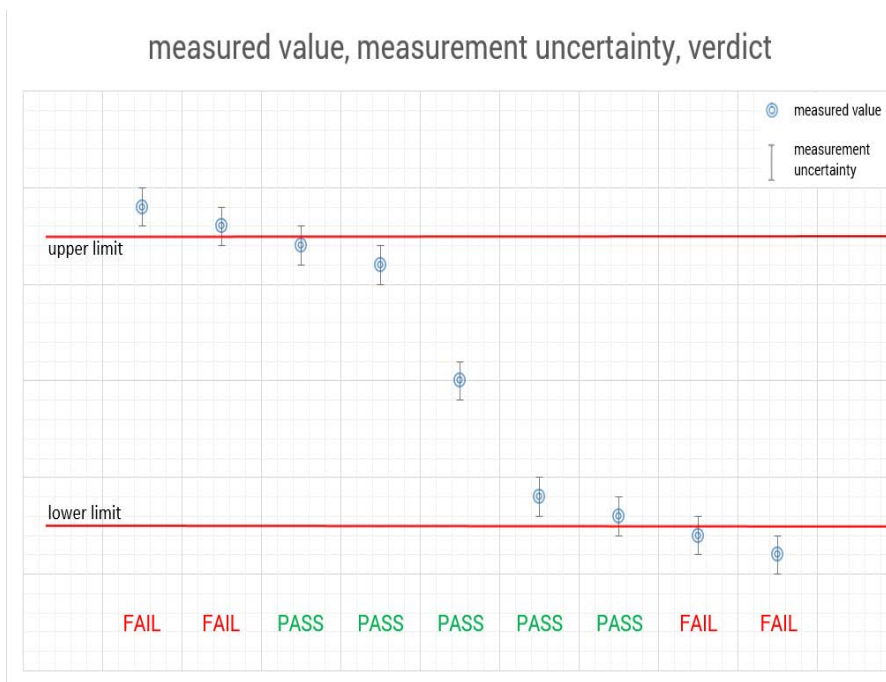



## 7 Description of the test setup

Typically, the calibrations of the test apparatus are commissioned to and performed by an accredited calibration laboratory. The calibration intervals are determined in accordance with the DIN EN ISO/IEC 17025. In addition to the external calibrations, the laboratory executes comparison measurements with other calibrated test systems or effective verifications. Weekly chamber inspections and range calibrations are performed. Where possible, RF generating and signaling equipment as well as measuring receivers and analyzers are connected to an external high-precision 10 MHz reference (GPS-based or rubidium frequency standard).

In order to simplify the identification of the equipment used at some special tests, some items of test equipment and ancillaries can be provided with an identifier or number in the equipment list below (Lab/Item).

Each block diagram listed can contain several test setup configurations. All devices belonging to a test setup are identified with the same letter syntax. For example: Column Setup and all devices with an A.

### **Agenda:** Kind of Calibration

|      |  |     |  |
|------|--|-----|--|
| k    | calibration / calibrated                   | EK  | limited calibration                                  |
| ne   | not required (k, ev, izw, zw not required) | zw  | cyclical maintenance (external cyclical maintenance) |
| ev   | periodic self verification                 | izw | internal cyclical maintenance                        |
| Ve   | long-term stability recognized             | g   | blocked for accredited testing                       |
| vlk! | Attention: extended calibration interval   |     |  |
| NK!  | Attention: not calibrated                  | *)  | next calibration ordered / currently in progress     |



## 7.1 Shielded semi anechoic chamber

The radiated measurements are performed in vertical and horizontal plane in the frequency range from 30 MHz to 1 GHz in semi-anechoic chambers. The EUT is positioned on a non-conductive support with a height of 0.80 m above a conductive ground plane that covers the whole chamber. The receiving antennas are conform to specifications ANSI C63. These antennas can be moved over the height range between 1.0 m and 4.0 m in order to search for maximum field strength emitted from EUT. The measurement distances between EUT and receiving antennas are indicated in the test setups for the various frequency ranges. For each measurement, the EUT is rotated in all three axes until the maximum field strength is received. The wanted and unwanted emissions are received by spectrum analyzers where the detector modes and resolution bandwidths over various frequency ranges are set according to requirement ANSI C63.

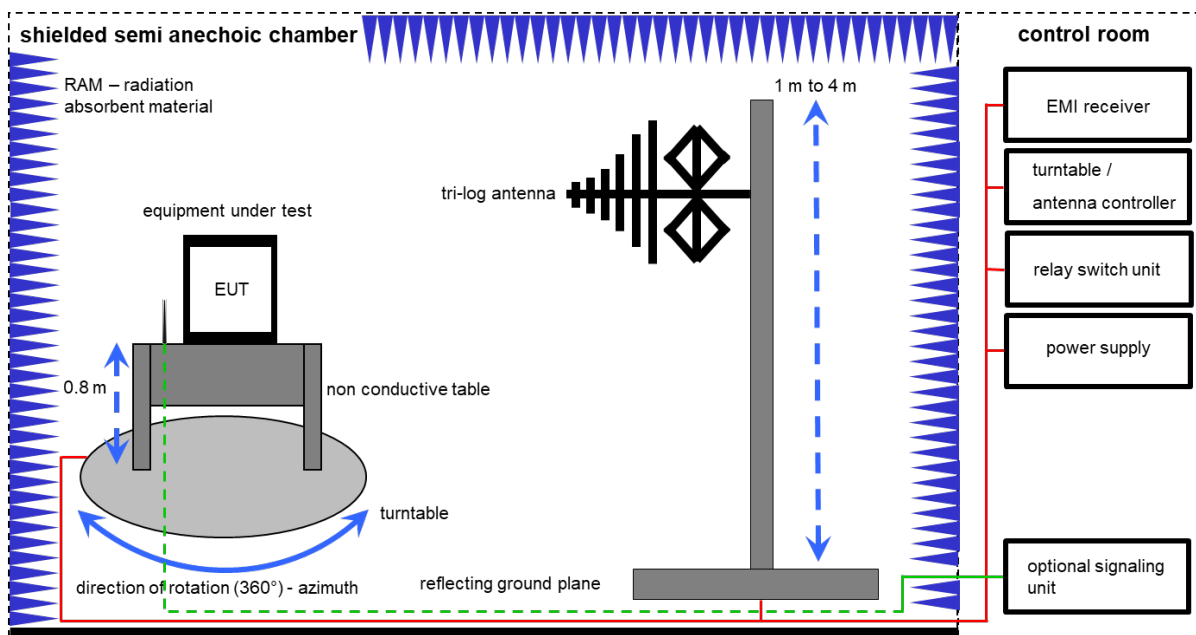

Measurement distance: tri-log antenna 10 meter  
EMC32 software version: 10.59.00

FS = UR + CL + AF

(FS-field strength; UR-voltage at the receiver; CL-loss of the cable; AF-antenna factor)

Example calculation:

FS [dB $\mu$ V/m] = 12.35 [dB $\mu$ V/m] + 1.90 [dB] + 16.80 [dB/m] = 31.05 [dB $\mu$ V/m] (35.69  $\mu$ V/m)

### Equipment table:

| No. | Setup | Equipment   | Type       | Manufacturer | Serial No.      | INV. No.  | Kind of Calibration | Last Calibration | Next Calibration |
|-----|-------|---|------------|--------------|-----------------|-----------|---------------------|------------------|------------------|
| 1   | A     | Switch-Unit                                       | 3488A      | HP           | 2719A14505      | 300000368 | ev                  | -/-              | -/-              |
| 2   | A     | Semi anechoic chamber                             | 3000023    | MWB AG       | -/-             | 300000551 | ne                  | -/-              | -/-              |
| 3   | A     | Analyzer-Reference-System (Harmonics and Flicker) | ARS 16/1   | SPS          | A3509 07/0 0205 | 300003314 | vKI!                | 29.12.2021       | 31.12.2023       |
| 4   | A     | Antenna Tower                                     | Model 2175 | ETS-Lindgren | 64762           | 300003745 | izw                 | -/-              | -/-              |
| 5   | A     | Positioning Controller                            | Model 2090 | ETS-Lindgren | 64672           | 300003746 | izw                 | -/-              | -/-              |

|    |   |  |              |                             |        |           |      |            |            |
|----|---|--|--------------|-----------------------------|--------|-----------|------|------------|------------|
| 6  | A | Turntable Interface-Box                      | Model 105637 | ETS-Lindgren                | 44583  | 300003747 | izw  | -/-        | -/-        |
| 7  | A | TRILOG Broadband Test-Antenna 30 MHz - 3 GHz | VULB9163     | Schwarzbeck Mess-Elektronik | 318    | 300003696 | vKI! | 30.09.2021 | 29.09.2023 |
| 8  | A | Turntable                                    | 2089-4.0     | EMCO                        | -/-    | 300004394 | ne   | -/-        | -/-        |
| 9  | A | PC   | TecLine      | F+W                         | -/-    | 300004388 | ne   | -/-        | -/-        |
| 10 | A | EMI Test Receiver                            | ESR3         | Rohde & Schwarz             | 102587 | 300005771 | k    | 09.12.2022 | 31.12.2023 |

## 7.2 Shielded fully anechoic chamber

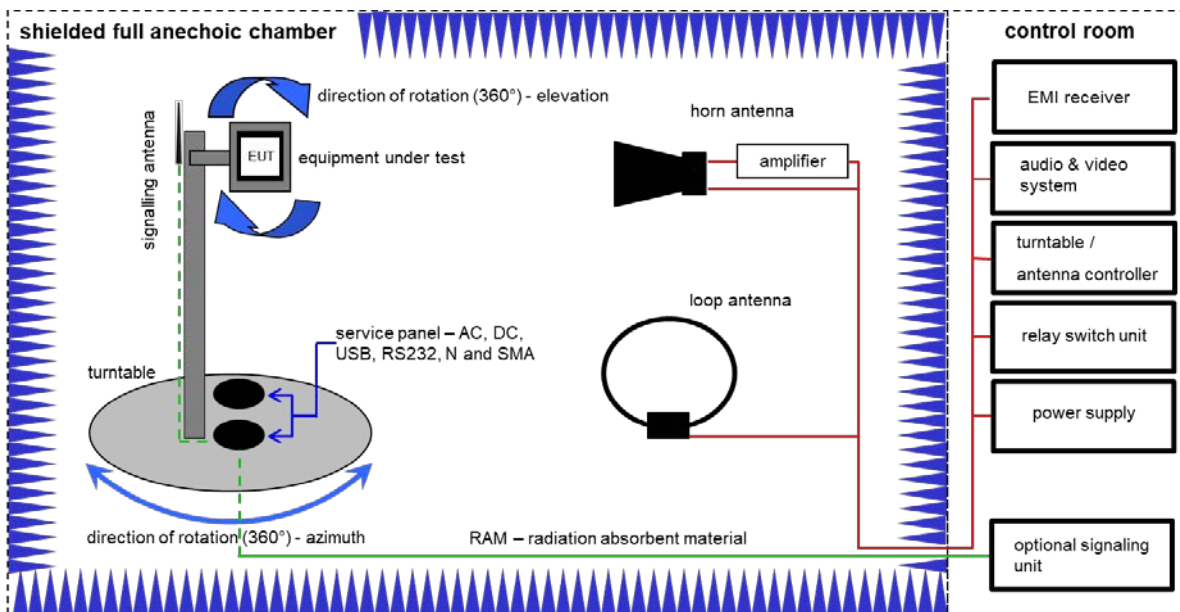

Measurement distance: horn antenna 3 meter; loop antenna 3 meter / 1 meter

$$FS = UR + CA + AF$$

(FS-field strength; UR-voltage at the receiver; CA-loss of the signal path; AF-antenna factor)

Example calculation:

$$FS [dB\mu V/m] = 40.0 [dB\mu V/m] + (-35.8) [dB] + 32.9 [dB/m] = 37.1 [dB\mu V/m] (71.61 \mu V/m)$$

Equipment table:

| No. | Setup   | Equipment                                      | Type                             | Manufacturer         | Serial No. | INV. No.  | Kind of Calibration | Last Calibration | Next Calibration |
|-----|---------|--|----------------------------------|----------------------|------------|-----------|---------------------|------------------|------------------|
| 1   | C       | Active Loop Antenna 9 kHz to 30 MHz            | 6502                             | EMCO                 | 2210       | 300001015 | vKI!                | 01.07.2021       | 31.07.2023       |
| 2   | A, B    | Double-Ridged Waveguide Horn Antenna 1-18.0GHz | 3115                             | EMCO                 | 8812-3088  | 300001032 |                     | 02.08.2021       | 31.08.2023       |
| 3   | A, B    | Highpass Filter                                | WHK1.1/15G-10SS                  | Wainwright           | 37         | 400000148 | ne                  | -/-              | -/-              |
| 4   | A, B    | Highpass Filter                                | WHKX7.0/18G-8SS                  | Wainwright           | 18         | 300003789 | ne                  | -/-              | -/-              |
| 5   | A, B    | Broadband Amplifier 0.5-18 GHz                 | CBLU5184540                      | CERNEX               | 22051      | 300004483 | ev                  | -/-              | -/-              |
| 6   | A, B, C | 4U RF Switch Platform                          | L4491A                           | Agilent Technologies | MY50000032 | 300004510 | ne                  | -/-              | -/-              |
| 7   | A, B, C | NEXIO EMV-Software                             | BAT EMC V2022.0.22.0             | Nexio                | -/-        | 300004682 | ne                  | -/-              | -/-              |
| 8   | A, B, C | Anechoic chamber                               | -/-                              | TDK                  | -/-        | 300003726 | ne                  | -/-              | -/-              |
| 9   | A, B, C | EMI Test Receiver 9kHz-26,5GHz                 | ESR26                            | Rohde & Schwarz      | 101376     | 300005063 | k                   | 13.12.2022       | 31.12.2023       |
| 10  | B       | Band Reject Filter                             | WRCJV12-5120-5150-5350-5380-40SS | Wainwright           | 5          | 300005168 | ev                  | -/-              | -/-              |
| 11  | B       | Band Reject Filter                             | WRCJV12-5695-5725-5850-5880-40SS | Wainwright           | 5          | 300005169 | ev                  | -/-              | -/-              |
| 12  | B       | Band Reject Filter                             | WRCJV16-5440-5470-5725-5755-40SS | Wainwright           | 9          | 300005170 | ev                  | -/-              | -/-              |
| 13  | A, B    | RF-Amplifier                                   | AMF-6F06001800-30-10P-R          | NARDA-MITEQ Inc      | 2011571    | 300005240 | ev                  | -/-              | -/-              |

NOTE: The radiated tests were finished before the 2023-07-31.

### 7.3 Radiated measurements > 18 GHz

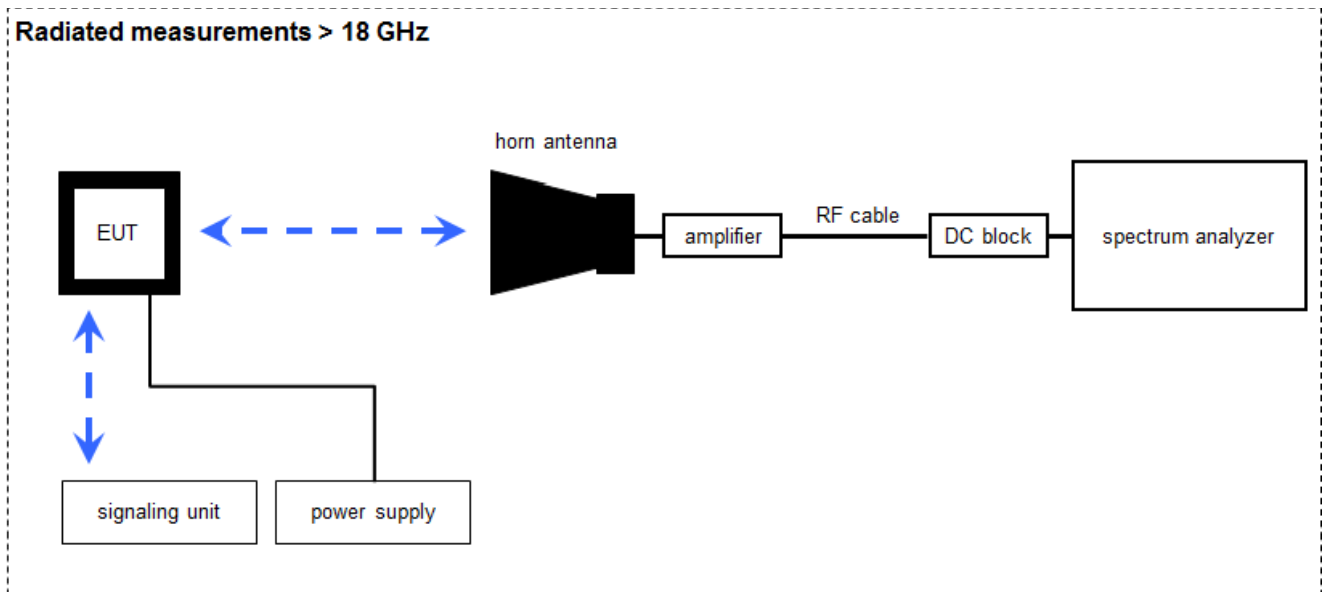

Measurement distance: horn antenna 50 cm

$$FS = UR + CA + AF$$

(FS-field strength; UR-voltage at the receiver; CA-loss signal path & distance correction; AF-antenna factor)

Example calculation:

$$FS [dB\mu V/m] = 40.0 [dB\mu V/m] + (-60.1) [dB] + 36.74 [dB/m] = 16.64 [dB\mu V/m] (6.79 \mu V/m)$$

**Equipment table:**

| No. | Setup | Equipment                                   | Type               | Manufacturer   | Serial No.       | INV. No.  | Kind of Calibration | Last Calibration | Next Calibration |
|-----|-------|---|--------------------|----------------|------------------|-----------|---------------------|------------------|------------------|
| 1   | A     | Microwave System Amplifier, 0.5-26.5 GHz    | 83017A             | HP             | 00419            | 300002268 | ev                  | -/-              | -/-              |
| 2   | A     | Std. Gain Horn Antenna 18.0-26.5 GHz        | 638                | Narda          | 01096            | 300000486 | vKI!                | 17.01.2022       | 31.01.2024       |
| 3   | A     | Std. Gain Horn Antenna 26.5-40.0 GHz        | V637               | Narda          | 82-16            | 300000510 | vKI!                | 17.01.2022       | 31.01.2024       |
| 4   | A     | Broadband Low Noise Amplifier 18-50 GHz     | CBL18503070-XX     | CERNEX         | 19338            | 300004273 | ev                  | -/-              | -/-              |
| 5   | A     | Signal analyzer                             | FSV40              | Rohde&Schwarz  | 101353           | 300004819 | k                   | 08.12.2022       | 31.12.2023       |
| 6   | A     | Signal- and Spectrum Analyzer 2 Hz - 50 GHz | FSW50              | Rohde&Schwarz  | 101560           | 300006179 | k                   | 04.04.2023       | 30.04.2024       |
| 7   | A     | RF-Cable                                    | ST18/SMAm/SMAm /48 | Huber & Suhner | Batch no. 600918 | 400001182 | ev                  | -/-              | -/-              |
| 8   | A     | DC-Blocker 0.1-40 GHz                       | 8141A              | Inmet          | -/-              | 400001185 | ev                  | -/-              | -/-              |

## 7.4 AC conducted

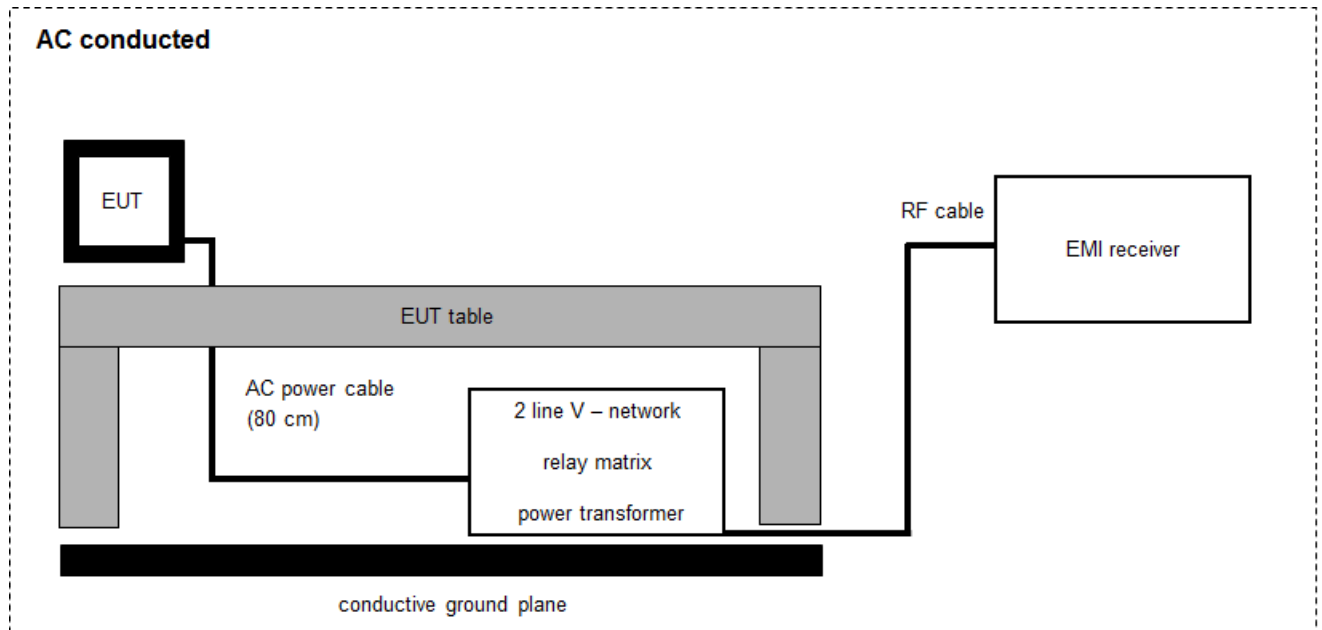

$$FS = UR + CF + VC$$

(FS-field strength; UR-voltage at the receiver; CR-loss of the cable and filter; VC-correction factor of the ISN)

Example calculation:

$$FS [dB\mu V/m] = 37.62 [dB\mu V/m] + 9.90 [dB] + 0.23 [dB] = 47.75 [dB\mu V/m] (244.06 \mu V/m)$$

**Equipment table:**

| No. | Setup | Equipment                                 | Type    | Manufacturer    | Serial No. | INV. No.  | Kind of Calibration | Last Calibration | Next Calibration |
|-----|-------|---|---------|-----------------|------------|-----------|---------------------|------------------|------------------|
| 1   | A     | Two-line V-Network (LISN) 9 kHz to 30 MHz | ESH3-Z5 | Rohde & Schwarz | 892475/017 | 300002209 | vIK!                | 14.12.2021       | 31.12.2023       |
| 2   | A     | RF-Filter-section                         | 85420E  | HP              | 3427A00162 | 300002214 | NK!                 | -/-              | -/-              |
| 3   | A     | Hochpass 150 kHz                          | EZ-25   | R&S             | 100010     | 300003798 | ev                  | -/-              | -/-              |
| 4   | A     | PC  | TecLine | F+W             | -/-        | 300003532 | ne                  | -/-              | -/-              |
| 5   | A     | EMI Test Receiver 3.6 GHz                 | ESR3    | Rohde & Schwarz | 102981     | 300006318 | k                   | 09.12.2022       | 31.12.2023       |

## 7.5 Conducted measurements with peak power meter & spectrum analyzer

### Conducted measurements normal conditions

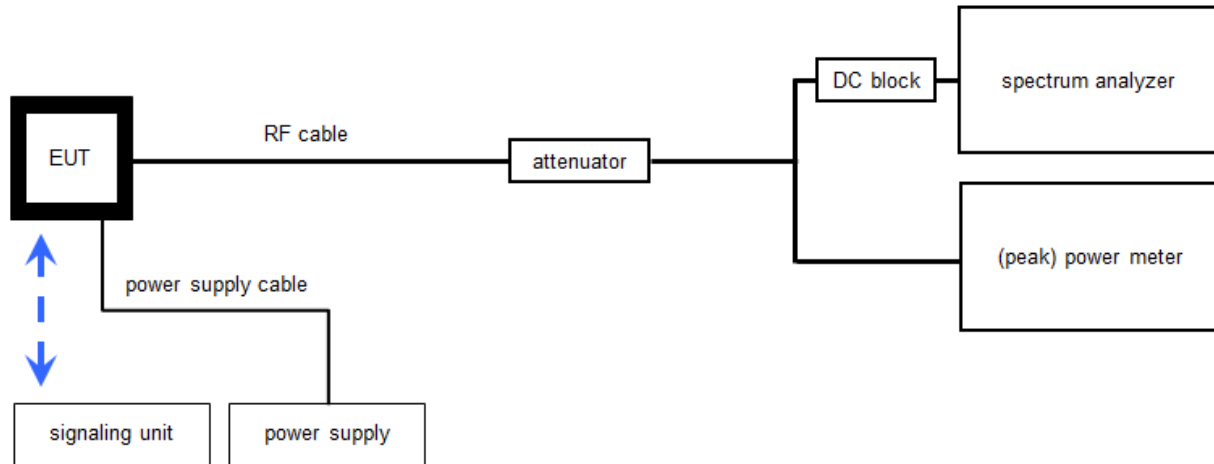

WLAN tester version: 1.1.13; LabView2015

OP = AV + CA  
 (OP-output power; AV-analyzer value; CA-loss signal path)

#### Example calculation:

OP [dBm] = 6.0 [dBm] + 11.7 [dB] = 17.7 [dBm] (58.88 mW)

#### Equipment table:

| No. | Setup | Equipment   | Type                                  | Manufacturer      | Serial No.       | INV. No.  | Kind of Calibration | Last Calibration | Next Calibration |
|-----|-------|---|---------------------------------------|-------------------|------------------|-----------|---------------------|------------------|------------------|
| 1   | A, B  | Isolating Transformer                                 | RT5A                                  | Grundig           | 12780            | 300001166 | ev                  | -/-              | -/-              |
| 2   | A     | Signal analyzer                                       | FSV40                                 | Rohde&Schwarz     | 101042           | 300004517 | k                   | 12.12.2022       | 31.12.2023       |
| 3   | A, B  | PC Tester R005  | Intel Core i3 3220/3,3 GHz, Prozessor | -/-               | 2V2403033A45 23  | 300004589 | ne                  | -/-              | -/-              |
| 4   | A, B  | RF-Cable  | ST18/SMAm/SMAm /60                    | Huber & Suhner    | Batch no. 606844 | 400001181 | ev                  | -/-              | -/-              |
| 5   | A, B  | DC-Blocker 0.1-40 GHz                                 | 8141A                                 | Inmet             | -/-              | 400001185 | ev                  | -/-              | -/-              |
| 6   | A, B  | Coax Attenuator 10 dB 2W 0-40 GHz                     | MCL BW-K10-2W44+                      | Mini Circuits     | -/-              | 400001186 | ev                  | -/-              | -/-              |
| 7   | A, B  | Tester Software RadioStar (C.BER2 for BT Conformance) | Version 1.0.0.X                       | CTC advanced GmbH | 0001             | 400001380 | ne                  | -/-              | -/-              |

## 8 Sequence of testing

### 8.1 Sequence of testing radiated spurious 9 kHz to 30 MHz

#### Setup

- The equipment is set up to simulate normal operation mode as described in the user manual or defined by the manufacturer.
- If the EUT is a tabletop system, it is placed on a table with 0.8 m height.
- If the EUT is a floor standing device, it is placed directly on the turn table.
- Auxiliary equipment and cables are positioned to simulate normal operation conditions as described in ANSI C 63.4.
- The AC power port of the EUT (if available) is connected to a power outlet below the turntable.
- Measurement distance is 3 m (see ANSI C 63.4) – see test details.
- EUT is set into operation.

#### Premeasurement\*

- The turntable rotates from 0° to 315° using 45° steps.
- The antenna height is 1 m.
- At each turntable position the analyzer sweeps with positive-peak detector to find the maximum of all emissions.

#### Final measurement

- Identified emissions during the pre-measurement are maximized by the software by rotating the turntable from 0° to 360°.
- Loop antenna is rotated about its vertical axis for maximum response at each azimuth about the EUT. (For certain applications, the loop antenna plane may also need to be positioned horizontally at the specified distance from the EUT)
- The final measurement is done in the position (turntable and elevation) causing the highest emissions with quasi-peak (as described in ANSI C 63.4).
- Final levels, frequency, measuring time, bandwidth, turntable position, correction factor, margin to the limit and limit will be recorded. A plot with the graph of the premeasurement and the limit is stored.

\*Note: The sequence will be repeated three times with different EUT orientations.

## 8.2 Sequence of testing radiated spurious 30 MHz to 1 GHz

### Setup

- The equipment is set up to simulate normal operation mode as described in the user manual or defined by the manufacturer.
- If the EUT is a tabletop system, a table with 0.8 m height is used, which is placed on the ground plane.
- If the EUT is a floor standing device, it is placed on the ground plane with insulation between both.
- Auxiliary equipment and cables are positioned to simulate normal operation conditions as described in ANSI C 63.4.
- The AC power port of the EUT (if available) is connected to a power outlet below the turntable.
- Measurement distance is 10 m or 3 m (see ANSI C 63.4) – see test details.
- EUT is set into operation.

### Premeasurement

- The turntable rotates from 0° to 315° using 45° steps.
- The antenna is polarized vertical and horizontal.
- The antenna height changes from 1 m to 3 m.
- At each turntable position, antenna polarization and height the analyzer sweeps three times in peak to find the maximum of all emissions.

### Final measurement

- The final measurement is performed for at least six highest peaks according to the requirements of the ANSI C63.4.
- Based on antenna and turntable positions at which the peak values are measured the software maximize the peaks by changing turntable position  $\pm 45^\circ$  and antenna height between 1 and 4 m.
- The final measurement is done with quasi-peak detector (as described in ANSI C 63.4).
- Final levels, frequency, measuring time, bandwidth, antenna height, antenna polarization, turntable angle, correction factor, margin to the limit and limit are recorded. A plot with the graph of the premeasurement with marked maximum final results and the limit is stored.



### 8.3 Sequence of testing radiated spurious 1 GHz to 18 GHz

#### Setup

- The equipment is set up to simulate normal operation mode as described in the user manual or defined by the manufacturer.
- If the EUT is a tabletop system, a 2-axis positioner with 1.5 m height is used.
- If the EUT is a floor standing device, it is placed directly on the turn table.
- Auxiliary equipment and cables are positioned to simulate normal operation conditions as described in ANSI C 63.4.
- The AC power port of the EUT (if available) is connected to a power outlet below the turntable.
- Measurement distance is 3 m (see ANSI C 63.4) – see test details.
- EUT is set into operation.

#### Premeasurement

- The turntable rotates from 0° to 315° using 45° steps.
- The antenna is polarized vertical and horizontal.
- The antenna height is 1.5 m.
- At each turntable position and antenna polarization the analyzer sweeps with positive peak detector to find the maximum of all emissions.

#### Final measurement

- The final measurement is performed for at least six highest peaks according to the requirements of the ANSI C63.4.
- Based on antenna and turntable positions at which the peak values are measured the software maximizes the peaks by rotating the turntable from 0° to 360°. This measurement is repeated for different EUT-table positions (0° to 150° in 30°-steps) and for both antenna polarizations.
- The final measurement is done in the position (turntable, EUT-table and antenna polarization) causing the highest emissions with Peak and RMS detector (as described in ANSI C 63.4).
- Final levels, frequency, measuring time, bandwidth, turntable position, EUT-table position, antenna polarization, correction factor, margin to the limit and limit are recorded. A plot with the graph of the premeasurement with marked maximum final results and the limit is stored.

## 8.4 Sequence of testing radiated spurious above 18 GHz

### Setup

- The equipment is set up to simulate normal operation mode as described in the user manual or defined by the manufacturer.
- Auxiliary equipment and cables are positioned to simulate normal operation conditions as described in ANSI C 63.4.
- The AC power port of the EUT (if available) is connected to a power outlet.
- The measurement distance is as appropriate (e.g. 0.5 m).
- The EUT is set into operation.

### Premeasurement

- The test antenna is handheld and moved carefully over the EUT to cover the EUT's whole sphere and different polarizations of the antenna.

### Final measurement

- The final measurement is performed at the position and antenna orientation causing the highest emissions with Peak and RMS detector (as described in ANSI C 63.4).
- Final levels, frequency, measuring time, bandwidth, correction factor, margin to the limit and limit are recorded. A plot with the graph of the premeasurement and the limit is stored.

## 9 Measurement uncertainty

| Measurement uncertainty                                  |                                     |           |
|--|-------------------------------------|-----------|
| Test case  | Uncertainty                         |           |
| Antenna gain   | ± 3 dB                              |           |
| Power spectral density                                   | ± 1.56 dB                           |           |
| DTS bandwidth  | ± 100 kHz (depends on the used RBW) |           |
| Occupied bandwidth                                       | ± 100 kHz (depends on the used RBW) |           |
| Maximum output power conducted                           | ± 1.56 dB                           |           |
| Detailed spurious emissions @ the band edge - conducted  | ± 1.56 dB                           |           |
| Band edge compliance radiated                            | ± 3 dB                              |           |
| Spurious emissions conducted                             | > 3.6 GHz                           | ± 1.56 dB |
|  | > 7 GHz                             | ± 1.56 dB |
|  | > 18 GHz                            | ± 2.31 dB |
|  | ≥ 40 GHz                            | ± 2.97 dB |
| Spurious emissions radiated below 30 MHz                 | ± 3 dB                              |           |
| Spurious emissions radiated 30 MHz to 1 GHz              | ± 3 dB                              |           |
| Spurious emissions radiated 1 GHz to 12.75 GHz           | ± 3.7 dB                            |           |
| Spurious emissions radiated above 12.75 GHz              | ± 4.5 dB                            |           |
| Spurious emissions conducted below 30 MHz (AC conducted) | ± 2.6 dB                            |           |

## 10 Summary of measurement results

|                                     |  |
|-------------------------------------|--|
| <input checked="" type="checkbox"/> | No deviations from the technical specifications were ascertained   |
| <input type="checkbox"/>            | There were deviations from the technical specifications ascertained  |
| <input type="checkbox"/>            | This test report is only a partial test report.<br>The content and verdict of the performed test cases are listed below. |

| TC Identifier | Description                              | Verdict   | Date       | Remark |
|---------------|--|-----------|------------|--------|
| RF-Testing    | CFR Title 47 Part 15<br>RSS 247, Issue 2 | See table | 2023-08-17 | -/-    |

| Test specification clause         | Test case  | C                                   | NC                       | NA                       | NP                                  | Remark                         |
|-----------------------------------|--|-------------------------------------|--------------------------|--------------------------|-------------------------------------|--------------------------------|
| -/-                               | Output power verification (cond.)                  | -/-                                 |                          |                          |                                     | Declared                       |
| -/-                               | Antenna gain                                       | -/-                                 |                          |                          |                                     | Declared                       |
| U-NII Part 15                     | Duty cycle   | -/-                                 |                          |                          |                                     | -/-                            |
| §15.407(a)<br>RSS - 247 (6.2.x.1) | Maximum output power<br>(conducted & radiated)     | <input checked="" type="checkbox"/> | <input type="checkbox"/> | <input type="checkbox"/> | <input type="checkbox"/>            | -/-                            |
| §15.407(a)<br>RSS - 247 (6.2.x.1) | Power spectral density                             | <input checked="" type="checkbox"/> | <input type="checkbox"/> | <input type="checkbox"/> | <input type="checkbox"/>            | -/-                            |
| RSS - 247 (6.2.4.1)               | Spectrum bandwidth<br>6dB bandwidth                | <input checked="" type="checkbox"/> | <input type="checkbox"/> | <input type="checkbox"/> | <input type="checkbox"/>            | -/-                            |
| §15.407(a)<br>RSS - 247 (6.2.x.2) | Spectrum bandwidth<br>26dB bandwidth               | <input checked="" type="checkbox"/> | <input type="checkbox"/> | <input type="checkbox"/> | <input type="checkbox"/>            | -/-                            |
| RSS Gen clause<br>6.6             | Spectrum bandwidth<br>99% bandwidth                | -/-                                 |                          |                          |                                     | -/-                            |
| §15.205<br>RSS - 247 (6.2.x.2)    | Band edge compliance radiated                      | <input checked="" type="checkbox"/> | <input type="checkbox"/> | <input type="checkbox"/> | <input type="checkbox"/>            | -/-                            |
| §15.407(b)<br>RSS - 247 (6.2.x.2) | TX spurious emissions radiated                     | <input checked="" type="checkbox"/> | <input type="checkbox"/> | <input type="checkbox"/> | <input type="checkbox"/>            | -/-                            |
| §15.109<br>RSS-Gen                | RX spurious emissions radiated                     | <input type="checkbox"/>            | <input type="checkbox"/> | <input type="checkbox"/> | <input checked="" type="checkbox"/> | -/-                            |
| §15.209(a)<br>RSS-Gen             | Spurious emissions radiated<br>< 30 MHz            | <input checked="" type="checkbox"/> | <input type="checkbox"/> | <input type="checkbox"/> | <input type="checkbox"/>            | -/-                            |
| §15.107(a)<br>§15.207             | Spurious emissions conducted<br>emissions < 30 MHz | <input checked="" type="checkbox"/> | <input type="checkbox"/> | <input type="checkbox"/> | <input type="checkbox"/>            | -/-                            |
| §15.407<br>RSS - 247 (6.3)        | DFS  | -/-                                 |                          |                          |                                     | See report<br>23-1-0061401T005 |

Notes:

|    |           |     |               |     |                |     |               |
|----|-----------|-----|---------------|-----|----------------|-----|---------------|
| C: | Compliant | NC: | Not compliant | NA: | Not applicable | NP: | Not performed |
|----|-----------|-----|---------------|-----|----------------|-----|---------------|

## 11 Additional comments

- Reference documents: DFS report: 23-1-0061401T004  
DIW377DISH - WiFi test commands\_V2.docx
- Special test descriptions: In U-NII-1 & U-NII-2A & U-NII-2C bands the power settings have been reduced to be compliant with the radiated band edge requirement, or output power, or power density requirement.
- In U-NII-3 band the power settings have been reduced to be compliant with the spectrum mask as per FCC Part 15.407 (b)(4) and KDB 789033 II.G.2 (c) (ii).
- Configuration descriptions: All tests were performed with both chains active. SISO modes are not supported.

Provided channels and used power settings for all modes:

a-mode:

| U-NII-1 & U-NII-2A (5150 MHz to 5250 MHz & 5250 MHz to 5350 MHz)<br>channel number & center frequency |             |             |      |             |             |             |      |             |
|---|-------------|-------------|------|-------------|-------------|-------------|------|-------------|
| channel   | <b>36</b>   | <b>40</b>   | 44   | <b>48</b>   | <b>52</b>   | <b>56</b>   | 60   | <b>64</b>   |
| f <sub>c</sub> / MHz  | <b>5180</b> | <b>5200</b> | 5220 | <b>5240</b> | <b>5260</b> | <b>5280</b> | 5300 | <b>5320</b> |
| Power setting *)  | <b>69</b>   | <b>73</b>   | -/-  | <b>74</b>   | <b>74</b>   | <b>74</b>   | -/-  | <b>70</b>   |

| U-NII-2C (5470 MHz to 5725 MHz)<br>channel number & center frequency |             |      |      |      |      |             |      |      |      |      |             |
|--|-------------|------|------|------|------|-------------|------|------|------|------|-------------|
| channel  | <b>100</b>  | 104  | 108  | 112  | 116  | <b>120</b>  | 124  | 128  | 132  | 136  | <b>144</b>  |
| f <sub>c</sub> / MHz   | <b>5500</b> | 5520 | 5540 | 5560 | 5580 | <b>5600</b> | 5620 | 5640 | 5660 | 5680 | <b>5720</b> |
| Power setting *)   | <b>76</b>   | -/-  | -/-  | -/-  | -/-  | <b>75</b>   | -/-  | -/-  | -/-  | -/-  | <b>75</b>   |

| U-NII-3 (5725 MHz to 5850 MHz)<br>channel number & center frequency |             |      |  |             |      |             |
|---|-------------|------|--|-------------|------|-------------|
| channel   | <b>149</b>  | 153  |  | <b>157</b>  | 161  | <b>165</b>  |
| f <sub>c</sub> / MHz  | <b>5745</b> | 5765 |  | <b>5785</b> | 5805 | <b>5825</b> |
| Power setting *)  | <b>96</b>   | -/-  |  | <b>96</b>   | -/-  | <b>96</b>   |

nHT20-mode:

| U-NII-1 & U-NII-2A (5150 MHz to 5250 MHz & 5250 MHz to 5350 MHz)<br>channel number & center frequency |             |             |      |             |             |             |      |             |
|---|-------------|-------------|------|-------------|-------------|-------------|------|-------------|
| channel   | <b>36</b>   | <b>40</b>   | 44   | <b>48</b>   | <b>52</b>   | <b>56</b>   | 60   | <b>64</b>   |
| f <sub>c</sub> / MHz  | <b>5180</b> | <b>5200</b> | 5220 | <b>5240</b> | <b>5260</b> | <b>5280</b> | 5300 | <b>5320</b> |
| Power setting *)  | <b>68</b>   | <b>72</b>   | -/-  | <b>76</b>   | <b>75</b>   | <b>75</b>   | -/-  | <b>70</b>   |

| U-NII-2C (5470 MHz to 5725 MHz)<br>channel number & center frequency |             |      |      |      |      |             |      |      |      |      |             |
|--|-------------|------|------|------|------|-------------|------|------|------|------|-------------|
| channel  | <b>100</b>  | 104  | 108  | 112  | 116  | <b>120</b>  | 124  | 128  | 132  | 136  | <b>144</b>  |
| f <sub>c</sub> / MHz   | <b>5500</b> | 5520 | 5540 | 5560 | 5580 | <b>5600</b> | 5620 | 5640 | 5660 | 5680 | <b>5720</b> |
| Power setting *)   | <b>75</b>   | -/-  | -/-  | -/-  | -/-  | <b>76</b>   | -/-  | -/-  | -/-  | -/-  | <b>76</b>   |

| U-NII-3 (5725 MHz to 5850 MHz)<br>channel number & center frequency |             |      |  |             |      |             |
|---|-------------|------|--|-------------|------|-------------|
| channel   | <b>149</b>  | 153  |  | <b>157</b>  | 161  | <b>165</b>  |
| f <sub>c</sub> / MHz  | <b>5745</b> | 5765 |  | <b>5785</b> | 5805 | <b>5825</b> |
| Power setting *)  | <b>96</b>   | -/-  |  | <b>96</b>   | -/-  | <b>96</b>   |

acVHT20-mode:

| U-NII-1 & U-NII-2A (5150 MHz to 5250 MHz & 5250 MHz to 5350 MHz)<br>channel number & center frequency |             |             |      |             |             |             |      |             |
|---|-------------|-------------|------|-------------|-------------|-------------|------|-------------|
| channel   | <b>36</b>   | <b>40</b>   | 44   | <b>48</b>   | <b>52</b>   | <b>56</b>   | 60   | <b>64</b>   |
| f <sub>c</sub> / MHz  | <b>5180</b> | <b>5200</b> | 5220 | <b>5240</b> | <b>5260</b> | <b>5280</b> | 5300 | <b>5320</b> |
| Power setting *)  | <b>68</b>   | <b>75</b>   | -/-  | <b>76</b>   | <b>76</b>   | <b>76</b>   | -/-  | <b>70</b>   |

| U-NII-2C (5470 MHz to 5725 MHz)<br>channel number & center frequency |             |      |      |      |      |             |      |      |      |      |             |
|--|-------------|------|------|------|------|-------------|------|------|------|------|-------------|
| channel  | <b>100</b>  | 104  | 108  | 112  | 116  | <b>120</b>  | 124  | 128  | 132  | 136  | <b>144</b>  |
| f <sub>c</sub> / MHz   | <b>5500</b> | 5520 | 5540 | 5560 | 5580 | <b>5600</b> | 5620 | 5640 | 5660 | 5680 | <b>5720</b> |
| Power setting *)   | <b>74</b>   | -/-  | -/-  | -/-  | -/-  | <b>76</b>   | -/-  | -/-  | -/-  | -/-  | <b>76</b>   |

| U-NII-3 (5725 MHz to 5850 MHz)<br>channel number & center frequency |             |      |             |      |             |
|---|-------------|------|-------------|------|-------------|
| channel   | <b>149</b>  | 153  | <b>157</b>  | 161  | <b>165</b>  |
| f <sub>c</sub> / MHz  | <b>5745</b> | 5765 | <b>5785</b> | 5805 | <b>5825</b> |
| Power setting *)  | <b>96</b>   | -/-  | <b>96</b>   | -/-  | <b>96</b>   |

axHE20-mode:

| U-NII-1 & U-NII-2A (5150 MHz to 5250 MHz & 5250 MHz to 5350 MHz)<br>channel number & center frequency |             |             |      |             |             |             |      |             |
|---|-------------|-------------|------|-------------|-------------|-------------|------|-------------|
| channel   | <b>36</b>   | <b>40</b>   | 44   | <b>48</b>   | <b>52</b>   | <b>56</b>   | 60   | <b>64</b>   |
| f <sub>c</sub> / MHz  | <b>5180</b> | <b>5200</b> | 5220 | <b>5240</b> | <b>5260</b> | <b>5280</b> | 5300 | <b>5320</b> |
| Power setting *)  | <b>64</b>   | <b>76</b>   | -/-  | <b>76</b>   | <b>76</b>   | <b>76</b>   | -/-  | <b>66</b>   |

| U-NII-2C (5470 MHz to 5725 MHz)<br>channel number & center frequency |             |      |      |      |      |             |      |      |      |      |             |
|--|-------------|------|------|------|------|-------------|------|------|------|------|-------------|
| channel  | <b>100</b>  | 104  | 108  | 112  | 116  | <b>120</b>  | 124  | 128  | 132  | 136  | <b>144</b>  |
| f <sub>c</sub> / MHz   | <b>5500</b> | 5520 | 5540 | 5560 | 5580 | <b>5600</b> | 5620 | 5640 | 5660 | 5680 | <b>5720</b> |
| Power setting *)   | <b>76</b>   | -/-  | -/-  | -/-  | -/-  | <b>76</b>   | -/-  | -/-  | -/-  | -/-  | <b>76</b>   |

| U-NII-3 (5725 MHz to 5850 MHz)<br>channel number & center frequency |             |      |             |      |             |
|---|-------------|------|-------------|------|-------------|
| channel   | <b>149</b>  | 153  | <b>157</b>  | 161  | <b>165</b>  |
| f <sub>c</sub> / MHz  | <b>5745</b> | 5765 | <b>5785</b> | 5805 | <b>5825</b> |
| Power setting *)  | <b>96</b>   | -/-  | <b>96</b>   | -/-  | <b>96</b>   |

nHT40-mode:

| U-NII-1 & U-NII-2A (5150 MHz to 5250 MHz & 5250 MHz to 5350 MHz)<br>channel number & center frequency |             |             |             |             |
|---|-------------|-------------|-------------|-------------|
| channel   | <b>38</b>   | <b>46</b>   | <b>54</b>   | <b>62</b>   |
| f <sub>c</sub> / MHz  | <b>5190</b> | <b>5230</b> | <b>5270</b> | <b>5310</b> |
| Power setting *)  | <b>50</b>   | <b>79</b>   | <b>82</b>   | <b>52</b>   |

| U-NII-2C (5470 MHz to 5725 MHz)<br>channel number & center frequency |             |      |             |      |
|--|-------------|------|-------------|------|
| channel  | <b>102</b>  | 110  | <b>118</b>  | 126  |
| f <sub>c</sub> / MHz   | <b>5510</b> | 5550 | <b>5590</b> | 5630 |
| Power setting *)   | <b>62</b>   | -/-  | <b>80</b>   | -/-  |

| U-NII-3 (5725 MHz to 5850 MHz)<br>channel number & center frequency |             |             |
|---|-------------|-------------|
| channel   | <b>151</b>  | <b>159</b>  |
| f <sub>c</sub> / MHz  | <b>5755</b> | <b>5795</b> |
| Power setting *)  | <b>96</b>   | <b>96</b>   |

acVHT40-mode:

| U-NII-1 & U-NII-2A (5150 MHz to 5250 MHz & 5250 MHz to 5350 MHz)<br>channel number & center frequency |             |             |             |             |
|---|-------------|-------------|-------------|-------------|
| channel   | <b>38</b>   | <b>46</b>   | <b>54</b>   | <b>62</b>   |
| f <sub>c</sub> / MHz  | <b>5190</b> | <b>5230</b> | <b>5270</b> | <b>5310</b> |
| Power setting *)  | <b>50</b>   | <b>79</b>   | <b>79</b>   | <b>52</b>   |

| U-NII-2C (5470 MHz to 5725 MHz)<br>channel number & center frequency |             |      |             |      |
|--|-------------|------|-------------|------|
| channel  | <b>102</b>  | 110  | <b>118</b>  | 126  |
| f <sub>c</sub> / MHz   | <b>5510</b> | 5550 | <b>5590</b> | 5630 |
| Power setting *)   | <b>62</b>   | -/-  | <b>80</b>   | -/-  |

| U-NII-3 (5725 MHz to 5850 MHz)<br>channel number & center frequency |             |             |
|---|-------------|-------------|
| channel   | <b>151</b>  | <b>159</b>  |
| f <sub>c</sub> / MHz  | <b>5755</b> | <b>5795</b> |
| Power setting *)  | <b>96</b>   | <b>96</b>   |



axHE40-mode:

| U-NII-1 & U-NII-2A (5150 MHz to 5250 MHz & 5250 MHz to 5350 MHz)<br>channel number & center frequency |             |             |             |             |
|---|-------------|-------------|-------------|-------------|
| channel   | <b>38</b>   | <b>46</b>   | <b>54</b>   | <b>62</b>   |
| f <sub>c</sub> / MHz  | <b>5190</b> | <b>5230</b> | <b>5270</b> | <b>5310</b> |
| Power setting *)  | <b>44</b>   | <b>79</b>   | <b>79</b>   | <b>46</b>   |

| U-NII-2C (5470 MHz to 5725 MHz)<br>channel number & center frequency |             |      |             |      |
|--|-------------|------|-------------|------|
| channel  | <b>102</b>  | 110  | <b>118</b>  | 126  |
| f <sub>c</sub> / MHz   | <b>5510</b> | 5550 | <b>5590</b> | 5630 |
| Power setting *)   | <b>56</b>   | -/-  | <b>80</b>   | -/-  |

| U-NII-3 (5725 MHz to 5850 MHz)<br>channel number & center frequency |             |             |
|---|-------------|-------------|
| channel   | <b>151</b>  | <b>159</b>  |
| f <sub>c</sub> / MHz  | <b>5755</b> | <b>5795</b> |
| Power setting *)  | <b>96</b>   | <b>96</b>   |

acVHT80-mode:

| U-NII-1 & U-NII-2A (5150 MHz to 5250 MHz & 5250 MHz to 5350 MHz)<br>channel number & center frequency |             |             |
|---|-------------|-------------|
| channel   | <b>42</b>   | <b>58</b>   |
| f <sub>c</sub> / MHz  | <b>5210</b> | <b>5290</b> |
| Power setting *)  | <b>48</b>   | <b>48</b>   |

| U-NII-2C (5470 MHz to 5725 MHz)<br>channel number & center frequency |             |             |
|--|-------------|-------------|
| channel  | <b>106</b>  | <b>122</b>  |
| f <sub>c</sub> / MHz   | <b>5530</b> | <b>5610</b> |
| Power setting *)   | <b>52</b>   | <b>82</b>   |

| U-NII-3 (5725 MHz to 5850 MHz)<br>channel number & center frequency |             |
|---|-------------|
| channel   | <b>155</b>  |
| f <sub>c</sub> / MHz  | <b>5775</b> |
| Power setting *)  | <b>88</b>   |

axHE80-mode:

| U-NII-1 & U-NII-2A (5150 MHz to 5250 MHz & 5250 MHz to 5350 MHz)<br>channel number & center frequency |             |             |
|---|-------------|-------------|
| channel   | <b>42</b>   | <b>58</b>   |
| f <sub>c</sub> / MHz  | <b>5210</b> | <b>5290</b> |
| Power setting *)  | <b>46</b>   | <b>46</b>   |

| U-NII-2C (5470 MHz to 5725 MHz)<br>channel number & center frequency |             |             |             |
|--|-------------|-------------|-------------|
| channel  | <b>106</b>  | <b>122</b>  | <b>138</b>  |
| f <sub>c</sub> / MHz   | <b>5530</b> | <b>5610</b> | <b>5690</b> |
| Power setting *)   | <b>48</b>   | <b>82</b>   | <b>82</b>   |

| U-NII-3 (5725 MHz to 5850 MHz)<br>channel number & center frequency |             |
|---|-------------|
| channel   | <b>155</b>  |
| f <sub>c</sub> / MHz  | <b>5775</b> |
| Power setting *)  | <b>88</b>   |

- EUT selection:
- Only one device available
  - Devices selected by the customer
  - Devices selected by the laboratory (Randomly)

- Test mode:
- No test mode available.  
Iperf is used to transmit data to a companion device
  - Special software is used.  
EUT is transmitting pseudo random data by itself

Antennas and transmit operating modes:

- Operating mode 1 (single antenna)
  - Equipment with 1 antenna,
  - Equipment with 2 diversity antennas operating in switched diversity mode by which at any moment in time only 1 antenna is used,
  - Smart antenna system with 2 or more transmit/receive chains, but operating in a mode where only 1 transmit/receive chain is used)
- Operating mode 2 (multiple antennas, no beamforming)
  - Equipment operating in this mode contains a smart antenna system using two or more transmit/receive chains simultaneously but without beamforming.
- Operating mode 3 (multiple antennas, with beamforming)
  - Equipment operating in this mode contains a smart antenna system using two or more transmit/receive chains simultaneously with beamforming.  
In addition to the antenna assembly gain (G), the beamforming gain (Y) may have to be taken into account when performing the measurements.

## 12 Measurement results

### 12.1 Identify worst case data rate

Declared by the customer:

| OFDM – mode     | Modulation scheme / bandwidth |                 |                |                 |                |                 |
|-----------------|-------------------------------|-----------------|----------------|-----------------|----------------|-----------------|
|                 | U-NII-1 & U-NII-2A            |                 | U-NII-2C       |                 | U-NII-3        |                 |
|                 | lowest channel                | highest channel | lowest channel | highest channel | lowest channel | highest channel |
| a – mode        | 6 Mbit/s                      | 6 Mbit/s        | 6 Mbit/s       | 6 Mbit/s        | 6 Mbit/s       | 6 Mbit/s        |
| n HT20 – mode   | MCS8                          | MCS8            | MCS8           | MCS8            | MCS8           | MCS8            |
| ac VHT20        | MCS0NSS2                      | MCS0NSS2        | MCS0NSS2       | MCS0NSS2        | MCS0NSS2       | MCS0NSS2        |
| ax HE20         | HE0NSS2                       | HE0NSS2         | HE0NSS2        | HE0NSS2         | HE0NSS2        | HE0NSS2         |
| n HT40 – mode   | MCS8                          | MCS8            | MCS8           | MCS8            | MCS8           | MCS8            |
| ac VHT40 – mode | MCS0NSS2                      | MCS0NSS2        | MCS0NSS2       | MCS0NSS2        | MCS0NSS2       | MCS0NSS2        |
| ax HE40 - mode  | HE0NSS2                       | HE0NSS2         | HE0NSS2        | HE0NSS2         | HE0NSS2        | HE0NSS2         |
| ac VHT80 – mode | MCS0NSS2                      | MCS0NSS2        | MCS0NSS2       | MCS0NSS2        | MCS0NSS2       | MCS0NSS2        |
| ax HE80 – mode  | HE0NSS2                       | HE0NSS2         | HE0NSS2        | HE0NSS2         | HE0NSS2        | HE0NSS2         |

### 12.2 Antenna gain

Declared by the manufacturer (see referenced documents).

UNII-1/2A: 6.2dBi combined gain

UNII-2C/3: 6.3dBi combined gain

## 12.3 Duty cycle

Description:

The duty cycle is necessary to compute the maximum power during an actual transmission. The shown plots and values are to show an example of the measurement procedure. The real value is measured direct during the power measurement or power density measurement. The correction value is shown in each plot of these measurements.

Measurement:

| Measurement parameter           |   |
|---------------------------------|---|
| According to: KDB789033 D02, B. |   |
| External result file(s)         | 23-1-00614001T004_A6a-h.pdf<br>FCC Part 15.407 Max Output Power and PSD |
| Used test setup:                | See chapter 7.5 – A   |
| Measurement uncertainty:        | See chapter 9   |

Results:

Duty cycle and correction factor:

| OFDM – mode | Calculation method   |                            |            |                   |
|-------------|--|----------------------------|------------|-------------------|
|             | $T_{on} (D2_{plot}) * 100 / T_{complete} (D3_{plot}) = \text{duty cycle}$<br>$10 * \log(\text{duty cycle}) = \text{correction factor}$ |                            |            |                   |
|             | $T_{on} (D2_{plot})$   | $T_{complete} (D3_{plot})$ | Duty cycle | Correction factor |
| a – mode    | -/-  | -/-                        | 100%       | 0 dB              |
| n20 – mode  | -/-  | -/-                        | 100%       | 0 dB              |
| ac20 – mode | -/-  | -/-                        | 100%       | 0 dB              |
| ax20 – mode | -/-  | -/-                        | 100%       | 0 dB              |
| n40 – mode  | -/-  | -/-                        | 100%       | 0 dB              |
| ac40 – mode | -/-  | -/-                        | 100%       | 0 dB              |
| ax40 – mode | -/-  | -/-                        | 100%       | 0 dB              |
| ac80 – mode | -/-  | -/-                        | 100%       | 0 dB              |
| ax80 – mode | -/-  | -/-                        | 100%       | 0 dB              |

## 12.4 Maximum output power

### 12.4.1 Maximum output power according to FCC requirements

Description:

Measurement of the maximum output power conducted

Measurement:

| Measurement parameter               |   |
|-------------------------------------|---|
| According to: KDB789033 D02, E.2.e. |   |
| External result file(s)             | 23-1-00614001T004_A6a-h.pdf<br>FCC Part 15.407 Max Output Power and PSD |
| Used test setup:                    | See chapter 7.5 – A   |
| Measurement uncertainty:            | See chapter 9   |
| Standard parts:                     | FCC: § 15.407 (a)   |

Limits:

| Limits                               |  |
|--------------------------------------|--|
| Radiated output power                | Conducted output power   |
| Band 5150 MHz – 5250 MHz             |  |
| Conducted power + 6 dBi antenna gain | <b>For client devices</b><br>output power $\leq$ 250 mW/24dBm  |
| Band 5250MHz – 5350 MHz              |  |
| Conducted power + 6 dBi antenna gain | Output power $\leq$ lesser of 250mW or 11dBm +10logB<br>(B is the 26 dB emission bandwidth in megahertz) |
| Band 5470MHz – 5725 MHz              |  |
| Conducted power + 6 dBi antenna gain | Output power $\leq$ lesser of 250mW or 11dBm +10logB<br>(B is the 26 dB emission bandwidth in megahertz) |
| Band 5725MHz – 5850 MHz              |  |
| Conducted power + 6 dBi antenna gain | output power $\leq$ 1W/30dBm   |

\*If transmitting antennas of directional gain greater than 6 dBi are used, the maximum conducted output power shall be reduced by the amount in dB that the directional gain of the antenna exceeds 6 dBi. This leads to the following limits:

| Bands        | UNII-1 | UNII-2A | UNII-2C | UNII-3 |
|--------------|--------|---------|---------|--------|
| Limits [dBm] | 23.8   | 23.8    | 23.7    | 29.7   |

Results:

| 802.11a                    |      |      |      |      |      |      |      |      |      |      |      |      |
|----------------------------|------|------|------|------|------|------|------|------|------|------|------|------|
| Maximum output power [dBm] |      |      |      |      |      |      |      |      |      |      |      |      |
| Channel                    | 36   | 40   | 48   | 52   | 56   | 64   | 100  | 120  | 144  | 149  | 157  | 165  |
| Port 1                     | 18.5 | 19.5 | 19.5 | 19.8 | 19.7 | 18.4 | 18.4 | 19.5 | 19.4 | 24.0 | 24.1 | 23.6 |
| Port 2                     | 17.4 | 18.6 | 18.9 | 18.8 | 18.6 | 17.4 | 17.4 | 18.8 | 19.0 | 24.0 | 24.0 | 23.9 |
| SUM                        | 21.0 | 22.1 | 22.2 | 22.4 | 22.2 | 20.9 | 20.9 | 22.2 | 22.2 | 27.0 | 27.0 | 26.7 |

| 802.11nHT20                |      |      |      |      |      |      |      |      |      |      |      |      |
|----------------------------|------|------|------|------|------|------|------|------|------|------|------|------|
| Maximum output power [dBm] |      |      |      |      |      |      |      |      |      |      |      |      |
| Channel                    | 36   | 40   | 48   | 52   | 56   | 64   | 100  | 120  | 144  | 149  | 157  | 165  |
| Port 1                     | 18.1 | 19.2 | 20.0 | 20.2 | 19.8 | 19.8 | 18.5 | 19.8 | 19.6 | 24.0 | 24.0 | 23.5 |
| Port 2                     | 17.0 | 18.3 | 19.5 | 19.3 | 19.1 | 19.1 | 17.9 | 19.2 | 19.3 | 24.3 | 24.1 | 23.9 |
| SUM                        | 20.6 | 21.8 | 22.7 | 22.8 | 22.5 | 22.5 | 21.2 | 22.6 | 22.5 | 27.2 | 27.2 | 26.7 |

| 802.11ac VHT20             |      |      |      |      |      |      |      |      |      |      |      |      |
|----------------------------|------|------|------|------|------|------|------|------|------|------|------|------|
| Maximum output power [dBm] |      |      |      |      |      |      |      |      |      |      |      |      |
| Channel                    | 36   | 40   | 48   | 52   | 56   | 64   | 100  | 120  | 144  | 149  | 157  | 165  |
| Port 1                     | 18.2 | 19.8 | 20.1 | 20.2 | 20.1 | 18.3 | 18.5 | 19.9 | 19.8 | 24.3 | 24.0 | 23.5 |
| Port 2                     | 17.4 | 19.1 | 19.5 | 19.4 | 19.4 | 17.9 | 17.8 | 19.3 | 19.2 | 24.4 | 24.1 | 23.9 |
| SUM                        | 21.4 | 22.5 | 22.8 | 22.9 | 22.8 | 21.1 | 21.2 | 22.6 | 22.5 | 27.4 | 27.1 | 26.7 |

| 802.11ax20                 |      |      |      |      |      |      |      |      |      |      |      |      |
|----------------------------|------|------|------|------|------|------|------|------|------|------|------|------|
| Maximum output power [dBm] |      |      |      |      |      |      |      |      |      |      |      |      |
| Channel                    | 36   | 40   | 48   | 52   | 56   | 64   | 100  | 120  | 144  | 149  | 157  | 165  |
| Port 1                     | 17.5 | 20.2 | 20.2 | 20.3 | 20.2 | 17.6 | 19.4 | 20.1 | 20.0 | 24.2 | 24.4 | 23.7 |
| Port 2                     | 16.8 | 19.5 | 19.9 | 19.7 | 19.6 | 17.1 | 18.6 | 19.5 | 19.4 | 24.4 | 24.3 | 24.1 |
| SUM                        | 20.1 | 22.9 | 23.0 | 23.0 | 22.9 | 20.4 | 22.0 | 22.8 | 22.7 | 27.3 | 27.3 | 26.9 |

| 802.11 n HT40              |      |      |      |      |      |      |      |      |      |
|----------------------------|------|------|------|------|------|------|------|------|------|
| Maximum output power [dBm] |      |      |      |      |      |      |      |      |      |
| Channel                    | 38   | 46   | 54   | 62   | 102  | 118  | 142  | 151  | 159  |
| Port 1                     | 13.1 | 20.7 | 21.0 | 13.7 | 15.5 | 20.9 | 21.0 | 24.5 | 24.4 |
| Port 2                     | 12.5 | 20.5 | 20.1 | 12.9 | 14.4 | 20.0 | 20.3 | 24.3 | 24.0 |
| SUM                        | 15.8 | 23.6 | 23.5 | 16.3 | 18.0 | 23.5 | 23.7 | 27.4 | 27.2 |

| 802.11 ac VHT40            |      |      |      |      |      |      |      |      |      |
|----------------------------|------|------|------|------|------|------|------|------|------|
| Maximum output power [dBm] |      |      |      |      |      |      |      |      |      |
| Channel                    | 38   | 46   | 54   | 62   | 102  | 118  | 142  | 151  | 159  |
| Port 1                     | 13.7 | 20.8 | 21.1 | 13.8 | 15.6 | 21.0 | 20.9 | 24.6 | 24.5 |
| Port 2                     | 12.8 | 20.5 | 20.0 | 13.2 | 14.3 | 19.8 | 20.1 | 24.3 | 24.1 |
| SUM                        | 16.3 | 23.7 | 23.6 | 16.5 | 18.0 | 23.4 | 23.5 | 27.5 | 27.3 |

| 802.11 ax HE40             |      |      |      |      |      |      |      |      |      |
|----------------------------|------|------|------|------|------|------|------|------|------|
| Maximum output power [dBm] |      |      |      |      |      |      |      |      |      |
| Channel                    | 38   | 46   | 54   | 62   | 102  | 118  | 142  | 151  | 159  |
| Port 1                     | 12.2 | 20.8 | 21.1 | 12.6 | 14.3 | 21.0 | 20.9 | 23.9 | 23.7 |
| Port 2                     | 11.2 | 20.6 | 20.3 | 11.5 | 13.0 | 20.1 | 20.1 | 23.7 | 23.3 |
| SUM                        | 14.8 | 23.7 | 23.7 | 15.1 | 16.7 | 23.6 | 23.5 | 26.8 | 26.5 |

| 802.11 ac VHT80            |      |      |      |      |      |      |  |
|----------------------------|------|------|------|------|------|------|--|
| Maximum output power [dBm] |      |      |      |      |      |      |  |
| Channel                    | 42   | 58   | 106  | 122  | 138  | 155  |  |
| Port 1                     | 12.9 | 13.1 | 13.3 | 20.4 | 20.6 | 22.6 |  |
| Port 2                     | 12.2 | 12.1 | 12.3 | 20.2 | 20.3 | 22.1 |  |
| SUM                        | 15.6 | 15.7 | 15.8 | 23.3 | 23.4 | 25.4 |  |

| 802.11 ax HE80             |      |      |      |      |      |      |
|----------------------------|------|------|------|------|------|------|
| Maximum output power [dBm] |      |      |      |      |      |      |
| Channel                    | 42   | 58   | 106  | 122  | 138  | 155  |
| Port 1                     | 11.9 | 11.9 | 11.6 | 20.1 | 20.2 | 21.9 |
| Port 2                     | 11.2 | 11.0 | 10.7 | 19.9 | 20.0 | 21.5 |
| SUM                        | 14.6 | 14.5 | 14.2 | 23.0 | 23.1 | 24.7 |



## 12.5 Power spectral density

### 12.5.1 Power spectral density according to FCC requirements

Description:

Measurement of the power spectral density of a digital modulated system. The measurement is repeated at the lowest, middle and highest channel.

Measurement:

| Measurement parameter           |   |
|---------------------------------|---|
| According to: KDB789033 D02, F. |   |
| External result file(s)         | 23-1-00614001T004_A6a-h.pdf<br>FCC Part 15.407 Max Output Power and PSD |
| Used test setup:                | See chapter 7.5 – A   |
| Measurement uncertainty:        | See chapter 9   |
| Standard parts:                 | FCC: § 15.407 (a)   |

Limits:

| Power Spectral Density   |
|--|
| <b>Band 5150 MHz – 5250 MHz</b>  |
| For client devices point power spectral density conducted $\leq 11$ dBm in any 1 MHz band* |
| <b>Band 5250MHz – 5350 MHz</b>   |
| power spectral density conducted $\leq 11$ dBm in any 1 MHz band*                          |
| <b>Band 5470MHz – 5725 MHz</b>   |
| power spectral density conducted $\leq 11$ dBm in any 1 MHz band*                          |
| <b>Band 5725MHz – 5850 MHz</b>   |
| power spectral density conducted $\leq 30$ dBm in any 500 kHz band*                        |

\*If transmitting antennas of directional gain greater than 6 dBi are used, the maximum conducted output power shall be reduced by the amount in dB that the directional gain of the antenna exceeds 6 dBi. This leads to the following limits:

| Bands        | UNII-1 | UNII-2A | UNII-2C | UNII-3 |
|--------------|--------|---------|---------|--------|
| Limits [dBm] | 10.8   | 10.8    | 10.7    | 29.7   |

Results:

| 802.11 a  |      |      |      |      |      |      |      |      |      |      |      |      |
|---|------|------|------|------|------|------|------|------|------|------|------|------|
| Power spectral density [dBm/1MHz] or [dBm/500kHz] |      |      |      |      |      |      |      |      |      |      |      |      |
| Channel   | 36   | 40   | 48   | 52   | 56   | 64   | 100  | 120  | 144  | 149  | 157  | 165  |
| Port 1  | 8.0  | 7.8  | 7.8  | 8.1  | 8.0  | 7.9  | 7.9  | 7.8  | 7.7  | 9.1  | 9.3  | 8.8  |
| Port 2  | 6.9  | 6.9  | 7.1  | 7.1  | 6.9  | 7.0  | 7.0  | 7.1  | 7.3  | 9.5  | 9.3  | 9.2  |
| SUM   | 10.5 | 10.4 | 10.5 | 10.6 | 10.5 | 10.5 | 10.5 | 10.5 | 10.5 | 12.3 | 12.3 | 12.0 |

| 802.11 n HT20                                     |     |     |      |      |      |      |      |      |      |      |      |      |
|---|-----|-----|------|------|------|------|------|------|------|------|------|------|
| Power spectral density [dBm/1MHz] or [dBm/500kHz] |     |     |      |      |      |      |      |      |      |      |      |      |
| Channel   | 36  | 40  | 48   | 52   | 56   | 64   | 100  | 120  | 144  | 149  | 157  | 165  |
| Port 1  | 7.3 | 7.2 | 7.9  | 8.1  | 7.8  | 7.8  | 7.7  | 7.8  | 7.6  | 9.0  | 9.1  | 8.3  |
| Port 2  | 6.2 | 6.2 | 7.4  | 7.2  | 7.1  | 7.1  | 7.1  | 7.2  | 7.2  | 9.3  | 9.1  | 8.9  |
| SUM   | 9.8 | 9.7 | 10.7 | 10.7 | 10.4 | 10.4 | 10.4 | 10.5 | 10.4 | 12.1 | 12.1 | 11.6 |

| 802.11 ac VHT20                                   |      |      |      |      |      |      |      |      |      |      |      |      |
|---|------|------|------|------|------|------|------|------|------|------|------|------|
| Power spectral density [dBm/1MHz] or [dBm/500kHz] |      |      |      |      |      |      |      |      |      |      |      |      |
| Channel   | 36   | 40   | 48   | 52   | 56   | 64   | 100  | 120  | 144  | 149  | 157  | 165  |
| Port 1  | 7.5  | 7.8  | 8.0  | 8.2  | 8.1  | 7.5  | 7.7  | 7.8  | 7.7  | 9.2  | 9.0  | 8.5  |
| Port 2  | 6.6  | 7.1  | 7.4  | 7.3  | 7.4  | 7.1  | 7.0  | 7.3  | 7.2  | 9.3  | 9.1  | 8.9  |
| SUM   | 10.1 | 10.5 | 10.8 | 10.8 | 10.7 | 10.3 | 10.4 | 10.6 | 10.5 | 12.3 | 12.1 | 11.7 |

| 802.11ax HE20                                     |     |      |      |      |      |     |     |      |      |      |      |      |
|---|-----|------|------|------|------|-----|-----|------|------|------|------|------|
| Power spectral density [dBm/1MHz] or [dBm/500kHz] |     |      |      |      |      |     |     |      |      |      |      |      |
| Channel   | 36  | 40   | 48   | 52   | 56   | 64  | 100 | 120  | 144  | 149  | 157  | 165  |
| Port 1  | 5.1 | 7.9  | 7.8  | 7.9  | 7.9  | 5.2 | 7.0 | 7.8  | 7.6  | 8.9  | 9.0  | 8.3  |
| Port 2  | 4.4 | 7.1  | 7.5  | 7.3  | 7.2  | 4.8 | 6.3 | 7.1  | 7.1  | 9.0  | 8.9  | 8.8  |
| SUM   | 7.8 | 10.5 | 10.6 | 10.6 | 10.6 | 8.0 | 9.7 | 10.5 | 10.4 | 11.9 | 12.0 | 11.6 |

| 802.11 n HT40                                     |      |     |     |      |     |     |     |     |     |
|---|------|-----|-----|------|-----|-----|-----|-----|-----|
| Power spectral density [dBm/1MHz] or [dBm/500kHz] |      |     |     |      |     |     |     |     |     |
| Channel   | 38   | 46  | 54  | 62   | 102 | 118 | 142 | 151 | 159 |
| Port 1  | -0.5 | 5.8 | 6.1 | 0.1  | 1.9 | 6.1 | 6.2 | 6.6 | 6.7 |
| Port 2  | -1.1 | 5.6 | 5.2 | -0.7 | 0.7 | 5.1 | 5.5 | 6.5 | 6.2 |
| SUM   | 2.2  | 8.7 | 8.7 | 2.7  | 4.4 | 8.7 | 8.9 | 9.6 | 9.5 |

| 802.11 ac VHT40                                   |      |     |     |      |     |     |     |     |     |
|---|------|-----|-----|------|-----|-----|-----|-----|-----|
| Power spectral density [dBm/1MHz] or [dBm/500kHz] |      |     |     |      |     |     |     |     |     |
| Channel   | 38   | 46  | 54  | 62   | 102 | 118 | 142 | 151 | 159 |
| Port 1  | 0.1  | 5.9 | 6.2 | 0.2  | 1.9 | 6.2 | 6.1 | 6.6 | 6.6 |
| Port 2  | -0.8 | 5.7 | 5.1 | -0.4 | 0.6 | 4.9 | 5.3 | 6.4 | 6.3 |
| SUM   | 2.7  | 8.8 | 8.7 | 2.9  | 4.3 | 8.6 | 8.7 | 9.5 | 9.5 |

| 802.11ax HE40                                     |      |     |     |      |      |     |     |     |     |
|---|------|-----|-----|------|------|-----|-----|-----|-----|
| Power spectral density [dBm/1MHz] or [dBm/500kHz] |      |     |     |      |      |     |     |     |     |
| Channel   | 38   | 46  | 54  | 62   | 102  | 118 | 142 | 151 | 159 |
| Port 1  | -2.9 | 5.8 | 6.1 | -2.4 | -0.7 | 6.1 | 5.8 | 6.7 | 6.6 |
| Port 2  | -3.8 | 5.6 | 5.2 | -3.5 | -1.9 | 5.0 | 5.1 | 6.5 | 6.2 |
| SUM   | -0.3 | 8.7 | 8.7 | 0.1  | 1.7  | 5.6 | 8.5 | 9.6 | 9.4 |

| 802.11 ac VHT80                                   |      |      |      |     |     |     |
|---|------|------|------|-----|-----|-----|
| Power spectral density [dBm/1MHz] or [dBm/500kHz] |      |      |      |     |     |     |
| Channel   | 42   | 58   | 106  | 122 | 138 | 155 |
| Port 1  | -3.5 | -3.1 | -3.1 | 2.5 | 2.8 | 1.8 |
| Port 2  | -4.2 | -4.2 | -4.3 | 2.3 | 2.4 | 1.2 |
| SUM   | -0.8 | -0.6 | -0.6 | 5.4 | 5.6 | 4.5 |

| 802.11ax HE80                                     |      |      |      |     |     |     |
|---|------|------|------|-----|-----|-----|
| Power spectral density [dBm/1MHz] or [dBm/500kHz] |      |      |      |     |     |     |
| Channel   | 42   | 58   | 106  | 122 | 138 | 155 |
| Port 1  | -5.7 | -5.5 | -6.0 | 2.5 | 2.6 | 1.8 |
| Port 2  | -6.3 | -6.5 | -7.0 | 2.3 | 2.5 | 1.4 |
| SUM   | -3.0 | -3.0 | -3.5 | 5.4 | 5.6 | 4.6 |

## 12.6 Minimum emission bandwidth for the band 5.725-5.85 GHz

Description:

Measurement of the 6 dB bandwidth of the modulated signal.

Measurement:

| Measurement parameter             |   |
|-----------------------------------|---|
| According to: KDB789033 D02, C.2. |   |
| External result file(s)           | 23-1-00614001T004_A6a-h.pdf<br>FCC Part 15.407 & ISED Minimum Emission BW |
| Used test setup:                  | See chapter 7.5 – A   |
| Measurement uncertainty:          | See chapter 9   |

Limits:

| FCC   | ISED |
|---|------|
| The minimum 6 dB bandwidth shall be at least 500 kHz. |      |

Results:

| a      | 6 dB emission bandwidth (MHz)  |                |                 |
|--------|--------------------------------|----------------|-----------------|
|        | U-NII-3 (5725 MHz to 5850 MHz) |                |                 |
|        | Lowest channel                 | Middle channel | Highest channel |
| Port 1 | 16.35                          | 16.35          | 16.35           |
| Port 2 | 16.35                          | 16.35          | 16.30           |

| n HT20 | 6 dB emission bandwidth (MHz)  |                |                 |
|--------|--------------------------------|----------------|-----------------|
|        | U-NII-3 (5725 MHz to 5850 MHz) |                |                 |
|        | Lowest channel                 | Middle channel | Highest channel |
| Port 1 | 17.6                           | 17.6           | 17.6            |
| Port 2 | 17.6                           | 17.6           | 17.6            |

| ac HT20 | 6 dB emission bandwidth (MHz)  |                |                 |
|---------|--------------------------------|----------------|-----------------|
|         | U-NII-3 (5725 MHz to 5850 MHz) |                |                 |
|         | Lowest channel                 | Middle channel | Highest channel |
| Port 1  | 17.6                           | 17.6           | 17.6            |
| Port 2  | 17.6                           | 17.6           | 17.6            |

| ax HE20 | 6 dB emission bandwidth (MHz)  |                |                 |
|---------|--------------------------------|----------------|-----------------|
|         | U-NII-3 (5725 MHz to 5850 MHz) |                |                 |
|         | Lowest channel                 | Middle channel | Highest channel |
| Port 1  | 19.0                           | 19.0           | 19.0            |
| Port 2  | 19.0                           | 19.0           | 18.8            |

Results:

| n HT40 | 6 dB emission bandwidth (MHz)  |                 |
|--------|--------------------------------|-----------------|
|        | U-NII-3 (5725 MHz to 5850 MHz) |                 |
|        | Lowest channel                 | Highest channel |
| Port 1 | 36.3                           | 36.0            |
| Port 2 | 36.3                           | 36.3            |

| ac VHT40 | 6 dB emission bandwidth (MHz)  |                 |
|----------|--------------------------------|-----------------|
|          | U-NII-3 (5725 MHz to 5850 MHz) |                 |
|          | Lowest channel                 | Highest channel |
| Port 1   | 36.3                           | 36.3            |
| Port 2   | 36.3                           | 36.3            |

| ax HE40 | 6 dB emission bandwidth (MHz)  |                 |
|---------|--------------------------------|-----------------|
|         | U-NII-3 (5725 MHz to 5850 MHz) |                 |
|         | Lowest channel                 | Highest channel |
| Port 1  | 36.7                           | 36.4            |
| Port 2  | 37.7                           | 37.7            |

Results:

| ac VHT80 | 6 dB emission bandwidth (MHz)  |  |
|----------|--------------------------------|--|
|          | U-NII-3 (5725 MHz to 5850 MHz) |  |
|          | Middle channel                 |  |
| Port 1   | 76.0                           |  |
| Port 2   | 76.4                           |  |

| ax VHT80 | 6 dB emission bandwidth (MHz)  |  |
|----------|--------------------------------|--|
|          | U-NII-3 (5725 MHz to 5850 MHz) |  |
|          | Middle channel                 |  |
| Port 1   | 76.2                           |  |
| Port 2   | 75.2                           |  |

## 12.7 Spectrum bandwidth / 26 dB bandwidth

Description:

Measurement of the 26 dB bandwidth of the modulated signal.

Measurement:

| Measurement parameter             |  |
|-----------------------------------|--|
| According to: KDB789033 D02, C.1. |  |
| External result file(s)           | 23-1-00614001T004_A6a-h.pdf<br>FCC Part 15.407 & ISED Bandwidths |
| Used test setup:                  | see chapter 7.5 – A  |
| Measurement uncertainty:          | See chapter 9  |

Limits:

| Spectrum Bandwidth – 26 dB Bandwidth  |
|---|
| <p><b>IC:</b> Any unwanted emissions that fall into the band 5250-5350 MHz shall be attenuated below the channel power by at least 26 dB, when measured using a resolution bandwidth between 1 and 5% of the occupied bandwidth (i.e. 99% bandwidth), above 5250 MHz. The 26 dB bandwidth may fall into the 5250-5350 MHz band; however, if the occupied bandwidth also falls within the 5250-5350 MHz band, the transmission is considered as intentional and the devices shall comply with all requirements in the band 5250-5350 MHz including implementing dynamic frequency selection (DFS) and TPC, on the portion of the emission that resides in the 5250-5350 MHz band.</p> <p><b>FCC:</b> Radar Detection Function of Dynamic Frequency Selection (DFS). U-NII devices operating with any part of its 26 dB emission bandwidth in the 5.25-5.35 GHz and 5.47-5.725 GHz bands shall employ a DFS radar detection mechanism to detect the presence of radar systems and to avoid co-channel operation with radar systems.</p> |

| 802.11a<br>26 dB bandwidth [MHz] |      |      |       |      |      |      |      |      |      |      |      |      |
|----------------------------------|------|------|-------|------|------|------|------|------|------|------|------|------|
| Channel                          | 36   | 40   | 48    | 52   | 56   | 64   | 100  | 120  | 144  | 149  | 157  | 165  |
| Port 1                           | 21.4 | 21.7 | 21.6* | 21.6 | 21.6 | 21.4 | 21.4 | 21.6 | 21.6 | 35.5 | 38.7 | 39.3 |
| Port 2                           | 21.4 | 17.1 | 21.7* | 21.6 | 21.6 | 21.6 | 21.7 | 21.7 | 21.6 | 35.6 | 38.7 | 39.0 |

| 802.11n HT20<br>26 dB bandwidth [MHz] |      |      |       |      |      |      |      |      |      |      |      |      |
|---------------------------------------|------|------|-------|------|------|------|------|------|------|------|------|------|
| Channel                               | 36   | 40   | 48    | 52   | 56   | 64   | 100  | 120  | 144  | 149  | 157  | 165  |
| Port 1                                | 21.7 | 22.0 | 22.0* | 26.0 | 22.0 | 21.7 | 21.7 | 22.0 | 22.0 | 40.0 | 40.0 | 40.0 |
| Port 2                                | 21.5 | 21.8 | 26.4* | 23.5 | 21.7 | 21.6 | 21.4 | 22.1 | 21.8 | 39.9 | 40.0 | 39.9 |

| 802.11ac VHT20<br>26 dB bandwidth [MHz] |      |      |       |      |      |      |      |      |      |      |      |      |
|---|------|------|-------|------|------|------|------|------|------|------|------|------|
| Channel                                 | 36   | 40   | 48    | 52   | 56   | 64   | 100  | 120  | 144  | 149  | 157  | 165  |
| Port 1                                  | 21.9 | 22.4 | 23.7* | 23.7 | 22.0 | 21.9 | 21.7 | 22.0 | 22.0 | 39.9 | 40.0 | 40.0 |
| Port 2                                  | 21.5 | 21.9 | 23.4* | 22.1 | 22.2 | 21.6 | 21.7 | 22.1 | 21.7 | 39.2 | 40.0 | 40.0 |

| 802.11ax HE20<br>26 dB bandwidth [MHz] |      |      |       |      |      |      |      |      |      |      |      |      |
|--|------|------|-------|------|------|------|------|------|------|------|------|------|
| Channel                                | 36   | 40   | 48    | 52   | 56   | 64   | 100  | 120  | 144  | 149  | 157  | 165  |
| Port 1                                 | 22.0 | 22.5 | 21.8* | 22.0 | 21.9 | 22.0 | 21.9 | 21.8 | 22.1 | 39.8 | 40.0 | 40.0 |
| Port 2                                 | 21.7 | 23.3 | 23.3* | 23.4 | 22.0 | 21.7 | 22.0 | 21.9 | 21.7 | 39.4 | 40.0 | 40.0 |

Where the 26dB emission bandwidth extends the band 5150MHz to 5250 MHz (channel 48) the 99% bandwidth was used in lieu of the 26dB bandwidth (see KDB 789033 D02 B.2.a) (i)).

Where the 26dB emission bandwidth does extend the 5725 – 5850 MHz band the 20dB bandwidth was measured to show compliance with §15.215(c). The 20dB bandwidth is reported in **23-1-00614001T004\_A6a-h** and compliant with the §15.215 (c) requirement.



| 802.11n HT40<br>26 dB bandwidth [MHz] |      |       |       |      |      |      |      |      |      |
|---------------------------------------|------|-------|-------|------|------|------|------|------|------|
| Channel                               | 38   | 46    | 54    | 62   | 102  | 118  | 142  | 151  | 159  |
| Port 1                                | 39.8 | 55.5* | 55.8* | 39.8 | 39.9 | 50.6 | 44.2 | 80.0 | 80.0 |
| Port 2                                | 39.6 | 51.9* | 54.3* | 39.4 | 39.6 | 52.7 | 39.6 | 79.5 | 80.0 |

| 802.11ac HT40<br>26 dB bandwidth [MHz] |      |      |       |      |      |      |      |      |      |
|--|------|------|-------|------|------|------|------|------|------|
| Channel                                | 38   | 46   | 54    | 62   | 102  | 118  | 142  | 151  | 159  |
| Port 1                                 | 39.8 | 50.0 | 56.8* | 39.9 | 39.9 | 55.0 | 46.0 | 80.0 | 80.0 |
| Port 2                                 | 39.3 | 52.7 | 46.6* | 39.5 | 39.4 | 46.3 | 39.8 | 80.0 | 80.0 |

| 802.11ax HE40<br>26 dB bandwidth [MHz] |      |      |       |      |      |      |      |      |      |
|--|------|------|-------|------|------|------|------|------|------|
| Channel                                | 38   | 46   | 54    | 62   | 102  | 118  | 142  | 151  | 159  |
| Port 1                                 | 40.1 | 54.2 | 54.6* | 40.2 | 40.2 | 53.1 | 44.2 | 79.9 | 80.0 |
| Port 2                                 | 39.9 | 54.3 | 40.8* | 39.9 | 40.1 | 41.0 | 40.1 | 78.6 | 79.7 |

Where the 26dB emission bandwidth extends the band 5150MHz to 5250 MHz (channel 48) the 99% bandwidth was used in lieu of the 26dB bandwidth (see KDB 789033 D02 B.2.a) (i)).

Where the 26dB emission bandwidth does extend the 5725 – 5850 MHz band the 20dB bandwidth was measured to show compliance with §15.215(c). The 20dB bandwidth is reported in **23-1-00614001T004\_A6a-h** and compliant with the §15.215 (c) requirement.

| 802.11ac VHT80<br>26 dB bandwidth [MHz] |      |       |      |       |      |       |
|---|------|-------|------|-------|------|-------|
| Channel                                 | 42   | 58    | 106  | 122   | 138  | 155   |
| Port 1                                  | 81.4 | 81.4* | 81.8 | 117.1 | 82.6 | 140.3 |
| Port 2                                  | 80.8 | 81.0* | 81.3 | 104.3 | 81.6 | 128.3 |

| 802.11ax HE80<br>26 dB bandwidth [MHz] |      |       |      |      |      |       |
|--|------|-------|------|------|------|-------|
| Channel                                | 42   | 58    | 106  | 122  | 138  | 155   |
| Port 1                                 | 81.3 | 81.1* | 81.4 | 81.9 | 81.9 | 120.8 |
| Port 2                                 | 81.4 | 80.8* | 81.1 | 86.7 | 81.1 | 108.6 |

\*Where the 26dB emission bandwidth extends the band 5150MHz to 5250 MHz (channel 48) the 99% bandwidth was used in lieu of the 26dB bandwidth (see KDB 789033 D02 B.2.a) (i)).

Where the 26dB emission bandwidth does extend the 5725 – 5850 MHz band the 20dB bandwidth was measured to show compliance with §15.215(c). The 20dB bandwidth is reported in **23-1-00614001T004\_A6a-h** and compliant with the §15.215 (c) requirement.

## 12.8 Occupied bandwidth / 99% emission bandwidth

Description:

Measurement of the 99% bandwidth of the modulated signal acc. RSS-GEN.

Measurement:

| Measurement parameter    |  |
|--------------------------|--|
| External result file(s)  | 23-1-00614001T004_A6a-h.pdf<br>FCC Part 15.407 & ISED Bandwidths |
| Test setup:              | See sub clause 7.5 – A   |
| Measurement uncertainty: | See chapter 9  |

Usage:

| -/-                                      | ISED |
|--|------|
| OBW is necessary for Emission Designator |      |

Results:

| 802.11a<br>99% bandwidth [MHz] |      |      |      |      |      |      |      |      |      |      |      |      |
|--------------------------------|------|------|------|------|------|------|------|------|------|------|------|------|
| Channel                        | 36   | 40   | 48   | 52   | 56   | 64   | 100  | 120  | 144  | 149  | 157  | 165  |
| Port 1                         | 17.0 | 17.2 | 17.2 | 17.3 | 17.2 | 17.0 | 17.0 | 17.2 | 17.2 | 20.1 | 22.3 | 24.2 |
| Port 2                         | 16.9 | 21.6 | 17.1 | 17.1 | 17.1 | 16.9 | 16.9 | 17.1 | 17.1 | 19.9 | 23.7 | 23.9 |

| 802.11n HT20<br>99% bandwidth [MHz] |      |      |      |      |      |      |      |      |      |      |      |      |
|-------------------------------------|------|------|------|------|------|------|------|------|------|------|------|------|
| Channel                             | 36   | 40   | 48   | 52   | 56   | 64   | 100  | 120  | 144  | 149  | 157  | 165  |
| Port 1                              | 18.1 | 18.3 | 18.3 | 18.3 | 18.3 | 18.1 | 18.2 | 18.3 | 18.3 | 21.5 | 24.0 | 25.4 |
| Port 2                              | 17.8 | 18.0 | 18.1 | 18.0 | 18.0 | 17.8 | 17.9 | 18.1 | 18.0 | 22.5 | 25.5 | 25.4 |

| 802.11ac VHT20<br>99% bandwidth [MHz] |      |      |      |      |      |      |      |      |      |      |      |      |
|---------------------------------------|------|------|------|------|------|------|------|------|------|------|------|------|
| Channel                               | 36   | 40   | 48   | 52   | 56   | 64   | 100  | 120  | 144  | 149  | 157  | 165  |
| Port 1                                | 18.1 | 18.3 | 18.4 | 18.4 | 18.3 | 18.1 | 18.1 | 18.3 | 18.3 | 22.8 | 22.8 | 25.2 |
| Port 2                                | 17.8 | 18.1 | 18.1 | 18.0 | 18.1 | 17.8 | 17.9 | 18.1 | 18.0 | 22.9 | 25.1 | 24.8 |

| 802.11ax HE20<br>99% bandwidth [MHz] |      |      |      |      |      |      |      |      |      |      |      |      |
|--------------------------------------|------|------|------|------|------|------|------|------|------|------|------|------|
| Channel                              | 36   | 40   | 48   | 52   | 56   | 64   | 100  | 120  | 144  | 149  | 157  | 165  |
| Port 1                               | 19.2 | 19.3 | 19.2 | 19.2 | 19.2 | 19.2 | 19.2 | 19.2 | 19.2 | 20.6 | 23.6 | 24.6 |
| Port 2                               | 19.1 | 19.2 | 19.2 | 19.2 | 19.2 | 19.1 | 19.2 | 19.2 | 19.2 | 21.6 | 25.6 | 25.8 |

| 802.11n HT40<br>99% bandwidth [MHz] |      |      |      |      |      |      |      |      |      |
|-------------------------------------|------|------|------|------|------|------|------|------|------|
| Channel                             | 38   | 46   | 54   | 62   | 102  | 118  | 134  | 151  | 159  |
| Port 1                              | 36.3 | 36.7 | 36.7 | 36.4 | 36.4 | 36.7 | 36.7 | 53.7 | 54.2 |
| Port 2                              | 36.2 | 36.6 | 36.4 | 36.2 | 36.3 | 36.4 | 36.4 | 42.2 | 50.2 |

| 802.11ac VHT40<br>99% bandwidth [MHz] |      |      |      |      |      |      |      |      |      |
|---------------------------------------|------|------|------|------|------|------|------|------|------|
| Channel                               | 38   | 46   | 54   | 62   | 102  | 118  | 134  | 151  | 159  |
| Port 1                                | 36.4 | 36.7 | 36.8 | 36.4 | 36.4 | 36.7 | 36.6 | 52.8 | 53.3 |
| Port 2                                | 36.1 | 36.4 | 36.4 | 36.2 | 36.2 | 36.4 | 36.4 | 42.1 | 50.1 |

| 802.11ax HE40<br>99% bandwidth [MHz] |      |      |      |      |      |      |      |      |      |
|--------------------------------------|------|------|------|------|------|------|------|------|------|
| Channel                              | 38   | 46   | 54   | 62   | 102  | 118  | 134  | 151  | 159  |
| Port 1                               | 37.6 | 37.8 | 37.8 | 37.6 | 37.6 | 37.8 | 37.6 | 46.5 | 45.8 |
| Port 2                               | 37.6 | 37.8 | 37.7 | 37.6 | 37.7 | 37.8 | 37.6 | 41.5 | 47.4 |

| 802.11ac VHT80<br>99% bandwidth [MHz] |      |      |      |      |      |      |
|---------------------------------------|------|------|------|------|------|------|
| Channel                               | 42   | 58   | 106  | 122  | 138  | 155  |
| Port 1                                | 75.7 | 75.5 | 75.5 | 75.9 | 76.1 | 76.7 |
| Port 2                                | 75.3 | 75.5 | 75.5 | 75.9 | 75.9 | 76.5 |

| 802.11ax HE80<br>99% bandwidth [MHz] |      |      |      |      |      |      |
|--------------------------------------|------|------|------|------|------|------|
| Channel                              | 42   | 58   | 106  | 122  | 138  | 155  |
| Port 1                               | 76.9 | 77.1 | 77.1 | 77.1 | 77.1 | 77.5 |
| Port 2                               | 76.9 | 76.9 | 76.9 | 77.1 | 76.9 | 77.3 |

**12.9 Undesirable emissions for transmitters operating in the 5725 MHz to 5850 MHz band**

Description:

Measurement of the spectrum mask as per FCC Part 15.407 (b)(4) and KDB 789033 II.G.2 (c) (ii).  
 The measurement is repeated at the lowest, middle and highest channel and performed in a conducted way as defined in KDB 789033 II.G.3 (b).

Measurement:

| Measurement parameter    |                        |
|--------------------------|------------------------|
| Detector:                | Peak                   |
| Sweep time:              | Auto                   |
| Resolution bandwidth:    | 1 MHz                  |
| Video bandwidth:         | ≥ 3 x RBW              |
| Span:                    | See plots!             |
| Trace mode:              | Max Hold               |
| Test setup:              | See sub clause 7.3 – A |
| Measurement uncertainty: | See chapter 9          |

Limits:

| FCC Part 15.407 (b)(4)  |
|---|
| All emissions shall be limited to a level of -27 dBm/MHz at 75 MHz or more above or below the band edge increasing linearly to 10 dBm/MHz at 25 MHz above or below the band edge, and from 25 MHz above or below the band edge increasing linearly to a level of 15.6 dBm/MHz at 5 MHz above or below the band edge, and from 5 MHz above or below the band edge increasing linearly to a level of 27 dBm/MHz at the band edge. |

Result:

See plots below

**Plots:**

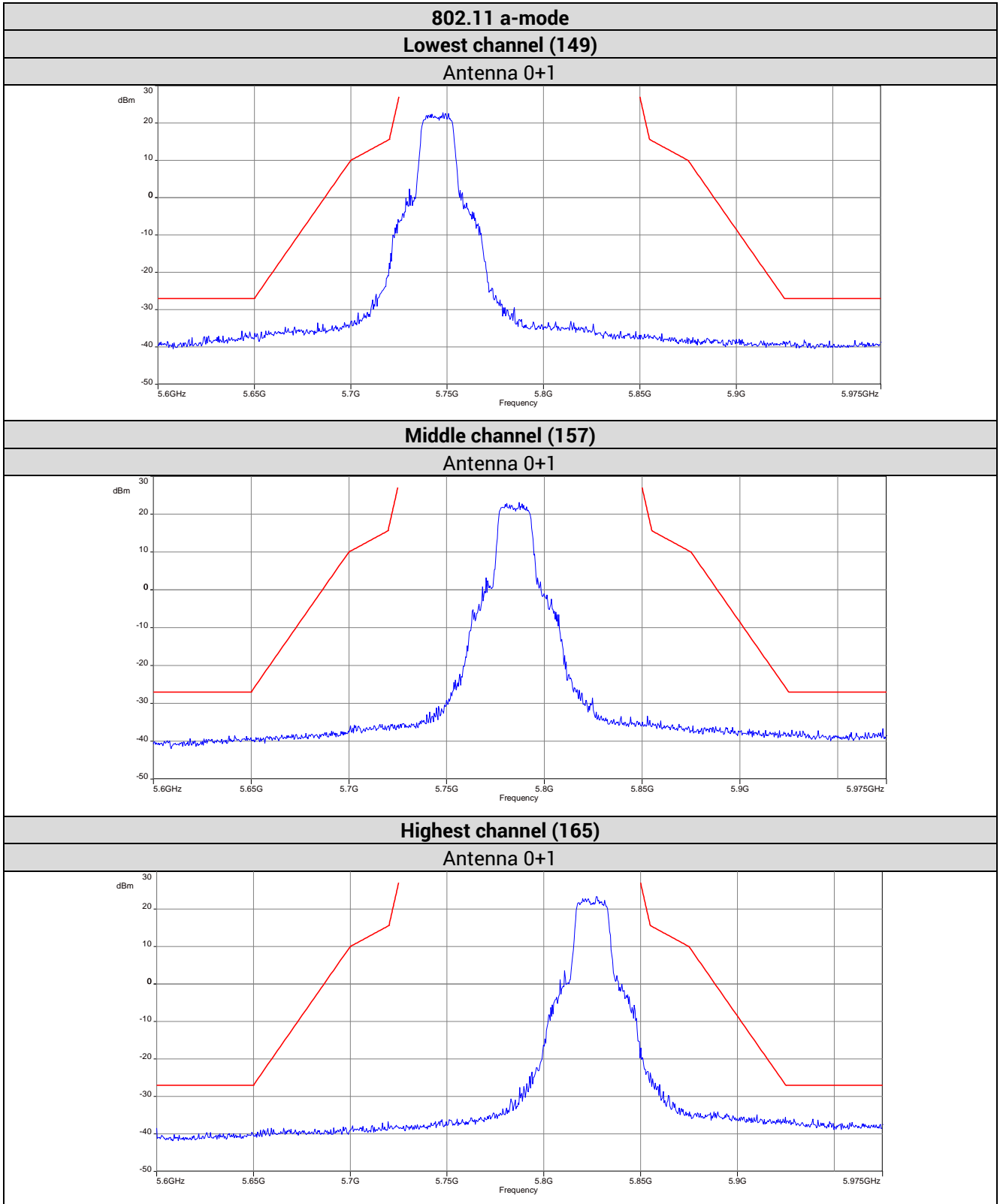

**802.11 n HT20-mode**

**Lowest channel (149)**

**Antenna 0+1**

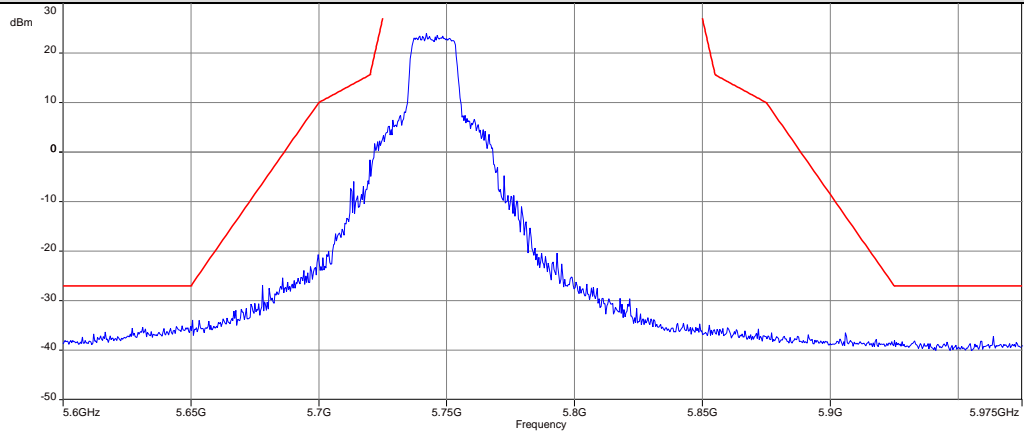

**Middle channel (157)**

**Antenna 0+1**

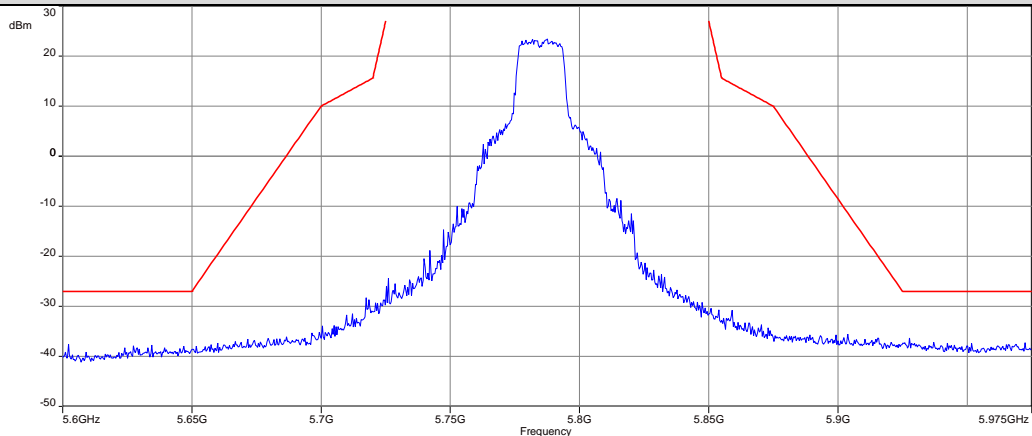

**Highest channel (165)**

**Antenna 0+1**

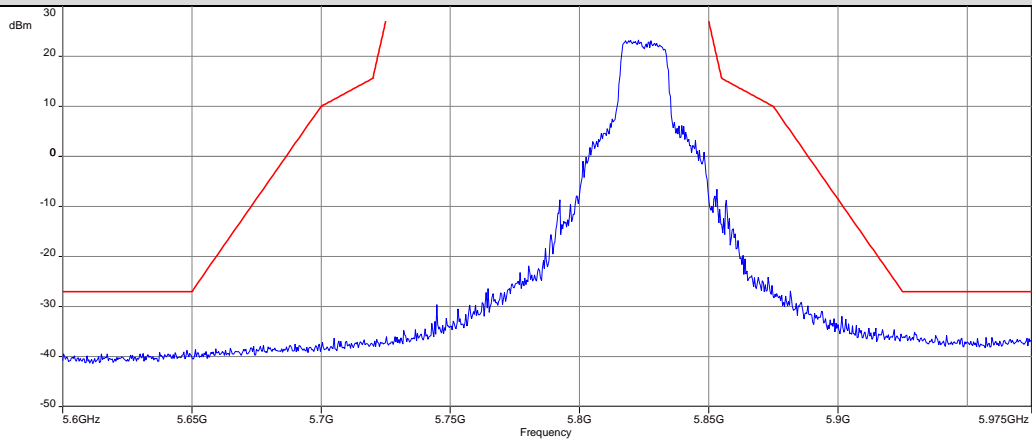

**802.11 ac VHT20-mode**

**Lowest channel (149)**

**Antenna 0+1**

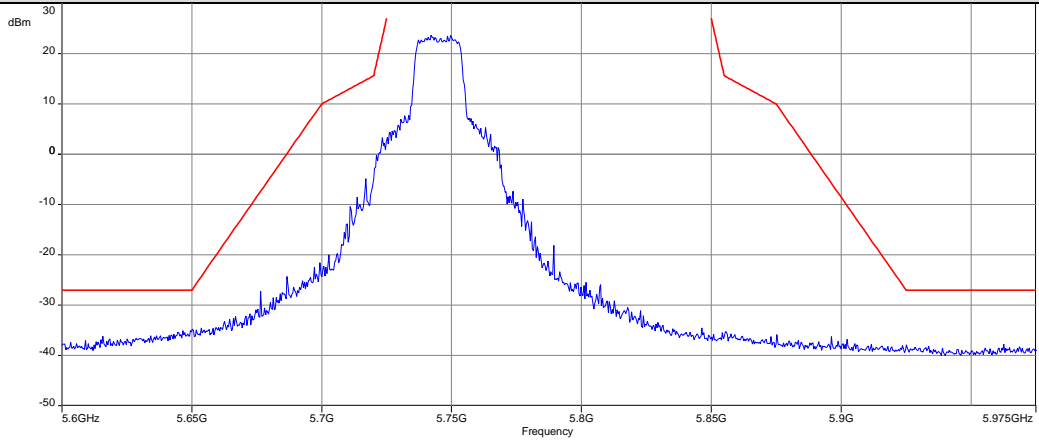

**Middle channel (157)**

**Antenna 0+1**

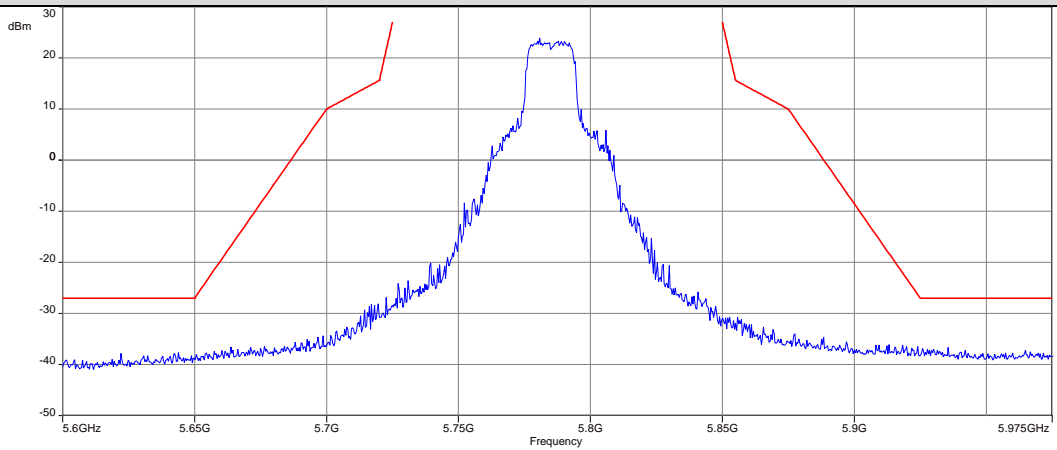

**Highest channel (165)**

**Antenna 0+1**

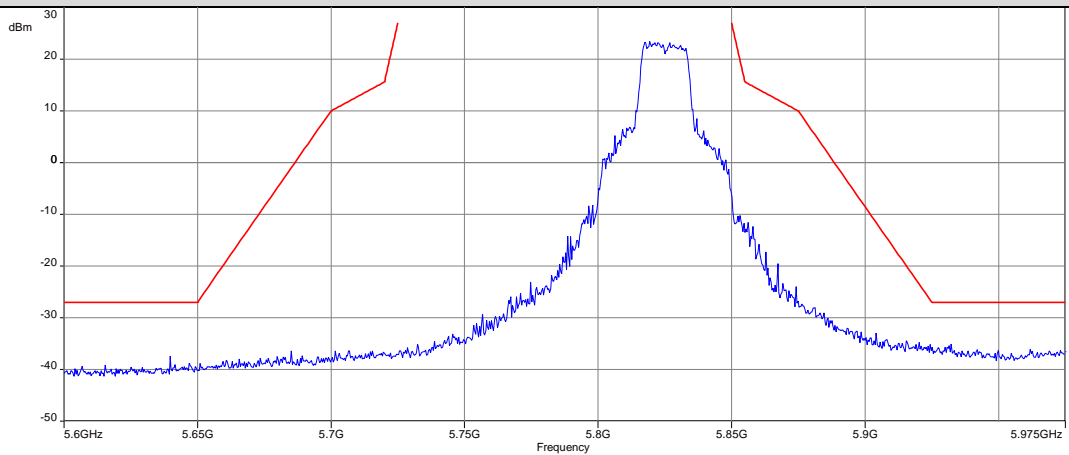



**802.11 ax HE20-mode**

**Lowest channel (149)**

**Antenna 0+1**

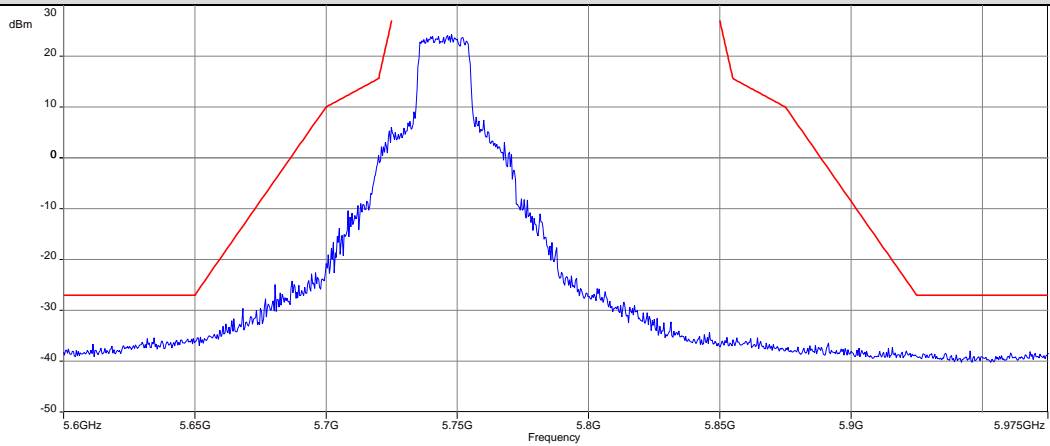

**Middle channel (157)**

**Antenna 0+1**

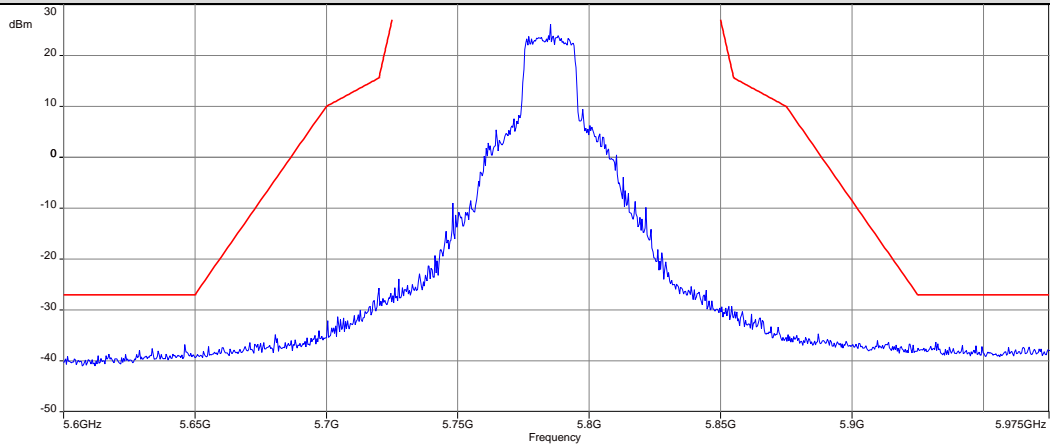

**Highest channel (165)**

**Antenna 0+1**

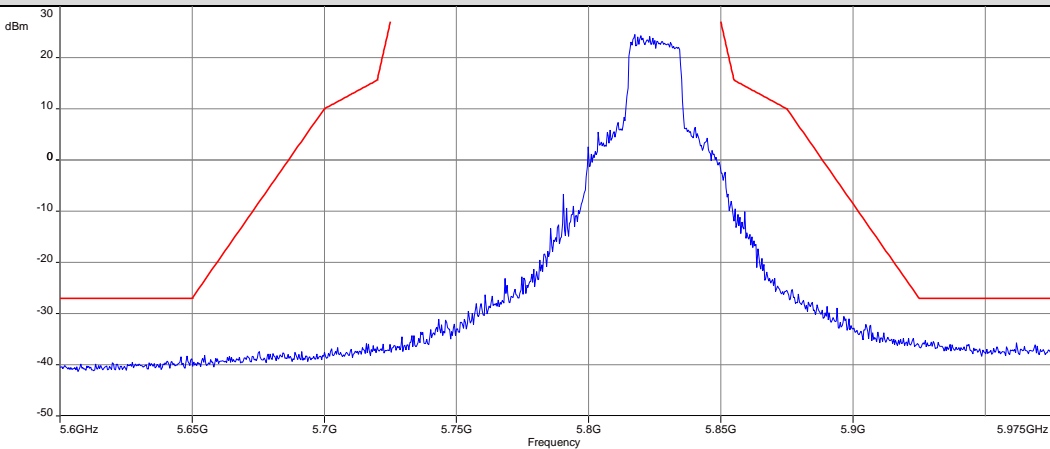

**802.11 n HT40-mode**

**Lowest channel (151)**

**Antenna 0+1**

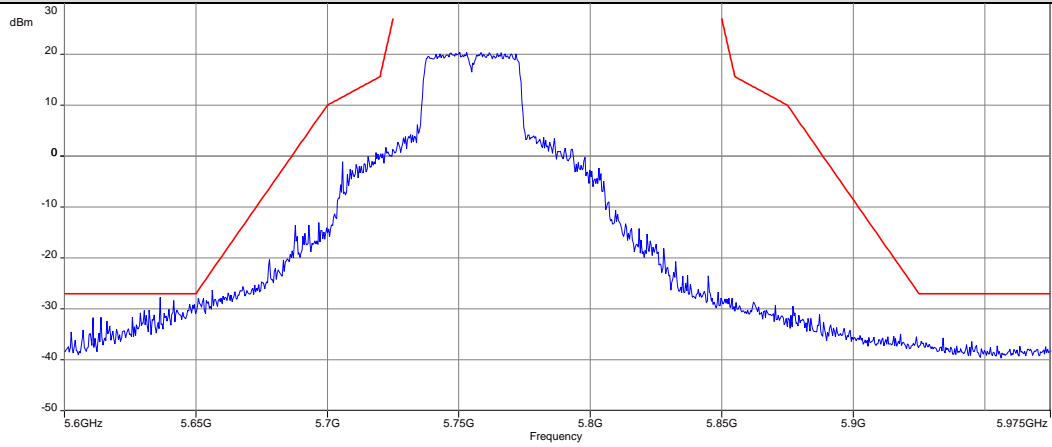

**Highest channel (159)**

**Antenna 0+1**

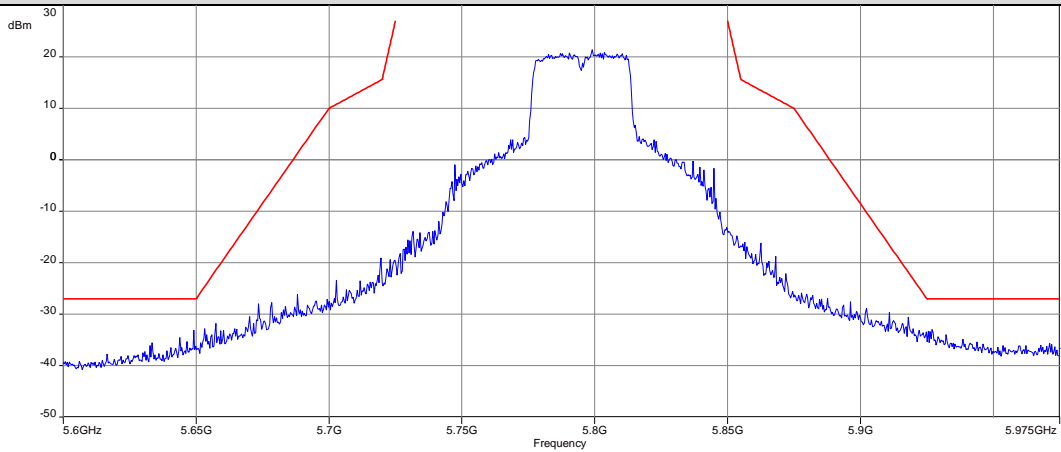

**802.11 ac VHT40-mode**

**Lowest channel (151)**

**Antenna 0+1**

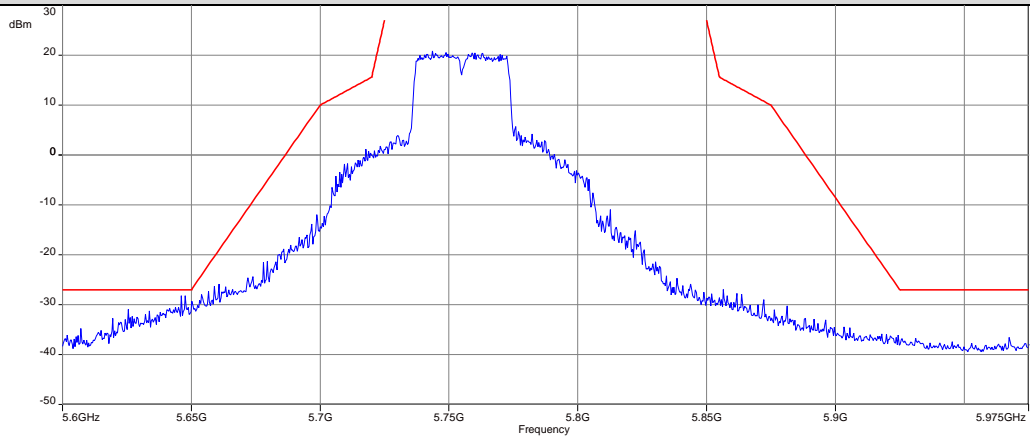

**Highest channel (159)**

**Antenna 0+1**

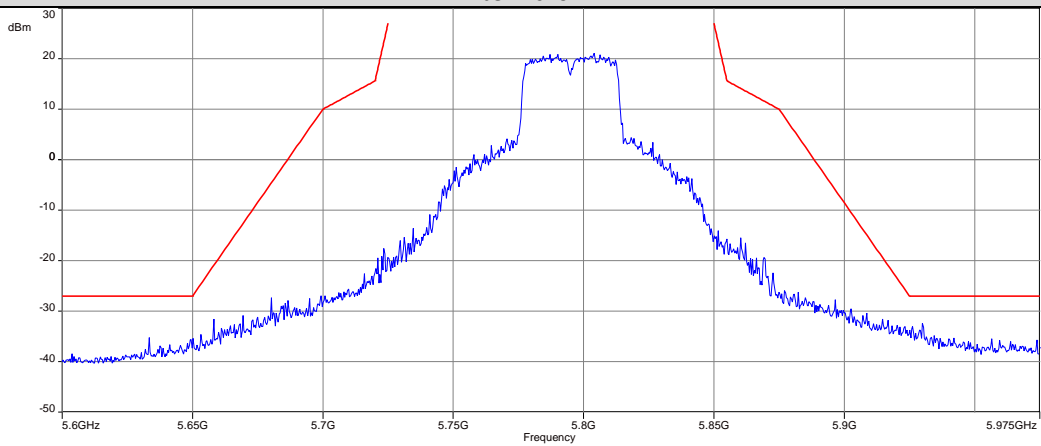

**802.11 ax HE40-mode**

**Lowest channel (151)**

**Antenna 0+1**

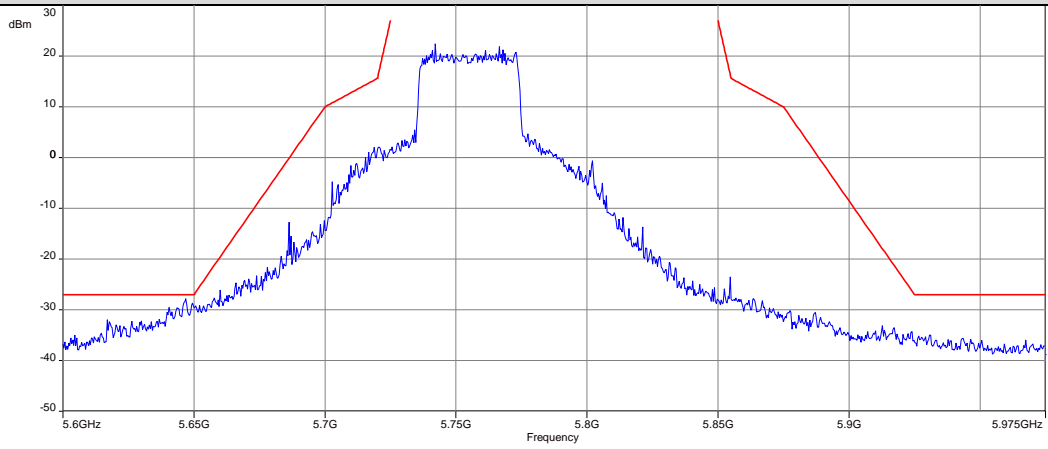

**Highest channel (159)**

**Antenna 0+1**

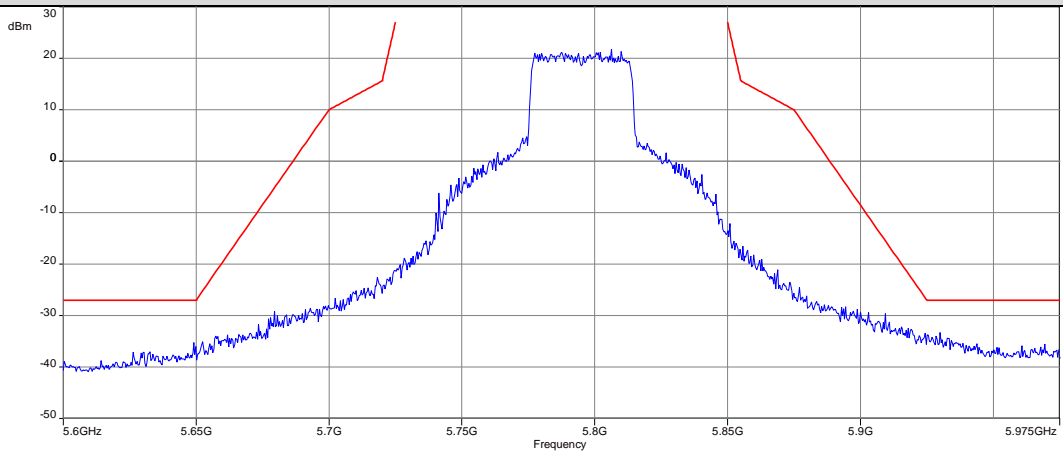

**802.11 ac VHT80-mode**

**Channel (155)**

**Antenna 0+1**

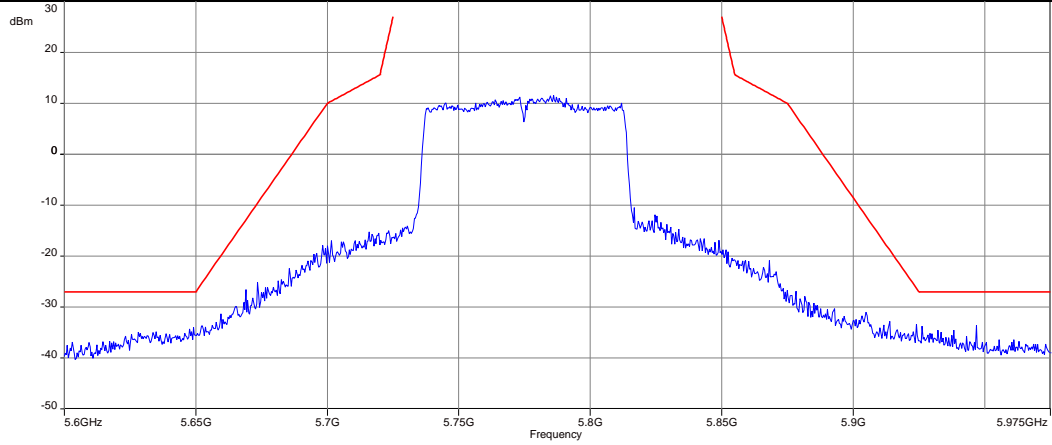

**802.11 ax HE80-mode**

**Lowest channel (155)**

**Antenna 0+1**

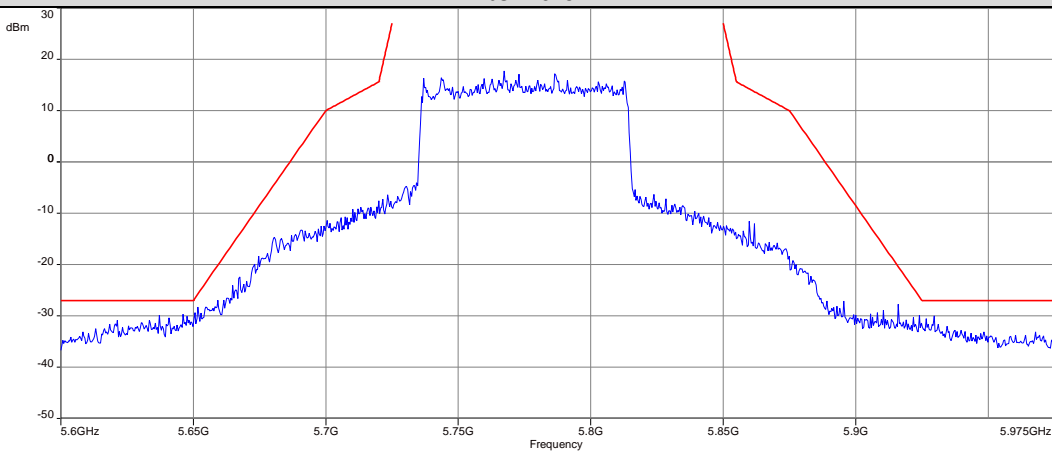

## 12.10 Band edge compliance radiated

**Description:**

Measurement of the radiated band edge compliance. The EUT is turned in the position that results in the maximum level at the band edge. Then a sweep over the corresponding restricted band is performed. The EUT is set to the lowest channel for the lower restricted band and to the highest channel for the upper restricted band. Measurement distance is 3m.

**Measurement:**

| Measurement parameter    |                        |
|--------------------------|------------------------|
| Detector:                | Peak / RMS             |
| Sweep time:              | Auto                   |
| Resolution bandwidth:    | 1 MHz                  |
| Video bandwidth:         | ≥ 3 x RBW              |
| Span:                    | See plots!             |
| Trace mode:              | Max Hold               |
| Test setup:              | See sub clause 6.2 – A |
| Measurement uncertainty: | See chapter 9          |

**Limits:**

| Band Edge Compliance Radiated  |
|--|
| In any 100 kHz bandwidth outside the frequency band in which the spread spectrum or digitally modulated intentional radiator is operating, the radio frequency power that is produced by the intentional radiator shall be at least 20 dB below that in the 100 kHz bandwidth within the band that contains the highest level of the desired power, based on either an RF conducted or a radiated measurement. Attenuation below the general limits specified in Section 15.209(a) is not required. In addition, radiated emissions which fall in the restricted bands, as defined in Section 15.205(a), must also comply with the radiated emission limits specified in Section 15.209(a) (see Section 5.205(c)). |
| 74 dBµV/m (peak)<br>54 dBµV/m (average)  |

**Result:**

| Scenario  | Band Edge Compliance Radiated [dBµV/m]      |
|-----------|---|
| band edge | < 74 dBµV/m (peak)<br>< 54 dBµV/m (average) |

**Plots:**

**Plot 1:** lower band edge; U-NII-1; lowest channel; a-mode

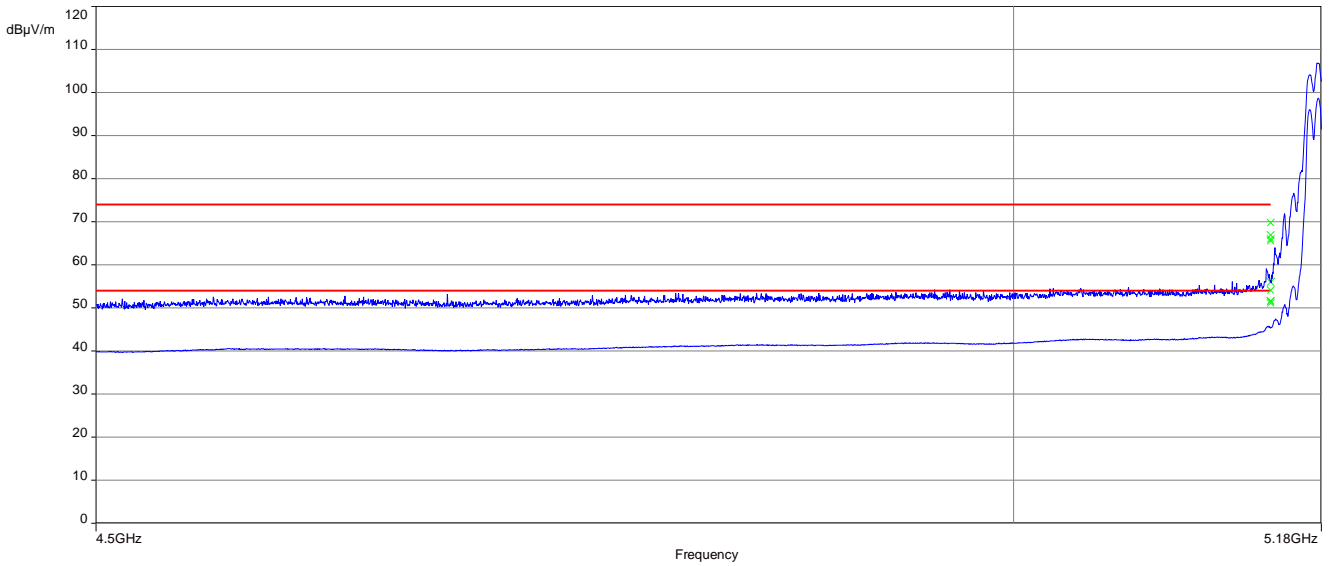

**Plot 2:** upper band edge; U-NII-2A; highest channel; a-mode

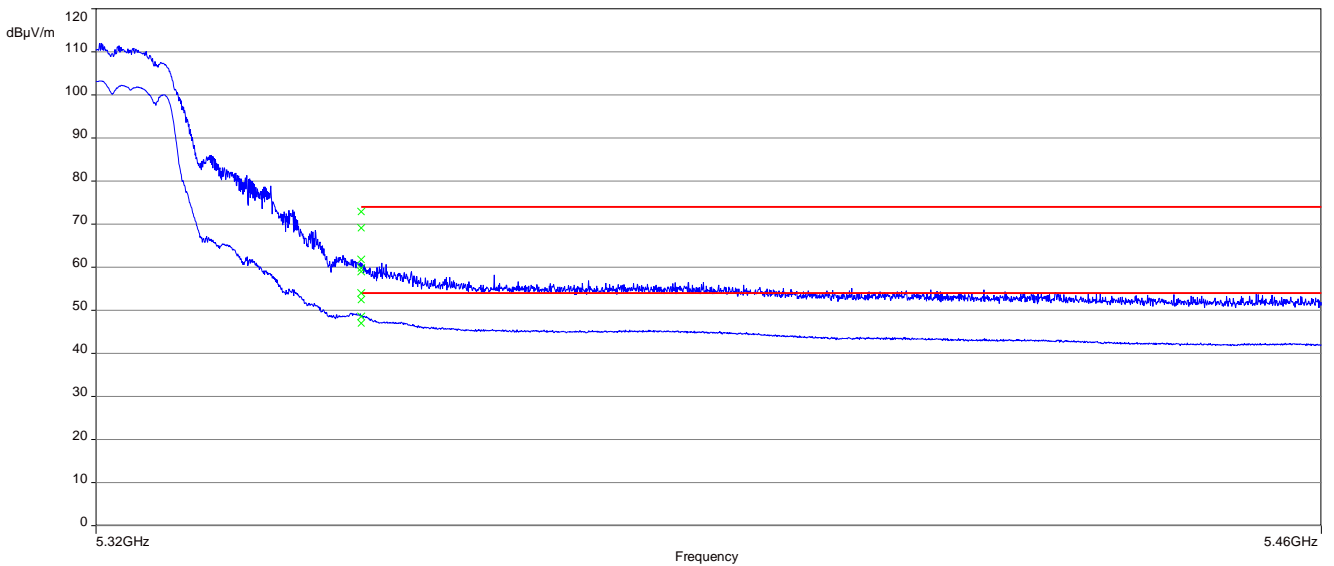

**Plot 3:** lower band edge; U-NII-2C; lowest channel; a-mode

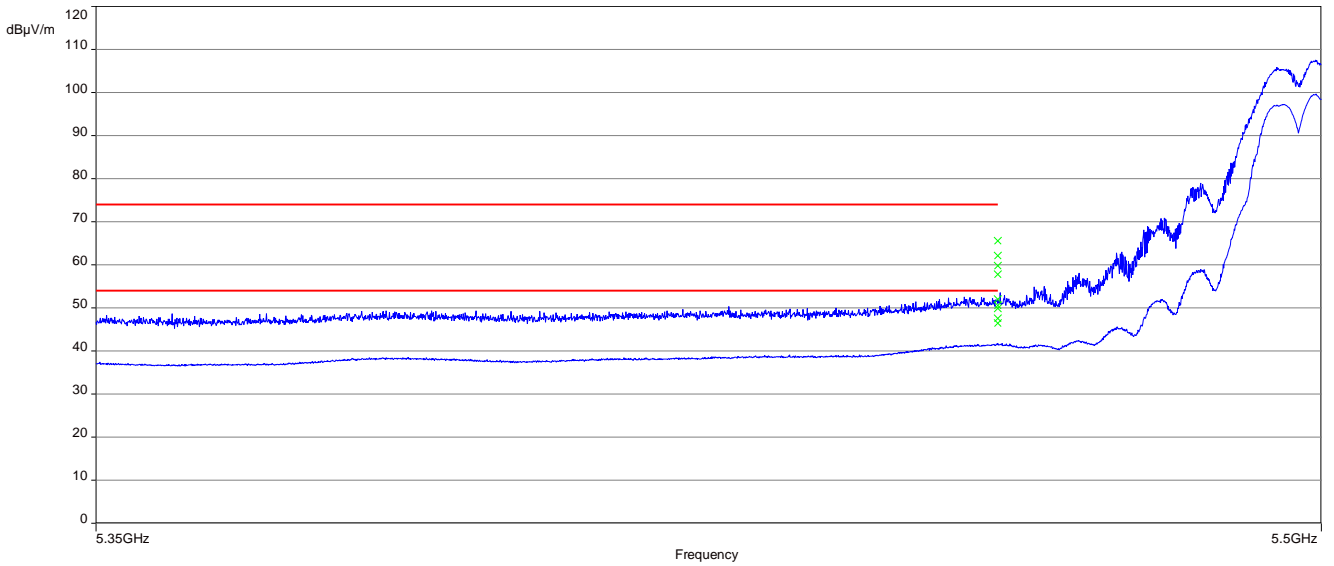

**Plot 4:** lower band edge; U-NII-1; lowest channel; n20-mode

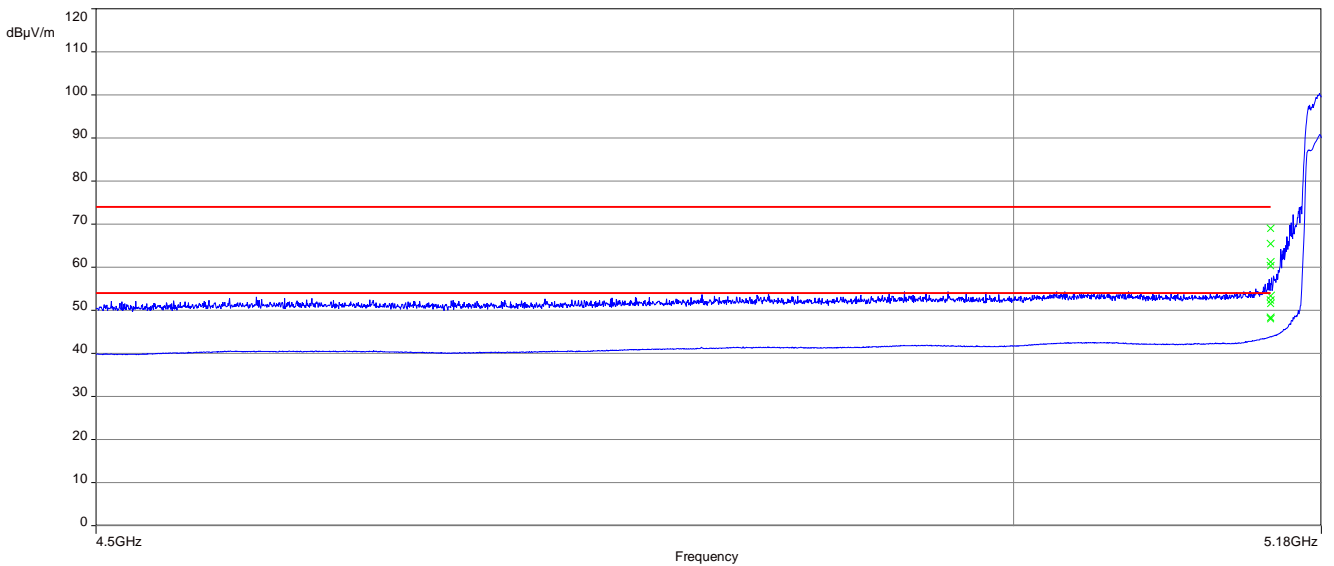



**Plot 5:** upper band edge; U-NII-2A; highest channel; n20-mode

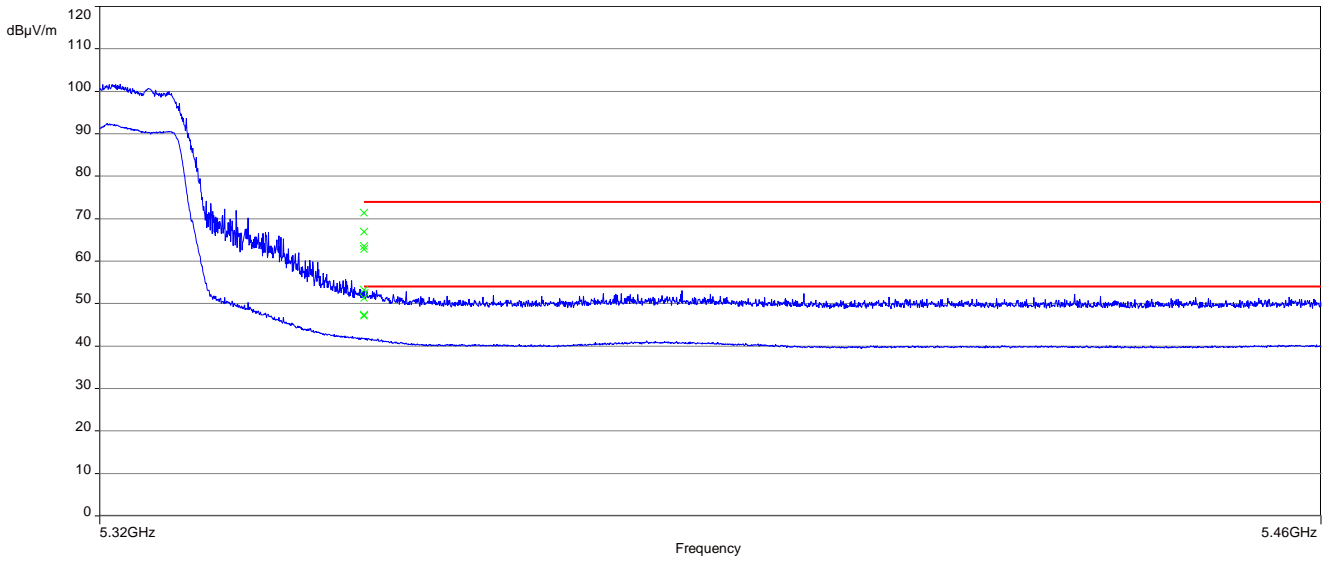

**Plot 6:** lower band edge; U-NII-2C; lowest channel; n20-mode

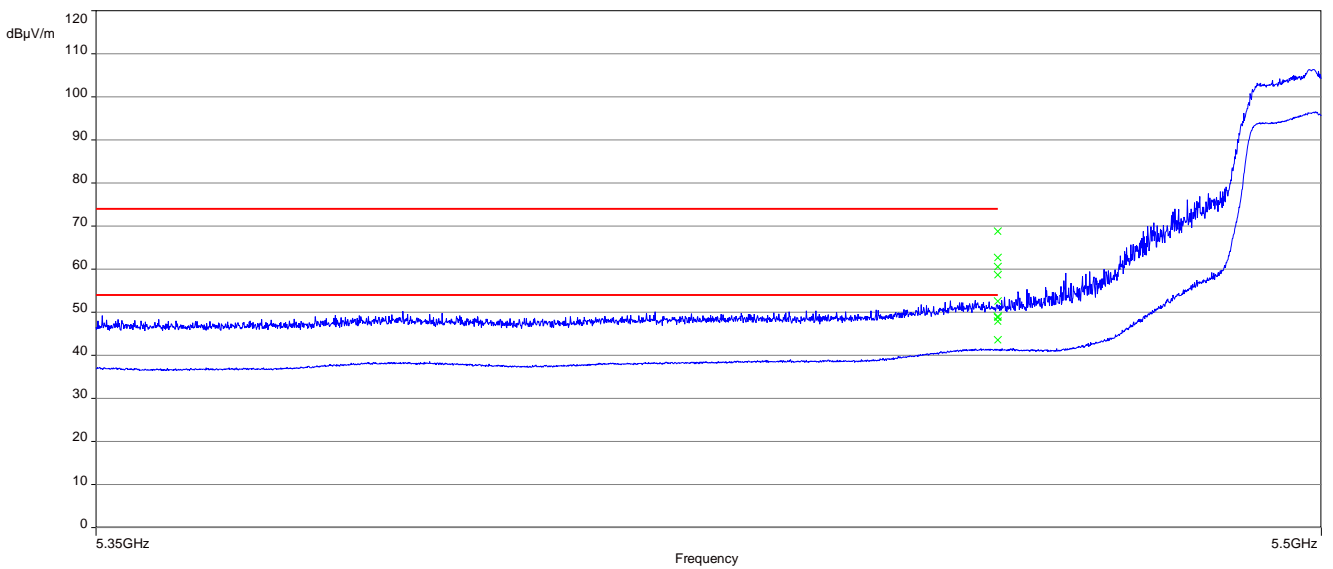

**Plot 7:** lower band edge; U-NII-1; lowest channel; ac20-mode

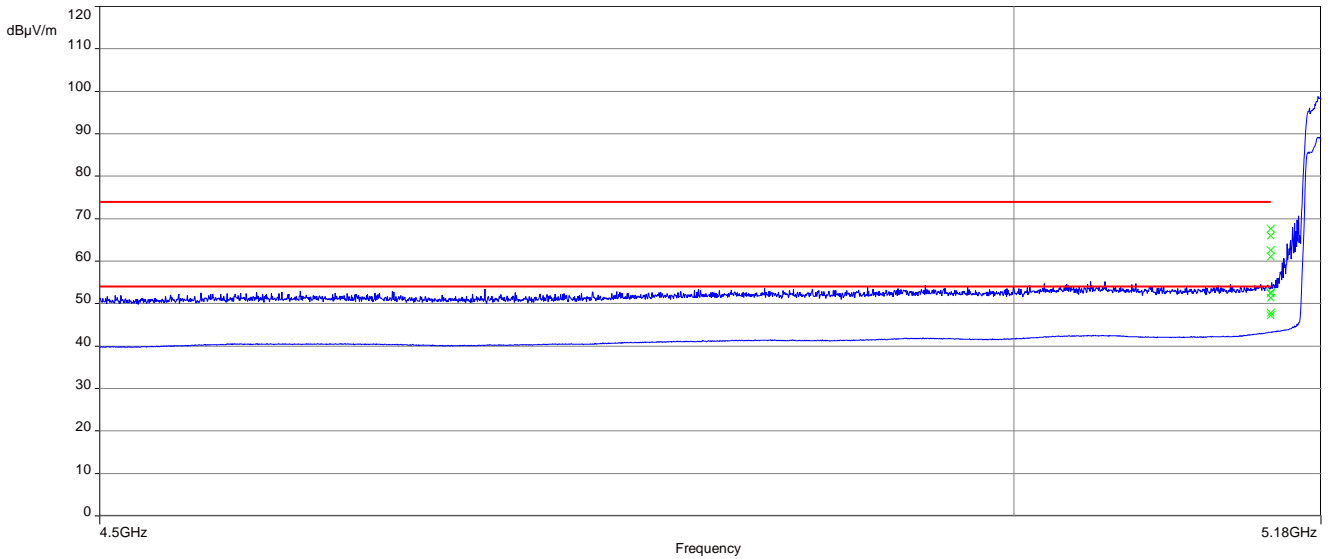

**Plot 8:** upper band edge; U-NII-2A; highest channel; ac20-mode

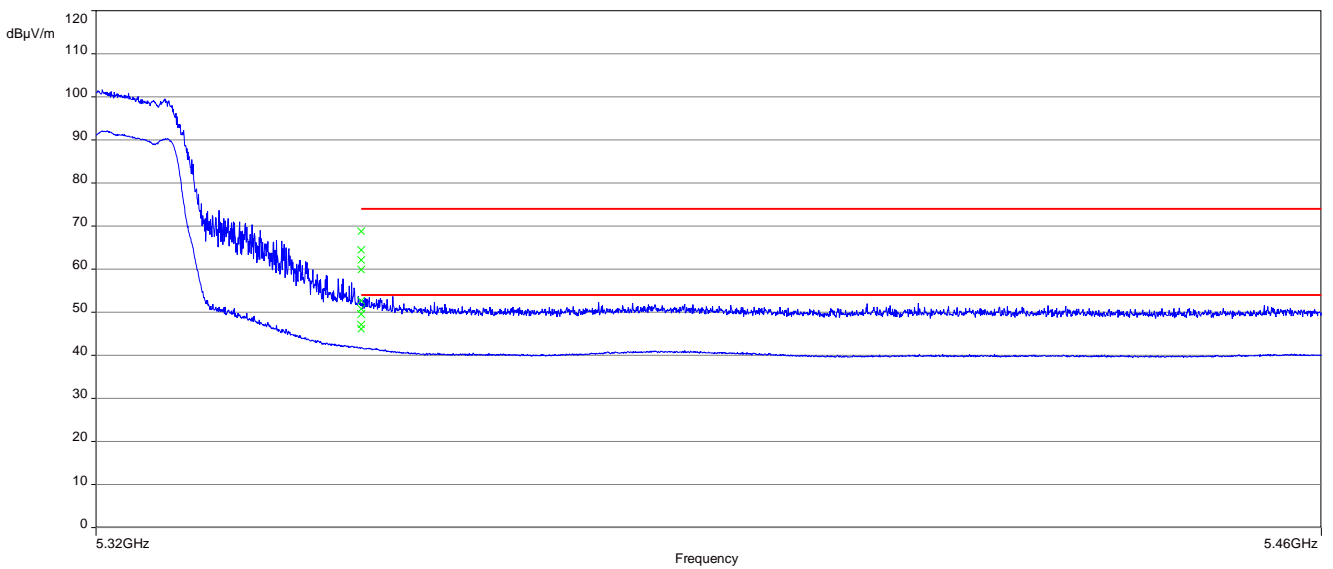

**Plot 9:** lower band edge; U-NII-2C; lowest channel; ac20-mode

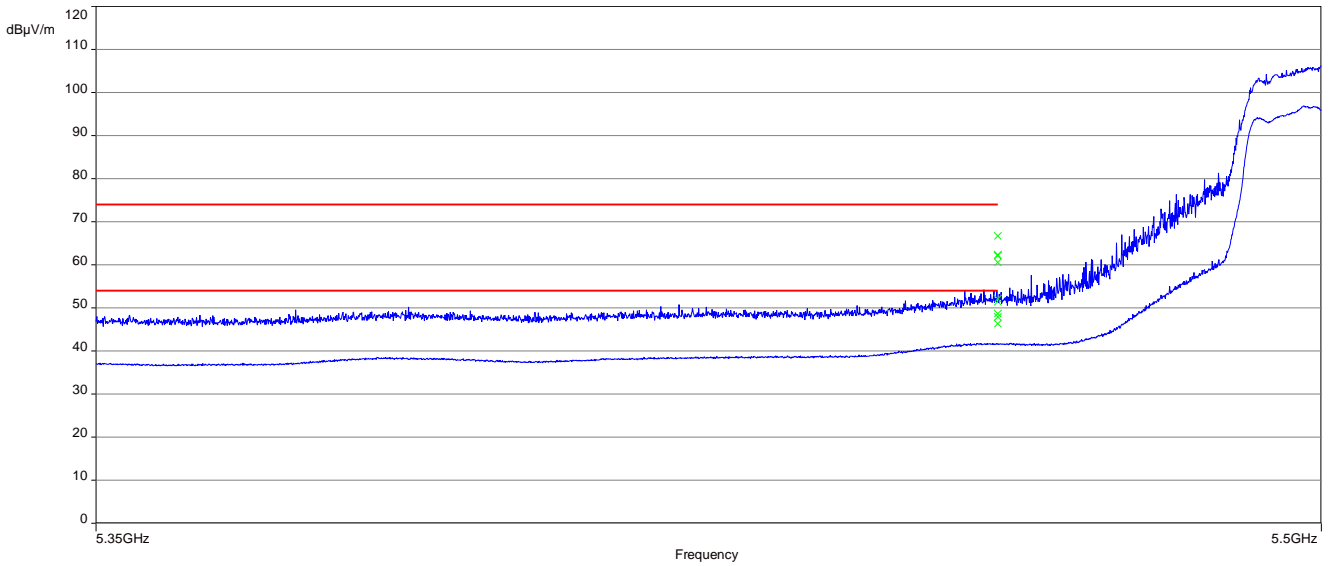

**Plot 10:** lower band edge; U-NII-1; lowest channel; ax20-mode

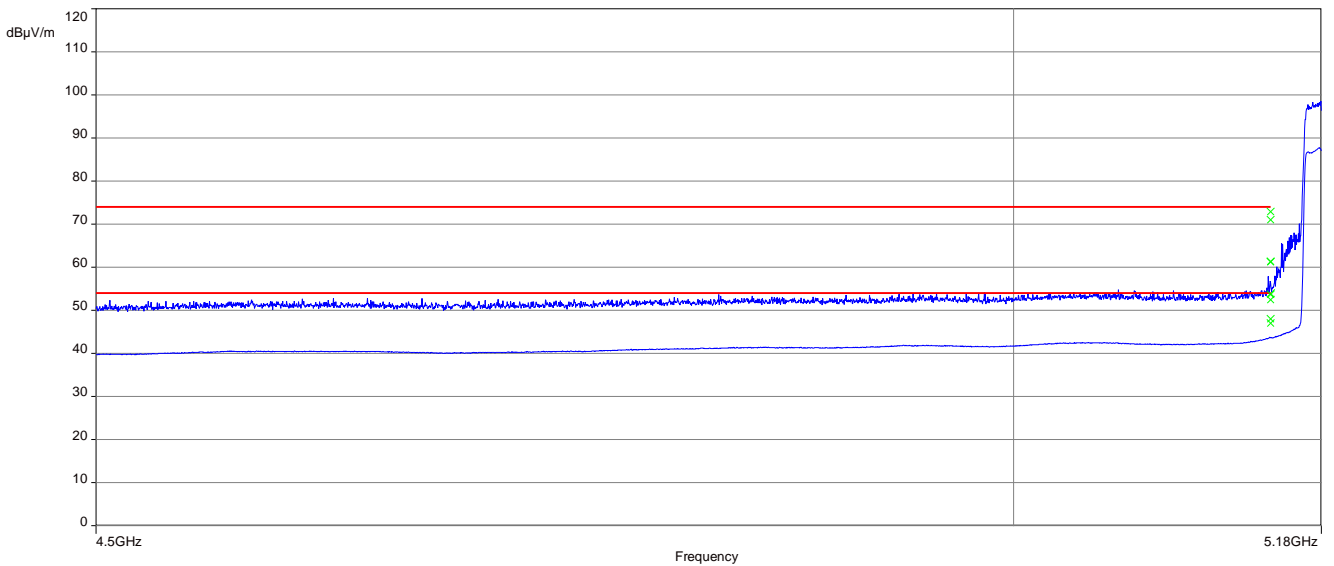

**Plot 11:** upper band edge; U-NII-2A; highest channel; ax20-mode

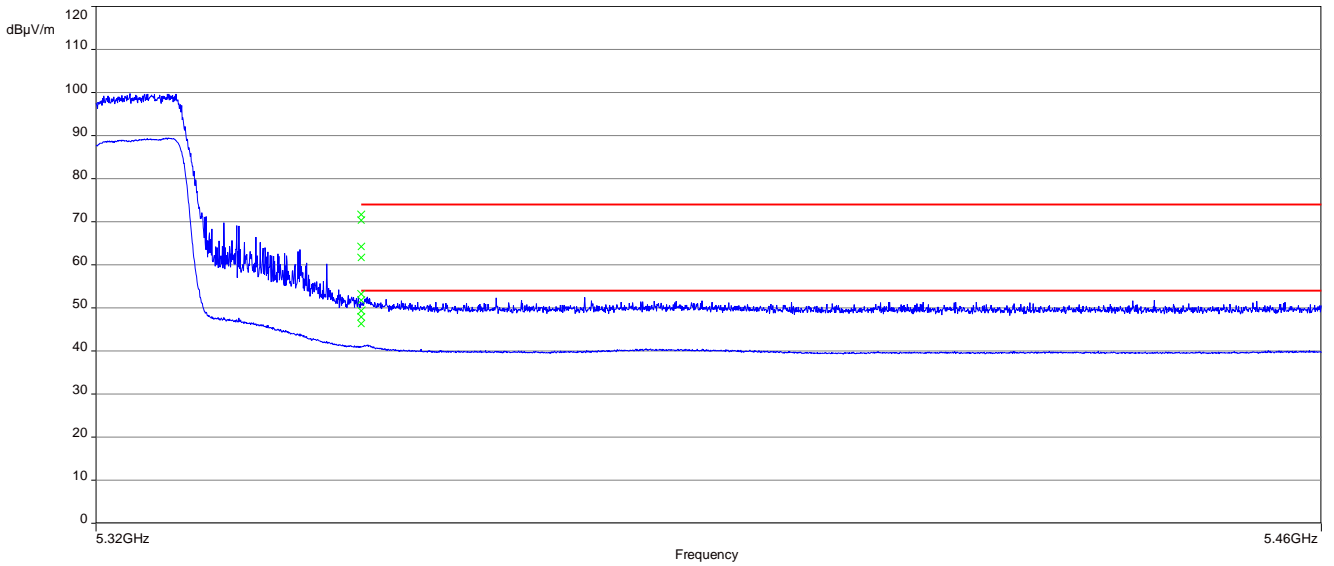

**Plot 12:** lower band edge; U-NII-2C; lowest channel; ax20-mode

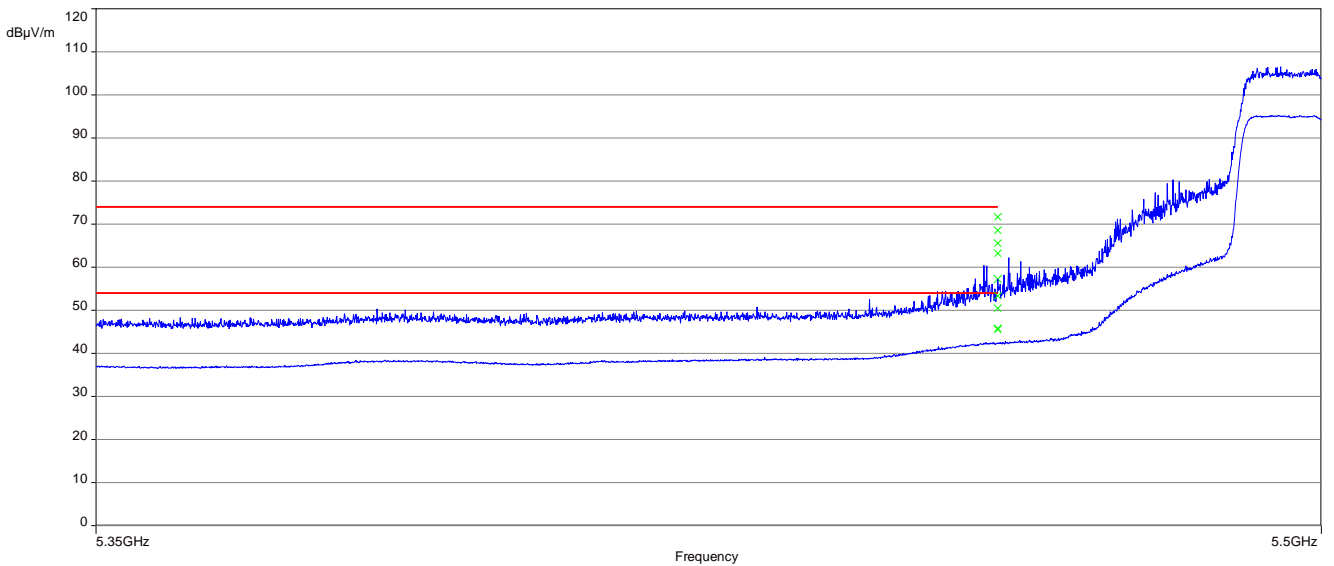

**Plot 13:** lower band edge; U-NII-1; lowest channel; n40-mode

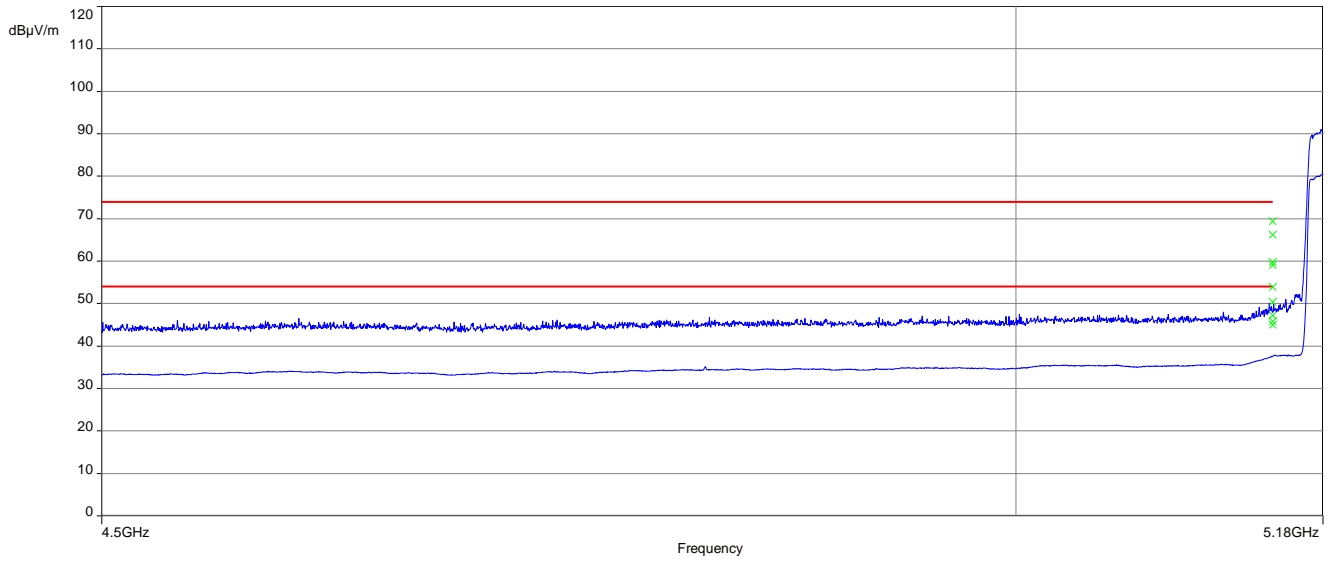

**Plot 14:** upper band edge; U-NII-2A; highest channel; n40-mode

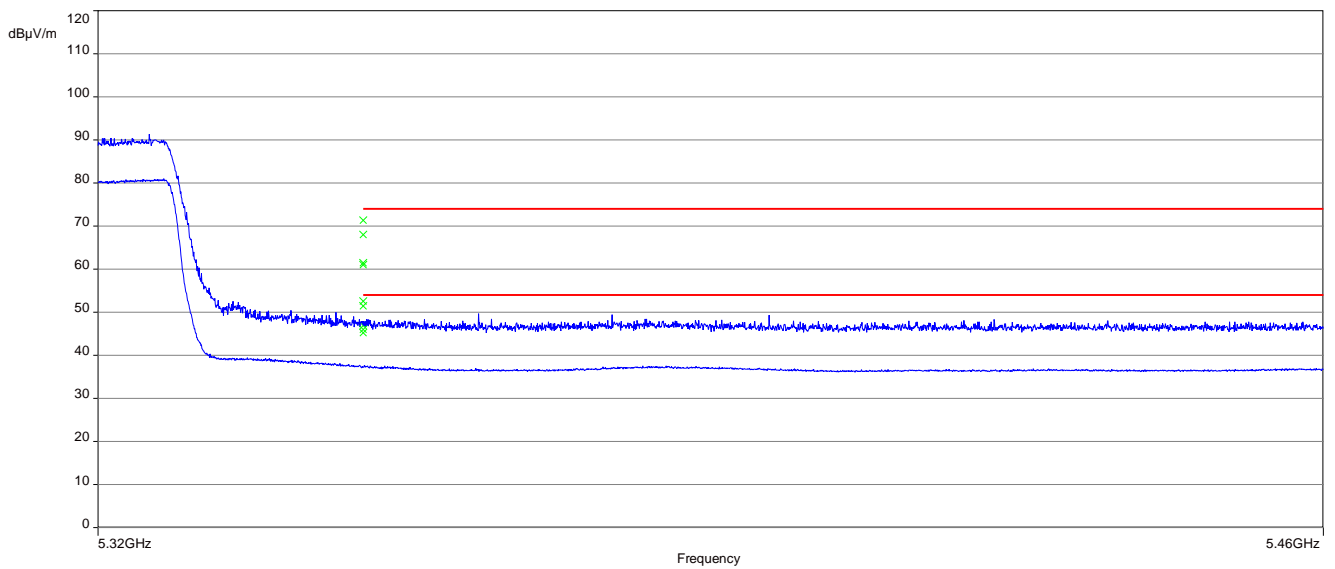

**Plot 15:** lower band edge; U-NII-2C; lowest channel; n40-mode

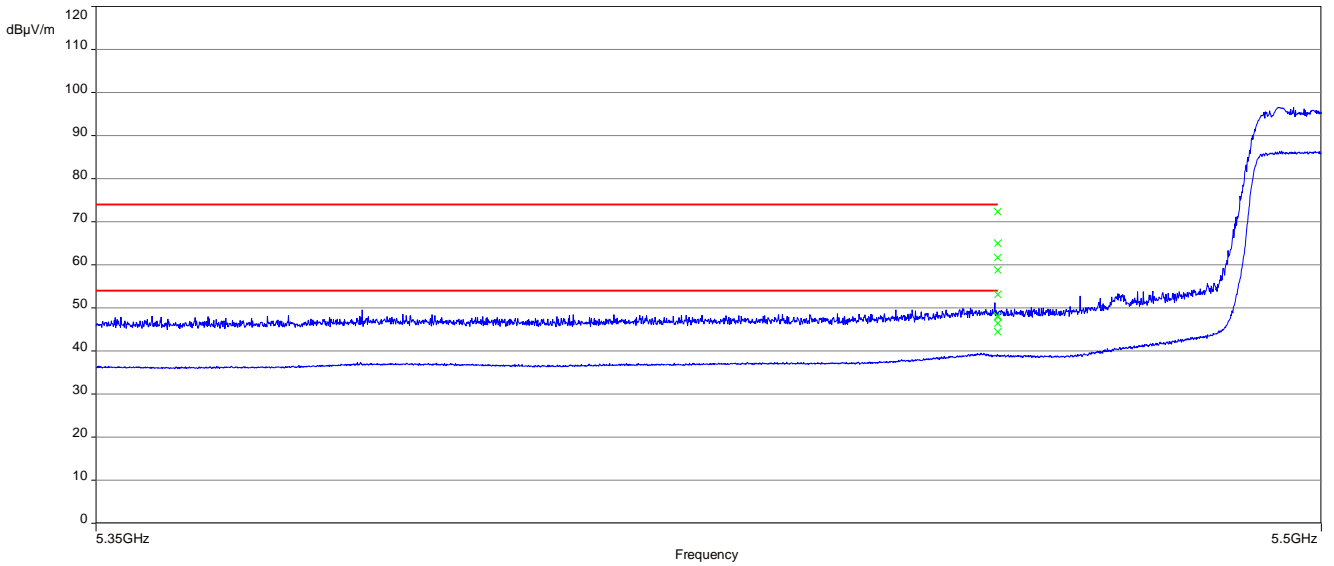

**Plot 16:** lower band edge; U-NII-1; lowest channel; ac40-mode

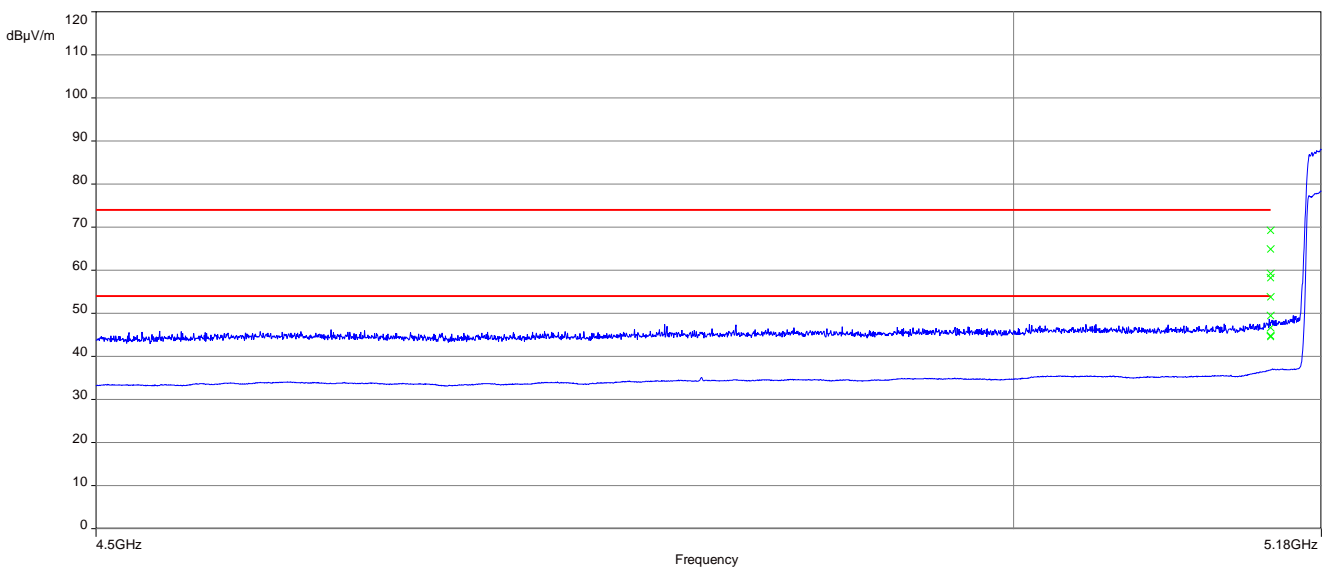

**Plot 17:** upper band edge; U-NII-2A; highest channel; ac40-mode

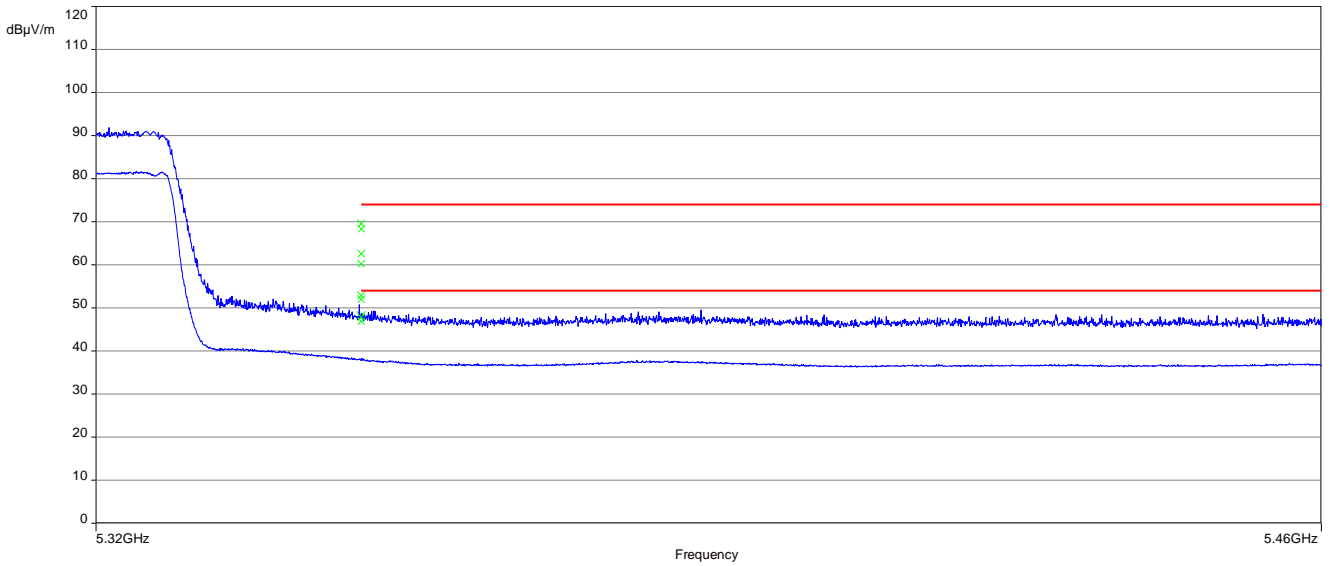

**Plot 18:** lower band edge; U-NII-2C; lowest channel; ac40-mode

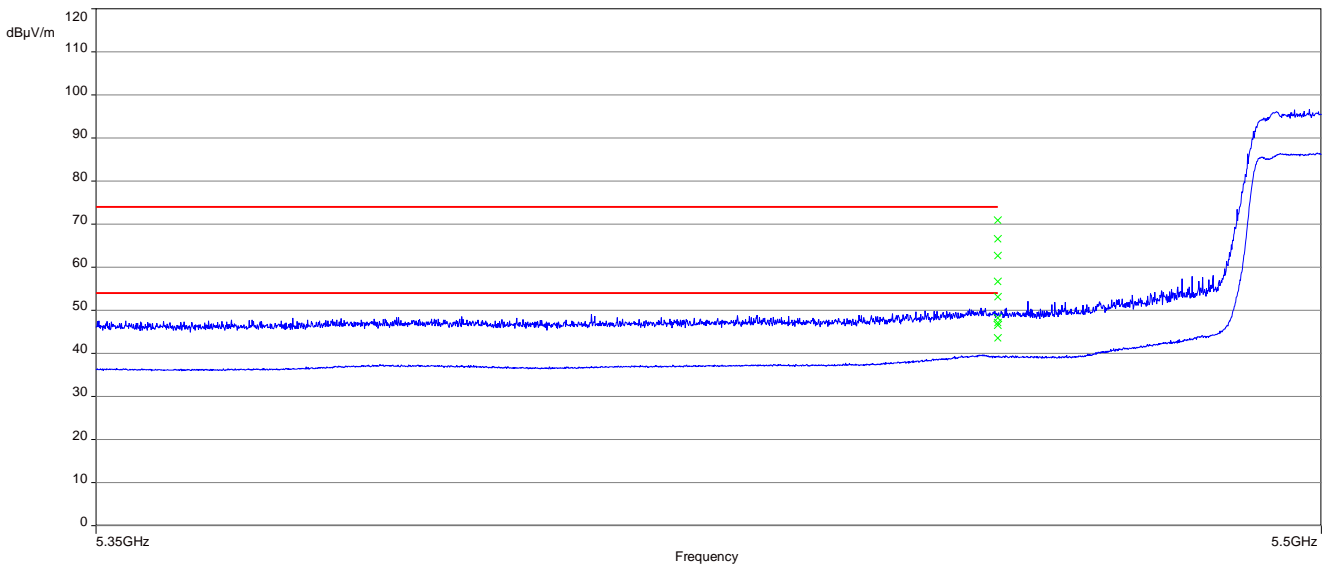

**Plot 19:** lower band edge; U-NII-1; lowest channel; ax40-mode

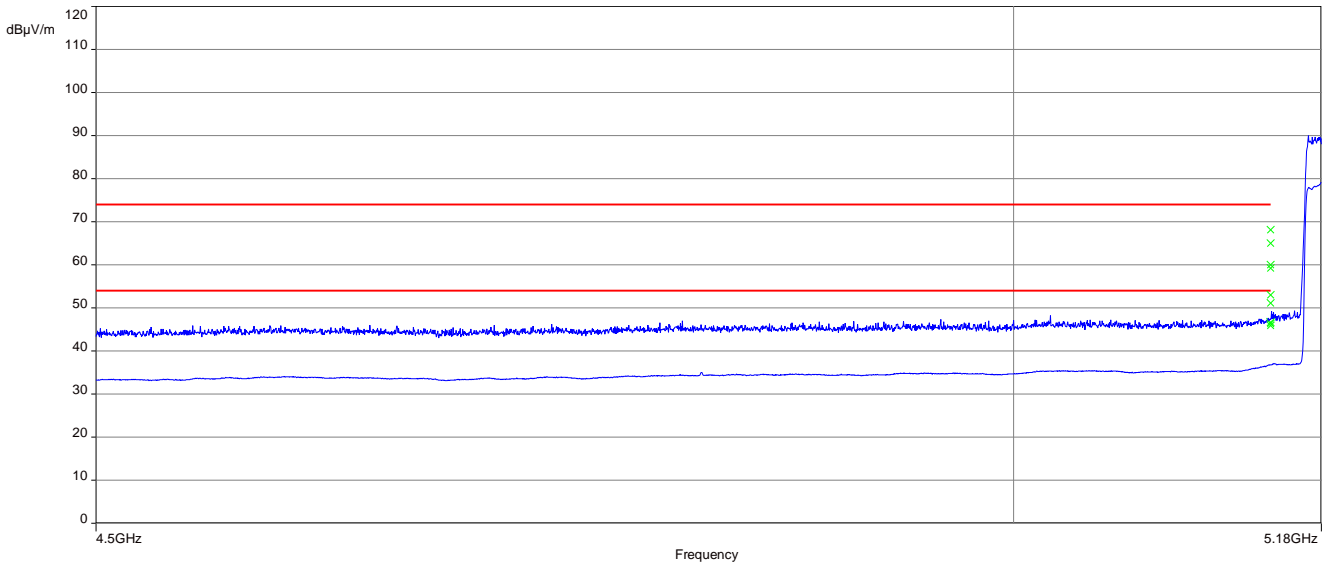

**Plot 20:** upper band edge; U-NII-2A; highest channel; ax40-mode

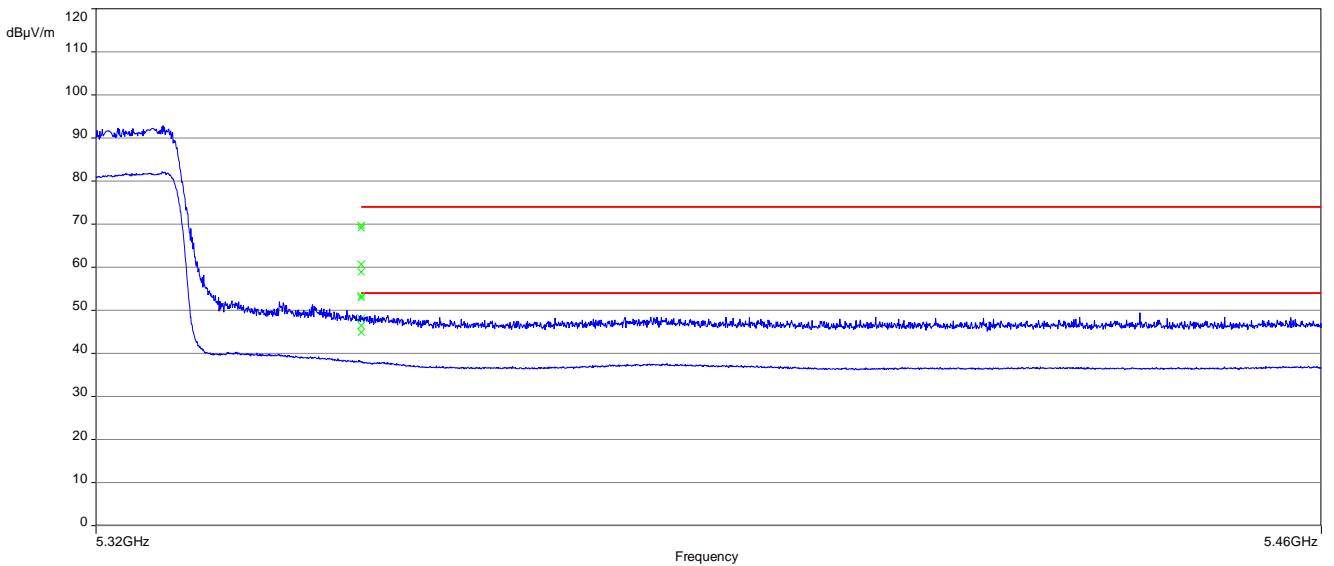



**Plot 21:** lower band edge; U-NII-2C; lowest channel; ax40-mode

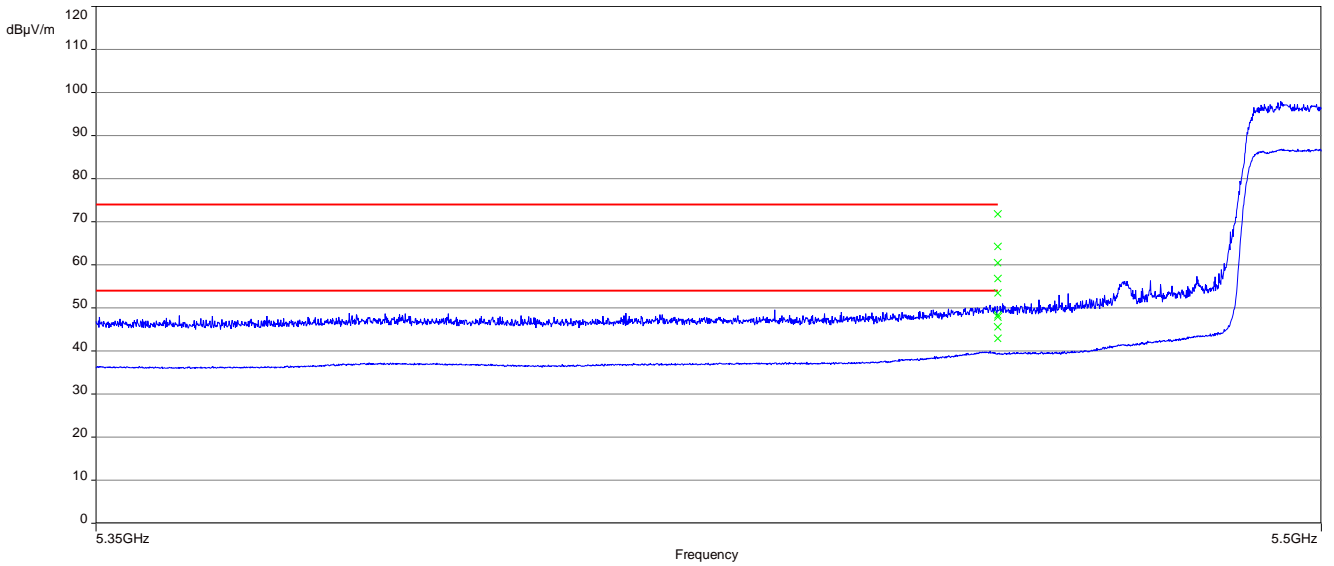

**Plot 22:** lower band edge; U-NII-1; lowest channel; ac80-mode

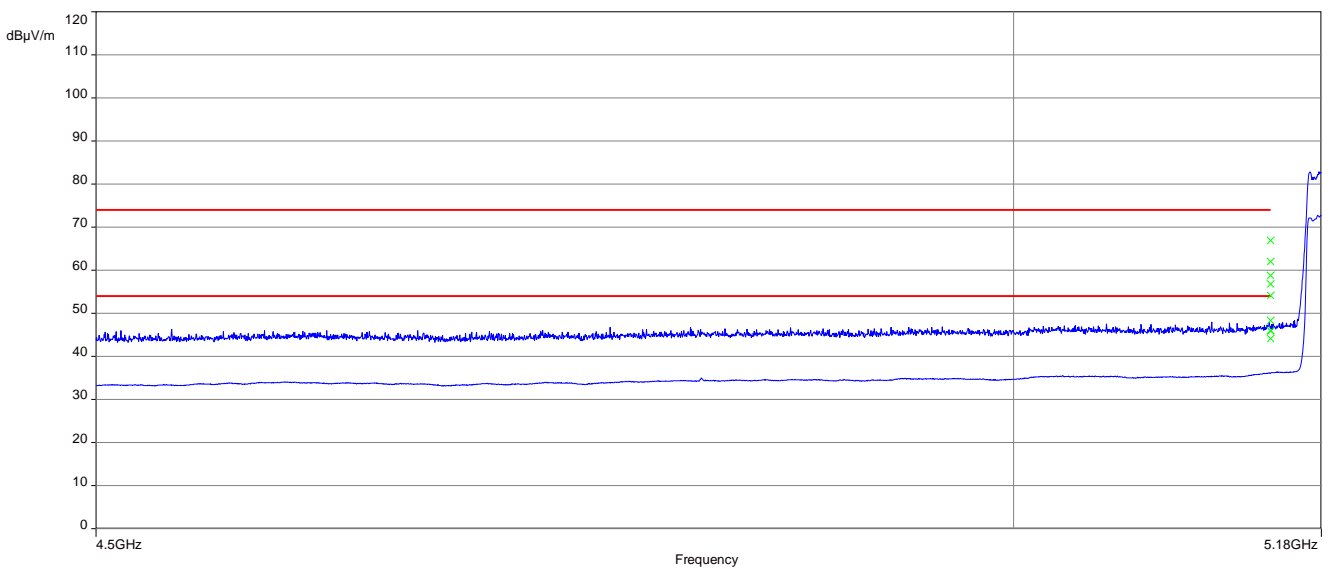

**Plot 23:** upper band edge; U-NII-2A; highest channel; ac80-mode

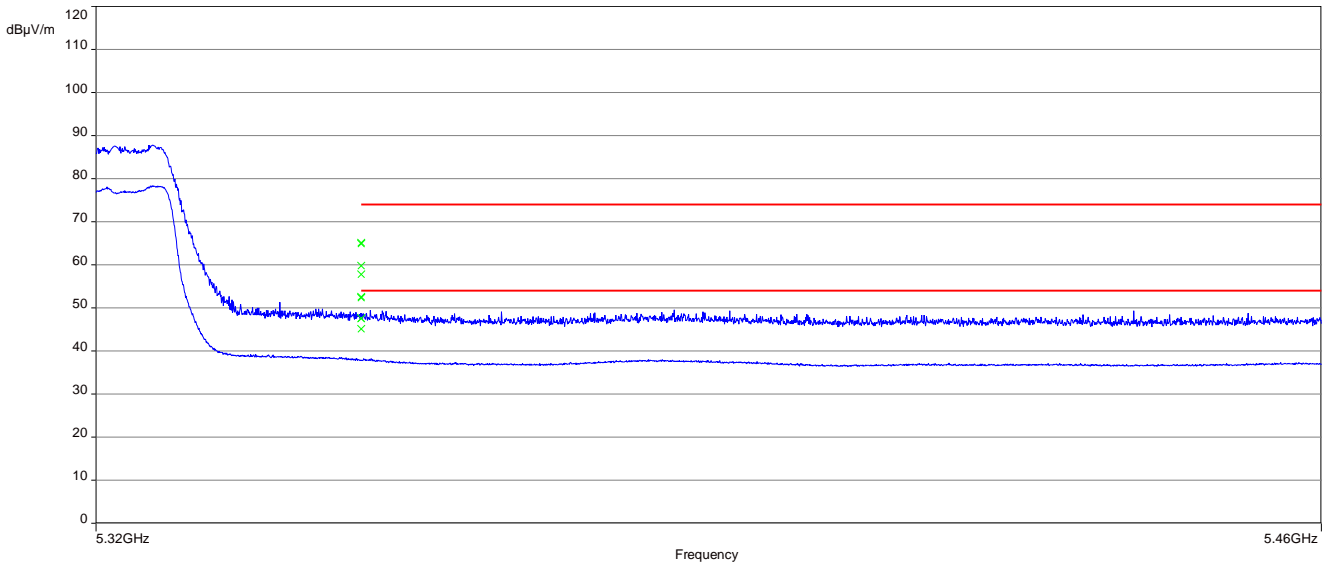

**Plot 24:** lower band edge; U-NII-2C; lowest channel; ac80-mode

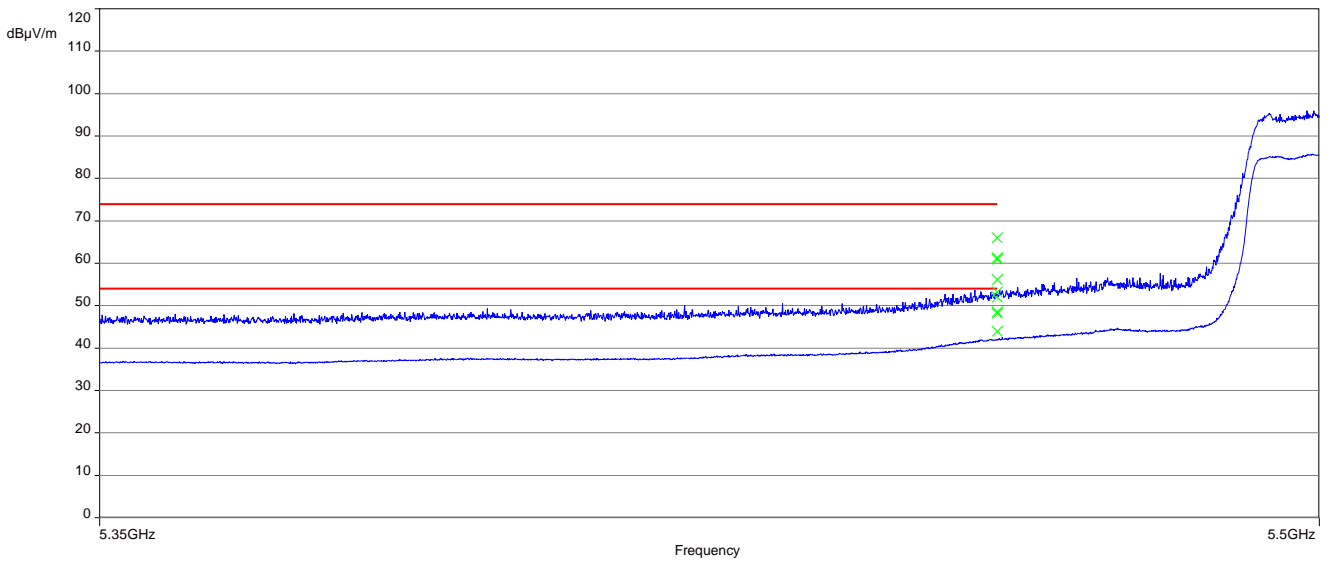

**Plot 25:** lower band edge; U-NII-1; lowest channel; ax80-mode

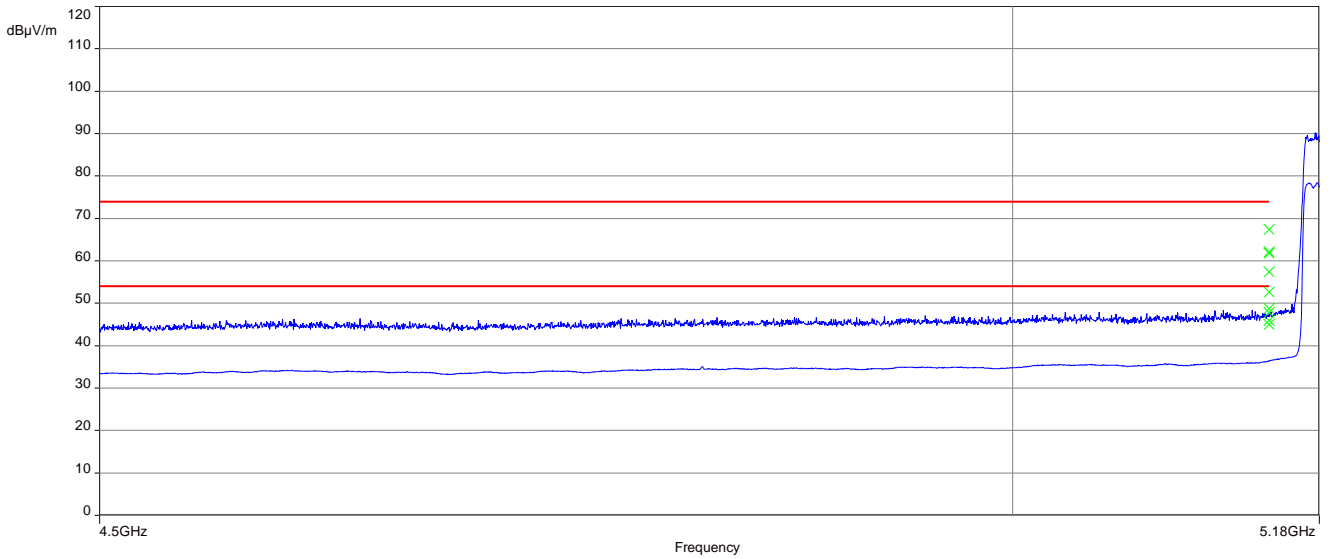

**Plot 26:** upper band edge; U-NII-2A; highest channel; ax80-mode

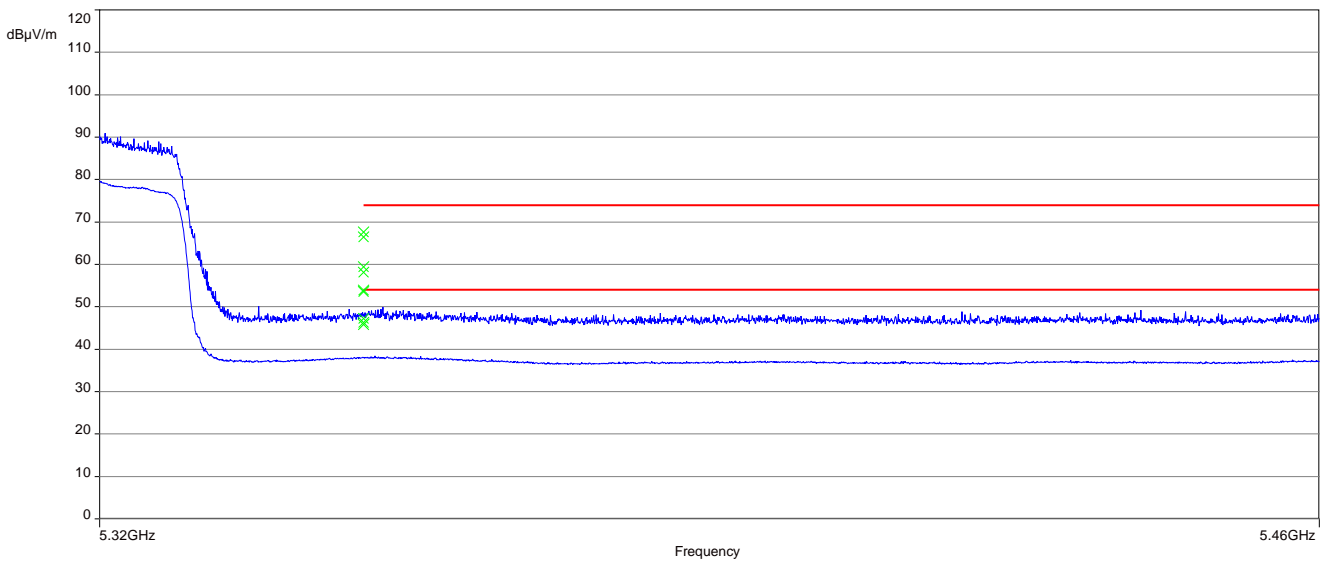

**Plot 27:** lower band edge; U-NII-2C; lowest channel; ax80-mode

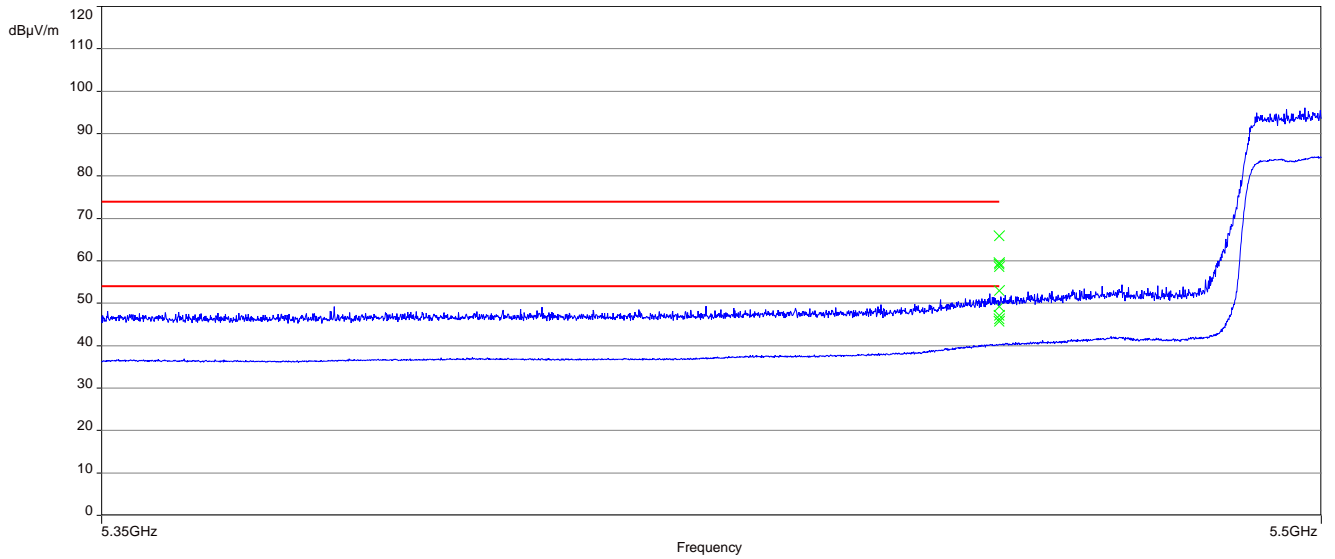

## 12.11 Spurious emissions radiated below 30 MHz

Description:

Measurement of the radiated spurious emissions in transmit mode below 30 MHz. The limits are re-calculated to a measurement distance of 3 m with 40 dB/decade according CFR Part 2.

Measurement:

| Measurement parameter    |  |
|--------------------------|--|
| Detector:                | Peak / Quasi Peak                          |
| Sweep time:              | Auto                                       |
| Video bandwidth:         | F < 150 kHz: 200 Hz<br>F > 150 kHz: 9 kHz  |
| Resolution bandwidth:    | F < 150 kHz: 1 kHz<br>F > 150 kHz: 100 kHz |
| Span:                    | 9 kHz to 30 MHz                            |
| Trace mode:              | Max Hold                                   |
| Test setup:              | See sub clause 6.2 – C                     |
| Measurement uncertainty: | See chapter 9                              |

Limits:

| Spurious Emissions Radiated < 30 MHz |                               |                      |
|--------------------------------------|-------------------------------|----------------------|
| Frequency (MHz)                      | Field Strength (dB $\mu$ V/m) | Measurement distance |
| 0.009 – 0.490                        | 2400/F(kHz)                   | 300                  |
| 0.490 – 1.705                        | 24000/F(kHz)                  | 30                   |
| 1.705 – 30.0                         | 30                            | 30                   |

Results:

| Spurious Emissions Radiated < 30 MHz [dB $\mu$ V/m]         |          |                      |
|---|----------|----------------------|
| F [MHz]   | Detector | Level [dB $\mu$ V/m] |
| All detected emissions are more than 20 dB below the limit. |          |                      |
|   |          |                      |
|   |          |                      |

**Plots:** 20 MHz channel bandwidth

**Plot 1:** 9 kHz to 30 MHz, U-NII-1; lowest channel

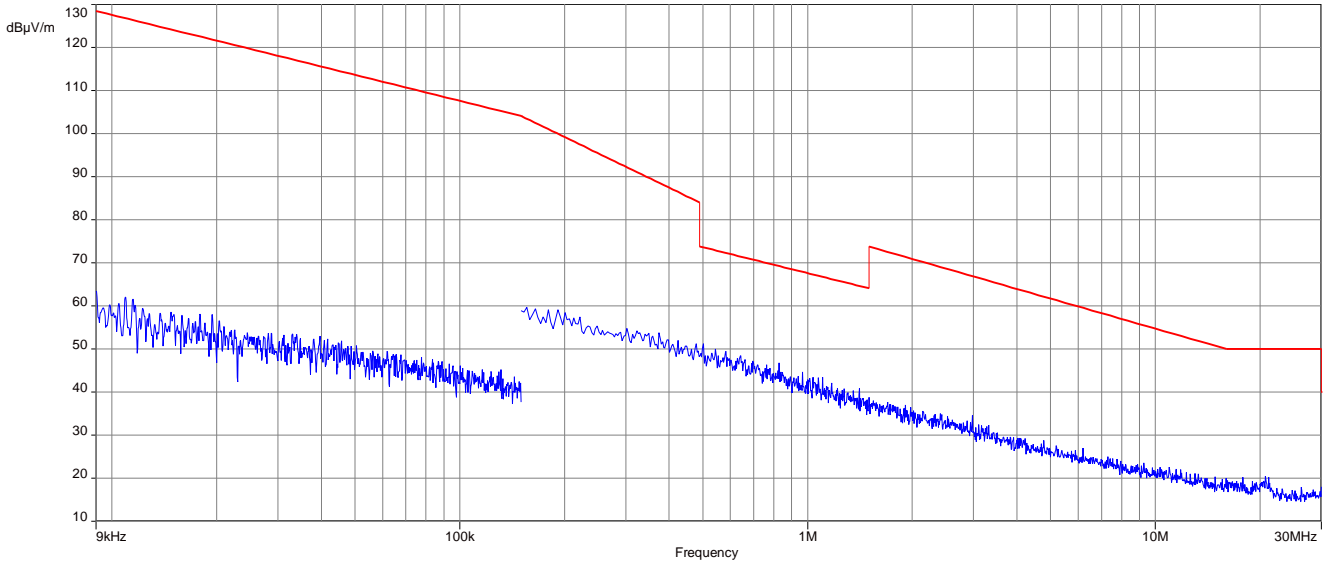

**Plot 2:** 9 kHz to 30 MHz, U-NII-1; middle channel

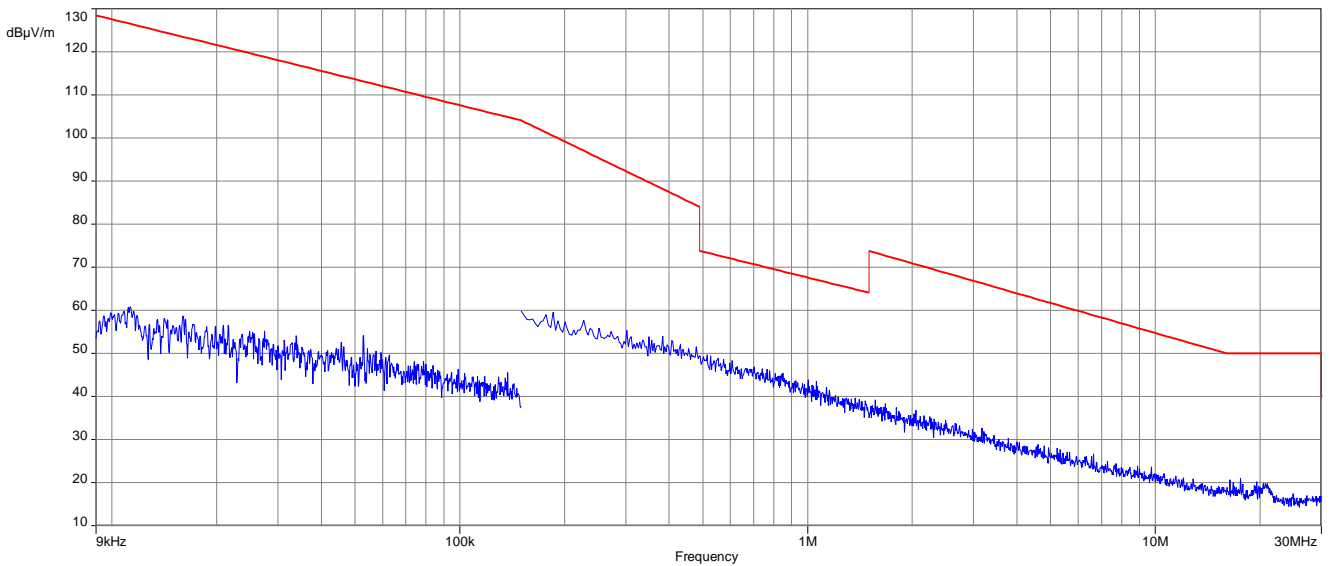

**Plot 3:** 9 kHz to 30 MHz, U-NII-1; highest channel

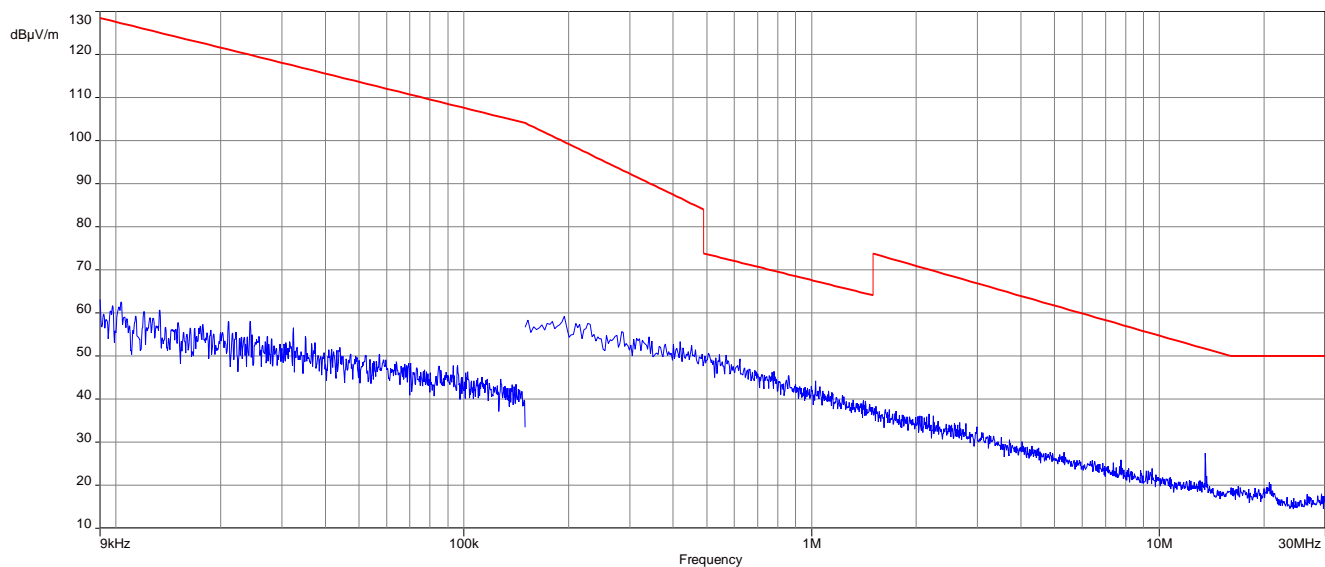

**Plot 4:** 9 kHz to 30 MHz, U-NII-2A; lowest channel

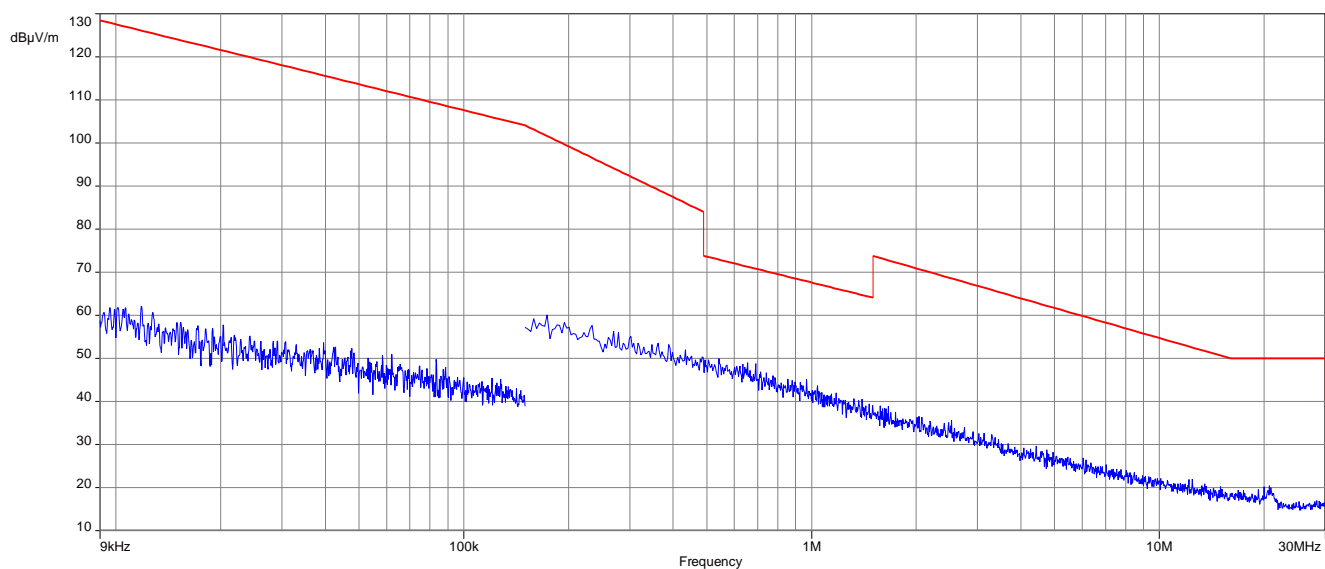

**Plot 5:** 9 kHz to 30 MHz, U-NII-2A; middle channel

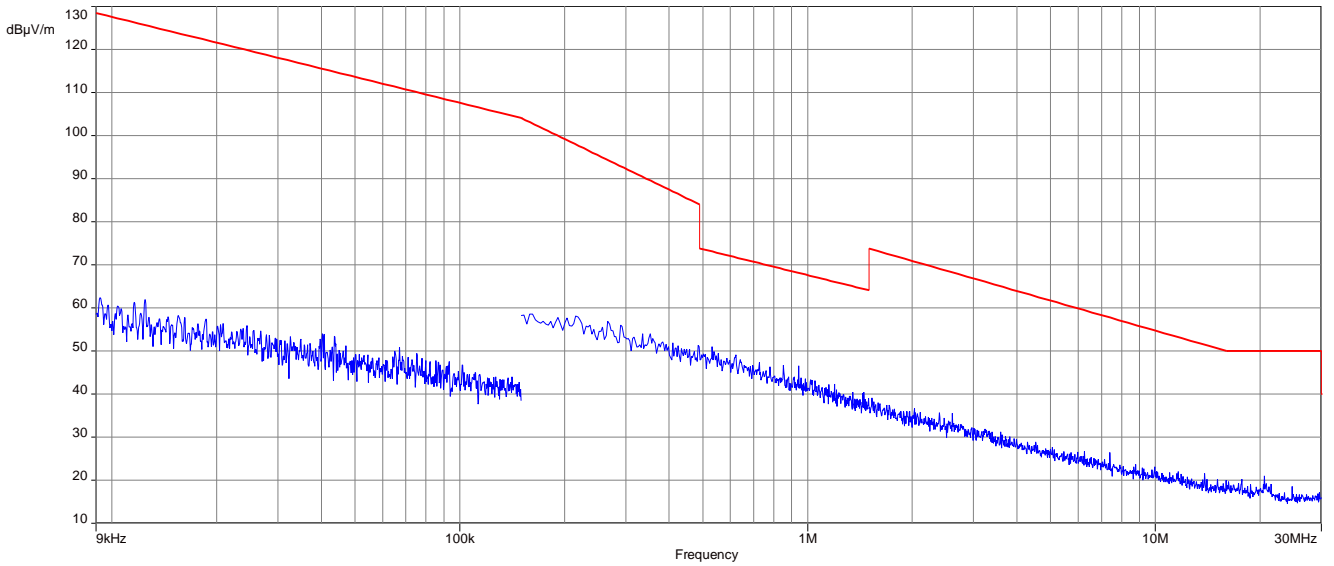

**Plot 6:** 9 kHz to 30 MHz, U-NII-2A; highest channel

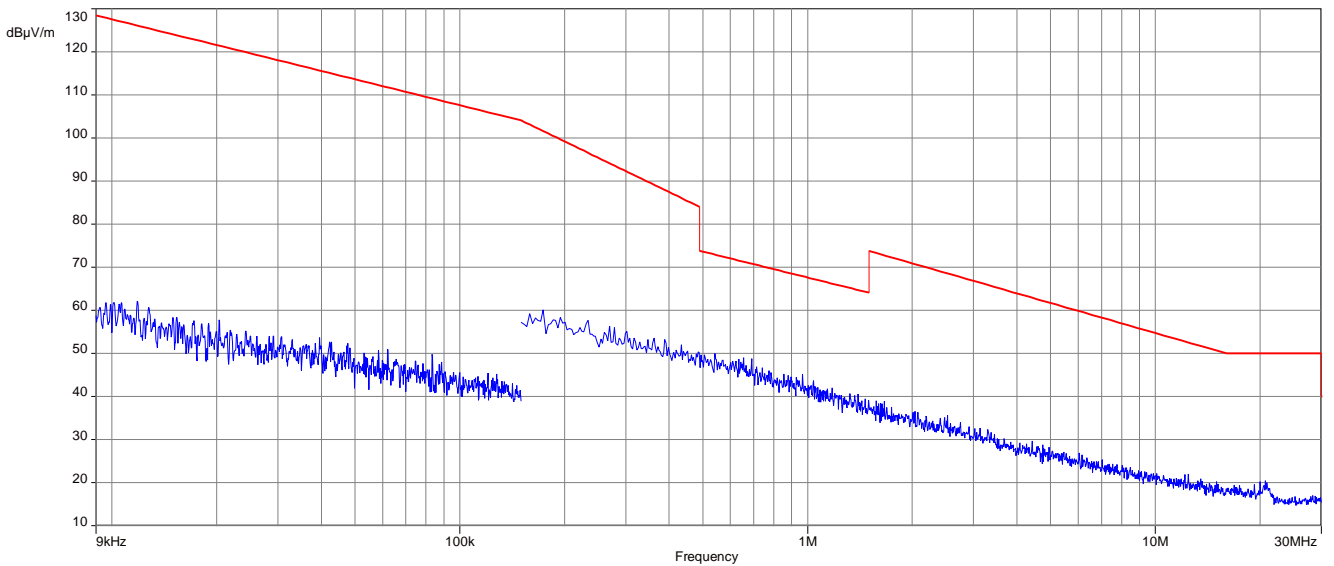



**Plot 7:** 9 kHz to 30 MHz, U-NII-2C; lowest channel

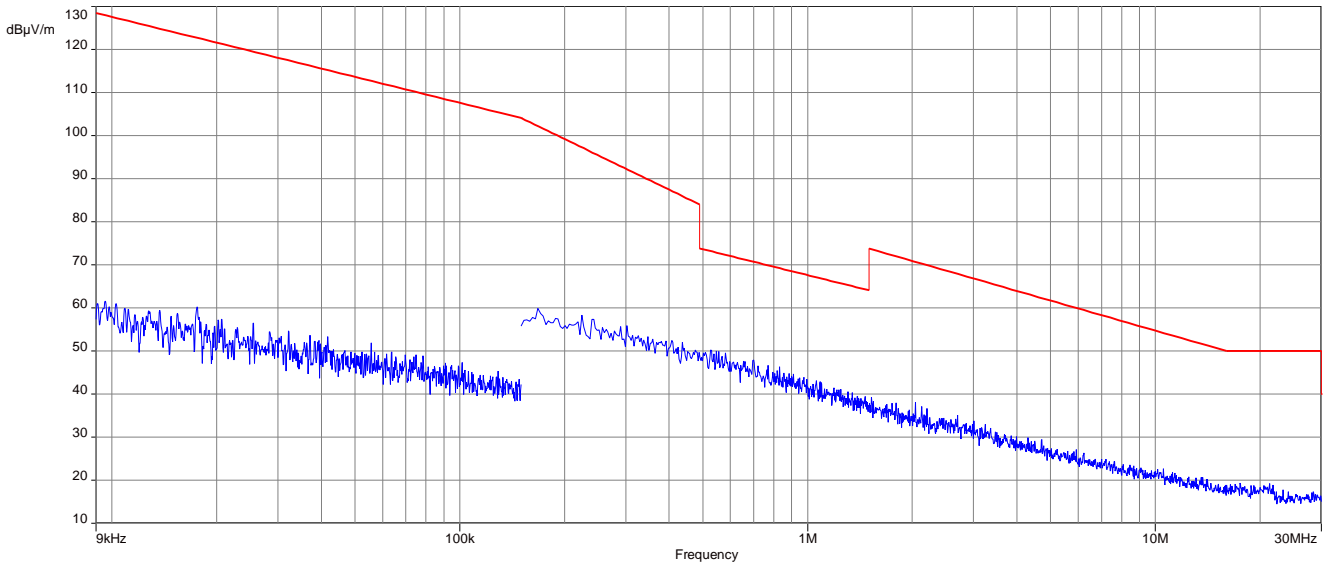

**Plot 8:** 9 kHz to 30 MHz, U-NII-2C; middle channel

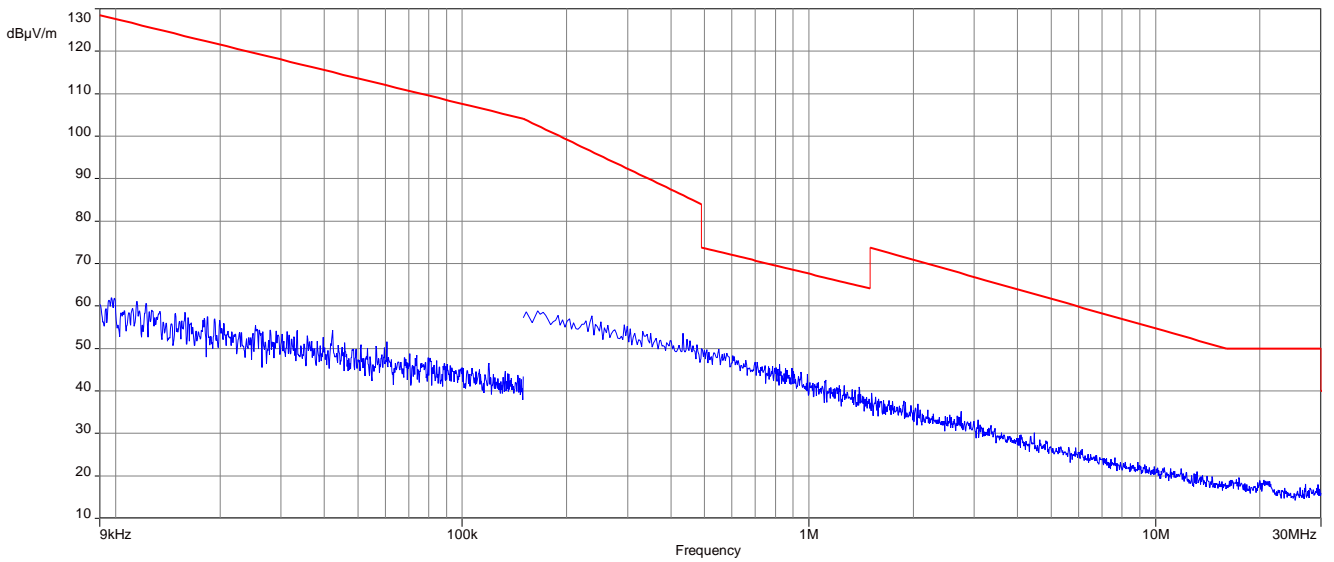

**Plot 9:** 9 kHz to 30 MHz, U-NII-2C; highest channel

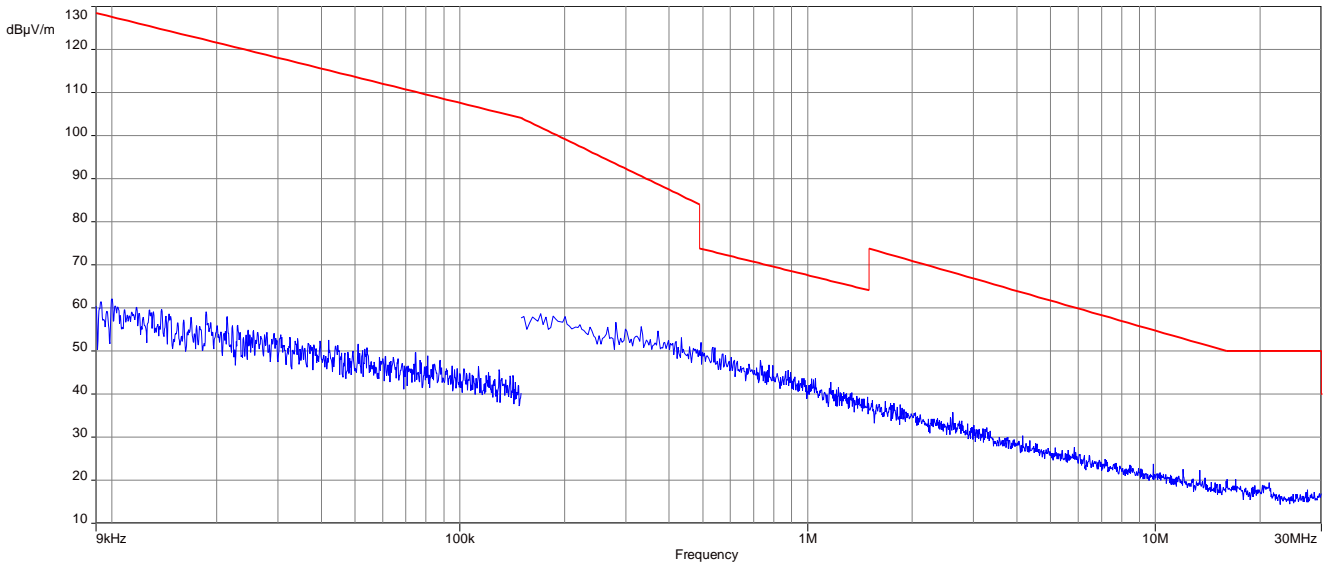

**Plot 10:** 9 kHz to 30 MHz, U-NII-3; lowest channel

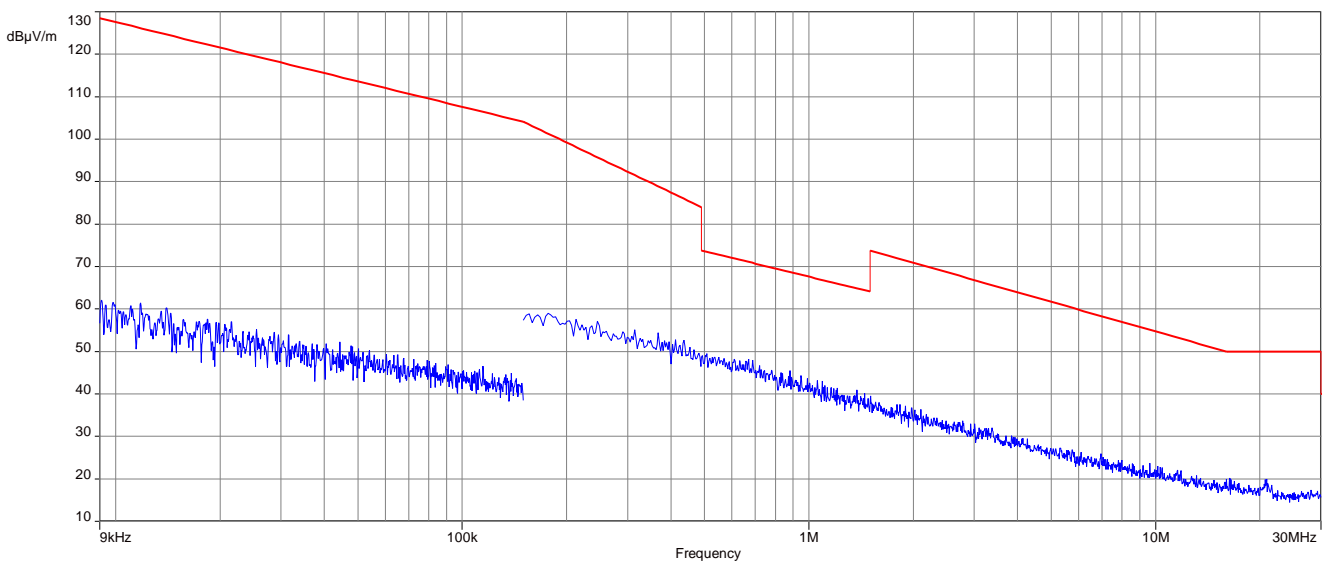

**Plot 11:** 9 kHz to 30 MHz, U-NII-3; middle channel

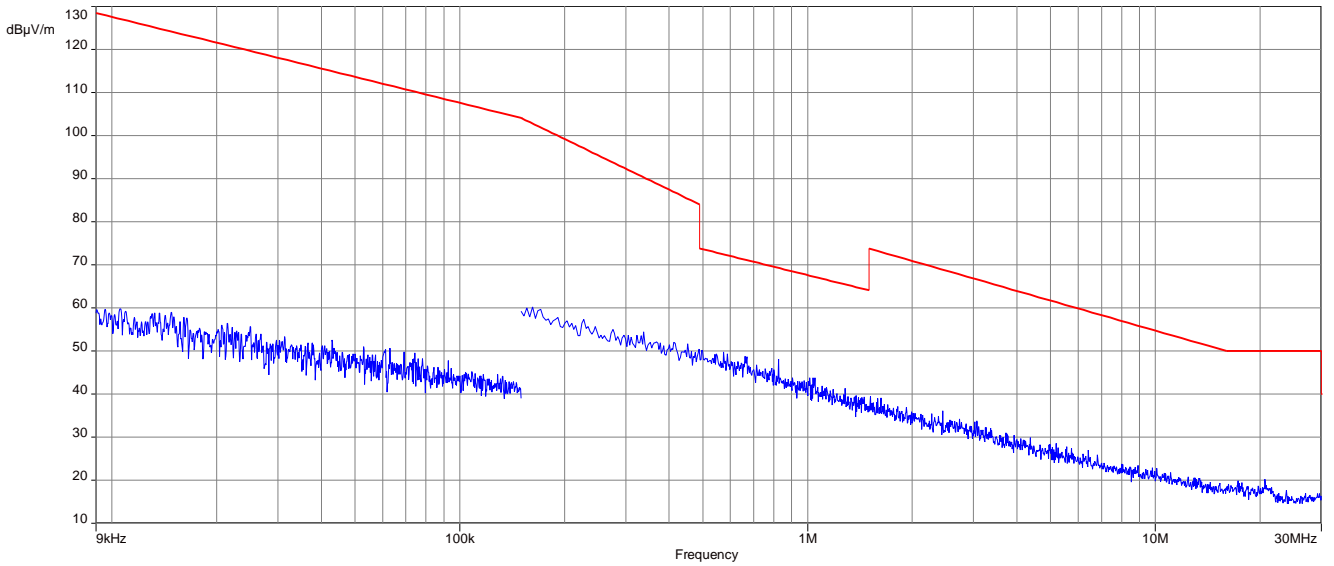

**Plot 12:** 9 kHz to 30 MHz, U-NII-3; highest channel

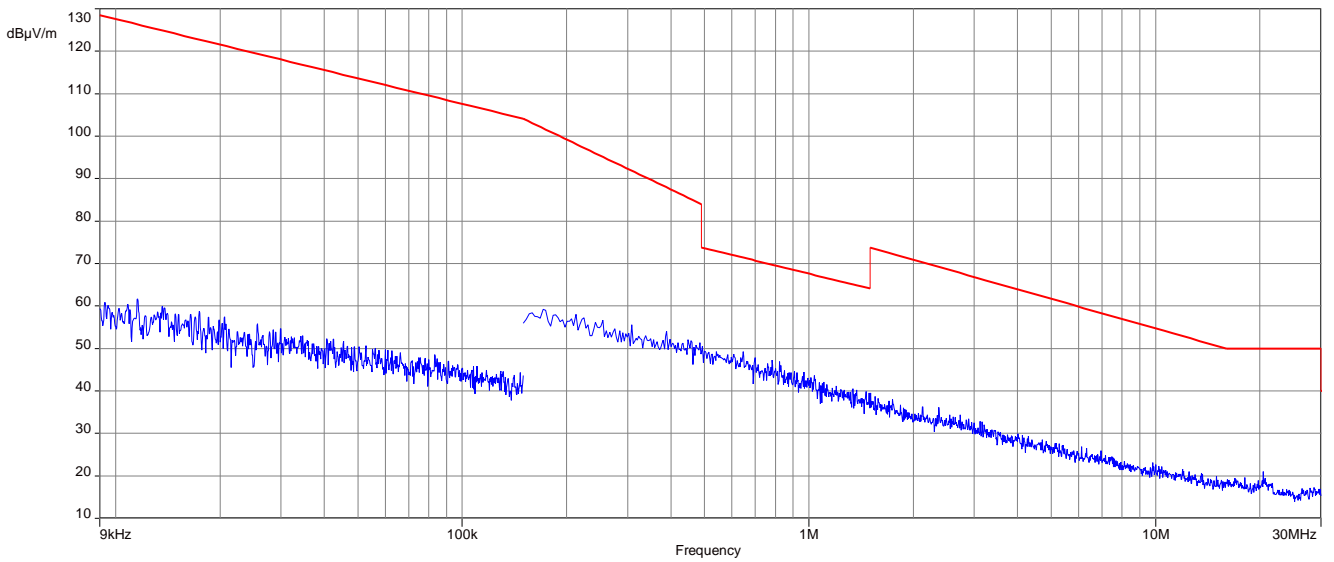

**Plots:** 40 MHz channel bandwidth

**Plot 1:** 9 kHz to 30 MHz, U-NII-1; lowest channel

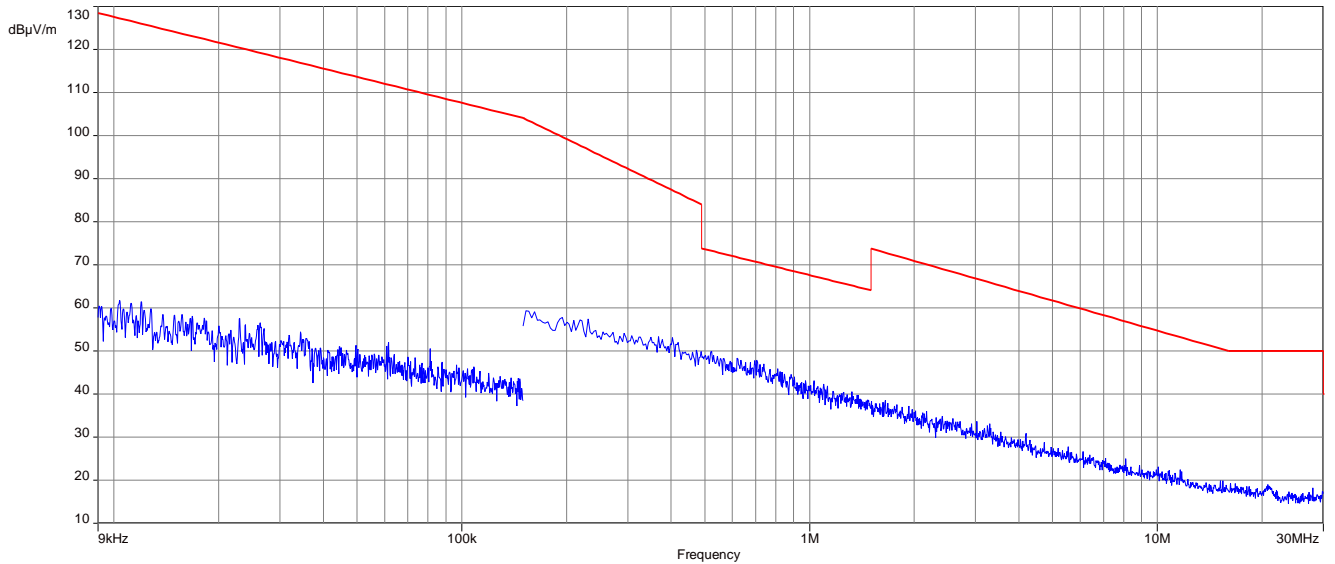

**Plot 2:** 9 kHz to 30 MHz, U-NII-1; highest channel

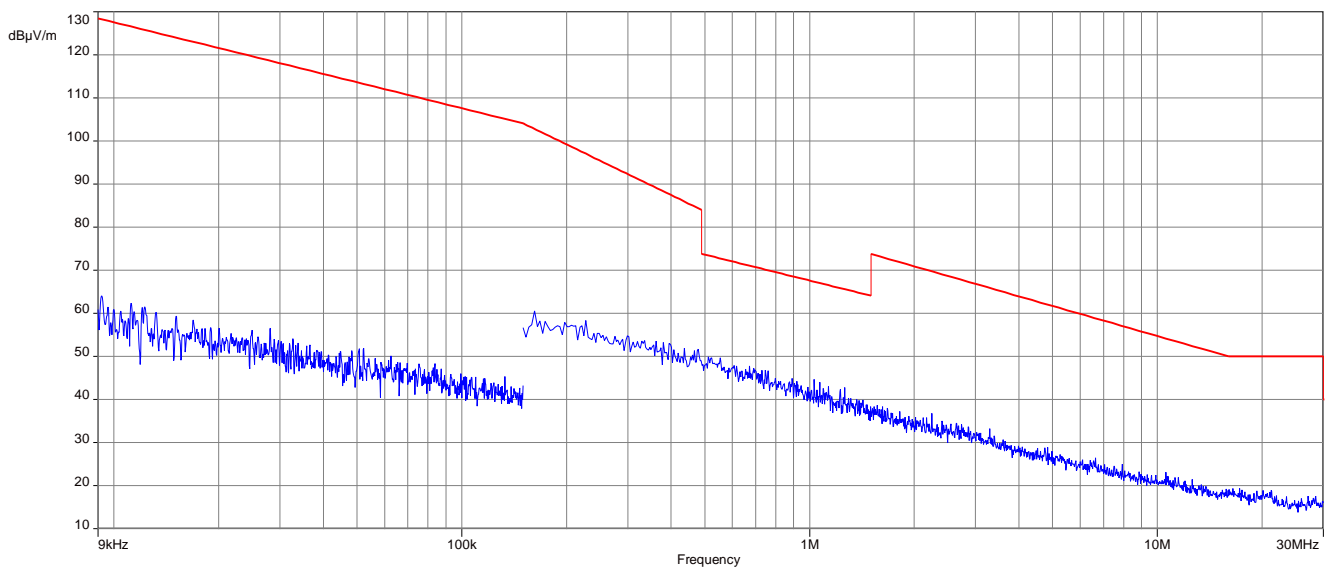

**Plot 3:** 9 kHz to 30 MHz, U-NII-2A; lowest channel

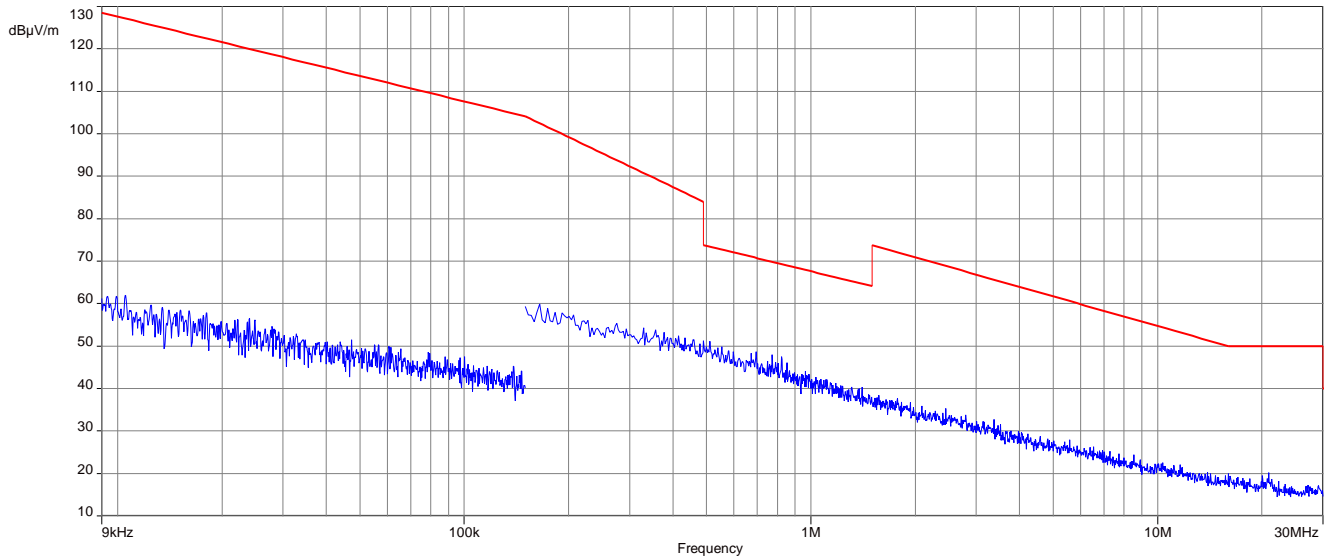

**Plot 4:** 9 kHz to 30 MHz, U-NII-2A; highest channel

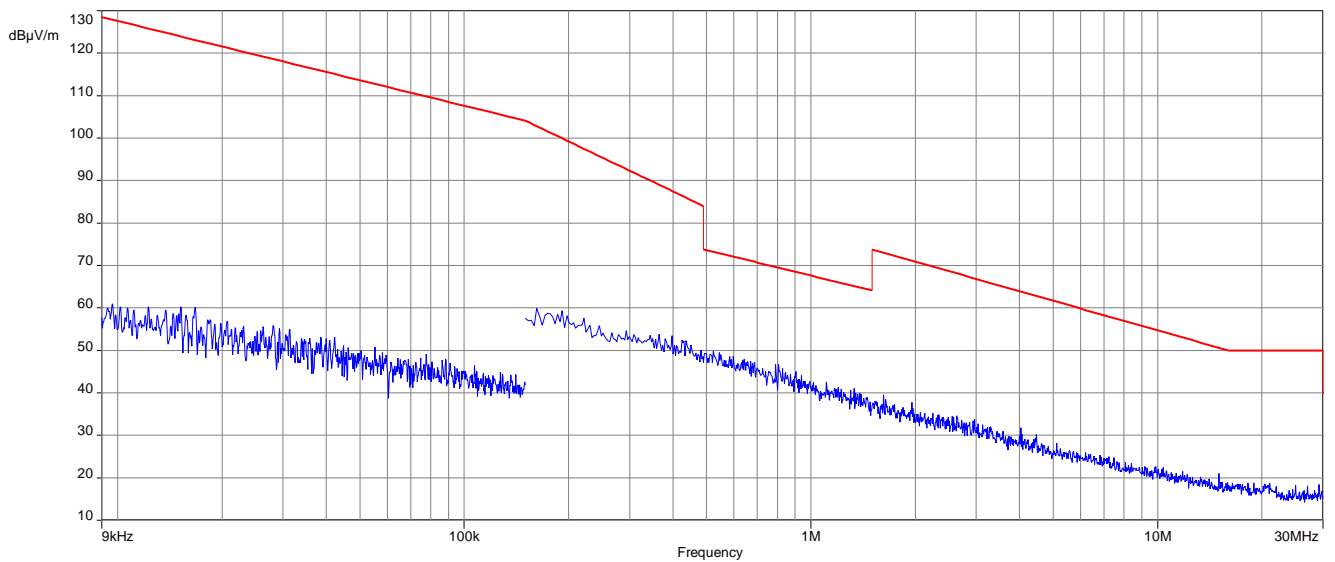

**Plot 5:** 9 kHz to 30 MHz, U-NII-2C; lowest channel

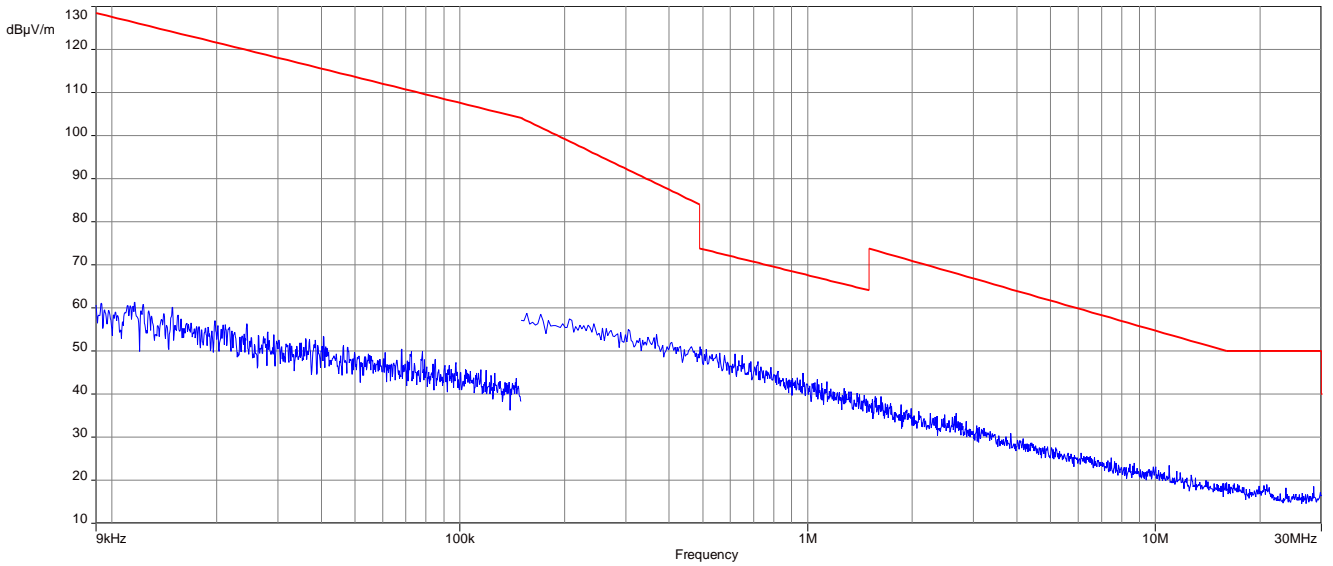

**Plot 6:** 9 kHz to 30 MHz, U-NII-2C; middle channel

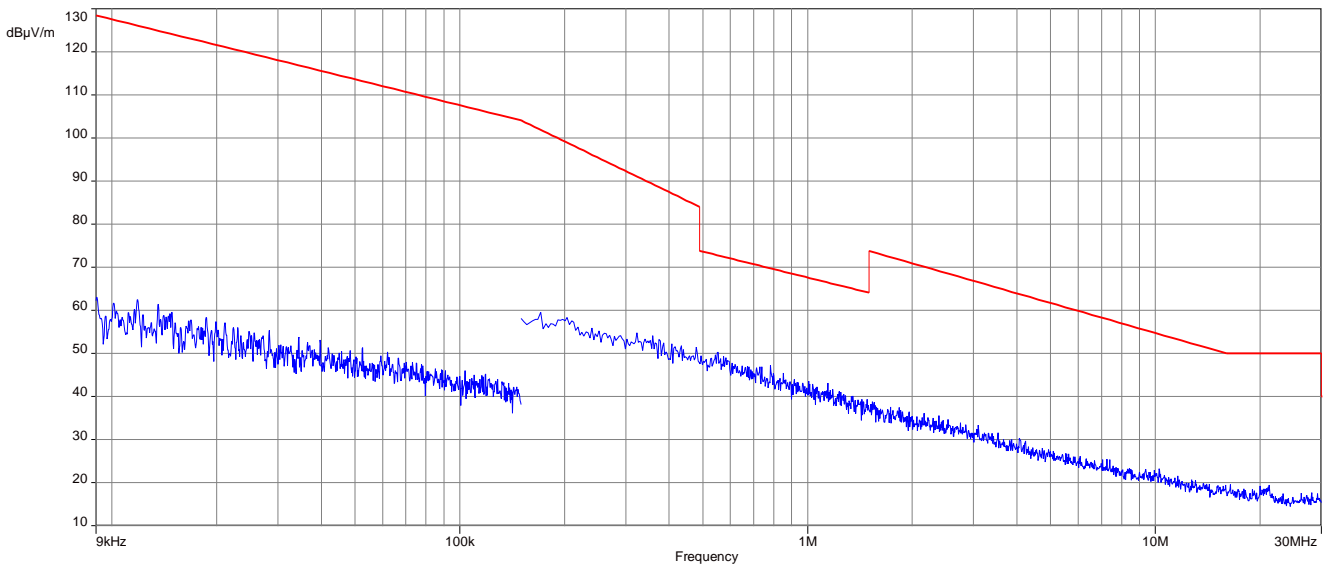

**Plot 7:** 9 kHz to 30 MHz, U-NII-2C; highest channel

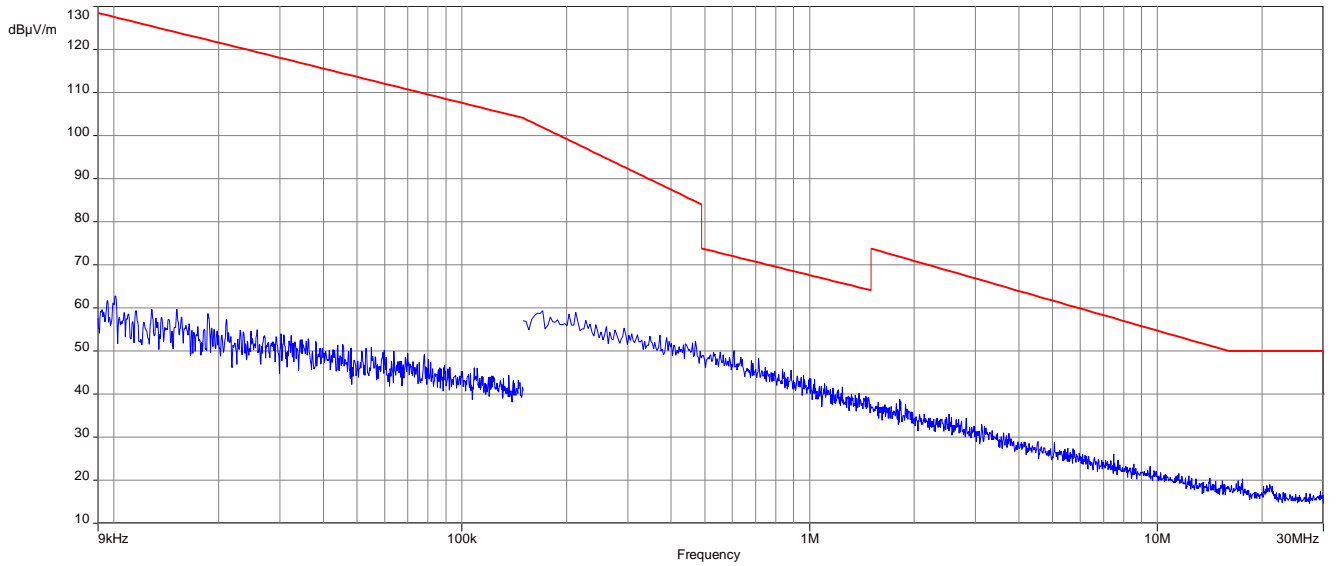

**Plot 8:** 9 kHz to 30 MHz, U-NII-3; lowest channel

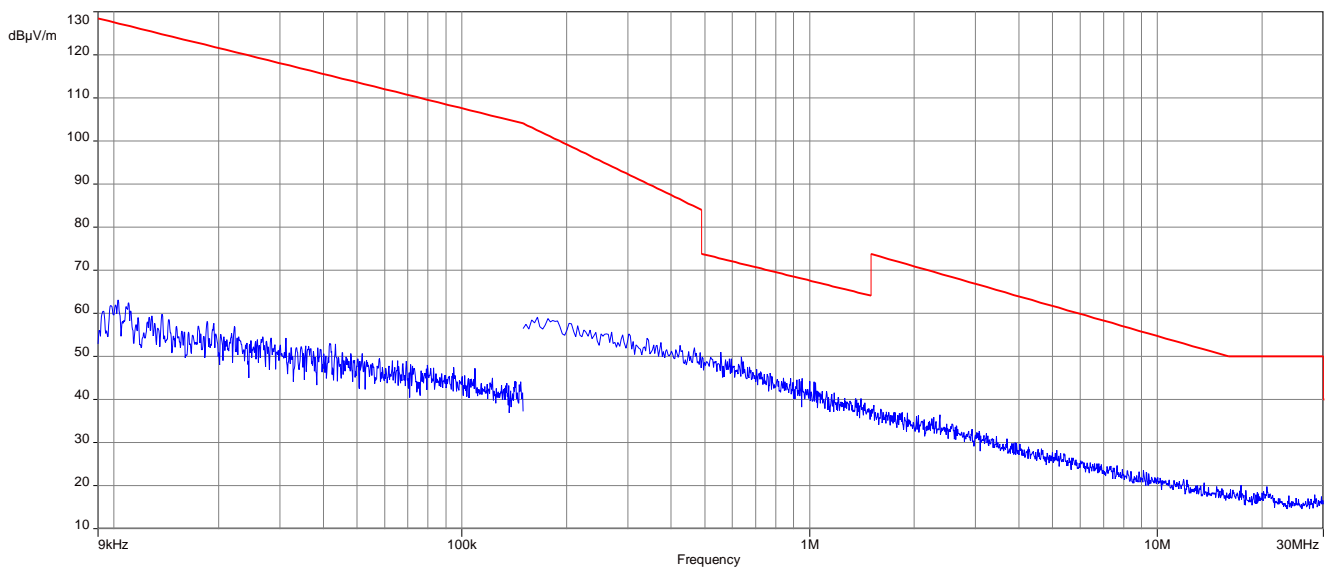

**Plot 9:** 9 kHz to 30 MHz, U-NII-3; highest channel

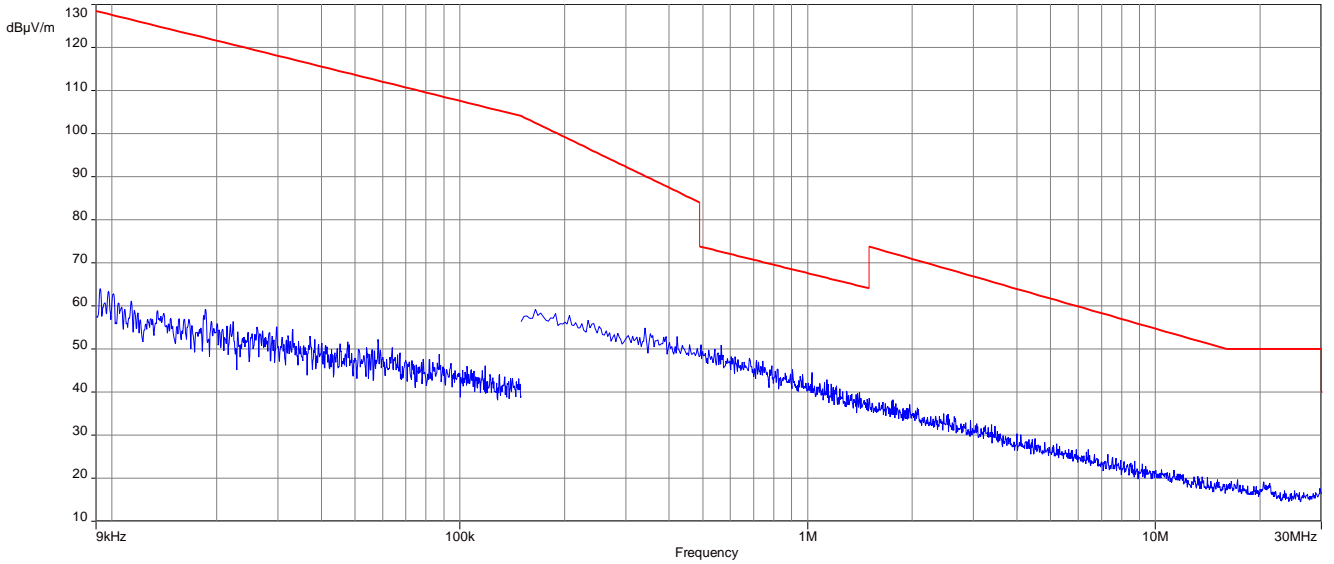



**Plots:** 80 MHz channel bandwidth

**Plot 1:** 9 kHz to 30 MHz, U-NII-1; middle channel

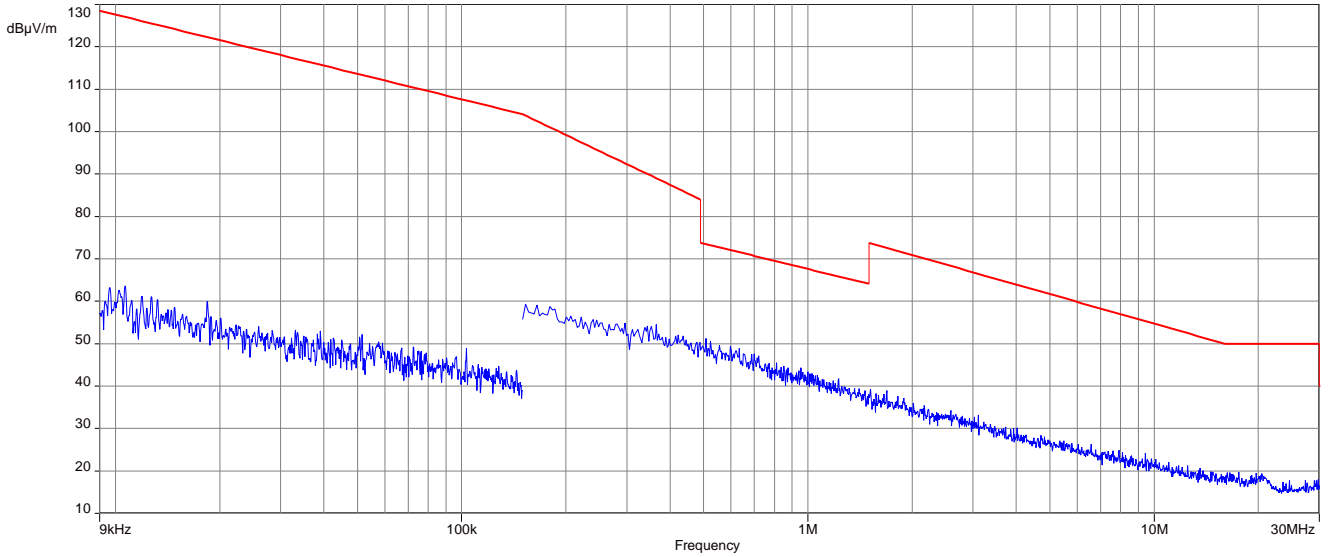

**Plot 2:** 9 kHz to 30 MHz, U-NII-2A; middle channel

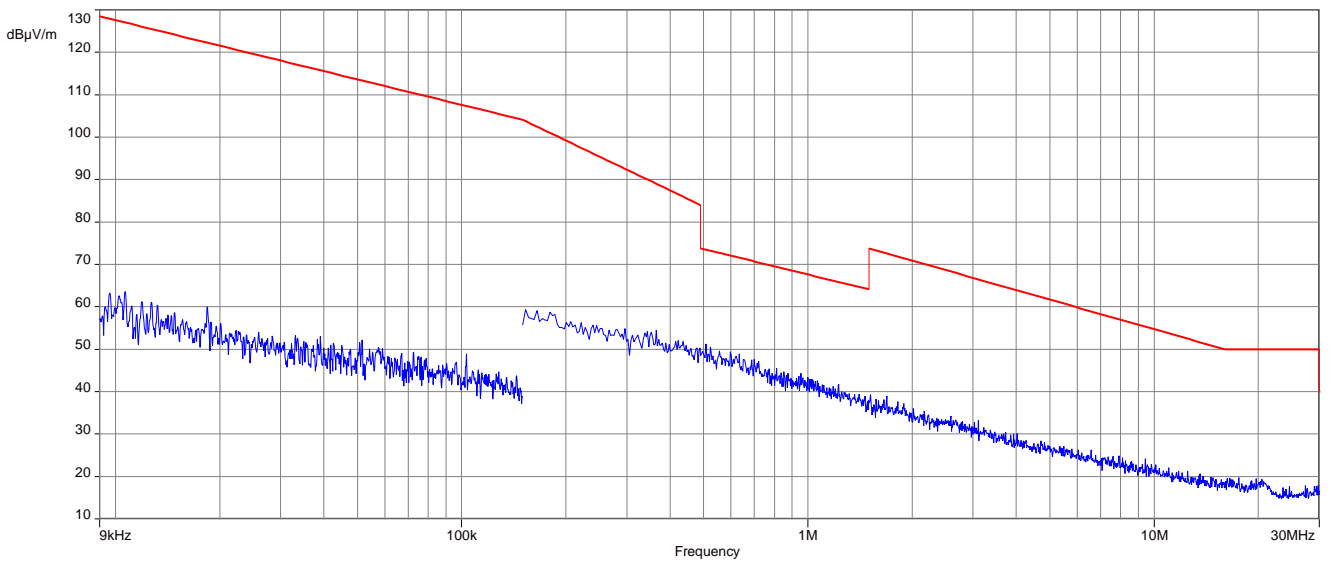

**Plot 3:** 9 kHz to 30 MHz, U-NII-2C; lowest channel

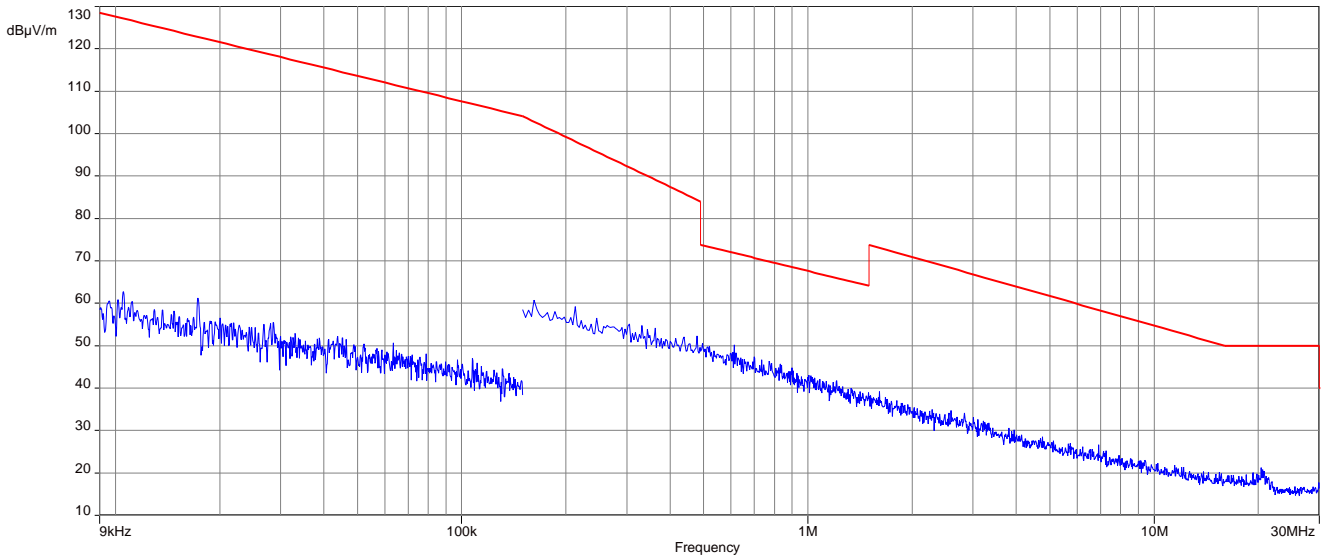

**Plot 4:** 9 kHz to 30 MHz, U-NII-2C; highest channel

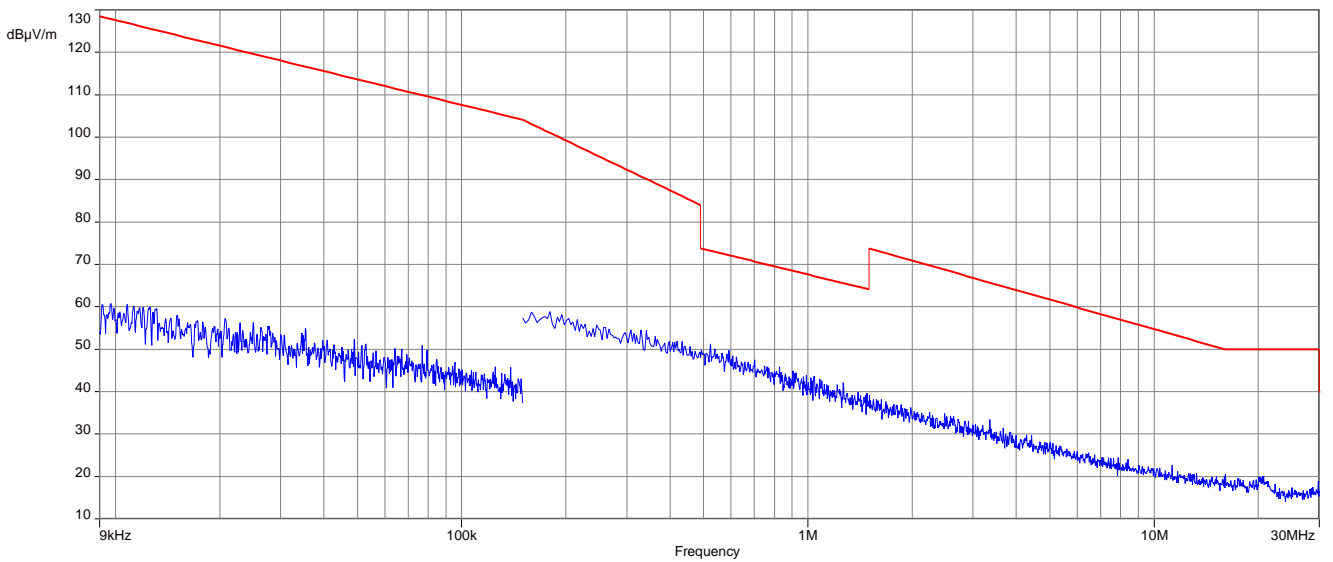

**Plot 5:** 9 kHz to 30 MHz, U-NII-3; middle channel

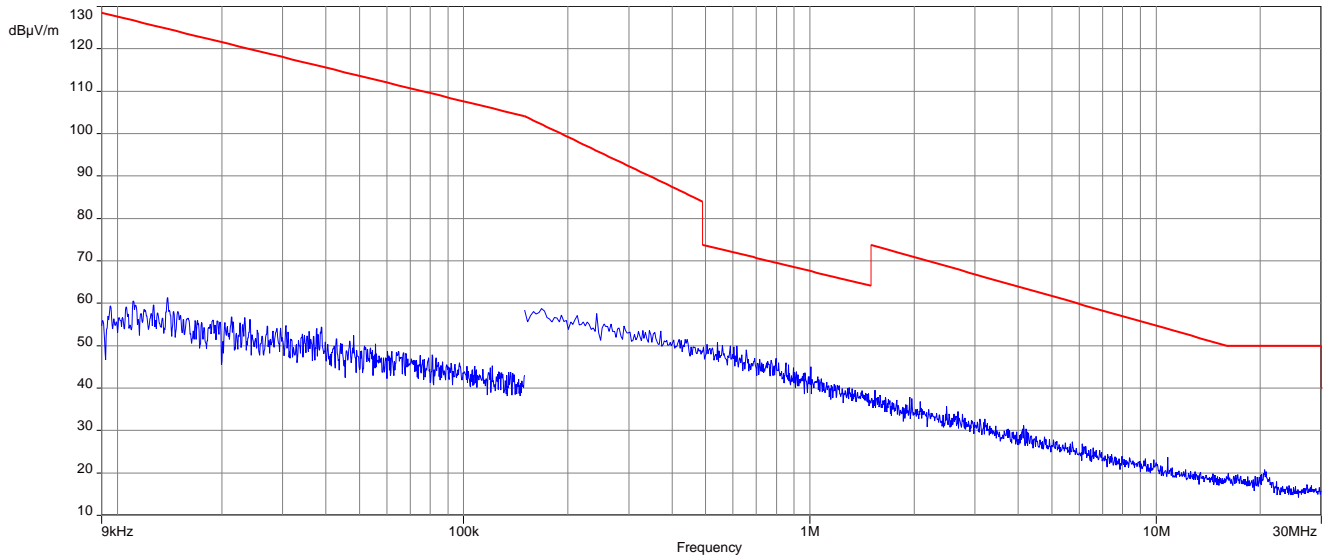

## 12.12 Spurious emissions radiated 30 MHz to 1 GHz

Description:

Measurement of the radiated spurious emissions and cabinet radiations below 1 GHz.

Measurement:

| Measurement parameter    |                        |
|--------------------------|------------------------|
| Detector:                | Quasi Peak             |
| Sweep time:              | Auto                   |
| Resolution bandwidth:    | 120 kHz                |
| Video bandwidth:         | 500 kHz                |
| Span:                    | 30 MHz to 1 GHz        |
| Test setup:              | See sub clause 7.1 – A |
| Measurement uncertainty: | See chapter 9          |

Limits:

| TX Spurious Emissions Radiated |                         |                      |
|--------------------------------|-------------------------|----------------------|
| §15.209 / RSS-247              |                         |                      |
| Frequency (MHz)                | Field Strength (dBµV/m) | Measurement distance |
| 30 - 88                        | 30.0                    | 10                   |
| 88 – 216                       | 33.5                    | 10                   |
| 216 – 960                      | 36.0                    | 10                   |
| Above 960                      | 54.0                    | 3                    |
| §15.407                        |                         |                      |
| Outside the restricted bands!  | -27 dBm / MHz           |                      |

**Plots:** 20 MHz channel bandwidth

**Plot 1:** 30 MHz to 1 GHz; vertical & horizontal polarization; valid for all channels and bands

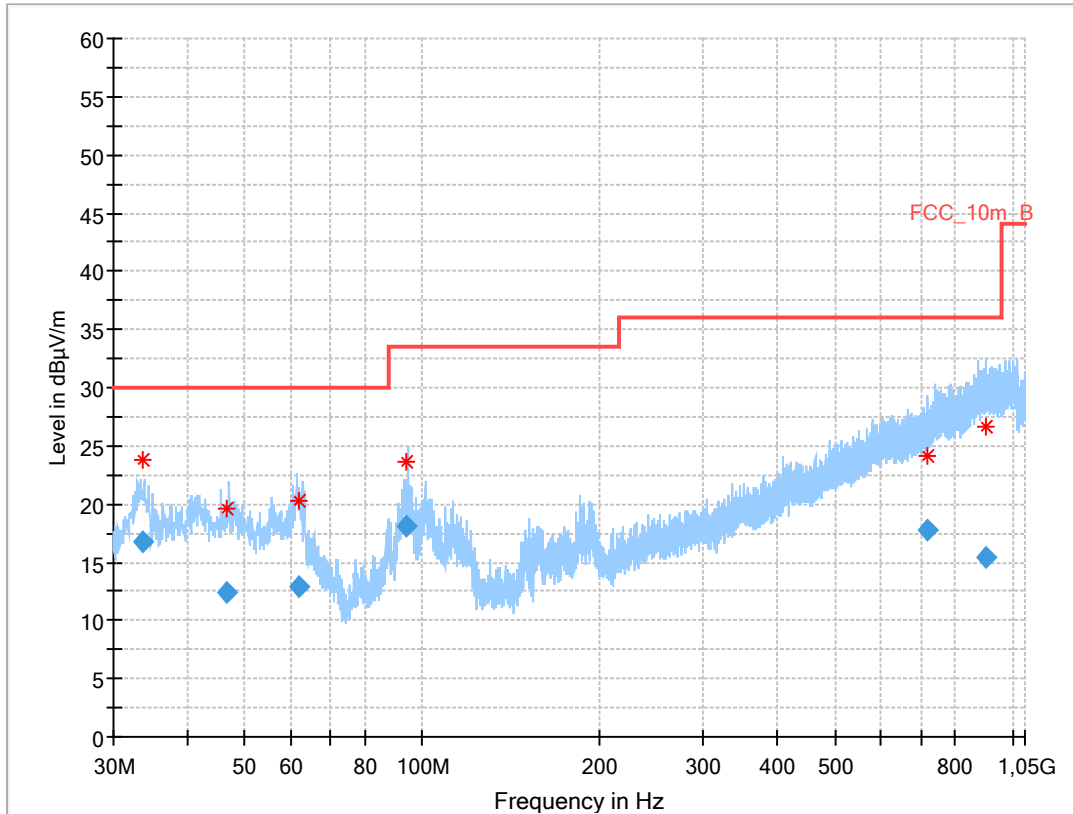

**Results:**

| Frequency (MHz) | QuasiPeak (dBµV/m) | Limit (dBµV/m) | Margin (dB) | Meas. Time (ms) | Bandwidth (kHz) | Height (cm) | Pol | Azimuth (deg) | Corr. (dB) |
|-----------------|--------------------|----------------|-------------|-----------------|-----------------|-------------|-----|---------------|------------|
| 33.689          | 16.75              | 30.0           | 13.3        | 1000            | 120.0           | 149.0       | V   | 243           | 14         |
| 46.782          | 12.48              | 30.0           | 17.5        | 1000            | 120.0           | 203.0       | V   | 8             | 16         |
| 62.010          | 12.86              | 30.0           | 17.1        | 1000            | 120.0           | 294.0       | V   | 180           | 13         |
| 94.209          | 18.12              | 33.5           | 15.4        | 1000            | 120.0           | 111.0       | V   | 302           | 12         |
| 719.380         | 17.72              | 36.0           | 18.3        | 1000            | 120.0           | 200.0       | V   | 270           | 23         |
| 903.921         | 15.49              | 36.0           | 20.5        | 1000            | 120.0           | 200.0       | V   | 180           | 26         |

**Plots:** 40 MHz channel bandwidth

**Plot 2:** 30 MHz to 1 GHz; vertical & horizontal polarization; valid for all channels and bands

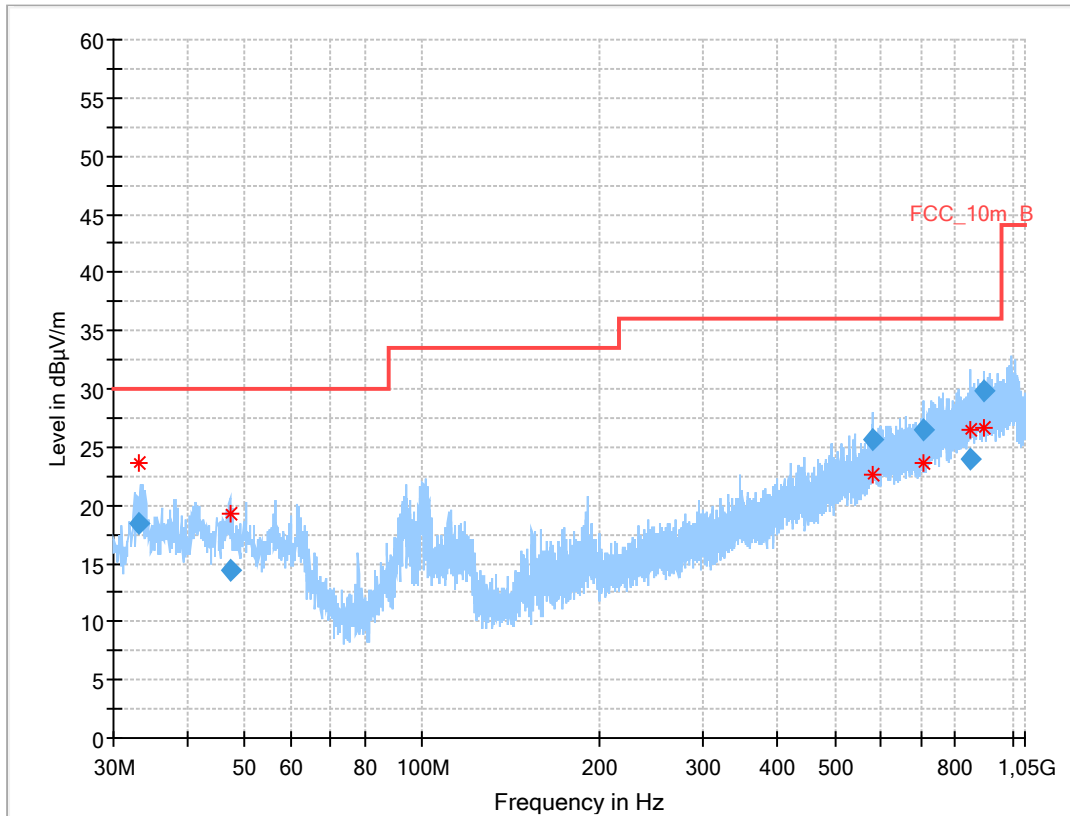

**Results:**

| Frequency (MHz) | QuasiPeak (dBµV/m) | Limit (dBµV/m) | Margin (dB) | Meas. Time (ms) | Bandwidth (kHz) | Height (cm) | Pol | Azimuth (deg) | Corr. (dB) |
|-----------------|--------------------|----------------|-------------|-----------------|-----------------|-------------|-----|---------------|------------|
| 33.689          | 16.75              | 30.0           | 13.3        | 1000            | 120.0           | 149.0       | V   | 243           | 14         |
| 46.782          | 12.48              | 30.0           | 17.5        | 1000            | 120.0           | 203.0       | V   | 8             | 16         |
| 62.010          | 12.86              | 30.0           | 17.1        | 1000            | 120.0           | 294.0       | V   | 180           | 13         |
| 94.209          | 18.12              | 33.5           | 15.4        | 1000            | 120.0           | 111.0       | V   | 302           | 12         |
| 719.380         | 17.72              | 36.0           | 18.3        | 1000            | 120.0           | 200.0       | V   | 270           | 23         |
| 903.921         | 15.49              | 36.0           | 20.5        | 1000            | 120.0           | 200.0       | V   | 180           | 26         |

**Plots:** 80 MHz channel bandwidth

**Plot 3:** 30 MHz to 1 GHz; vertical & horizontal polarization; valid for all channels and bands

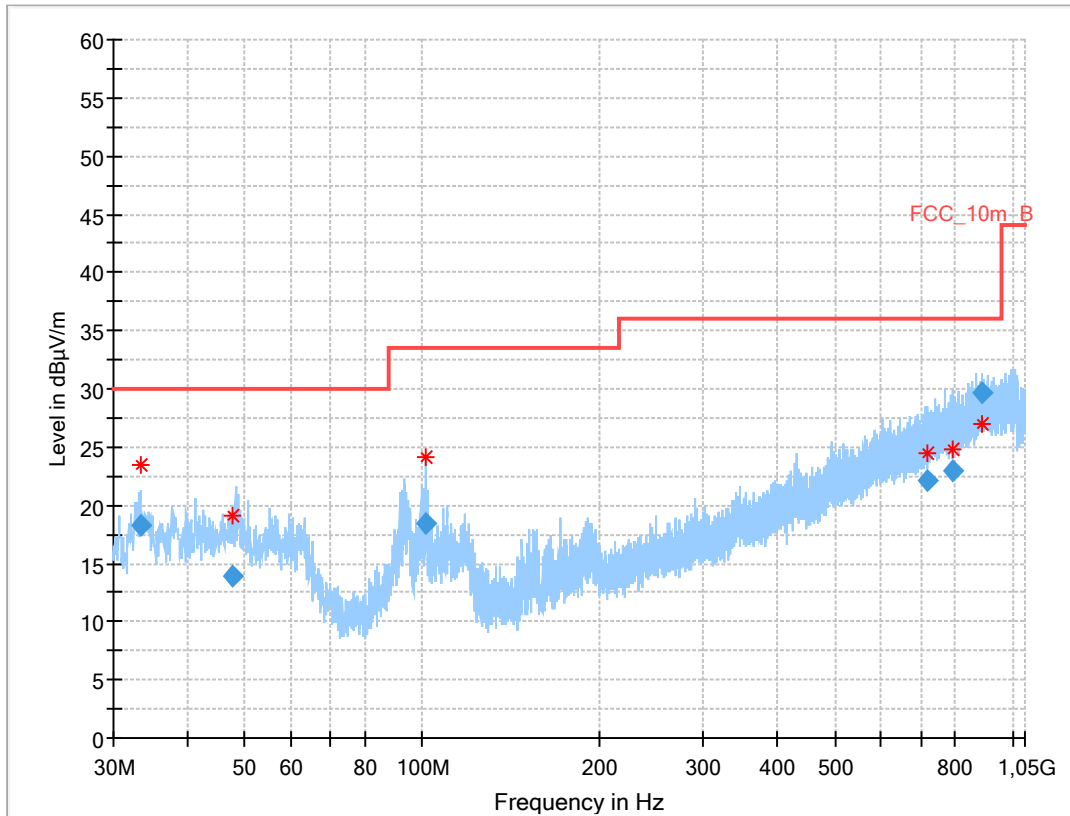

**Results:**

| Frequency (MHz) | QuasiPeak (dBµV/m) | Limit (dBµV/m) | Margin (dB) | Meas. Time (ms) | Bandwidth (kHz) | Height (cm) | Pol | Azimuth (deg) | Corr. (dB) |
|-----------------|--------------------|----------------|-------------|-----------------|-----------------|-------------|-----|---------------|------------|
| 33.347          | 18.26              | 30.0           | 11.7        | 1000            | 120.0           | 102.0       | V   | 243           | 14         |
| 47.763          | 13.96              | 30.0           | 16.0        | 1000            | 120.0           | 195.0       | V   | 192           | 16         |
| 101.787         | 18.51              | 33.5           | 15.0        | 1000            | 120.0           | 110.0       | V   | 284           | 14         |
| 715.398         | 22.07              | 36.0           | 13.9        | 1000            | 120.0           | 182.0       | H   | 142           | 23         |
| 792.389         | 22.88              | 36.0           | 13.1        | 1000            | 120.0           | 149.0       | H   | -31           | 24         |
| 888.348         | 29.74              | 36.0           | 6.3         | 1000            | 120.0           | 195.0       | H   | -37           | 25         |

### 12.13 Spurious emissions radiated 1 GHz to 40 GHz

Description:

Measurement of the radiated spurious emissions and cabinet radiations from 1 GHz to 40 GHz.

Measurement:

| Measurement parameter    |  |
|--------------------------|--|
| Detector:                | Peak / RMS   |
| Sweep time:              | Auto   |
| Resolution bandwidth:    | 1 MHz  |
| Video bandwidth:         | 3 MHz  |
| Span:                    | 1 GHz to 40 GHz  |
| Trace mode:              | Max Hold / Average with 100 counts + 20 log (1 / X)<br>for duty cycle lower than 100 % |
| Test setup:              | See sub clause 7.2 – B<br>See sub clause 7.3 – A                                       |
| Measurement uncertainty: | See chapter 9  |

Limits:

| TX Spurious Emissions Radiated |                         |                      |
|--------------------------------|-------------------------|----------------------|
| §15.209 / RSS-247              |                         |                      |
| Frequency (MHz)                | Field Strength (dBµV/m) | Measurement distance |
| Above 960                      | 54.0                    | 3                    |
| §15.407                        |                         |                      |
| Outside the restricted bands!  | -27 dBm / MHz           |                      |



**Results:** 20 MHz channel bandwidth

| TX Spurious Emissions Radiated [dBµV/m] / dBm             |          |                |   |          |                |   |          |                |
|---|----------|----------------|---|----------|----------------|---|----------|----------------|
| U-NII-1 (5150 MHz to 5250 MHz)                            |          |                |   |          |                |   |          |                |
| Lowest channel  |          |                | Middle channel  |          |                | Highest channel   |          |                |
| F [MHz]   | Detector | Level [dBµV/m] | F [MHz]   | Detector | Level [dBµV/m] | F [MHz]   | Detector | Level [dBµV/m] |
| -/-   | Peak     | -/-            |   | Peak     | -/-            | -/-   | Peak     | -/-            |
|   | AVG      | -/-            |   | AVG      | -/-            |   | AVG      | -/-            |
| For emissions above 18 GHz please take look at the plots. |          |                | For emissions above 18 GHz please take look at the plots. |          |                | For emissions above 18 GHz please take look at the plots. |          |                |

| TX Spurious Emissions Radiated [dBµV/m] / dBm             |          |                |   |          |                |   |          |                |
|---|----------|----------------|---|----------|----------------|---|----------|----------------|
| U-NII-2A (5250 MHz to 5350 MHz)                           |          |                |   |          |                |   |          |                |
| Lowest channel  |          |                | Middle channel  |          |                | Highest channel   |          |                |
| F [MHz]   | Detector | Level [dBµV/m] | F [MHz]   | Detector | Level [dBµV/m] | F [MHz]   | Detector | Level [dBµV/m] |
| -/-   | Peak     | -/-            |   | Peak     | -/-            | -/-   | Peak     | -/-            |
|   | AVG      | -/-            |   | AVG      | -/-            |   | AVG      | -/-            |
| For emissions above 18 GHz please take look at the plots. |          |                | For emissions above 18 GHz please take look at the plots. |          |                | For emissions above 18 GHz please take look at the plots. |          |                |

| TX Spurious Emissions Radiated [dBµV/m] / dBm             |          |                |   |          |                |   |          |                |
|---|----------|----------------|---|----------|----------------|---|----------|----------------|
| U-NII-2C (5470 MHz to 5725 MHz)                           |          |                |   |          |                |   |          |                |
| Lowest channel  |          |                | Middle channel  |          |                | Highest channel   |          |                |
| F [MHz]   | Detector | Level [dBµV/m] | F [MHz]   | Detector | Level [dBµV/m] | F [MHz]   | Detector | Level [dBµV/m] |
| -/-   | Peak     | -/-            | -/-   | Peak     | -/-            | -/-   | Peak     | -/-            |
|   | AVG      | -/-            | -/-   | AVG      | -/-            |   | AVG      | -/-            |
| For emissions above 18 GHz please take look at the plots. |          |                | For emissions above 18 GHz please take look at the plots. |          |                | For emissions above 18 GHz please take look at the plots. |          |                |

| TX Spurious Emissions Radiated [dBµV/m] / dBm             |          |                |   |          |                |   |          |                |
|---|----------|----------------|---|----------|----------------|---|----------|----------------|
| U-NII-3 (5725 MHz to 5850 MHz)                            |          |                |   |          |                |   |          |                |
| Lowest channel  |          |                | Middle channel  |          |                | Highest channel   |          |                |
| F [MHz]   | Detector | Level [dBµV/m] | F [MHz]   | Detector | Level [dBµV/m] | F [MHz]   | Detector | Level [dBµV/m] |
| -/-   | Peak     | -/-            | -/-   | Peak     | -/-            | -/-   | Peak     | -/-            |
|   | AVG      | -/-            |   | AVG      | -/-            |   | AVG      | -/-            |
| For emissions above 18 GHz please take look at the plots. |          |                | For emissions above 18 GHz please take look at the plots. |          |                | For emissions above 18 GHz please take look at the plots. |          |                |

**Results:** 40 MHz channel bandwidth

| TX Spurious Emissions Radiated [dB $\mu$ V/m] / dBm       |      |     |   |      |     |
|---|------|-----|---|------|-----|
| U-NII-1 (5150 MHz to 5250 MHz)                            |      |     |   |      |     |
| Lowest channel  |      |     | Highest channel   |      |     |
| -/-   | Peak | -/- | -/-   | Peak | -/- |
|   | AVG  | -/- |   | AVG  | -/- |
| For emissions above 18 GHz please take look at the plots. |      |     | For emissions above 18 GHz please take look at the plots. |      |     |

| TX Spurious Emissions Radiated [dB $\mu$ V/m] / dBm       |      |     |   |      |     |
|---|------|-----|---|------|-----|
| U-NII-2A (5250 MHz to 5350 MHz)                           |      |     |   |      |     |
| Lowest channel  |      |     | Highest channel   |      |     |
| -/-   | Peak | -/- | -/-   | Peak | -/- |
|   | AVG  | -/- |   | AVG  | -/- |
| For emissions above 18 GHz please take look at the plots. |      |     | For emissions above 18 GHz please take look at the plots. |      |     |

| TX Spurious Emissions Radiated [dB $\mu$ V/m] / dBm       |          |                      |   |          |                      |   |          |                      |
|---|----------|----------------------|---|----------|----------------------|---|----------|----------------------|
| U-NII-2C (5470 MHz to 5725 MHz)                           |          |                      |   |          |                      |   |          |                      |
| Lowest channel  |          |                      | Middle channel  |          |                      | Highest channel   |          |                      |
| F [MHz]   | Detector | Level [dB $\mu$ V/m] | F [MHz]   | Detector | Level [dB $\mu$ V/m] | F [MHz]   | Detector | Level [dB $\mu$ V/m] |
| -/-   | Peak     | -/-                  | -/-   | Peak     | -/-                  | -/-   | Peak     | -/-                  |
|   | AVG      | -/-                  |   | AVG      | -/-                  |   | AVG      | -/-                  |
| For emissions above 18 GHz please take look at the plots. |          |                      | For emissions above 18 GHz please take look at the plots. |          |                      | For emissions above 18 GHz please take look at the plots. |          |                      |

| TX Spurious Emissions Radiated [dB $\mu$ V/m] / dBm       |      |     |   |      |     |
|---|------|-----|---|------|-----|
| U-NII-3 (5725 MHz to 5850 MHz)                            |      |     |   |      |     |
| Lowest channel  |      |     | Highest channel   |      |     |
| -/-   | Peak | -/- | -/-   | Peak | -/- |
|   | AVG  | -/- |   | AVG  | -/- |
| For emissions above 18 GHz please take look at the plots. |      |     | For emissions above 18 GHz please take look at the plots. |      |     |

**Results:** 80 MHz channel bandwidth

| TX Spurious Emissions Radiated [dB $\mu$ V/m] / dBm       |          |                      |
|---|----------|----------------------|
| U-NII-1 (5150 MHz to 5250 MHz)                            |          |                      |
| Middle channel  |          |                      |
| F [MHz]   | Detector | Level [dB $\mu$ V/m] |
| -/-   | Peak     | -/-                  |
|   | AVG      | -/-                  |
| For emissions above 18 GHz please take look at the plots. |          |                      |

| TX Spurious Emissions Radiated [dB $\mu$ V/m] / dBm       |          |                      |
|---|----------|----------------------|
| U-NII-2A (5250 MHz to 5350 MHz)                           |          |                      |
| Middle channel  |          |                      |
| F [MHz]   | Detector | Level [dB $\mu$ V/m] |
| -/-   | Peak     | -/-                  |
|   | AVG      | -/-                  |
| For emissions above 18 GHz please take look at the plots. |          |                      |

| TX Spurious Emissions Radiated [dB $\mu$ V/m] / dBm       |      |     |   |      |     |
|---|------|-----|---|------|-----|
| U-NII-2C (5470 MHz to 5725 MHz)                           |      |     |   |      |     |
| Lowest channel  |      |     | Highest channel   |      |     |
| -/-   | Peak | -/- | -/-   | Peak | -/- |
|   | AVG  | -/- |   | AVG  | -/- |
| For emissions above 18 GHz please take look at the plots. |      |     | For emissions above 18 GHz please take look at the plots. |      |     |

| TX Spurious Emissions Radiated [dB $\mu$ V/m] / dBm       |          |                      |
|---|----------|----------------------|
| U-NII-3 (5725 MHz to 5850 MHz)                            |          |                      |
| Middle channel  |          |                      |
| F [MHz]   | Detector | Level [dB $\mu$ V/m] |
| -/-   | Peak     | -/-                  |
|   | AVG      | -/-                  |
| For emissions above 18 GHz please take look at the plots. |          |                      |

Note: The carrier signal is notched with a UNII band rejection filter.

**Plots:** 20 MHz channel bandwidth

**Plot 1:** 1 GHz to 18 GHz; vertical & horizontal polarization; U-NII-1; lowest channel

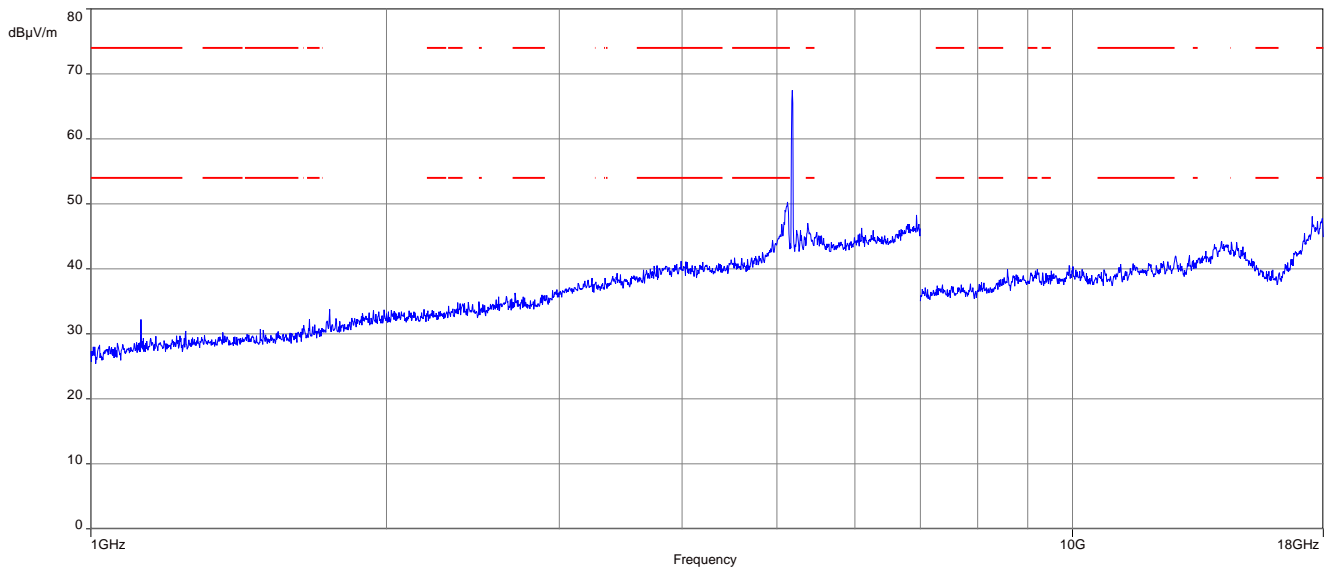

**Plot 2:** 1 GHz to 18 GHz; vertical & horizontal polarization; U-NII-1; middle channel

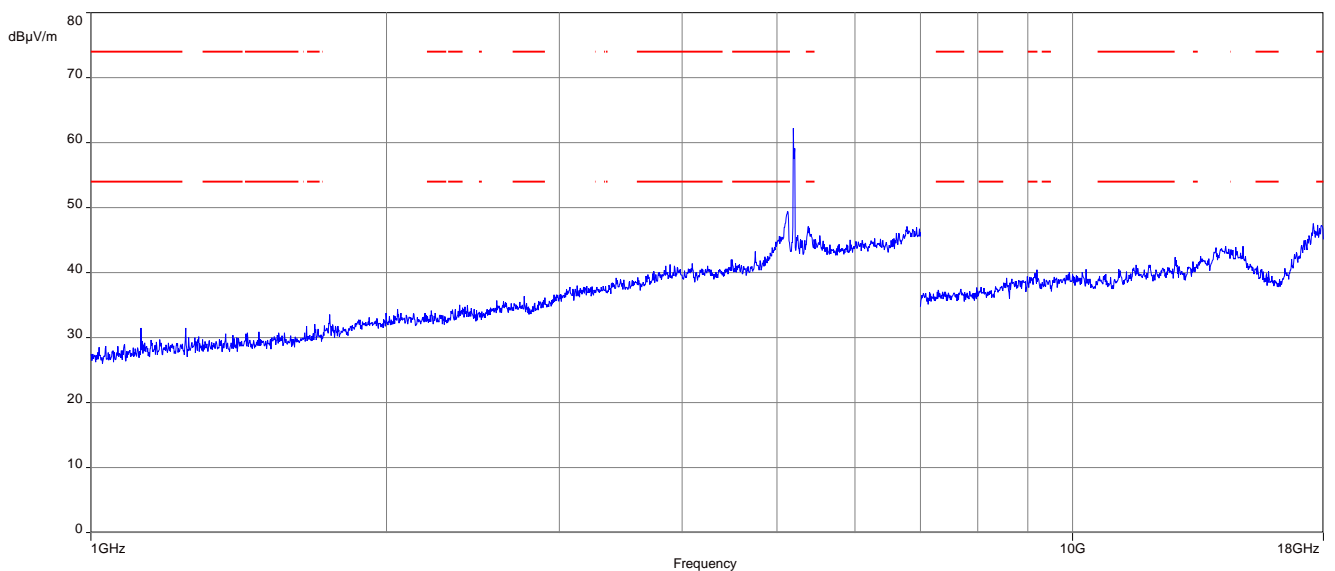

**Plot 3:** 1 GHz to 18 GHz; vertical & horizontal polarization; U-NII-1; highest channel

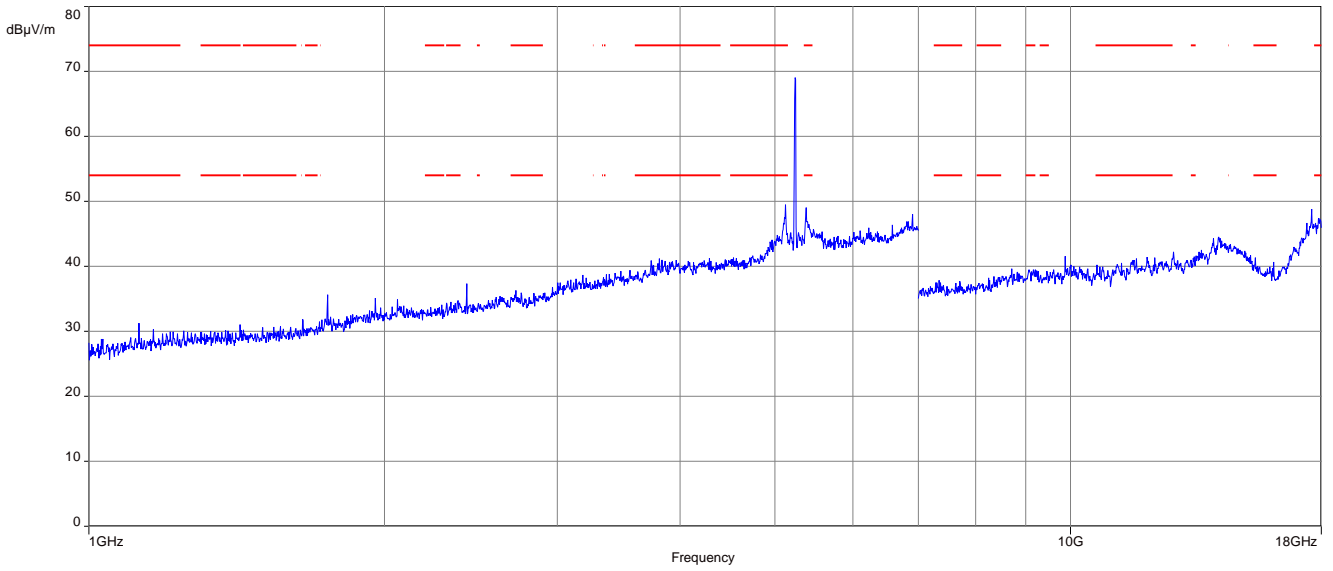

**Plot 4:** 1 GHz to 18 GHz; vertical & horizontal polarization; U-NII-2A; lowest channel

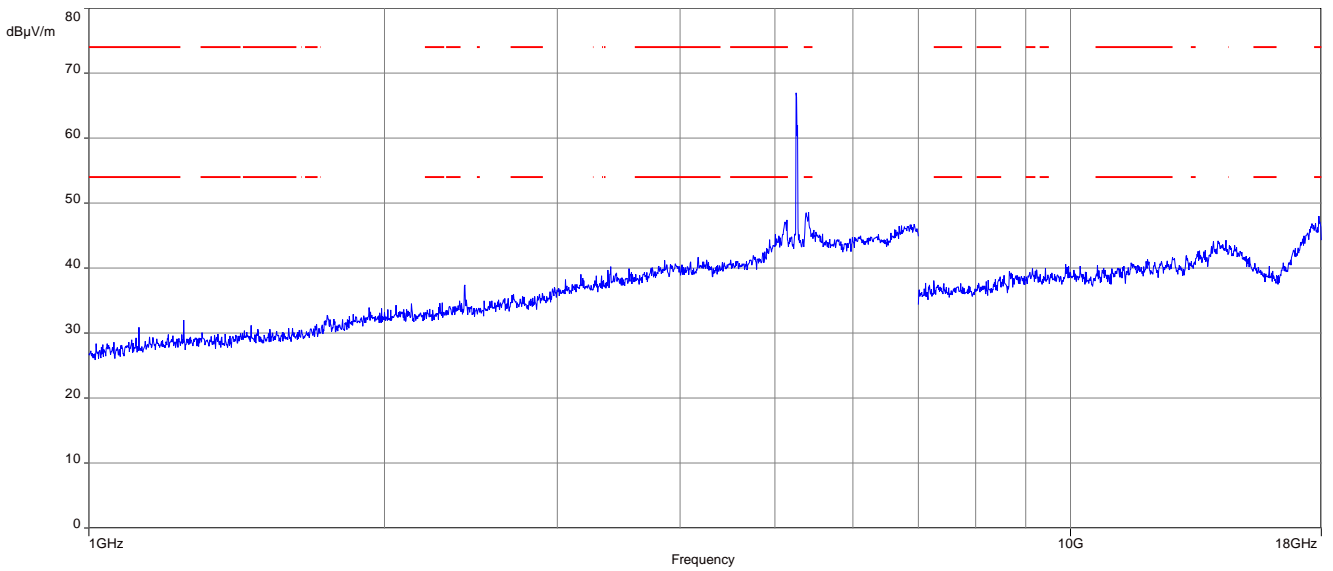

**Plot 5:** 1 GHz to 18 GHz; vertical & horizontal polarization; U-NII-2A; middle channel

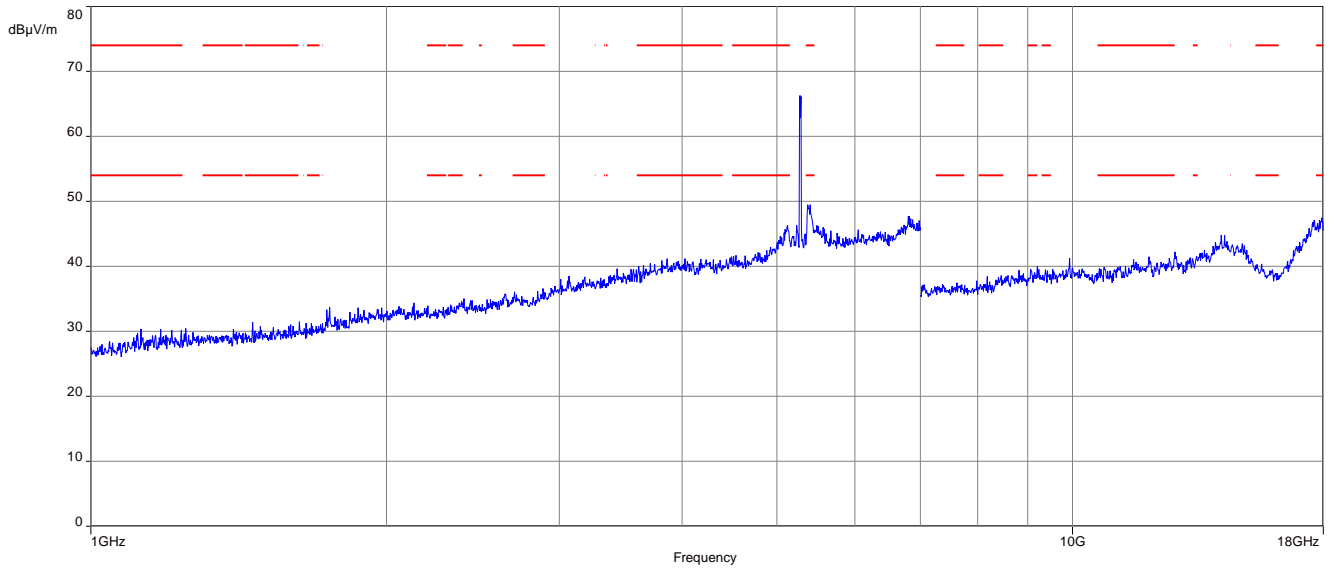

**Plot 6:** 1 GHz to 18 GHz; vertical & horizontal polarization; U-NII-2A; highest channel

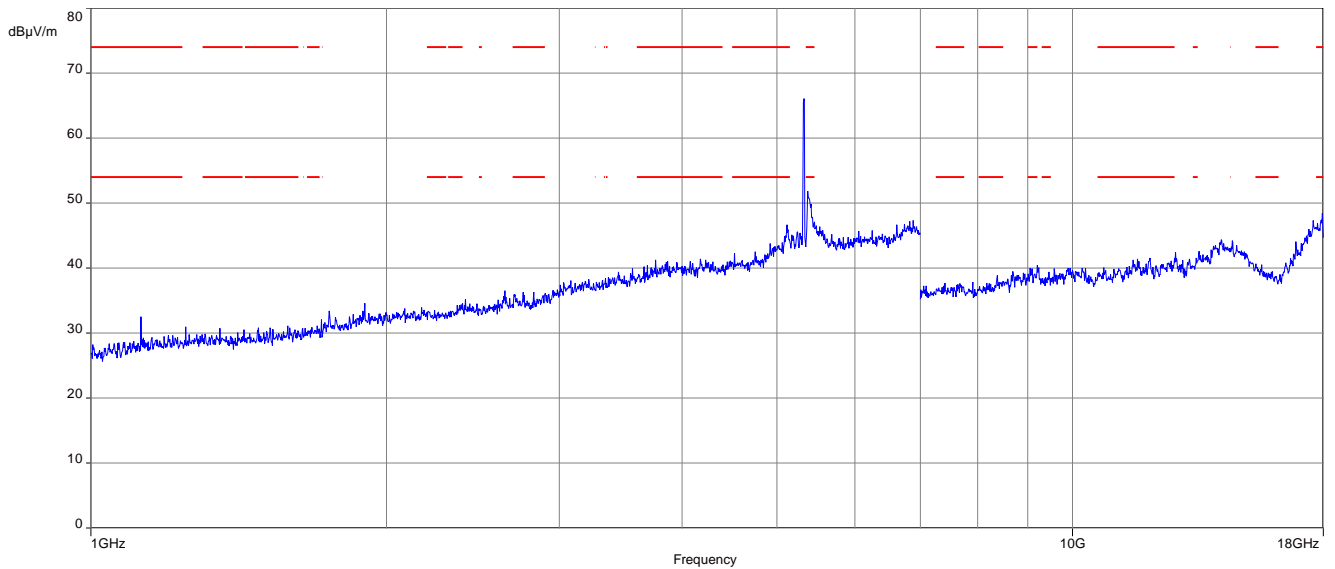

**Plot 7:** 1 GHz to 18 GHz; vertical & horizontal polarization; U-NII-2C; lowest channel

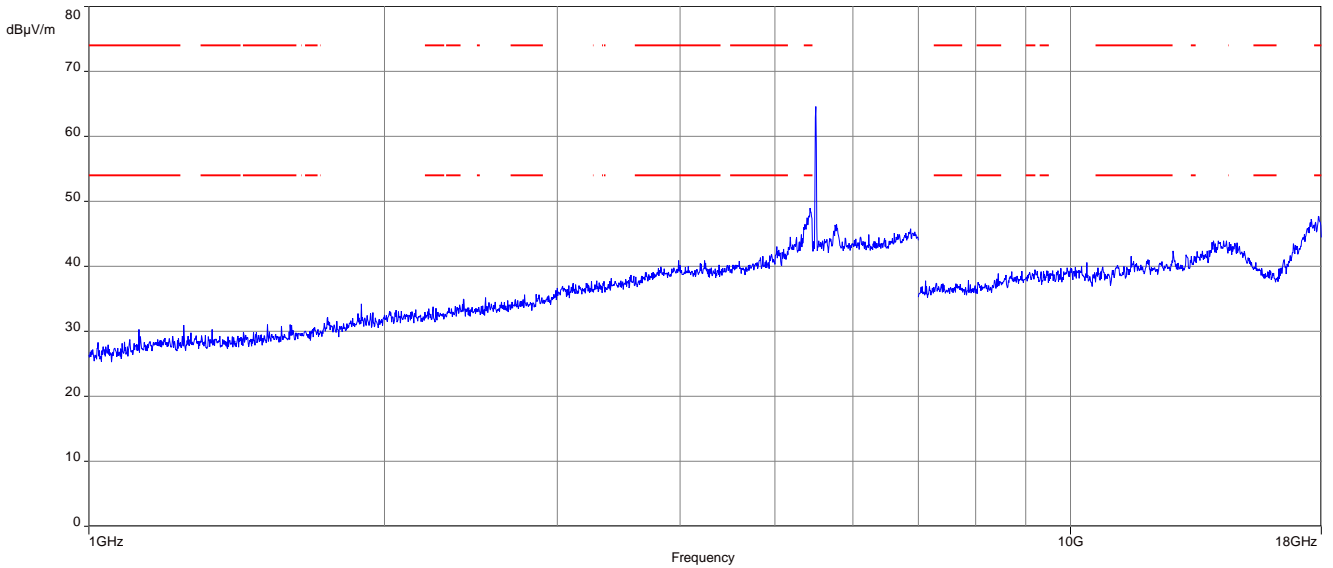

**Plot 8:** 1 GHz to 18 GHz; vertical & horizontal polarization; U-NII-2C; middle channel

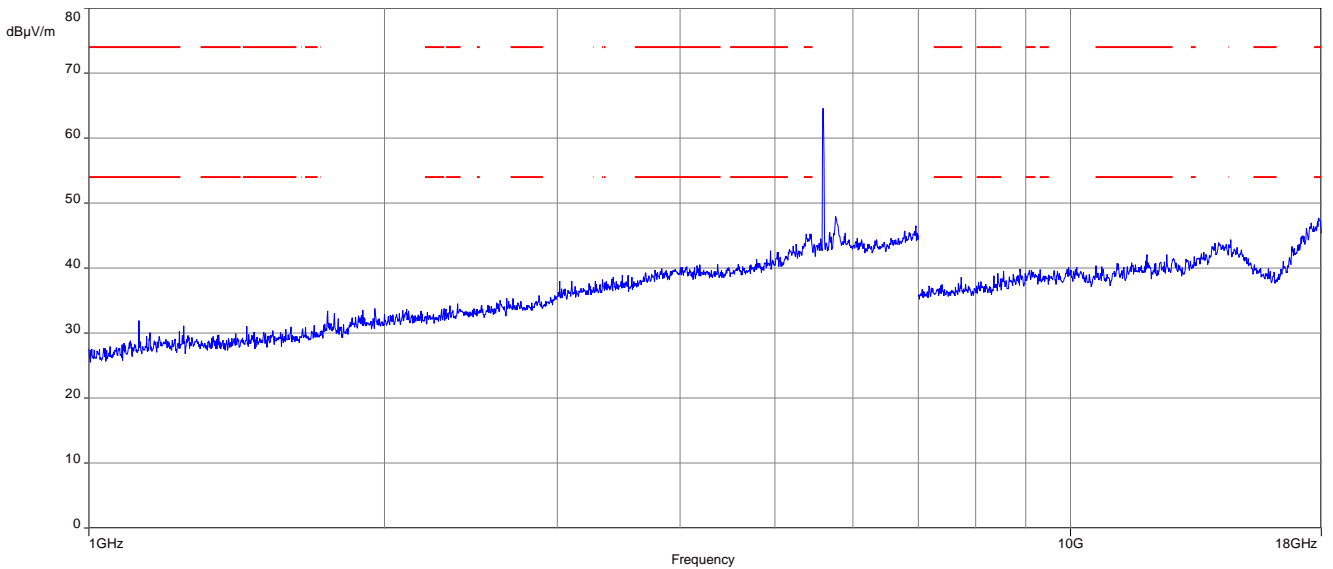

**Plot 9:** 1 GHz to 18 GHz; vertical & horizontal polarization; U-NII-2C; highest channel

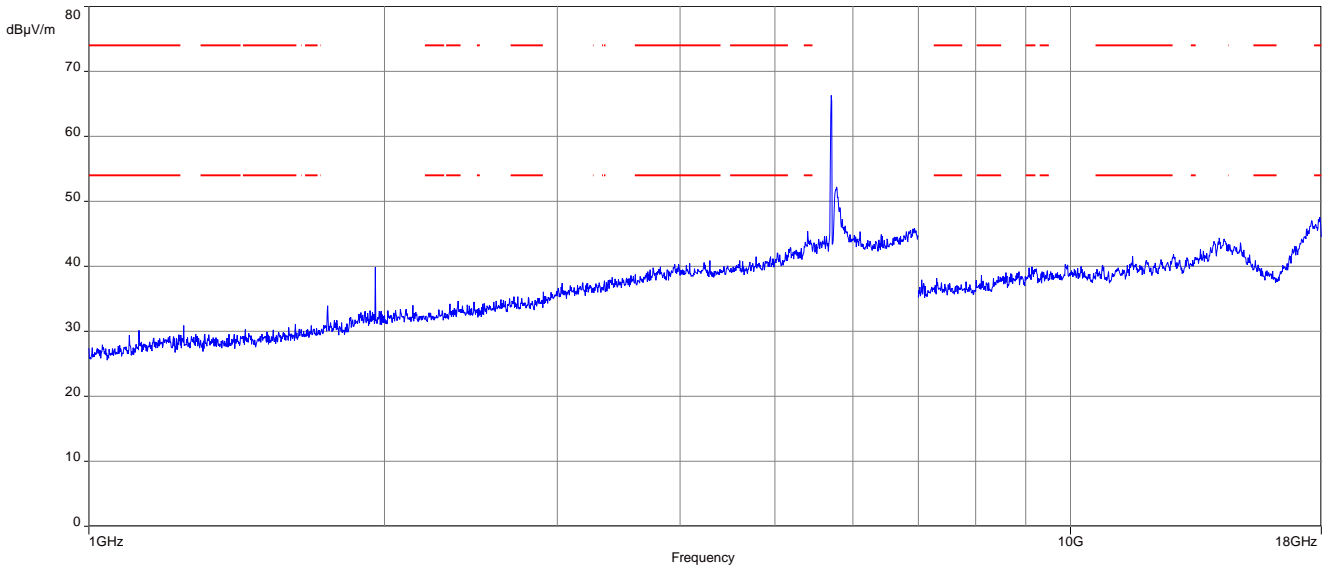

**Plot 10:** 1 GHz to 18 GHz; vertical & horizontal polarization; U-NII-3; lowest channel

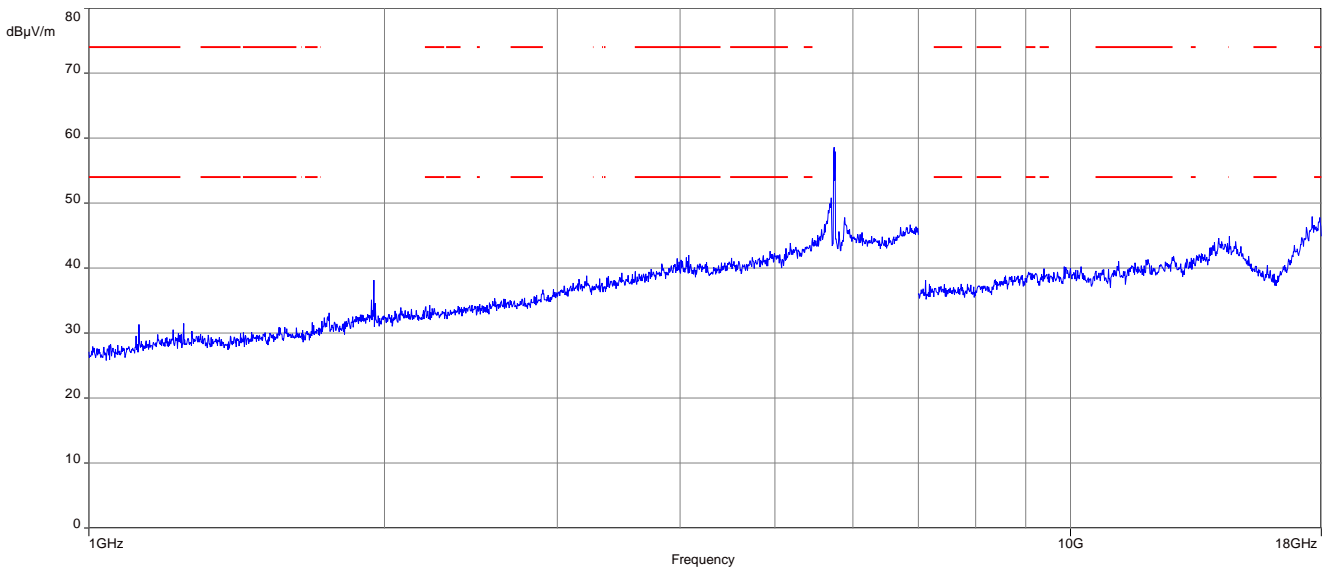



**Plot 11:** 1 GHz to 18 GHz; vertical & horizontal polarization; U-NII-3; middle channel

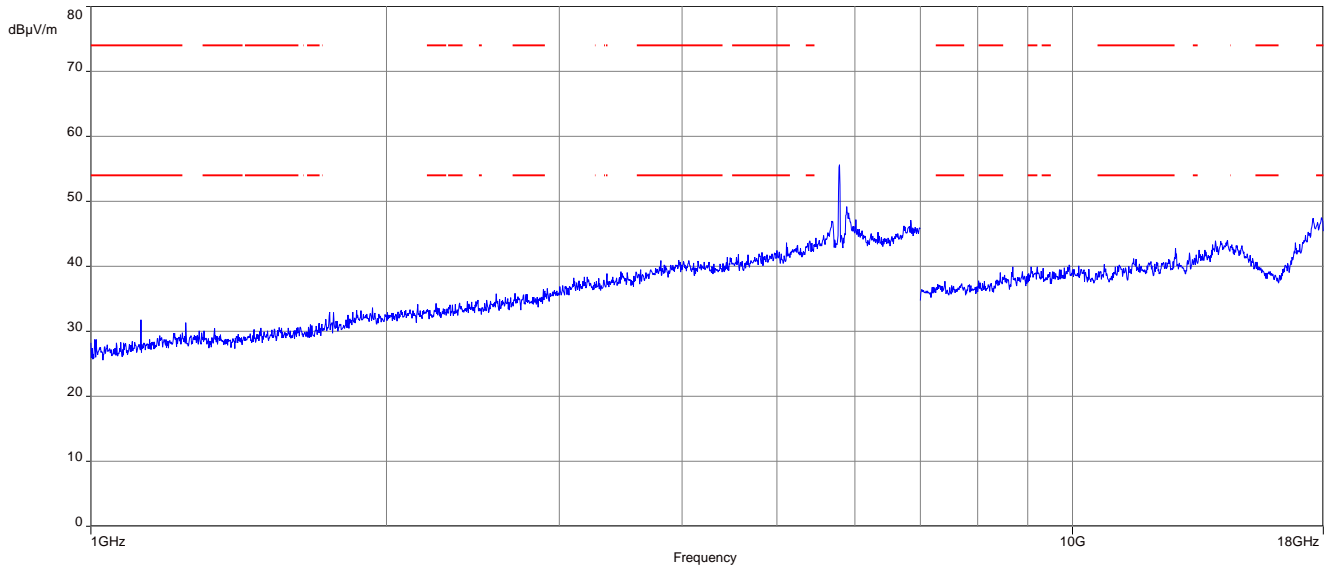

**Plot 12:** 1 GHz to 18 GHz; vertical & horizontal polarization; U-NII-3; highest channel

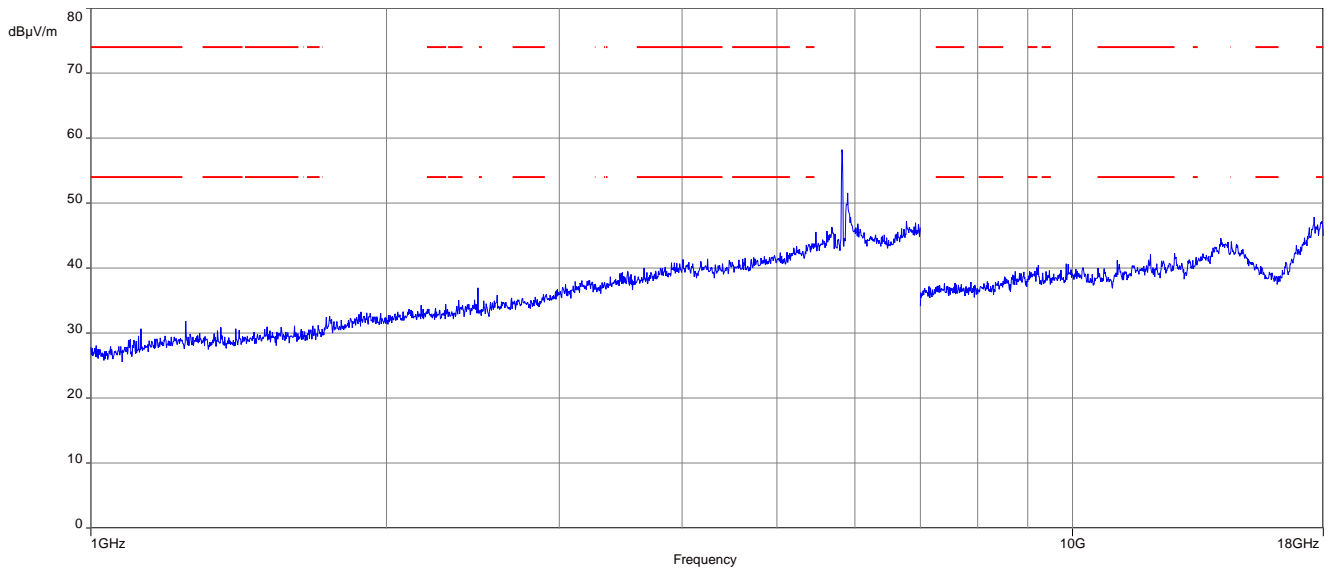

**Plot 13:** 18 GHz to 26 GHz; vertical & horizontal polarization; all channels

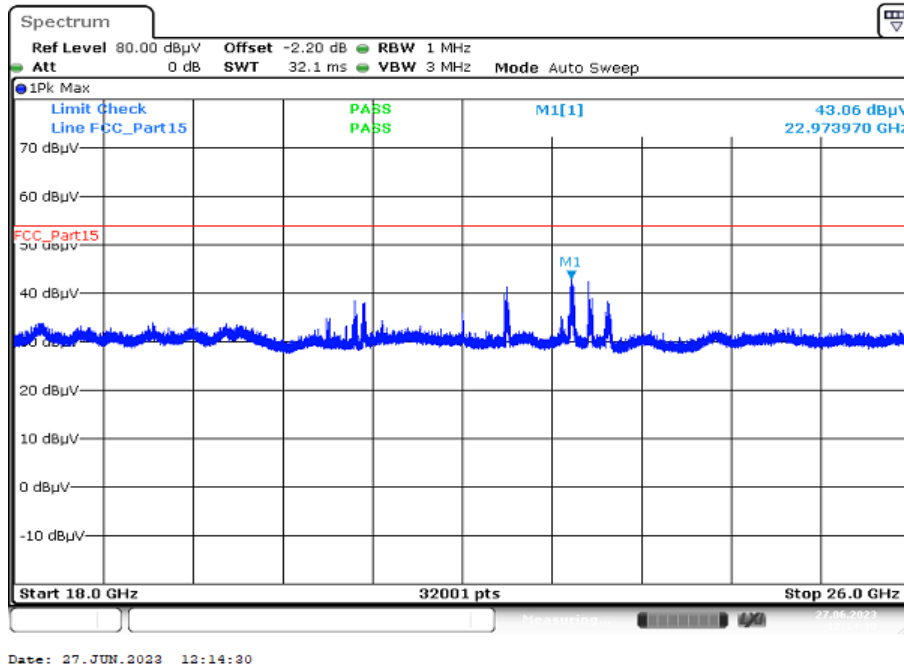

**Plot 14:** 26 GHz to 40 GHz; vertical & horizontal polarization; all channels

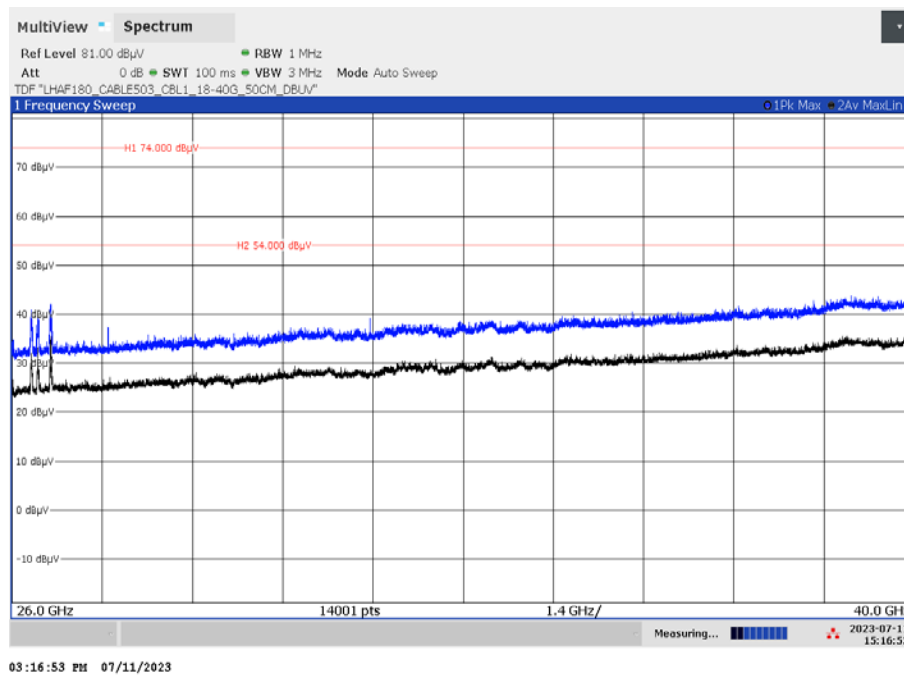

**Plots:** 40 MHz channel bandwidth

**Plot 1:** 1 GHz to 18 GHz; vertical & horizontal polarization; U-NII-1; lowest channel

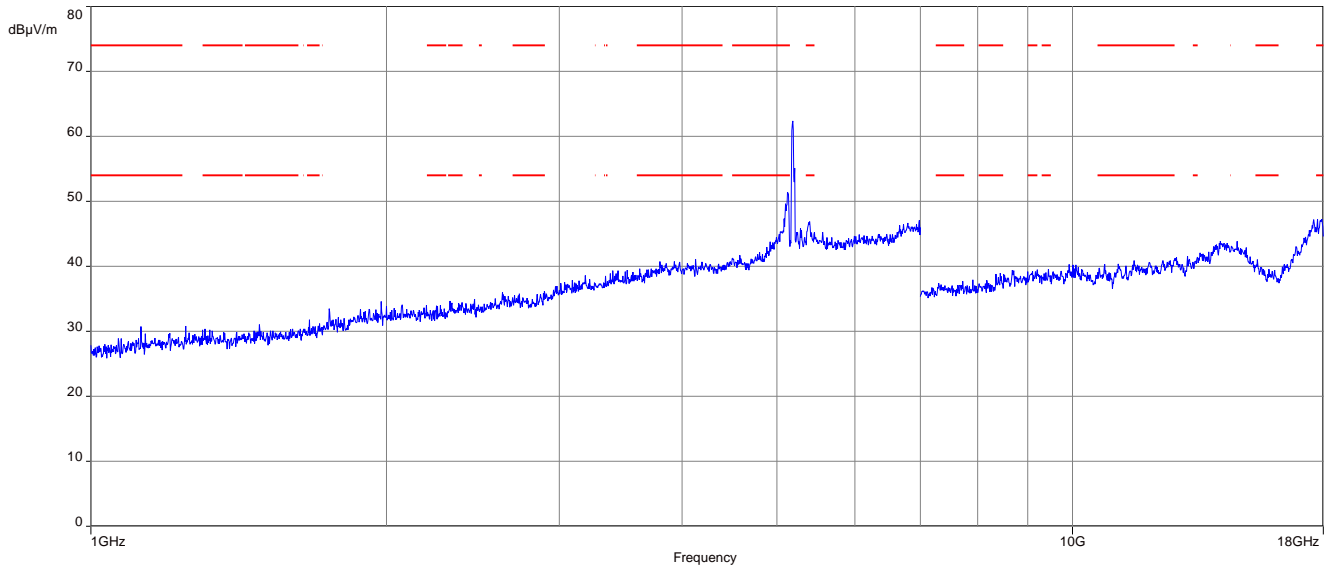

**Plot 2:** 1 GHz to 18 GHz; vertical & horizontal polarization; U-NII-1; highest channel

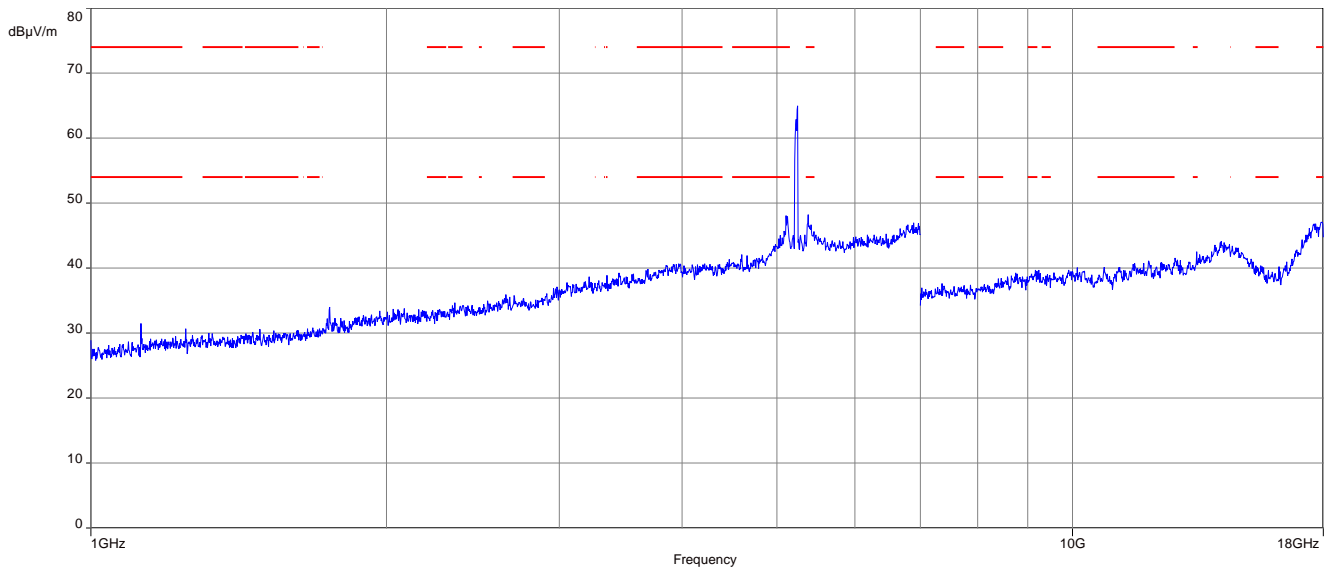

**Plot 3:** 1 GHz to 18 GHz; vertical & horizontal polarization; U-NII-2A; lowest channel

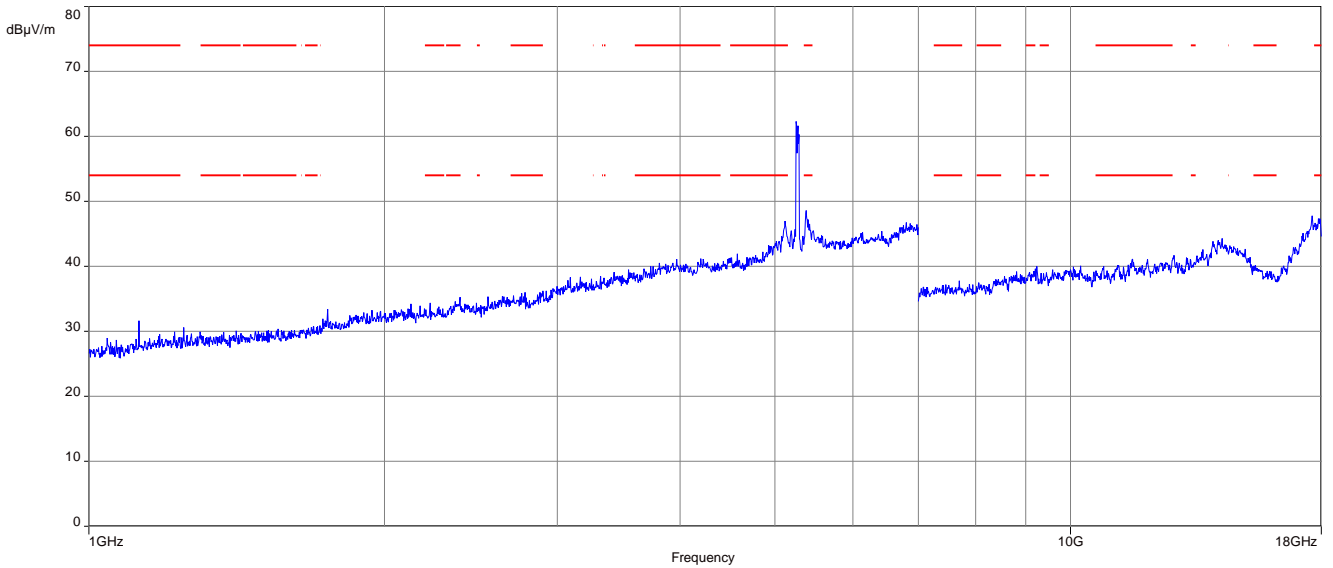

**Plot 4:** 1 GHz to 18 GHz; vertical & horizontal polarization; U-NII-2A; highest channel

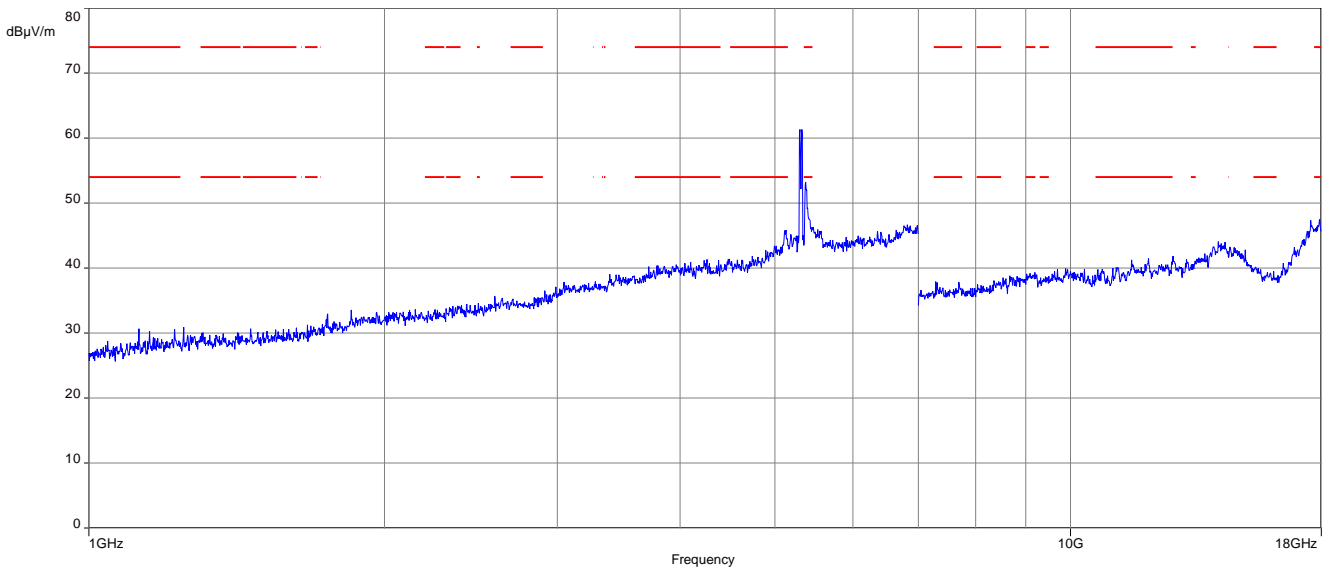

**Plot 5:** 1 GHz to 18 GHz; vertical & horizontal polarization; U-NII-2C; lowest channel

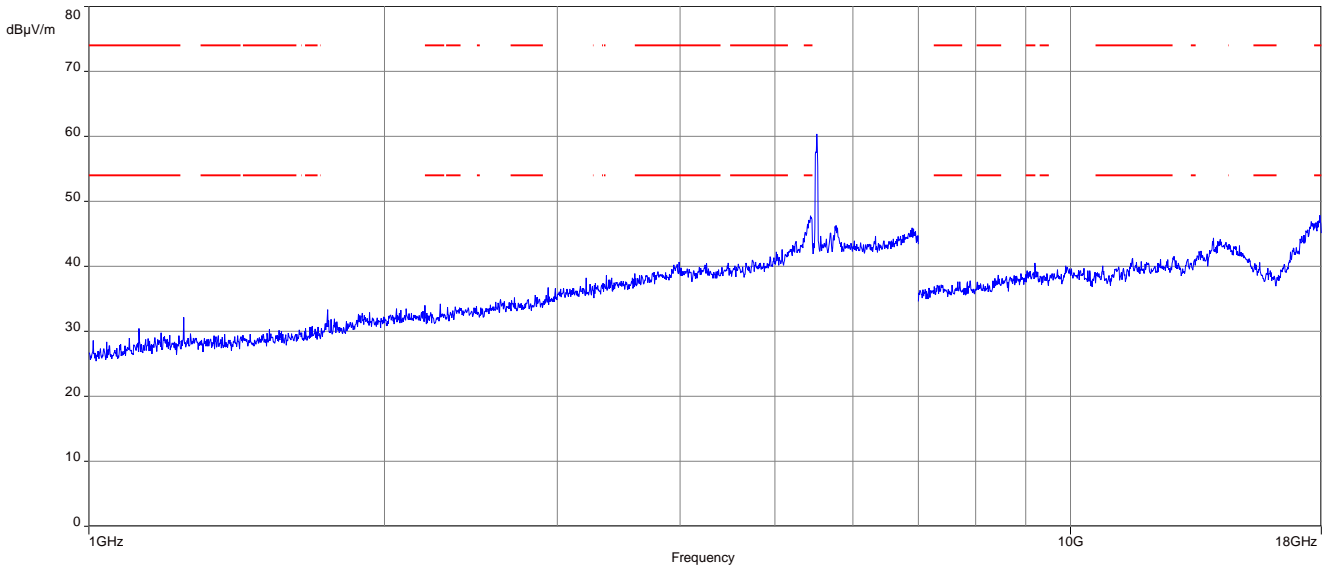

**Plot 6:** 1 GHz to 18 GHz; vertical & horizontal polarization; U-NII-2C; middle channel

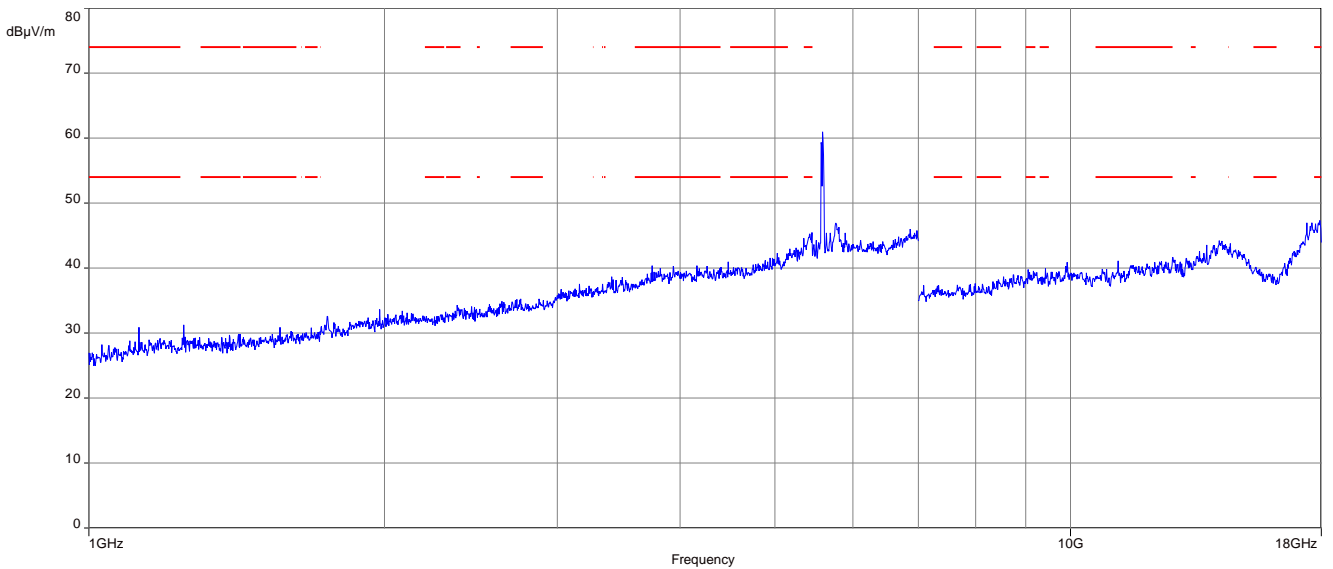

**Plot 7:** 1 GHz to 18 GHz; vertical & horizontal polarization; U-NII-2C; highest channel

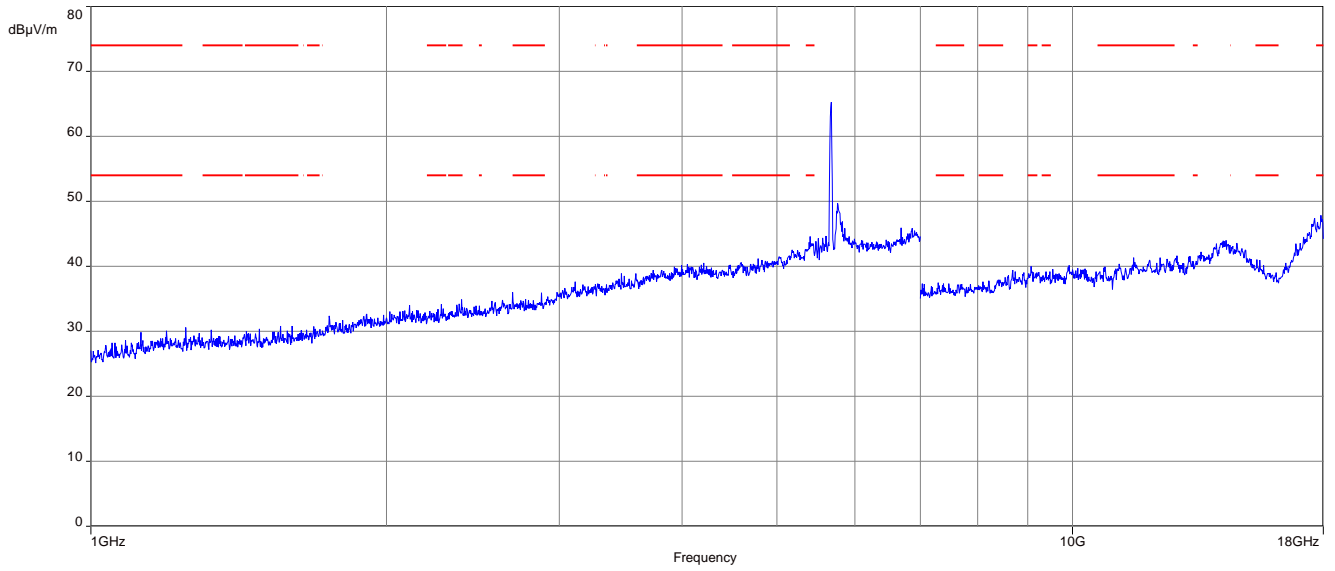

**Plot 8:** 1 GHz to 18 GHz; vertical & horizontal polarization; U-NII-3; lowest channel

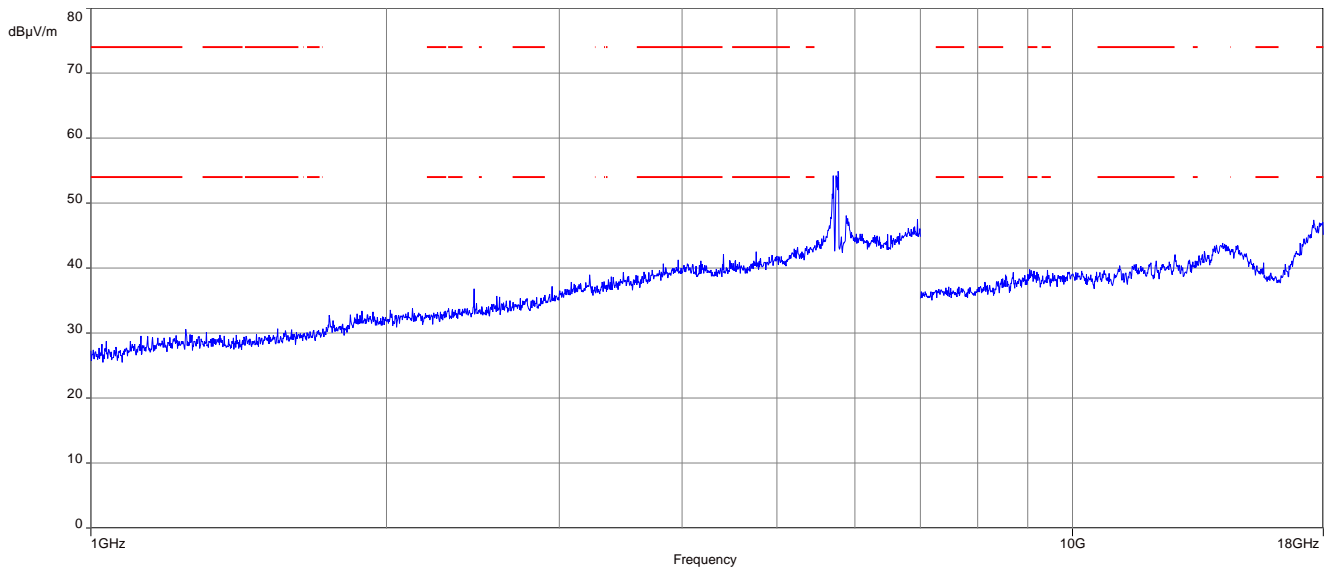

**Plot 9:** 1 GHz to 18 GHz; vertical & horizontal polarization; U-NII-3; highest channel

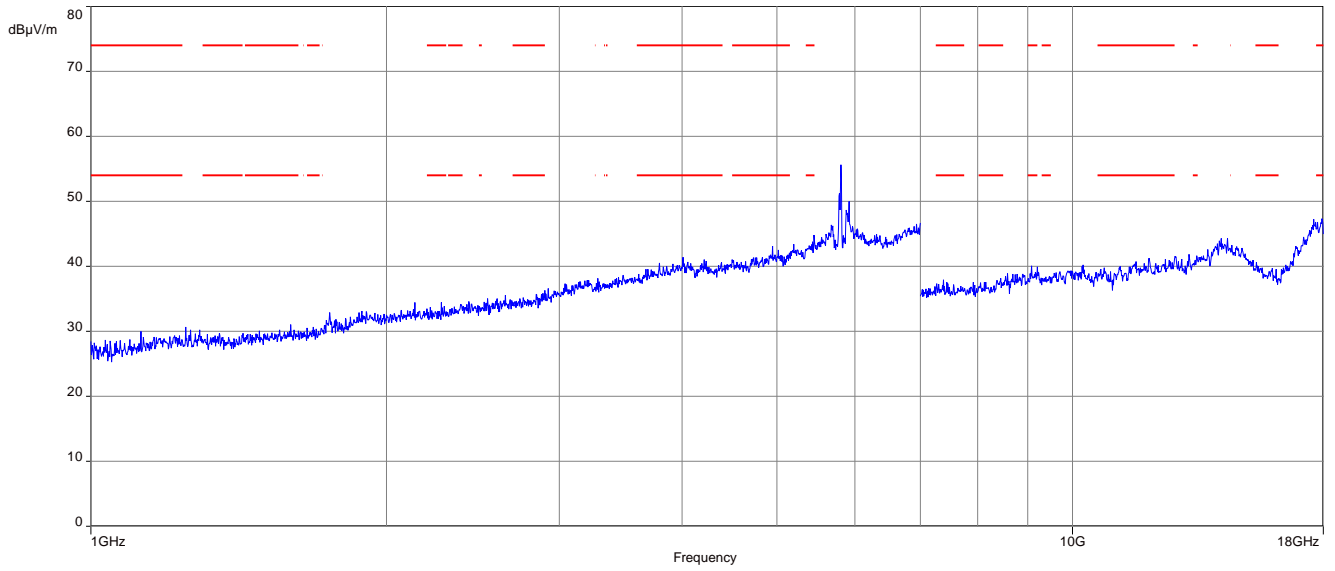

Plot 10: 18 GHz to 26 GHz; vertical & horizontal polarization; all channels

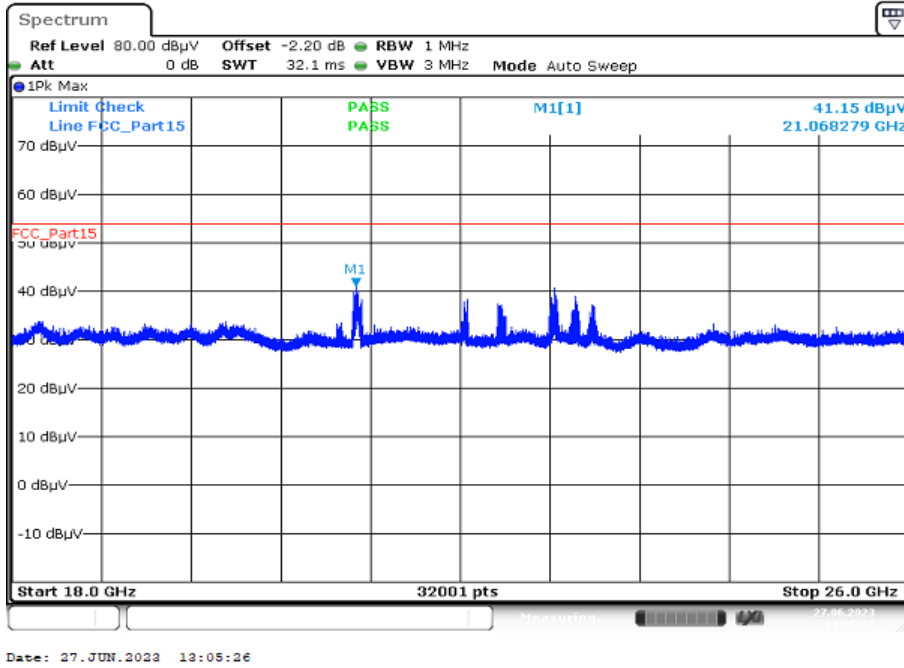

Plot 11: 26 GHz to 40 GHz; vertical & horizontal polarization; all channels

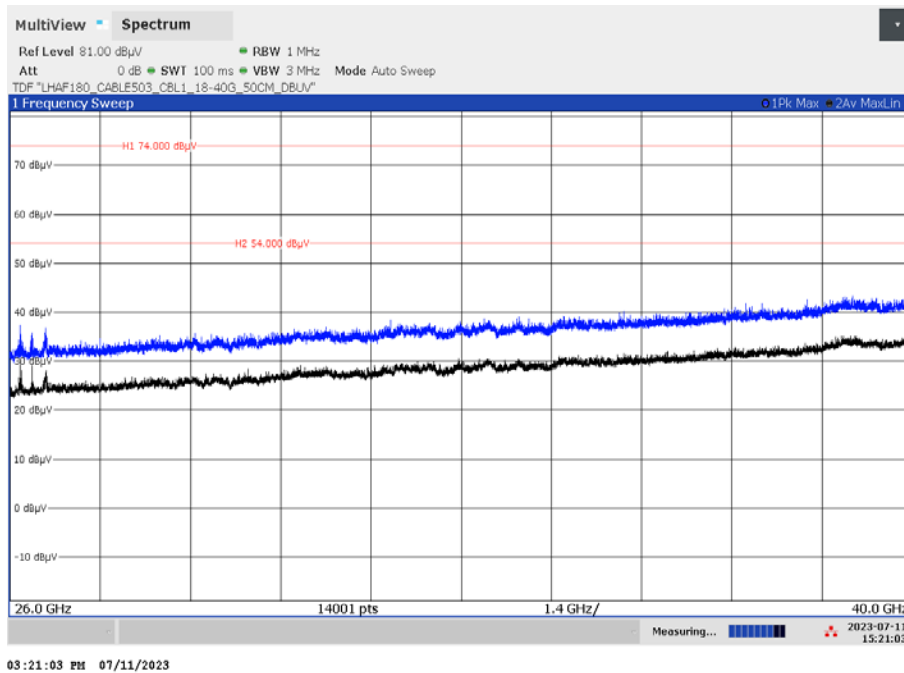



**Plots:** 80 MHz channel bandwidth

**Plot 1:** 1 GHz to 18 GHz; vertical & horizontal polarization; U-NII-1; middle channel

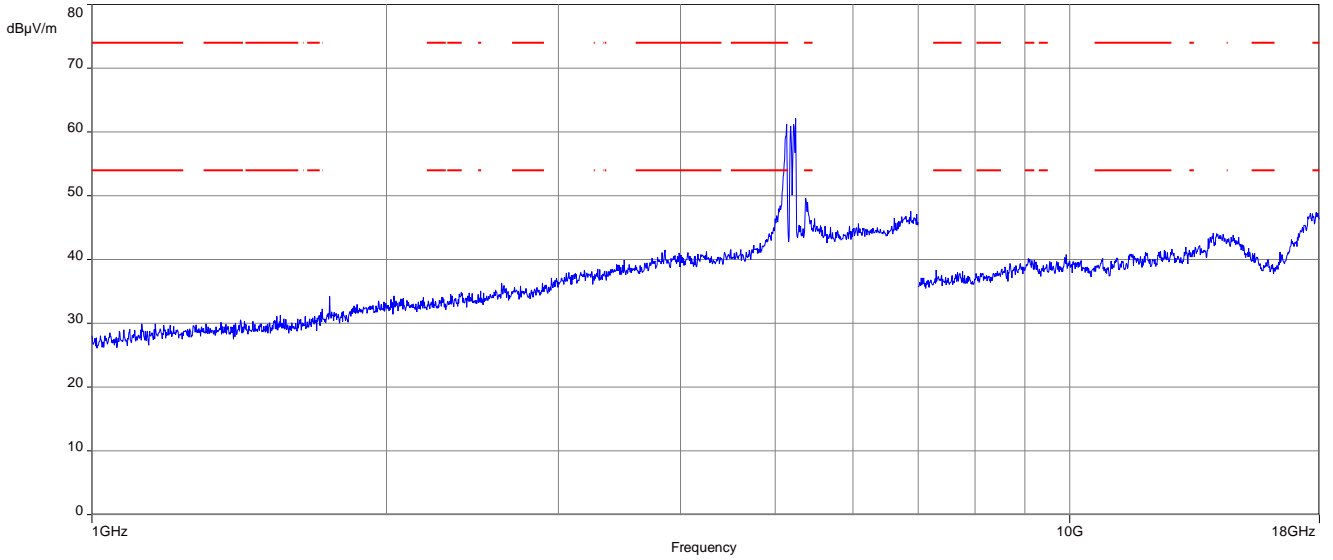

**Plot 2:** 1 GHz to 18 GHz; vertical & horizontal polarization; U-NII-2A; middle channel

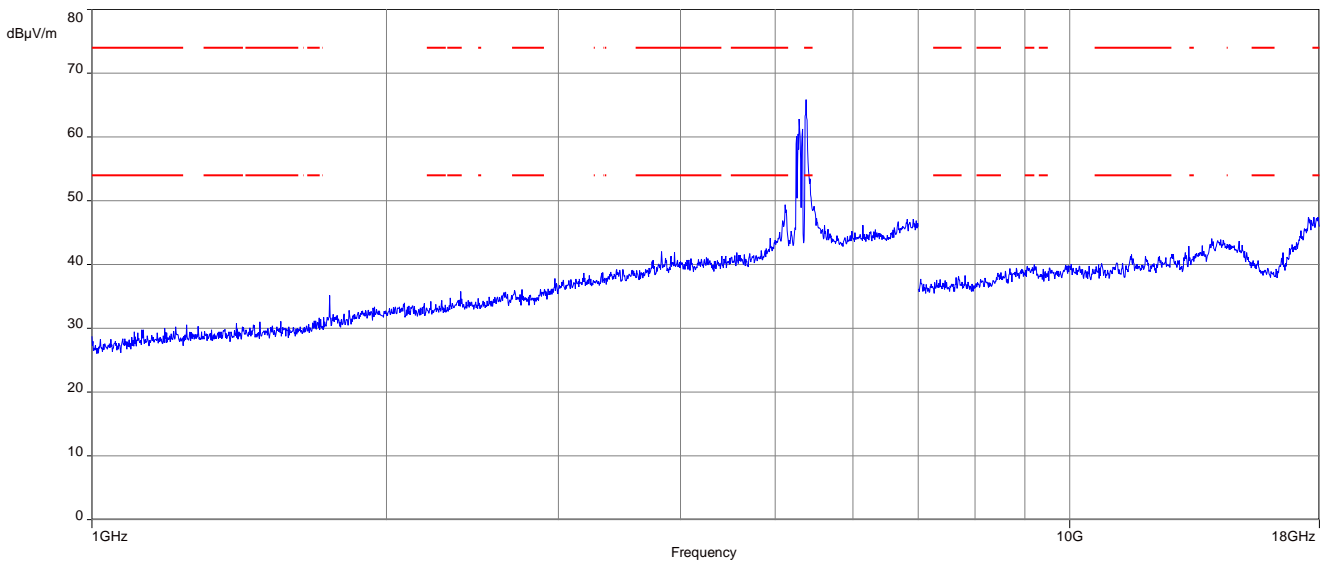

**Plot 3:** 1 GHz to 18 GHz; vertical & horizontal polarization; U-NII-2C; lowest channel

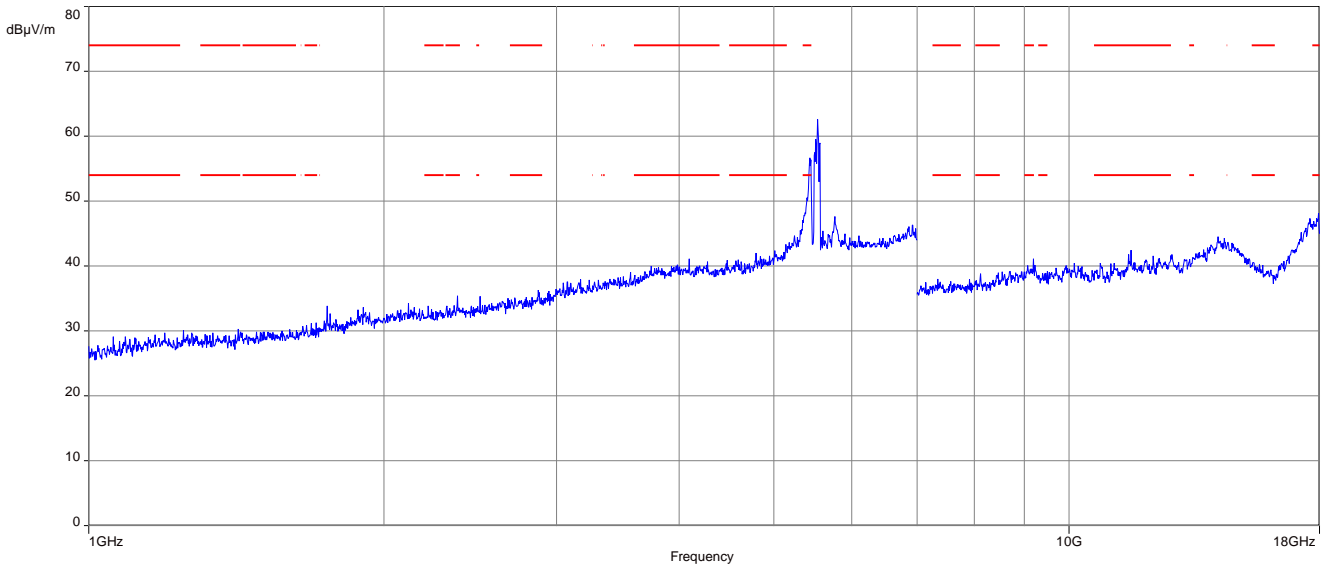

**Plot 4:** 1 GHz to 18 GHz; vertical & horizontal polarization; U-NII-2C; middle channel

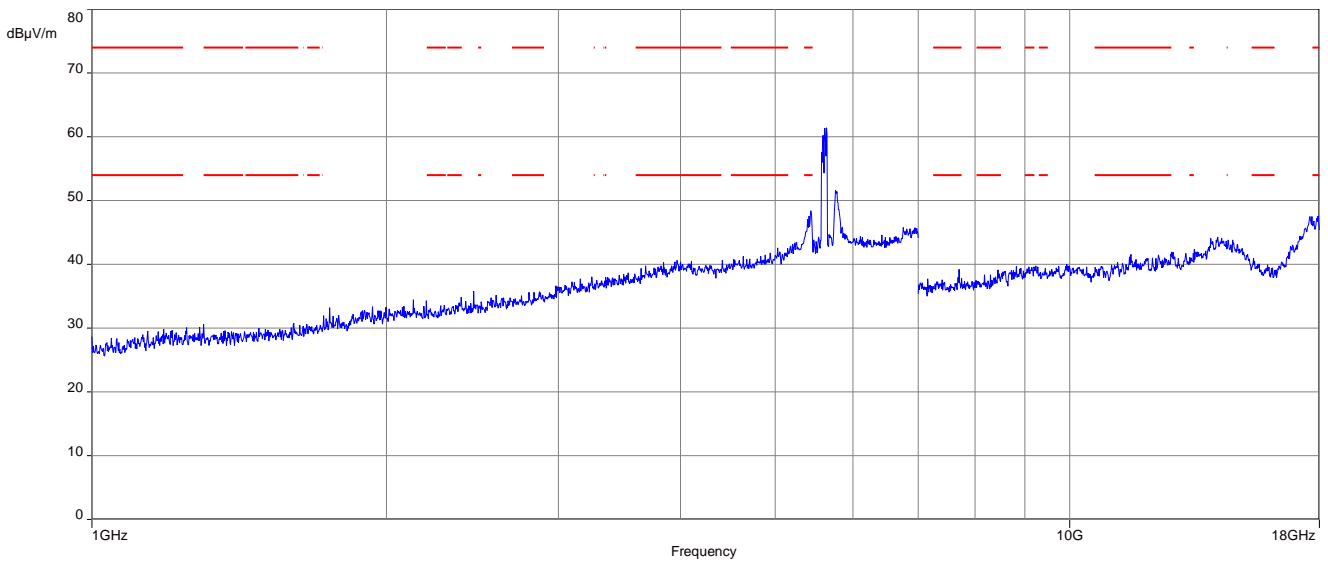

**Plot 5:** 1 GHz to 18 GHz; vertical & horizontal polarization; U-NII-3; middle channel

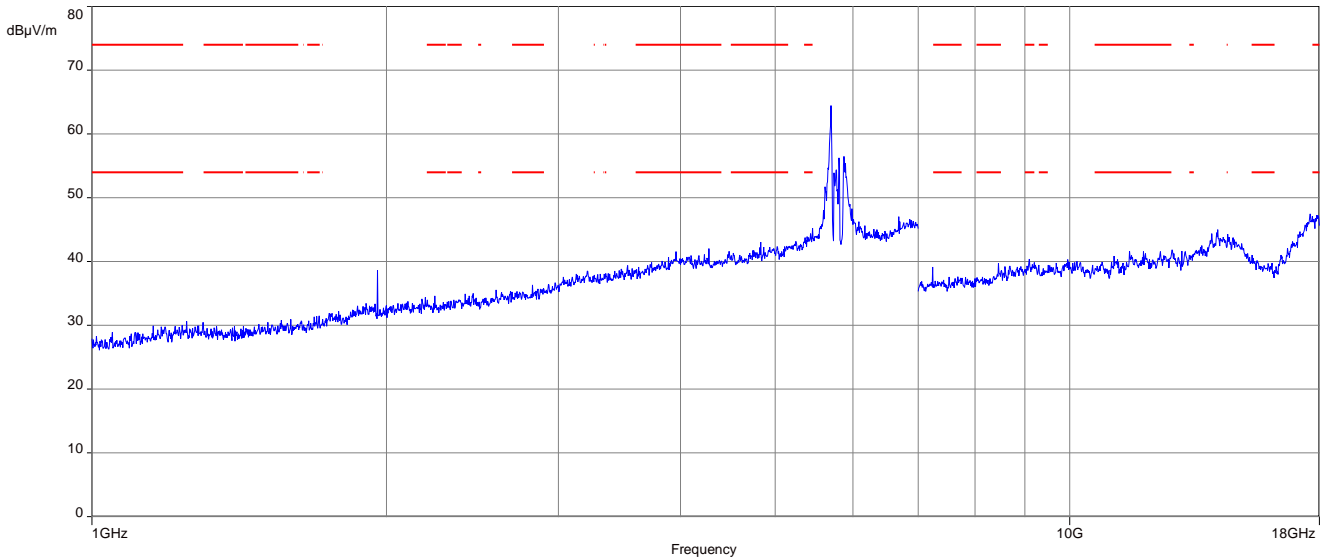

**Plot 6:** 18 GHz to 26 GHz; vertical & horizontal polarization; all channels

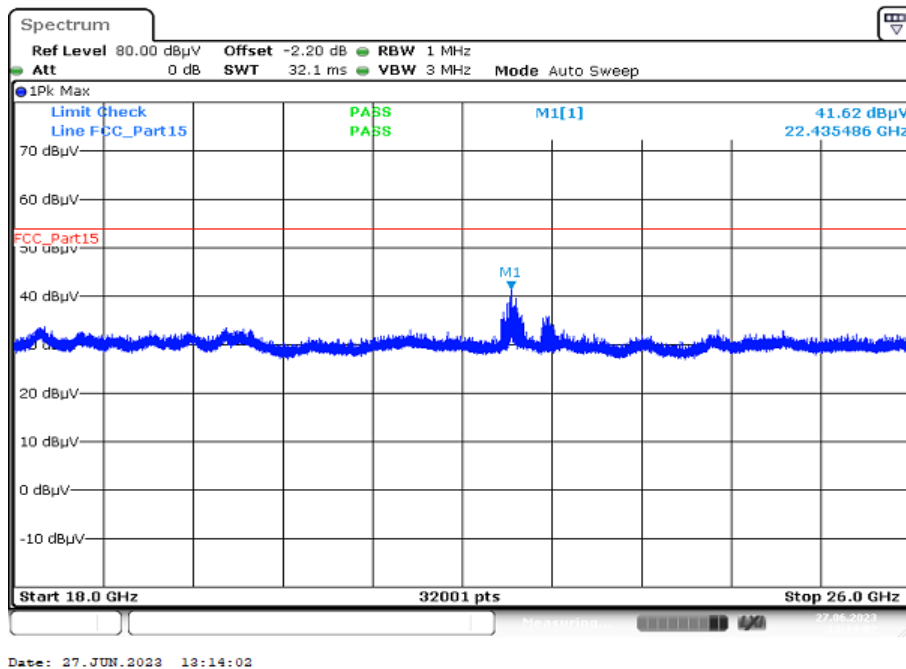

Plot 7: 26 GHz to 40 GHz; vertical & horizontal polarization; all channels

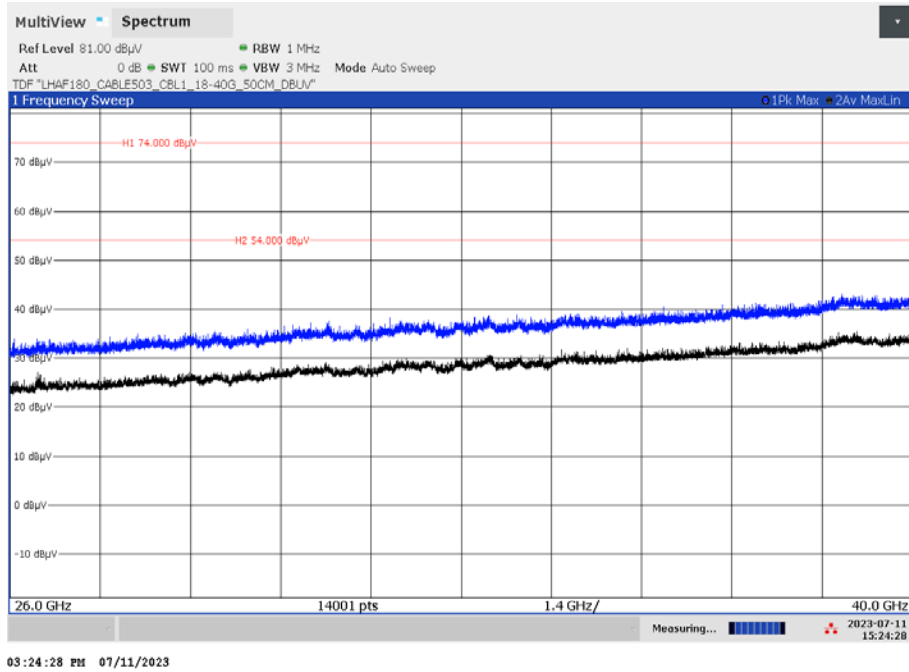

## 12.14 Spurious emissions conducted < 30 MHz

Description:

Measurement of the conducted spurious emissions in transmit mode below 30 MHz. The EUT is set to middle channel. If critical peaks are found the lowest channel and the highest channel will be measured too. Both power lines, phase and neutral line, are measured. Found peaks are re-measured with average and quasi peak detection to show compliance to the limits.

Measurement:

| Measurement parameter    |                             |
|--------------------------|-----------------------------|
| Detector:                | Peak - Quasi Peak / Average |
| Sweep time:              | Auto                        |
| Video bandwidth:         | 9 kHz                       |
| Resolution bandwidth:    | 100 kHz                     |
| Span:                    | 150 kHz to 30 MHz           |
| Trace mode:              | Max Hold                    |
| Test setup:              | See sub clause 6.4 – A      |
| Measurement uncertainty: | See chapter 9               |

Limits:

| Spurious Emissions Conducted < 30 MHz |                     |                  |
|---------------------------------------|---------------------|------------------|
| Frequency (MHz)                       | Quasi-Peak (dBµV/m) | Average (dBµV/m) |
| 0.15 – 0.5                            | 66 to 56*           | 56 to 46*        |
| 0.5 – 5                               | 56                  | 46               |
| 5 – 30.0                              | 60                  | 50               |

\*Decreases with the logarithm of the frequency

Results:

| Spurious Emissions Conducted < 30 MHz [dBµV/m]              |          |                |
|---|----------|----------------|
| F [MHz]   | Detector | Level [dBµV/m] |
| All detected emissions are more than 20 dB below the limit. |          |                |
|   |          |                |

**Plots:**

**Plot 1:** 150 kHz to 30 MHz, phase line

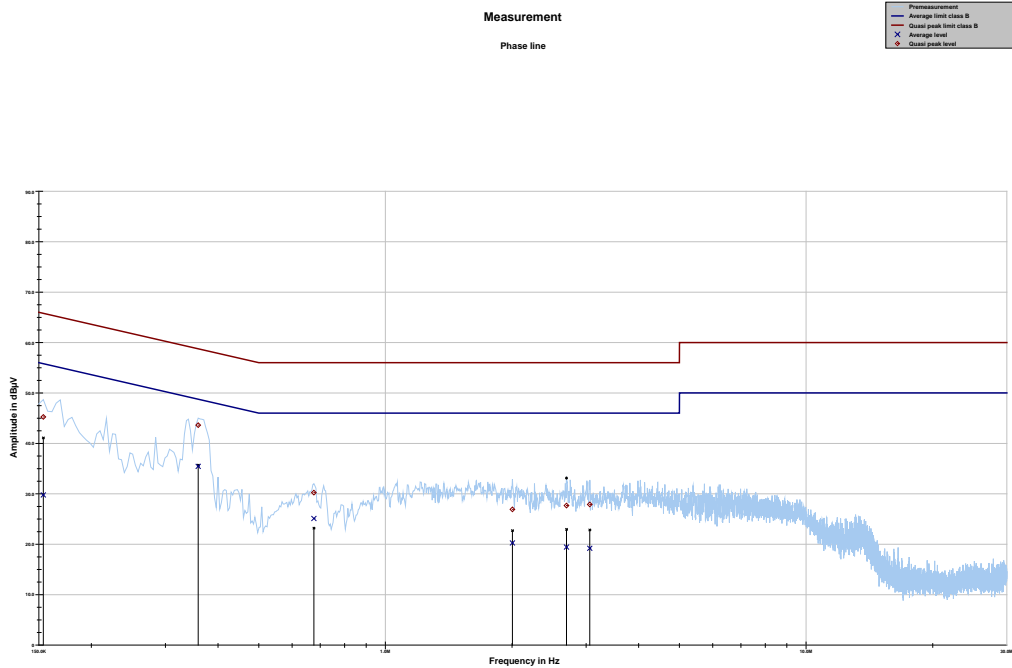

Project ID: 0061401T004

| Frequency | Quasi peak level | Margin quasi peak | Limit QP | Average level | Margin average | Limit AV |
|-----------|------------------|-------------------|----------|---------------|----------------|----------|
| MHz       | dBµV             | dB                | dBµV     | dBµV          | dB             | dBµV     |
| 0.153731  | 45.25            | 20.55             | 65.796   | 29.78         | 26.12          | 55.893   |
| 0.358950  | 43.62            | 15.13             | 58.753   | 35.44         | 14.59          | 50.030   |
| 0.676106  | 30.23            | 25.77             | 56.000   | 25.10         | 20.90          | 46.000   |
| 2.004431  | 26.91            | 29.09             | 56.000   | 20.25         | 25.75          | 46.000   |
| 2.694713  | 27.67            | 28.33             | 56.000   | 19.43         | 26.57          | 46.000   |
| 3.060375  | 27.89            | 28.11             | 56.000   | 19.20         | 26.80          | 46.000   |

Plot 2: 150 kHz to 30 MHz, neutral line

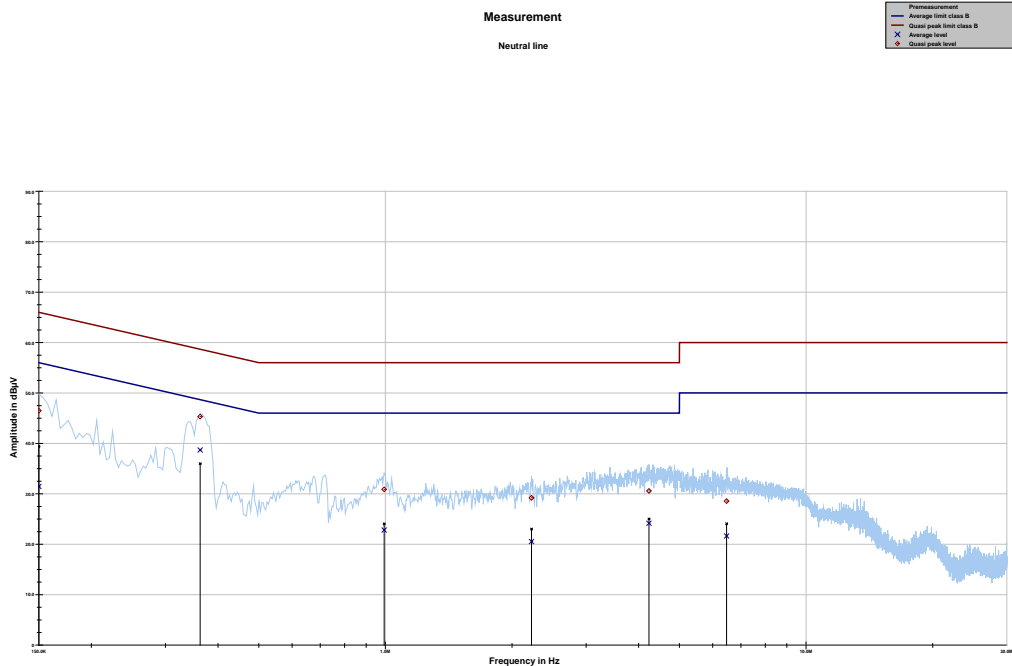

Project ID: 0061401T004

| Frequency<br>MHz | Quasi peak<br>level<br>dBµV | Margin quasi<br>peak<br>dB | Limit QP<br>dBµV | Average level<br>dBµV | Margin<br>average<br>dB | Limit AV<br>dBµV |
|------------------|-----------------------------|----------------------------|------------------|-----------------------|-------------------------|------------------|
| 0.153731         | 45.25                       | 20.55                      | 65.796           | 29.78                 | 26.12                   | 55.893           |
| 0.358950         | 43.62                       | 15.13                      | 58.753           | 35.44                 | 14.59                   | 50.030           |
| 0.676106         | 30.23                       | 25.77                      | 56.000           | 25.10                 | 20.90                   | 46.000           |
| 2.004431         | 26.91                       | 29.09                      | 56.000           | 20.25                 | 25.75                   | 46.000           |
| 2.694713         | 27.67                       | 28.33                      | 56.000           | 19.43                 | 26.57                   | 46.000           |
| 3.060375         | 27.89                       | 28.11                      | 56.000           | 19.20                 | 26.80                   | 46.000           |

## 13 Observations

No observations except those reported with the single test cases have been made.

## 14 Glossary

|                  |  |
|------------------|--|
| <b>EUT</b>       | Equipment under test                       |
| <b>DUT</b>       | Device under test                          |
| <b>UUT</b>       | Unit under test                            |
| <b>GUE</b>       | GNSS User Equipment                        |
| <b>FCC</b>       | Federal Communications Commission          |
| <b>FCC ID</b>    | Company Identifier at FCC                  |
| <b>IC</b>        | Industry Canada                            |
| <b>PMN</b>       | Product marketing name                     |
| <b>HMN</b>       | Host marketing name                        |
| <b>HVIN</b>      | Hardware version identification number     |
| <b>FVIN</b>      | Firmware version identification number     |
| <b>EMC</b>       | Electromagnetic Compatibility              |
| <b>HW</b>        | Hardware                                   |
| <b>SW</b>        | Software                                   |
| <b>Inv. No.</b>  | Inventory number                           |
| <b>S/N or SN</b> | Serial number                              |
| <b>C</b>         | Compliant                                  |
| <b>NC</b>        | Not compliant                              |
| <b>NA</b>        | Not applicable                             |
| <b>NP</b>        | Not performed                              |
| <b>PP</b>        | Positive peak                              |
| <b>QP</b>        | Quasi peak                                 |
| <b>AVG</b>       | Average                                    |
| <b>OC</b>        | Operating channel                          |
| <b>OCW</b>       | Operating channel bandwidth                |
| <b>OBW</b>       | Occupied bandwidth                         |
| <b>OOB</b>       | Out of band                                |
| <b>DFS</b>       | Dynamic frequency selection                |
| <b>CAC</b>       | Channel availability check                 |
| <b>OP</b>        | Occupancy period                           |
| <b>NOP</b>       | Non occupancy period                       |
| <b>DC</b>        | Duty cycle                                 |
| <b>PER</b>       | Packet error rate                          |
| <b>CW</b>        | Clean wave                                 |
| <b>MC</b>        | Modulated carrier                          |
| <b>WLAN</b>      | Wireless local area network                |
| <b>RLAN</b>      | Radio local area network                   |
| <b>DSSS</b>      | Dynamic sequence spread spectrum           |
| <b>OFDM</b>      | Orthogonal frequency division multiplexing |



## 15 Document history

| Version | Applied changes | Date of release |
|---------|-----------------|-----------------|
| -/-     | Initial release | 2023-08-17      |

## 16 Accreditation Certificate – D-PL-12076-01-05

| first page   | last page  |
|--|--|
|  <p>The first page of the accreditation certificate includes the DAKKS logo, the name of the Deutsche Akkreditierungsstelle GmbH, and details of the accreditation for CTC advanced GmbH. It specifies the testing fields as Telecommunication (FCC Requirements) and provides the registration number D-PL-12076-01-05. The page is signed by the Head of Division on 09.06.2020.</p> |  <p>The last page of the accreditation certificate contains contact information for three offices: Berlin, Frankfurt am Main, and Braunschweig. It also includes a disclaimer regarding the publication of extracts and provides information on where to find the up-to-date state of membership, listing websites for EA, ILAC, and IAF.</p> |

**Note: The current certificate annex is published on the websites (link see below).**

<https://www.dakks.de/files/data/as/pdf/D-PL-12076-01-05e.pdf>

or

[https://cetecomadvanced.com/files/pdfs/d-pl-12076-01-05\\_tcb\\_usa.pdf](https://cetecomadvanced.com/files/pdfs/d-pl-12076-01-05_tcb_usa.pdf)

##### END OF TEST REPORT #####