

## TEST REPORT

Test report no.: 1-5761\_23-01-04

BNetzA-CAB-02/21-102

### Testing laboratory

**CTC advanced GmbH**

Untertuerkheimer Strasse 6 – 10

66117 Saarbruecken / Germany

Phone: + 49 681 5 98 - 0

Fax: + 49 681 5 98 - 9075

Internet: <https://www.ctcadvanced.com>

e-mail: [mail@ctcadvanced.com](mailto:mail@ctcadvanced.com)

**Accredited Testing Laboratory:**

The testing laboratory (area of testing) is accredited according to DIN EN ISO/IEC 17025 (2018-03) by the Deutsche Akkreditierungsstelle GmbH (DAkkS)

The accreditation is valid for the scope of testing procedures as stated in the accreditation certificate starting with the registration number: D-PL-12076-01.

### Applicant

**SAGEMCOM BROADBAND SAS**

250, route de l' Empereur

92848 Rueil-Malmaison Cedex / FRANCE

Phone: -/-

Contact: Benjamin Murindangabo

e-mail: [benjamin.murindangabo-ext@sagemcom.com](mailto:benjamin.murindangabo-ext@sagemcom.com)

### Manufacturer

**SAGEMCOM BROADBAND SAS**

250, route de l' Empereur

92848 Rueil-Malmaison Cedex / FRANCE

### Test standard/s

FCC - Title 47 CFR Part 15      FCC - Title 47 of the Code of Federal Regulations; Chapter I; Part 15 - Radio frequency devices

For further applied test standards please refer to section 3 of this test report.

### Test Item

**Kind of test item:** Video Soundbox  
**Model name:** VSB3918 ALT US  
**FCC ID:** VW3VSB3918  
**Frequency:** 2400 MHz to 2483.5 MHz  
**Technology tested:** WLAN  
**Antenna:** 2 integrated dual-band antennas  
**Power supply:** 115 V AC by mains adapter  
**Temperature range:** 0°C to +40°C

This test report is electronically signed and valid without handwritten signature. For verification of the electronic signatures, the public keys can be requested at the testing laboratory.

### Test report authorized:

Michael Dorongovski  
Lab Manager  
Radio Labs

### Test performed:

Marco Bertolino  
Supervisor Radio Services  
Radio Labs

## 1 Table of contents

|       |  |    |
|-------|--|----|
| 1     | Table of contents.....   | 2  |
| 2     | General information.....   | 4  |
| 2.1   | Notes and disclaimer .....   | 4  |
| 2.2   | Application details .....  | 4  |
| 2.3   | Test laboratories sub-contracted .....                                 | 4  |
| 3     | Test standard/s, references and accreditations .....                   | 5  |
| 4     | Reporting statements of conformity – decision rule .....               | 6  |
| 5     | Test environment.....  | 7  |
| 6     | Test item .....  | 7  |
| 6.1   | General description .....  | 7  |
| 6.2   | Additional information .....   | 7  |
| 7     | Description of the test setup.....                                     | 8  |
| 7.1   | Shielded semi anechoic chamber .....                                   | 9  |
| 7.2   | Shielded fully anechoic chamber.....                                   | 10 |
| 7.3   | Radiated measurements > 18 GHz .....                                   | 11 |
| 7.4   | AC conducted.....  | 12 |
| 7.5   | Conducted measurements with peak power meter & spectrum analyzer ..... | 13 |
| 8     | Sequence of testing.....   | 14 |
| 8.1   | Sequence of testing radiated spurious 9 kHz to 30 MHz .....            | 14 |
| 8.2   | Sequence of testing radiated spurious 30 MHz to 1 GHz.....             | 15 |
| 8.3   | Sequence of testing radiated spurious 1 GHz to 18 GHz.....             | 16 |
| 8.4   | Sequence of testing radiated spurious above 18 GHz.....                | 17 |
| 9     | Measurement uncertainty.....   | 18 |
| 10    | Summary of measurement results .....                                   | 19 |
| 11    | Additional information and comments .....                              | 20 |
| 12    | Additional EUT parameter .....   | 21 |
| 13    | Measurement results .....  | 22 |
| 13.1  | Antenna gain .....   | 22 |
| 13.2  | Identify worst case data rate.....                                     | 23 |
| 13.3  | Maximum output power.....  | 24 |
| 13.4  | Duty cycle.....  | 26 |
| 13.5  | Peak power spectral density .....                                      | 27 |
| 13.6  | 6 dB DTS bandwidth .....   | 29 |
| 13.7  | Occupied bandwidth – 99% emission bandwidth .....                      | 31 |
| 13.8  | Occupied bandwidth – 20 dB bandwidth.....                              | 33 |
| 13.9  | Band edge compliance radiated .....                                    | 35 |
| 13.10 | Spurious emissions conducted.....                                      | 42 |
| 13.11 | Spurious emissions radiated below 30 MHz .....                         | 49 |
| 13.12 | Spurious emissions radiated 30 MHz to 1 GHz .....                      | 54 |
| 13.13 | Spurious emissions radiated above 1 GHz.....                           | 57 |

|       |   |    |
|-------|---|----|
| 13.14 | Spurious emissions conducted below 30 MHz (AC conducted)..... | 63 |
| 14    | Observations.....   | 66 |
| 15    | Glossary.....   | 66 |
| 16    | Document history.....   | 67 |
| 17    | Accreditation Certificate – D-PL-12076-01-05 .....            | 67 |

## 2 General information

### 2.1 Notes and disclaimer

The test results of this test report relate exclusively to the test item specified in this test report. CTC advanced GmbH does not assume responsibility for any conclusions and generalizations drawn from the test results with regard to other specimens or samples of the type of the equipment represented by the test item.

The test report may only be reproduced or published in full. Reproduction or publication of extracts from the report requires the prior written approval of CTC advanced GmbH.

The testing service provided by CTC advanced GmbH has been rendered under the current "General Terms and Conditions for CTC advanced GmbH".

CTC advanced GmbH will not be liable for any loss or damage resulting from false, inaccurate, inappropriate or incomplete product information provided by the customer.

Under no circumstances does the CTC advanced GmbH test report include any endorsement or warranty regarding the functionality, quality or performance of any other product or service provided.

Under no circumstances does the CTC advanced GmbH test report include or imply any product or service warranties from CTC advanced GmbH, including, without limitation, any implied warranties of merchantability, fitness for purpose, or non-infringement, all of which are expressly disclaimed by CTC advanced GmbH.

All rights and remedies regarding vendor's products and services for which CTC advanced GmbH has prepared this test report shall be provided by the party offering such products or services and not by CTC advanced GmbH.

In no case this test report can be considered as a Letter of Approval.

This test report is electronically signed and valid without handwritten signature. For verification of the electronic signatures, the public keys can be requested at the testing laboratory.

### 2.2 Application details

|                                    |            |
|------------------------------------|------------|
| Date of receipt of order:          | 2023-01-31 |
| Date of receipt of test item:      | 2023-01-30 |
| Start of test:*                    | 2023-02-06 |
| End of test:*                      | 2023-02-10 |
| Person(s) present during the test: | -/-        |

\*Date of each measurement, if not shown in the plot, can be requested. Dates are stored in the measurement software.

### 2.3 Test laboratories sub-contracted

None

### 3 Test standard/s, references and accreditations

| Test standard              | Date | Description   |
|----------------------------|------|---|
| FCC - Title 47 CFR Part 15 | -/-  | FCC - Title 47 of the Code of Federal Regulations; Chapter I; Part 15 - Radio frequency devices |

| Guidance         | Version | Description  |
|------------------|---------|--|
| KDB 558074 D01   | v05r02  | GUIDANCE FOR COMPLIANCE MEASUREMENTS ON DIGITAL TRANSMISSION SYSTEM, FREQUENCY HOPPING SPREAD SPECTRUM SYSTEM, AND HYBRID SYSTEM DEVICES OPERATING UNDER SECTION 15.247 OF THE FCC RULES |
| ANSI C63.4-2014  | -/-     | American National Standard for Methods of Measurement of Radio-Noise Emissions from Low-Voltage Electrical and Electronic Equipment in the Range of 9 kHz to 40 GHz                      |
| ANSI C63.10-2013 | -/-     | American National Standard of Procedures for Compliance Testing of Unlicensed Wireless Devices   |
| KDB 662911 D01   | v02r01  | Emissions Testing of Transmitters with Multiple Outputs in the Same Band   |

| Accreditation    | Description   |
|------------------|---|
| D-PL-12076-01-05 | Telecommunication FCC requirements<br><a href="https://www.dakks.de/as/ast/d/D-PL-12076-01-05e.pdf">https://www.dakks.de/as/ast/d/D-PL-12076-01-05e.pdf</a> |



FCC designation number: DE0002

#### 4 Reporting statements of conformity – decision rule

Only the measured values related to their corresponding limits will be used to decide whether the equipment under test meets the requirements of the test standards listed in chapter 3. The measurement uncertainty is mentioned in this test report, see chapter 9, but is not taken into account - neither to the limits nor to the measurement results. Measurement results with a smaller margin to the corresponding limits than the measurement uncertainty have a potential risk of more than 5% that the decision might be wrong."

measured value, measurement uncertainty, verdict

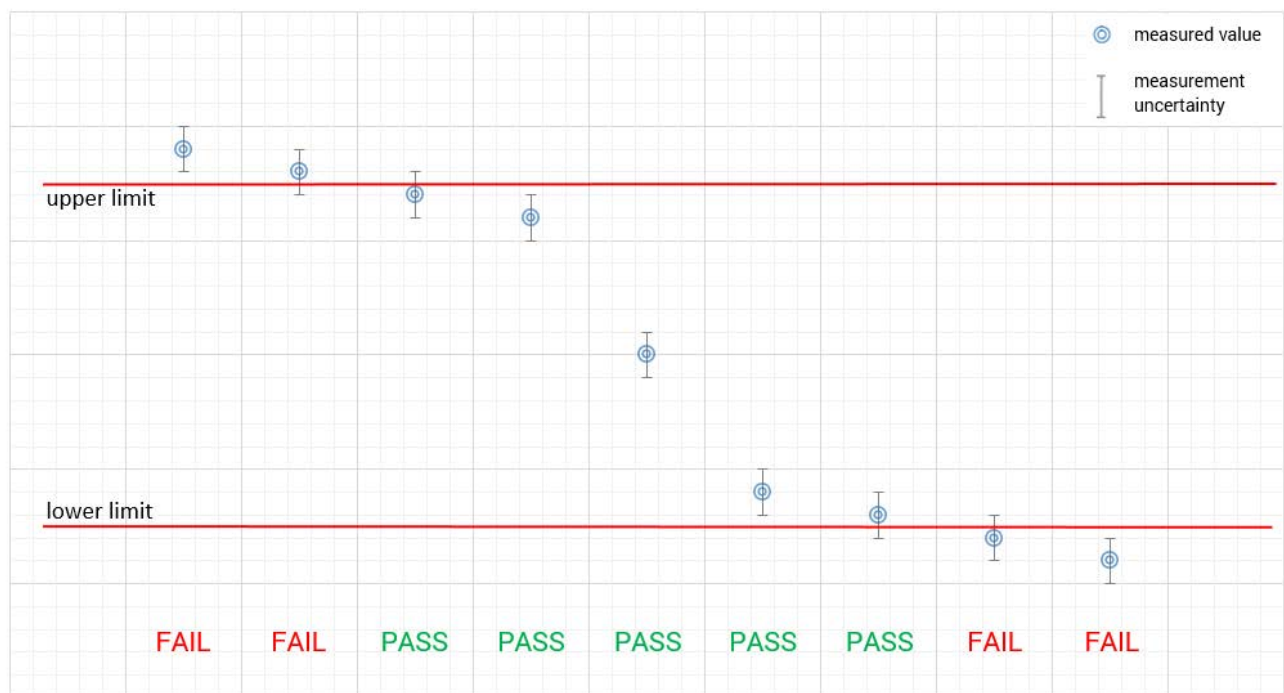

## 5 Test environment

|                           |   |                                     |  |
|---------------------------|---|-------------------------------------|--|
| Temperature               | : | $T_{nom}$<br>$T_{max}$<br>$T_{min}$ | +22 °C during room temperature tests<br>No tests under extreme conditions performed.<br>No tests under extreme conditions performed. |
| Relative humidity content | : |                                     | 42 %   |
| Barometric pressure       | : |                                     | 1016 hpa   |
| Power supply              | : | $V_{nom}$<br>$V_{max}$<br>$V_{min}$ | 115 V AC by mains adapter<br>No tests under extreme conditions performed.<br>No tests under extreme conditions performed.            |

## 6 Test item

### 6.1 General description

|                            |   |   |              |
|----------------------------|---|---|--------------|
| Kind of test item          | : | Video Soundbox                            |              |
| Model name                 | : | VSB3918 ALT US                            |              |
| S/N serial number          | : | Radiated unit:                            | Prototype    |
|                            |   | Conducted unit:                           | 622432194559 |
| Hardware status            | : | M393 AL VSB-3                             |              |
| Software status            | : | N/A                                       |              |
| Firmware status            | : | N/A                                       |              |
| Frequency band             | : | 2400 MHz to 2483.5 MHz                    |              |
| Type of radio transmission | : | DSSS, OFDM                                |              |
| Use of frequency spectrum  | : |   |              |
| Type of modulation         | : | CCK, (D)BPSK, (D)QPSK, 16 – QAM, 64 – QAM |              |
| Number of channels         | : | 11  |              |
| Antenna                    | : | 2 integrated dual-band antennas           |              |
| Power supply               | : | 115 V AC by mains adapter                 |              |
| Temperature range          | : | 0°C to +40°C                              |              |

### 6.2 Additional information

The content of the following annexes is defined in the QA. It may be that not all of the listed annexes are necessary for this report, thus some values in between may be missing.

Test setup and EUT photos are included in test report:

- 1-5761/23-01-01\_AnnexA
- 1-5761/23-01-01\_AnnexB
- 1-5761/23-01-01\_AnnexD

## 7 Description of the test setup

Typically, the calibrations of the test apparatus are commissioned to and performed by an accredited calibration laboratory. The calibration intervals are determined in accordance with the DIN EN ISO/IEC 17025. In addition to the external calibrations, the laboratory executes comparison measurements with other calibrated test systems or effective verifications. Weekly chamber inspections and range calibrations are performed. Where possible, RF generating and signaling equipment as well as measuring receivers and analyzers are connected to an external high-precision 10 MHz reference (GPS-based or rubidium frequency standard).

In order to simplify the identification of the equipment used at some special tests, some items of test equipment and ancillaries can be provided with an identifier or number in the equipment list below (Lab/Item).

Each block diagram listed can contain several test setup configurations. All devices belonging to a test setup are identified with the same letter syntax. For example: Column Setup and all devices with an A.

### **Agenda:** Kind of Calibration

|      |  |     |  |
|------|--|-----|--|
| k    | calibration / calibrated                   | EK  | limited calibration                                  |
| ne   | not required (k, ev, izw, zw not required) | zw  | cyclical maintenance (external cyclical maintenance) |
| ev   | periodic self verification                 | izw | internal cyclical maintenance                        |
| Ve   | long-term stability recognized             | g   | blocked for accredited testing                       |
| vlk! | Attention: extended calibration interval   |     |  |
| NK!  | Attention: not calibrated                  | *)  | next calibration ordered / currently in progress     |



## 7.1 Shielded semi anechoic chamber

The radiated measurements are performed in vertical and horizontal plane in the frequency range from 30 MHz to 1 GHz in semi-anechoic chambers. The EUT is positioned on a non-conductive support with a height of 0.80 m above a conductive ground plane that covers the whole chamber. The receiving antennas are conform to specifications ANSI C63. These antennas can be moved over the height range between 1.0 m and 4.0 m in order to search for maximum field strength emitted from EUT. The measurement distances between EUT and receiving antennas are indicated in the test setups for the various frequency ranges. For each measurement, the EUT is rotated in all three axes until the maximum field strength is received. The wanted and unwanted emissions are received by spectrum analyzers where the detector modes and resolution bandwidths over various frequency ranges are set according to requirement ANSI C63.

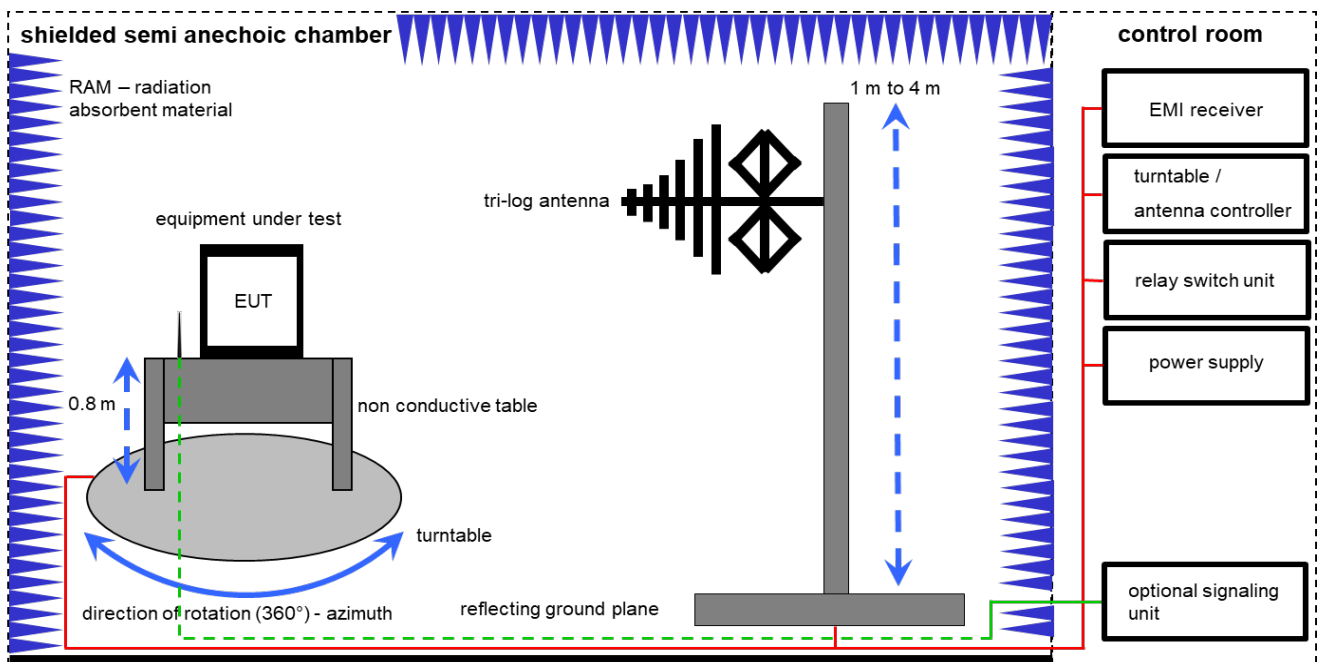

Measurement distance: tri-log antenna 10 meter; EMC32 software version: 10.59.00

$$FS = UR + CL + AF$$

(FS-field strength; UR-voltage at the receiver; CL-loss of the cable; AF-antenna factor)

**Example calculation:**

$$FS [dB\mu V/m] = 12.35 [dB\mu V/m] + 1.90 [dB] + 16.80 [dB/m] = 31.05 [dB\mu V/m] (35.69 \mu V/m)$$

**Equipment table:**

| No. | Setup | Equipment   | Type         | Manufacturer                  | Serial No.      | INV. No.  | Kind of Calibration | Last Calibration | Next Calibration |
|-----|-------|---|--------------|-------------------------------|-----------------|-----------|---------------------|------------------|------------------|
| 1   | A     | Switch-Unit                                       | 3488A        | HP                            | 2719A14505      | 300000368 | ev                  | -/-              | -/-              |
| 2   | A     | Semi anechoic chamber                             | 3000023      | MWB AG                        | -/-             | 300000551 | ne                  | -/-              | -/-              |
| 3   | A     | Analyzer-Reference-System (Harmonics and Flicker) | ARS 16/1     | SPS                           | A3509 07/0 0205 | 300003314 | vIK!                | 29.12.2021       | 31.12.2023       |
| 4   | A     | Antenna Tower                                     | Model 2175   | ETS-Lindgren                  | 64762           | 300003745 | izw                 | -/-              | -/-              |
| 5   | A     | Positioning Controller                            | Model 2090   | ETS-Lindgren                  | 64672           | 300003746 | izw                 | -/-              | -/-              |
| 6   | A     | Turntable Interface-Box                           | Model 105637 | ETS-Lindgren                  | 44583           | 300003747 | izw                 | -/-              | -/-              |
| 7   | A     | TRILOG Broadband Test-Antenna 30 MHz - 3 GHz      | VULB9163     | Schwarzbeck Mess - Elektronik | 318             | 300003696 | vIK!                | 30.09.2021       | 29.09.2023       |
| 8   | A     | Turntable   | 2089-4.0     | EMCO                          | -/-             | 300004394 | ne                  | -/-              | -/-              |
| 9   | A     | PC  | Tecline      | F+W                           | -/-             | 300004388 | ne                  | -/-              | -/-              |
| 10  | A     | EMI Test Receiver                                 | ESR3         | Rohde & Schwarz               | 102587          | 300005771 | k                   | 09.12.2022       | 31.12.2023       |

## 7.2 Shielded fully anechoic chamber

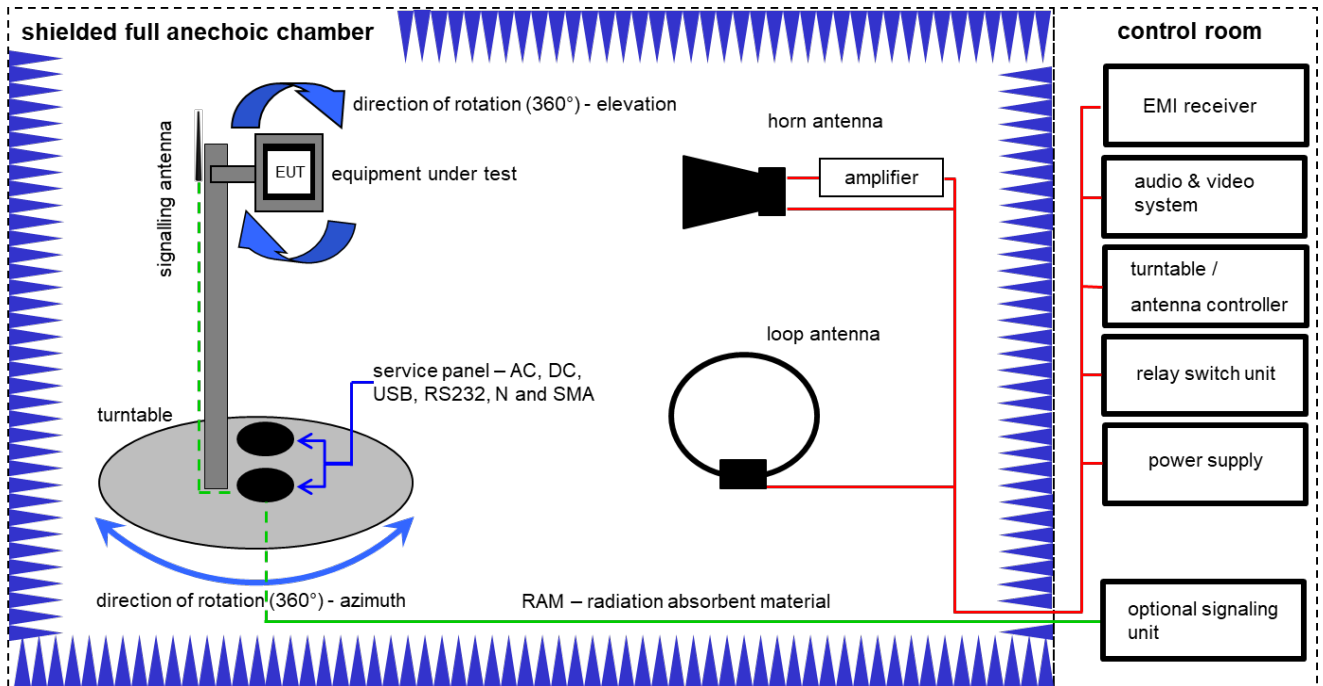

Measurement distance: horn antenna 3 meter; loop antenna 3 meter / 1 meter

FS = UR + CA + AF

(FS-field strength; UR-voltage at the receiver; CA-loss of the signal path; AF-antenna factor)

Example calculation:

FS [dB $\mu$ V/m] = 40.0 [dB $\mu$ V/m] + (-35.8) [dB] + 32.9 [dB/m] = 37.1 [dB $\mu$ V/m] (71.61  $\mu$ V/m)

### Equipment table:

| No. | Setup   | Equipment                                      | Type                                  | Manufacturer         | Serial No.      | INV. No.  | Kind of Calibration | Last Calibration | Next Calibration |
|-----|---------|--|---------------------------------------|----------------------|-----------------|-----------|---------------------|------------------|------------------|
| 1   | B       | Active Loop Antenna 9 kHz to 30 MHz            | 6502                                  | EMCO                 | 2210            | 300001015 | vKI!                | 01.07.2021       | 31.07.2023       |
| 2   | A, C    | Double-Ridged Waveguide Horn Antenna 1-18.0GHz | 3115                                  | EMCO                 | 9107-3696       | 300001604 | vKI!                | 12.03.2021       | 11.03.2023       |
| 3   | C       | Highpass Filter                                | WHK1.1/15G-10SS                       | Wainwright           | 37              | 400000148 | ne                  | -/-              | -/-              |
| 4   | C       | Highpass Filter                                | WHKX7.0/18G-8SS                       | Wainwright           | 18              | 300003789 | ne                  | -/-              | -/-              |
| 5   | C       | Band Reject Filter                             | WRCG2400/2483-2375/2505-50/10SS       | Wainwright           | 26              | 300003792 | ne                  | -/-              | -/-              |
| 6   | C       | Broadband Amplifier 0.5-18 GHz                 | CBLU5184540                           | CERNEX               | 22051           | 300004483 | ev                  | -/-              | -/-              |
| 7   | A, B, C | 4U RF Switch Platform                          | L4491A                                | Agilent Technologies | MY50000032      | 300004510 | ne                  | -/-              | -/-              |
| 8   | A, B, C | Computer                                       | Intel Core i3 3220/3,3 GHz, Prozessor | -/-                  | 2V2403033A54 21 | 300004591 | ne                  | -/-              | -/-              |
| 9   | A, B, C | NEXIO EMV-Software                             | BAT EMC V2022.0.22.0                  | Nexio                | -/-             | 300004682 | ne                  | -/-              | -/-              |
| 10  | A, B, C | Anechoic chamber                               | -/-                                   | TDK                  | -/-             | 300003726 | ne                  | -/-              | -/-              |
| 11  | A, B, C | EMI Test Receiver 9kHz-26,5GHz                 | ESR26                                 | Rohde & Schwarz      | 101376          | 300005063 | k                   | 13.12.2022       | 31.12.2023       |
| 12  | C       | RF-Amplifier                                   | AMF-6F06001800-30-10P-R               | NARDA-MITEQ Inc      | 2011571         | 300005240 | ev                  | -/-              | -/-              |

### 7.3 Radiated measurements > 18 GHz

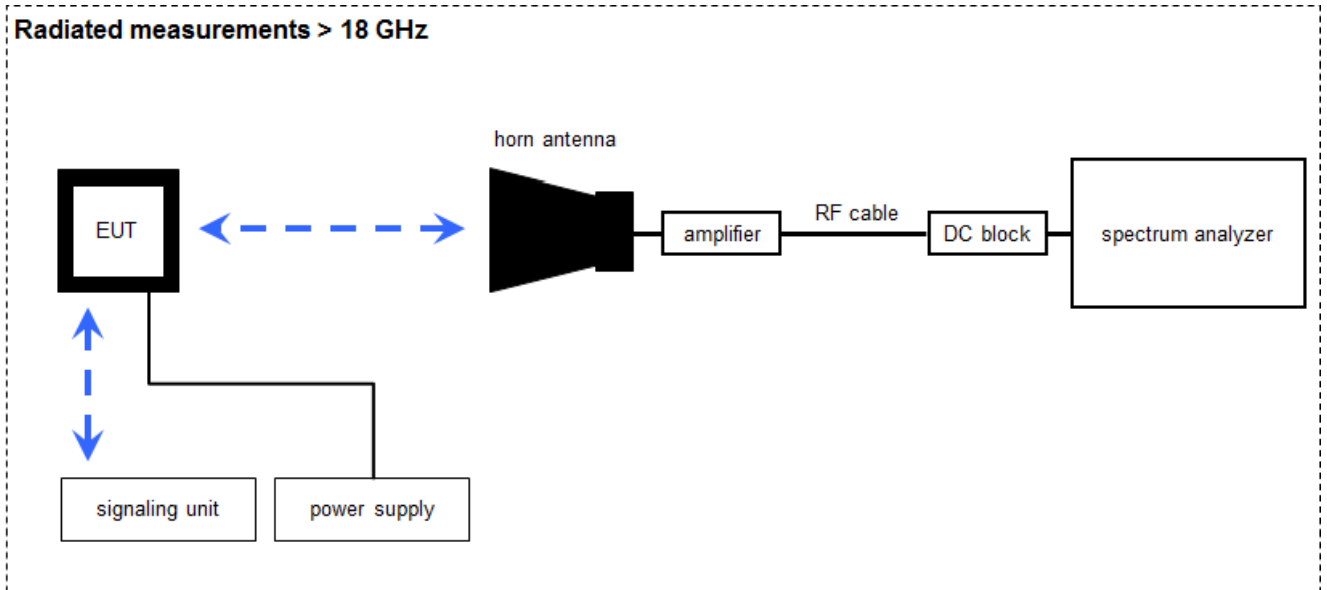

Measurement distance: horn antenna 50 cm

$$FS = UR + CA + AF$$

(FS-field strength; UR-voltage at the receiver; CA-loss signal path & distance correction; AF-antenna factor)

Example calculation:

$$FS [dB\mu V/m] = 40.0 [dB\mu V/m] + (-60.1) [dB] + 36.74 [dB/m] = 16.64 [dB\mu V/m] (6.79 \mu V/m)$$

**Equipment table:**

| No. | Setup | Equipment                                | Type              | Manufacturer   | Serial No.       | INV. No.  | Kind of Calibration | Last Calibration | Next Calibration |
|-----|-------|--|-------------------|----------------|------------------|-----------|---------------------|------------------|------------------|
| 1   | A     | Microwave System Amplifier, 0.5-26.5 GHz | 83017A            | HP             | 00419            | 300002268 | ev                  | -/-              | -/-              |
| 2   | A     | Std. Gain Horn Antenna 18.0-26.5 GHz     | 638               | Narda          | 01096            | 300000486 | vKI!                | 17.01.2022       | 31.01.2024       |
| 3   | A     | Signal analyzer                          | FSV40             | Rohde&Schwarz  | 101042           | 300004517 | k                   | 12.12.2022       | 31.12.2023       |
| 4   | A     | RF-Cable                                 | ST18/SMAM/SMAM/48 | Huber & Suhner | Batch no. 600918 | 400001182 | ev                  | -/-              | -/-              |
| 5   | A     | DC-Blocker 0.1-40 GHz                    | 8141A             | Inmet          | -/-              | 400001185 | ev                  | -/-              | -/-              |

## 7.4 AC conducted

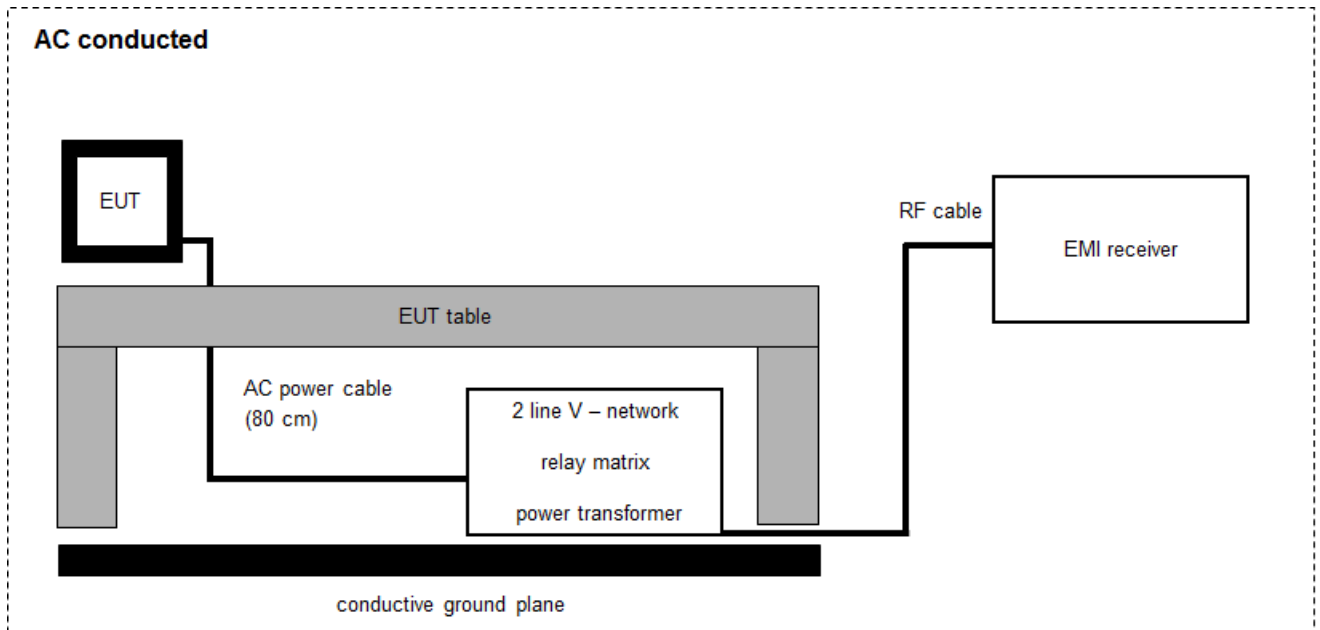

$$FS = UR + CF + VC$$

(FS-field strength; UR-voltage at the receiver; CR-loss of the cable and filter; VC-correction factor of the ISN)

Example calculation:

$$FS [dB\mu V/m] = 37.62 [dB\mu V/m] + 9.90 [dB] + 0.23 [dB] = 47.75 [dB\mu V/m] (244.06 \mu V/m)$$

**Equipment table:**

| No. | Setup | Equipment                                 | Type    | Manufacturer    | Serial No. | INV. No.  | Kind of Calibration | Last Calibration | Next Calibration |
|-----|-------|---|---------|-----------------|------------|-----------|---------------------|------------------|------------------|
| 1   | A     | Two-line V-Network (LISN) 9 kHz to 30 MHz | ESH3-Z5 | Rohde & Schwarz | 892475/017 | 300002209 | vIK!                | 14.12.2021       | 31.12.2023       |
| 2   | A     | RF-Filter-section                         | 85420E  | HP              | 3427A00162 | 300002214 | NK!                 | -/-              | -/-              |
| 3   | A     | Hochpass 150 kHz                          | EZ-25   | R&S             | 100010     | 300003798 | ev                  | -/-              | -/-              |
| 4   | A     | PC  | TecLine | F+W             | -/-        | 300003532 | ne                  | -/-              | -/-              |
| 5   | A     | EMI Test Receiver 3.6 GHz                 | ESR3    | Rohde & Schwarz | 102981     | 300006318 | k                   | 09.12.2022       | 31.12.2023       |

## 7.5 Conducted measurements with peak power meter & spectrum analyzer

### Conducted measurements normal conditions

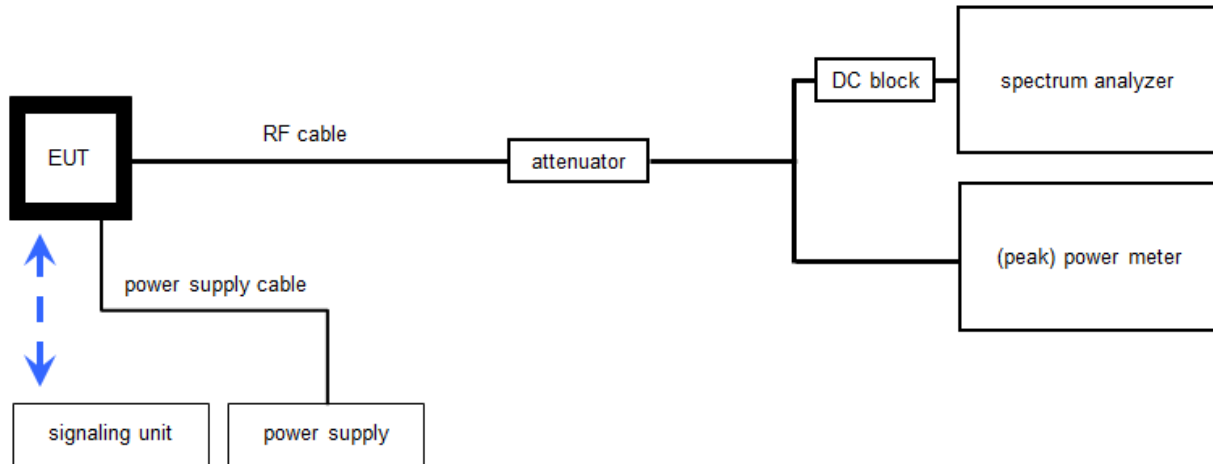

WLAN tester version: 1.1.13; LabView2015

OP = AV + CA  
 (OP-output power; AV-analyzer value; CA-loss signal path)

Example calculation:

OP [dBm] = 6.0 [dBm] + 11.7 [dB] = 17.7 [dBm] (58.88 mW)

**Equipment table:**

| No. | Setup | Equipment   | Type                                  | Manufacturer      | Serial No.       | INV. No.  | Kind of Calibration | Last Calibration | Next Calibration |
|-----|-------|---|---------------------------------------|-------------------|------------------|-----------|---------------------|------------------|------------------|
| 1   | A, B  | Isolating Transformer                                 | RT5A                                  | Grundig           | 12780            | 300001166 | ev                  | -/-              | -/-              |
| 2   | A     | Signal analyzer                                       | FSV40                                 | Rohde&Schwarz     | 101042           | 300004517 | k                   | 12.12.2022       | 31.12.2023       |
| 3   | A, B  | PC Tester R005  | Intel Core i3 3220/3,3 GHz, Prozessor | -/-               | 2V2403033A45 23  | 300004589 | ne                  | -/-              | -/-              |
| 4   | A, B  | RF-Cable  | ST18/SMAm/SMAm /60                    | Huber & Suhner    | Batch no. 606844 | 400001181 | ev                  | -/-              | -/-              |
| 5   | A, B  | DC-Blocker 0.1-40 GHz                                 | 8141A                                 | Inmet             | -/-              | 400001185 | ev                  | -/-              | -/-              |
| 6   | A, B  | Coax Attenuator 10 dB 2W 0-40 GHz                     | MCL BW-K10-2W44+                      | Mini Circuits     | -/-              | 400001186 | ev                  | -/-              | -/-              |
| 7   | A, B  | Tester Software RadioStar (C.BER2 for BT Conformance) | Version 1.0.0.X                       | CTC advanced GmbH | 0001             | 400001380 | ne                  | -/-              | -/-              |
| 8   | B     | USB Wideband Power Sensor (50MHz - 18GHz)             | U2021XA                               | Keysight          | MY591900010      | 300005802 | k                   | 07.12.2022       | 06.12.2023       |

## 8 Sequence of testing

### 8.1 Sequence of testing radiated spurious 9 kHz to 30 MHz

#### Setup

- The equipment is set up to simulate normal operation mode as described in the user manual or defined by the manufacturer.
- If the EUT is a tabletop system, it is placed on a table with 0.8 m height.
- If the EUT is a floor standing device, it is placed directly on the turn table.
- Auxiliary equipment and cables are positioned to simulate normal operation conditions as described in ANSI C 63.4.
- The AC power port of the EUT (if available) is connected to a power outlet below the turntable.
- Measurement distance is 3 m (see ANSI C 63.4) – see test details.
- EUT is set into operation.

#### Premeasurement\*

- The turntable rotates from 0° to 315° using 45° steps.
- The antenna height is 1 m.
- At each turntable position the analyzer sweeps with positive-peak detector to find the maximum of all emissions.

#### Final measurement

- Identified emissions during the pre-measurement are maximized by the software by rotating the turntable from 0° to 360°.
- Loop antenna is rotated about its vertical axis for maximum response at each azimuth about the EUT. (For certain applications, the loop antenna plane may also need to be positioned horizontally at the specified distance from the EUT)
- The final measurement is done in the position (turntable and elevation) causing the highest emissions with quasi-peak (as described in ANSI C 63.4).
- Final levels, frequency, measuring time, bandwidth, turntable position, correction factor, margin to the limit and limit will be recorded. A plot with the graph of the premeasurement and the limit is stored.

\*Note: The sequence will be repeated three times with different EUT orientations.

## 8.2 Sequence of testing radiated spurious 30 MHz to 1 GHz

### Setup

- The equipment is set up to simulate normal operation mode as described in the user manual or defined by the manufacturer.
- If the EUT is a tabletop system, a table with 0.8 m height is used, which is placed on the ground plane.
- If the EUT is a floor standing device, it is placed on the ground plane with insulation between both.
- Auxiliary equipment and cables are positioned to simulate normal operation conditions as described in ANSI C 63.4.
- The AC power port of the EUT (if available) is connected to a power outlet below the turntable.
- Measurement distance is 10 m or 3 m (see ANSI C 63.4) – see test details.
- EUT is set into operation.

### Premeasurement

- The turntable rotates from 0° to 315° using 45° steps.
- The antenna is polarized vertical and horizontal.
- The antenna height changes from 1 m to 3 m.
- At each turntable position, antenna polarization and height the analyzer sweeps three times in peak to find the maximum of all emissions.

### Final measurement

- The final measurement is performed for at least six highest peaks according to the requirements of the ANSI C63.4.
- Based on antenna and turntable positions at which the peak values are measured the software maximize the peaks by changing turntable position  $\pm 45^\circ$  and antenna height between 1 and 4 m.
- The final measurement is done with quasi-peak detector (as described in ANSI C 63.4).
- Final levels, frequency, measuring time, bandwidth, antenna height, antenna polarization, turntable angle, correction factor, margin to the limit and limit are recorded. A plot with the graph of the premeasurement with marked maximum final results and the limit is stored.

### 8.3 Sequence of testing radiated spurious 1 GHz to 18 GHz

#### Setup

- The equipment is set up to simulate normal operation mode as described in the user manual or defined by the manufacturer.
- If the EUT is a tabletop system, a 2-axis positioner with 1.5 m height is used.
- If the EUT is a floor standing device, it is placed directly on the turn table.
- Auxiliary equipment and cables are positioned to simulate normal operation conditions as described in ANSI C 63.4.
- The AC power port of the EUT (if available) is connected to a power outlet below the turntable.
- Measurement distance is 3 m (see ANSI C 63.4) – see test details.
- EUT is set into operation.

#### Premeasurement

- The turntable rotates from 0° to 315° using 45° steps.
- The antenna is polarized vertical and horizontal.
- The antenna height is 1.5 m.
- At each turntable position and antenna polarization the analyzer sweeps with positive peak detector to find the maximum of all emissions.

#### Final measurement

- The final measurement is performed for at least six highest peaks according to the requirements of the ANSI C63.4.
- Based on antenna and turntable positions at which the peak values are measured the software maximizes the peaks by rotating the turntable from 0° to 360°. This measurement is repeated for different EUT-table positions (0° to 150° in 30°-steps) and for both antenna polarizations.
- The final measurement is done in the position (turntable, EUT-table and antenna polarization) causing the highest emissions with Peak and RMS detector (as described in ANSI C 63.4).
- Final levels, frequency, measuring time, bandwidth, turntable position, EUT-table position, antenna polarization, correction factor, margin to the limit and limit are recorded. A plot with the graph of the premeasurement with marked maximum final results and the limit is stored.



## 8.4 Sequence of testing radiated spurious above 18 GHz

### Setup

- The equipment is set up to simulate normal operation mode as described in the user manual or defined by the manufacturer.
- Auxiliary equipment and cables are positioned to simulate normal operation conditions as described in ANSI C 63.4.
- The AC power port of the EUT (if available) is connected to a power outlet.
- The measurement distance is as appropriate (e.g. 0.5 m).
- The EUT is set into operation.

### Premeasurement

- The test antenna is handheld and moved carefully over the EUT to cover the EUT's whole sphere and different polarizations of the antenna.

### Final measurement

- The final measurement is performed at the position and antenna orientation causing the highest emissions with Peak and RMS detector (as described in ANSI C 63.4).
- Final levels, frequency, measuring time, bandwidth, correction factor, margin to the limit and limit are recorded. A plot with the graph of the premeasurement and the limit is stored.

## 9 Measurement uncertainty

| Measurement uncertainty                                  |                                     |           |
|--|-------------------------------------|-----------|
| Test case  | Uncertainty                         |           |
| Antenna gain   | ± 3 dB                              |           |
| Power spectral density                                   | ± 1.56 dB                           |           |
| DTS bandwidth  | ± 100 kHz (depends on the used RBW) |           |
| Occupied bandwidth                                       | ± 100 kHz (depends on the used RBW) |           |
| Maximum output power conducted                           | ± 1.56 dB                           |           |
| Detailed spurious emissions @ the band edge - conducted  | ± 1.56 dB                           |           |
| Band edge compliance radiated                            | ± 3 dB                              |           |
| Spurious emissions conducted                             | > 3.6 GHz                           | ± 1.56 dB |
|  | > 7 GHz                             | ± 1.56 dB |
|  | > 18 GHz                            | ± 2.31 dB |
|  | ≥ 40 GHz                            | ± 2.97 dB |
| Spurious emissions radiated below 30 MHz                 | ± 3 dB                              |           |
| Spurious emissions radiated 30 MHz to 1 GHz              | ± 3 dB                              |           |
| Spurious emissions radiated 1 GHz to 12.75 GHz           | ± 3.7 dB                            |           |
| Spurious emissions radiated above 12.75 GHz              | ± 4.5 dB                            |           |
| Spurious emissions conducted below 30 MHz (AC conducted) | ± 2.6 dB                            |           |

## 10 Summary of measurement results

|                                     |  |
|-------------------------------------|--|
| <input checked="" type="checkbox"/> | No deviations from the technical specifications were ascertained   |
| <input type="checkbox"/>            | There were deviations from the technical specifications ascertained  |
| <input type="checkbox"/>            | This test report is only a partial test report.<br>The content and verdict of the performed test cases are listed below. |

| TC Identifier | Description | Verdict    | Date       | Remark |
|---------------|-------------|------------|------------|--------|
| RF-Testing    | CFR Part 15 | See table! | 2023-03-07 | -/-    |

| Test specification clause                | Test case   | Guideline                            | Temperature & voltage conditions | C                                   | NC                       | NA                       | NP                       | Remark |
|--|---|--------------------------------------|----------------------------------|-------------------------------------|--------------------------|--------------------------|--------------------------|--------|
| §15.247(b)(4)<br>RSS - 247 / 5.4 (f)(ii) | Antenna gain  | -/-                                  | Nominal                          | -/-                                 |                          |                          |                          | -/-    |
| §15.35                                   | Duty cycle  | -/-                                  | Nominal                          | -/-                                 |                          |                          |                          | -/-    |
| §15.247(e)<br>RSS - 247 / 5.2 (b)        | Power spectral density                              | KDB 558074<br>DTS clause: 8.4        | Nominal                          | <input checked="" type="checkbox"/> | <input type="checkbox"/> | <input type="checkbox"/> | <input type="checkbox"/> | -/-    |
| §15.247(a)(2)<br>RSS - 247 / 5.2 (a)     | DTS bandwidth                                       | KDB 558074<br>DTS clause: 8.2        | Nominal                          | <input checked="" type="checkbox"/> | <input type="checkbox"/> | <input type="checkbox"/> | <input type="checkbox"/> | -/-    |
| RSS Gen<br>clause 4.6.1                  | Occupied bandwidth                                  | -/-                                  | Nominal                          | <input checked="" type="checkbox"/> | <input type="checkbox"/> | <input type="checkbox"/> | <input type="checkbox"/> | -/-    |
| §15.247(b)(3)<br>RSS - 247 / 5.4 (d)     | Maximum output power                                | KDB 558074<br>DTS clause:<br>8.3.1.3 | Nominal                          | <input checked="" type="checkbox"/> | <input type="checkbox"/> | <input type="checkbox"/> | <input type="checkbox"/> | -/-    |
| §15.247(d)<br>RSS - 247 / 5.5            | Detailed spurious emissions @ the band edge – cond. | -/-                                  | Nominal                          | <input checked="" type="checkbox"/> | <input type="checkbox"/> | <input type="checkbox"/> | <input type="checkbox"/> | -/-    |
| §15.205<br>RSS - 247 / 5.5<br>RSS - Gen  | Band edge compliance cond. or rad.                  | KDB 558074<br>DTS clause:<br>8.7.3   | Nominal                          | <input checked="" type="checkbox"/> | <input type="checkbox"/> | <input type="checkbox"/> | <input type="checkbox"/> | -/-    |
| §15.247(d)<br>RSS - 247 / 5.5            | TX spurious emissions cond.                         | KDB 558074<br>DTS clause: 8.5        | Nominal                          | <input checked="" type="checkbox"/> | <input type="checkbox"/> | <input type="checkbox"/> | <input type="checkbox"/> | -/-    |
| §15.209(a)<br>RSS-Gen                    | TX spurious emissions rad. below 30 MHz             | -/-                                  | Nominal                          | <input checked="" type="checkbox"/> | <input type="checkbox"/> | <input type="checkbox"/> | <input type="checkbox"/> | -/-    |
| §15.247(d)<br>RSS - 247 / 5.5<br>RSS-Gen | TX spurious emissions rad. 30 MHz to 1 GHz          | -/-                                  | Nominal                          | <input checked="" type="checkbox"/> | <input type="checkbox"/> | <input type="checkbox"/> | <input type="checkbox"/> | -/-    |
| §15.247(d)<br>RSS - 247 / 5.5<br>RSS-Gen | TX spurious emissions rad. above 1 GHz              | -/-                                  | Nominal                          | <input checked="" type="checkbox"/> | <input type="checkbox"/> | <input type="checkbox"/> | <input type="checkbox"/> | -/-    |
| §15.107(a)<br>§15.207                    | Conducted emissions < 30 MHz                        | -/-                                  | Nominal                          | <input checked="" type="checkbox"/> | <input type="checkbox"/> | <input type="checkbox"/> | <input type="checkbox"/> | -/-    |

**Notes:**

|          |           |           |               |           |                |           |               |
|----------|-----------|-----------|---------------|-----------|----------------|-----------|---------------|
| <b>C</b> | Compliant | <b>NC</b> | Not compliant | <b>NA</b> | Not applicable | <b>NP</b> | Not performed |
|----------|-----------|-----------|---------------|-----------|----------------|-----------|---------------|

## 11 Additional information and comments

Reference documents: 22-12-06\_Antenna Drawing VSB3918 ALT US.pptx (Gain)

Co-applicable documents: 1-5761\_23-01-04\_Annex\_MR1 to MR5

Special test descriptions: Power settings:

|                       |    |
|-----------------------|----|
| DSSS / b – mode       | 64 |
| OFDM / g – mode       | 52 |
| OFDM / n HT20 – mode  | 52 |
| OFDM / ac HT20 – mode | 52 |
| OFDM / ax HE20 – mode | 52 |

Configuration descriptions: During radiated tests, both antennas were transmitting simultaneously.

- EUT selection:
- Only one device available
  - Devices selected by the customer
  - Devices selected by the laboratory (Randomly)

Provided channels:

Channels with 20 MHz channel bandwidth:

| channel number & center frequency |             |      |      |      |      |             |      |      |      |      |             |      |      |
|-----------------------------------|-------------|------|------|------|------|-------------|------|------|------|------|-------------|------|------|
| channel                           | 1           | 2    | 3    | 4    | 5    | 6           | 7    | 8    | 9    | 10   | 11          | 12   | 13   |
| f <sub>c</sub> / MHz              | <b>2412</b> | 2417 | 2422 | 2427 | 2432 | <b>2437</b> | 2442 | 2447 | 2452 | 2457 | <b>2462</b> | 2467 | 2472 |

Note: The channels used for the tests are marked in bold in the list.

## 12 Additional EUT parameter

- Test mode:
- No test mode available  
lperf was used to ping another device with the largest support packet size
  - Test mode available  
Special software is used.  
EUT is transmitting pseudo random data by itself
- Modulation types:
- Wide Band Modulation (None Hopping – e.g. DSSS, OFDM)
  - Frequency Hopping Spread Spectrum (FHSS)
- Antennas and transmit operating modes:
- Operating mode 1 (single antenna)
    - Equipment with 1 antenna,
    - Equipment with 2 diversity antennas operating in switched diversity mode by which at any moment in time only 1 antenna is used,
    - Smart antenna system with 2 or more transmit/receive chains, but operating in a mode where only 1 transmit/receive chain is used)
  - Operating mode 2 (multiple antennas, no beamforming)
    - Equipment operating in this mode contains a smart antenna system using two or more transmit/receive chains simultaneously but without beamforming.
  - Operating mode 3 (multiple antennas, with beamforming)
    - Equipment operating in this mode contains a smart antenna system using two or more transmit/receive chains simultaneously with beamforming.  
In addition to the antenna assembly gain (G), the beamforming gain (Y) may have to be taken into account when performing the measurements.

### 13 Measurement results

#### 13.1 Antenna gain

**Limits:**

| FCC   | ISED |
|---|------|
| 6 dBi / > 6 dBi output power and power density reduction required |      |

**Results:** 22-12-06\_Antenna Drawing VSB3918 ALT US.pptx (Gain)

|   | lowest channel | middle channel | highest channel |
|---|----------------|----------------|-----------------|
| Gain [dBi] / Declared<br>Combined antenna gain (ANT0; ANT1) | 4.85           |                |                 |

## 13.2 Identify worst case data rate

### Description:

All modes of the module will be measured with an average power meter or spectrum analyzer to identify the maximum transmission power.

In further tests only the identified worst case modulation scheme or bandwidth will be measured and this mode is used as representative mode for all other modulation schemes.

### Measurement:

| Measurement parameter   |                         |
|-------------------------|-------------------------|
| Detector                | Peak                    |
| Sweep time              | Auto                    |
| Resolution bandwidth    | 3 MHz                   |
| Video bandwidth         | 3 MHz                   |
| Trace mode              | Max hold                |
| Test setup              | See chapter 7.5 setup B |
| Measurement uncertainty | See chapter 9           |

### Results:

| Modulation scheme / bandwidth (declared by the customer) |          |
|--|----------|
| DSSS / b – mode  | 1 Mbit/s |
| OFDM / g – mode  | 6 Mbit/s |
| OFDM / n HT20 – mode                                     | MCS8     |
| OFDM / ac HT20 – mode                                    | MCS0     |
| OFDM / ax HE20 – mode                                    | MCS8     |

### 13.3 Maximum output power

**Description:**

Measurement of the maximum conducted peak output power. The measurements are performed using the data rate identified in the previous chapter.

**Measurement:**

| Measurement parameter            |                                  |
|----------------------------------|----------------------------------|
| According to DTS clause: 8.3.1.3 |                                  |
| Peak power meter                 |                                  |
| External result file(s)          | 1-5761_23-01-04_Annex_MR1 to MR5 |
| Test setup                       | See chapter 7.5 setup B          |
| Measurement uncertainty          | See chapter 9                    |

**Limits:**

| FCC   | ISED |
|---|------|
| Conducted 1.0 W / 30 dBm with an antenna gain of max. 6 dBi |      |



**Results:**

| antenna port 1                               | maximum output power / dBm |                |                 |
|--|----------------------------|----------------|-----------------|
|  | lowest channel             | middle channel | highest channel |
| Output power conducted DSSS / b – mode       | 22.1                       | 21.4           | 21.2            |
| Output power conducted OFDM / g – mode       | 25.9                       | 25.9           | 25.1            |
| Output power conducted OFDM / n HT20 – mode  | 25.6                       | 26.2           | 25.1            |
| Output power conducted OFDM / ac HT20 – mode | 26.2                       | 25.3           | 25.0            |
| Output power conducted OFDM / ax HE20 – mode | 26.2                       | 25.7           | 25.2            |

| antenna port 2                               | maximum output power / dBm |                |                 |
|--|----------------------------|----------------|-----------------|
|  | lowest channel             | middle channel | highest channel |
| Output power conducted DSSS / b – mode       | 21.9                       | 21.4           | 21.2            |
| Output power conducted OFDM / g – mode       | 26.1                       | 25.7           | 25.4            |
| Output power conducted OFDM / n HT20 – mode  | 25.8                       | 25.7           | 25.3            |
| Output power conducted OFDM / ac HT20 – mode | 25.7                       | 24.9           | 25.5            |
| Output power conducted OFDM / ax HE20 – mode | 25.7                       | 25.9           | 25.4            |

| antenna port 1 + 2<br>calculated             | maximum output power / dBm |                |                 |
|--|----------------------------|----------------|-----------------|
|  | lowest channel             | middle channel | highest channel |
| Output power conducted DSSS / b – mode       | 25.0                       | 24.4           | 24.2            |
| Output power conducted OFDM / g – mode       | 29.0                       | 28.8           | 28.3            |
| Output power conducted OFDM / n HT20 – mode  | 28.7                       | 29.0           | 28.2            |
| Output power conducted OFDM / ac HT20 – mode | 29.0                       | 28.1           | 28.3            |
| Output power conducted OFDM / ax HE20 – mode | 29.0                       | 28.8           | 28.3            |

### 13.4 Duty cycle

**Description:**

Measurement of the timing behavior.

**Measurement:**

| Measurement parameter   |                                  |
|-------------------------|----------------------------------|
| Detector                | Peak                             |
| Sweep time              | Depends on the signal see plot   |
| Resolution bandwidth    | 10 MHz                           |
| Video bandwidth         | 10 MHz                           |
| Trace mode              | Max hold                         |
| External result file(s) | 1-5761_23-01-04_Annex_MR1 to MR5 |
| Test setup              | See chapter 7.5 setup A          |
| Measurement uncertainty | See chapter 9                    |

**Limits:**

| FCC            | ISED |
|----------------|------|
| No limitation! |      |

**Results:**

| T <sub>nom</sub>      | V <sub>nom</sub> | lowest channel | middle channel | highest channel |
|-----------------------|------------------|----------------|----------------|-----------------|
| DSSS / b – mode       |                  | 100 % / 0 dB   | 100 % / 0 dB   | 100 % / 0 dB    |
| OFDM / g – mode       |                  | 100 % / 0 dB   | 100 % / 0 dB   | 100 % / 0 dB    |
| OFDM / n HT20 – mode  |                  | 100 % / 0 dB   | 100 % / 0 dB   | 100 % / 0 dB    |
| OFDM / ac HT20 – mode |                  | 100 % / 0 dB   | 100 % / 0 dB   | 100 % / 0 dB    |
| OFDM / ax HE20 – mode |                  | 100 % / 0 dB   | 100 % / 0 dB   | 100 % / 0 dB    |

## 13.5 Peak power spectral density

### Description:

Measurement of the peak power spectral density of a digital modulated system. The PSD shows the strength of the variations as a function of the frequency.

### Measurement:

| Measurement parameter        |  |
|------------------------------|--|
| According to DTS clause: 8.4 |  |
| Detector                     | Positive Peak                              |
| Sweep time                   | Auto                                       |
| Resolution bandwidth         | 100 kHz                                    |
| Video bandwidth              | 300 kHz                                    |
| Span                         | 30 MHz                                     |
| Trace mode                   | Max. hold (allow trace to fully stabilize) |
| External result file(s)      | 1-5761_23-01-04_Annex_MR1 to MR5           |
| Test setup                   | See chapter 7.5 setup A                    |
| Measurement uncertainty      | See chapter 9                              |

### Limits:

| FCC                       | ISED |
|---------------------------|------|
| 8 dBm / 3 kHz (conducted) |      |

**Results:** antenna port 1

| measured              | peak power spectral density / dBm @ 3 kHz |                |                 |
|-----------------------|---|----------------|-----------------|
|                       | Lowest channel                            | Middle channel | Highest channel |
| DSSS / b – mode       | -5.5                                      | -6.2           | -5.7            |
| OFDM / g – mode       | -10.5                                     | -12.0          | -11.4           |
| OFDM / n HT20 – mode  | -11.4                                     | -11.5          | -11.7           |
| OFDM / ac HT20 – mode | -10.9                                     | -12.8          | -11.3           |
| OFDM / ax HE20 – mode | -11.5                                     | -12.1          | -13.0           |

**Results:** antenna port 2

| measured              | peak power spectral density / dBm @ 3 kHz |                |                 |
|-----------------------|---|----------------|-----------------|
|                       | Lowest channel                            | Middle channel | Highest channel |
| DSSS / b – mode       | -5.0                                      | -3.0           | -5.3            |
| OFDM / g – mode       | -10.6                                     | -12.3          | -11.8           |
| OFDM / n HT20 – mode  | -9.6                                      | -13.0          | -11.8           |
| OFDM / ac HT20 – mode | -11.3                                     | -11.4          | -11.8           |
| OFDM / ax HE20 – mode | -11.2                                     | -12.7          | -12.1           |

**Results:** antenna port 1 + 2

| calculated            | peak power spectral density / dBm @ 3 kHz |                |                 |
|-----------------------|---|----------------|-----------------|
|                       | Lowest channel                            | Middle channel | Highest channel |
| DSSS / b – mode       | -2.2                                      | -1.3           | -2.5            |
| OFDM / g – mode       | -7.5                                      | -9.1           | -8.6            |
| OFDM / n HT20 – mode  | -7.4                                      | -9.2           | -8.7            |
| OFDM / ac HT20 – mode | -8.1                                      | -9.0           | -8.5            |
| OFDM / ax HE20 – mode | -8.3                                      | -9.4           | -9.5            |

### 13.6 6 dB DTS bandwidth

#### Description:

Measurement of the 6 dB bandwidth of the modulated signal.

#### Measurement:

| Measurement parameter        |                                  |
|------------------------------|----------------------------------|
| According to DTS clause: 8.2 |                                  |
| Detector                     | Peak                             |
| Sweep time                   | Auto                             |
| Resolution bandwidth         | 100 kHz                          |
| Video bandwidth              | 500 kHz                          |
| Span                         | 30 MHz / 50 MHz                  |
| Trace mode                   | Single count with 200 counts     |
| External result file(s)      | 1-5761_23-01-04_Annex_MR1 to MR5 |
| Test setup                   | See chapter 7.5 setup A          |
| Measurement uncertainty      | See chapter 9                    |

#### Limits:

| FCC   | ISED |
|---|------|
| Systems using digital modulation techniques may operate in the 2400–2483.5 MHz band.<br>The minimum 6 dB bandwidth shall be at least 500 kHz. |      |

**Results:**

| antenna port 1        | 6 dB DTS bandwidth / kHz |                |                 |
|-----------------------|--------------------------|----------------|-----------------|
|                       | lowest channel           | middle channel | highest channel |
| DSSS / b – mode       | 8008                     | 7984           | 7536            |
| OFDM / g – mode       | 16292                    | 16328          | 16296           |
| OFDM / n HT20 – mode  | 17280                    | 17580          | 17516           |
| OFDM / ac HT20 – mode | 17292                    | 17576          | 17296           |
| OFDM / ax HE20 – mode | 18936                    | 18996          | 18860           |

| antenna port 2        | 6 dB DTS bandwidth / kHz |                |                 |
|-----------------------|--------------------------|----------------|-----------------|
|                       | lowest channel           | middle channel | highest channel |
| DSSS / b – mode       | 8000                     | 8008           | 7528            |
| OFDM / g – mode       | 16324                    | 16352          | 16324           |
| OFDM / n HT20 – mode  | 17544                    | 17584          | 17564           |
| OFDM / ac HT20 – mode | 17544                    | 17580          | 17544           |
| OFDM / ax HE20 – mode | 18888                    | 18952          | 18856           |

### 13.7 Occupied bandwidth – 99% emission bandwidth

**Description:**

Measurement of the 99% bandwidth of the modulated signal acc. RSS-GEN.

**Measurement:**

| Measurement parameter   |   |
|-------------------------|---|
| Detector                | Peak  |
| Sweep time              | Auto  |
| Resolution bandwidth    | 300 kHz   |
| Video bandwidth         | 1 MHz   |
| Span                    | 30 MHz / 50 MHz   |
| Measurement procedure   | Measurement of the 99% bandwidth using the integration function of the analyzer |
| Trace mode              | Single count with 200 counts  |
| External result file(s) | 1-5761_23-01-04_Annex_MR1 to MR5  |
| Test setup              | See chapter 7.5 setup A   |
| Measurement uncertainty | See chapter 9   |

**Usage:**

|  |      |
|--|------|
| -/-                                      | ISED |
| OBW is necessary for Emission Designator |      |

**Results:**

| antenna port 1        | 99% emission bandwidth / kHz |                |                 |
|-----------------------|------------------------------|----------------|-----------------|
|                       | lowest channel               | middle channel | highest channel |
| DSSS / b – mode       | 11631                        | 11575          | 11559           |
| OFDM / g – mode       | 17438                        | 17678          | 17470           |
| OFDM / n HT20 – mode  | 18406                        | 18618          | 18422           |
| OFDM / ac HT20 – mode | 18442                        | 18618          | 18430           |
| OFDM / ax HE20 – mode | 19082                        | 19246          | 19110           |

| antenna port 2        | 99% emission bandwidth / kHz |                |                 |
|-----------------------|------------------------------|----------------|-----------------|
|                       | lowest channel               | middle channel | highest channel |
| DSSS / b – mode       | 11739                        | 11739          | 11747           |
| OFDM / g – mode       | 17150                        | 17346          | 17130           |
| OFDM / n HT20 – mode  | 18002                        | 18202          | 18014           |
| OFDM / ac HT20 – mode | 17998                        | 18178          | 18002           |
| OFDM / ax HE20 – mode | 19074                        | 19198          | 19078           |



### 13.8 Occupied bandwidth – 20 dB bandwidth

**Description:**

Measurement of the 20 dB bandwidth of the modulated carrier.

**Measurement:**

| Measurement parameter   |                                   |
|-------------------------|-----------------------------------|
| Detector                | Peak                              |
| Sweep time              | Auto                              |
| Resolution bandwidth    | 100 kHz                           |
| Video bandwidth         | 500 kHz                           |
| Span                    | 30 MHz / 50 MHz                   |
| Trace mode              | Single count with min. 200 counts |
| External result file(s) | 1-5761_23-01-04_Annex_MR1 to MR5  |
| Test setup              | See chapter 7.5 setup A           |
| Measurement uncertainty | See chapter 9                     |

**Usage:**

| FCC  | ISED |
|--|------|
| The complete bandwidth has to be within the frequency range of the band. |      |

**Results:**

| antenna port 1        | 20 dB bandwidth / MHz |                |                 |
|-----------------------|-----------------------|----------------|-----------------|
|                       | lowest channel        | middle channel | highest channel |
| DSSS / b – mode       | 13416                 | 13400          | 13392           |
| OFDM / g – mode       | 20440                 | 20812          | 20452           |
| OFDM / n HT20 – mode  | 20908                 | 21196          | 20932           |
| OFDM / ac HT20 – mode | 21024                 | 21280          | 21024           |
| OFDM / ax HE20 – mode | 20876                 | 21296          | 21116           |

| antenna port 2        | 20 dB bandwidth / MHz |                |                 |
|-----------------------|-----------------------|----------------|-----------------|
|                       | lowest channel        | middle channel | highest channel |
| DSSS / b – mode       | 13444                 | 13444          | 13448           |
| OFDM / g – mode       | 20192                 | 20232          | 20240           |
| OFDM / n HT20 – mode  | 20480                 | 20748          | 20316           |
| OFDM / ac HT20 – mode | 20228                 | 20736          | 20280           |
| OFDM / ax HE20 – mode | 20784                 | 21092          | 20788           |

### 13.9 Band edge compliance radiated

#### Description:

Measurement of the radiated band edge compliance. The EUT is turned in the position that results in the maximum level at the band edge. Then a sweep over the corresponding restricted band is performed. The EUT is set to the lowest channel for the lower restricted band and to the highest channel for the upper restricted band. Measurement distance is 3 meter.

#### Measurement:

|                         | Measurement parameter for peak measurements | Measurement parameter for average measurements                                    |
|-------------------------|---|---|
|                         |   | According to DTS clause: 8.7.3  |
| Detector                | Peak  | RMS   |
| Sweep time              | Auto  | Auto  |
| Resolution bandwidth    | 1 MHz                                       | 100 kHz   |
| Video bandwidth         | 3 MHz                                       | 300 kHz   |
| Span                    | See plot                                    | 2 MHz   |
| Trace mode              | Max. hold                                   | RMS Average over 101 sweeps   |
| Analyzer function       | -/-   | Band power function<br>(Compute the power by integrating the spectrum over 1 MHz) |
| Test setup              | See chapter 7.2 setup A                     |   |
| Measurement uncertainty | See chapter 9                               |   |

#### Limits:

| FCC   | ISED |
|---|------|
| 74 dB $\mu$ V/m @ 3 m (Peak)<br>54 dB $\mu$ V/m @ 3 m (AVG) |      |

**Results:**

| band edge compliance radiated / (dB $\mu$ V / m) @ 3 m |                           |                           |                           |
|--|---------------------------|---------------------------|---------------------------|
|  | DSSS / b – mode           | OFDM / g – mode           | OFDM / n HT20 – mode      |
| Lower band edge  | 70.8 (Peak)<br>43.8 (AVG) | 69.9 (Peak)<br>53.9 (AVG) | 72.6 (Peak)<br>53.7 (AVG) |
| Upper band edge  | 65.5 (Peak)<br>44.1 (AVG) | 68.8 (Peak)<br>53.9 (AVG) | 72.2 (Peak)<br>53.3 (AVG) |
|  | OFDM / ac HT20 – mode     | OFDM / ax HE20 – mode     | -/-                       |
| Lower band edge  | 71.1 (Peak)<br>52.9 (AVG) | 72.6 (Peak)<br>53.3 (AVG) | -/-                       |
| Upper band edge  | 71.6 (Peak)<br>53.0 (AVG) | 73.4 (Peak)<br>53.0 (AVG) | -/-                       |

**Plots:** DSSS / b – mode - peak / average

**Plot 1:** TX mode, lower band edge, vertical & horizontal polarization

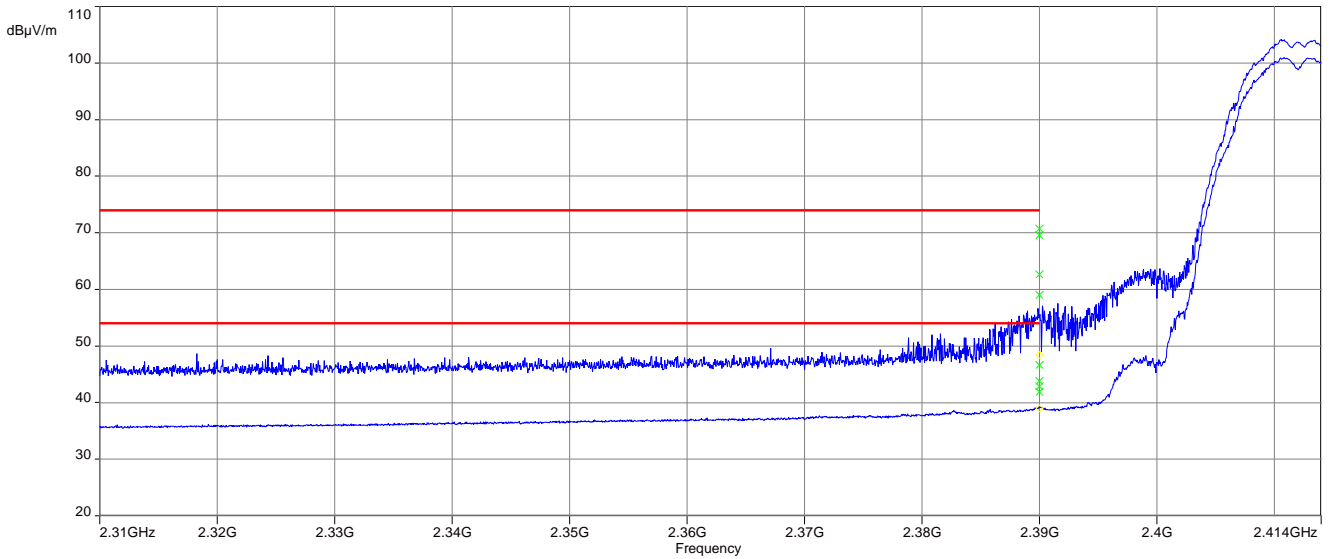

**Plot 2:** TX mode, upper band edge, vertical & horizontal polarization

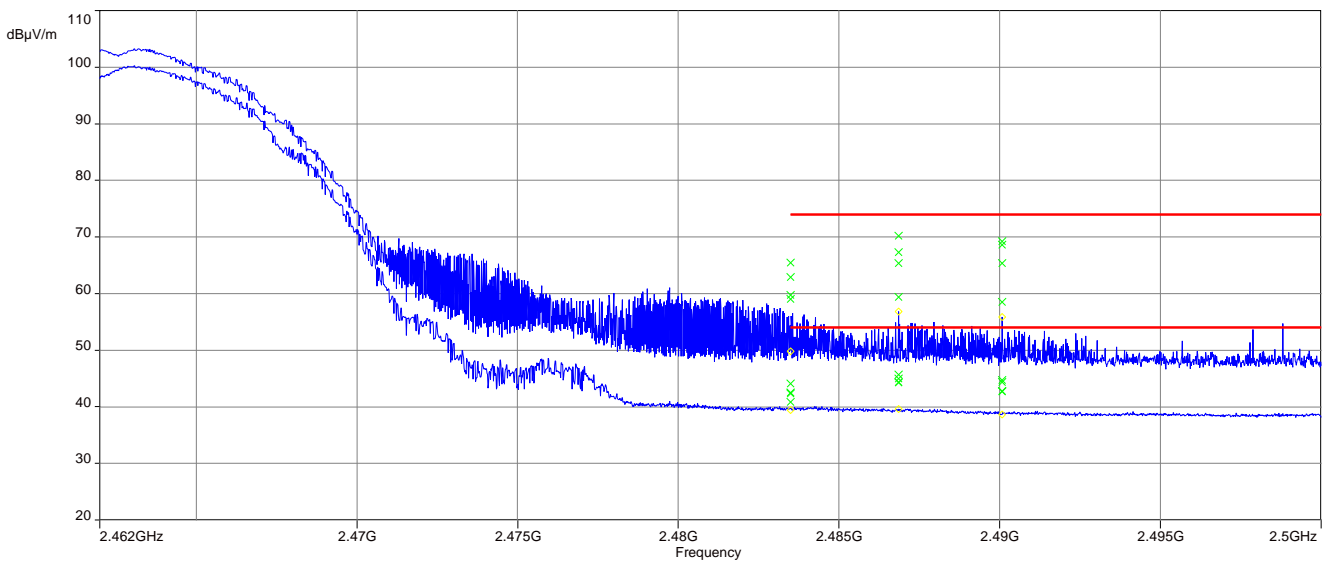

**Plots:** OFDM / g – mode - peak / average

**Plot 1:** TX mode, lower band edge, vertical & horizontal polarization

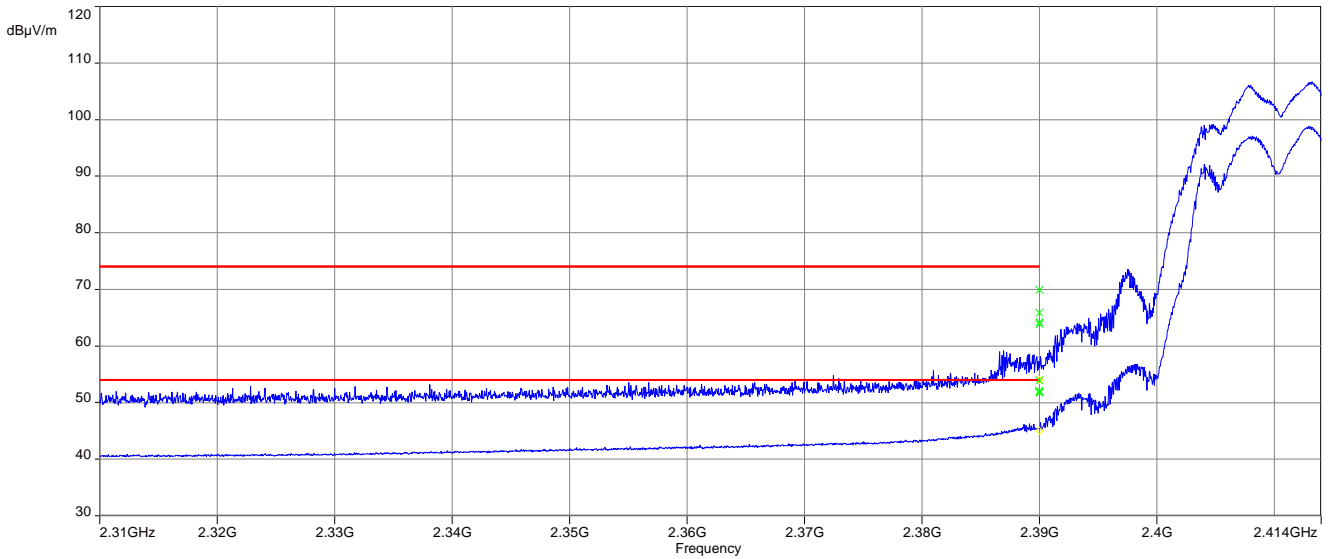

**Plot 2:** TX mode, upper band edge, vertical & horizontal polarization

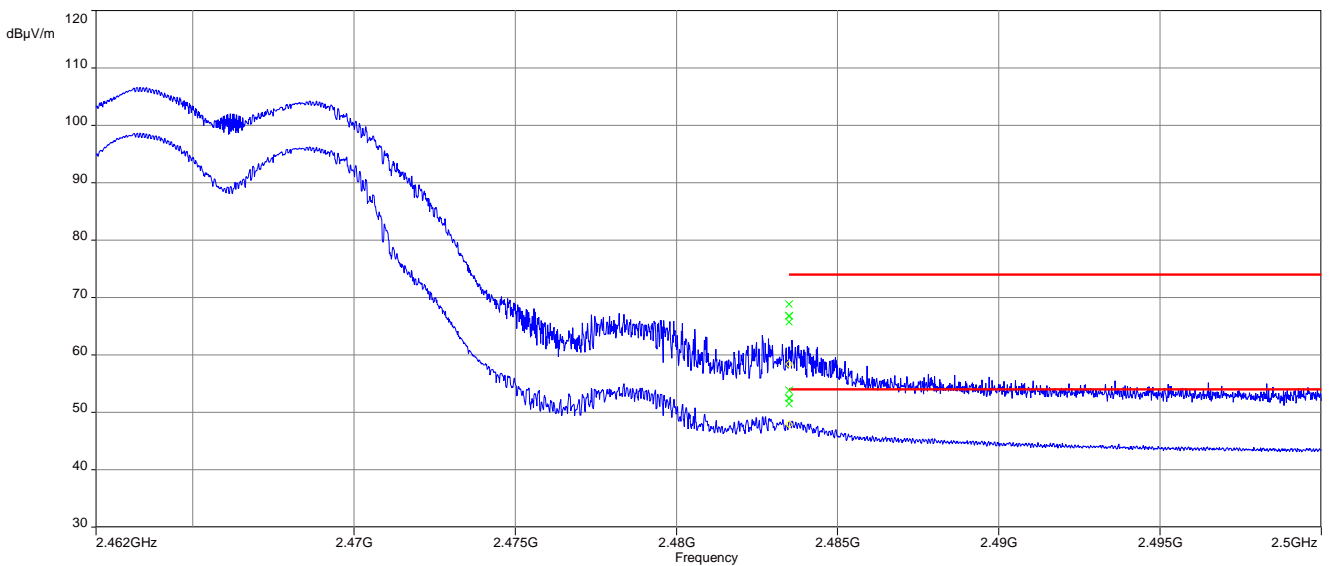

**Plots:** OFDM / n HT20 – mode - peak / average

**Plot 1:** TX mode, lower band edge, vertical & horizontal polarization

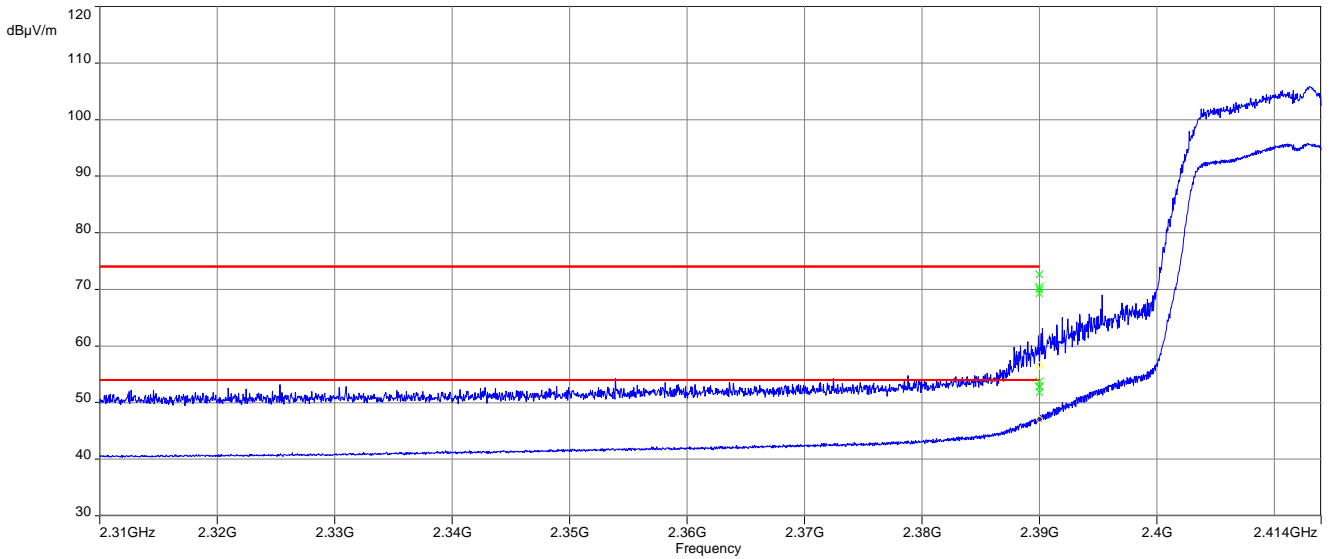

**Plot 2:** TX mode, upper band edge, vertical & horizontal polarization

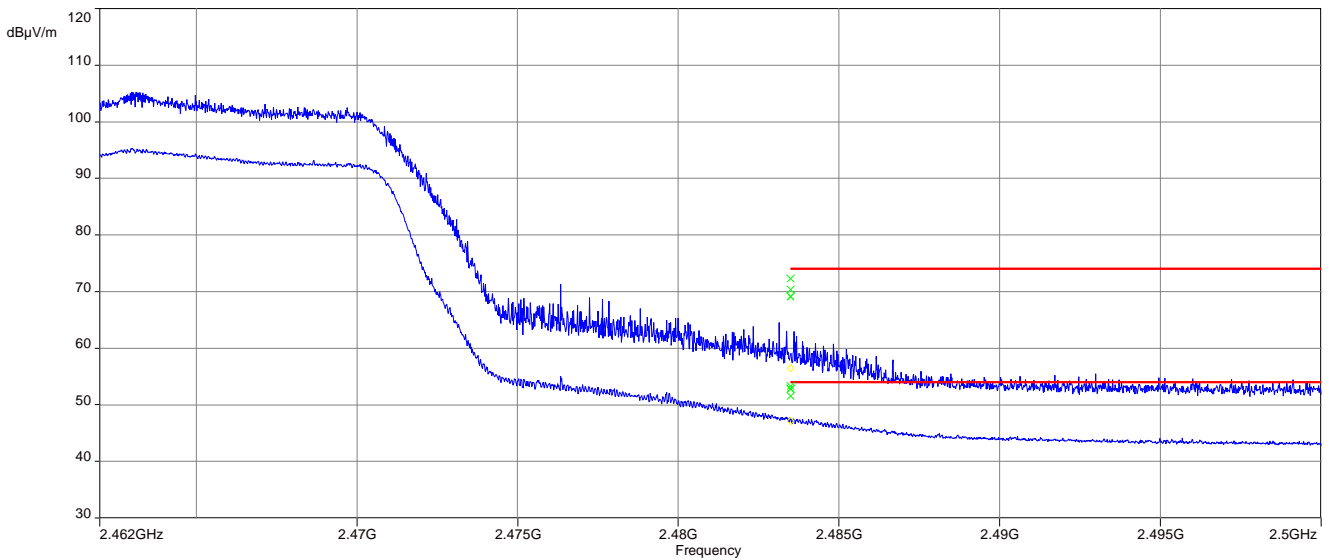

**Plots:** OFDM / ac HT20 – mode - peak / average

**Plot 1:** TX mode, lower band edge, vertical & horizontal polarization

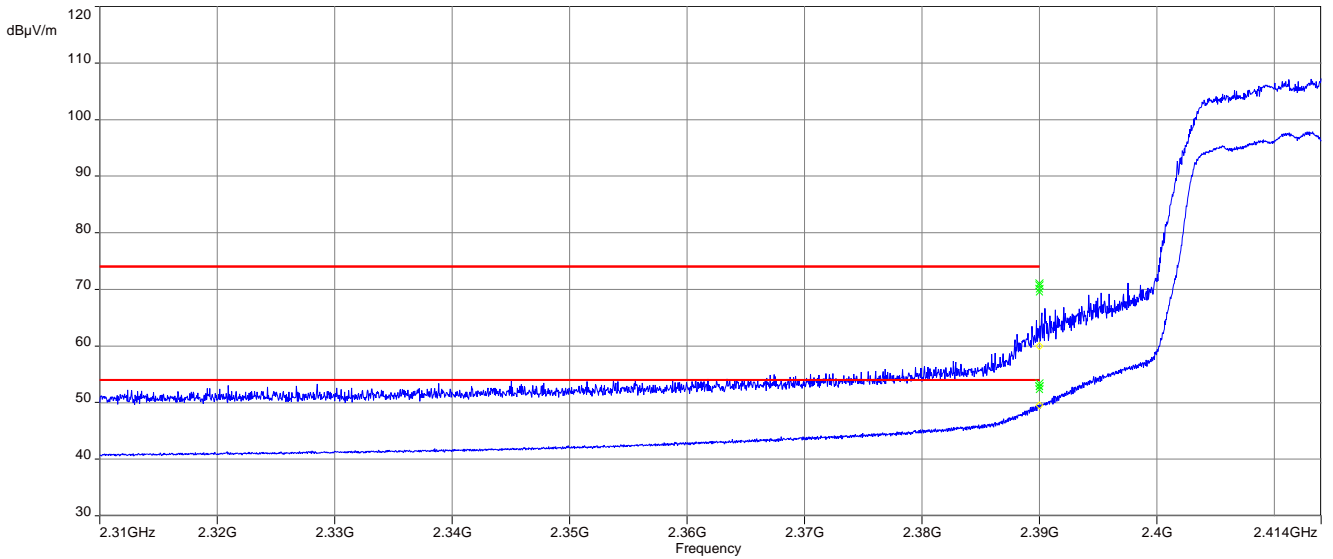

**Plot 2:** TX mode, upper band edge, vertical & horizontal polarization

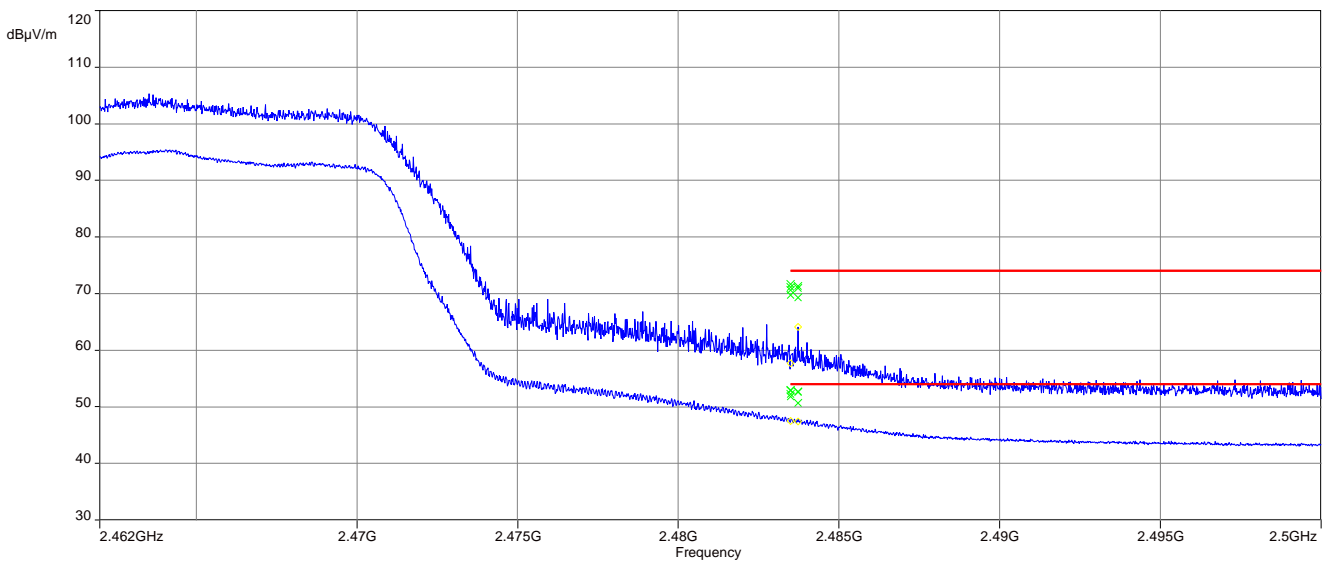



**Plots:** OFDM / ax HE20 – mode - peak / average

**Plot 1:** TX mode, lower band edge, vertical & horizontal polarization

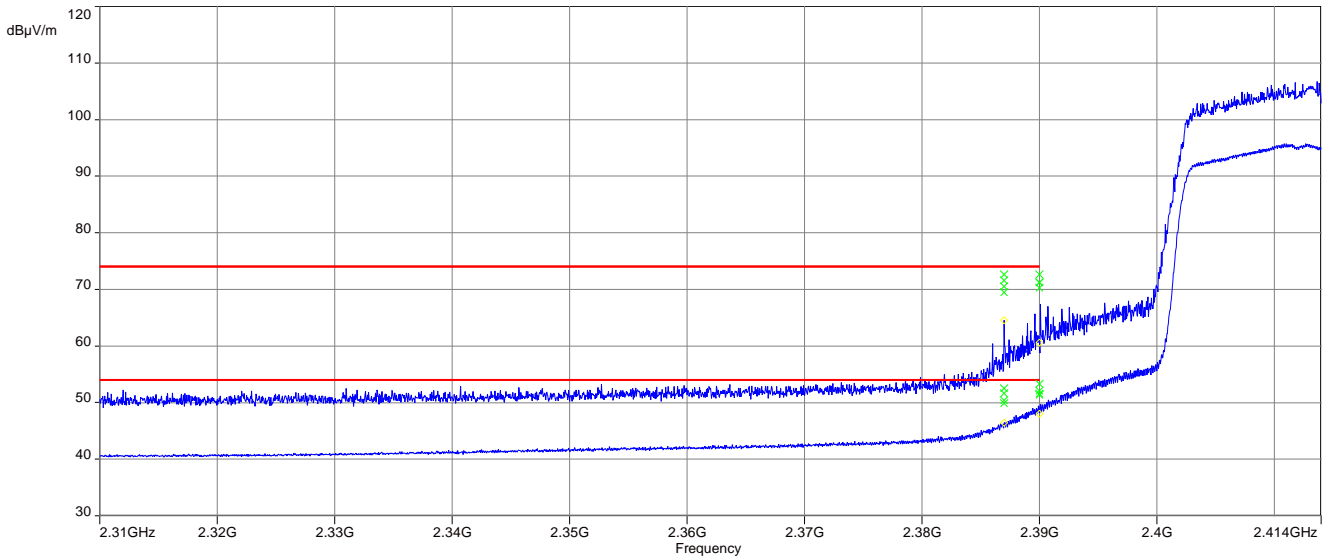

**Plot 2:** TX mode, upper band edge, vertical & horizontal polarization

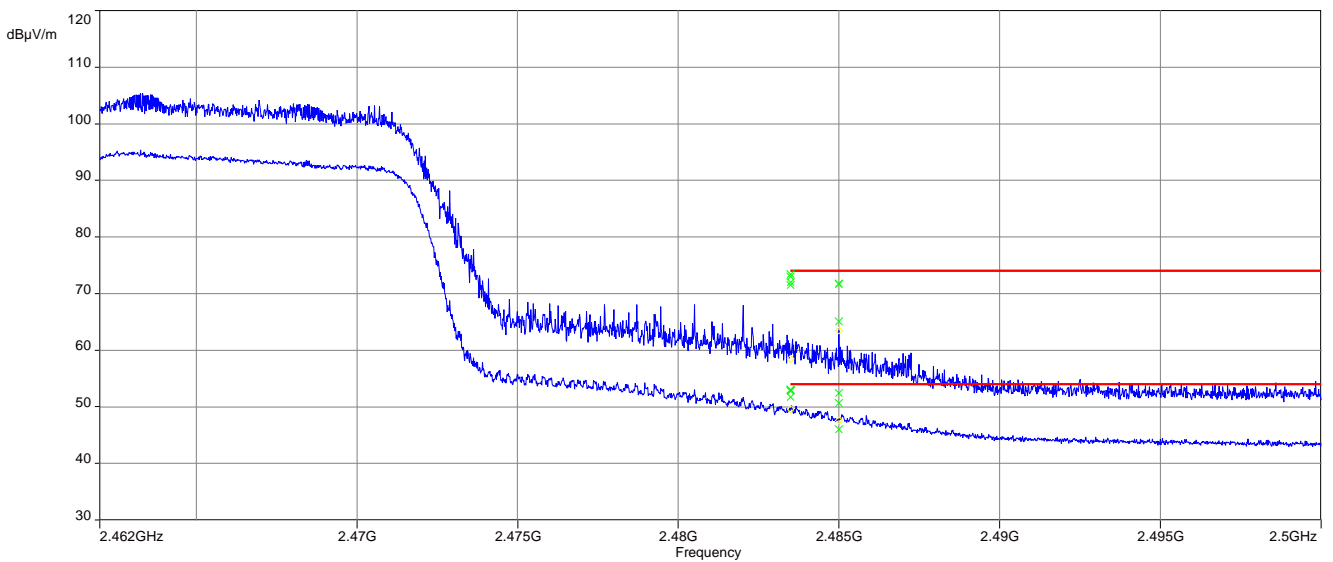

### 13.10 Spurious emissions conducted

**Description:**

Measurement of the conducted spurious emissions in transmit mode. The measurement is performed at the lowest; the middle and the highest channel.

**Measurement:**

| Measurement parameter   |                                  |
|-------------------------|----------------------------------|
| Detector                | Peak                             |
| Sweep time              | Auto                             |
| Resolution bandwidth    | 100 kHz                          |
| Video bandwidth         | 500 kHz                          |
| Span                    | 9 kHz to 25 GHz                  |
| Trace mode              | Max Hold                         |
| External result file(s) | 1-5761_23-01-04_Annex_MR1 to MR5 |
| Test setup              | See chapter 7.5 setup A          |
| Measurement uncertainty | See chapter 9                    |

**Limits:**

| FCC  | ISED |
|--|------|
| In any 100 kHz bandwidth outside the frequency band in which the spread spectrum or digitally modulated intentional radiator is operating, the radio frequency power that is produced by the intentional radiator shall be at least 30 dB below that in the 100 kHz bandwidth within the band that contains the highest level of the desired power, based on either an RF conducted or a radiated measurement. Attenuation below the general limits specified in Section 15.209(a) is not required |      |

**Results:** DSSS / b – mode; antenna port 1

| TX spurious emissions conducted |  |                             |                                   |  |                     |
|---------------------------------|--|-----------------------------|-----------------------------------|--|---------------------|
| f [MHz]                         |  | amplitude of emission [dBm] | limit max. allowed emission power | actual attenuation below frequency of operation [dB] | results             |
| Lowest channel                  |  | 8.4                         | 30 dBm                            |  | Operating frequency |
| No peaks detected               |  |                             | -20 dBc (peak)                    |  | compliant           |
|                                 |  |                             | -30 dBc (average)                 |  |                     |
| Middle channel                  |  | 7.1                         | 30 dBm                            |  | Operating frequency |
| No peaks detected               |  |                             | -20 dBc (peak)                    |  | compliant           |
|                                 |  |                             | -30 dBc (average)                 |  |                     |
| Highest channel                 |  | 7.2                         | 30 dBm                            |  | Operating frequency |
| No peaks detected               |  |                             | -20 dBc (peak)                    |  | compliant           |
|                                 |  |                             | -30 dBc (average)                 |  |                     |

**Results:** OFDM / g – mode; antenna port 1

| TX spurious emissions conducted |  |                             |                                   |  |                     |
|---------------------------------|--|-----------------------------|-----------------------------------|--|---------------------|
| f [MHz]                         |  | amplitude of emission [dBm] | limit max. allowed emission power | actual attenuation below frequency of operation [dB] | results             |
| Lowest channel                  |  | 1.1                         | 30 dBm                            |  | Operating frequency |
| No peaks detected               |  |                             | -20 dBc (peak)                    |  | compliant           |
|                                 |  |                             | -30 dBc (average)                 |  |                     |
| Middle channel                  |  | 1.0                         | 30 dBm                            |  | Operating frequency |
| No peaks detected               |  |                             | -20 dBc (peak)                    |  | compliant           |
|                                 |  |                             | -30 dBc (average)                 |  |                     |
| Highest channel                 |  | 0.9                         | 30 dBm                            |  | Operating frequency |
| No peaks detected               |  |                             | -20 dBc (peak)                    |  | compliant           |
|                                 |  |                             | -30 dBc (average)                 |  |                     |

**Results:** OFDM / n HT20 – mode; antenna port 1

| TX spurious emissions conducted |  |                             |                                     |  |                     |
|---------------------------------|--|-----------------------------|-------------------------------------|--|---------------------|
| f [MHz]                         |  | amplitude of emission [dBm] | limit max. allowed emission power   | actual attenuation below frequency of operation [dB] | results             |
| Lowest channel                  |  | 1.5                         | 30 dBm                              |  | Operating frequency |
| No peaks detected               |  |                             | -20 dBc (peak)<br>-30 dBc (average) |  | compliant           |
|                                 |  |                             |                                     |  |                     |
| Middle channel                  |  | 1.3                         | 30 dBm                              |  | Operating frequency |
| No peaks detected               |  |                             | -20 dBc (peak)<br>-30 dBc (average) |  | compliant           |
|                                 |  |                             |                                     |  |                     |
| Highest channel                 |  | 0.1                         | 30 dBm                              |  | Operating frequency |
| No peaks detected               |  |                             | -20 dBc (peak)<br>-30 dBc (average) |  | compliant           |
|                                 |  |                             |                                     |  |                     |

**Results:** OFDM / ac HT20 –mode; antenna port 1

| TX spurious emissions conducted |  |                             |                                     |  |                     |
|---------------------------------|--|-----------------------------|-------------------------------------|--|---------------------|
| f [MHz]                         |  | amplitude of emission [dBm] | limit max. allowed emission power   | actual attenuation below frequency of operation [dB] | results             |
| Lowest channel                  |  | 1.1                         | 30 dBm                              |  | Operating frequency |
| No peaks detected               |  |                             | -20 dBc (peak)<br>-30 dBc (average) |  | compliant           |
|                                 |  |                             |                                     |  |                     |
| Middle channel                  |  | 0.8                         | 30 dBm                              |  | Operating frequency |
| No peaks detected               |  |                             | -20 dBc (peak)<br>-30 dBc (average) |  | compliant           |
|                                 |  |                             |                                     |  |                     |
| Highest channel                 |  | 0.0                         | 30 dBm                              |  | Operating frequency |
| No peaks detected               |  |                             | -20 dBc (peak)<br>-30 dBc (average) |  | compliant           |
|                                 |  |                             |                                     |  |                     |

**Results:** OFDM / ax HE20 – mode; antenna port 1

| TX spurious emissions conducted |  |                             |                                     |  |                     |
|---------------------------------|--|-----------------------------|-------------------------------------|--|---------------------|
| f [MHz]                         |  | amplitude of emission [dBm] | limit max. allowed emission power   | actual attenuation below frequency of operation [dB] | results             |
| Lowest channel                  |  | 1.5                         | 30 dBm                              |  | Operating frequency |
| No peaks detected               |  |                             | -20 dBc (peak)<br>-30 dBc (average) |  | compliant           |
|                                 |  |                             |                                     |  |                     |
| Middle channel                  |  | 0.5                         | 30 dBm                              |  | Operating frequency |
| No peaks detected               |  |                             | -20 dBc (peak)<br>-30 dBc (average) |  | compliant           |
|                                 |  |                             |                                     |  |                     |
| Highest channel                 |  | 0.8                         | 30 dBm                              |  | Operating frequency |
| No peaks detected               |  |                             | -20 dBc (peak)<br>-30 dBc (average) |  | compliant           |
|                                 |  |                             |                                     |  |                     |

**Results:** DSSS / b – mode; antenna port 2

| TX spurious emissions conducted |  |                             |                                     |  |                     |
|---------------------------------|--|-----------------------------|-------------------------------------|--|---------------------|
| f [MHz]                         |  | amplitude of emission [dBm] | limit max. allowed emission power   | actual attenuation below frequency of operation [dB] | results             |
| Lowest channel                  |  | 8.0                         | 30 dBm                              |  | Operating frequency |
| No peaks detected               |  |                             | -20 dBc (peak)<br>-30 dBc (average) |  | compliant           |
| Middle channel                  |  | 8.4                         | 30 dBm                              |  | Operating frequency |
| No peaks detected               |  |                             | -20 dBc (peak)<br>-30 dBc (average) |  | compliant           |
| Highest channel                 |  | 8.3                         | 30 dBm                              |  | Operating frequency |
| No peaks detected               |  |                             | -20 dBc (peak)<br>-30 dBc (average) |  | compliant           |

**Results:** OFDM / g – mode; antenna port 2

| TX spurious emissions conducted |  |                             |                                     |  |                     |
|---------------------------------|--|-----------------------------|-------------------------------------|--|---------------------|
| f [MHz]                         |  | amplitude of emission [dBm] | limit max. allowed emission power   | actual attenuation below frequency of operation [dB] | results             |
| Lowest channel                  |  | 1.4                         | 30 dBm                              |  | Operating frequency |
| No peaks detected               |  |                             | -20 dBc (peak)<br>-30 dBc (average) |  | compliant           |
| Middle channel                  |  | 0.5                         | 30 dBm                              |  | Operating frequency |
| No peaks detected               |  |                             | -20 dBc (peak)<br>-30 dBc (average) |  | compliant           |
| Highest channel                 |  | 0.2                         | 30 dBm                              |  | Operating frequency |
| No peaks detected               |  |                             | -20 dBc (peak)<br>-30 dBc (average) |  | compliant           |

**Results:** OFDM / n HT20 – mode; antenna port 2

| TX spurious emissions conducted |  |                             |                                     |  |                     |
|---------------------------------|--|-----------------------------|-------------------------------------|--|---------------------|
| f [MHz]                         |  | amplitude of emission [dBm] | limit max. allowed emission power   | actual attenuation below frequency of operation [dB] | results             |
| Lowest channel                  |  | 0.7                         | 30 dBm                              |  | Operating frequency |
| No peaks detected               |  |                             | -20 dBc (peak)<br>-30 dBc (average) |  | compliant           |
|                                 |  |                             |                                     |  |                     |
| Middle channel                  |  | 1.3                         | 30 dBm                              |  | Operating frequency |
| No peaks detected               |  |                             | -20 dBc (peak)<br>-30 dBc (average) |  | compliant           |
|                                 |  |                             |                                     |  |                     |
| Highest channel                 |  | 0.3                         | 30 dBm                              |  | Operating frequency |
| No peaks detected               |  |                             | -20 dBc (peak)<br>-30 dBc (average) |  | compliant           |
|                                 |  |                             |                                     |  |                     |

**Results:** OFDM / ac HT20 –mode; antenna port 2

| TX spurious emissions conducted |  |                             |                                     |  |                     |
|---------------------------------|--|-----------------------------|-------------------------------------|--|---------------------|
| f [MHz]                         |  | amplitude of emission [dBm] | limit max. allowed emission power   | actual attenuation below frequency of operation [dB] | results             |
| Lowest channel                  |  | 1.1                         | 30 dBm                              |  | Operating frequency |
| No peaks detected               |  |                             | -20 dBc (peak)<br>-30 dBc (average) |  | compliant           |
|                                 |  |                             |                                     |  |                     |
| Middle channel                  |  | 0.7                         | 30 dBm                              |  | Operating frequency |
| No peaks detected               |  |                             | -20 dBc (peak)<br>-30 dBc (average) |  | compliant           |
|                                 |  |                             |                                     |  |                     |
| Highest channel                 |  | 0.2                         | 30 dBm                              |  | Operating frequency |
| No peaks detected               |  |                             | -20 dBc (peak)<br>-30 dBc (average) |  | compliant           |
|                                 |  |                             |                                     |  |                     |

**Results:** OFDM / ax HE20 – mode; antenna port 2

| TX spurious emissions conducted |  |                             |                                     |  |                     |
|---------------------------------|--|-----------------------------|-------------------------------------|--|---------------------|
| f [MHz]                         |  | amplitude of emission [dBm] | limit max. allowed emission power   | actual attenuation below frequency of operation [dB] | results             |
| Lowest channel                  |  | 0.6                         | 30 dBm                              |  | Operating frequency |
| No peaks detected               |  |                             | -20 dBc (peak)<br>-30 dBc (average) |  | compliant           |
| Middle channel                  |  | 0.3                         | 30 dBm                              |  | Operating frequency |
| No peaks detected               |  |                             | -20 dBc (peak)<br>-30 dBc (average) |  | compliant           |
| Highest channel                 |  | -0.4                        | 30 dBm                              |  | Operating frequency |
| No peaks detected               |  |                             | -20 dBc (peak)<br>-30 dBc (average) |  | compliant           |



### 13.11 Spurious emissions radiated below 30 MHz

**Description:**

Measurement of the radiated spurious emissions in transmit mode below 30 MHz. The limits are recalculated to a measurement distance of 3 m with 40 dB/decade according CFR Part 2.

**Measurement:**

| Measurement parameter   |   |
|-------------------------|---|
| Detector                | Peak / Quasi Peak   |
| Sweep time              | Auto  |
| Resolution bandwidth    | F < 150 kHz: 200 Hz<br>F > 150 kHz: 9 kHz   |
| Video bandwidth         | F < 150 kHz: 1 kHz<br>F > 150 kHz: 100 kHz  |
| Span                    | 9 kHz to 30 MHz   |
| Trace mode              | Max Hold  |
| Measured modulation     | <input checked="" type="checkbox"/> DSSS b – mode<br><input checked="" type="checkbox"/> OFDM g – mode<br><input type="checkbox"/> OFDM n HT20 – mode<br><input type="checkbox"/> OFDM ac HT20 – mode<br><input type="checkbox"/> OFDM ax HE20 – mode |
| Test setup              | See chapter 7.2 setup B   |
| Measurement uncertainty | See chapter 9   |

**Limits:**

| FCC             |                             | ISED                     |
|-----------------|-----------------------------|--------------------------|
| Frequency / MHz | Field Strength / (dBµV / m) | Measurement distance / m |
| 0.009 – 0.490   | 2400/F(kHz)                 | 300                      |
| 0.490 – 1.705   | 24000/F(kHz)                | 30                       |
| 1.705 – 30.0    | 30                          | 30                       |

**Results:**

| TX spurious emissions radiated < 30 MHz / (dBµV / m) @ 3 m |          |                    |
|--|----------|--------------------|
| Frequency / MHz  | Detector | Level / (dBµV / m) |
| All detected peaks are more than 20 dB below the limit.    |          |                    |

**Plots:** DSSS

**Plot 1:** 9 kHz to 30 MHz, lowest channel

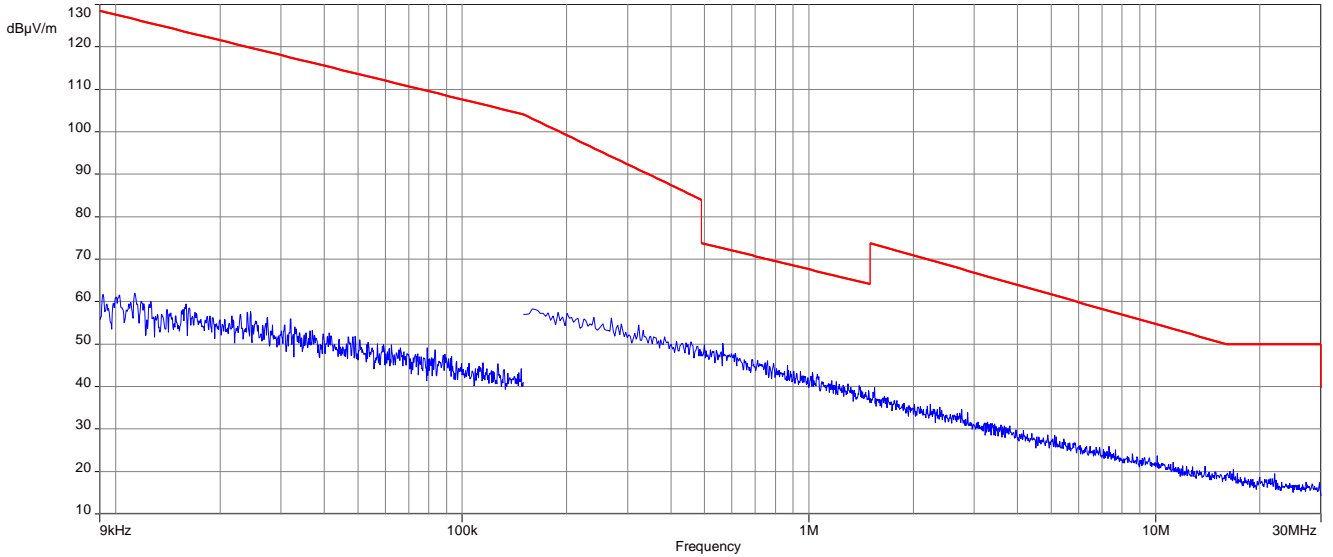

**Plot 2:** 9 kHz to 30 MHz, middle channel

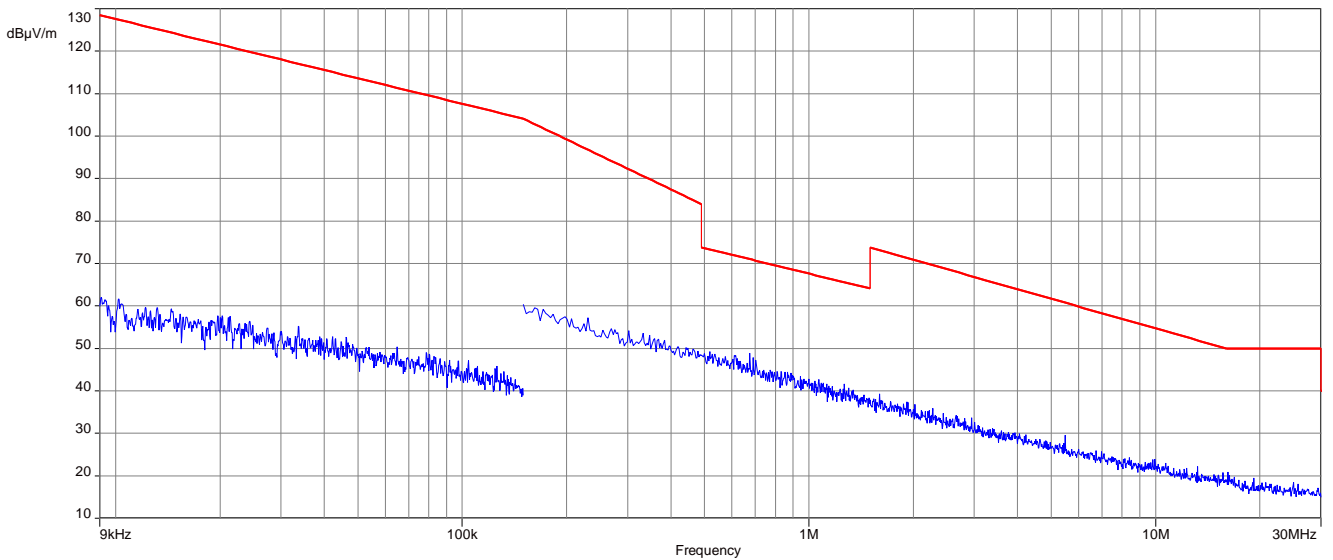

**Plot 3:** 9 kHz to 30 MHz, highest channel

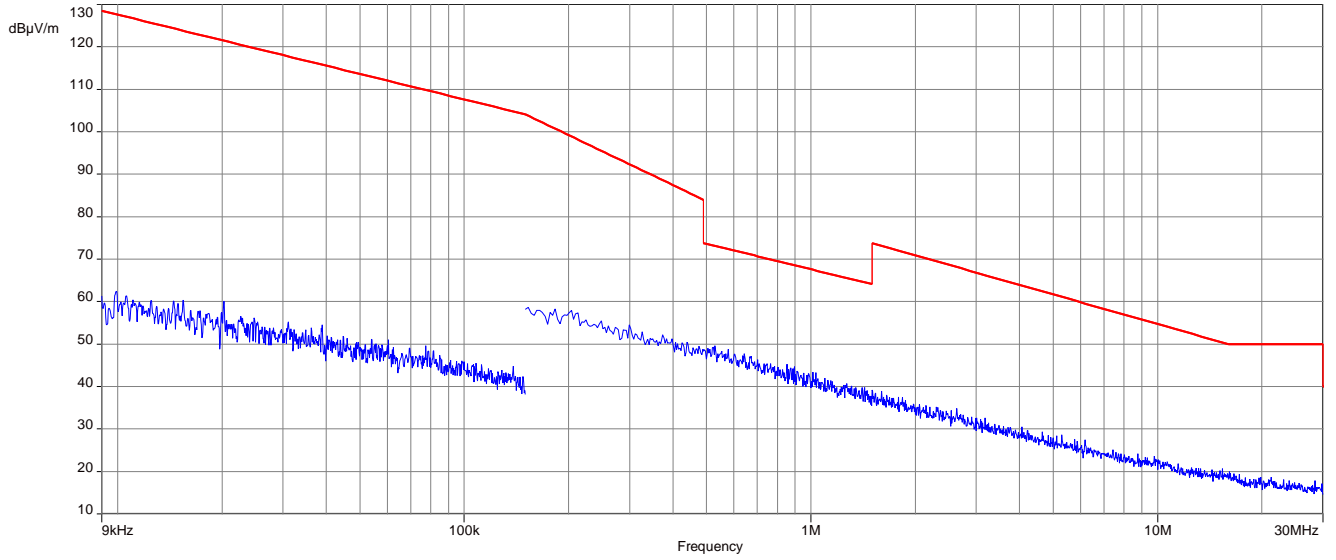

**Plots:** OFDM (20 MHz nominal channel bandwidth)

**Plot 1:** 9 kHz to 30 MHz, lowest channel

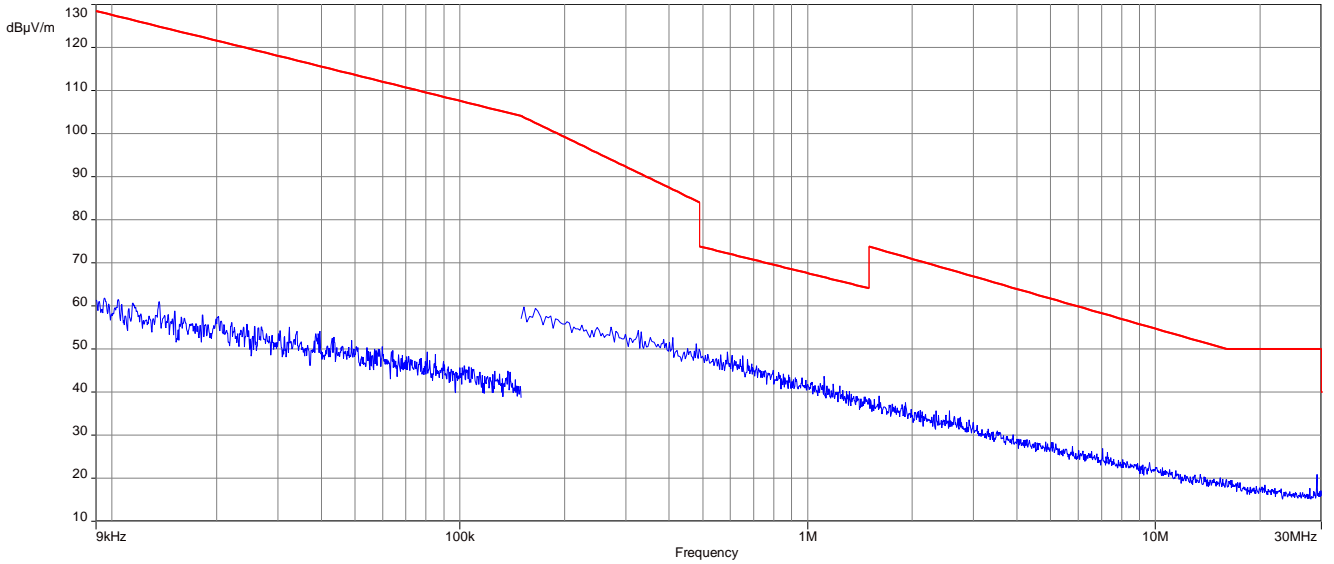

**Plot 2:** 9 kHz to 30 MHz, middle channel

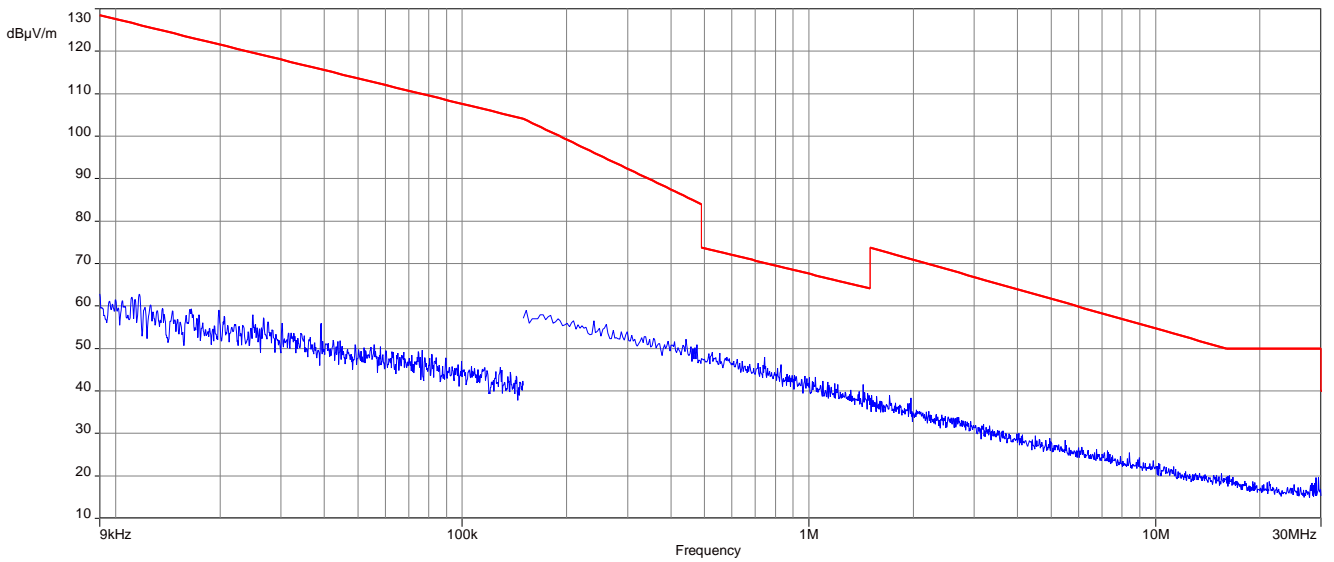

**Plot 3:** 9 kHz to 30 MHz, highest channel

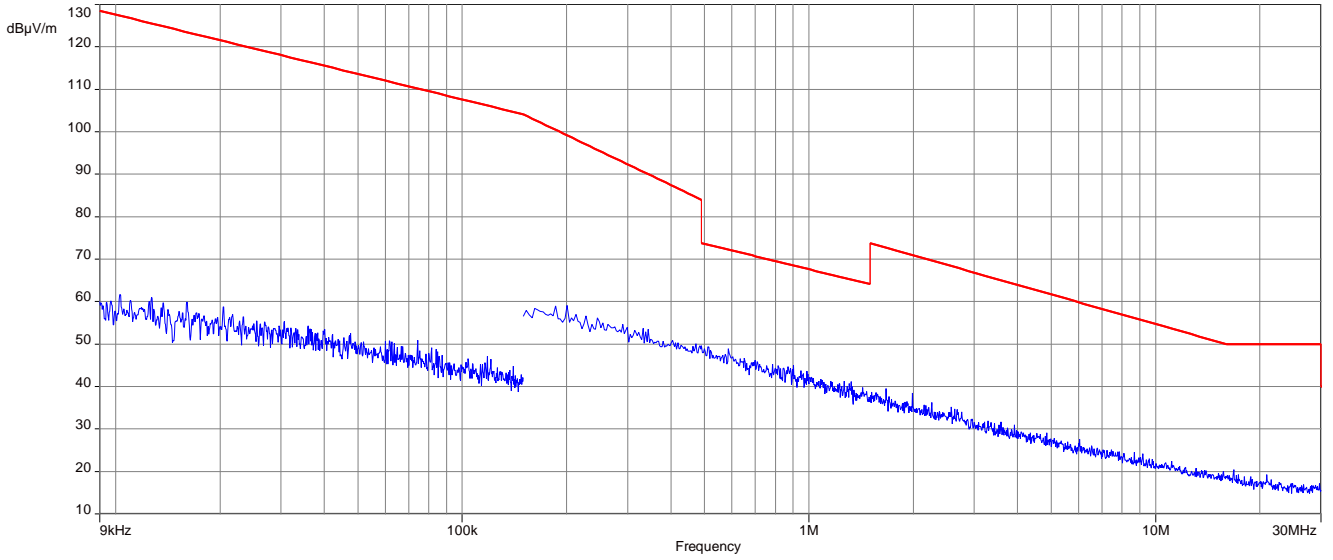

### 13.12 Spurious emissions radiated 30 MHz to 1 GHz

#### Description:

Measurement of the radiated spurious emissions and cabinet radiations below 1 GHz.

#### Measurement:

| Measurement parameter   |   |
|-------------------------|---|
| Detector                | Peak / Quasi Peak   |
| Sweep time              | Auto  |
| Resolution bandwidth    | 120 kHz   |
| Video bandwidth         | 3 x RBW   |
| Span                    | 30 MHz to 1 GHz   |
| Trace mode              | Max Hold  |
| Measured modulation     | <input checked="" type="checkbox"/> DSSS b – mode<br><input checked="" type="checkbox"/> OFDM g – mode<br><input type="checkbox"/> OFDM n HT20 – mode<br><input type="checkbox"/> OFDM ac HT20 – mode<br><input type="checkbox"/> OFDM ax HE20 – mode |
| Test setup              | See chapter 7.1 setup A   |
| Measurement uncertainty | See chapter 9   |

#### Limits:

| FCC  | ISED                              |                          |
|--|-----------------------------------|--------------------------|
| In any 100 kHz bandwidth outside the frequency band in which the spread spectrum or digitally modulated intentional radiator is operating, the radio frequency power that is produced by the intentional radiator shall be at least 20 dB below that in the 100 kHz bandwidth within the band that contains the highest level of the desired power, based on either an RF conducted or a radiated measurement. Attenuation below the general limits specified in Section 15.209(a) is not required. In addition, radiated emissions which fall in the restricted bands, as defined in §15.205(a), must also comply with the radiated emission limits specified in §15.209(a) (see §15.205(c)). |                                   |                          |
| Frequency / MHz  | Field Strength / (dB $\mu$ V / m) | Measurement distance / m |
| 30 – 88  | 30.0                              | 10                       |
| 88 – 216   | 33.5                              | 10                       |
| 216 – 960  | 36.0                              | 10                       |

**Plot:** DSSS

**Plot 1:** 30 MHz to 1 GHz, vertical & horizontal polarization, (valid for all channels)

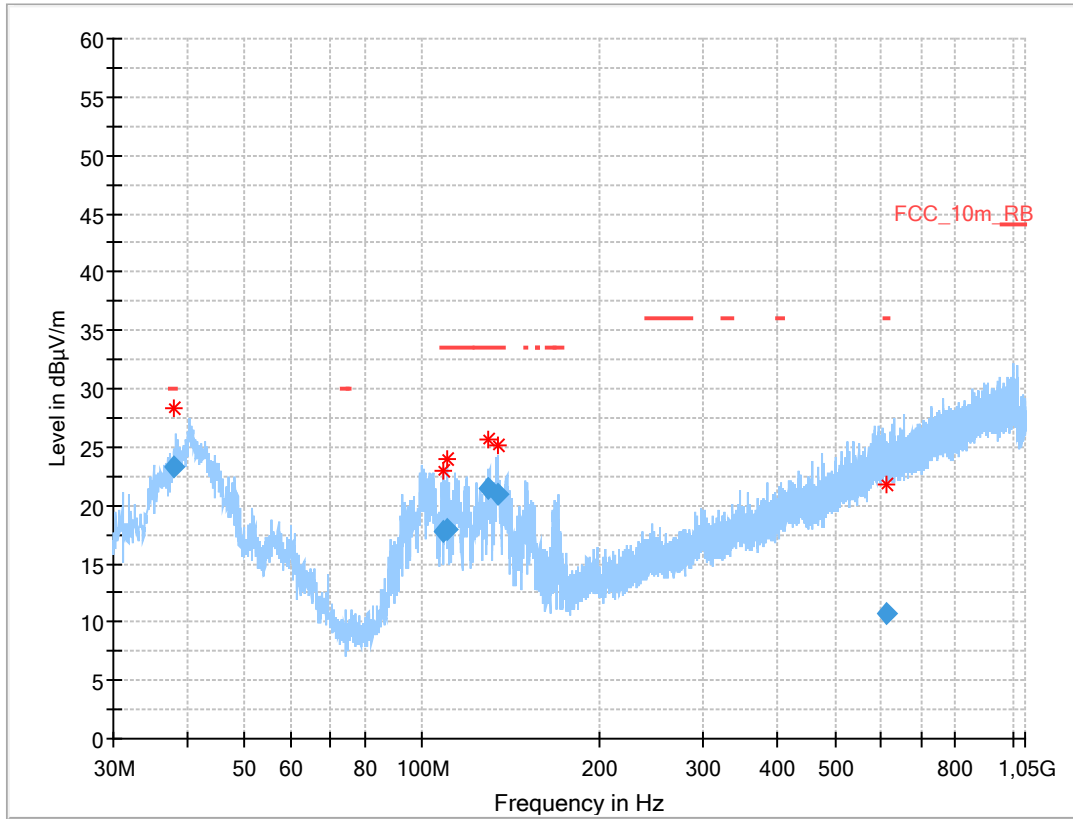

**Final results:**

| Frequency (MHz) | QuasiPeak (dBµV/m) | Limit (dBµV/m) | Margin (dB) | Meas. Time (ms) | Bandwidth (kHz) | Height (cm) | Pol | Azimuth (deg) | Corr. (dB) |
|-----------------|--------------------|----------------|-------------|-----------------|-----------------|-------------|-----|---------------|------------|
| 38.100          | 23.32              | 30.0           | 6.7         | 1000            | 120.0           | 135.0       | V   | 92            | 15         |
| 108.954         | 17.71              | 33.5           | 15.8        | 1000            | 120.0           | 100.0       | V   | 256           | 13         |
| 110.629         | 17.99              | 33.5           | 15.5        | 1000            | 120.0           | 147.0       | V   | 243           | 13         |
| 129.360         | 21.49              | 33.5           | 12.0        | 1000            | 120.0           | 142.0       | V   | 326           | 10         |
| 133.983         | 20.87              | 33.5           | 12.6        | 1000            | 120.0           | 112.0       | V   | -25           | 10         |
| 613.173         | 10.73              | 36.0           | 25.3        | 1000            | 120.0           | 200.0       | V   | 221           | 22         |

**Plot:** OFDM (20 MHz nominal channel bandwidth)

**Plot 2:** 30 MHz to 1 GHz, vertical & horizontal polarization (valid for all channels)

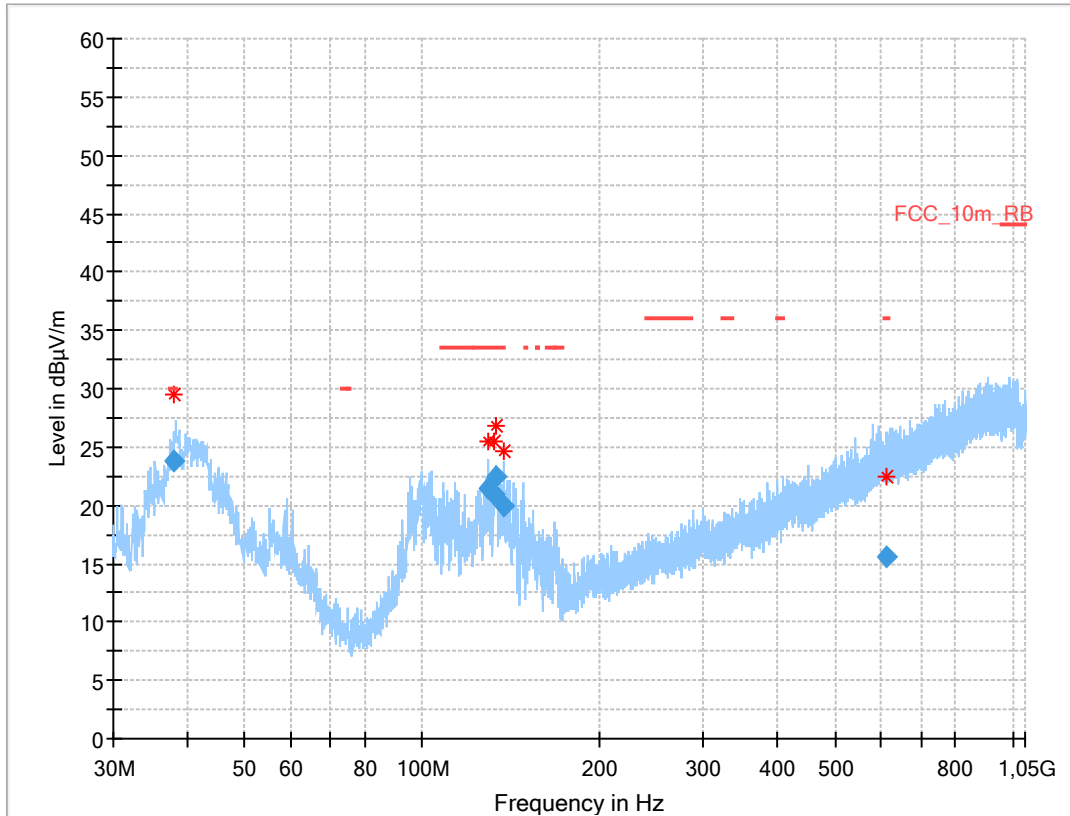

**Final results:**

| Frequency (MHz) | QuasiPeak (dBµV/m) | Limit (dBµV/m) | Margin (dB) | Meas. Time (ms) | Bandwidth (kHz) | Height (cm) | Pol | Azimuth (deg) | Corr. (dB) |
|-----------------|--------------------|----------------|-------------|-----------------|-----------------|-------------|-----|---------------|------------|
| 38.073          | 23.73              | 30.0           | 6.3         | 1000            | 120.0           | 159.0       | V   | 45            | 15         |
| 129.306         | 21.45              | 33.5           | 12.1        | 1000            | 120.0           | 161.0       | V   | 328           | 10         |
| 132.200         | 21.00              | 33.5           | 12.5        | 1000            | 120.0           | 173.0       | V   | 330           | 10         |
| 133.532         | 22.44              | 33.5           | 11.1        | 1000            | 120.0           | 112.0       | V   | 323           | 10         |
| 137.503         | 19.95              | 33.5           | 13.6        | 1000            | 120.0           | 100.0       | V   | 323           | 10         |
| 612.639         | 15.55              | 36.0           | 20.5        | 1000            | 120.0           | 200.0       | V   | 180           | 22         |



### 13.13 Spurious emissions radiated above 1 GHz

**Description:**

Measurement of the radiated spurious emissions above 1 GHz in transmit mode and receiver / idle mode.

**Measurement:**

| Measurement parameter   |   |
|-------------------------|---|
| Detector                | Peak / RMS  |
| Sweep time              | Auto  |
| Resolution bandwidth    | 1 MHz   |
| Video bandwidth         | 3 x RBW   |
| Span                    | 1 GHz to 26 GHz   |
| Trace mode              | Max Hold  |
| Measured modulation     | <input checked="" type="checkbox"/> DSSS b – mode<br><input checked="" type="checkbox"/> OFDM g – mode<br><input type="checkbox"/> OFDM n HT20 – mode<br><input type="checkbox"/> OFDM ac HT20 – mode<br><input type="checkbox"/> OFDM ax HE20 – mode |
| Test setup              | See sub clause 7.2 setup C (1 GHz - 18 GHz)<br>See sub clause 7.3 setup A (18 GHz - 26 GHz)   |
| Measurement uncertainty | See chapter 9   |

**Limits:**

| FCC  | ISED                        |                          |
|--|-----------------------------|--------------------------|
| In any 100 kHz bandwidth outside the frequency band in which the spread spectrum or digitally modulated intentional radiator is operating, the radio frequency power that is produced by the intentional radiator shall be at least 30 dB below that in the 100 kHz bandwidth within the band that contains the highest level of the desired power, based on either an RF conducted or a radiated measurement. Attenuation below the general limits specified in Section 15.209(a) is not required. In addition, radiated emissions which fall in the restricted bands, as defined in §15.205(a), must also comply with the radiated emission limits specified in §15.209(a) (see §15.205(c)). |                             |                          |
| Frequency / MHz  | Field Strength / (dBµV / m) | Measurement distance / m |
| Above 960  | 54.0 (AVG)                  | 3                        |
|  | 74.0 (peak)                 |                          |

**Results:** DSSS

| TX spurious emissions radiated / dBµV/m @ 3 m   |          |                |   |          |                |   |          |                |
|---|----------|----------------|---|----------|----------------|---|----------|----------------|
| lowest channel                                  |          |                | middle channel                                  |          |                | highest channel                                       |          |                |
| f / MHz   | Detector | Level / dBµV/m | f / MHz   | Detector | Level / dBµV/m | f / MHz   | Detector | Level / dBµV/m |
| All detected peaks are below the average limit. |          |                | All detected peaks are below the average limit. |          |                | 2726  | Peak     | 60.0           |
|   |          |                |   |          |                |   | AVG      | 31.4           |
| -/-   | Peak     | -/-            | -/-   | Peak     | -/-            | All other detected peaks are below the average limit. |          |                |
|   | AVG      | -/-            |   | AVG      | -/-            |   |          |                |

**Results:** OFDM (20 MHz nominal channel bandwidth)

| TX spurious emissions radiated / dBµV/m @ 3 m   |          |                |   |          |                |   |          |                |
|---|----------|----------------|---|----------|----------------|---|----------|----------------|
| lowest channel                                  |          |                | middle channel                                  |          |                | highest channel                                 |          |                |
| f / MHz   | Detector | Level / dBµV/m | f / MHz   | Detector | Level / dBµV/m | f / MHz   | Detector | Level / dBµV/m |
| All detected peaks are below the average limit. |          |                | All detected peaks are below the average limit. |          |                | All detected peaks are below the average limit. |          |                |
| -/-   | Peak     | -/-            | -/-   | Peak     | -/-            | -/-   | Peak     | -/-            |
|   | AVG      | -/-            |   | AVG      | -/-            |   | AVG      | -/-            |

**Plots:** DSSS

**Plot 1:** Lowest channel, 1 GHz to 18 GHz, vertical & horizontal polarization

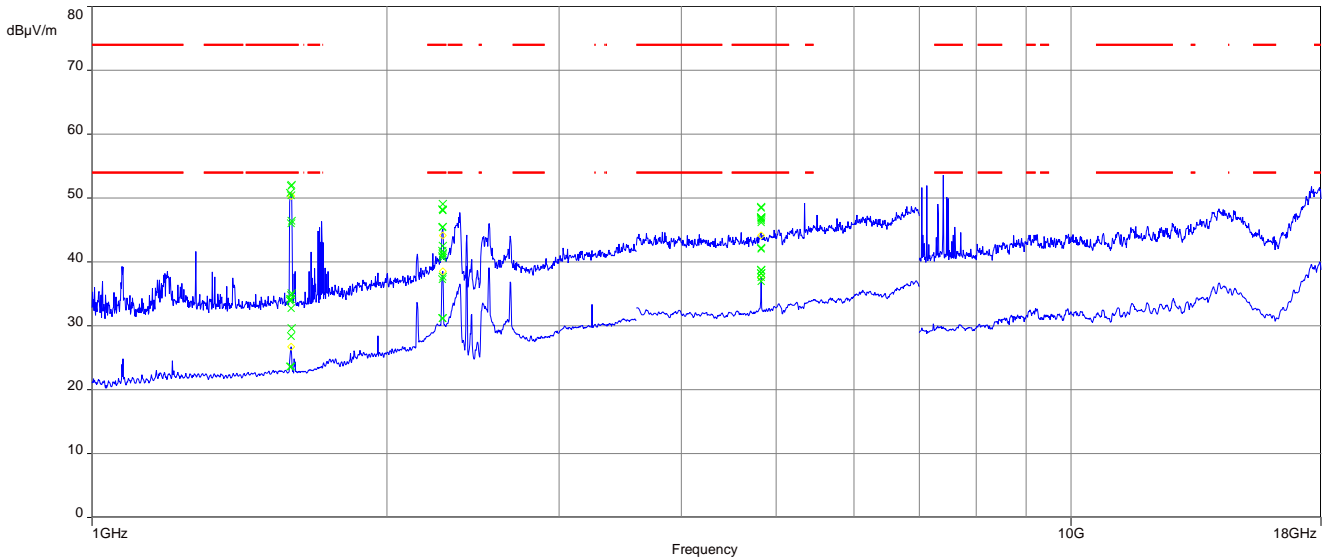

The carrier signal is notched with a 2.4 GHz band rejection filter.

**Plot 2:** Middle channel, 1 GHz to 18 GHz, vertical & horizontal polarization

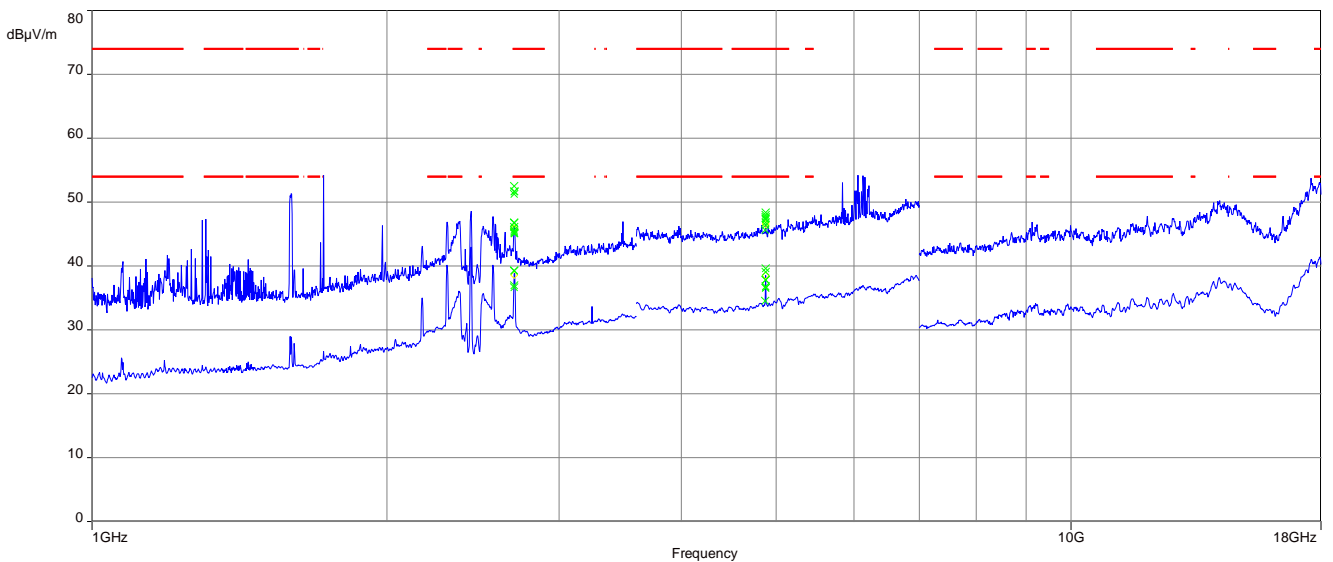

The carrier signal is notched with a 2.4 GHz band rejection filter.

**Plot 3:** Highest channel, 1 GHz to 18 GHz, vertical & horizontal polarization

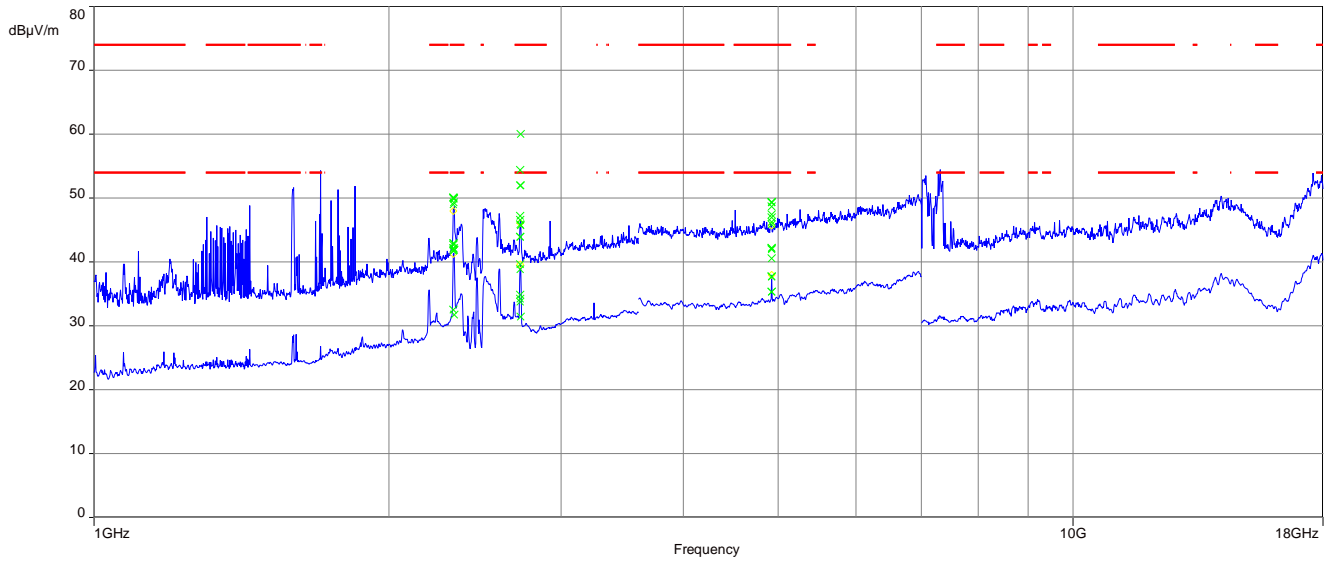

The carrier signal is notched with a 2.4 GHz band rejection filter.

**Plots:** OFDM (20 MHz bandwidth)

**Plot 1:** Lowest channel, 1 GHz to 18 GHz, vertical & horizontal polarization

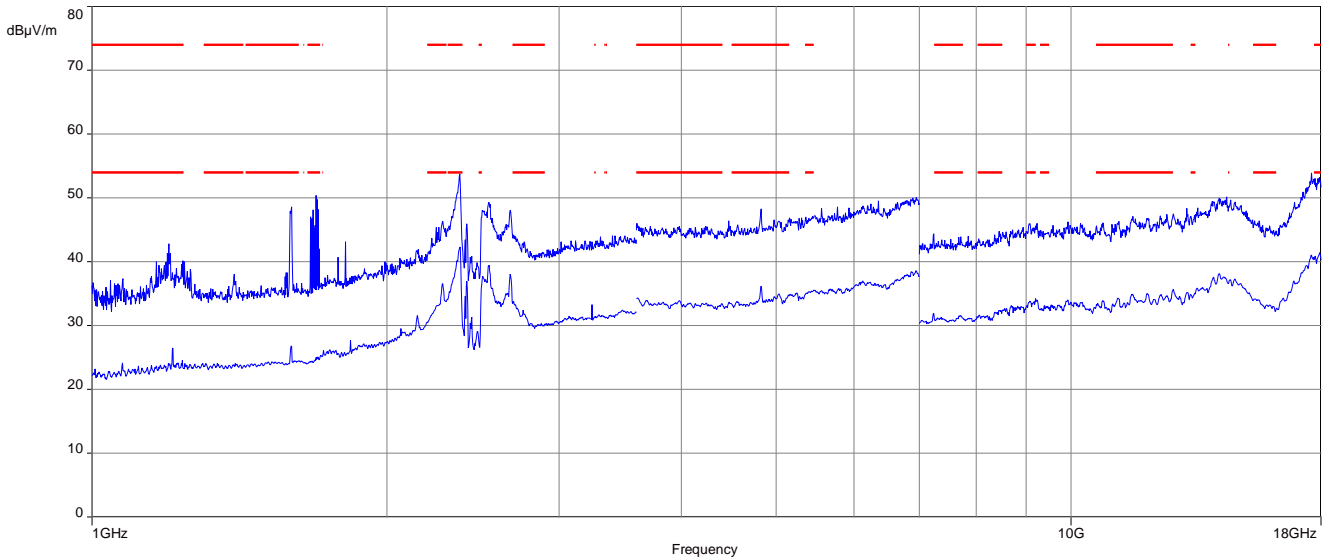

The carrier signal is notched with a 2.4 GHz band rejection filter.

**Plot 2:** Middle channel, 1 GHz to 18 GHz, vertical & horizontal polarization

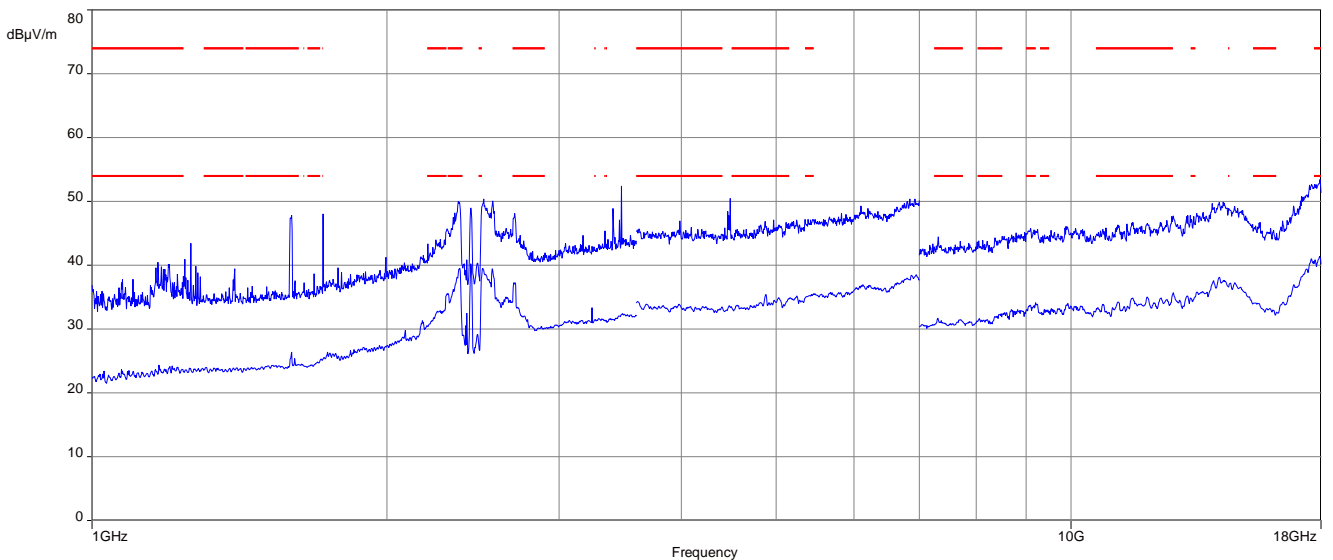

The carrier signal is notched with a 2.4 GHz band rejection filter.

**Plot 3:** Highest channel, 1 GHz to 18 GHz, vertical & horizontal polarization

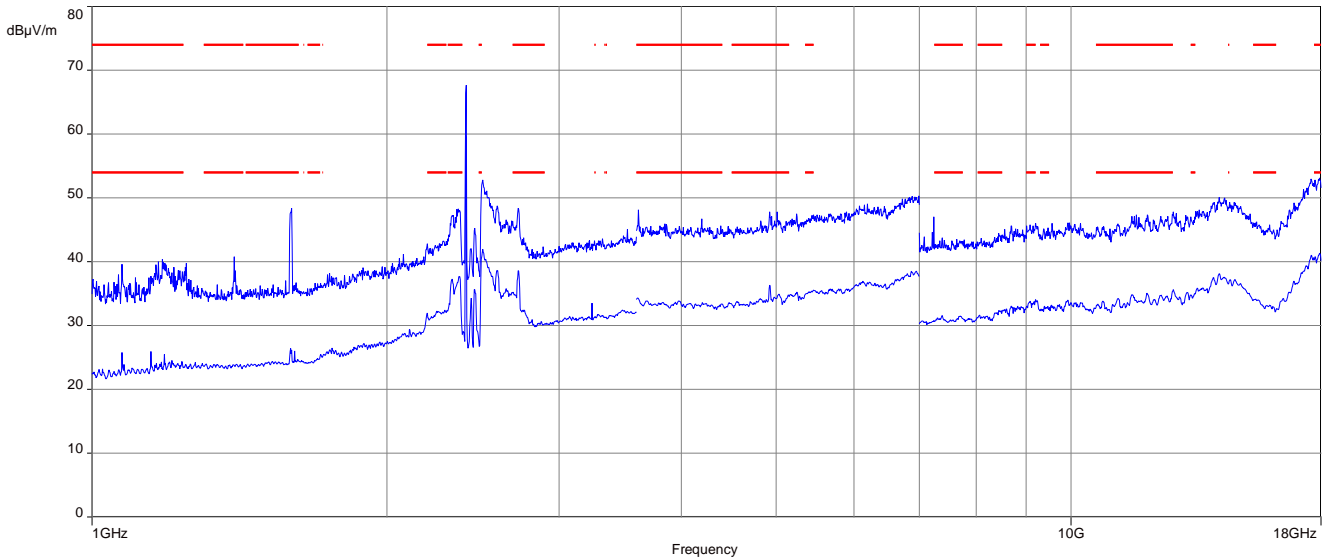

The carrier signal is notched with a 2.4 GHz band rejection filter.

**Plot:** valid for all channels and both modes

**Plot 1:** 18 GHz to 26 GHz, vertical & horizontal polarization

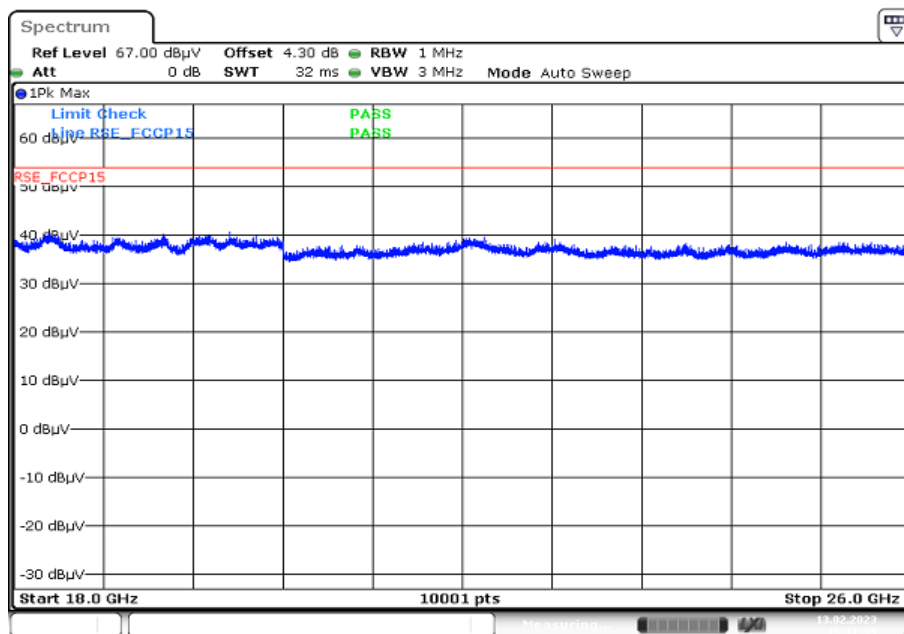

Date: 13 FEB 2023 16:17:20

### 13.14 Spurious emissions conducted below 30 MHz (AC conducted)

#### Description:

Measurement of the conducted spurious emissions in transmit mode below 30 MHz. Both power lines, phase and neutral line, are measured. Found peaks are re-measured with average and quasi peak detection to show compliance to the limits.

#### Measurement:

| Measurement parameter   |  |
|-------------------------|--|
| Detector                | Peak - Quasi Peak / Average                |
| Sweep time              | Auto                                       |
| Resolution bandwidth    | F < 150 kHz: 200 Hz<br>F > 150 kHz: 9 kHz  |
| Video bandwidth         | F < 150 kHz: 1 kHz<br>F > 150 kHz: 100 kHz |
| Span                    | 9 kHz to 30 MHz                            |
| Trace mode              | Max. hold                                  |
| Test setup              | See chapter 7.4 setup A                    |
| Measurement uncertainty | See chapter 9                              |

#### Limits:

| FCC              |                               | ISED                       |  |
|------------------|-------------------------------|----------------------------|--|
| Frequency / MHz) | Quasi-Peak / (dB $\mu$ V / m) | Average / (dB $\mu$ V / m) |  |
| 0.15 – 0.5       | 66 to 56*                     | 56 to 46*                  |  |
| 0.5 – 5          | 56                            | 46                         |  |
| 5 – 30.0         | 60                            | 50                         |  |

\*Decreases with the logarithm of the frequency

**Plots:**

**Plot 1:** 150 kHz to 30 MHz, phase line

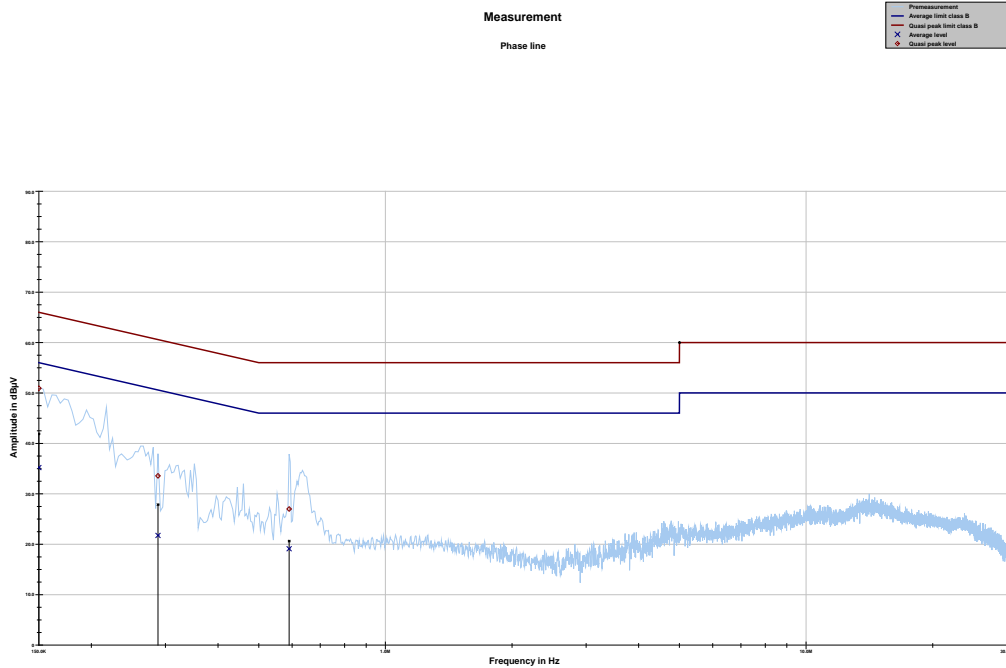

Project ID: 5761\_01\_05

| Frequency | Quasi peak level | Margin quasi peak | Limit QP | Average level | Margin average | Limit AV |
|-----------|------------------|-------------------|----------|---------------|----------------|----------|
| MHz       | dBµV             | dB                | dBµV     | dBµV          | dB             | dBµV     |
| 0.150000  | 50.93            | 15.07             | 66.000   | 35.21         | 20.79          | 56.000   |
| 0.288056  | 33.56            | 27.02             | 60.580   | 21.75         | 30.31          | 52.056   |
| 0.590287  | 26.98            | 29.02             | 56.000   | 19.09         | 26.91          | 46.000   |



Plot 2: 150 kHz to 30 MHz, neutral line

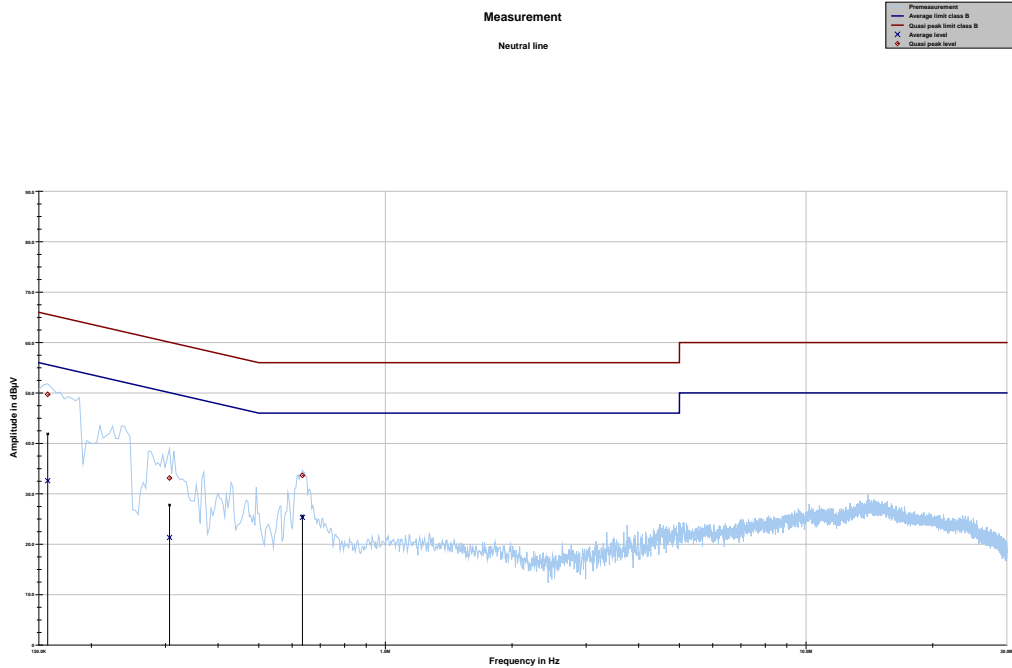

Project ID: 5761\_01\_05

| Frequency | Quasi peak level | Margin quasi peak | Limit QP | Average level | Margin average | Limit AV |
|-----------|------------------|-------------------|----------|---------------|----------------|----------|
| MHz       | dBµV             | dB                | dBµV     | dBµV          | dB             | dBµV     |
| 0.150000  | 50.93            | 15.07             | 66.000   | 35.21         | 20.79          | 56.000   |
| 0.288056  | 33.56            | 27.02             | 60.580   | 21.75         | 30.31          | 52.056   |
| 0.590287  | 26.98            | 29.02             | 56.000   | 19.09         | 26.91          | 46.000   |

## 14 Observations

No observations except those reported with the single test cases have been made.

## 15 Glossary

|                  |  |
|------------------|--|
| <b>EUT</b>       | Equipment under test                       |
| <b>DUT</b>       | Device under test                          |
| <b>UUT</b>       | Unit under test                            |
| <b>FCC</b>       | Federal Communications Commission          |
| <b>FCC ID</b>    | Company Identifier at FCC                  |
| <b>IC</b>        | Industry Canada                            |
| <b>PMN</b>       | Product marketing name                     |
| <b>HMN</b>       | Host marketing name                        |
| <b>HVIN</b>      | Hardware version identification number     |
| <b>FVIN</b>      | Firmware version identification number     |
| <b>EMC</b>       | Electromagnetic Compatibility              |
| <b>HW</b>        | Hardware                                   |
| <b>SW</b>        | Software                                   |
| <b>Inv. No.</b>  | Inventory number                           |
| <b>S/N or SN</b> | Serial number                              |
| <b>C</b>         | Compliant                                  |
| <b>NC</b>        | Not compliant                              |
| <b>NA</b>        | Not applicable                             |
| <b>NP</b>        | Not performed                              |
| <b>PP</b>        | Positive peak                              |
| <b>QP</b>        | Quasi peak                                 |
| <b>AVG</b>       | Average                                    |
| <b>OC</b>        | Operating channel                          |
| <b>OCW</b>       | Operating channel bandwidth                |
| <b>OBW</b>       | Occupied bandwidth                         |
| <b>OOB</b>       | Out of band                                |
| <b>DFS</b>       | Dynamic frequency selection                |
| <b>CAC</b>       | Channel availability check                 |
| <b>OP</b>        | Occupancy period                           |
| <b>NOP</b>       | Non occupancy period                       |
| <b>DC</b>        | Duty cycle                                 |
| <b>PER</b>       | Packet error rate                          |
| <b>CW</b>        | Clean wave                                 |
| <b>MC</b>        | Modulated carrier                          |
| <b>WLAN</b>      | Wireless local area network                |
| <b>RLAN</b>      | Radio local area network                   |
| <b>DSSS</b>      | Dynamic sequence spread spectrum           |
| <b>OFDM</b>      | Orthogonal frequency division multiplexing |
| <b>FHSS</b>      | Frequency hopping spread spectrum          |

## 16 Document history

| Version | Applied changes | Date of release |
|---------|-----------------|-----------------|
| -/-     | Initial release | 2023-03-07      |

## 17 Accreditation Certificate – D-PL-12076-01-05

| first page   | last page  |
|--|--|
|  <p>The first page of the accreditation certificate includes the DAKKS logo, the name 'Deutsche Akkreditierungsstelle GmbH', and details about its accreditation for CTC advanced GmbH. It specifies the testing fields as 'Telecommunication (FCC Requirements)' and provides the registration number D-PL-12076-01-05. The page is signed by the Head of Division on 09.06.2020.</p> |  <p>The last page of the accreditation certificate contains contact information for three offices: Berlin, Frankfurt am Main, and Braunschweig. It also includes a disclaimer about the publication of extracts and a list of websites where the up-to-date state of membership can be retrieved.</p> |

**Note: The current certificate annex is published on the websites (link see below).**

<https://www.dakks.de/files/data/as/pdf/D-PL-12076-01-05e.pdf>

or

[https://cetecomadvanced.com/files/pdfs/d-pl-12076-01-05\\_tcb\\_usa.pdf](https://cetecomadvanced.com/files/pdfs/d-pl-12076-01-05_tcb_usa.pdf)

##### END OF TEST REPORT #####