

ELECTROMAGNETIC EMISSIONS COMPLIANCE REPORT

INTENTIONAL RADIATOR CERTIFICATION TO FCC PART 22 SUBPART H and PART 24 SUBPART E

OF

Product Name: MO300QBM

Brand Name: SAGEM

Model Name: MO300QBM

Market Name: N/A

FCC ID: VW3MO300QBM

Report No.: ER/2008/20007

Issue Date: Oct. 29, 2008

FCC Rule Part: 2, 22H & 24E

Prepared for: SAGEM COMMUNICATIONS
27, rue Leblanc, 75512 PARIS CEDEX 15, France

Prepared by: SGS Taiwan Ltd.
Electronics & Communication Laboratory
No. 134, Wu Kung Rd., Wuku Industrial Zone,
Taipei County, Taiwan.

Note: This report shall not be reproduced except in full, without the written approval of SGS Taiwan Ltd. This document may be altered or revised by SGS Taiwan Ltd. personnel only, and shall be noted in the revision section of the document.

VERIFICATION OF COMPLIANCE

Applicant: SAGEM COMMUNICATIONS
27, rue Leblanc, 75512 PARIS CEDEX 15, France

Product Name: MO300QBM

FCC ID Number: VW3MO300QBM

Brand Name: SAGEM

Model No.: MO300QBM

Market name: N/A

Model Difference: N/A

File Number: ER/2008/20007

Date of test: Feb. 12, 2008 ~ Feb. 17, 2008

Date of EUT Received: Feb. 12, 2008

We hereby certify that:

The above equipment was tested by SGS Taiwan Ltd. The test data, data evaluation, test procedures, and equipment configurations shown in this report were made in accordance with the procedures given in TIA/EIA-603-B-2002 and the energy emitted by the sample EUT tested as described in this report is in compliance with conducted and radiated emission limits of FCC Rule FCC PART 22 subpart H and FCC PART 24 subpart E.

The test results of this report relate only to the tested sample identified in this report.

Test By:		Date	Oct. 29, 2008
	Sky Wang/Asst. Supervisor		
Prepared By:		Date	Oct. 29, 2008
	Elisa Chen/Asst. Supervisor		
Approved By:		Date	Oct. 29, 2008
	Vincent Su/Manager		

Version

Version No.	Date	Description
00	Feb. 18, 2008	Initial creation of document
01	Oct. 20, 2008	Part of EDGE data added
02	Oct. 29, 2008	Revise 2 slots to 1 slot in page 19 and 20 for typo.

This document is issued by the Company subject to its General Conditions of Service which is available on request or accessible at www.sgs.com. Attention is drawn to the limitations of liability, indemnification and jurisdictional issues defined therein. Unless otherwise stated, the results shown in this test report refer only to the sample(s) tested. This document cannot be reproduced except in full, without prior approval of the Company. Any unauthorized alteration, forgery or falsification of the content or appearance of this report is unlawful and offenders may be prosecuted to the fullest extent of the law. 此報告是遵循本公司訂定之通用服務條款所製作發放，相關服務條款備索，或可在 www.sgs.com 中查閱，本公司之義務、免責、管轄權皆明確規範其中。除非另有說明，此報告結果僅對檢驗之樣品負責。本報告未經本公司書面許可，不可部份複製。對本報告內容或外觀之任何未經授權之變更、偽造、竄改皆屬非法，違犯者將會被依法追訴。

Table of Contents

1. GENERAL INFORMATION	6
1.1. Related Submittal(s) / Grant (s)	7
1.2. Test Methodology	7
1.3. Test Facility	7
1.4. Special Accessories	7
1.5. Equipment Modifications	7
2. SYSTEM TEST CONFIGURATION	8
2.1. EUT Configuration	8
2.2. EUT Exercise	8
2.3. Test Procedure	8
2.4. Configuration of Tested System	9
3. SUMMARY OF TEST RESULTS	10
4. DESCRIPTION OF TEST MODES	10
5. RF POWER OUTPUT MEASUREMENT	11
5.1. Standard Applicable	11
5.2. Test Set-up:	11
5.3. Measurement Procedure	11
5.4. Measurement Equipment Used:	12
5.5. Measurement Result	12
Note: The path loss was offset in the instrument during test.ERP, EIRP MEASUREMENT ...	14
ERP, EIRP MEASUREMENT	15
5.6. Standard Applicable	15
5.7. Test SET-UP (Block Diagram of Configuration)	15
5.8. Measurement Procedure	17
5.9. Measurement Equipment Used:	18
5.10. Measurement Result	19
6. 99% OCCUPIED BANDWIDTH MEASUREMENT	21
6.1. Standard Applicable	21
6.2. Test Set-up:	21
6.3. Measurement Procedure	21
6.4. Measurement Equipment Used:	22
6.5. Measurement Result:	22
7. OUT OF BAND EMISSION AT ANTENNA TERMINALS	31
7.1. Standard Applicable	31
7.2. Test SET-UP	31
7.3. Measurement Procedure	31

This document is issued by the Company subject to its General Conditions of Service which is available on request or accessible at www.sgs.com. Attention is drawn to the limitations of liability, indemnification and jurisdictional issues defined therein. Unless otherwise stated, the results shown in this test report refer only to the sample(s) tested. This document cannot be reproduced except in full, without prior approval of the Company. Any unauthorized alteration, forgery or falsification of the content or appearance of this report is unlawful and offenders may be prosecuted to the fullest extent of the law. 此報告是遵循本公司訂定之通用服務條款所製作發放，相關服務條款備索，或可在 www.sgs.com 中查閱，本公司之義務、免責、管轄權皆明確規範其中。除非另有說明，此報告結果僅對檢驗之樣品負責。本報告未經本公司書面許可，不可部份複製。對本報告內容或外觀之任何未經授權之變更、偽造、竄改皆屬非法，違犯者將會被依法追訴。

7.4.	Measurement Equipment Used:	32
7.5.	Measurement Result.....	33
8.	FIELD STRENGTH OF SPURIOUS RADIATION MEASUREMENT	43
8.1.	Standard Applicable	43
8.2.	EUT Setup (Block Diagram of Configuration).....	43
8.3.	Measurement Procedure.....	45
8.4.	Measurement Equipment Used:	46
8.5.	Measurement Result.....	46
9.	FREQUENCY STABILITY V.S. TEMPERATURE MEASUREMENT	59
9.1.	Standard Applicable	59
9.2.	Test Set-up:	59
9.3.	Measurement Procedure.....	59
9.4.	Measurement Equipment Used:	60
9.5.	Measurement Result.....	61
10.	FREQUENCY STABILITY V.S. VOLTAGE MEASUREMENT	62
10.1.	Standard Applicable	62
10.2.	Test Set-up:	62
10.3.	Measurement Procedure.....	62
10.4.	Measurement Equipment Used:	63
10.5.	Measurement Result.....	64
11.	AC POWER LINE CONDUCTED EMISSION TEST	65
11.1.	Standard Applicable	65
11.2.	EUT Setup.....	65
11.3.	Measurement Procedure.....	65
11.4.	Measurement Equipment Used:	66
11.5.	Measurement Result.....	66
	PHOTOGRAPHS OF SET UP	71
	PHOTOGRAPHS OF EUT	74

1. GENERAL INFORMATION

Product Name:	MO300QBM	
Model Name:	MO300QBM	
Market name:	N/A	
Model Difference:	N/A	
Brand Name:	SAGEM	
Simple Hands-Free (SHF):	N/A	
Power Supply:	3.8 Vdc	
	Battery Model:	N/A
	Adapter Model:	N/A

GSM:

Frequency Range and Power	GSM/GPRS 850: 824MHz –849MHz GPRS Class 10	33 dBm
	EDGE 850: 824MHz –849MHz, Class 10	27 dBm
	PCS/GPRS 1900: 1850MHz –1910MHz GPRS Class 10	30 dBm
	EDGE 1900: 1850MHz –1910MHz, Class 10	26 dBm
Type of Emission:	GSM/GPRS: 300KGXW EDGE: 300KG7W	
Software Version:	K 3,X	
Hardware Version:	V3.x	

1.1. Related Submittal(s) / Grant (s)

This submittal(s) (test report) is intended to comply with Section Part 22 subpart H and Part 24 subpart E of the FCC CFR 47 Rules.

1.2. Test Methodology

Both conducted and radiated testing were performed according to the procedures documented on chapter 13 of ANSI C63.4 (2003) and FCC CFR 47.1046, 2.1047, 2.1049, 2.1051, 2.1053, 2.1055 and 2.1057.

1.3. Test Facility

The measurement facilities used to collect the 3m Radiated Emission and AC power line conducted data are located on the address of SGS Taiwan Ltd. Electronics & Communication Laboratory No. 134, Wu Kung Rd., Wuku Industrial Zone, Taipei Country, Taiwan which are constructed and calibrated to meet the FCC requirements in documents ANSI C63.4: 2003. FCC Registration Number are: 990257 and 236194, Canada Registration Number: 4620A-1

The 10 m Open Area Test Sites located on the address of SGS Taiwan Ltd. Electronics & Communication Laboratory No. 29, Pau-Tou-Tsuo Valley Chia-Pau Tsuen, Linkou Hsiang, Taipei county, which is constructed and calibrated to meet the CISPR 22/EN 55022 requirements. SGS Site No. 1(3 &10 meters) and FCC Registration Number: 94644.

1.4. Special Accessories

Not available for this EUT intended for grant.

1.5. Equipment Modifications

Not available for this EUT intended for grant.

2. SYSTEM TEST CONFIGURATION

2.1. EUT Configuration

The EUT configuration for testing is installed on RF field strength measurement to meet the Commissions requirement and operating in a manner which intends to maximize its emission characteristics in a continuous normal application.

2.2. EUT Exercise

The EUT (Transmitter) was operated in the engineering mode to fix the Tx frequency which was for the purpose of the measurements.

2.3. Test Procedure

2.3.1 Conducted Emissions

The EUT is placed on a turn table which is 0.8 m above ground plane. According to the requirements in Section 7 and 13 of ANSI C63.4-2003. Conducted emissions from the EUT measured in the frequency range between 0.15 MHz and 30MHz using CISPR Quasi-Peak and Average detector mode.

2.3.2 Radiated Emissions

The EUT is placed on a turn table which is 1.0 m above ground plane. The turn table shall rotate 360 degrees to determine the position of maximum emission level. EUT is set 3m away from the receiving antenna which varied from 1m to 4m to find out the highest emission. And also, each emission was to be maximized by changing the polarization of receiving antenna both horizontal and vertical. In order to find out the max. emission, the relative positions of this hand-held transmitter (EUT) was rotated through three orthogonal axes according to the requirements in Section 8 and 13 of ANSI C63.4-2003.

2.4. Configuration of Tested System

Fig. 2-1 Configuration of Tested System (Fixed Channel)

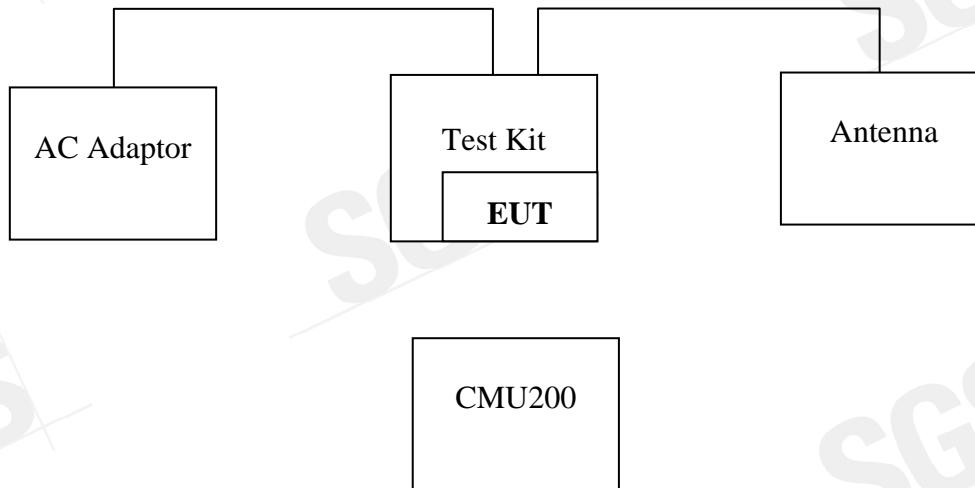

Table 2-1 Equipment Used in Tested System

Item	Equipment	Mfr/Brand	Model/ Type No.	Series No.	Data Cable	Power Cord
1	Universal Radio Communication Tester	R&S	CMU200	102189	shielded	Un-shielded
2	Test Kit	SAGEM	MO300 demoboard	N/A	N/A	N/A
3	Antenna	N/A	N/A	N/A	Un-shielded	Un-shielded
4	AC/DC Adaptor	N/A	FW75550/05	N/A	N/A	Un-shielded

3. SUMMARY OF TEST RESULTS

FCC Rules	Description Of Test	Result
§2.1046(a) §22.913(a) §24.232(a)	RF Power Output	Compliant
§2.1046(a) §22.913(a) §24.232(a)	ERP/ EIRP measurement	Compliant
§2.1049(h)	99% Occupied Bandwidth	Compliant
§2.1051 §22.917(a) §24.238(a)	Out of Band Emissions at Antenna Terminals and Band Edge	Compliant
§2.1053 §22.917(a) §24.238(a)	Field Strength of Spurious Radiation	Compliant
§2.1055(a)(1)(b)	Frequency Stability vs. Temperature	Compliant
§2.1055(d)(1)(2)	Frequency Stability vs. Voltage	Compliant
§15.107;§15.207	AC Power Line Conducted Emission	Compliant

4. DESCRIPTION OF TEST MODES

The EUT has been tested under operating condition.

EUT staying in continuous transmitting mode. Channel Low, Mid and High for each band with max. data rate were chosen for full testing.

The field strength of spurious radiation emission was measured as EUT lie down and stand position (E1 and H mode) for both GSM and GPRS. The worst-case of H mode for GSM 850 band and E1 for GSM 1900 band for channel Low, Mid and High at GSM mode was reported.

5. RF POWER OUTPUT MEASUREMENT

5.1. Standard Applicable

According to FCC §2.1046.

FCC 22.913(a) Mobile station are limited to 7W.

FCC 24.232(b) Mobile station are limited to 2W.

5.2. Test Set-up:

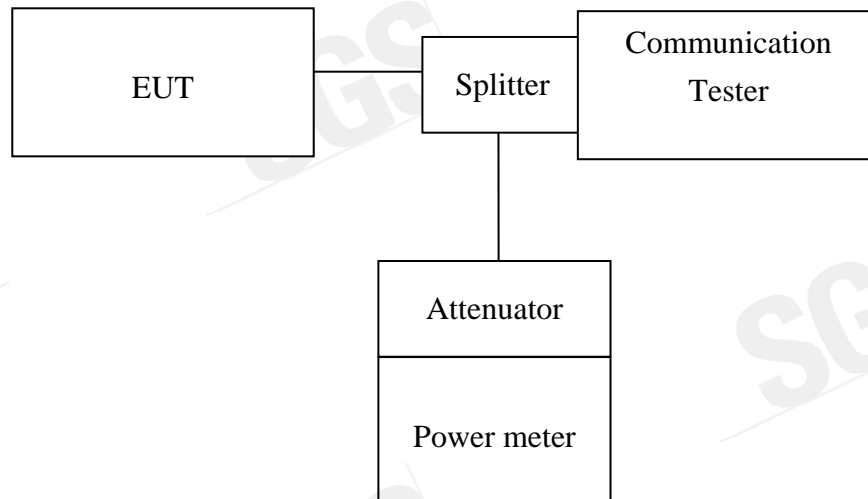

Note: Measurement setup for testing on Antenna connector

5.3. Measurement Procedure

The transmitter output was connected to a calibrated attenuator, the other end of which was connected to a power meter. Transmitter output was read off the power meter in dBm. The power output at the transmitter antenna port was determined by adding the value of the attenuator to the power meter reading.

5.4. Measurement Equipment Used:

Conducted Emission Test Site					
EQUIPMENT TYPE	MFR	MODEL NUMBER	SERIAL NUMBER	LAST CAL.	CAL DUE.
Spectrum Analyzer	Agilent	E4446A	MY43360126	04/19/2008	04/18/2010
Spectrum Analyzer	Agilent	E7405A	US41160416	07/04/2007	07/03/2009
Spectrum Analyzer	R&S	FSP 40	100034	02/22/2008	02/21/2009
Communication Test	R&S	CMU200	102189	05/13/2008	05/12/2009
Power Sensor	Anritsu	MA2490A	31431	07/07/2007	07/06/2009
Power Meter	Anritsu	ML2487A	6K00002070	05/28/2008	05/27/2010
Temperature Chamber	TERCHY	MHG-120LF	911009	04/14/2008	04/13/2009
Low Loss Cable	HUBER+SUHNER	SUCOFLEX 104PEA	N/A	02/13/2008	02/12/2009
Attenuator	Mini-Circuit	BW-S10W5	N/A	07/05/2008	07/04/2009
Attenuator	Mini-Circuit	BW-S6W5	N/A	07/05/2008	07/04/2009
Splitter	Agilent	11636B	51818 / 51820	07/05/2008	07/04/2009
DC Power Supply	Agilent	6038A	2929A-07548	06/27/2007	06/26/2009

5.5. Measurement Result

850 GSM mode:

EUT Mode	Frequency (MHz)	CH	Power meter Reading (dBm)	Path Loss (dB)	Peak Power (dBm)
GSM 850, 1 time slot	824.20	128	14.94	17.80	32.74
	836.60	190	15.04	17.80	32.84
	848.80	251	15.12	17.80	32.92

850 GPRS mode:

EUT Mode	Frequency (MHz)	CH	Power meter Reading (dBm)	Path Loss (dB)	Peak Power (dBm)
GPRS 850 1 time slot	824.2	128	32.4	0	32.4
	836.6	190	32.5	0	32.5
	848.8	251	32.6	0	32.6
GPRS 850 2 time slot	824.2	128	31.0	0	31.0
	836.6	190	31.1	0	31.1
	848.8	251	31.2	0	31.2

GPRS 850 1 time slot has max. conducted power.

850 EDGE mode:

EUT Mode	Frequency (MHz)	CH	Power meter Reading (dBm)	Path Loss (dB)	Peak Power (dBm)
EDGE 850 1 Time slot	824.2	128	27	0	27
	836.6	190	26.9	0	26.9
	848.8	251	26.8	0	26.8
EDGE 850 2 Time slot	824.2	128	26.6	0	26.6
	836.6	190	26.5	0	26.5
	848.8	251	26.4	0	26.4

EDGE 850 1 time slot has max. conducted power.

Note: The path loss was offset in the instrument during test.

PCS mode:

EUT Mode	Frequency (MHz)	CH	Power Meter Reading (dBm)	Path Loss (dB)	Peak Power (dBm)
PCS 1900 1 time slot	1850.20	512	12.32	17.80	30.12
	1880.00	661	12.34	17.80	30.14
	1909.80	810	12.28	17.80	30.08

1900 GPRS mode:

EUT Mode	Frequency (MHz)	CH	Power meter Reading (dBm)	Path Loss (dB)	Peak Power (dBm)
GPRS 1900 1 time slot	1850.2	512	29.8	0	29.8
	1880	661	29.6	0	29.6
	1909.8	810	29.5	0	29.5
GPRS 1900 2 time slot	1850.2	512	28.4	0	28.4
	1880	661	28.2	0	28.2
	1909.8	810	28	0	28

GPRS 1900 1 time slot has max. conducted power.

1900 EDGE Mode:

EUT Mode	Frequency (MHz)	CH	Power meter Reading (dBm)	Path Loss (dB)	Peak Power (dBm)
EDGE 1900 1 Time slot	1850.2	512	26.4	0	26.4
	1880	661	26.3	0	26.3
	1909.8	810	26.1	0	26.1
EDGE 1900 2 Time slot	1850.2	512	25.6	0	25.6
	1880	661	25.5	0	25.5
	1909.8	810	25.4	0	25.4

EDGE 1900 1 time slot has max. conducted power.

Note: The path loss was offset in the instrument during test.

ERP, EIRP MEASUREMENT

5.6. Standard Applicable

According to FCC §2.1046

FCC 22.913(a) Mobile station are limited to 7W ERP.

FCC 24.232(b) Mobile station are limited to 2W EIRP.

5.7. Test SET-UP (Block Diagram of Configuration)

(A) Radiated Emission Test Set-Up, Frequency Below 1000MHz

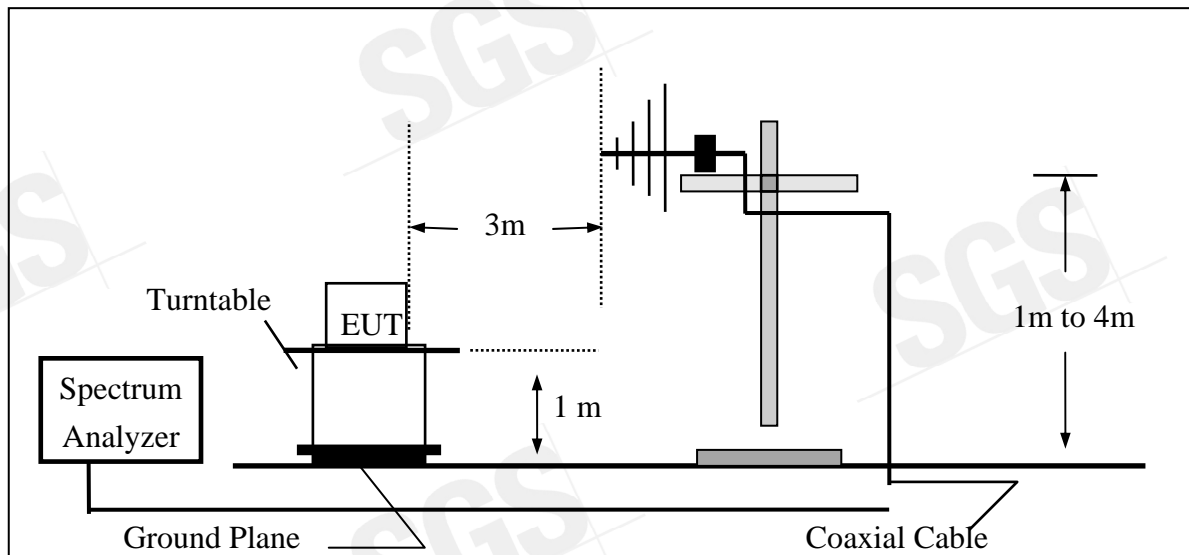

(B) Radiated Emission Test Set-UP Frequency Over 1 GHz

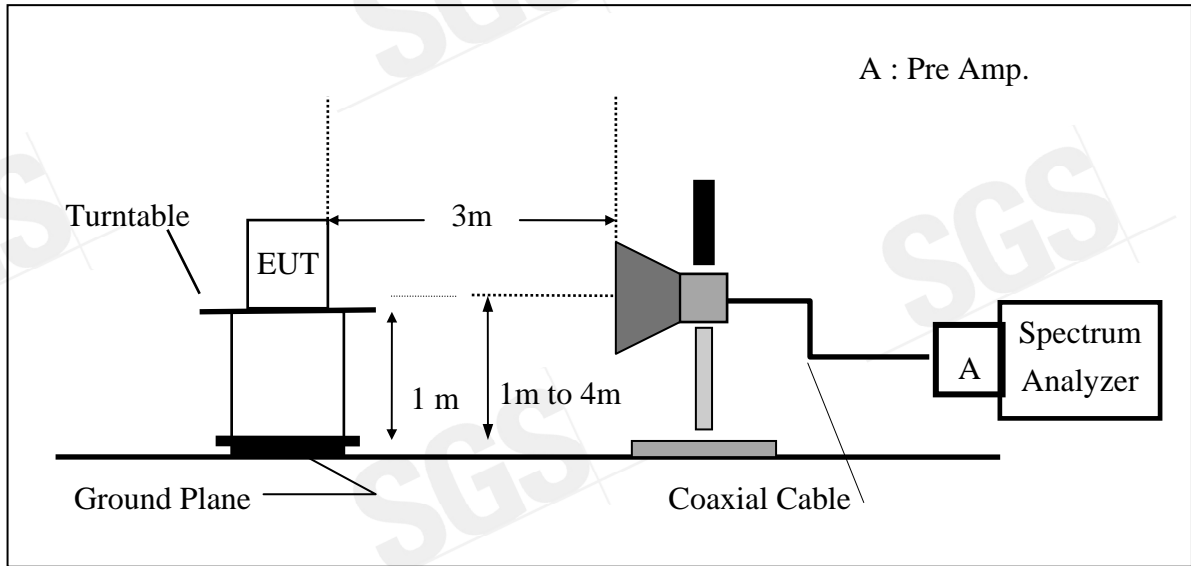

(C) Substituted Method Test Set-UP

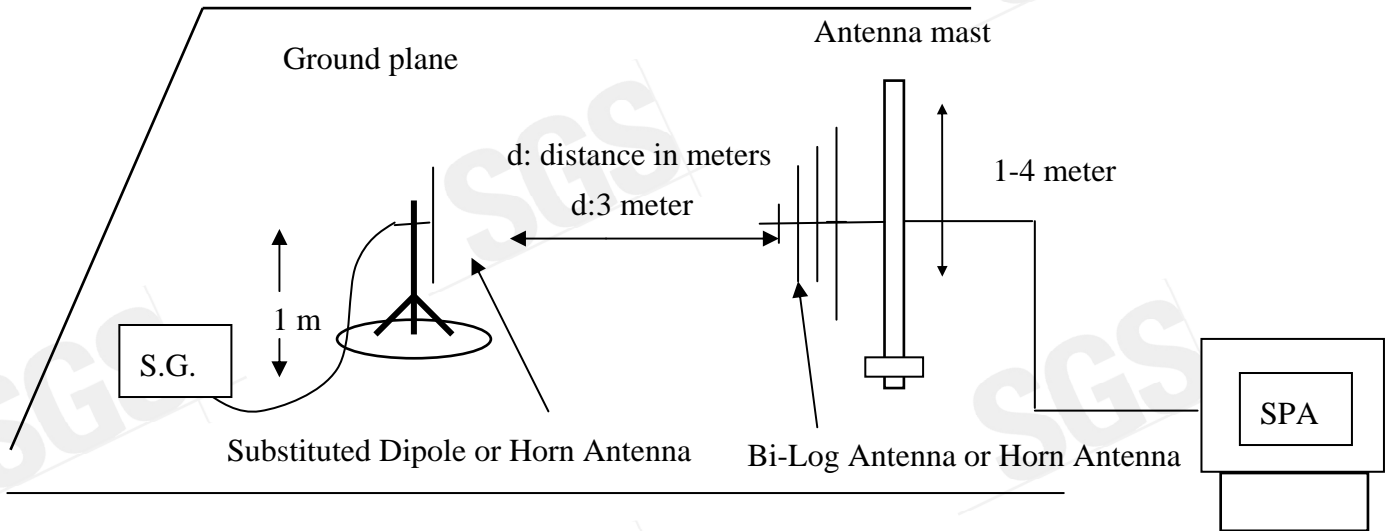

5.8. Measurement Procedure

The EUT was placed on a non-conductive, The measurement antenna was placed at a distance of 3 meters from the EUT. During the tests, the antenna height and the EUT azimuth were varied in order to identify the maximum level of emissions from the EUT. This maximization process was repeated with the EUT positioned in each of its three orthogonal orientations.

During the measurement, the EUT was communication with the station. The highest emission was recorded with the rotation of the turntable and the lowering of the test antenna from 4m to 1m. The reading was recorded and the field strength (E in dBuV/m) was calculated. And Peak detector was used during this test.

ERP in frequency band 824.2 –848.80.8MHz were measured using a substitution method. The EUT was replaced by dipole antenna connected, the S.G. output was recorded and ERP was calculated as follows:

EIRP in frequency band 1850.2 –1909.8MHz were measured using a substitution method. The EUT was replaced by or horn antenna connected, the S.G. output was recorded and EIRP was calculated as follows:

$$\text{ERP} = \text{S.G. output (dBm)} + \text{Antenna Gain (dBd)} - \text{Cable Loss (dB)}$$

$$\text{EIRP} = \text{S.G. output (dBm)} + \text{Antenna Gain (dBi)} - \text{Cable Loss (dB)}$$

5.9. Measurement Equipment Used:

EQUIPMENT TYPE	MFR	MODEL NUMBER	SERIAL NUMBER	LAST CAL.	CAL DUE.
Spectrum Analyzer	Agilent	E4446A	MY43360126	04/19/2008	04/18/2010
Spectrum Analyzer	Agilent	E7405A	US41160416	07/04/2007	07/03/2009
Spectrum Analyzer	R&S	FSP 40	100034	02/22/2008	02/21/2009
Communication Test	R&S	CMU200	102189	05/13/2008	05/12/2009
Bi-log Antenna	SCHWAZBECK	VULB9160	3224	11/29/2007	11/28/2008
Horn antenna	SCHWAZBECK	BBHA 9120D	309/320	03/14/2008	03/13/2009
Pre-Amplifier	HP	8447F	3113A06892	01/05/2008	01/04/2009
Pre-Amplifier	HP	8449B	3008A01973	01/05/2008	01/04/2009
Signal Generator	R&S	SMR40	100210	01/22/2008	01/21/2009
Turn Table	HD	DT420	N/A	N.C.R	N.C.R
Antenna Tower	HD	MA240-N	240/657	N.C.R	N.C.R
Controller	HD	HD100	N/A	N.C.R	N.C.R
Low Loss Cable	HUBER+SUHNER	SUCOFLEX 104PEA-10M	10m	02/13/2008	02/12/2009
Low Loss Cable	HUBER+SUHNER	SUCOFLEX 104PEA-3M	3m	02/13/2008	02/12/2009
Low Loss Cable	HUBER+SUHNER	SUCOFLEX 104PEA-0.5M	0.5m	02/13/2008	02/12/2009
Site NSA	SGS	966 chamber	N/A	11/17/2007	11/16/2008
Attenuator	Mini-Circuit	BW-S10W5	N/A	07/05/2008	07/04/2009
Dipole Antenna	SCHWAZBECK	VHAP	908/909	07/10/2008	07/10/2010
Dipole Antenna	SCHWAZBECK	UHAP	891/892	07/10/2008	07/10/2010

5.10. Measurement Result

EUT Mode	Frequency (MHz)	CH	EUT Pol.	Antenna Pol.	SPA Reading (dBuV)	S.G. Output (dBm)	Antenna Gain (dBd)	Cable Loss (dB)	ERP (dBm)	Limit (dBm)
GSM 850	824.20	128	H	V	122.09	35.70	-7.87	3.62	24.20	38.45
				H	128.27	42.00	-7.87	3.62	30.50	38.45
	836.60	190	H	V	121.87	35.62	-7.88	3.65	24.09	38.45
				H	128.17	41.94	-7.88	3.65	30.41	38.45
	848.80	251	H	V	122.98	36.86	-7.88	3.68	25.30	38.45
				H	128.96	42.77	-7.88	3.68	31.21	38.45

EUT Mode	Frequency (MHz)	CH	EUT Pol.	Antenna Pol.	SPA Reading (dBuV)	S.G. Output (dBm)	Antenna Gain (dBi)	Cable Loss (dB)	EIRP (dBm)	Limit (dBm)
PCS 1900	1850.20	512	H	V	116.73	12.34	9.90	5.56	16.68	33.00
				H	126.75	22.57	9.90	5.56	26.91	33.00
	1880.00	661	H	V	116.29	11.93	9.99	5.61	16.31	33.00
				H	127.46	23.32	9.99	5.61	27.69	33.00
	1909.80	810	H	V	116.01	11.68	10.08	5.66	16.10	33.00
				H	126.86	22.75	10.08	5.66	27.17	33.00

Note: Class 10, 1 slot was used during test.

Remark :

- (1) The RBW,VBW of SPA for frequency

 Below 1GHz was RBW=100 KHz, VBW=300KHz,
 Above 1GHz was RBW= 1MHz , VBW= 3MHz
- (2) Peak detector was used during test.

EUT Mode	Frequency (MHz)	CH	EUT Pol.	Antenna Pol.	SPA Reading (dBuV)	S.G. Output (dBm)	Antenna Gain (dBd)	Cable Loss (dB)	ERP (dBm)	Limit (dBm)
EDGE 850	824.20	128	H	V	114.97	28.58	-7.87	3.62	17.08	38.45
				H	123.42	37.15	-7.87	3.62	25.65	38.45
	836.60	190	H	V	114.73	28.48	-7.88	3.65	16.95	38.45
				H	122.72	36.49	-7.88	3.65	24.96	38.45
	848.80	251	H	V	114.14	28.02	-7.88	3.68	16.46	38.45
				H	123.66	37.47	-7.88	3.68	25.91	38.45

EUT Mode	Frequency (MHz)	CH	EUT Pol.	Antenna Pol.	SPA Reading (dBuV)	S.G. Output (dBm)	Antenna Gain (dBi)	Cable Loss (dB)	EIRP (dBm)	Limit (dBm)
EDGE 1900	1850.20	512	H	V	112.99	8.60	9.90	5.56	12.94	33.00
				H	121.57	17.39	9.90	5.56	21.73	33.00
	1880.00	661	H	V	113.15	8.79	9.99	5.61	13.17	33.00
				H	121.15	17.01	9.99	5.61	21.38	33.00
	1909.80	810	H	V	113.76	9.43	10.08	5.66	13.85	33.00
				H	120.95	16.84	10.08	5.66	21.26	33.00

Note: Class 10, 1 slot was used during test.

Remark :

- (1) The RBW,VBW of SPA for frequency
Below 1GHz was RBW=100 KHz, VBW=300KHz,
Above 1GHz was RBW= 1MHz , VBW= 3MHz
- (2) Peak detector was used during test.

6. 99% OCCUPIED BANDWIDTH MEASUREMENT

6.1. Standard Applicable

According to §FCC 2.1049.

6.2. Test Set-up:

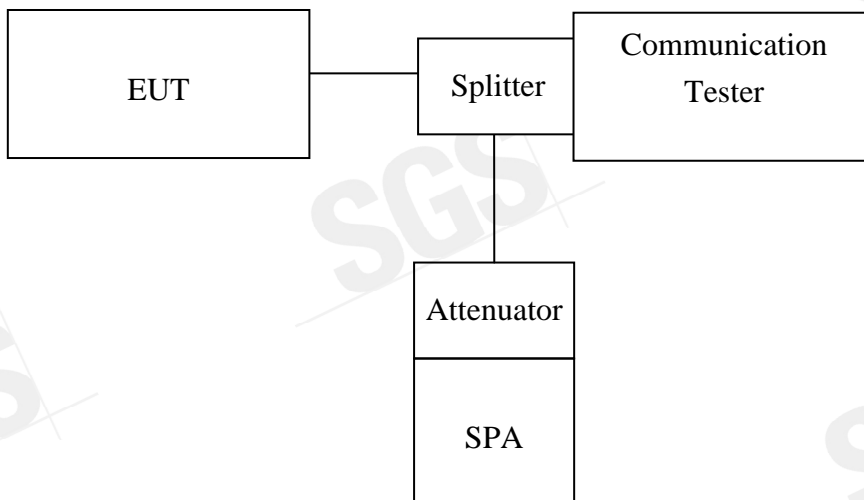

Note: Measurement setup for testing on Antenna connector

6.3. Measurement Procedure

The EUT's output RF connector was connected with a short cable to the spectrum analyzer, RBW (10/30KHz) was set to about 1% of emission BW, VBW= 3 times RBW(30/100KHz), -26dBc display line was placed on the screen (or 99% bandwidth), the occupied bandwidth is the delta frequency between the two points where the display line intersects the signal trace.

6.4. Measurement Equipment Used:

Conducted Emission Test Site					
EQUIPMENT TYPE	MFR	MODEL NUMBER	SERIAL NUMBER	LAST CAL.	CAL DUE.
Spectrum Analyzer	Agilent	E4446A	MY43360126	04/19/2008	04/18/2010
Spectrum Analyzer	Agilent	E7405A	US41160416	07/04/2007	07/03/2009
Spectrum Analyzer	R&S	FSP 40	100034	02/22/2008	02/21/2009
Communication Test	R&S	CMU200	102189	05/13/2008	05/12/2009
Power Sensor	Anritsu	MA2490A	31431	07/07/2007	07/06/2009
Power Meter	Anritsu	ML2487A	6K00002070	05/28/2008	05/27/2010
Temperature Chamber	TERCHY	MHG-120LF	911009	04/14/2008	04/13/2010
Low Loss Cable	HUBER+SUHNER	SUCOFLEX 104PEA	N/A	02/13/2008	02/12/2009
Attenuator	Mini-Circuit	BW-S10W5	N/A	07/05/2008	07/04/2009
Attenuator	Mini-Circuit	BW-S6W5	N/A	07/05/2008	07/04/2009
Splitter	Agilent	11636B	51818 / 51820	07/05/2008	07/04/2009
DC Power Supply	Agilent	6038A	2929A-07548	06/27/2007	06/26/2009

6.5. Measurement Result:.

EUT Mode	Frequency (MHz)	CH	99% Bandwidth (MHz)
GSM 850	824.20	128	0.2470
	836.60	190	0.2500
	848.80	251	0.2440

EUT Mode	Frequency (MHz)	CH	99% Bandwidth (MHz)
EDGE 850	824.20	128	0.2428
	836.60	190	0.2439
	848.80	251	0.2434

This document is issued by the Company subject to its General Conditions of Service which is available on request or accessible at www.sgs.com. Attention is drawn to the limitations of liability, indemnification and jurisdictional issues defined therein. Unless otherwise stated, the results shown in this test report refer only to the sample(s) tested. This document cannot be reproduced except in full, without prior approval of the Company. Any unauthorized alteration, forgery or falsification of the content or appearance of this report is unlawful and offenders may be prosecuted to the fullest extent of the law. 此報告是遵循本公司訂定之通用服務條款所製作發放，相關服務條款備索，或可在 www.sgs.com 中查閱，本公司之義務、免責、管轄權皆明確規範其中。除非另有說明，此報告結果僅對檢驗之樣品負責。本報告未經本公司書面許可，不可部份複製。對本報告內容或外觀之任何未經授權之變更、偽造、竄改皆屬非法，違犯者將會被依法追訴。

EUT Mode	Frequency (MHz)	CH	99% Bandwidth (MHz)
PCS 1900	1850.20	512	0.2410
	1880.00	661	0.2410
	1909.80	810	0.2460

EUT Mode	Frequency (MHz)	CH	99% Bandwidth (MHz)
EDGE 1900	1850.20	512	0.2449
	1880.00	661	0.2407
	1909.80	810	0.2468

This document is issued by the Company subject to its General Conditions of Service which is available on request or accessible at www.sgs.com. Attention is drawn to the limitations of liability, indemnification and jurisdictional issues defined therein. Unless otherwise stated, the results shown in this test report refer only to the sample(s) tested. This document cannot be reproduced except in full, without prior approval of the Company. Any unauthorized alteration, forgery or falsification of the content or appearance of this report is unlawful and offenders may be prosecuted to the fullest extent of the law. 此報告是遵循本公司訂定之通用服務條款所製作發放，相關服務條款備索，或可在 www.sgs.com 中查閱，本公司之義務、免責、管轄權皆明確規範其中。除非另有說明，此報告結果僅對檢驗之樣品負責。本報告未經本公司書面許可，不可部份複製。對本報告內容或外觀之任何未經授權之變更、偽造、竄改皆屬非法，違犯者將會被依法追訴。

Figure 7-1: GSM Channel Low

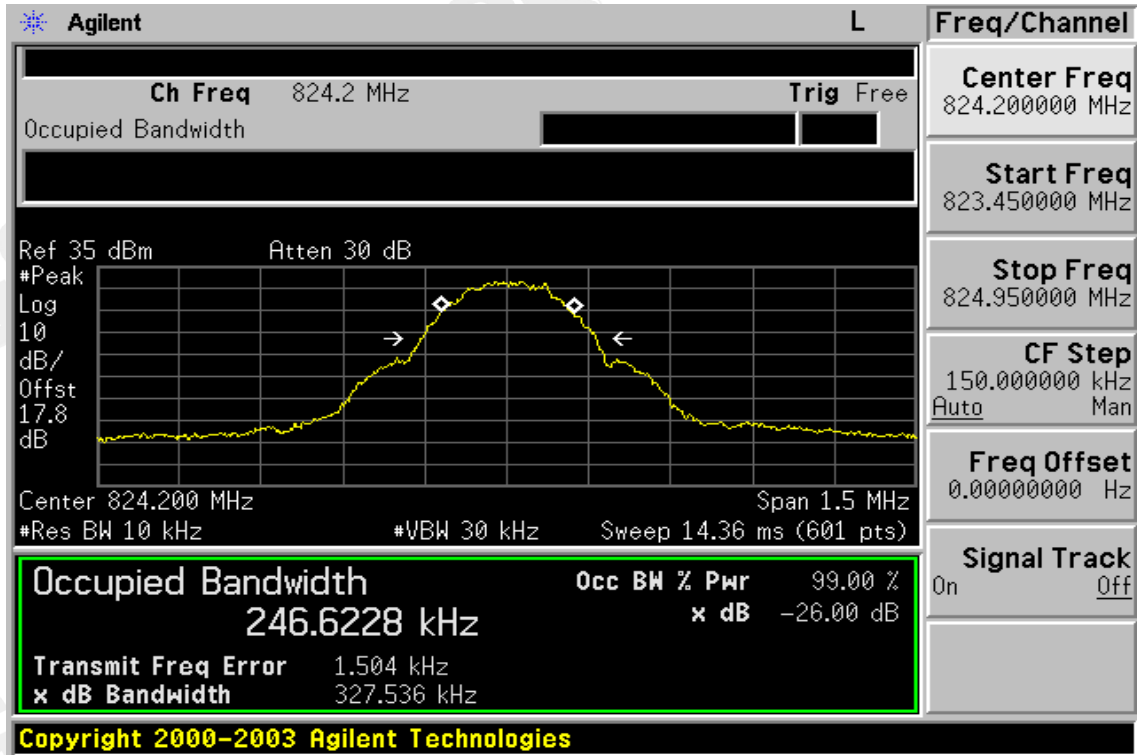

Figure 7-2 GSM Channel Mid

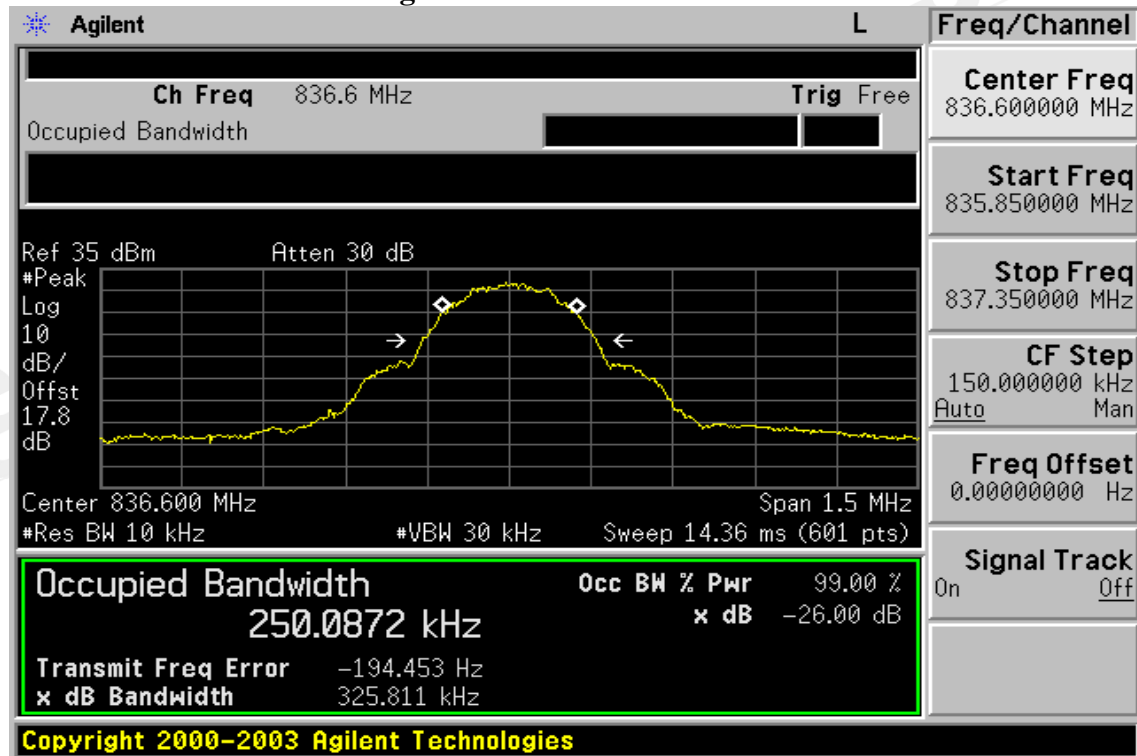

Figure 7-3: GSM Channel High

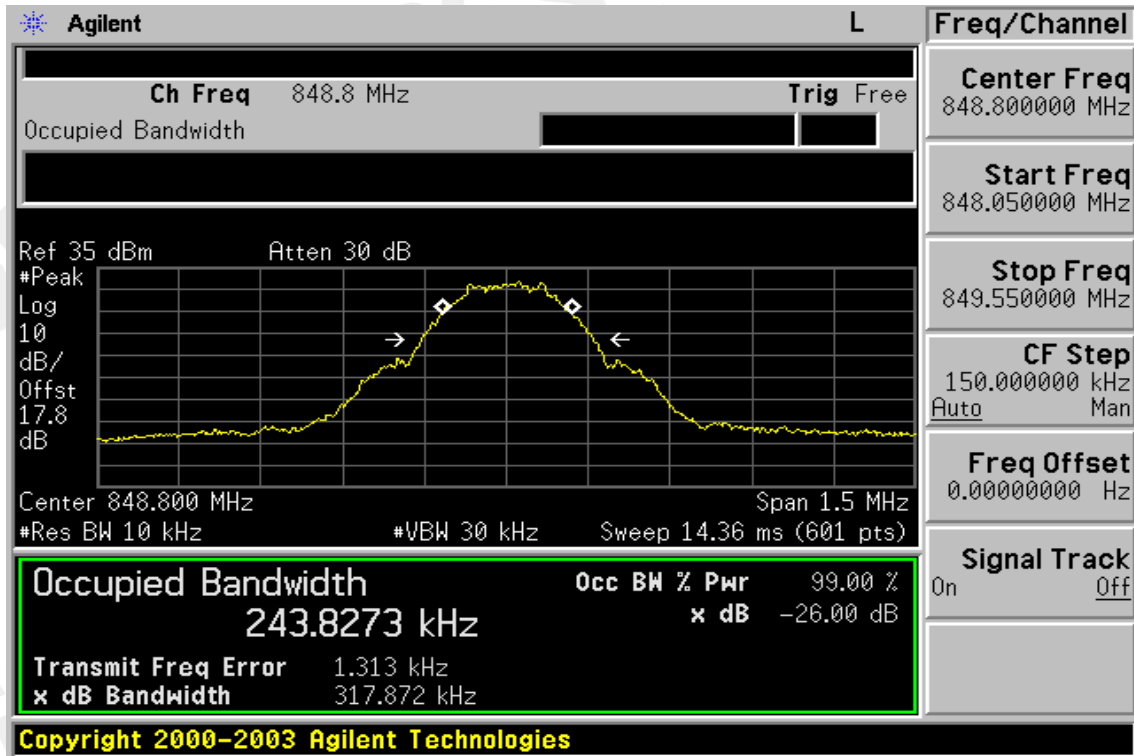

Figure 7-4: PCS Channel Low

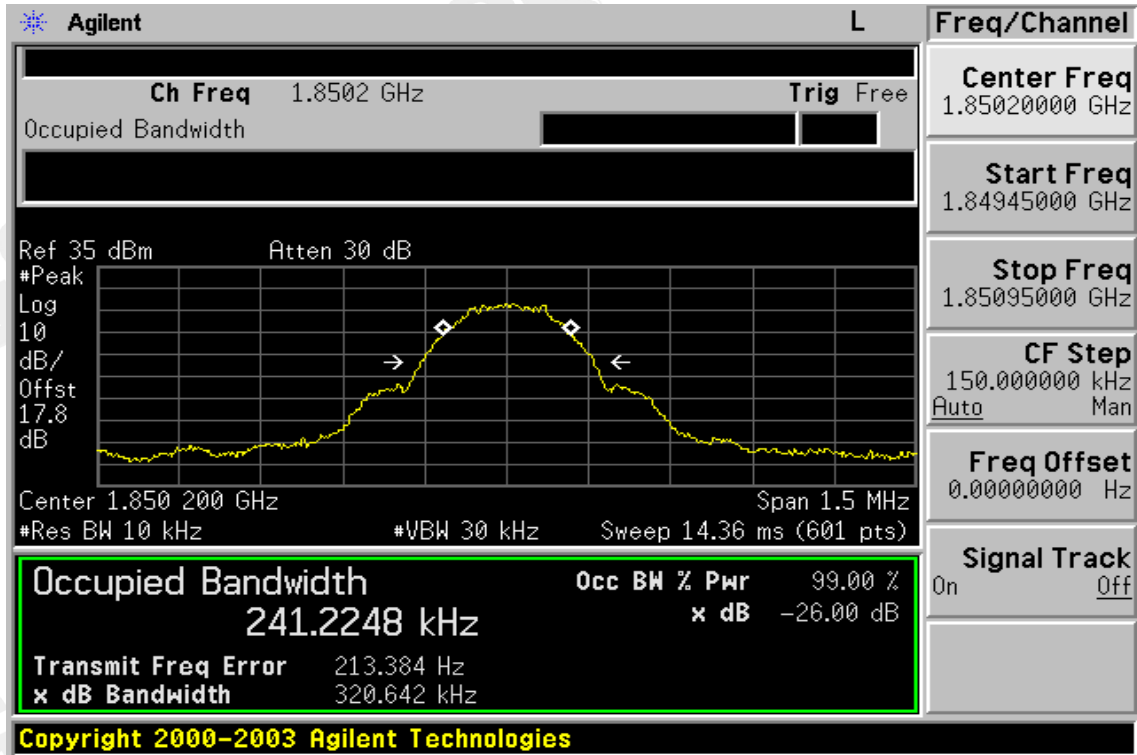

Figure 7-5 PCS Channel Mid

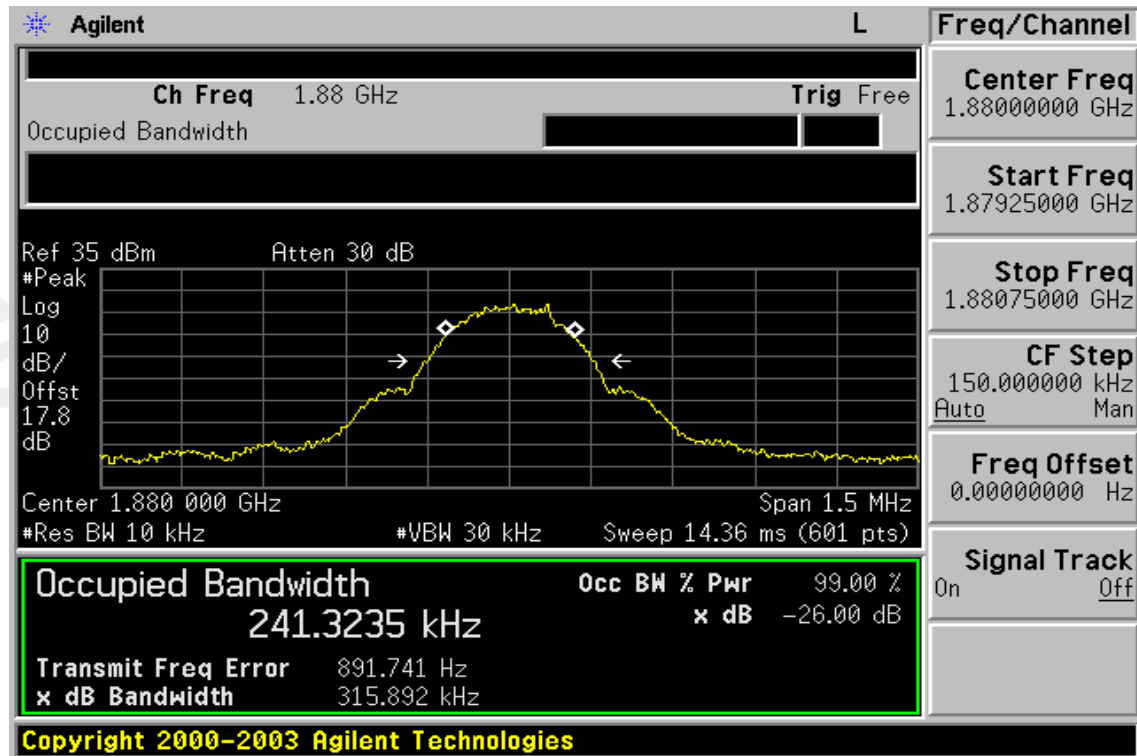

Figure 7-6: PCS Channel High

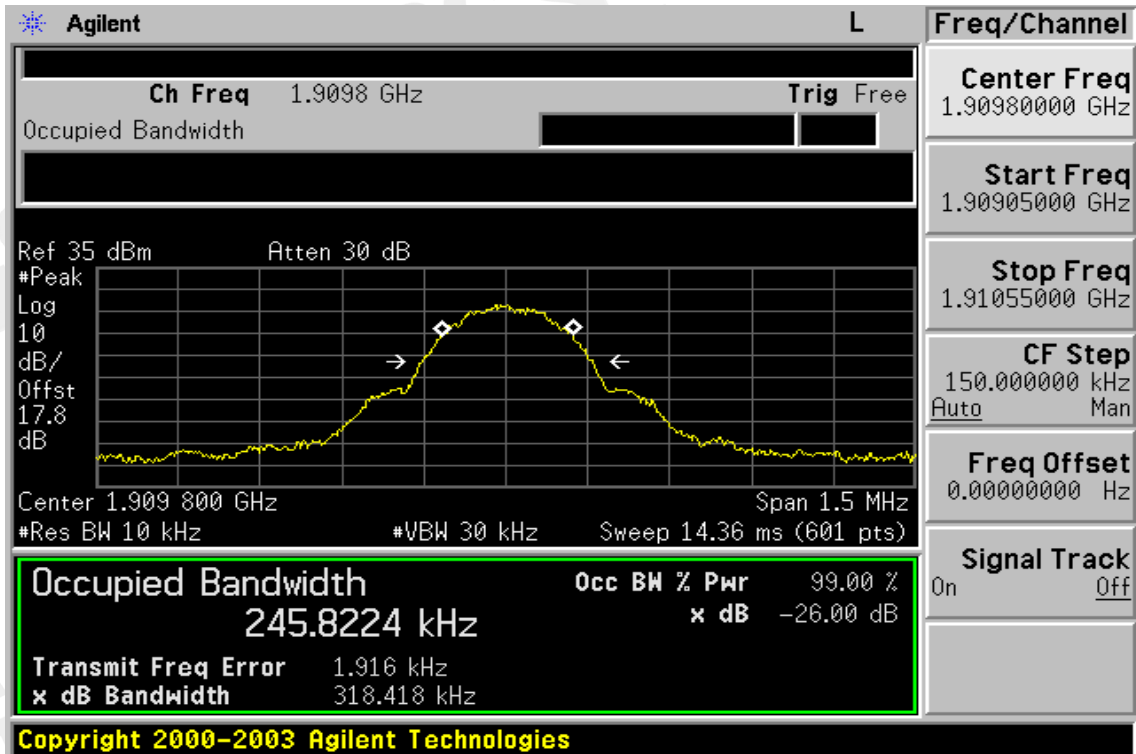

Figure 7-7: EDGE 850 Channel Low

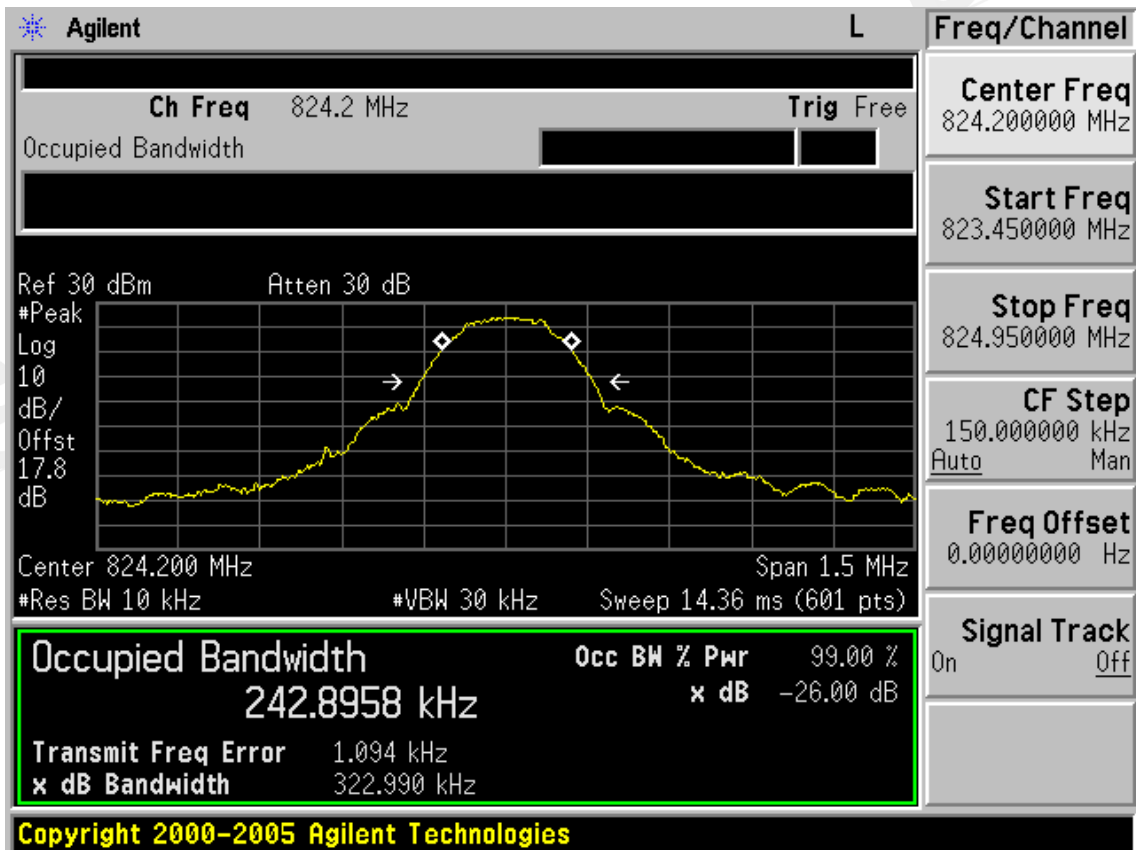

Figure 7-8 EDGE 850 Channel Mid

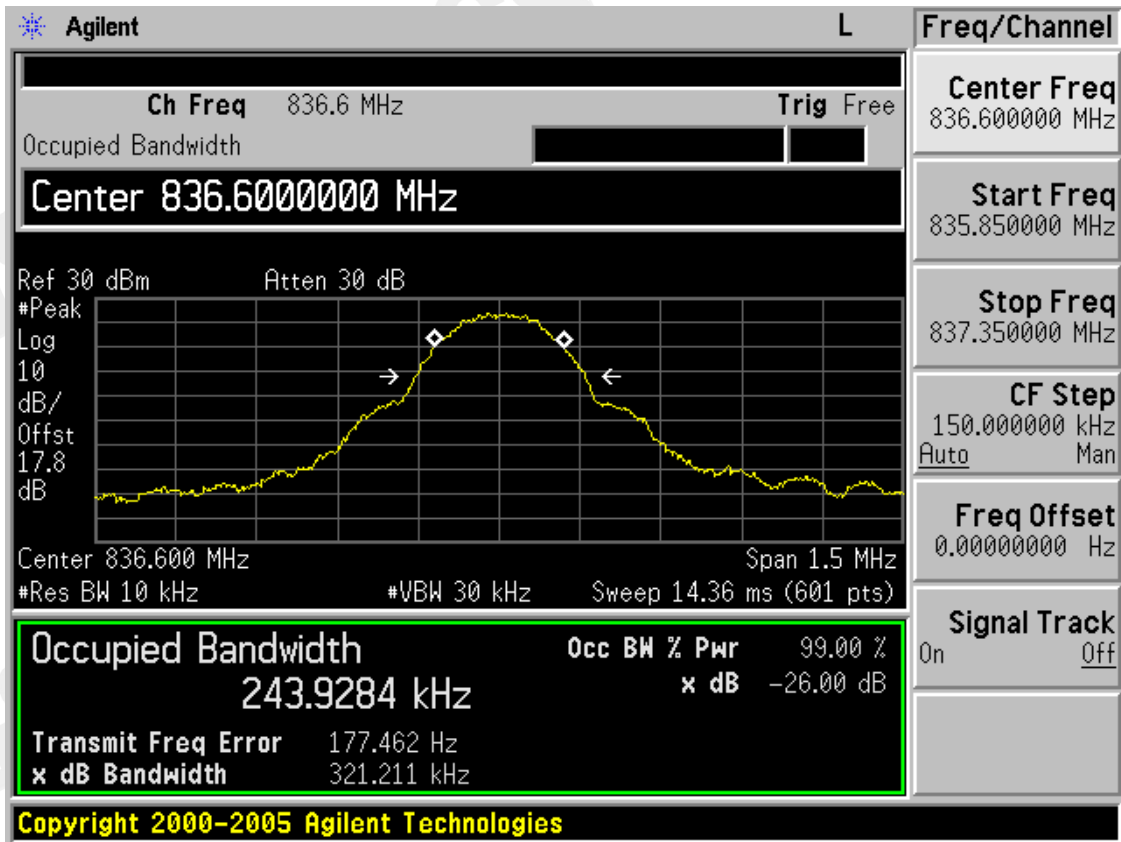

Figure 7-9: EDGE 850 Channel High

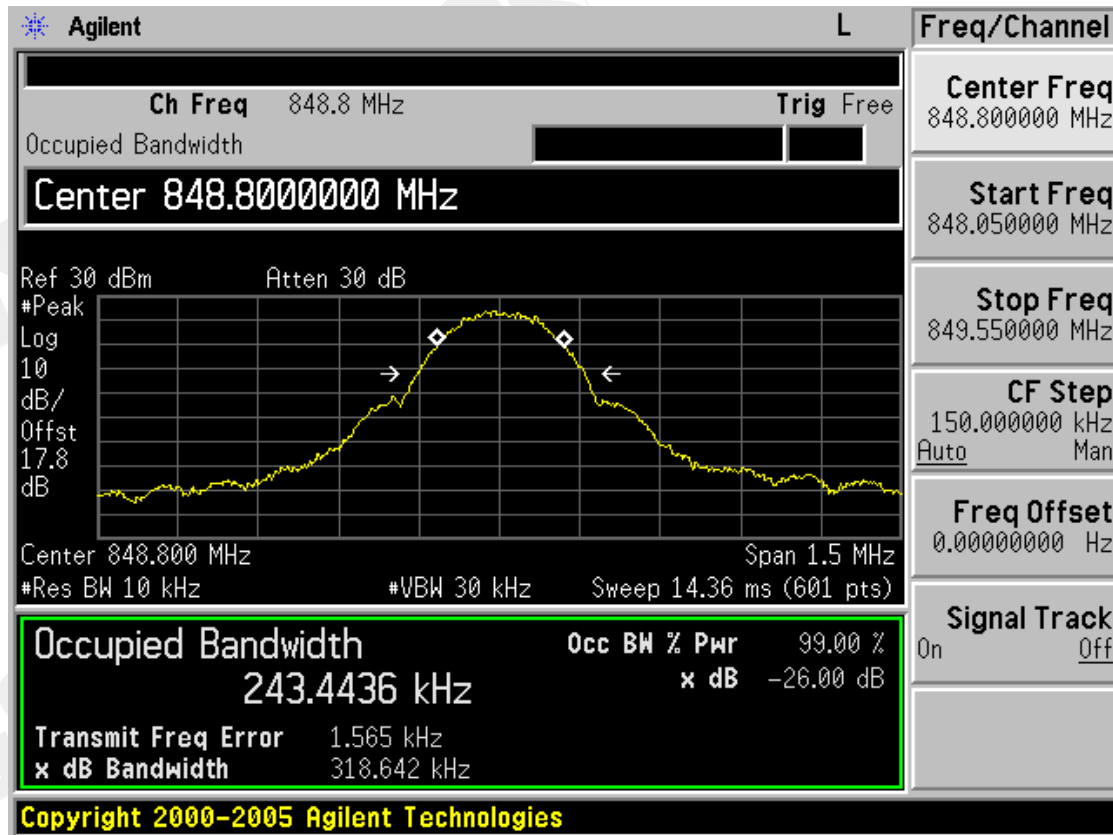

Figure 7-10: EDGE 1900 Channel Low

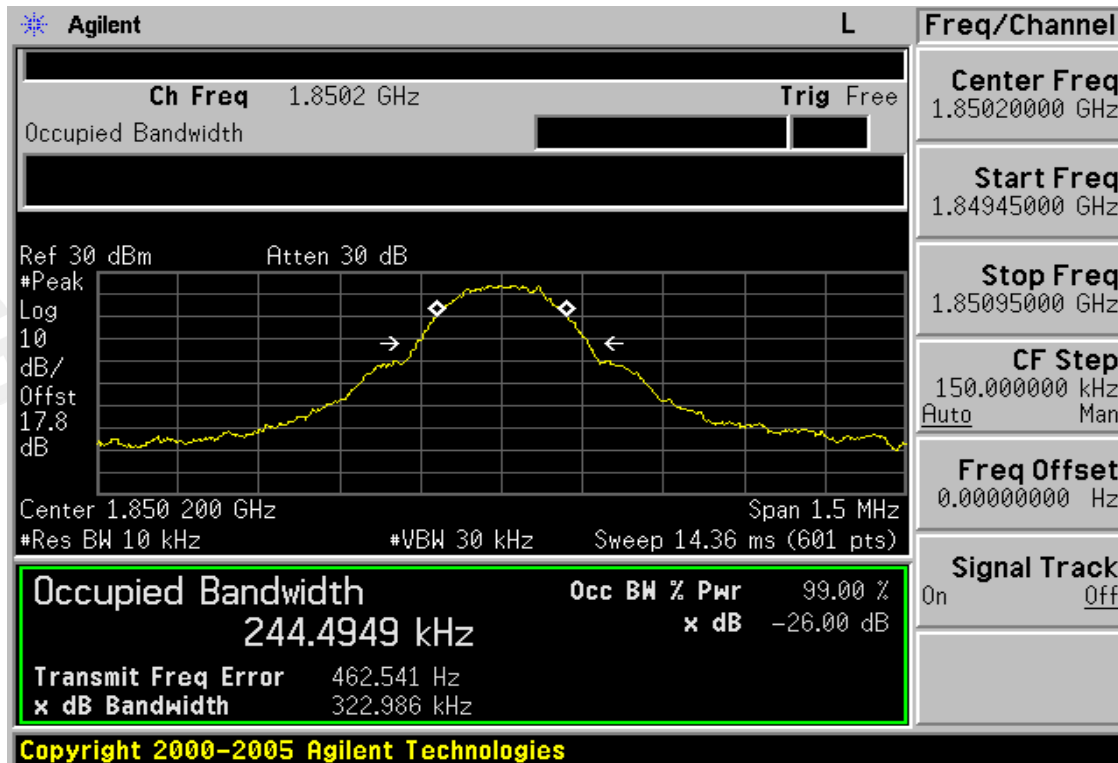

Figure 7-11 EDGE 1900 Channel Mid

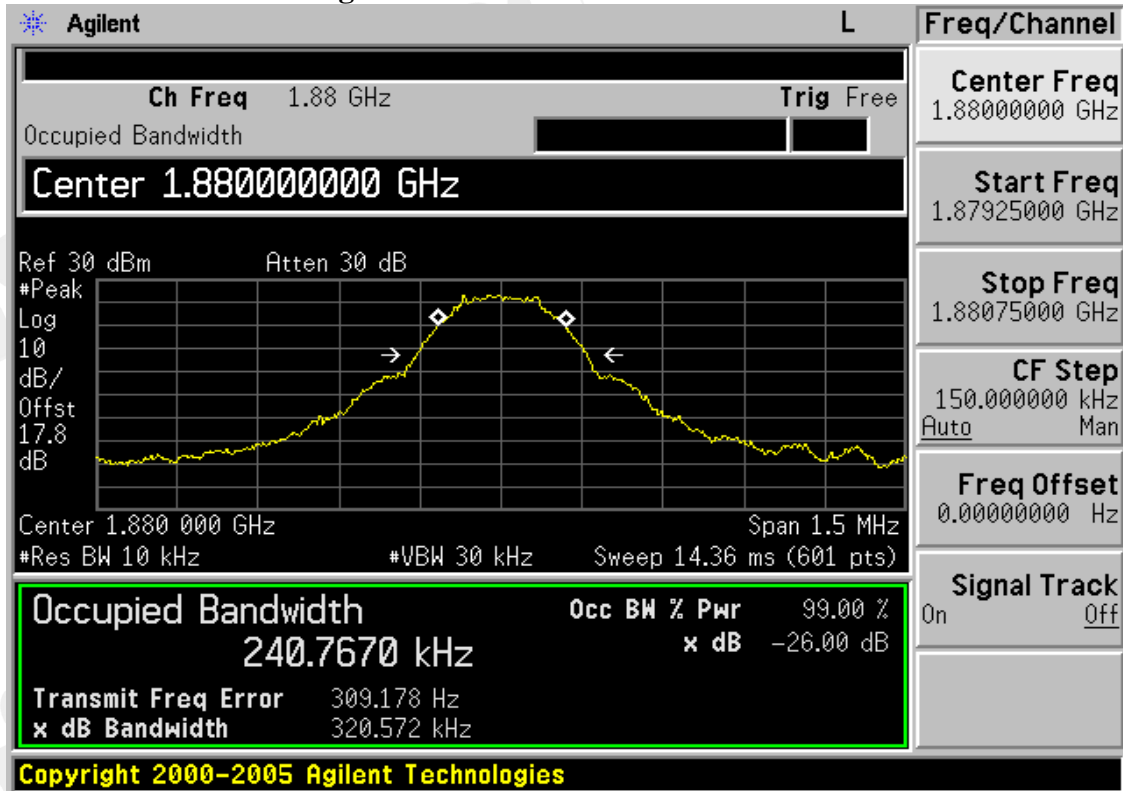
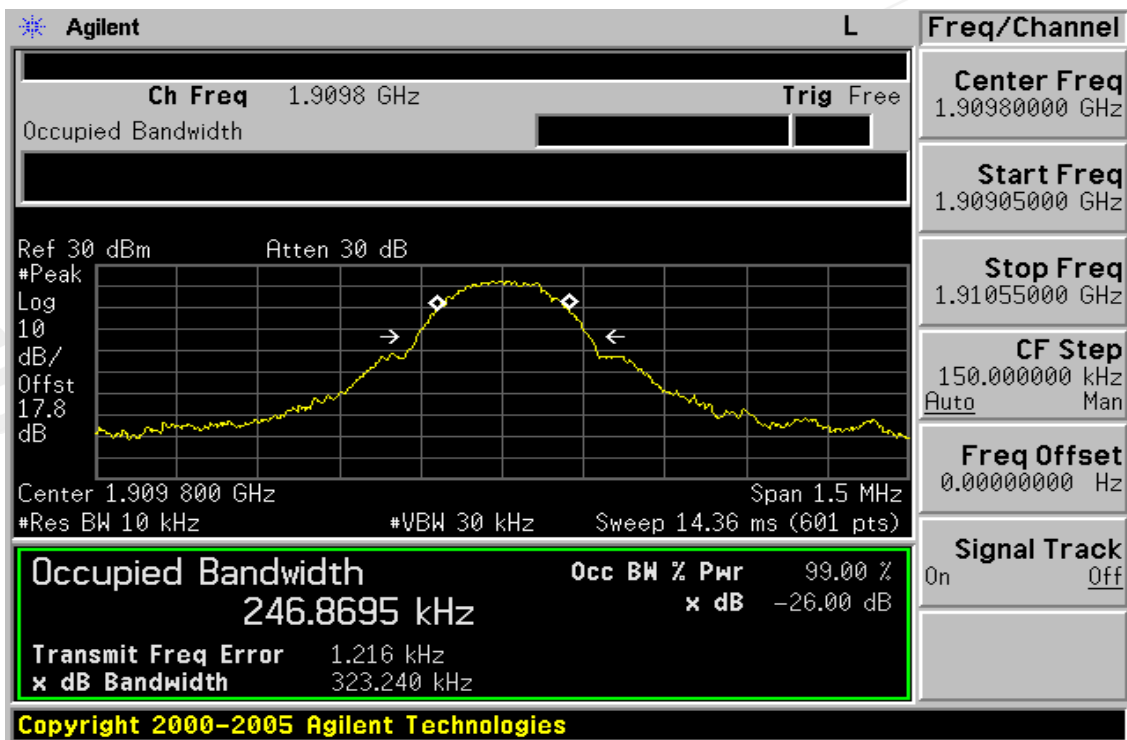

Figure 7-12: EDGE 1900 Channel High



7. OUT OF BAND EMISSION AT ANTENNA TERMINALS

7.1. Standard Applicable

According to FCC §2.1051.

FCC §22.917(a), §24.238(a), the magnitude of each spurious and harmonic emission that can be detected when the equipment is operated under the conditions specified in the instruction manual and/ or alignment procedure, shall not be less than $43 + 10 \log$ (mean output power in watts) dBc below the mean power output outside a license's frequency block (-13dBm)

7.2. Test SET-UP

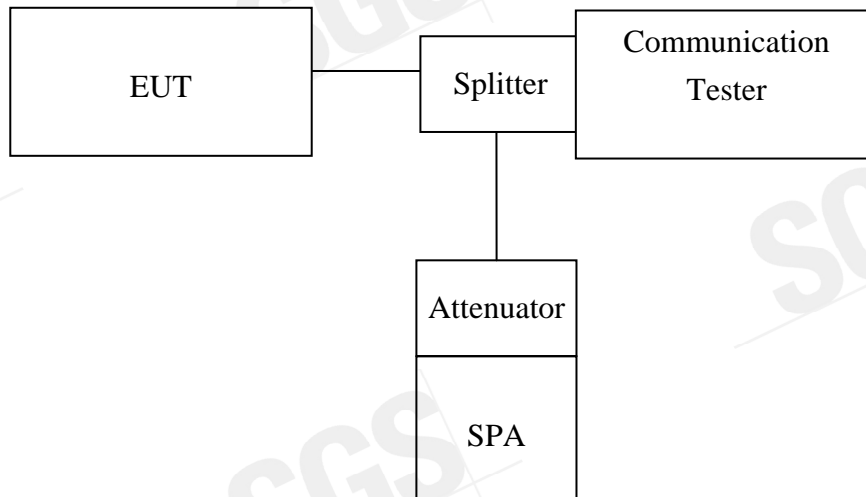

Note: Measurement setup for testing on Antenna connector

7.3. Measurement Procedure

The RF output of the transceiver was connected to a spectrum analyzer through appropriate attenuation. The resolution bandwidth of the spectrum analyzer was set at 1MHz, sufficient scans were taken to show the out of band Emissions if any up to 10th harmonic.

For the out of band: Set the RBW, VBW = 1MHz, Start=30MHz, Stop= 10th harmonic.
Limit = -13dBm

Band Edge Requirements: In the 1 MHz bands immediately outside and adjacent to the frequency block, a resolution bandwidth of at least 1 percent of the emission bandwidth of the fundamental emission of the transmitter may be employed to measure the out of band Emissions. Limit, -13dBm.

7.4. Measurement Equipment Used:

Conducted Emission Test Site					
EQUIPMENT TYPE	MFR	MODEL NUMBER	SERIAL NUMBER	LAST CAL.	CAL DUE.
Spectrum Analyzer	Agilent	E4446A	MY43360126	04/19/2008	04/18/2010
Spectrum Analyzer	Agilent	E7405A	US41160416	07/04/2007	07/03/2009
Spectrum Analyzer	R&S	FSP 40	100034	02/22/2008	02/21/2009
Communication Test	R&S	CMU200	102189	05/13/2008	05/12/2009
Power Sensor	Anritsu	MA2490A	31431	07/07/2007	07/06/2009
Power Meter	Anritsu	ML2487A	6K00002070	05/28/2008	05/27/2010
Temperature Chamber	TERCHY	MHG-120LF	911009	04/14/2008	04/13/2010
Low Loss Cable	HUBER+SUHNER	SUCOFLEX 104PEA	N/A	02/13/2008	02/12/2009
Attenuator	Mini-Circuit	BW-S10W5	N/A	07/05/2008	07/04/2009
Attenuator	Mini-Circuit	BW-S6W5	N/A	07/05/2008	07/04/2009
Splitter	Agilent	11636B	51818 / 51820	07/05/2008	07/04/2009
DC Power Supply	Agilent	6038A	2929A-07548	06/27/2007	06/26/2009

7.5. Measurement Result

Figure 8-1: Out of Band emission at antenna terminals– GSM Channel Lowest

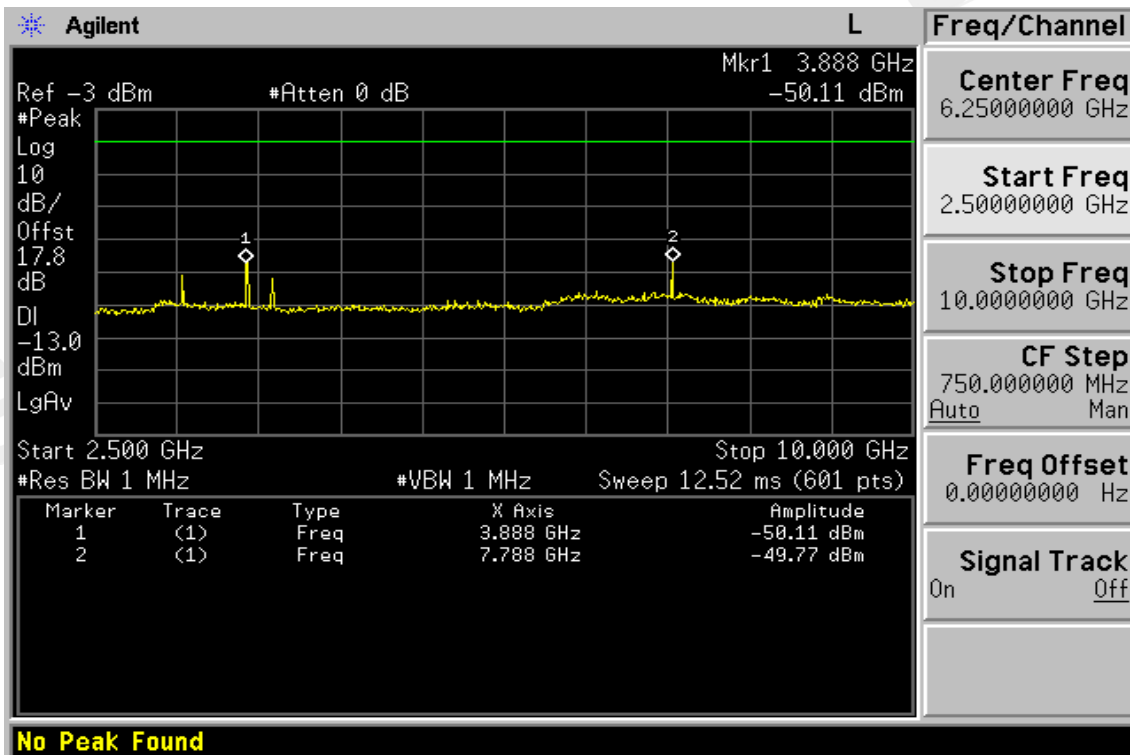
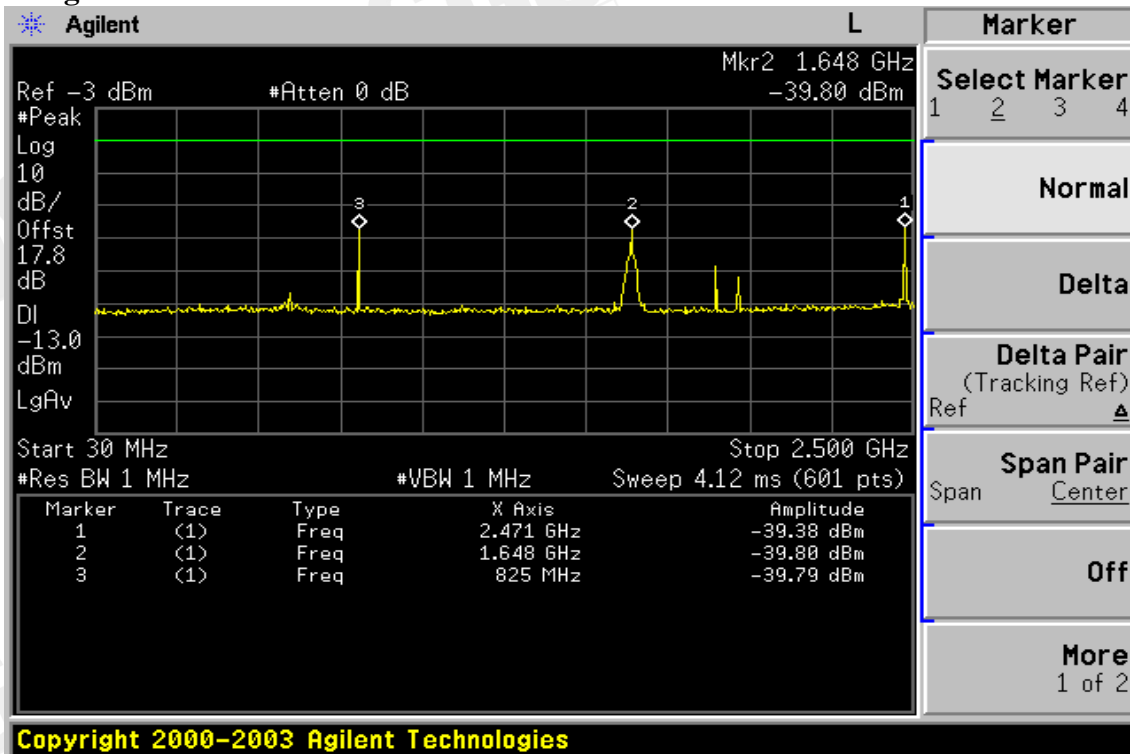

This document is issued by the Company subject to its General Conditions of Service which is available on request or accessible at www.sgs.com. Attention is drawn to the limitations of liability, indemnification and jurisdictional issues defined therein. Unless otherwise stated, the results shown in this test report refer only to the sample(s) tested. This document cannot be reproduced except in full, without prior approval of the Company. Any unauthorized alteration, forgery or falsification of the content or appearance of this report is unlawful and offenders may be prosecuted to the fullest extent of the law. 此報告是遵循本公司訂定之通用服務條款所製作發給，相關服務條款備索，或可在 www.sgs.com 中查閱，本公司之義務、免責、管轄權皆明確規範其中。除非另有說明，此報告結果僅對檢驗之樣品負責。本報告未經本公司書面許可，不可部份複製。對本報告內容或外觀之任何未經授權之變更、偽造、竄改皆屬非法，違犯者將會被依法追訴。

Figure 8-2: Out of Band emission at antenna terminals –GSM Channel Mid

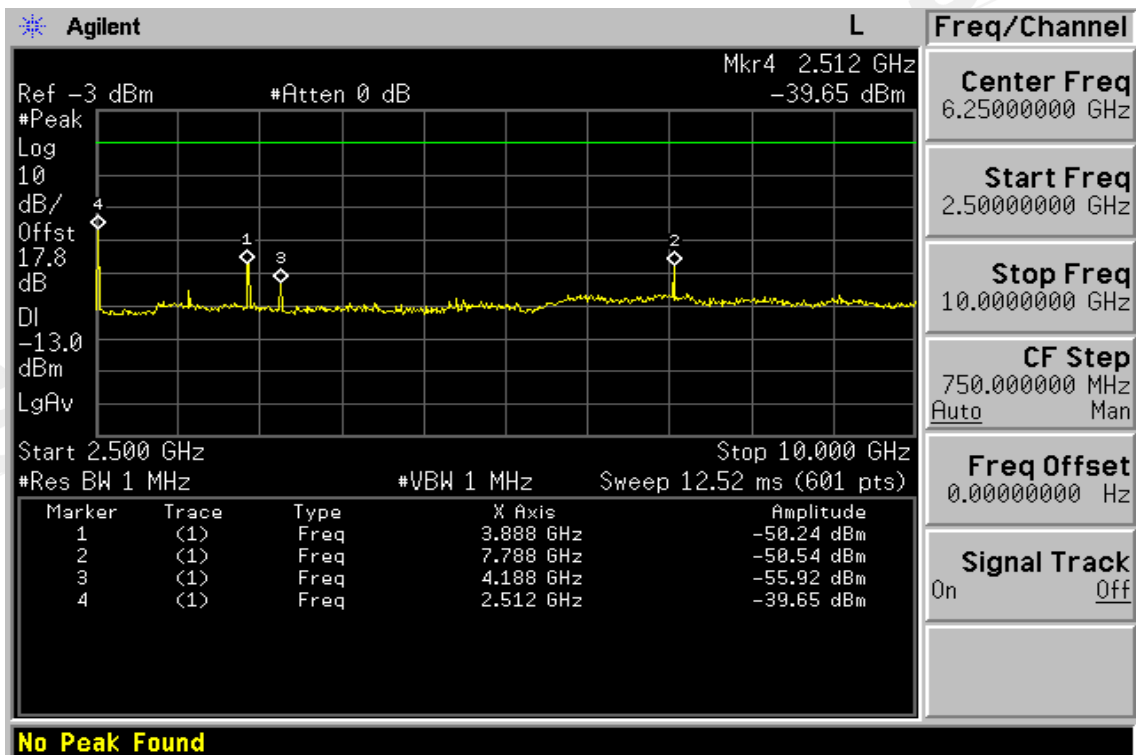
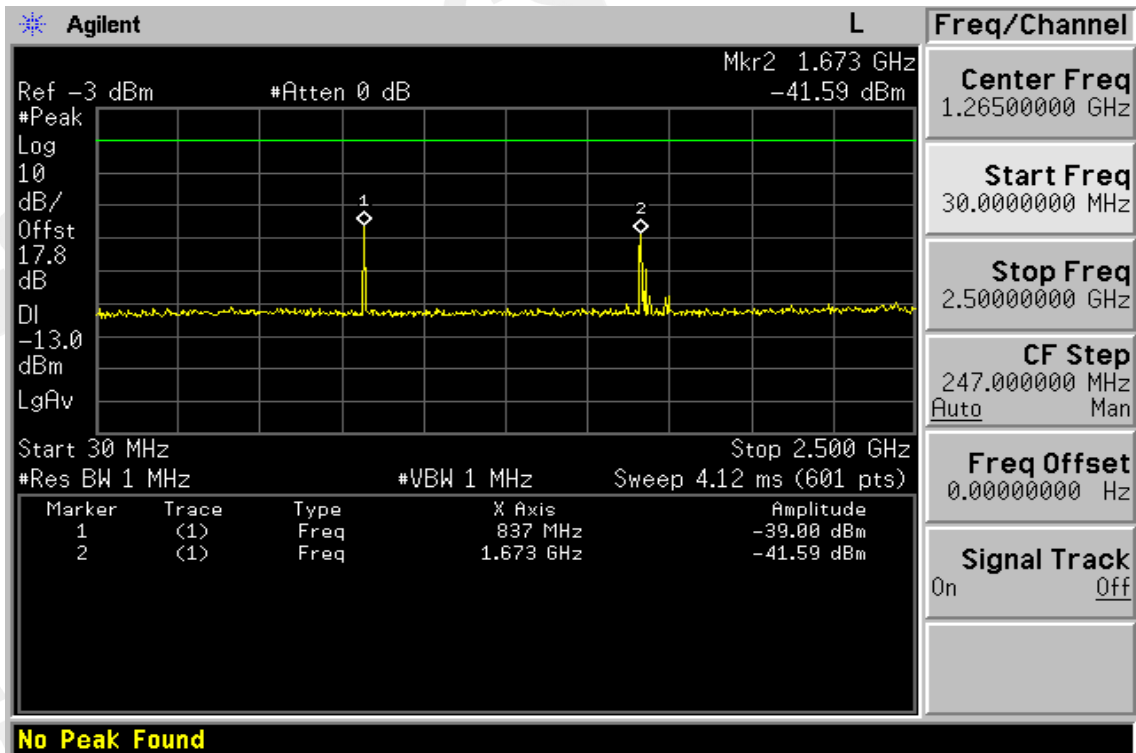

This document is issued by the Company subject to its General Conditions of Service which is available on request or accessible at www.sgs.com. Attention is drawn to the limitations of liability, indemnification and jurisdictional issues defined therein. Unless otherwise stated, the results shown in this test report refer only to the sample(s) tested. This document cannot be reproduced except in full, without prior approval of the Company. Any unauthorized alteration, forgery or falsification of the content or appearance of this report is unlawful and offenders may be prosecuted to the fullest extent of the law. 此報告是遵循本公司訂定之通用服務條款所製作發給，相關服務條款備索，或可在 www.sgs.com 中查閱，本公司之義務、免責、管轄權皆明確規範其中。除非另有說明，此報告結果僅對檢驗之樣品負責。本報告未經本公司書面許可，不可部份複製。對本報告內容或外觀之任何未經授權之變更、偽造、竄改皆屬非法，違犯者將會被依法追訴。

Figure 8-3: Out of Band emission at antenna terminals–GSM Channel Highest

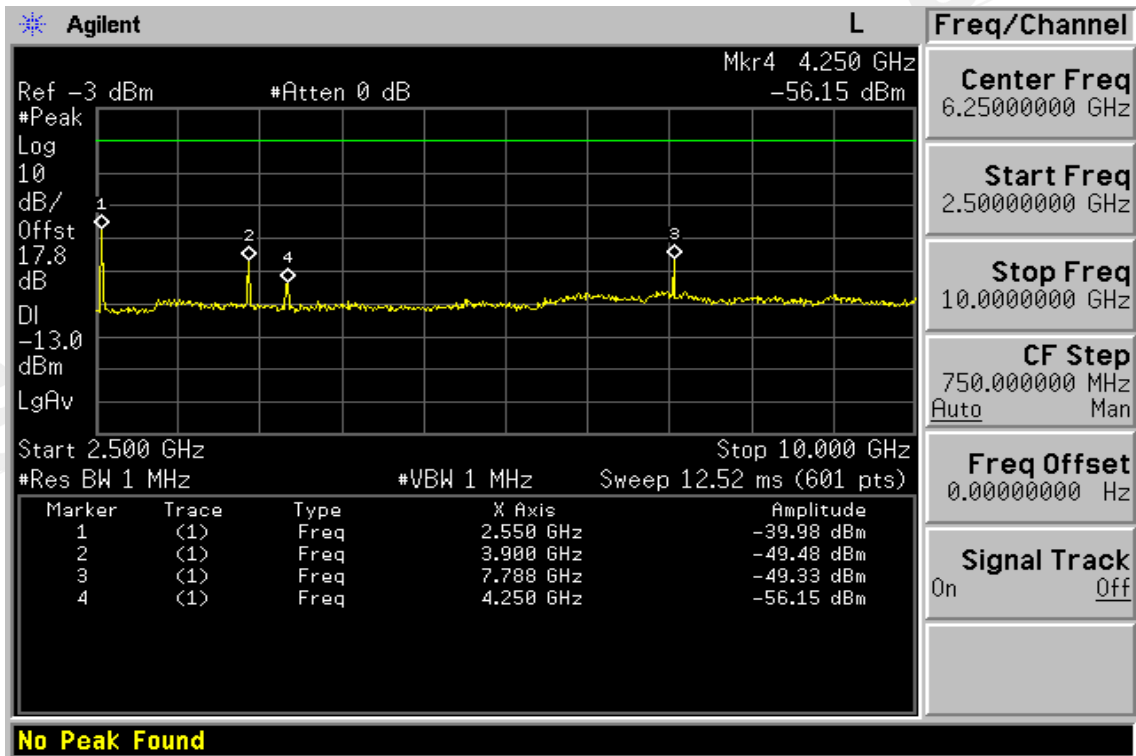
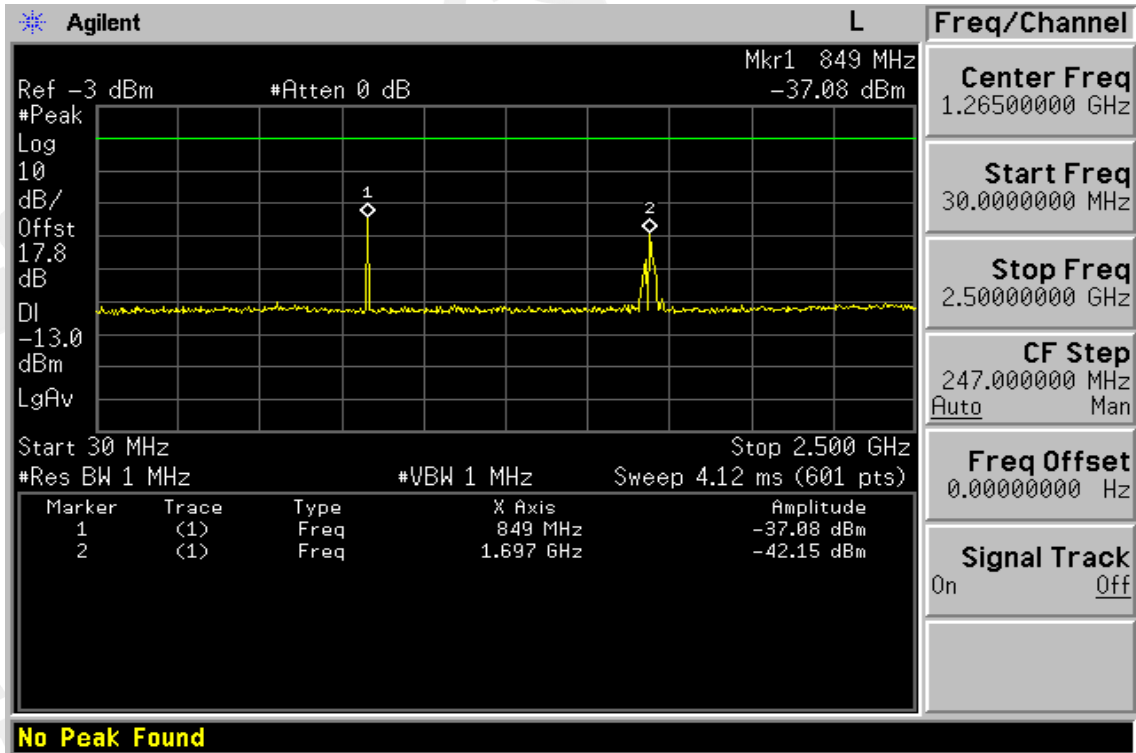

This document is issued by the Company subject to its General Conditions of Service which is available on request or accessible at www.sgs.com. Attention is drawn to the limitations of liability, indemnification and jurisdictional issues defined therein. Unless otherwise stated, the results shown in this test report refer only to the sample(s) tested. This document cannot be reproduced except in full, without prior approval of the Company. Any unauthorized alteration, forgery or falsification of the content or appearance of this report is unlawful and offenders may be prosecuted to the fullest extent of the law. 此報告是遵循本公司訂定之通用服務條款所製作發給，相關服務條款備索，或可在 www.sgs.com 中查閱，本公司之義務、免責、管轄權皆明確規範其中。除非另有說明，此報告結果僅對檢驗之樣品負責。本報告未經本公司書面許可，不可部份複製。對本報告內容或外觀之任何未經授權之變更、偽造、竄改皆屬非法，違犯者將會被依法追訴。

Figure 8-4: Bad edge emission at antenna terminals – GSM Channel Lowest

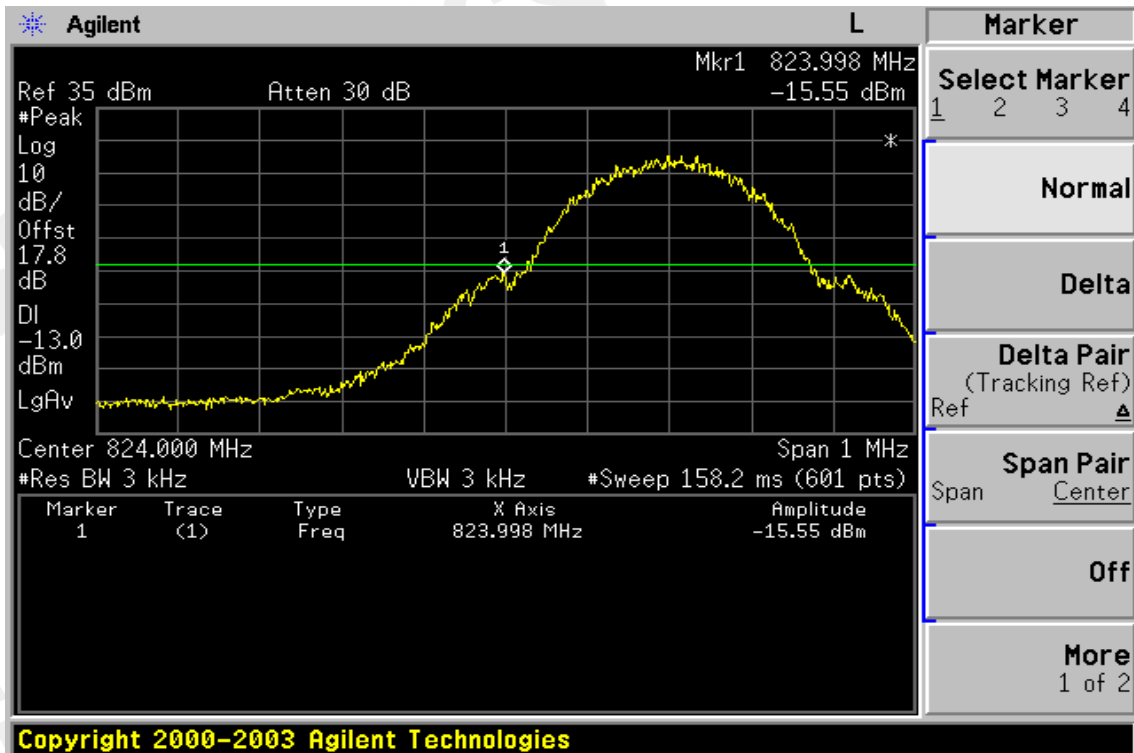

Figure 8-5: Band edge emission at antenna terminals – GSM Channel Highest

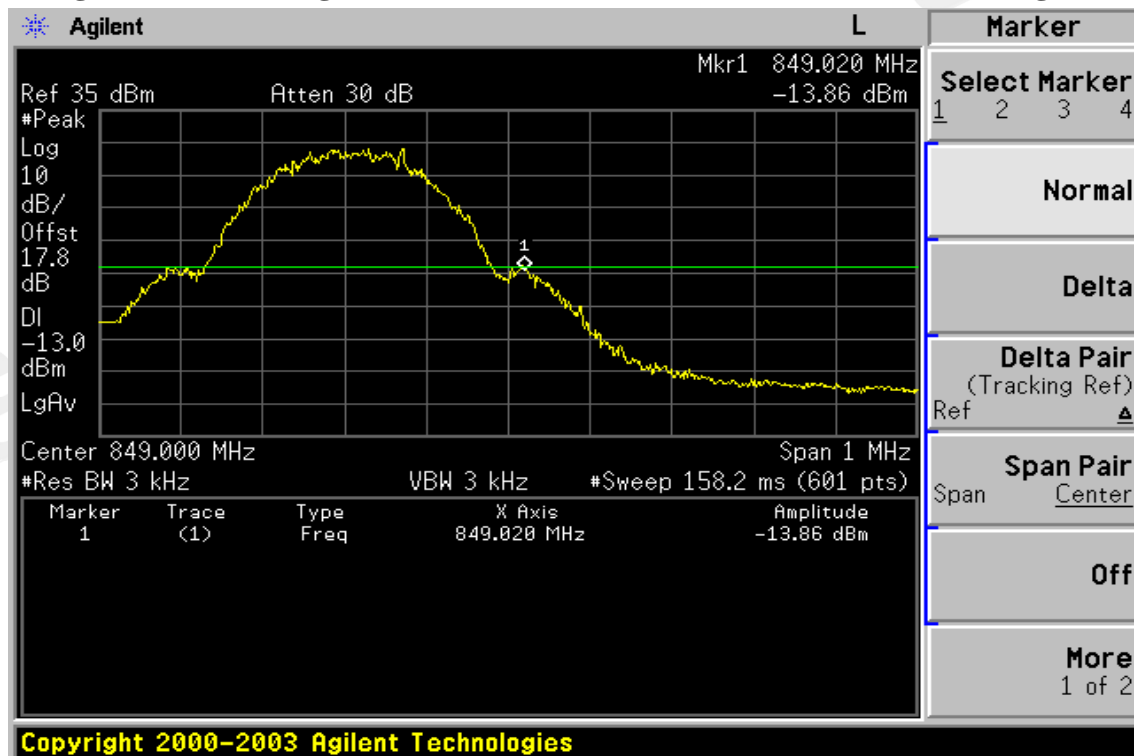

Figure 8-6: Out of Band emission at antenna terminals– PCS Channel Lowest

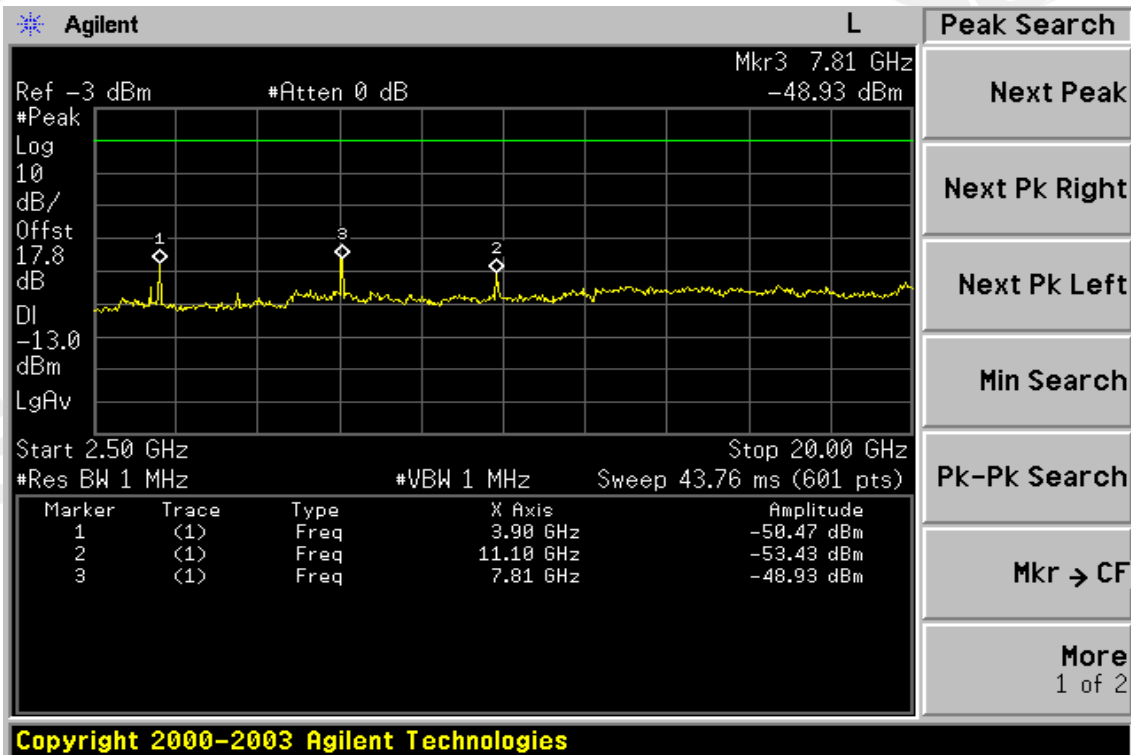
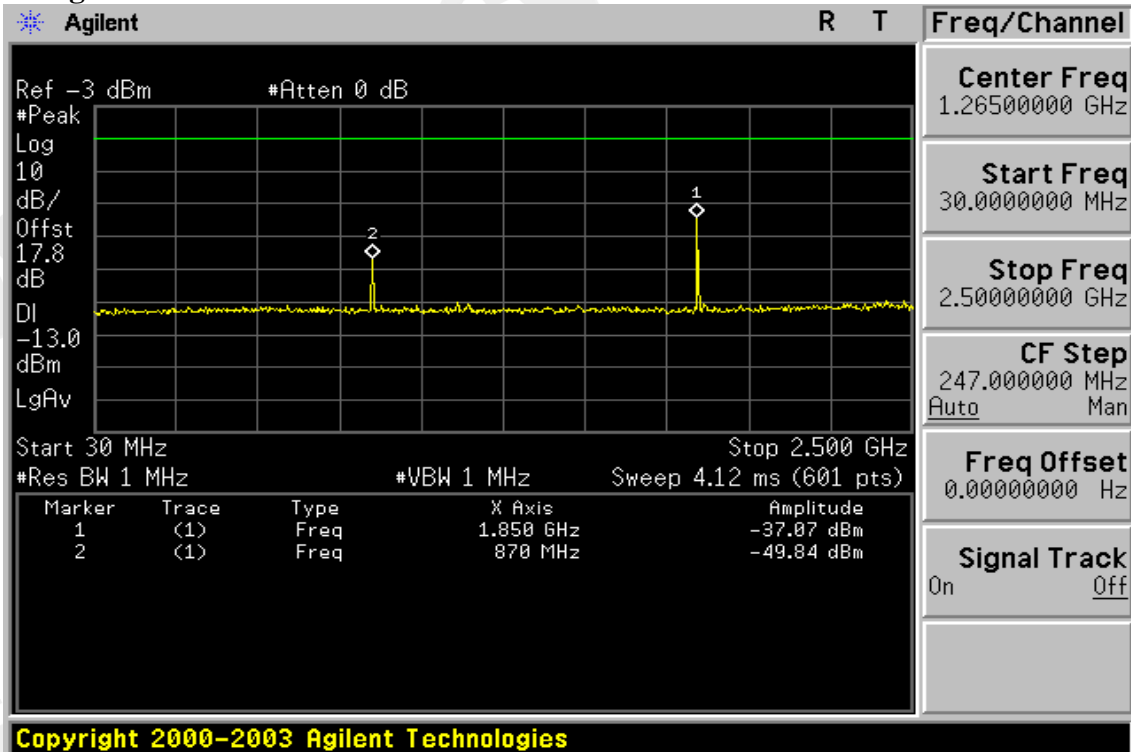

Figure 8-7: Out of Band emission at antenna terminals –PCS Channel Mid

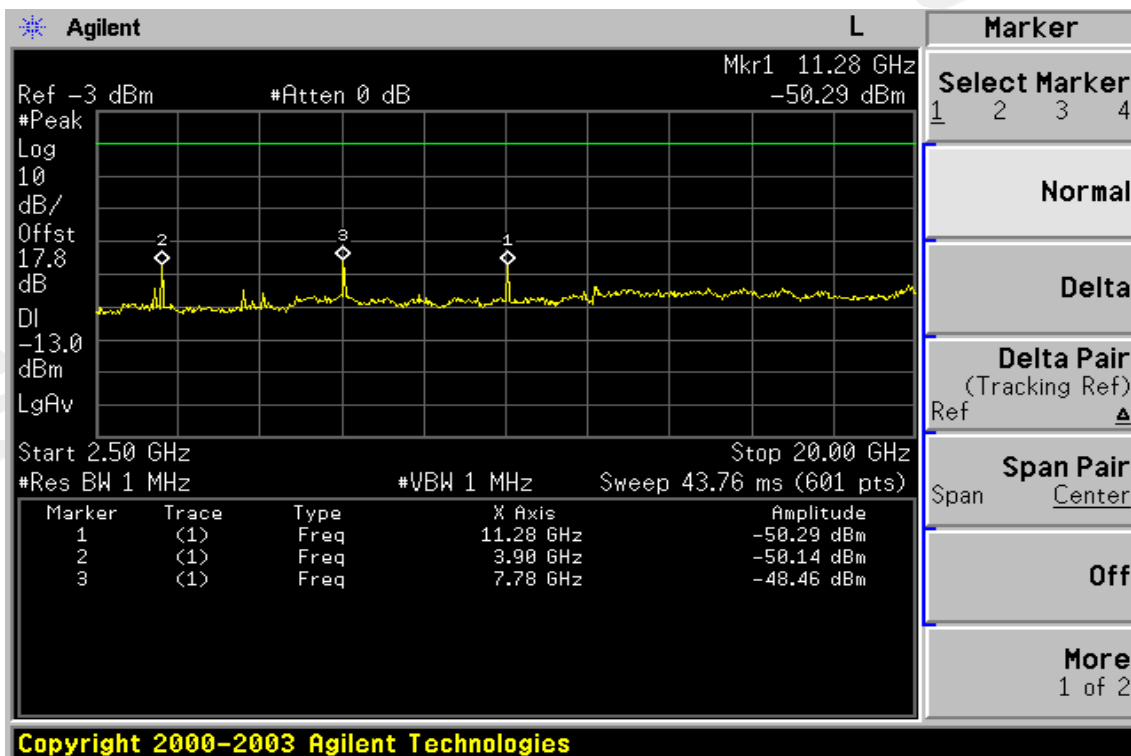
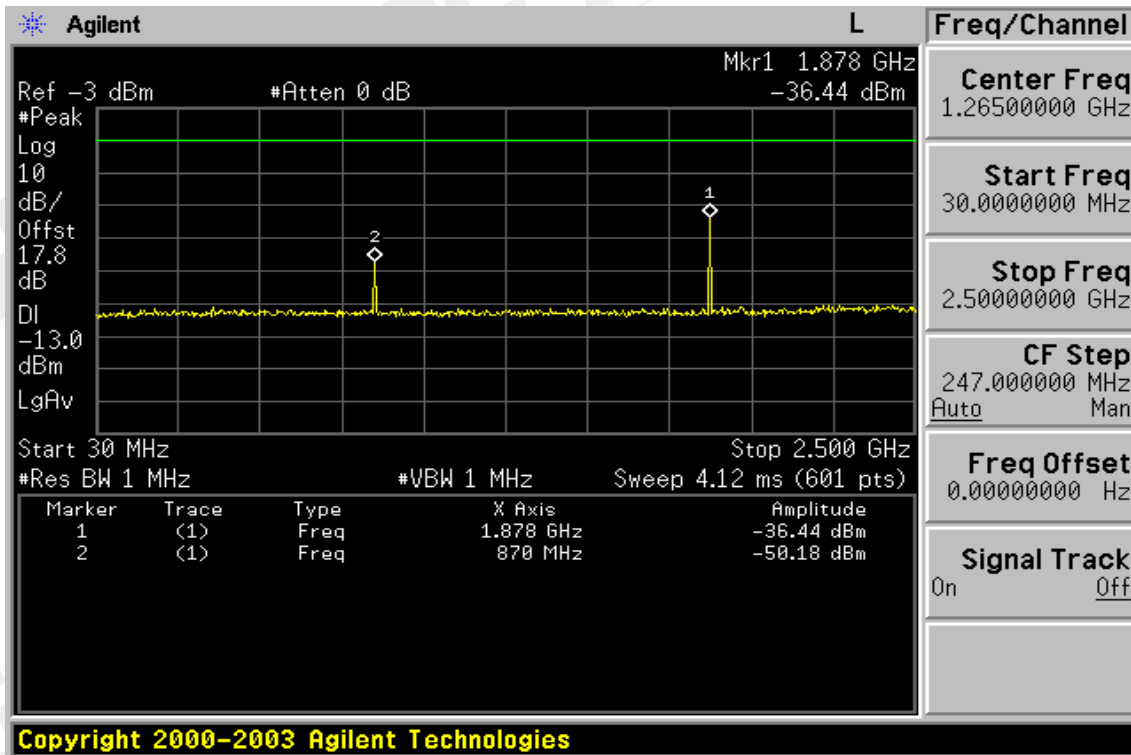
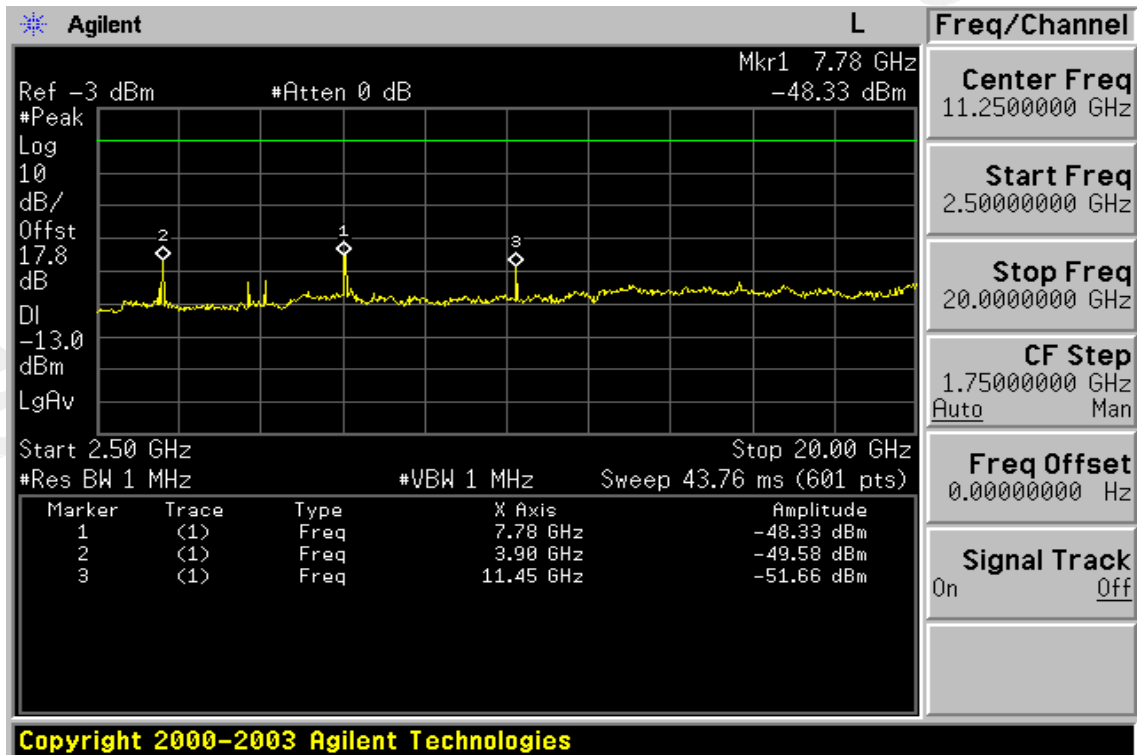
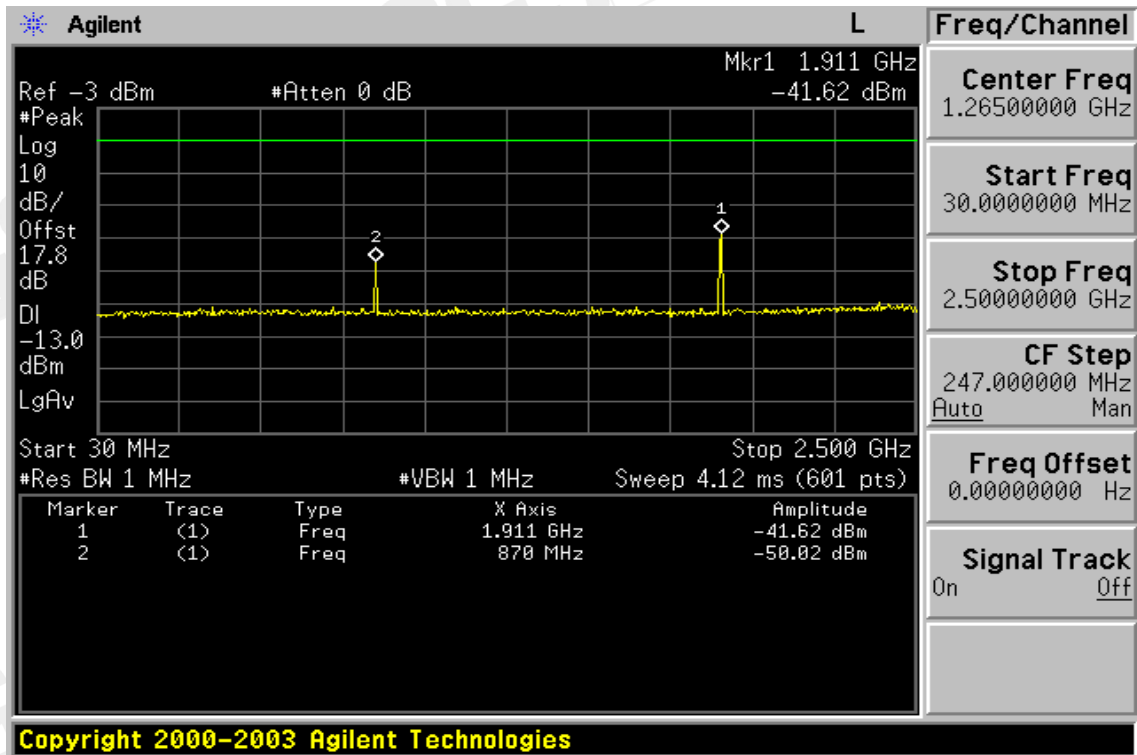

Figure 8-8: Out of Band emission at antenna terminals–PCS Channel Highest



This document is issued by the Company subject to its General Conditions of Service which is available on request or accessible at www.sgs.com. Attention is drawn to the limitations of liability, indemnification and jurisdictional issues defined therein. Unless otherwise stated, the results shown in this test report refer only to the sample(s) tested. This document cannot be reproduced except in full, without prior approval of the Company. Any unauthorized alteration, forgery or falsification of the content or appearance of this report is unlawful and offenders may be prosecuted to the fullest extent of the law. 此報告是遵循本公司訂定之通用服務條款所製作發給，相關服務條款備索，或可在 www.sgs.com 中查閱，本公司之義務、免責、管轄權皆明確規範其中。除非另有說明，此報告結果僅對檢驗之樣品負責。本報告未經本公司書面許可，不可部份複製。對本報告內容或外觀之任何未經授權之變更、偽造、竄改皆屬非法，違犯者將會被依法追訴。

Figure 8-9: Band edge emission at antenna terminals – PCS Channel Lowest

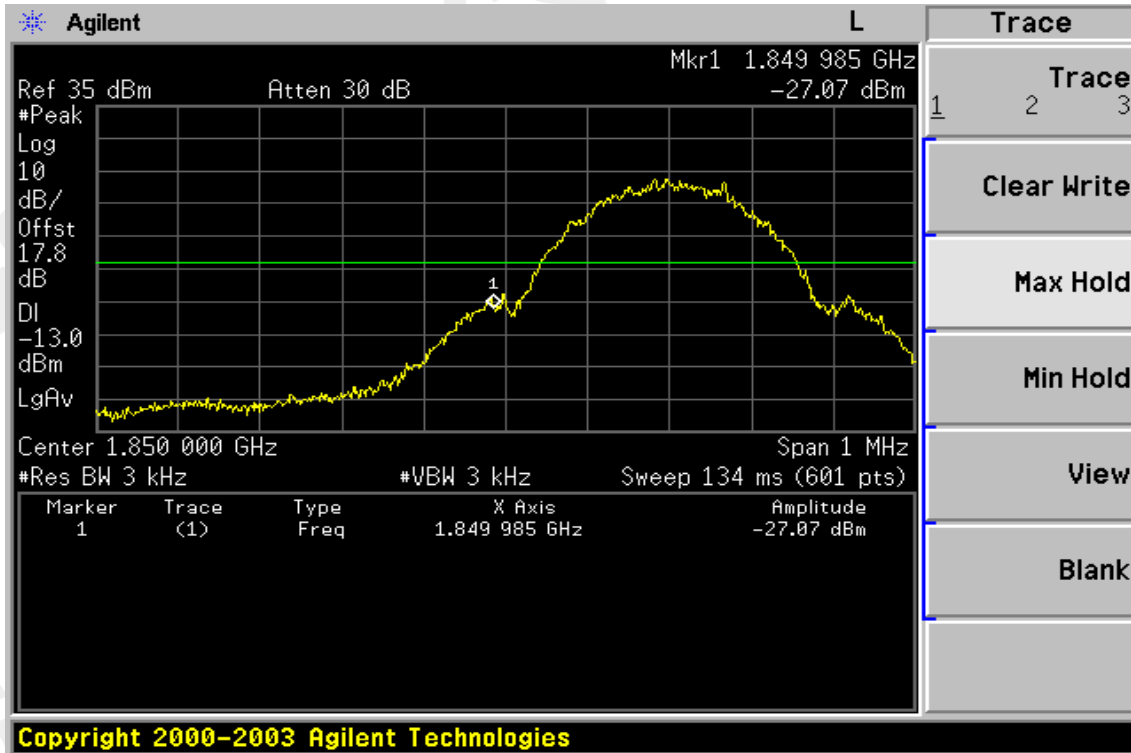

Figure 8-10: Band edge emission at antenna terminals – PCS Channel Highest

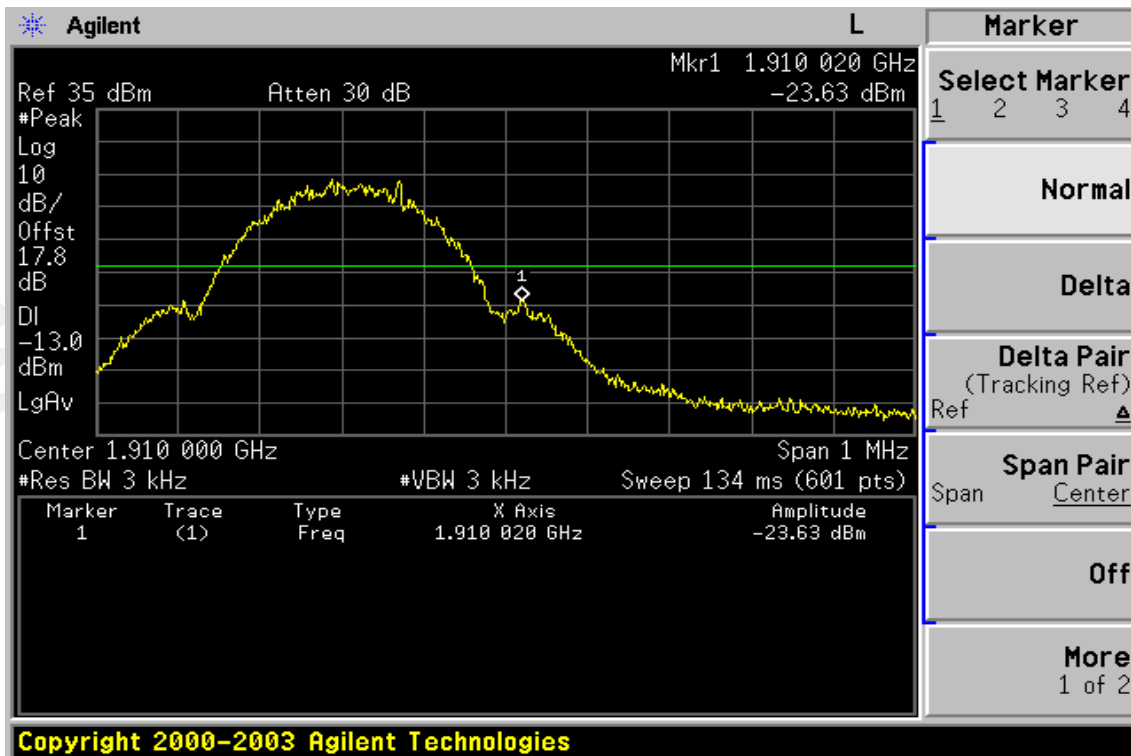

Figure 8-11: Band edge emission at antenna terminals – EDGE850 Channel Lowest

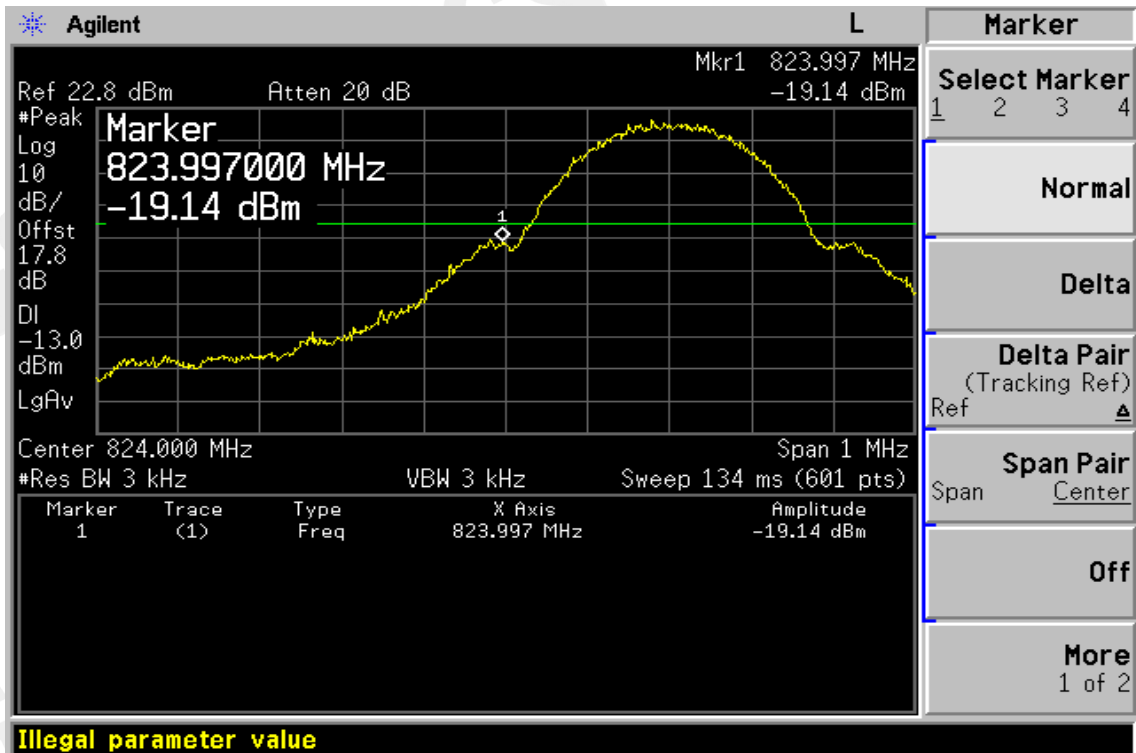

Figure 8-12: Band edge emission at antenna terminals –EDGE850 Channel Highest

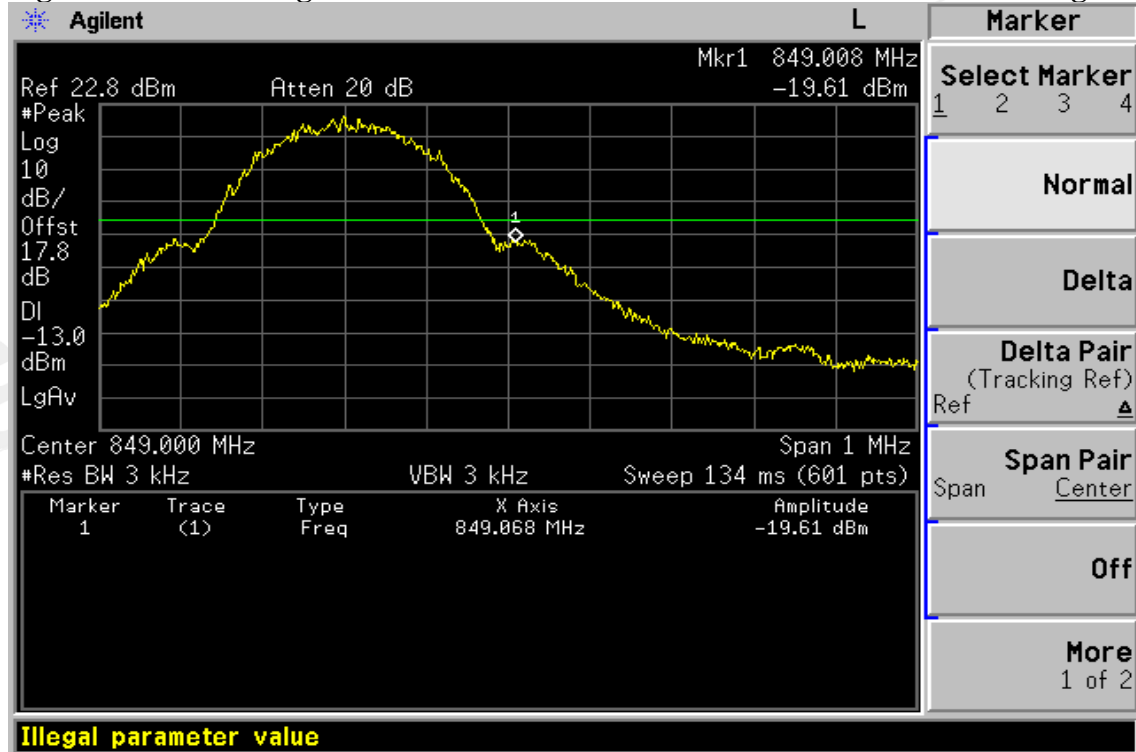

Figure 8-13: Bad edge emission at antenna terminals –EDGE1900 Channel Lowest

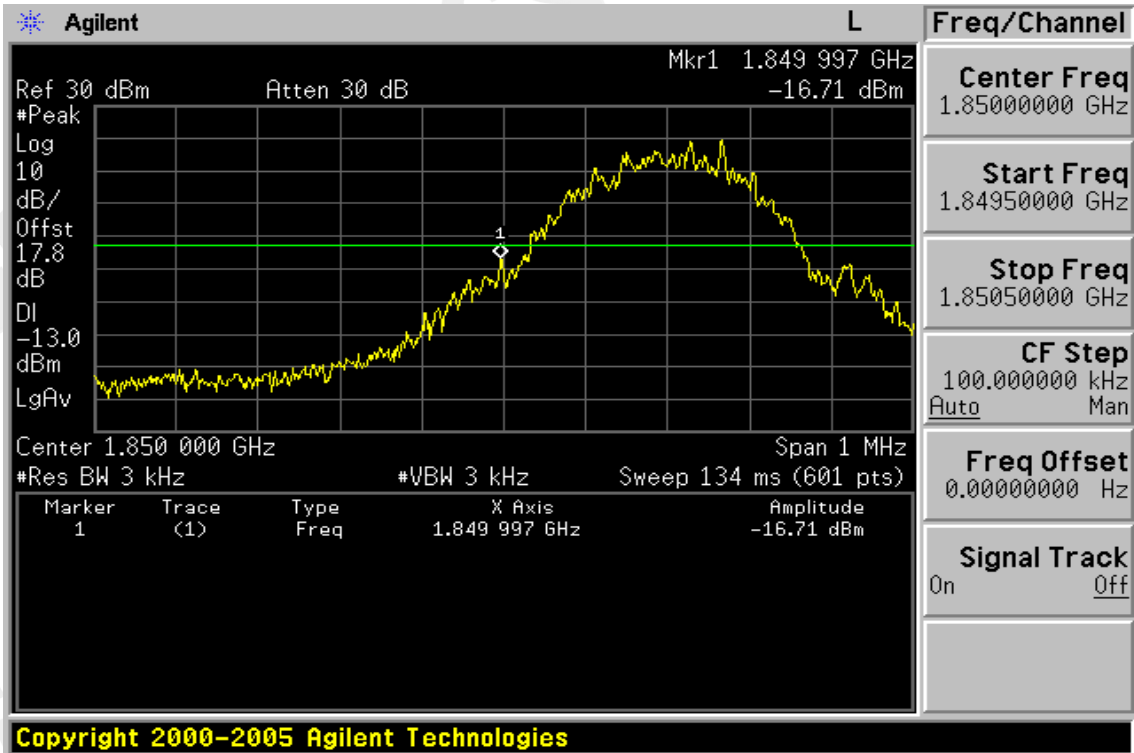
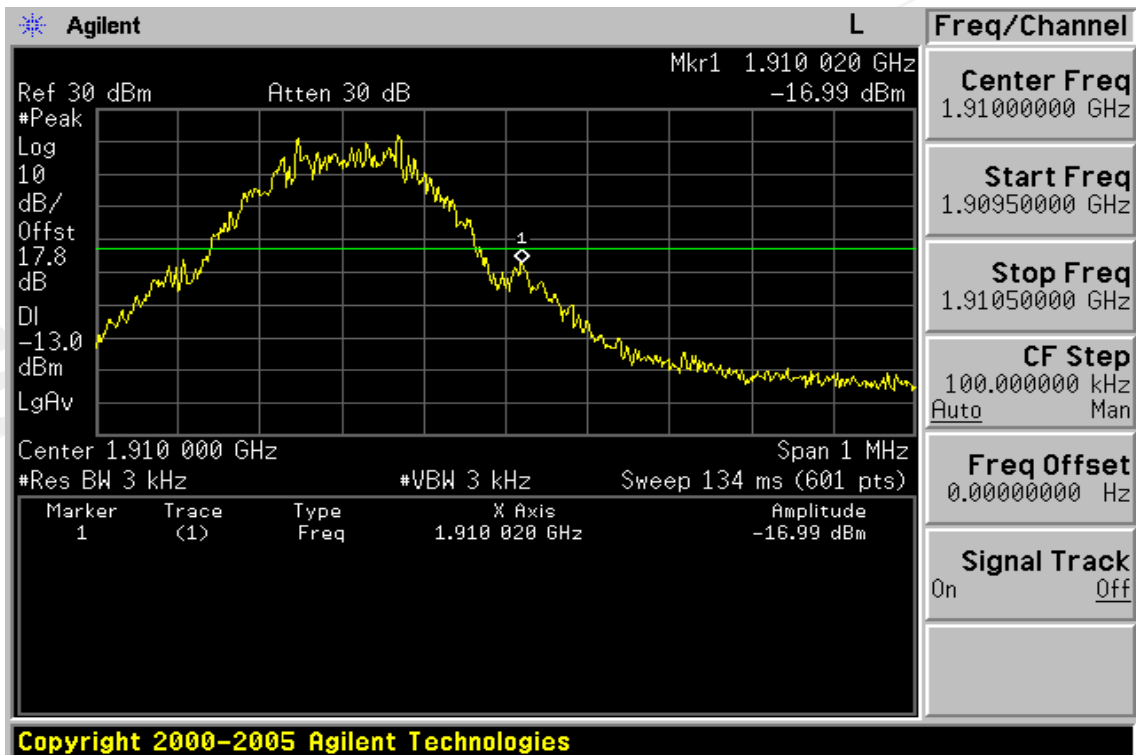

Figure 8-14: Band edge emission at antenna terminals –EDGE1900 Channel Highest



8. FIELD STRENGTH OF SPURIOUS RADIATION MEASUREMENT

8.1. Standard Applicable

According to FCC §2.1053,

FCC §22.917(a), §24.238(a), the magnitude of each spurious and harmonic emission that can be detected when the equipment is operated under the conditions specified in the instruction manual and/ or alignment procedure, shall not be less than $43 + 10 \log$ (mean output power in watts) dBc below the mean power output outside a license's frequency block (-13dBm)

8.2. EUT Setup (Block Diagram of Configuration)

(A) Radiated Emission Test Set-Up, Frequency Below 1000MHz

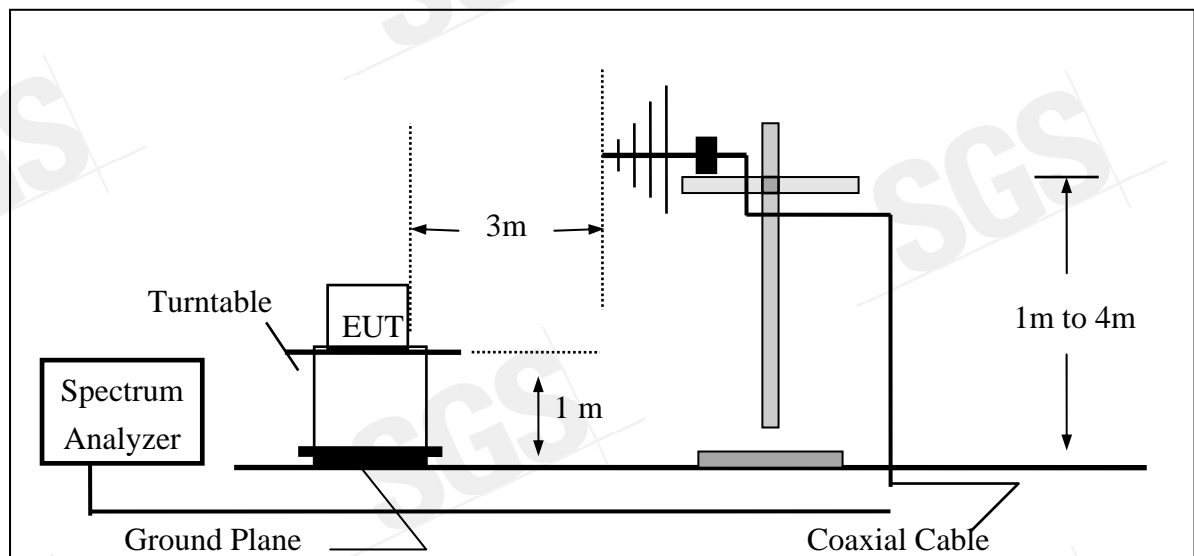

(B) Radiated Emission Test Set-UP Frequency Over 1 GHz

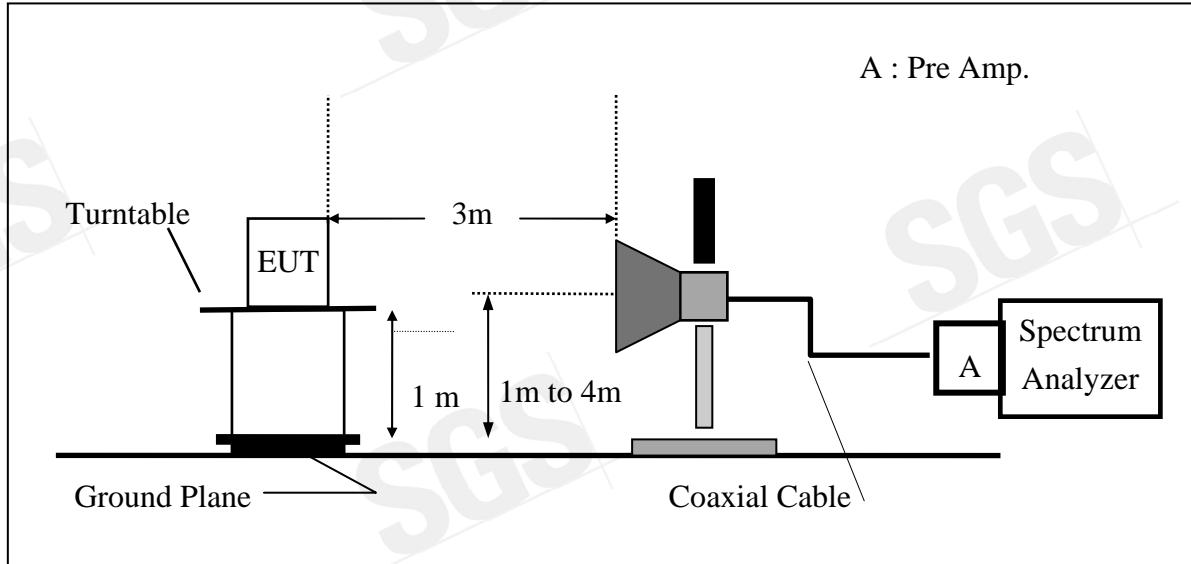

(C) Substituted Method Test Set-UP

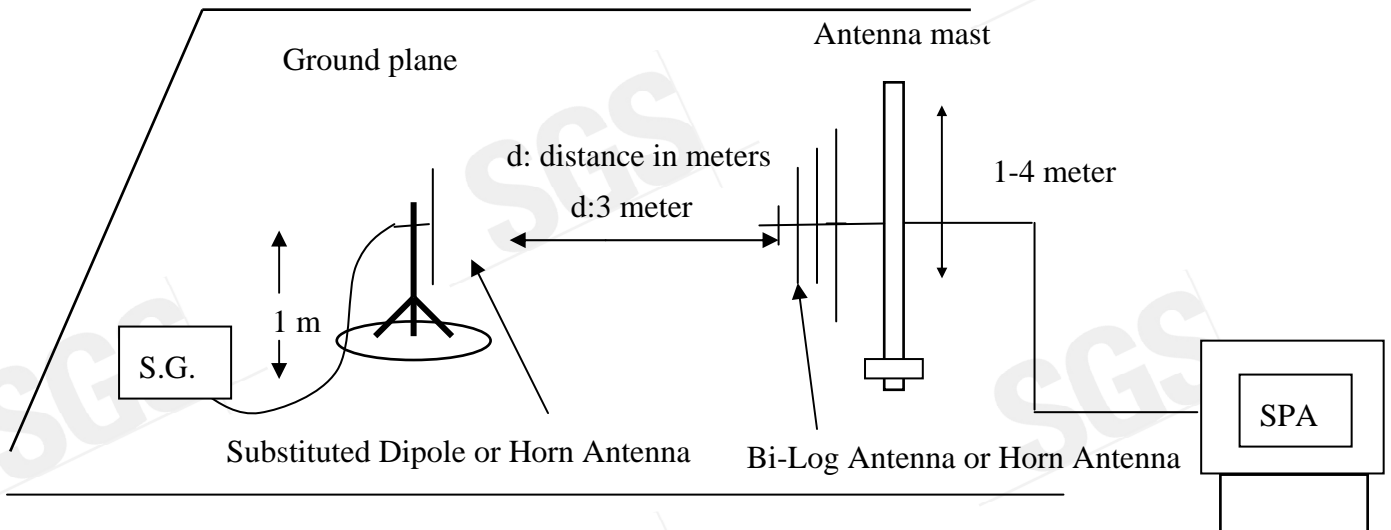

8.3. Measurement Procedure

The EUT was placed on a non-conductive, The measurement antenna was placed at a distance of 3 meters from the EUT. During the tests, the antenna height and the EUT azimuth were varied in order to identify the maximum level of emissions from the EUT. This maximization process was repeated with the EUT positioned in each of its three orthogonal orientations.

During the measurement, the EUT was communication with the station. The highest emission was recorded with the rotation of the turntable and the lowering of the test antenna from 4m to 1m. The reading was recorded and the field strength (E in dBuV/m) was calculated. And Peak detector was used during this test.

ERP was measured using a substitution method. The EUT was replaced by dipole antenna connected, the S.G. output was recorded and ERP was calculated as follows:

EIRP was measured using a substitution method. The EUT was replaced by or horn antenna connected, the S.G. output was recorded and EIRP was calculated as follows:

$$\text{ERP} = \text{S.G. output (dBm)} + \text{Antenna Gain (dBd)} - \text{Cable Loss (dB)}$$

$$\text{EIRP} = \text{S.G. output (dBm)} + \text{Antenna Gain (dBi)} - \text{Cable Loss (dB)}$$

8.4. Measurement Equipment Used:

EQUIPMENT TYPE	MFR	MODEL NUMBER	SERIAL NUMBER	LAST CAL.	CAL DUE.
Spectrum Analyzer	Agilent	E4446A	MY43360126	04/19/2008	04/18/2010
Spectrum Analyzer	Agilent	E7405A	US41160416	07/04/2007	07/03/2009
Spectrum Analyzer	R&S	FSP 40	100034	02/22/2008	02/21/2009
Communication Test	R&S	CMU200	102189	05/13/2008	05/12/2009
Bi-log Antenna	SCHWAZBECK	VULB9160	3224	11/29/2007	11/28/2008
Horn antenna	SCHWAZBECK	BBHA 9120D	309/320	03/14/2008	03/13/2009
Pre-Amplifier	HP	8447F	3113A06892	01/05/2008	01/04/2009
Pre-Amplifier	HP	8449B	3008A01973	01/05/2008	01/04/2009
Signal Generator	R&S	SMR40	100210	01/22/2008	01/21/2009
Turn Table	HD	DT420	N/A	N.C.R	N.C.R
Antenna Tower	HD	MA240-N	240/657	N.C.R	N.C.R
Controller	HD	HD100	N/A	N.C.R	N.C.R
Low Loss Cable	HUBER+SUHNER	SUCOFLEX 104PEA-10M	10m	02/13/2008	02/12/2009
Low Loss Cable	HUBER+SUHNER	SUCOFLEX 104PEA-3M	3m	02/13/2008	02/12/2009
Low Loss Cable	HUBER+SUHNER	SUCOFLEX 104PEA-0.5M	0.5m	02/13/2008	02/12/2009
Site NSA	SGS	966 chamber	N/A	11/17/2007	11/16/2008
Attenuator	Mini-Circuit	BW-S10W5	N/A	07/05/2008	07/04/2009
Dipole Antenna	SCHWAZBECK	VHAP	908/909	07/10/2008	07/10/2010
Dipole Antenna	SCHWAZBECK	UHAP	891/892	07/10/2008	07/10/2010

8.5. Measurement Result

Refer to attach tabular data sheets.

Radiated Spurious Emission Measurement Result: GSM 850 Mode

Operation Mode	: TX CH Low H Mode	Test Date:	Feb. 15, 2008
Fundamental Frequency	: 824.20 MHz	Test By:	Sky
Temperature	: 25°C	Pol:	Ver
Humidity	: 65%		

Freq. (MHz)	SPA. Reading (dBuV)	Ant.Pol. H/V	S.G Out-put (dBm)	Antenna Gain (dB/dBi)	Cable Loss (dB)	ERP/EIRP (dBm)	Limit (dBm)	Safe Margin (dBm)
36.79	51.98	V	-50.75	-4.16	0.75	-55.66	-13.00	-42.66
90.14	51.67	V	-52.72	-7.75	1.16	-61.63	-13.00	-48.63
153.19	45.53	V	-52.37	-7.80	1.47	-61.64	-13.00	-48.64
824.00	57.50	V	-29.83	-7.87	3.64	-41.35	-13.00	-28.35
902.03	35.69	V	-50.63	-7.95	3.82	-62.40	-13.00	-49.40
1648.40	---	V		9.29	5.06		-13.00	
1741.00	42.00	V	-65.00	9.57	5.22	-60.65	-13.00	-47.65
2472.60	45.04	V	-59.02	10.08	6.30	-55.25	-13.00	-42.25
3296.80	---	V		12.17	7.26		-13.00	
4121.00	---	V		12.61	8.33		-13.00	
4945.20	---	V		12.65	9.19		-13.00	
5769.40	---	V		13.55	9.80		-13.00	
6593.60	---	V		12.05	10.61		-13.00	
7417.80	---	V		11.49	11.28		-13.00	
8242.00	---	V		11.48	12.26		-13.00	

Measurement uncertainty	30MHz - 80MHz: 5.04dB
	80MHz - 1000MHz: 3.76dB
	1GHz - 13GHz: 4.45dB

Remark :

- 1 The emission behaviors belong to narrowband spurious emission.
- 2 Remark"---" means that the emission level is too low to be measured
- 3 The result basic equation calculation is as follows:
- 4 $ERP/EIRP (dBm) = SG \text{ Setting}(dBm) + Antenna \text{ Gain} (dB/dBi) - Cable \text{ loss} (dB)$
- 5 Peak detector was used during test.

Radiated Spurious Emission Measurement Result: GSM 850 Mode

Operation Mode	: TX CH Low H Mode	Test Date:	Feb. 15, 2008
Fundamental Frequency	: 824.20 MHz	Test By:	Sky
Temperature	: 25°C	Pol:	Hor
Humidity	: 65%		

Freq. (MHz)	SPA Reading (dBuV)	Ant.Pol. H/V	S.G Out-put (dBm)	Antenna Gain (dB/dBi)	Cable Loss (dB)	ERP/EIRP (dBm)	Limit (dBm)	Safe Margin (dBm)
90.14	46.84	H	-56.85	-7.75	1.16	-65.77	-13.00	-52.77
150.28	42.44	H	-56.16	-7.80	1.47	-65.43	-13.00	-52.43
223.03	45.10	H	-56.29	-7.86	1.76	-65.91	-13.00	-52.91
824.00	58.84	H	-28.82	-7.87	3.64	-40.34	-13.00	-27.34
902.03	39.37	H	-46.39	-7.95	3.82	-58.16	-13.00	-45.16
1648.40	---	H		9.29	5.06		-13.00	
2472.60	56.21	H	-47.85	10.08	6.30	-44.07	-13.00	-31.07
3296.80	---	H		12.17	7.26		-13.00	
4121.00	---	H		12.61	8.33		-13.00	
4945.20	---	H		12.65	9.19		-13.00	
5769.40	---	H		13.55	9.80		-13.00	
6593.60	---	H		12.05	10.61		-13.00	
7417.80	---	H		11.49	11.28		-13.00	
8242.00	---	H		11.48	12.26		-13.00	

Measurement uncertainty	30MHz - 80MHz: 5.04dB
	80MHz - 1000MHz: 3.76dB
	1GHz - 13GHz: 4.45dB

Remark :

- 1 The emission behaviors belong to narrowband spurious emission.
- 2 Remark"---" means that the emission level is too low to be measured
- 3 The result basic equation calculation is as follows:
- 4 $ERP/EIRP (dBm) = SG \text{ Setting}(dBm) + \text{Antenna Gain} (dB/dBi) - \text{Cable loss} (dB)$
- 5 Peak detector was used during test.

Radiated Spurious Emission Measurement Result: GSM 850 Mode

Operation Mode : TX CH Mid H Mode
 Fundamental Frequency : 836.60 MHz
 Temperature : 25°C
 Humidity : 65%

Test Date: Feb. 15, 2008
 Test By: Sky
 Pol: Ver

Freq. (MHz)	SPA. Reading (dBuV)	Ant.Pol. H/V	S.G Out-put (dBm)	Antenna Gain (dB/dBi)	Cable Loss (dB)	ERP/EIRP (dBm)	Limit (dBm)	Safe Margin (dBm)
36.79	51.70	V	-51.03	-4.16	0.75	-55.94	-13.00	-42.94
90.14	53.83	V	-50.56	-7.75	1.16	-59.47	-13.00	-46.47
114.39	50.69	V	-51.26	-7.77	1.29	-60.32	-13.00	-47.32
153.19	45.43	V	-52.47	-7.80	1.47	-61.74	-13.00	-48.74
902.03	35.03	V	-51.29	-7.95	3.82	-63.06	-13.00	-50.06
1673.20	---	V		9.36	5.10		-13.00	
2509.80	---	V		10.09	6.35		-13.00	
3346.40	39.01	V	-63.55	12.28	7.29	-58.57	-13.00	-45.57
4183.00	---	V		12.62	8.40		-13.00	
5019.60	---	V		12.67	9.26		-13.00	
5856.20	---	V		13.68	9.85		-13.00	
6692.80	---	V		11.95	10.74		-13.00	
7529.40	---	V		11.45	11.35		-13.00	
8366.00	---	V		11.59	12.43		-13.00	

Measurement uncertainty	30MHz - 80MHz: 5.04dB
	80MHz - 1000MHz: 3.76dB
	1GHz - 13GHz: 4.45dB

Remark :

- 1 The emission behaviors belong to narrowband spurious emission.
- 2 Remark"---" means that the emission level is too low to be measured
- 3 The result basic equation calculation is as follows:
- 4 $ERP/EIRP (dBm) = SG \text{ Setting}(dBm) + Antenna \text{ Gain} (dB/dBi) - Cable \text{ loss} (dB)$
- 5 Peak detector was used during test.

Radiated Spurious Emission Measurement Result: GSM 850 Mode

Operation Mode : TX CH Mid H Mode
 Fundamental Frequency : 836.60 MHz
 Temperature : 25°C
 Humidity : 65%

Test Date: Feb. 15, 2008
 Test By: Sky
 Pol: Hor

Freq. (MHz)	SPA. Reading (dBuV)	Ant.Pol. H/V	S.G Out-put (dBm)	Antenna Gain (dB/dBi)	Cable Loss (dB)	ERP/EIRP (dBm)	Limit (dBm)	Safe Margin (dBm)
90.14	49.07	H	-54.62	-7.75	1.16	-63.54	-13.00	-50.54
167.74	44.38	H	-55.34	-7.81	1.50	-64.66	-13.00	-51.66
221.09	46.68	H	-54.74	-7.86	1.74	-64.34	-13.00	-51.34
902.03	39.43	H	-46.33	-7.95	3.82	-58.10	-13.00	-45.10
1673.20	---	H		9.36	5.10		-13.00	
2509.80	48.58	H	-55.29	10.09	6.35	-51.55	-13.00	-38.55
3346.40	37.00	H	-65.32	12.28	7.29	-60.34	-13.00	-47.34
4183.00	---	H		12.62	8.40		-13.00	
5019.60	---	H		12.67	9.26		-13.00	
5856.20	---	H		13.68	9.85		-13.00	
6692.80	---	H		11.95	10.74		-13.00	
7529.40	---	H		11.45	11.35		-13.00	
8366.00	---	H		11.59	12.43		-13.00	

Measurement uncertainty	30MHz - 80MHz: 5.04dB
	80MHz -1000MHz: 3.76dB
	1GHz - 13GHz: 4.45dB

Remark :

- 1 The emission behaviors belong to narrowband spurious emission.
- 2 Remark"---" means that the emission level is too low to be measured
- 3 The result basic equation calculation is as follows:
- 4 $ERP/EIRP (dBm) = SG \text{ Setting}(dBm) + Antenna \text{ Gain} (dB/dBi) - Cable \text{ loss} (dB)$
- 5 Peak detector was used during test.

Radiated Spurious Emission Measurement Result: GSM 850 Mode

Operation Mode : TX CH High H Mode
 Fundamental Frequency : 848.80 MHz
 Temperature : 25°C
 Humidity : 65%

Test Date: Feb. 15, 2008
 Test By: Sky
 Pol: Ver

Freq. (MHz)	SPA. Reading (dBuV)	Ant.Pol. H/V	S.G Out-put (dBm)	Antenna Gain (dB/dBi)	Cable Loss (dB)	ERP/EIRP (dBm)	Limit (dBm)	Safe Margin (dBm)
36.79	47.96	V	-54.77	-4.16	0.75	-59.68	-13.00	-46.68
96.93	45.25	V	-58.66	-7.76	1.20	-67.62	-13.00	-54.62
164.83	43.57	V	-55.37	-7.81	1.50	-64.68	-13.00	-51.68
628.49	31.84	V	-58.62	-7.80	2.97	-69.39	-13.00	-56.39
850.00	77.51	V	-9.20	-7.88	3.75	-20.83	-13.00	-7.83
1697.60	---	V		9.44	5.14		-13.00	
2546.40	40.04	V	-63.75	10.20	6.40	-59.95	-13.00	-46.95
3395.20	---	V		12.38	7.33		-13.00	
4244.00	---	V		12.63	8.46		-13.00	
5092.80	---	V		12.74	9.32		-13.00	
5941.60	---	V		13.81	9.89		-13.00	
6790.40	---	V		11.86	10.87		-13.00	
7639.20	---	V		11.40	11.48		-13.00	
8488.00	---	V		11.70	12.59		-13.00	

Measurement uncertainty	30MHz - 80MHz: 5.04dB
	80MHz -1000MHz: 3.76dB
	1GHz - 13GHz: 4.45dB

Remark :

- 1 The emission behaviors belong to narrowband spurious emission.
- 2 Remark"---" means that the emission level is too low to be measured
- 3 The result basic equation calculation is as follows:
- 4 $ERP/EIRP (dBm) = SG \text{ Setting}(dBm) + Antenna \text{ Gain} (dB/dBi) - Cable \text{ loss} (dB)$
- 5 Peak detector was used during test.

Radiated Spurious Emission Measurement Result: GSM 850 Mode

Operation Mode	: TX CH High H Mode	Test Date:	Feb. 15, 2008
Fundamental Frequency	: 848.80 MHz	Test By:	Sky
Temperature	: 25°C	Pol:	Hor
Humidity	: 65%		

Freq. (MHz)	SPA. Reading (dBuV)	Ant.Pol. H/V	S.G Out-put (dBm)	Antenna Gain (dB/dBi)	Cable Loss (dB)	ERP/EIRP (dBm)	Limit (dBm)	Safe Margin (dBm)
90.14	48.94	H	-54.75	-7.75	1.16	-63.67	-13.00	-50.67
153.19	43.14	H	-55.65	-7.80	1.47	-64.92	-13.00	-51.92
218.18	46.67	H	-54.80	-7.86	1.72	-64.38	-13.00	-51.38
850.00	81.17	H	-5.82	-7.88	3.75	-17.45	-13.00	-4.45
902.03	37.59	H	-48.17	-7.95	3.82	-59.94	-13.00	-46.94
1697.60	---	H		9.44	5.14		-13.00	
2546.40	38.76	H	-65.02	10.20	6.40	-61.22	-13.00	-48.22
3395.20	---	H		12.38	7.33		-13.00	
4244.00	---	H		12.63	8.46		-13.00	
5092.80	---	H		12.74	9.32		-13.00	
5941.60	---	H		13.81	9.89		-13.00	
6790.40	---	H		11.86	10.87		-13.00	
7639.20	---	H		11.40	11.48		-13.00	
8488.00	---	H		11.70	12.59		-13.00	

Measurement uncertainty	30MHz - 80MHz: 5.04dB
	80MHz -1000MHz: 3.76dB
	1GHz - 13GHz: 4.45dB

Remark :

- 1 The emission behaviors belongs to narrowband spurious emission.
- 2 Remark"---" means that the emission level is too low to be measured
- 3 The result basic equation calculation is as follows:
- 4 $ERP/EIRP (dBm) = SG \text{ Setting}(dBm) + Antenna \text{ Gain} (dB/dBi) - Cable \text{ loss} (dB)$
- 5 Peak detector was used during test.

Radiated Spurious Emission Measurement Result: PCS 1900 Mode

Operation Mode	: TX CH Low E1 Mode	Test Date	Feb. 15, 2008
Fundamental Frequency	: 1850.20MHz	Test By:	Sky
Temperature	: 25°C	Pol:	Ver
Humidity	: 65%		

Freq. (MHz)	SPA. Reading (dBuV)	Ant.Pol. H/V	S.G Out-put (dBm)	Antenna Gain (dB/dBi)	Cable Loss (dB)	ERP/EIRP (dBm)	Limit (dBm)	Safe Margin (dBm)
90.14	51.19	V	-53.20	-7.75	1.16	-62.11	-13.00	-49.11
121.18	54.83	V	-46.29	-7.78	1.32	-55.39	-13.00	-42.39
155.13	46.58	V	-51.49	-7.80	1.48	-60.77	-13.00	-47.77
1273.00	48.66	V	-58.39	7.53	4.35	-55.21	-13.00	-42.21
1850.00	80.30	V	-26.66	9.90	5.41	-22.17	-13.00	-9.17
2540.50	45.93	V	-57.87	10.18	6.39	-54.08	-13.00	-41.08
3700.40	---	V		12.61	7.73		-13.00	
5550.60	---	V		13.23	9.68		-13.00	
7400.80	---	V		11.50	11.28		-13.00	
9251.00	---	V		11.92	13.10		-13.00	
11101.20	---	V		11.66	14.33		-13.00	
12951.40	---	V		13.63	15.98		-13.00	
14801.60	---	V		12.76	17.27		-13.00	
16651.80	---	V		15.92	19.04		-13.00	
18502.00	---	V		18.75	21.21		-13.00	

Measurement uncertainty	30MHz - 80MHz: 5.04dB
	80MHz - 1000MHz: 3.76dB
	1GHz - 13GHz: 4.45dB

Remark :

- 1 The emission behaviors belong to narrowband spurious emission.
- 2 Remark”---“ means that the emission level is too low to be measured
- 3 The result basic equation calculation is as follows:
- 4 $ERP/EIRP (dBm) = SG \text{ Setting}(dBm) + Antenna \text{ Gain} (dB/dBi) - Cable \text{ loss} (dB)$
- 5 Peak detector was used during test.

Radiated Spurious Emission Measurement Result: PCS 1900 Mode

Operation Mode	: TX CH Low E1 Mode	Test Date	Feb. 15, 2008
Fundamental Frequency	: 1850.20MHz	Test By:	Sky
Temperature	: 25°C	Pol:	Hor
Humidity	: 65%		

Freq. (MHz)	SPA. Reading (dBuV)	Ant.Pol. H/V	S.G Out-put (dBm)	Antenna Gain (dB/dBi)	Cable Loss (dB)	ERP/EIRP (dBm)	Limit (dBm)	Safe Margin (dBm)
121.18	50.38	H	-50.86	-7.78	1.32	-59.96	-13.00	-46.96
158.04	46.66	H	-52.44	-7.81	1.48	-61.73	-13.00	-48.73
221.09	45.67	H	-55.75	-7.86	1.74	-65.35	-13.00	-52.35
315.18	44.40	H	-54.47	-7.83	2.13	-64.44	-13.00	-51.44
1273.00	46.01	H	-61.82	7.53	4.35	-58.64	-13.00	-45.64
1850.00	73.00	H	-33.89	9.90	5.41	-29.40	-13.00	-16.40
3700.40	---	H		12.61	7.73		-13.00	
5550.60	---	H		13.23	9.68		-13.00	
7400.80	---	H		11.50	11.28		-13.00	
9251.00	---	H		11.92	13.10		-13.00	
11101.20	---	H		11.66	14.33		-13.00	
12951.40	---	H		13.63	15.98		-13.00	
14801.60	---	H		12.76	17.27		-13.00	
16651.80	---	H		15.92	19.04		-13.00	
18502.00	---	H		18.75	21.21		-13.00	

Measurement uncertainty	30MHz - 80MHz: 5.04dB
	80MHz - 1000MHz: 3.76dB
	1GHz - 13GHz: 4.45dB

Remark :

- 1 The emission behaviors belong to narrowband spurious emission.
- 2 Remark”---“ means that the emission level is too low to be measured
- 3 The result basic equation calculation is as follows:
- 4 $ERP/EIRP (dBm) = SG \text{ Setting}(dBm) + Antenna \text{ Gain} (dB/dBi) - Cable \text{ loss} (dB)$
- 5 Peak detector was used during test.

Radiated Spurious Emission Measurement Result: PCS 1900 Mode

Operation Mode	: TX CH Mid E1 Mode	Test Date	Feb. 15, 2008
Fundamental Frequency	: 1880MHz	Test By	Sky
Temperature	: 25°C	Pol	Ver
Humidity	: 65%		

Freq. (MHz)	SPA. Reading (dBuV)	Ant.Pol. H/V	S.G Out-put (dBm)	Antenna Gain (dB/dBi)	Cable Loss (dB)	ERP/EIRP (dBm)	Limit (dBm)	Safe Margin (dBm)
121.18	55.33	V	-45.79	-7.78	1.32	-54.89	-13.00	-41.89
158.04	46.98	V	-51.35	-7.81	1.48	-60.64	-13.00	-47.64
625.58	39.92	V	-50.54	-7.80	2.97	-61.31	-13.00	-48.31
1253.50	51.24	V	-55.81	7.42	4.31	-52.70	-13.00	-39.70
2508.00	48.67	V	-55.21	10.08	6.35	-51.47	-13.00	-38.47
3760.00	---	V		12.60	7.82		-13.00	
5640.00	---	V		13.36	9.73		-13.00	
7520.00	---	V		11.45	11.33		-13.00	
9400.00	---	V		11.93	13.15		-13.00	
11280.00	---	V		11.92	14.56		-13.00	
13160.00	---	V		13.33	16.11		-13.00	
15040.00	---	V		13.76	17.57		-13.00	
16920.00	---	V		15.27	19.66		-13.00	
18800.00	---	V		18.68	21.34		-13.00	

Measurement uncertainty	30MHz - 80MHz: 5.04dB
	80MHz -1000MHz: 3.76dB
	1GHz - 13GHz: 4.45dB

Remark :

- 1 The emission behaviors belong to narrowband spurious emission.
- 2 Remark"---" means that the emission level is too low to be measured
- 3 The result basic equation calculation is as follows:
- 4 $ERP/EIRP (dBm) = SG \text{ Setting}(dBm) + Antenna \text{ Gain} (dB/dBi) - Cable \text{ loss} (dB)$
- 5 Peak detector was used during test.

Radiated Spurious Emission Measurement Result: PCS 1900 Mode

Operation Mode	: TX CH Mid E1 Mode	Test Date	Feb. 15, 2008
Fundamental Frequency	: 1880MHz	Test By	Sky
Temperature	: 25°C	Pol	Hor
Humidity	: 65%		

Freq. (MHz)	SPA Reading (dBuV)	Ant.Pol. H/V	S.G Output (dBm)	Antenna Gain (dB/dBi)	Cable Loss (dB)	ERP/EIRP (dBm)	Limit (dBm)	Safe Margin (dBm)
121.18	50.27	H	-50.97	-7.78	1.32	-60.07	-13.00	-47.07
155.13	45.73	H	-53.18	-7.80	1.48	-62.46	-13.00	-49.46
625.58	39.71	H	-51.26	-7.80	2.97	-62.03	-13.00	-49.03
1253.50	47.05	H	-60.84	7.42	4.31	-57.73	-13.00	-44.73
2508.00	44.34	H	-59.54	10.08	6.35	-55.80	-13.00	-42.80
3760.00	---	H		12.60	7.82		-13.00	
5640.00	---	H		13.36	9.73		-13.00	
7520.00	---	H		11.45	11.33		-13.00	
9400.00	---	H		11.93	13.15		-13.00	
11280.00	---	H		11.92	14.56		-13.00	
13160.00	---	H		13.33	16.11		-13.00	
15040.00	---	H		13.76	17.57		-13.00	
16920.00	---	H		15.27	19.66		-13.00	
18800.00	---	H		18.68	21.34		-13.00	

Measurement uncertainty	30MHz - 80MHz: 5.04dB
	80MHz - 1000MHz: 3.76dB
	1GHz - 13GHz: 4.45dB

Remark :

- 1 The emission behaviors belong to narrowband spurious emission.
- 2 Remark"---" means that the emission level is too low to be measured
- 3 The result basic equation calculation is as follows:
- 4 $ERP/EIRP (dBm) = SG \text{ Setting}(dBm) + Antenna \text{ Gain} (dB/dBi) - Cable \text{ loss} (dB)$
- 5 Peak detector was used during test.

Radiated Spurious Emission Measurement Result: PCS 1900 Mode

Operation Mode	: TX CH High E1 Mode	Test Date	Feb. 15, 2008
Fundamental Frequency	: 1909.8 MHz	Test By	Sky
Temperature	: 25°C	Pol	Ver
Humidity	: 65%		

Freq. (MHz)	SPA. Reading (dBuV)	Ant.Pol. H/V	S.G Out-put (dBm)	Antenna Gain (dB/dBi)	Cable Loss (dB)	ERP/EIRP (dBm)	Limit (dBm)	Safe Margin (dBm)
121.18	55.55	V	-45.57	-7.78	1.32	-54.67	-13.00	-41.67
167.74	46.34	V	-52.86	-7.81	1.50	-62.18	-13.00	-49.18
635.28	47.13	V	-43.32	-7.80	2.98	-54.10	-13.00	-41.10
1273.00	49.18	V	-57.87	7.53	4.35	-54.69	-13.00	-41.69
1910.00	80.58	V	-26.36	10.08	5.51	-21.79	-13.00	-8.79
2540.50	48.37	V	-55.43	10.18	6.39	-51.64	-13.00	-38.64
3981.60	---	V		12.60	8.17		-13.00	
5972.40	---	V		13.86	9.91		-13.00	
7963.20	---	V		11.27	11.88		-13.00	
9954.00	---	V		12.08	13.43		-13.00	
11944.80	---	V		13.08	15.21		-13.00	
13935.60	---	V		11.82	16.86		-13.00	
15926.40	---	V		17.08	18.33		-13.00	
17917.20	---	V		9.63	20.12		-13.00	
19908.00	---	V		18.88	20.85		-13.00	

Measurement uncertainty	30MHz - 80MHz: 5.04dB
	80MHz -1000MHz: 3.76dB
	1GHz - 13GHz: 4.45dB

Remark :

- 1 The emission behaviors belong to narrowband spurious emission.
- 2 Remark"---" means that the emission level is too low to be measured
- 3 The result basic equation calculation is as follows:
- 4 $ERP/EIRP (dBm) = SG \text{ Setting}(dBm) + Antenna \text{ Gain} (dB/dBi) - Cable \text{ loss} (dB)$
- 5 Peak detector was used during test.

Radiated Spurious Emission Measurement Result: PCS 1900 Mode

Operation Mode	: TX CH High E1 Mode	Test Date	Feb. 15, 2008
Fundamental Frequency	: 1909.8 MHz	Test By	Sky
Temperature	: 25°C	Pol	Hor
Humidity	: 65%		

Freq. (MHz)	SPA. Reading (dBuV)	Ant.Pol. H/V	S.G Out-put (dBm)	Antenna Gain (dB/dBi)	Cable Loss (dB)	ERP/EIRP (dBm)	Limit (dBm)	Safe Margin (dBm)
116.33	50.91	H	-50.78	-7.77	1.30	-59.85	-13.00	-46.85
158.04	45.24	H	-53.86	-7.81	1.48	-63.15	-13.00	-50.15
635.28	49.08	H	-41.64	-7.80	2.98	-52.42	-13.00	-39.42
1273.00	40.60	H	-67.23	7.53	4.35	-64.05	-13.00	-51.05
1910.00	72.29	H	-34.56	10.08	5.51	-30.00	-13.00	-17.00
2540.50	40.32	H	-63.47	10.18	6.39	-59.69	-13.00	-46.69
3981.60	---	H		12.60	8.17		-13.00	
5972.40	---	H		13.86	9.91		-13.00	
7963.20	---	H		11.27	11.88		-13.00	
9954.00	---	H		12.08	13.43		-13.00	
11944.80	---	H		13.08	15.21		-13.00	
13935.60	---	H		11.82	16.86		-13.00	
15926.40	---	H		17.08	18.33		-13.00	
17917.20	---	H		9.63	20.12		-13.00	
19908.00	---	H		18.88	20.85		-13.00	

Measurement uncertainty	30MHz - 80MHz: 5.04dB
	80MHz -1000MHz: 3.76dB
	1GHz - 13GHz: 4.45dB

Remark :

- 1 The emission behaviors belong to narrowband spurious emission.
- 2 Remark"---" means that the emission level is too low to be measured
- 3 The result basic equation calculation is as follows:
- 4 $ERP/EIRP (dBm) = SG \text{ Setting}(dBm) + Antenna \text{ Gain} (dB/dBi) - Cable \text{ loss} (dB)$
- 5 Peak detector was used during test.

9. FREQUENCY STABILITY V.S. TEMPERATURE MEASUREMENT

9.1. Standard Applicable

According to FCC §2.1055(a)(1)(b).

Frequency Tolerance: +/-0.1 ppm for 850MHz band

+/-0.04 ppm for 1900MHz band

9.2. Test Set-up:

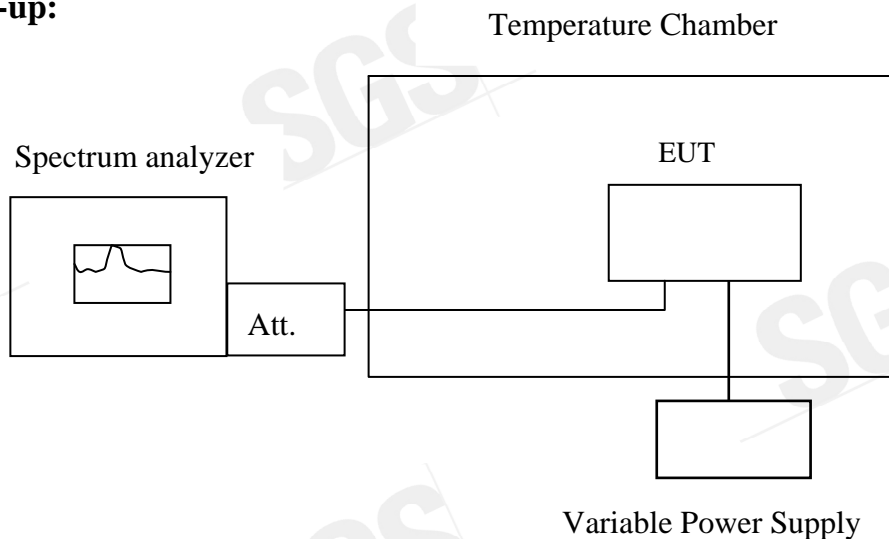

Note : Measurement setup for testing on Antenna connector

9.3. Measurement Procedure

The equipment under test was connected to an external AC or DC power supply and input rated voltage. RF output was connected to a frequency counter or spectrum analyzer via feed through attenuators. The EUT was placed inside the temperature chamber. Set the spectrum analyzer RBW low enough to obtain the desired frequency resolution and measure EUT 25°C operating frequency as reference frequency. Turn EUT off and set the chamber temperature to -30°C. After the temperature stabilized for approximately 30 minutes re-recorded the frequency. Repeat step measure with 10°C increased per stage until the highest temperature of +50°C reached.

9.4. Measurement Equipment Used:

Conducted Emission Test Site					
EQUIPMENT TYPE	MFR	MODEL NUMBER	SERIAL NUMBER	LAST CAL.	CAL DUE.
Spectrum Analyzer	Agilent	E4446A	MY43360126	04/19/2008	04/18/2010
Spectrum Analyzer	Agilent	E7405A	US41160416	07/04/2007	07/03/2009
Spectrum Analyzer	R&S	FSP 40	100034	02/22/2008	02/21/2009
Communication Test	R&S	CMU200	102189	05/13/2008	05/12/2009
Power Sensor	Anritsu	MA2490A	31431	07/07/2007	07/06/2009
Power Meter	Anritsu	ML2487A	6K00002070	05/28/2008	05/27/2010
Temperature Chamber	TERCHY	MHG-120LF	911009	04/14/2008	04/13/2010
Low Loss Cable	HUBER+SUHNER	SUCOFLEX 104PEA	N/A	02/13/2008	02/12/2009
Attenuator	Mini-Circuit	BW-S10W5	N/A	07/05/2008	07/04/2009
Attenuator	Mini-Circuit	BW-S6W5	N/A	07/05/2008	07/04/2009
Splitter	Agilent	11636B	51818 / 51820	07/05/2008	07/04/2009
DC Power Supply	Agilent	6038A	2929A-07548	06/27/2007	06/26/2009

9.5. Measurement Result

Reference Frequency: GSM Mid Channel 836.6 MHz @ 25°C				
Limit: +/- 0.1 ppm = 83.6 Hz				
Power Supply	Environment	Frequency	Delta (Hz)	Limit (Hz)
Vdc	Temperature (°C)	(MHz)		
3.8	-30	836.600003	3.00	83.6
3.8	-20	836.600007	-1.00	83.6
3.8	-10	836.600013	-7.00	83.6
3.8	0	836.600012	-6.00	83.6
3.8	10	836.600010	-4.00	83.6
3.8	20	836.600006	0.00	83.6
3.8	30	836.600001	5.00	83.6
3.8	40	836.599991	15.00	83.6
3.8	50	836.599984	22.00	83.6

Reference Frequency: PCS Mid Channel 1880 MHz @ 25°C				
Limit: +/- 0.04 ppm = 75.2 Hz				
Power Supply	Environment	Frequency	Delta (Hz)	Limit (Hz)
Vdc	Temperature (°C)	(MHz)		
3.8	-30	1879.999996	-18.00	75.2
3.8	-20	1879.999993	-15.00	75.2
3.8	-10	1879.999995	-17.00	75.2
3.8	0	1879.999992	-14.00	75.2
3.8	10	1879.999985	-7.00	75.2
3.8	20	1879.999978	0.00	75.2
3.8	30	1879.999970	8.00	75.2
3.8	40	1879.999963	15.00	75.2
3.8	50	1879.999954	24.00	75.2

10. FREQUENCY STABILITY V.S. VOLTAGE MEASUREMENT

10.1. Standard Applicable

According to FCC §2.1055(d)(1)(2)

Frequency Tolerance: +/-0.1ppm for 850MHz band

+/-0.04ppm for 1900MHz band

10.2. Test Set-up:

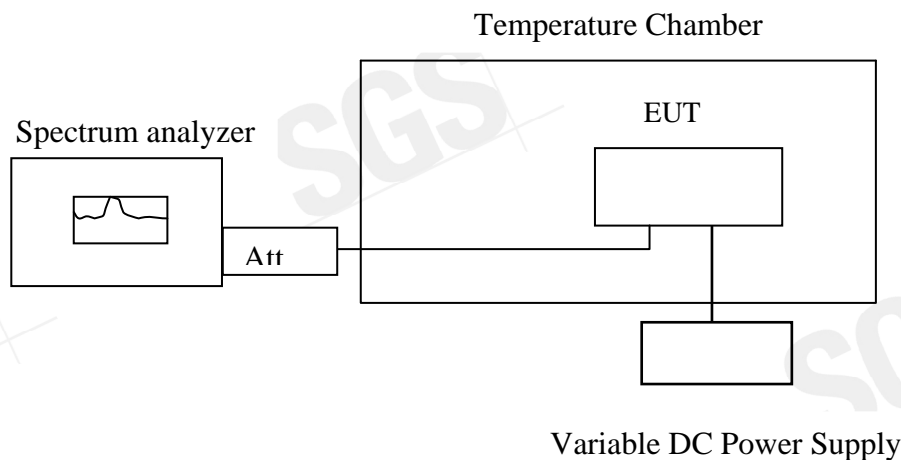

Note: Measurement setup for testing on Antenna connector

10.3. Measurement Procedure

Set chamber temperature to 25°C. Use a variable AC power supply / DC power source to power the EUT and set the voltage to rated voltage. Set the spectrum analyzer RBW low enough to obtain the desired frequency resolution and recorded the frequency.

Reduce the input voltage to specified extreme voltage variation (+/- 15%) and endpoint, record the maximum frequency change.

10.4. Measurement Equipment Used:

Conducted Emission Test Site					
EQUIPMENT TYPE	MFR	MODEL NUMBER	SERIAL NUMBER	LAST CAL.	CAL DUE.
Spectrum Analyzer	Agilent	E4446A	MY43360126	04/19/2008	04/18/2010
Spectrum Analyzer	Agilent	E7405A	US41160416	07/04/2007	07/03/2009
Spectrum Analyzer	R&S	FSP 40	100034	02/22/2008	02/21/2009
Communication Test	R&S	CMU200	102189	05/13/2008	05/12/2009
Power Sensor	Anritsu	MA2490A	31431	07/07/2007	07/06/2009
Power Meter	Anritsu	ML2487A	6K00002070	05/28/2008	05/27/2010
Temperature Chamber	TERCHY	MHG-120LF	911009	04/14/2008	04/13/2010
Low Loss Cable	HUBER+SUHNER	SUCOFLEX 104PEA	N/A	02/13/2008	02/12/2009
Attenuator	Mini-Circuit	BW-S10W5	N/A	07/05/2008	07/04/2009
Attenuator	Mini-Circuit	BW-S6W5	N/A	07/05/2008	07/04/2009
Splitter	Agilent	11636B	51818 / 51820	07/05/2008	07/04/2009
DC Power Supply	Agilent	6038A	2929A-07548	06/27/2007	06/26/2009

10.5. Measurement Result

Reference Frequency: GSM Mid Channel 836.6 MHz @ 25°C				
Limit: +/- 0.1 ppm = 83.6 Hz				
Power Supply	Environment	Frequency	Delta (Hz)	Limit (Hz)
Vdc	Temperature (°C)	(MHz)		
4.30	25.00	836.599997	0.00	83.6
3.80	25.00	836.600004	-7.00	83.6
3.30	25.00	836.599994	3.00	83.6
3.00 (End Point)	25.00	836.599754	24.30	83.6

Reference Frequency: PCS Mid Channel 1880 MHz @ 25°C				
Limit: +/- 0.04 ppm = 75.2 Hz				
Power Supply	Environment	Frequency	Delta (Hz)	Limit (Hz)
Vdc	Temperature (°C)	(MHz)		
4.3	25	1879.999977	0.00	75.2
3.8	25	1879.999975	2.00	75.2
3.3	25	1879.999973	4.00	75.2
3.00 (Endpoint)	25	1879.999584	39.30	75.2

11. AC POWER LINE CONDUCTED EMISSION TEST

11.1. Standard Applicable

According to §15.207. The emission value for frequency within 150KHz to 30MHz shall not exceed criteria of below chart.

Frequency range MHz	Limits dB(uV)	
	Quasi-peak	Average
0.15 to 0.50	66 to 56	56 to 46
0.50 to 5	56	46
5 to 30	60	50

Note

- 1.The lower limit shall apply at the transition frequencies
- 2.The limit decreases linearly with the logarithm of the frequency in the range 0.15 MHz to 0.50 MHz.

11.2. EUT Setup

1. The conducted emission tests were performed in the test site, using the setup in accordance with the ANSI C63.4-2001.
2. The EUT was plug-in DC power adaptor and was placed on the center of the back edge on the test table. The peripherals like earphone was placed on the side of the EUT. The rear of the EUT and peripherals were placed flushed with the rear of the tabletop.
3. The Power adaptor was connected with 110Vac/60Hz power source.

11.3. Measurement Procedure

1. The EUT was placed on a table which is 0.8m above ground plane.
2. Maximum procedure was performed on the six highest emissions to ensure EUT compliance.
3. Repeat above procedures until all frequency measured were complete.

11.4. Measurement Equipment Used:

Conducted Emission Test Site					
EQUIPMENT TYPE	MFR	MODEL NUMBER	SERIAL NUMBER	LAST CAL.	CAL DUE.
EMI Test Receiver	R&S	ESCS30	828985/004	09/15/2008	09/14/2009
LISN	Rolf-Heine	NNB-2/16Z	99012	02/18/2008	02/17/2009
LISN	FCC	FCC-LISN-50/250-25 -2-01	04034	02/18/2008	02/17/2009
Coaxial Cables	N/A	WK CE Cable	N/A	10/30/2007	10/29/2008

11.5. Measurement Result

The initial step in collecting conducted data is a spectrum analyzer peak scan of the measurement range. Significant peaks are then marked as shown on the following data page, and these signals are then quasi-peaked.

AC POWER LINE CONDUCTED EMISSION TEST DATA

Operation Mode:	GSM 850 LINK			Test Date:	Feb. 15, 2008
Temperature:	22 °C	Humidity:	57%	Test By:	Sky

Conducted Emission Measurement

File :ER-2008-20007(SGS上海Data :#39

80.0 dBuV

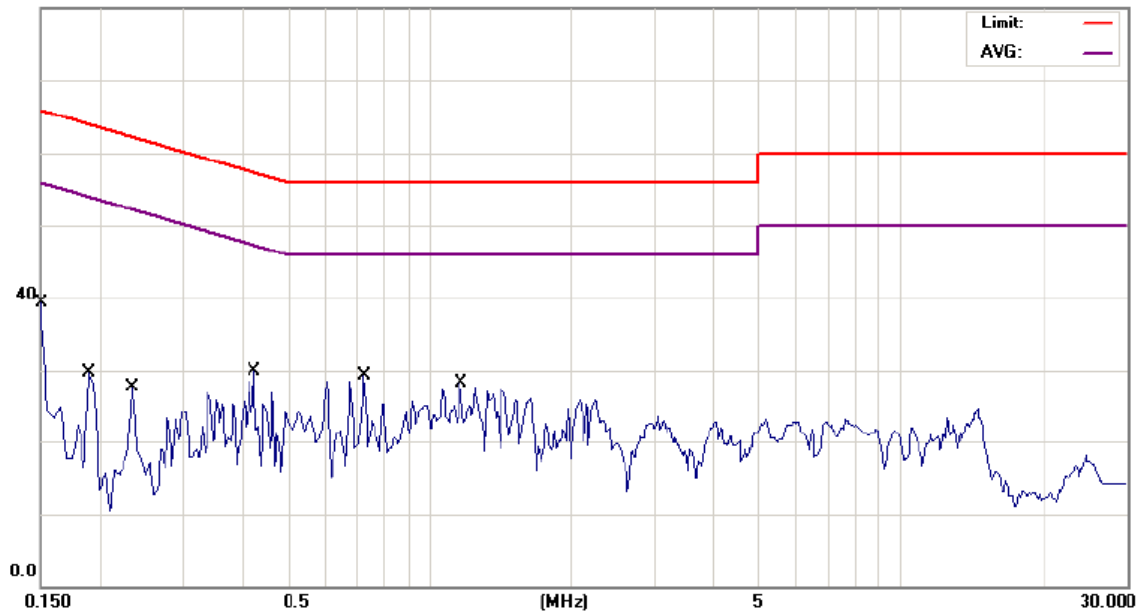

Site SGS CONDUCTED #1

Limit: CISPR22 Class B Conduction(QP)

EUT: MO300QBM

M/N: MO300QBM

Note: GSM 850 LINK

Phase: L1

Power: AC 120V/60Hz

Distance:

Temperature: 22 °C

Humidity: 57 %

Air Pressure: hpa

No.	Mk.	Freq. MHz	Reading Level dBuV	Factor dB	Measure- ment dBuV	Limit dBuV	Over dB	Detector	Comment
1	*	0.1500	38.07	1.18	39.25	66.00	-26.75	QP	
2		0.1900	29.47	0.25	29.72	64.04	-34.32	QP	
3		0.2350	27.73	0.02	27.75	62.27	-34.52	QP	
4		0.4250	29.81	0.02	29.83	57.35	-27.52	QP	
5		0.7250	29.23	0.02	29.25	56.00	-26.75	QP	
6		1.1600	28.27	0.01	28.28	56.00	-27.72	QP	

This document is issued by the Company subject to its General Conditions of Service which is available on request or accessible at www.sgs.com. Attention is drawn to the limitations of liability, indemnification and jurisdictional issues defined therein. Unless otherwise stated, the results shown in this test report refer only to the sample(s) tested. This document cannot be reproduced except in full, without prior approval of the Company. Any unauthorized alteration, forgery or falsification of the content or appearance of this report is unlawful and offenders may be prosecuted to the fullest extent of the law. 此報告是遵循本公司訂定之通用服務條款所製作發放，相關服務條款備索，或可在 www.sgs.com 中查閱，本公司之義務、免責、管轄權皆明確規範其中。除非另有說明，此報告結果僅對檢驗之樣品負責。本報告未經本公司書面許可，不可部份複製。對本報告內容或外觀之任何未經授權之變更、偽造、竄改皆屬非法，違犯者將會被依法追訴。

Conducted Emission Measurement

File :ER-2008-20007(SGS上海Data :#40

80.0 dBuV

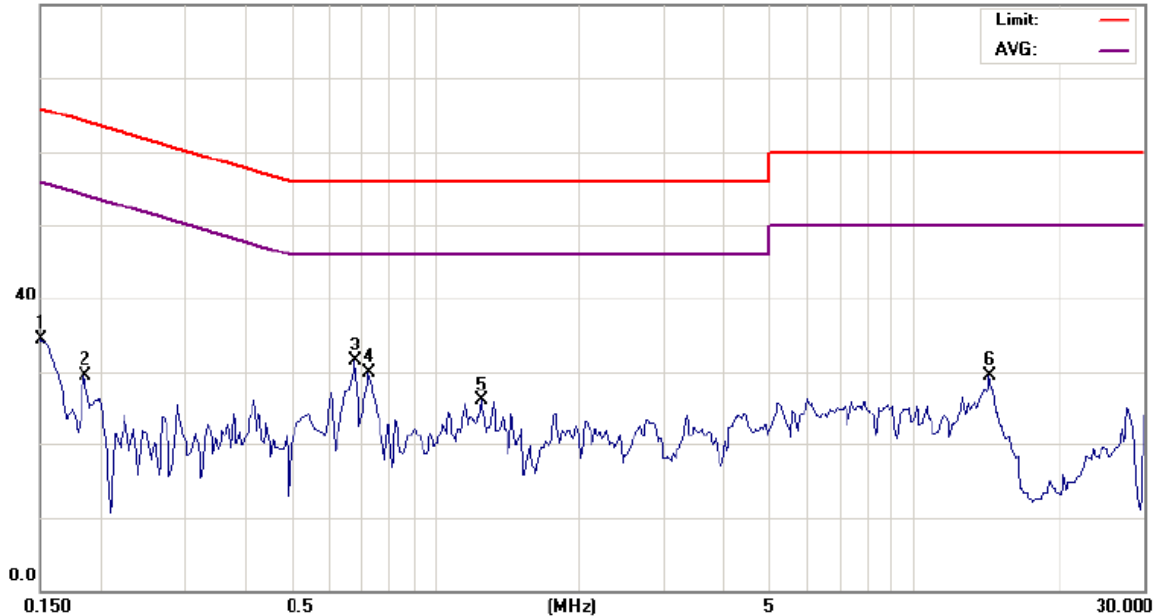

Site SGS CONDUCTED #1

Phase: N

Temperature: 22 °C

Limit: CISPR22 Class B Conduction(QP)

Power: AC 120V/60Hz

Humidity: 57 %

EUT: MO300QBM

Distance:

Air Pressure: hpa

M/N: MO300QBM

Note: GSM 850 LINK

No.	Mk.	Freq. MHz	Reading Level dBuV	Factor dB	Measure- ment dBuV	Limit dBuV	Over dB	Detector	Comment
1		0.1500	33.28	1.18	34.46	66.00	-31.54	peak	
2		0.1850	29.04	0.37	29.41	64.26	-34.85	peak	
3	*	0.6800	31.39	0.02	31.41	56.00	-24.59	peak	
4		0.7250	29.84	0.02	29.86	56.00	-26.14	peak	
5		1.2500	26.12	0.02	26.14	56.00	-29.86	peak	
6		14.3800	29.18	0.35	29.53	60.00	-30.47	peak	

AC POWER LINE CONDUCTED EMISSION TEST DATA

Operation Mode:	GSM 1900 LINK			Test Date:	Feb. 15, 2008
Temperature:	22 °C	Humidity:	57%	Test By:	Sky

Conducted Emission Measurement

File :ER-2008-20007(SGS上海Data :#45

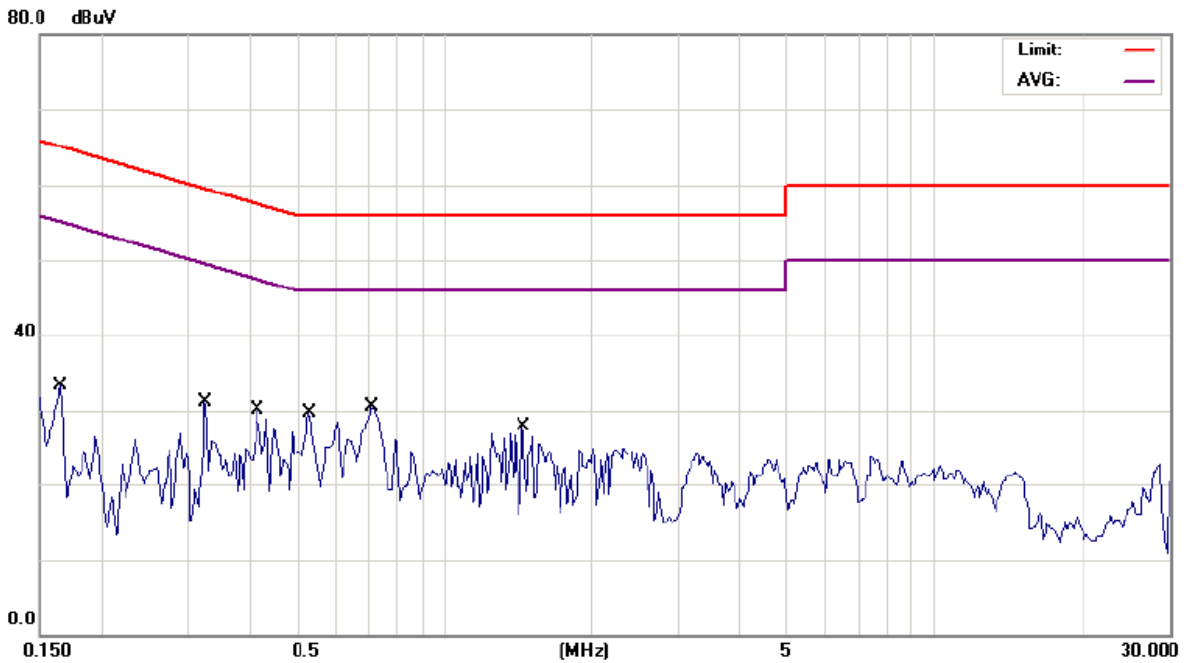

Site SGS CONDUCTED #1

Limit: CISPR22 Class B Conduction(QP)

EUT: MO300QBM

M/N: MO300QBM

Note: GSM 1900 LINK

Phase: L1

Power: AC 120V/60Hz

Distance:

Temperature: 22 °C

Humidity: 57 %

Air Pressure: hpa

No.	Mk.	Freq. MHz	Reading Level dBuV	Factor dB	Measure- ment dBuV	Limit dBuV	Over dB	Detector	Comment
1		0.1650	32.54	0.83	33.37	65.21	-31.84	QP	
2		0.3250	31.07	0.02	31.09	59.58	-28.49	QP	
3		0.4150	30.18	0.02	30.20	57.55	-27.35	QP	
4		0.5300	29.77	0.02	29.79	56.00	-26.21	QP	
5	*	0.7100	30.47	0.02	30.49	56.00	-25.51	QP	
6		1.4450	27.80	0.02	27.82	56.00	-28.18	QP	

This document is issued by the Company subject to its General Conditions of Service which is available on request or accessible at www.sgs.com. Attention is drawn to the limitations of liability, indemnification and jurisdictional issues defined therein. Unless otherwise stated, the results shown in this test report refer only to the sample(s) tested. This document cannot be reproduced except in full, without prior approval of the Company. Any unauthorized alteration, forgery or falsification of the content or appearance of this report is unlawful and offenders may be prosecuted to the fullest extent of the law. 此報告是遵循本公司訂定之通用服務條款所製作發放，相關服務條款備索，或可在 www.sgs.com 中查閱，本公司之義務、免責、管轄權皆明確規範其中。除非另有說明，此報告結果僅對檢驗之樣品負責。本報告未經本公司書面許可，不可部份複製。對本報告內容或外觀之任何未經授權之變更、偽造、竄改皆屬非法，違犯者將會被依法追訴。

Conducted Emission Measurement

File :ER-2008-20007(SGS上海Data :#46

80.0 dBuV

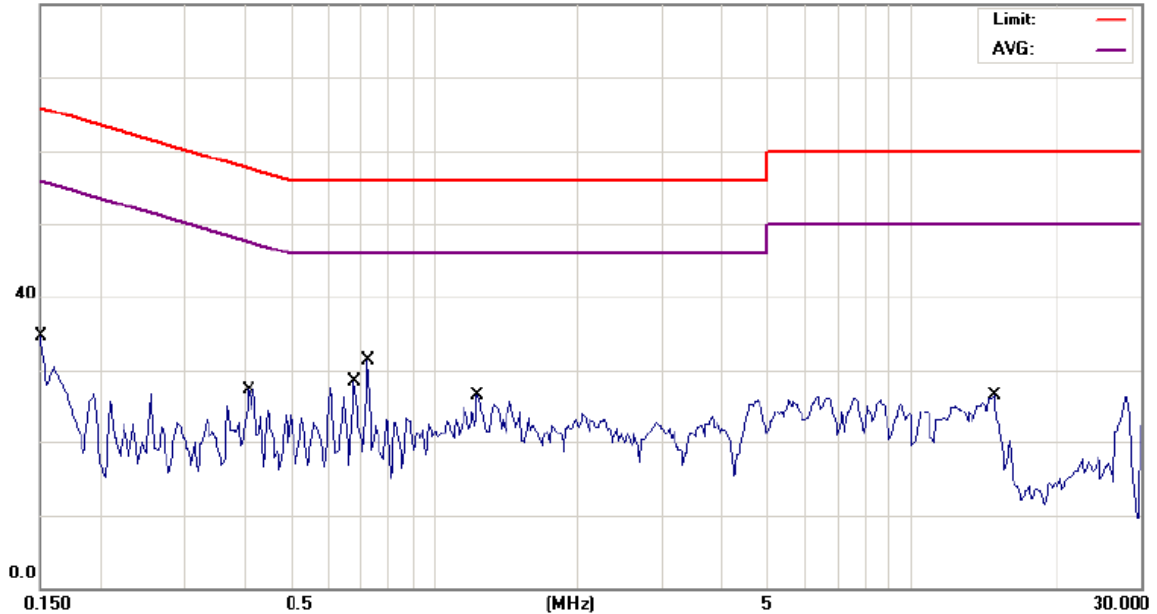

Site SGS CONDUCTED #1

Phase: **N**

Temperature: 22 °C

Limit: CISPR22 Class B Conduction(QP)

Power: AC 120V/60Hz

Humidity: 57 %

EUT: MO300QBM

Distance:

Air Pressure: hpa

M/N: MO300QBM

Note: GSM 1900 LINK

No.	Mk.	Freq. MHz	Reading Level dBuV	Factor dB	Measure- ment dBuV	Limit dBuV	Over dB	Detector	Comment
1		0.1500	33.58	1.18	34.76	66.00	-31.24	QP	
2		0.4100	27.36	0.02	27.38	57.65	-30.27	QP	
3		0.6800	28.56	0.02	28.58	56.00	-27.42	QP	
4	*	0.7250	31.25	0.02	31.27	56.00	-24.73	QP	
5		1.2350	26.44	0.02	26.46	56.00	-29.54	QP	
6		14.9200	26.08	0.37	26.45	60.00	-33.55	QP	

This document is issued by the Company subject to its General Conditions of Service which is available on request or accessible at www.sgs.com. Attention is drawn to the limitations of liability, indemnification and jurisdictional issues defined therein. Unless otherwise stated, the results shown in this test report refer only to the sample(s) tested. This document cannot be reproduced except in full, without prior approval of the Company. Any unauthorized alteration, forgery or falsification of the content or appearance of this report is unlawful and offenders may be prosecuted to the fullest extent of the law. 此報告是遵循本公司訂定之通用服務條款所製作發放，相關服務條款備索，或可在 www.sgs.com 中查閱，本公司之義務、免責、管轄權皆明確規範其中。除非另有說明，此報告結果僅對檢驗之樣品負責。本報告未經本公司書面許可，不可部份複製。對本報告內容或外觀之任何未經授權之變更、偽造、竄改皆屬非法，違犯者將會被依法追訴。

APPENDIX 1

PHOTOGRAPHS OF SET UP

This document is issued by the Company subject to its General Conditions of Service which is available on request or accessible at www.sgs.com. Attention is drawn to the limitations of liability, indemnification and jurisdictional issues defined therein. Unless otherwise stated, the results shown in this test report refer only to the sample(s) tested. This document cannot be reproduced except in full, without prior approval of the Company. Any unauthorized alteration, forgery or falsification of the content or appearance of this report is unlawful and offenders may be prosecuted to the fullest extent of the law. 此報告是遵循本公司訂定之通用服務條款所製作發放，相關服務條款備索，或可在 www.sgs.com 中查閱，本公司之義務、免責、管轄權皆明確規範其中。除非另有說明，此報告結果僅對檢驗之樣品負責。本報告未經本公司書面許可，不可部份複製。對本報告內容或外觀之任何未經授權之變更、偽造、竄改皆屬非法，違犯者將會被依法追訴。

Radiated Emission Set up Photos



This document is issued by the Company subject to its General Conditions of Service which is available on request or accessible at www.sgs.com. Attention is drawn to the limitations of liability, indemnification and jurisdictional issues defined therein. Unless otherwise stated, the results shown in this test report refer only to the sample(s) tested. This document cannot be reproduced except in full, without prior approval of the Company. Any unauthorized alteration, forgery or falsification of the content or appearance of this report is unlawful and offenders may be prosecuted to the fullest extent of the law. 此報告是遵循本公司訂定之通用服務條款所製作發放，相關服務條款備索，或可在 www.sgs.com 中查閱，本公司之義務、免責、管轄權皆明確規範其中。除非另有說明，此報告結果僅對檢驗之樣品負責。本報告未經本公司書面許可，不可部份複製。對本報告內容或外觀之任何未經授權之變更、偽造、竄改皆屬非法，違犯者將會被依法追訴。

Conducted Emission Set up Photos

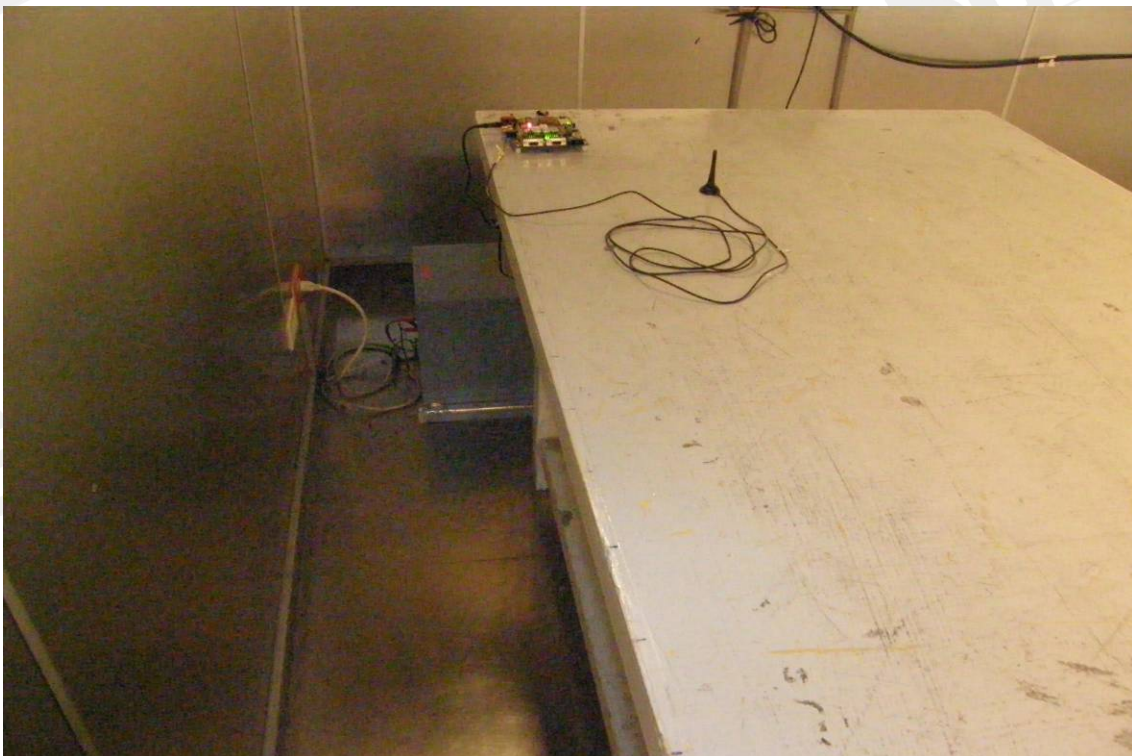

This document is issued by the Company subject to its General Conditions of Service which is available on request or accessible at www.sgs.com. Attention is drawn to the limitations of liability, indemnification and jurisdictional issues defined therein. Unless otherwise stated, the results shown in this test report refer only to the sample(s) tested. This document cannot be reproduced except in full, without prior approval of the Company. Any unauthorized alteration, forgery or falsification of the content or appearance of this report is unlawful and offenders may be prosecuted to the fullest extent of the law. 此報告是遵循本公司訂定之通用服務條款所製作發放，相關服務條款備索，或可在 www.sgs.com 中查閱，本公司之義務、免責、管轄權皆明確規範其中。除非另有說明，此報告結果僅對檢驗之樣品負責。本報告未經本公司書面許可，不可部份複製。對本報告內容或外觀之任何未經授權之變更、偽造、竄改皆屬非法，違犯者將會被依法追訴。

APPENDIX 2

PHOTOGRAPHS OF EUT

This document is issued by the Company subject to its General Conditions of Service which is available on request or accessible at www.sgs.com. Attention is drawn to the limitations of liability, indemnification and jurisdictional issues defined therein. Unless otherwise stated, the results shown in this test report refer only to the sample(s) tested. This document cannot be reproduced except in full, without prior approval of the Company. Any unauthorized alteration, forgery or falsification of the content or appearance of this report is unlawful and offenders may be prosecuted to the fullest extent of the law. 此報告是遵循本公司訂定之通用服務條款所製作發放，相關服務條款備索，或可在 www.sgs.com 中查閱，本公司之義務、免責、管轄權皆明確規範其中。除非另有說明，此報告結果僅對檢驗之樣品負責。本報告未經本公司書面許可，不可部份複製。對本報告內容或外觀之任何未經授權之變更、偽造、竄改皆屬非法，違犯者將會被依法追訴。

Front View of EUT - 1



Open View of EUT

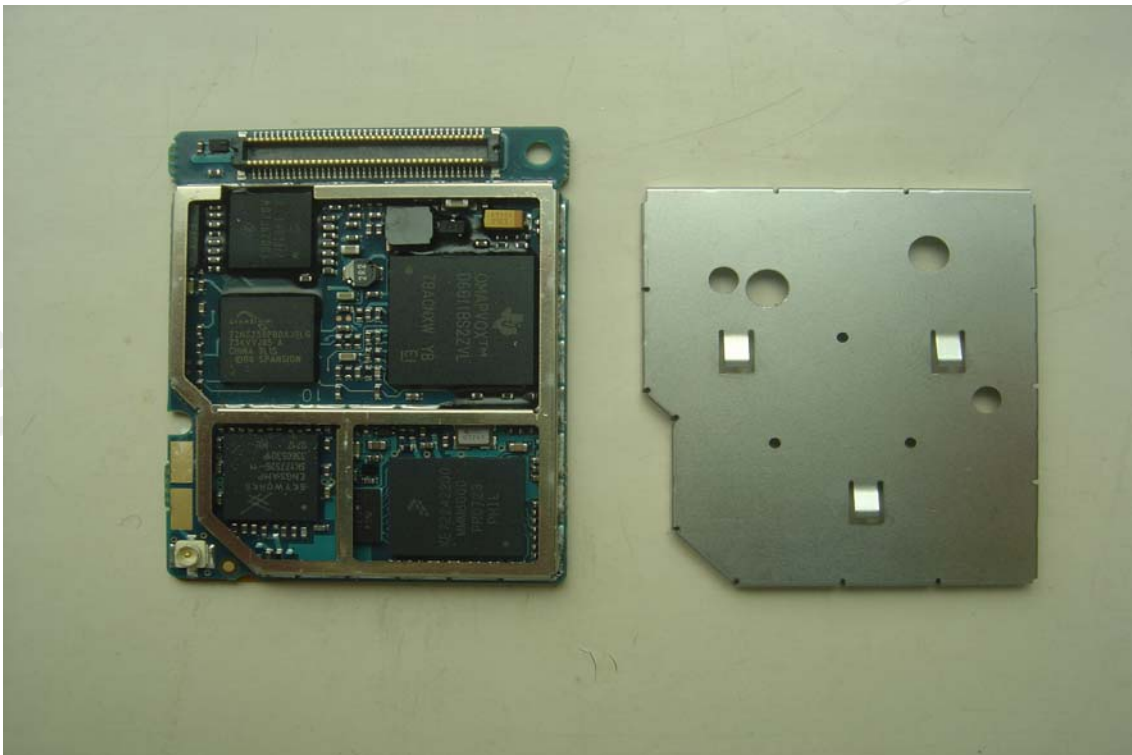

This document is issued by the Company subject to its General Conditions of Service which is available on request or accessible at www.sgs.com. Attention is drawn to the limitations of liability, indemnification and jurisdictional issues defined therein. Unless otherwise stated, the results shown in this test report refer only to the sample(s) tested. This document cannot be reproduced except in full, without prior approval of the Company. Any unauthorized alteration, forgery or falsification of the content or appearance of this report is unlawful and offenders may be prosecuted to the fullest extent of the law. 此報告是遵循本公司訂定之通用服務條款所製作發放，相關服務條款備索，或可在 www.sgs.com 中查閱，本公司之義務、免責、管轄權皆明確規範其中。除非另有說明，此報告結果僅對檢驗之樣品負責。本報告未經本公司書面許可，不可部份複製。對本報告內容或外觀之任何未經授權之變更、偽造、竄改皆屬非法，違犯者將會被依法追訴。

Front View of EUT - 2



Back View of EUT



This document is issued by the Company subject to its General Conditions of Service which is available on request or accessible at www.sgs.com. Attention is drawn to the limitations of liability, indemnification and jurisdictional issues defined therein. Unless otherwise stated, the results shown in this test report refer only to the sample(s) tested. This document cannot be reproduced except in full, without prior approval of the Company. Any unauthorized alteration, forgery or falsification of the content or appearance of this report is unlawful and offenders may be prosecuted to the fullest extent of the law. 此報告是遵循本公司訂定之通用服務條款所製作發放，相關服務條款備索，或可在 www.sgs.com 中查閱，本公司之義務、免責、管轄權皆明確規範其中。除非另有說明，此報告結果僅對檢驗之樣品負責。本報告未經本公司書面許可，不可部份複製。對本報告內容或外觀之任何未經授權之變更、偽造、竄改皆屬非法，違犯者將會被依法追訴。



- End of Report -