

# **FCC Part22H&24E Test Report Industry Canada RSS-132/RSS-133**

Product Name : GSM/GPRS Module  
Model No. : HiloNCV2  
FCC ID : VW3HILONCV2  
IC : 9140A-HILONCV2

Applicant : Sagemcom

Address : 250 route de l'empereur, 92848, France

Date of Receipt : Sep. 29, 2010  
Test Date : Sep. 29, 2010 ~Oct. 08, 2010  
Issued Date : Oct. 09, 2010  
Report No. : 109S034R-HP-US-P07V01  
Report Version : V 2.1

The test results relate only to the samples tested.

The test results shown in the test report are traceable to the national/international standard through the calibration of the equipment and evaluated measurement uncertainty herein.

This report must not be used to claim product endorsement by TAF, NVLAP, NIST or any agency of the Government.

The test report shall not be reproduced except in full without the written approval of QuieTek Corporation.

# Test Report Certification

Issued Date : Oct. 09, 2010

Report No. : 109S034R-HP-US-P07V01



Product Name : GSM/GPRS Module

Applicant : Sagemcom

Address : 250 route de l'empereur, 92848, France

Manufacturer : Sagemcom

Address : 250 route de l'empereur, 92848, France

Model No. : HiloNCV2

FCC ID : VW3HILONCV2

IC : 9140A-HILONCV2

EUT Voltage : Normal 3.7V/High 4.5V/Low 3.3V

Brand Name : Sagemcom

Applicable Standard : FCC CFR Title 47 Part 2,TIA/EIA 603-C, RSS-GEN Issue 2  
 FCC Part22 Subpart H, FCC Part24 Subpart E  
 Industry Canada RSS-132, Issue 2  
 Industry Canada RSS-133, Issue 5

Test Result : Complied

Performed Location : SuZhou EMC Laboratory  
 No.99 Hongye Rd., Suzhou Industrial Park Loufeng Hi-Tech  
 Development Zone., SuZhou, China  
 TEL: +86-512-6251-5088 / FAX: +86-512-6251-5098  
 FCC Registration Number: 800392, IC Lab Code: 4075B

Documented By : *Alice Ni*  
 ( Engineering ADM: Alice Ni )

Reviewed By : *Marlinchen*  
 ( Engineering Supervisor: Marlin Chen )

Approved By : *Dream Cao*  
 ( Engineering Manager: Dream Cao )

## Laboratory Information

We, **Quietek Corporation**, are an independent EMC and safety consultancy that was established the whole facility in our laboratories. The test facility has been accredited/accepted(audited or listed) by the following related bodies in compliance with ISO 17025, EN 45001 and specified testing scope:

<b>Taiwan R.O.C.</b>	<b>: BSMI, NCC, TAF</b>
<b>Germany</b>	<b>: TUV Rheinland</b>
<b>Norway</b>	<b>: Nemko, DNV</b>
<b>USA</b>	<b>: FCC, NVLAP</b>
<b>Japan</b>	<b>: VCCI</b>

The related certificate for our laboratories about the test site and management system can be downloaded from Quietek Corporation's Web Site : <http://www.quietek.com/tw/ctg/cts/accreditations.htm>  
 The address and introduction of Quietek Corporation's laboratories can be founded in our Web site : <http://www.quietek.com/>  
 If you have any comments, Please don't hesitate to contact us. Our contact information is as below:

### HsinChu Testing Laboratory :

No.75-2, 3rd Lin, Wangye Keng, Yonghxing Tsuen, Qionglin Shiang, Hsinchu County 307, Taiwan, R.O.C.  
 TEL:+886-3-592-8858 / FAX:+886-3-592-8859 E-Mail : [service@quietek.com](mailto:service@quietek.com)



### LinKou Testing Laboratory :

No. 5-22, Ruei-Shu Valley, Ruei-Ping Tsuen, Lin-Kou Shiang, Taipei, Taiwan, R.O.C.  
 TEL : 886-2-8601-3788 / FAX : 886-2-8601-3789 E-Mail : [service@quietek.com](mailto:service@quietek.com)



### Suzhou (China) Testing Laboratory :

No. 99 Hongye Rd., Suzhou Industrial Park Loufeng Hi-Tech Development Zone., Suzhou,China.  
 TEL : +86-512-6251-5088 / FAX : +86-512-6251-5098 E-Mail : [service@quietek.com](mailto:service@quietek.com)



**TABLE OF CONTENTS**

Description	Page
1. General Information .....	6
1.1. EUT Description .....	6
1.2. Mode of Operation .....	7
1.3. Tested System Details .....	8
1.4. Configuration of Tested System .....	9
1.5. EUT Exercise Software .....	10
2. Technical Test .....	11
2.1. Summary of Test Result .....	11
2.2. Test Environment .....	12
3. Peak Output Power.....	13
3.1. Test Equipment .....	13
3.2. Test Setup .....	14
3.3. Limit .....	14
3.4. Test Procedure .....	15
3.5. Uncertainty .....	16
3.6. Test Result .....	17
3.7. Test Photograph .....	19
4. Occupied Bandwidth.....	21
4.1. Test Equipment .....	21
4.2. Test Setup .....	21
4.3. Limit .....	22
4.4. Test Procedure .....	22
4.5. Uncertainty .....	22
4.6. Test Result .....	23
5. Spurious Emission At Antenna Terminals (+/- 1MHz).....	27
5.1. Test Equipment .....	27
5.2. Test Setup .....	27
5.3. Limit .....	28
5.4. Test Procedure .....	28
5.5. Uncertainty .....	28
5.6. Test Result .....	29
6. Spurious Emission .....	31
6.1. Test Equipment .....	31
6.2. Test Setup .....	32
6.3. Limit .....	32
6.4. Test Procedure .....	33

---

- 6.5. Uncertainty ..... 34
- 6.6. Test Result ..... 35
- 6.7. Test Photograph ..... 37
- 7. Frequency Stability Under Temperature & Voltage Variations ..... 39
  - 7.1. Test Equipment ..... 39
  - 7.2. Test Setup ..... 39
  - 7.3. Limit ..... 40
  - 7.4. Test Procedure ..... 40
  - 7.5. Uncertainty ..... 40
  - 7.6. Test Result ..... 41
- 8. Receiver Spurious Emission for RSS 132/133..... 43
  - 8.1. Test Equipment ..... 43
  - 8.2. Test Setup ..... 44
  - 8.3. Limit ..... 45
  - 8.4. Test Procedure ..... 45
  - 8.5. Uncertainty ..... 46
  - 8.6. Test Result ..... 47
- 9. Attachment ..... 55
  - EUT Photograph ..... 55

**1. General Information**

**1.1. EUT Description**

Product Name		GSM/GPRS Module		
Brand Name		Sagemcom		
Model No.		HiloNCV2		
Working Voltage		Normal 3.7V/High 4.5V/Low 3.3V		
Mode	GPRS	Band	UL Frequency (MHz)	DL Frequency (MHz)
		850	824~849	869~894
		1900	1850~1910	1930~1990
Channel Control		Auto		
Modulation Type		GMSK		

Antenna used for testing:

Antenna type	Monopole
Antenna Gain	0.45dBi for GSM 850. 0.61dBi for PCS 1900.

**1.2. Mode of Operation**

QuieTek has verified the construction and function in typical operation. All the test modes were carried out with the EUT in normal operation, which was shown in this test report and defined as:

Test Mode
Mode 1: GPRS850
Mode 2: GPRS1900

**1.3. Tested System Details**

The types for all equipments, plus descriptions of all cables used in the tested system (including inserted cards) are:

Product		Manufacturer	Model No.	Serial No.	Power Cord
1	CMU200	R&S	CMU200	N/A	N/A



### 1.4. Configuration of Tested System

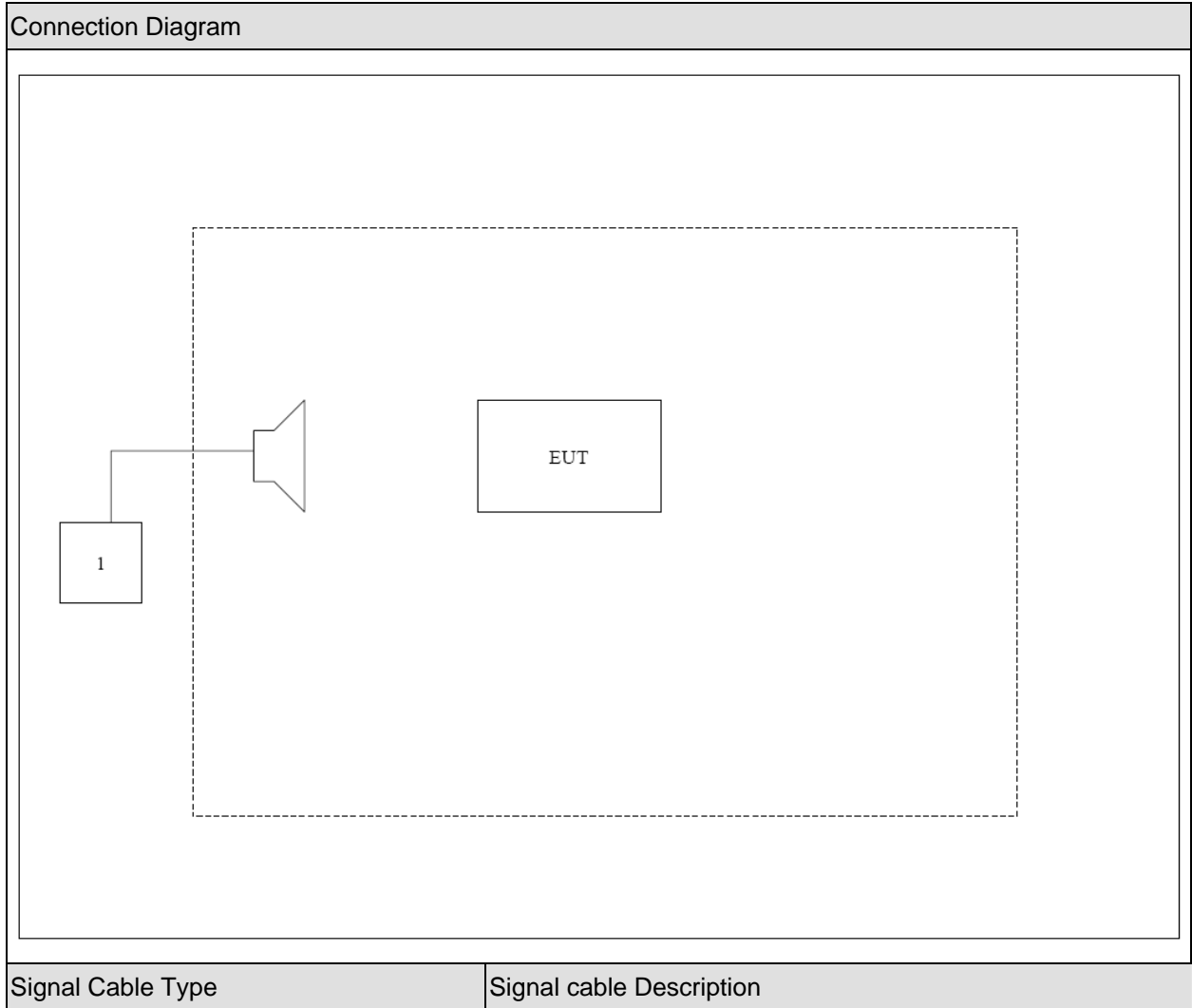

**1.5. EUT Exercise Software**

1	Setup the EUT and simulators as shown on above.
2	Turn on the power of all equipment.
3	EUT Communicate with CMU200, then select channel to test.

**2. Technical Test**

**2.1. Summary of Test Result**

- No deviations from the test standards
- Deviations from the test standards as below description:

For GPRS850 (FCC Part 22H & Part 2)

Emission			
Performed Item	Normative References	Test Performed	Deviation
Peak Output Power	FCC Part 22.913(a)(2) and Part 2.1046	Yes	No
Modulation Characteristic	FCC Part 2.1047(d)	Yes	No
Occupied Bandwidth	FCC Part 2.1049	Yes	No
Spurious Emission At Antenna Terminals (+/- 1MHz)	FCC Part 22.917(a) and Part 2.1049	Yes	No
Spurious Emission	FCC Part 22.917(b) and Part 2.1051, 2.1053	Yes	No
Frequency Stability Under Temperature & Voltage Variations	FCC Part 22.355 and 2.1055	Yes	No

For GPRS1900 (FCC Part 24E & Part 2)

Emission			
Performed Item	Normative References	Test Performed	Deviation
Peak Output Power	FCC Part 24.232(b) and Part 2.1046	Yes	No
Modulation Characteristic	FCC Part 2.1047(d)	Yes	No
Occupied Bandwidth	FCC Part 24.238(b) and Part 2.1049	Yes	No
Spurious Emission At Antenna Terminals (+/- 1MHz)	FCC Part 24.238(a) and Part 2.1049	Yes	No
Spurious Emission	FCC Part 24.238(b) and Part 2.1051, 2.1053	Yes	No
Frequency Stability Under Temperature & Voltage Variations	FCC Part 24.235 and 2.1055	Yes	No

**2.2. Test Environment**

Items	Required (IEC 68-1)	Actual
Temperature (°C)	15-35	23
Humidity (%RH)	25-75	52
Barometric pressure (mbar)	860-1060	950-1000

**3. Peak Output Power**

**3.1. Test Equipment**

Peak Output Power / AC-5

Instrument	Manufacturer	Type No.	Serial No	Cal. Date
PSA Series Spectrum Analyzer	Agilent	E4440A	MY49420184	2010.04.10
Radio Communication Tester	R&S	CMU 200	117088	2010.07.12
Dual Directional Coupler	Agilent	778D	20160	2010.04.20
10dB Coaxial Coupler	Agilent	87300C	MY44300299	2010.04.20
PSG Analog Signal Generator	Agilent	E8257D	MY44321116	2010.04.23
Preamplifier	QuieTek	AP-025C	CHM-0503006	2010.05.05
Preamplifier	Miteq	NSP1800-25	1364185	2010.05.05
Bilog Antenna	Teseq GmbH	CBL6112D	27612	2009.11.12
Half Wave Tuned Dipole Antenna	COM-POWER	AD-100	40137	2009.11.24
Broad-Band Horn Antenna	Schwarzbeck	BBHA9120D	737	2009.11.24
Broad-Band Horn Antenna	Schwarzbeck	BBHA9120D	499	2010.06.11
Temperature/Humidity Meter	Zhicheng	ZC1-2	AC5-TH	2010.01.14

### 3.2. Test Setup

Conducted Power Measurement:

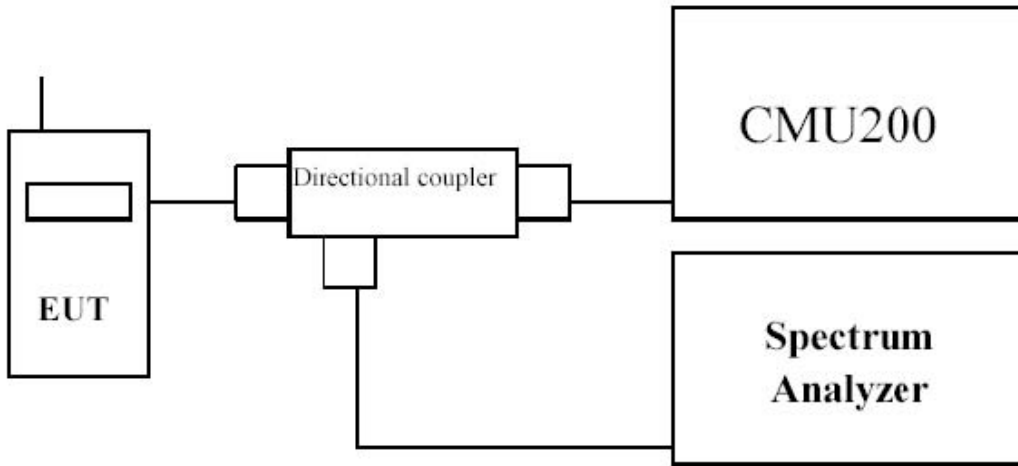

Radiated Power Measurement:

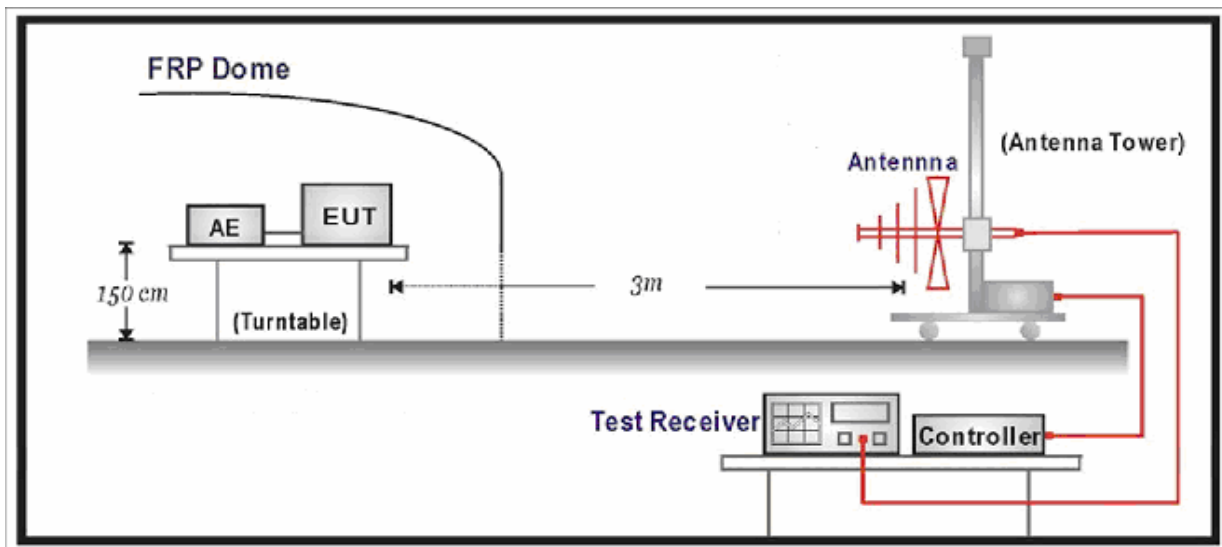

### 3.3. Limit

**For FCC Part 22.913(a)(2):**

The ERP of mobile transmitters and auxiliary test transmitters must not exceed 7 Watts.

**For FCC Part 24.232(b):**

The EIRP of mobile transmitters and auxiliary test transmitters must not exceed 2 Watts.

### 3.4. Test Procedure

**Conducted Power Measurement:**

- a) Place the EUT on a bench and set it in transmitting mode.
- b) Connect a low loss RF cable from the antenna port to a spectrum analyzer and CMU200 by a Directional Couple.
- c) EUT Communicate with CMU200, then selects a channel for testing.
- d) Add a correction factor to the display of spectrum, and then test.

**Radiated Power Measurement:**

- e) The EUT shall be placed at the specified height on a support, and in the position closest to normal use as declared by provider.
- f) The test antenna shall be oriented initially for vertical polarization and shall be chosen to correspond to the frequency of the transmitter
- g) The output of the test antenna shall be connected to the measuring receiver.
- h) The transmitter shall be switched on and the measuring receiver shall be tuned to the frequency of the transmitter under test.
- i) The test antenna shall be raised and lowered through the specified range of height until a maximum signal level is detected by the measuring receiver.
- j) The transmitter shall then be rotated through 360° in the horizontal plane, until the maximum signal level is detected by the measuring receiver.
- k) The test antenna shall be raised and lowered again through the specified range of height until a maximum signal level is detected by the measuring receiver.
- l) The maximum signal level detected by the measuring receiver shall be noted.
- m) The transmitter shall be replaced by a substitution antenna.
- n) The substitution antenna shall be orientated for vertical polarization and the length of the substitution antenna shall be adjusted to correspond to the frequency of the transmitter.
- o) The substitution antenna shall be connected to a calibrated signal generator.
- p) If necessary, the input attenuator setting of the measuring receiver shall be adjusted in order to increase the sensitivity of the measuring receiver.
- q) The test antenna shall be raised and lowered through the specified range of height to ensure that the maximum signal is received.
- r) The input signal to the substitution antenna shall be adjusted to the level that produces a level detected by the measuring receiver, that is equal to the level noted while the transmitter radiated power was measured, corrected for the change of input attenuator setting of the measuring receiver.
- s) The measurement shall be repeated with the test antenna and the substitution antenna orientated for horizontal polarization.

- t) The measure of the effective radiated power is the larger of the two levels recorded at the input to the substitution antenna, corrected for gain of the substitution antenna if necessary.

**Base station simulator settings for each test mode:**

1. For GPRS

Configure R&S CMU200 to support GMSK call, and set one timeslot transmission for GMSK GSM/GPRS.

Measure and record power outputs for both modulations.

### **3.5. Uncertainty**

The measurement uncertainty is defined as for Conducted Power Measurement  $\pm 1.2$  dB, for Radiated Power Measurement  $\pm 3.2$  dB



3.6. Test Result

GPRS 850 (1 UL slot)

Channel No.	Frequency (MHz)	Modulation	Conducted Output Power (dBm)	ERP (dBm)	Limit (dBm)
128	824.2	GPRS	31.83	27.70	38.50
189	836.4	GPRS	32.22	<b>29.61</b>	38.50
251	848.8	GPRS	32.32	27.44	38.50

GPRS1900 (1 UL slot)

Channel No.	Frequency (MHz)	Modulation	Conducted Output Power (dBm)	EIRP (dBm)	Limit (dBm)
512	1850.2	GPRS	28.95	28.03	33.00
661	1880.0	GPRS	29.38	<b>28.37</b>	33.00
810	1909.8	GPRS	29.24	27.77	33.00

Note: All conducted measurements are based on a peak detector.

**Radiated Measurement**

**GPRS850**

Frequency (MHz)	SA Reading (dBm)	Ant.Pol. (H/V)	SG Reading (dBm)	Cable Loss (dB)	Gain (dBd)	ERP (dBm)	Limit (dBm)	Margin (dB)
<b>Low Channel 128</b>								
824.20	15.56	H	30.28	2.56	-0.02	27.70	38.5	-10.80
824.20	13.59	V	27.36	2.56	-0.02	24.78	38.5	-13.72
<b>Middle Channel 189</b>								
836.40	17.45	H	32.10	2.59	0.10	29.61	38.5	-8.89
836.40	14.48	V	28.37	2.59	0.10	25.88	38.5	-12.62
<b>High Channel 251</b>								
848.80	15.27	H	29.85	2.54	0.13	27.44	38.5	-11.06
848.80	11.77	V	25.81	2.54	0.13	23.40	38.5	-15.10

**GPRS1900**

Frequency (MHz)	SA Reading (dBm)	Ant.Pol. (H/V)	SG Reading (dBm)	Cable Loss (dB)	Gain (dBi)	EIRP (dBm)	Limit (dBm)	Margin (dB)
<b>Low Channel 512</b>								
1850.20	27.15	H	12.52	3.55	10.40	19.37	33	-13.63
1850.20	35.91	V	21.18	3.55	10.40	28.03	33	-4.97
<b>Middle Channel 661</b>								
1880.00	25.32	H	10.68	3.53	10.43	17.58	33	-15.42
1880.00	36.18	V	21.47	3.53	10.43	28.37	33	-4.63
<b>High Channel 810</b>								
1909.80	24.02	H	9.40	3.56	10.44	16.28	33	-16.72
1909.80	35.57	V	20.89	3.56	10.44	27.77	33	-5.23

### 3.7. Test Photograph

Description: ERP Test Setup

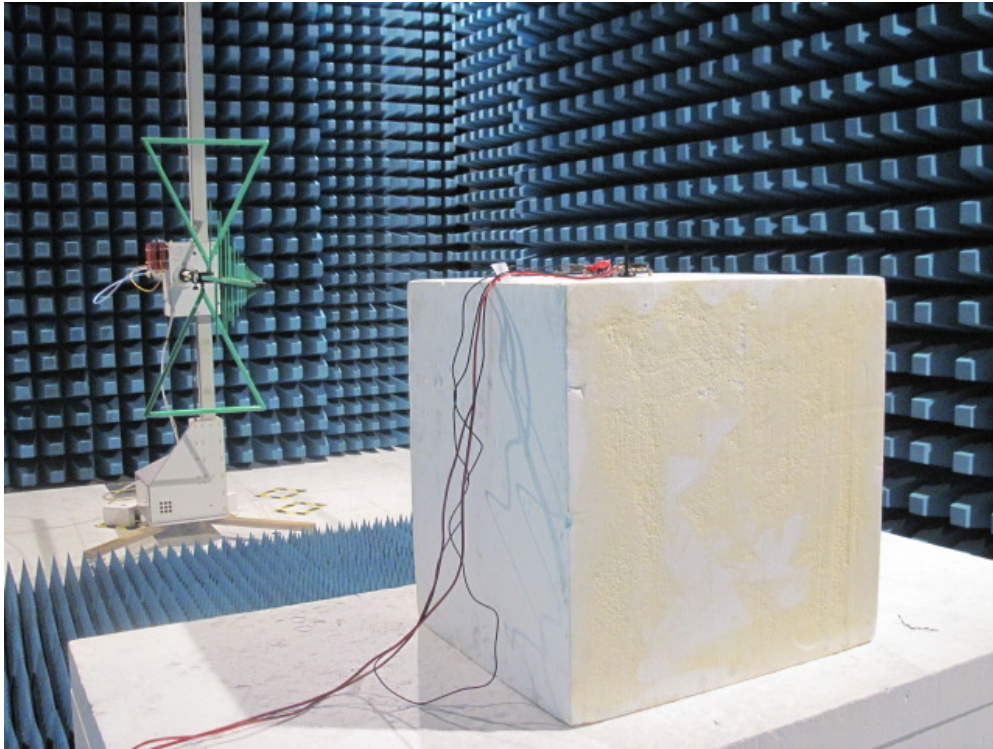

Description: Substitution Antenna for ERP Test





Description: EIRP Test Setup

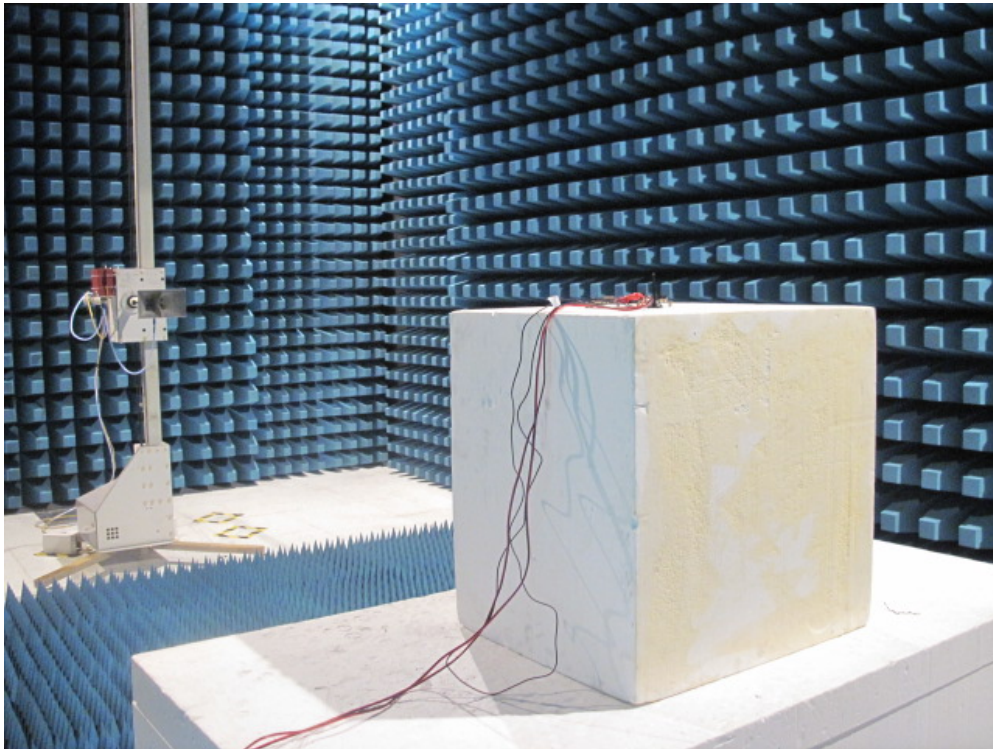

Description: Substitution Antenna for EIRP Test

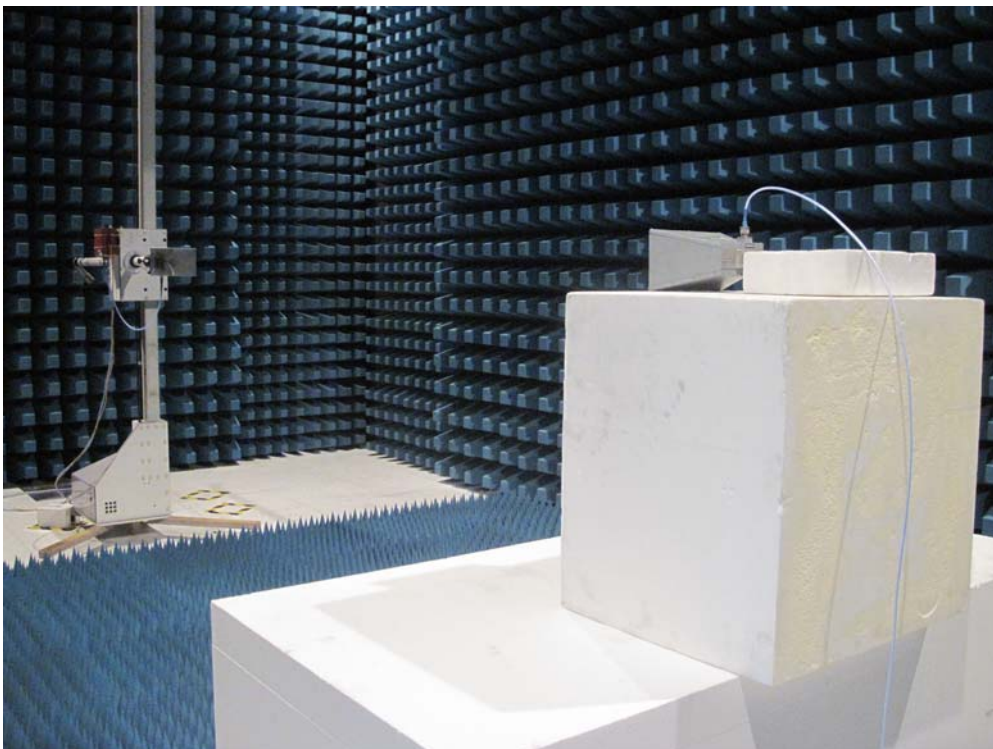

**4. Occupied Bandwidth**

**4.1. Test Equipment**

Occupied Bandwidth / AC-6

Instrument	Manufacturer	Type No.	Serial No	Cal. Date
PSA Series Spectrum Analyzer	Agilent	E4440A	MY49420184	2010.04.10
Radio Communication Tester	R&S	CMU 200	117088	2010.07.12
Dual Directional Coupler	Agilent	778D	20160	2010.04.20
10dB Coaxial Coupler	Agilent	87300C	MY44300299	2010.04.20
Temperature/Humidity Meter	Zhicheng	ZC1-2	AC6-TH	2010.01.14

**4.2. Test Setup**

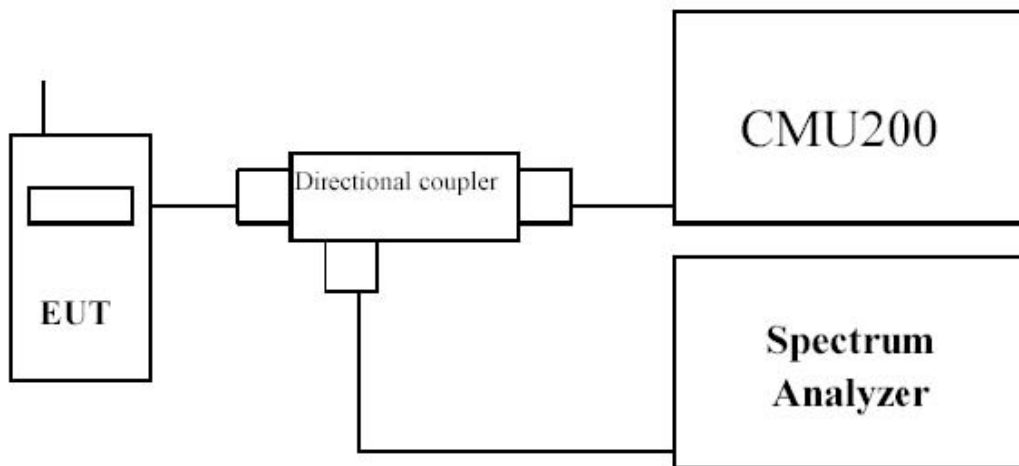

**4.3. Limit**

N/A

**4.4. Test Procedure**

Using Occupied Bandwidth measurement function of spectrum analyzer, and setting as follows:

For GPRS 850/1900 test --- RBW = 3 kHz and VBW = 10 kHz

**4.5. Uncertainty**

The measurement uncertainty is defined as  $\pm 10$  Hz

4.6. Test Result

Product	GSM/GPRS Module		
Test Item	Occupied Bandwidth		
Test Mode	Mode 1: GPRS850 Link		
Date of Test	2010/10/08	Test Site	AC-6

Channel No.	Frequency (MHz)	-26dB Occupied Bandwidth (kHz)	99% Occupied Bandwidth (kHz)
128	824.20	315.31	247.60
189	836.40	318.70	246.90
251	848.80	316.68	246.73

Figure Channel 128 (824.20MHz)

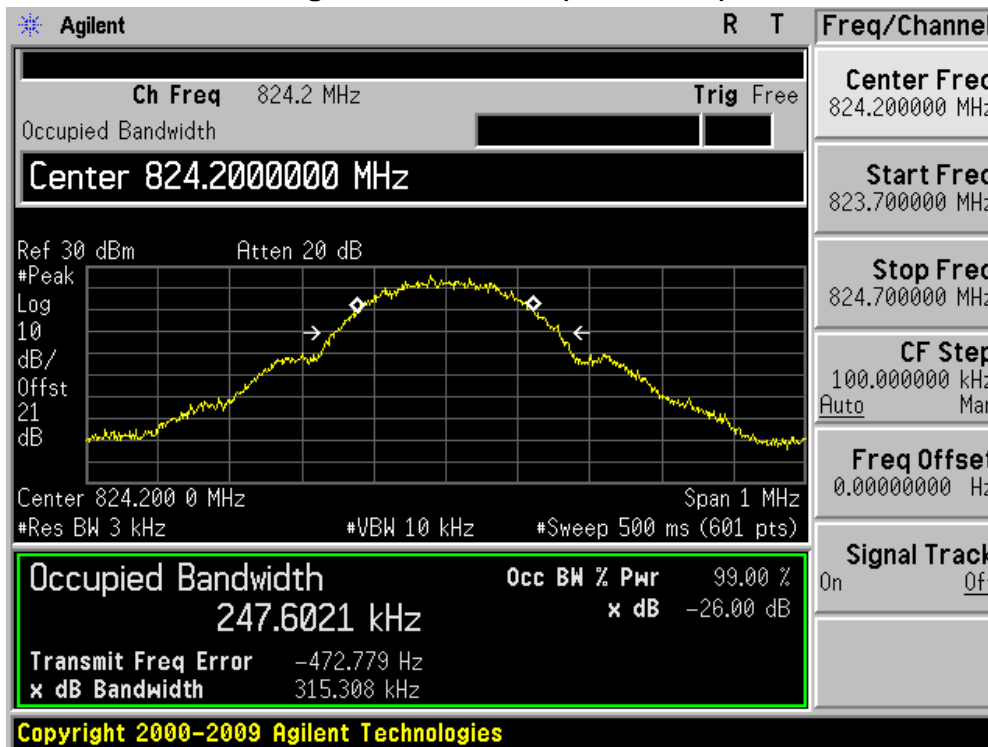

Figure Channel 189 (836.40MHz)

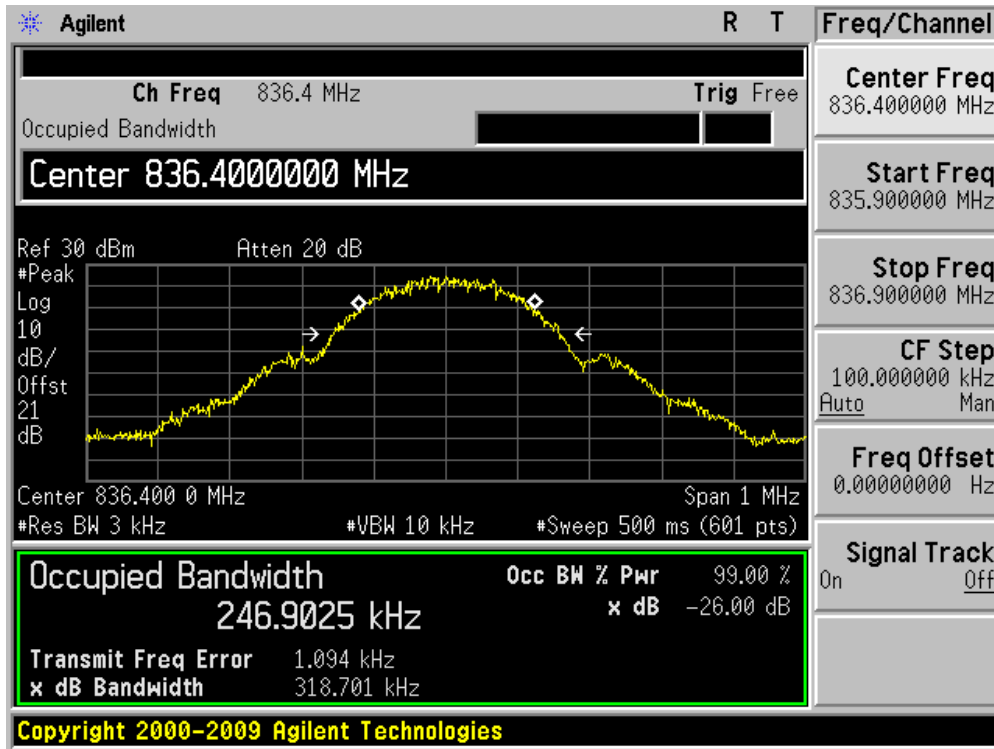
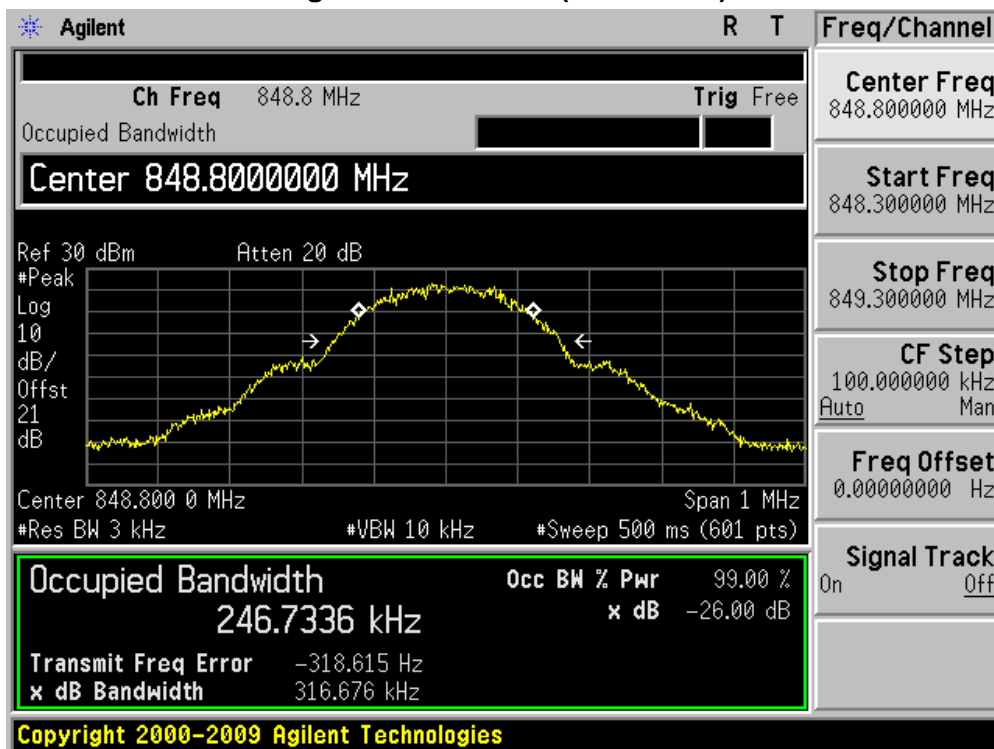

Figure Channel 251 (848.80MHz)





Product	GSM/GPRS Module		
Test Item	Occupied Bandwidth		
Test Mode	Mode 2: GPRS1900 Link		
Date of Test	2010/10/08	Test Site	AC-6

Channel No.	Frequency (MHz)	-26dB Occupied Bandwidth (kHz)	99% Occupied Bandwidth (kHz)
512	1850.20	316.99	247.20
661	1880.00	319.79	247.60
810	1909.80	317.21	246.13

Figure Channel 512 (1850.20MHz)

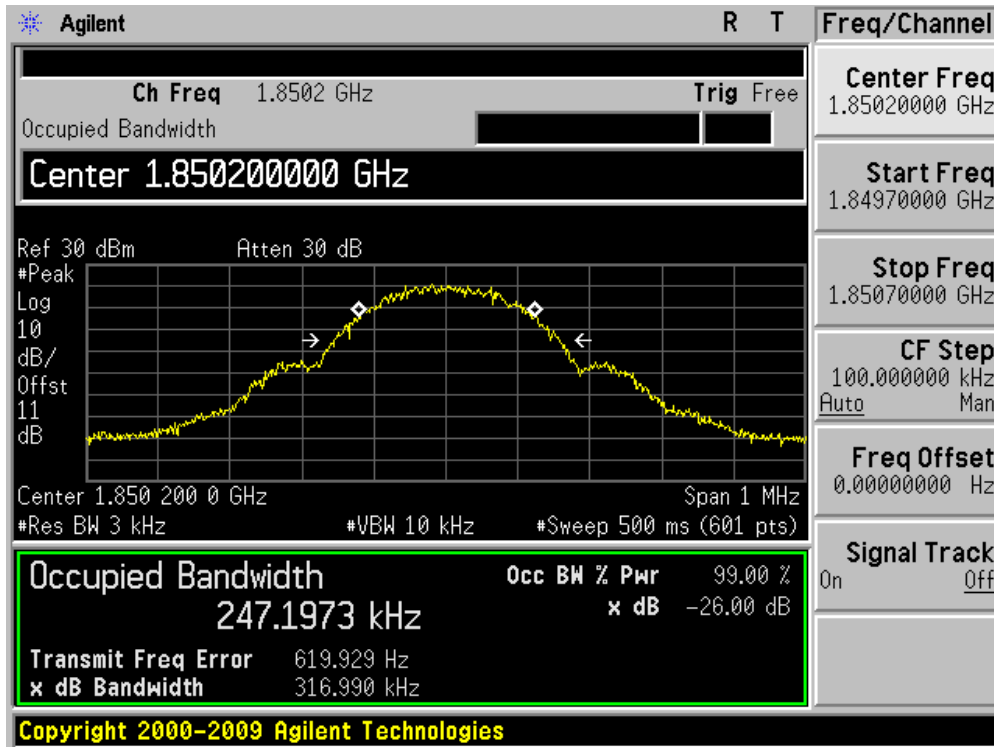

Figure Channel 661 (1880.00MHz)

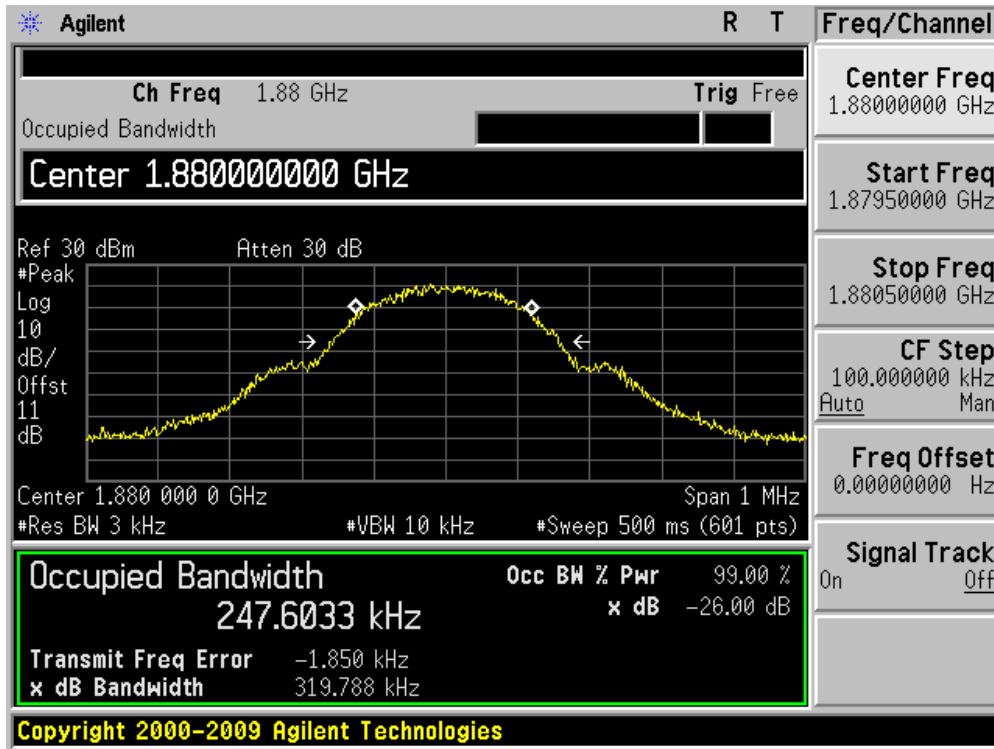
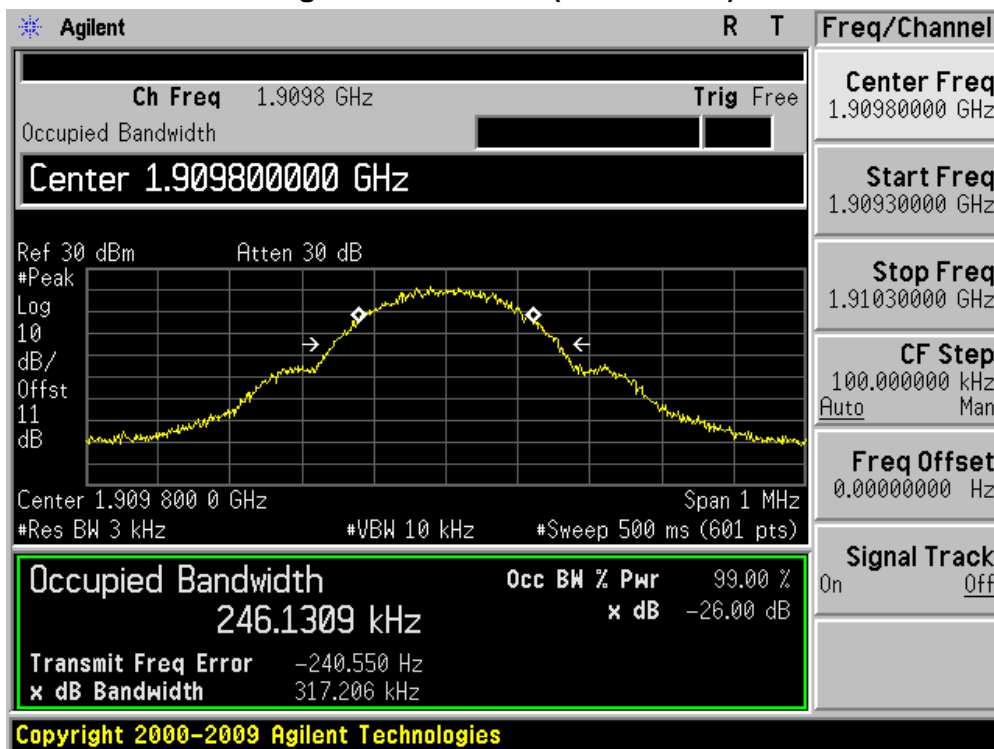

Figure Channel 810 (1909.80MHz)



**5. Spurious Emission At Antenna Terminals (+/- 1MHz)**

**5.1. Test Equipment**

Spurious Emission At Antenna Terminals (+/- 1MHz) / AC-6

Instrument	Manufacturer	Type No.	Serial No	Cal. Date
PSA Series Spectrum Analyzer	Agilent	E4440A	MY49420184	2010.04.10
Radio Communication Tester	R&S	CMU 200	117088	2010.07.12
Dual Directional Coupler	Agilent	778D	20160	2010.04.20
10dB Coaxial Coupler	Agilent	87300C	MY44300299	2010.04.20
Temperature/Humidity Meter	Zhicheng	ZC1-2	AC6-TH	2010.01.14

**5.2. Test Setup**

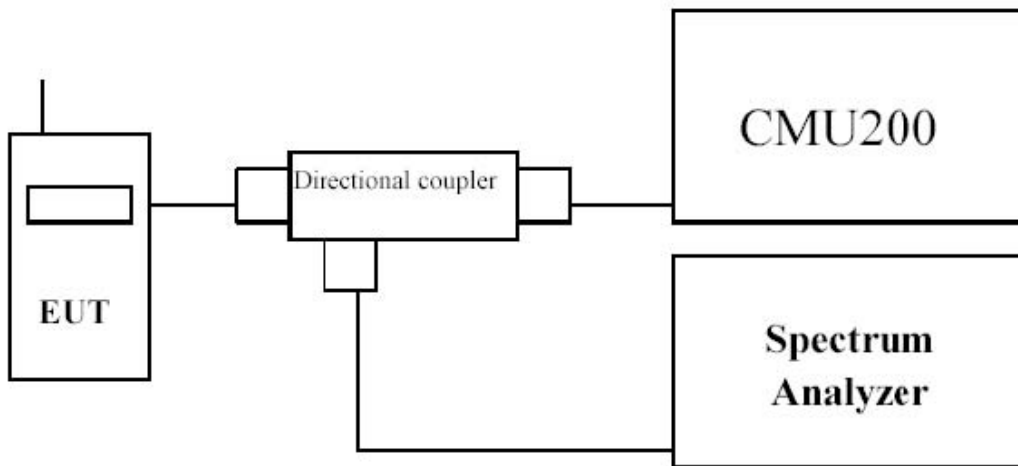

### **5.3. Limit**

The power of any emission outside of the authorized operating frequency ranges must be attenuated below the transmitting power (P) by a factor of at least  $43 + 10\log(P)$  dB.

### **5.4. Test Procedure**

In the 1MHz bands immediately outside and adjacent to the frequency block a resolution bandwidth of at least one percent of the emission bandwidth of the fundamental emission of the transmitter may be employed to measure the out of band Emissions.

### **5.5. Uncertainty**

The measurement uncertainty is defined as  $\pm 1.2$  dB.

5.6. Test Result

Product	GSM/GPRS Module		
Test Item	Spurious Emission At Antenna Terminals (+/- 1MHz)		
Test Mode	Mode 1: GPRS850 Link		
Date of Test	2010/10/08	Test Site	AC-6

Figure Channel 128 (824.20MHz)

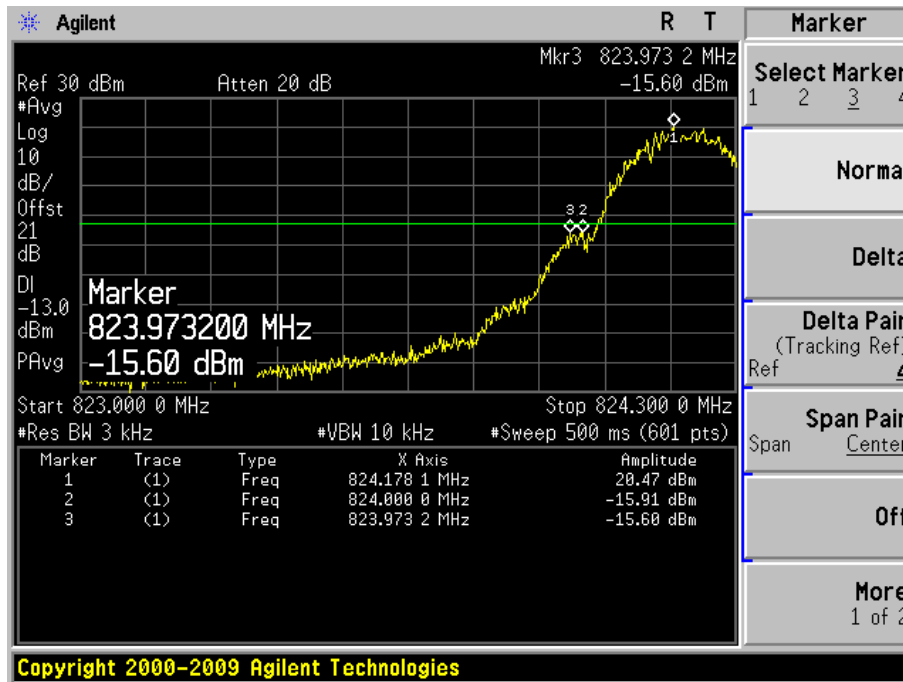
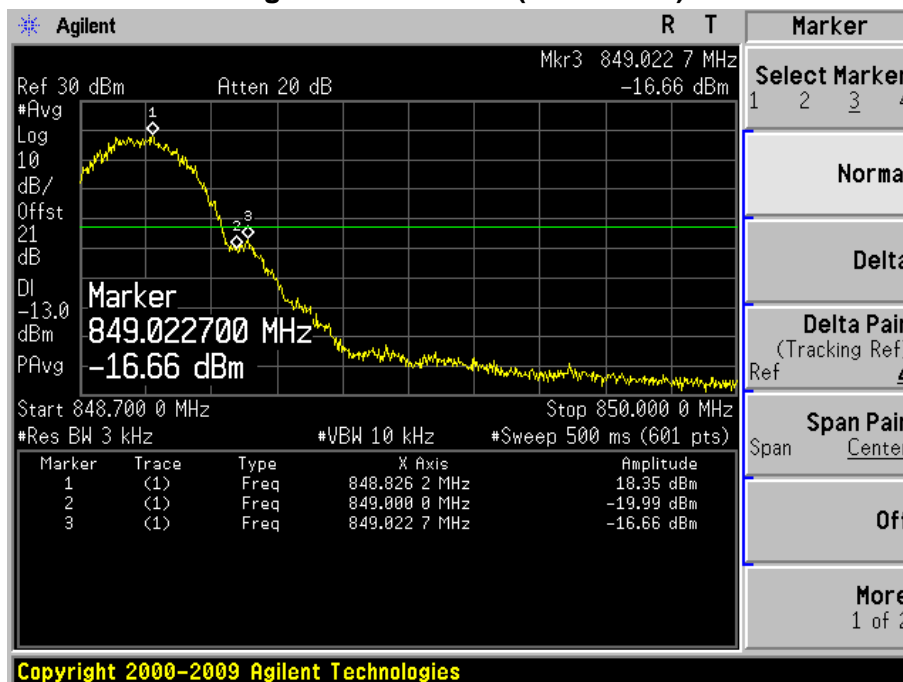

Figure Channel 251 (848.80MHz)



Product	GSM/GPRS Module		
Test Item	Spurious Emission At Antenna Terminals (+/- 1MHz)		
Test Mode	Mode 2: GPRS1900 Link		
Date of Test	2010/10/08	Test Site	AC-6

Figure Channel 128 (824.20MHz)

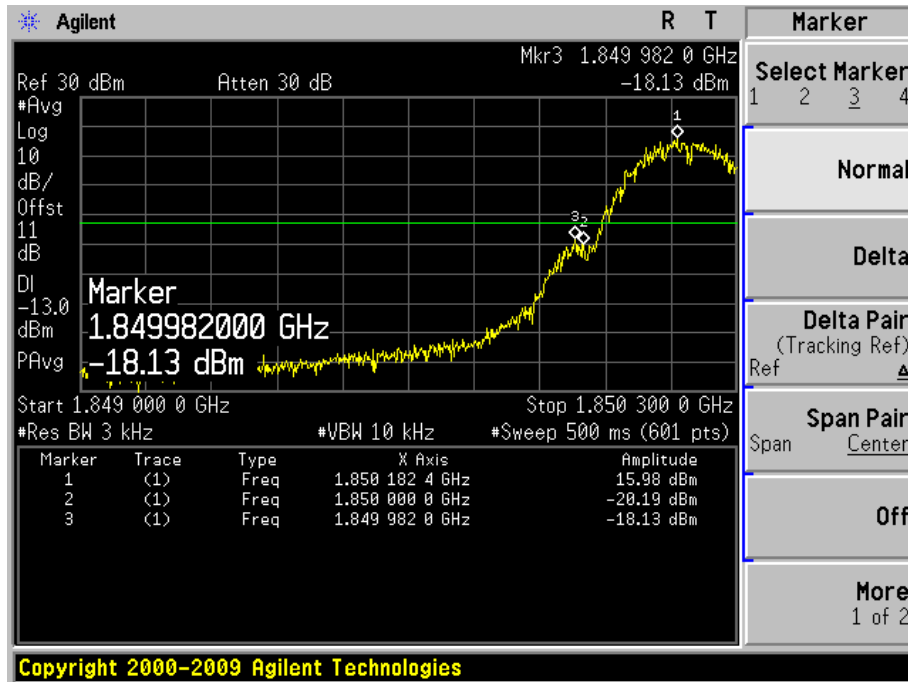
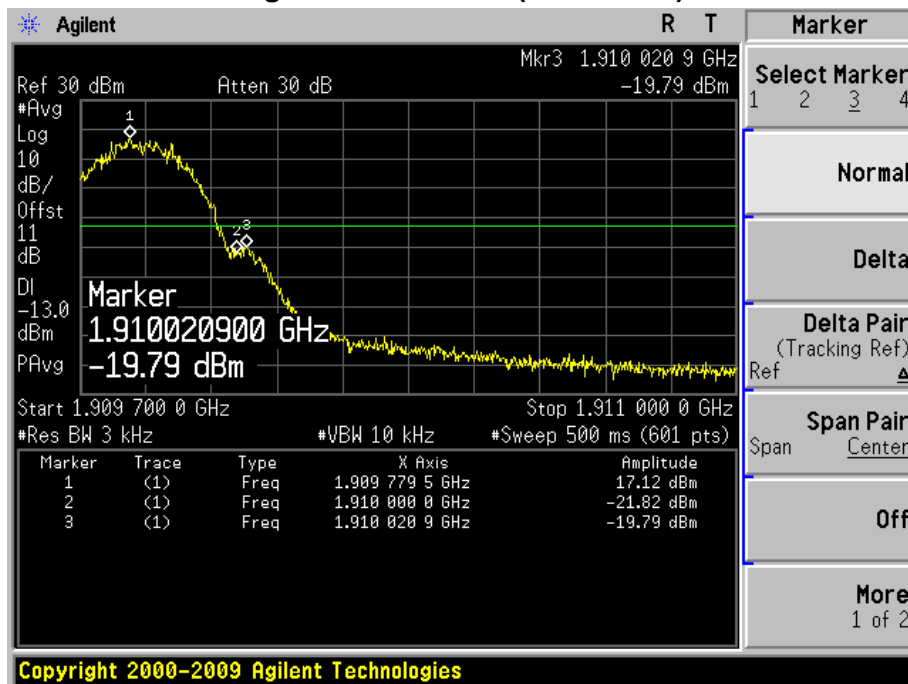

Figure Channel 251 (848.80MHz)



**6. Spurious Emission**

**6.1. Test Equipment**

Spurious Emission / AC-5

Instrument	Manufacturer	Type No.	Serial No	Cal. Date
PSA Series Spectrum Analyzer	Agilent	E4440A	MY49420184	2010.04.10
Radio Communication Tester	R&S	CMU 200	117088	2010.07.12
Dual Directional Coupler	Agilent	778D	20160	2010.04.20
10dB Coaxial Coupler	Agilent	87300C	MY44300299	2010.04.20
PSG Analog Signal Generator	Agilent	E8257D	MY44321116	2010.04.23
Preamplifier	QuieTek	AP-025C	CHM-0503006	2010.05.05
Preamplifier	Miteq	NSP1800-25	1364185	2010.05.05
Bilog Antenna	Teseq GmbH	CBL6112D	27612	2009.11.12
Half Wave Tuned Dipole Antenna	COM-POWER	AD-100	40137	2009.11.24
Broad-Band Horn Antenna	Schwarzbeck	BBHA9120D	737	2009.11.24
Broad-Band Horn Antenna	Schwarzbeck	BBHA9120D	499	2010.06.11
Temperature/Humidity Meter	Zhicheng	ZC1-2	AC5-TH	2010.01.14

6.2. Test Setup

Conducted Spurious Measurement:

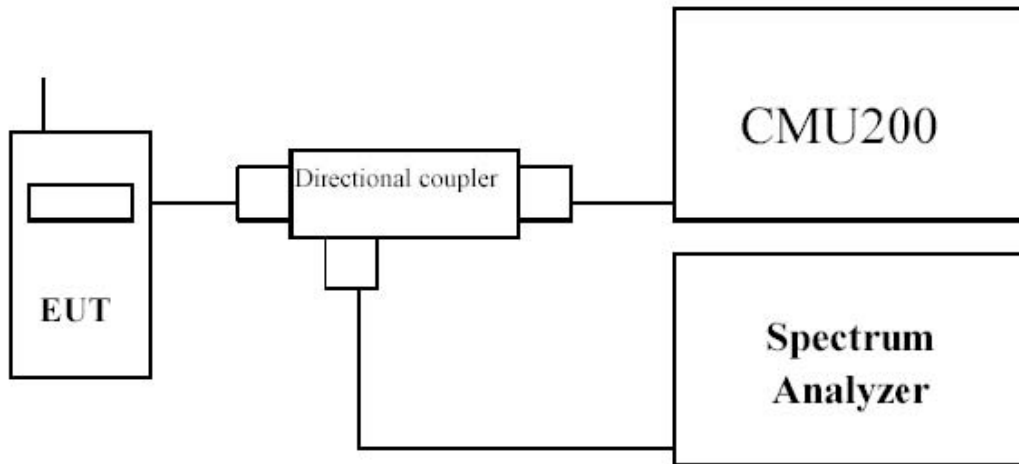

Radiated Spurious Measurement:

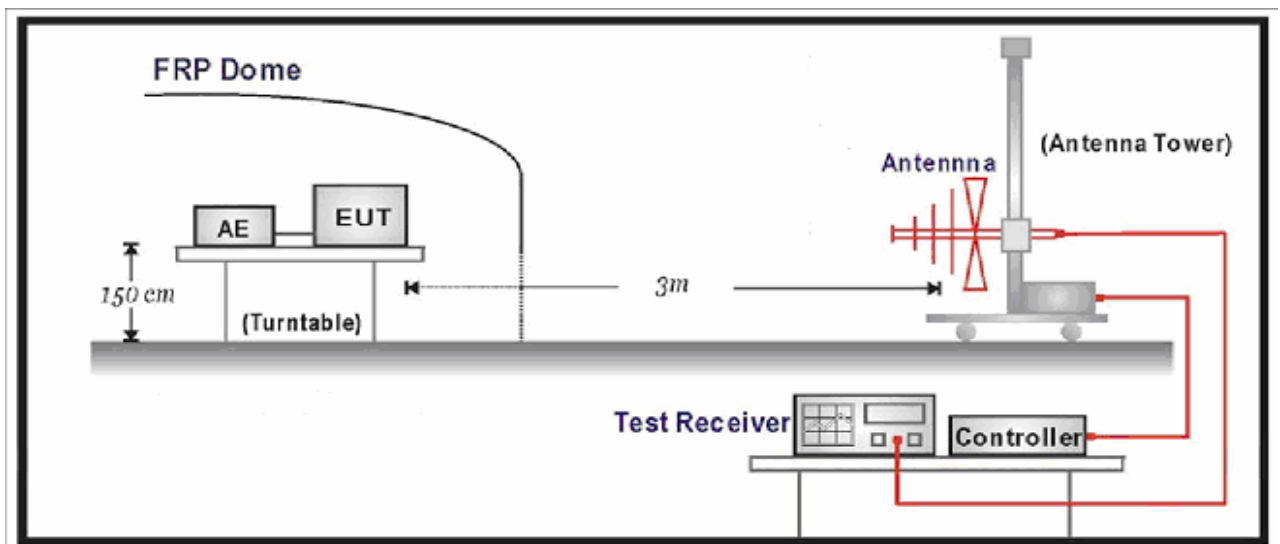

6.3. Limit

The power of any emission outside of the authorized operating frequency ranges must be attenuated below the transmitting power (P) by a factor of at least  $43 + 10\log(P)$  dB.



## 6.4. Test Procedure

### Conducted Spurious Measurement:

- a) Place the EUT on a bench and set it in transmitting mode.
- b) Connect a low loss RF cable from the antenna port to a spectrum analyzer and CMU200 by a Directional Couple.
- c) EUT Communicate with CMU200, then select a channel for testing.
- d) Add a correction factor to the display of spectrum, and then test.
- e) The resolution bandwidth of the spectrum analyzer was set at 1 MHz, sufficient scans were taken to show the out of band Emission if any up to 10<sup>th</sup> harmonic.

### Radiated Spurious Measurement:

- a) The EUT shall be placed at the specified height on a support, and in the position closest to normal use as declared by provider.
- b) The test antenna shall be oriented initially for vertical polarization and shall be chosen to correspond to the frequency of the transmitter
- c) The output of the test antenna shall be connected to the measuring receiver.
- d) The transmitter shall be switched on and the measuring receiver shall be tuned to the frequency of the transmitter under test.
- e) The test antenna shall be raised and lowered through the specified range of height until a maximum signal level is detected by the measuring receiver.
- f) The transmitter shall then be rotated through 360° in the horizontal plane, until the maximum signal level is detected by the measuring receiver.
- g) The test antenna shall be raised and lowered again through the specified range of height until a maximum signal level is detected by the measuring receiver.
- u) The maximum signal level detected by the measuring receiver shall be noted.
- h) The transmitter shall be replaced by a substitution antenna.
- i) The substitution antenna shall be orientated for vertical polarization and the length of the substitution antenna shall be adjusted to correspond to the frequency of the transmitter.
- j) The substitution antenna shall be connected to a calibrated signal generator.
- k) If necessary, the input attenuator setting of the measuring receiver shall be adjusted in order to increase the sensitivity of the measuring receiver.
- l) The test antenna shall be raised and lowered through the specified range of height to ensure that the maximum signal is received.
- m) The input signal to the substitution antenna shall be adjusted to the level that produces a level detected by the measuring receiver, that is equal to the level noted while the transmitter radiated power was measured, corrected for the change of input attenuator setting of the measuring receiver.

- n) The measurement shall be repeated with the test antenna and the substitution antenna orientated for horizontal polarization.
- o) The measure of the effective radiated power is the larger of the two levels recorded at the input to the substitution antenna, corrected for gain of the substitution antenna if necessary.
- p) The frequency range was checked up to 10<sup>th</sup> harmonic.

## **6.5. Uncertainty**

The measurement uncertainty is defined as 3.2 dB for Radiated Power Measurement.

6.6. Test Result

Product	GSM/GPRS Module		
Test Item	Spurious Emission		
Test Mode	Mode 1: GPRS850 Link		
Date of Test	2010/09/30	Test Site	AC-5

Frequency (MHz)	SA Reading (dBm)	Ant. Pol. (H/V)	SG Reading (dBm)	Cable Loss (dB)	Gain (dBi)	EIRP (dBm)	Limit (dBm)	Margin (dB)
Low Channel 128 (824.20MHz)								
1603.5	-35.75	V	-52.23	2.45	9.50	-45.18	-13	-32.18
2496.0	-45.23	V	-58.18	3.18	10.58	-50.78	-13	-37.78
1603.5	-44.69	H	-61.19	2.45	9.50	-54.14	-13	-41.14
2496.0	-46.79	H	-59.54	3.18	10.58	-52.14	-13	-39.14
Middle Channel 189 (836.40MHz)								
1671.5	-36.84	V	-53.44	2.50	9.90	-46.04	-13	-33.04
2513.0	-40.08	V	-53.04	3.18	10.62	-45.60	-13	-32.60
1671.5	-43.41	H	-59.96	2.50	9.90	-52.56	-13	-39.56
2513.0	-46.87	H	-59.66	3.18	10.62	-52.22	-13	-39.22
High Channel 251 (848.80MHz)								
1697.0	-37.63	V	-54.14	2.54	10.10	-46.58	-13	-33.58
2547.0	-42.26	V	-55.35	3.14	10.68	-47.81	-13	-34.81
1697.0	-48.53	H	-64.96	2.54	10.10	-57.40	-13	-44.40
2547.0	-46.93	H	-59.82	3.14	10.68	-52.28	-13	-39.28

Product	GSM/GPRS Module		
Test Item	Spurious Emission		
Test Mode	Mode 2: GPRS1900 Link		
Date of Test	2010/09/30	Test Site	AC-5

Frequency (MHz)	SA Reading (dBm)	Ant. Pol. (H/V)	SG Reading (dBm)	Cable Loss (dB)	Gain (dBi)	EIRP (dBm)	Limit (dBm)	Margin (dB)
Low Channel 512 (1850.20MHz)								
3703.0	-43.94	V	-55.69	3.84	12.69	-46.84	-13	-33.84
5556.0	-44.73	V	-51.43	4.82	13.15	-43.10	-13	-30.10
3703.0	-51.20	H	-58.48	3.84	12.69	-49.63	-13	-36.63
5556.0	-44.73	H	-51.43	4.82	13.15	-43.10	-13	-30.10
Middle Channel 661 (1880.00MHz)								
3762.5	-42.45	V	-53.50	3.75	12.73	-44.52	-13	-31.52
5998.0	-48.01	V	-54.23	5.00	13.00	-46.23	-13	-33.23
3762.5	-44.33	H	-55.44	3.75	12.73	-46.46	-13	-33.46
5998.0	-51.49	H	-57.84	5.00	13.00	-49.84	-13	-36.84
High Channel 810 (1909.80MHz)								
3822.0	-45.09	V	-55.42	4.02	12.73	-46.71	-13	-33.71
5554.5	-45.57	V	-52.19	4.82	13.10	-43.91	-13	-30.91
3822.0	-49.71	H	-60.41	4.02	12.73	-51.70	-13	-38.70
5554.5	-48.80	H	-55.41	4.82	13.10	-47.13	-13	-34.13

### 6.7. Test Photograph

Description: Radiated Spurious Emission Test Setup for Below 1 GHz

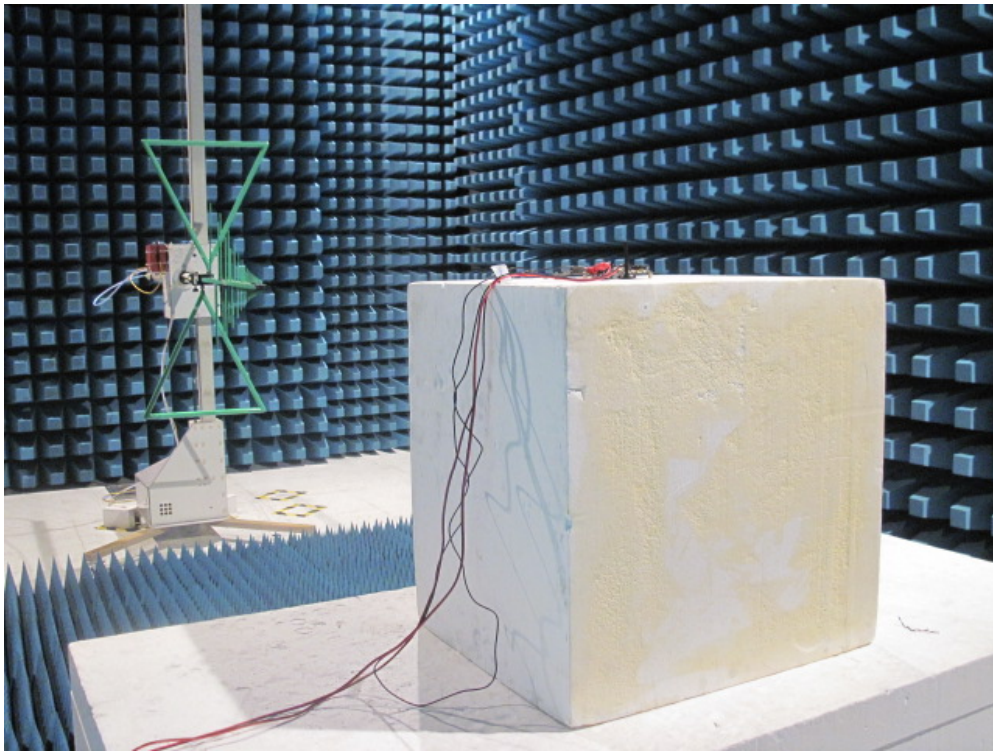

Description: Substitution Antenna Test Setup for Below 1 GHz





Description: Radiated Spurious Emission Test Setup for Above 1 GHz

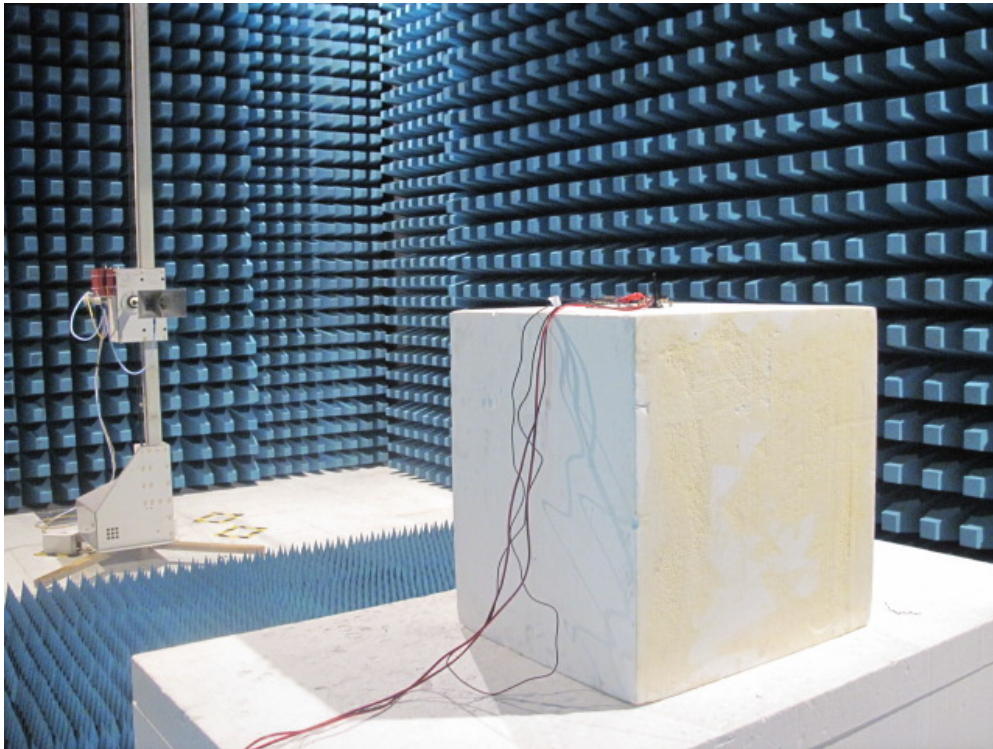

Description: Substitution Antenna Test Setup for Above 1 GHz

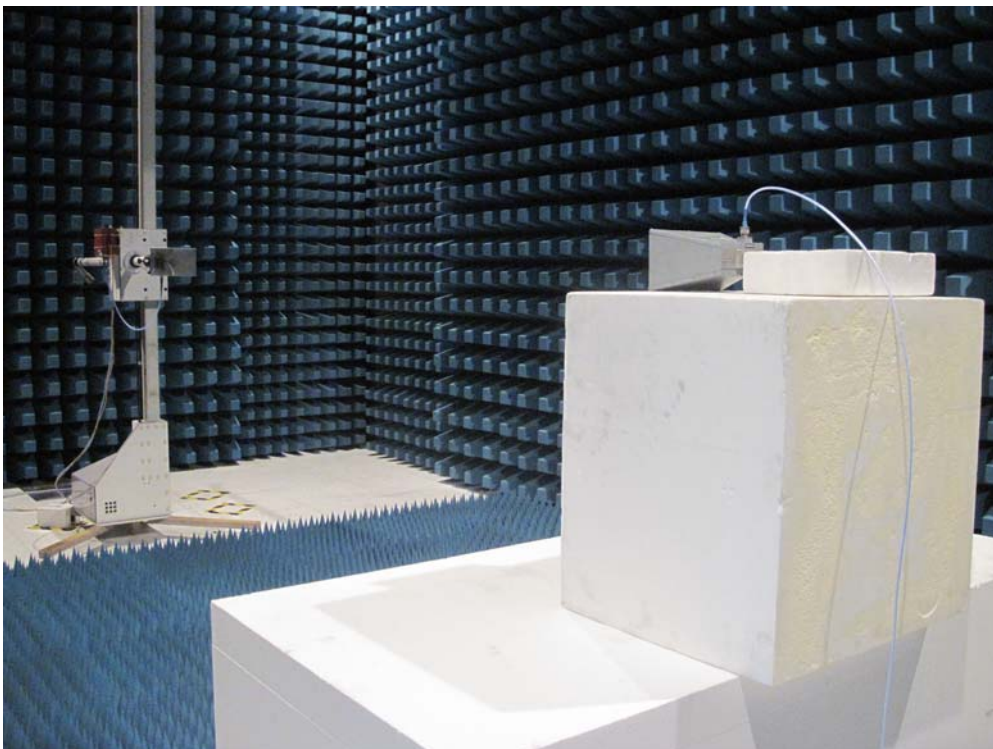

## 7. Frequency Stability Under Temperature & Voltage Variations

### 7.1. Test Equipment

Frequency Stability Under Temperature & Voltage Variations / AC-6

Instrument	Manufacturer	Type No.	Serial No	Cal. Date
PSA Series Spectrum Analyzer	Agilent	E4440A	MY49420184	2010.04.10
Radio Communication Tester	R&S	CMU 200	117088	2010.07.12
Dual Directional Coupler	Agilent	778D	20160	2010.04.20
10dB Coaxial Coupler	Agilent	87300C	MY44300299	2010.04.20
DC Power Supply	IDRC	CD-035-020PR	977272	2010.09.27
Temperature & Humidity Chamber	Gaoyu	TH-1P-B	WIT-05121302	2010.01.19
Temperature/Humidity Meter	Zhicheng	ZC1-2	AC6-TH	2010.01.14

### 7.2. Test Setup

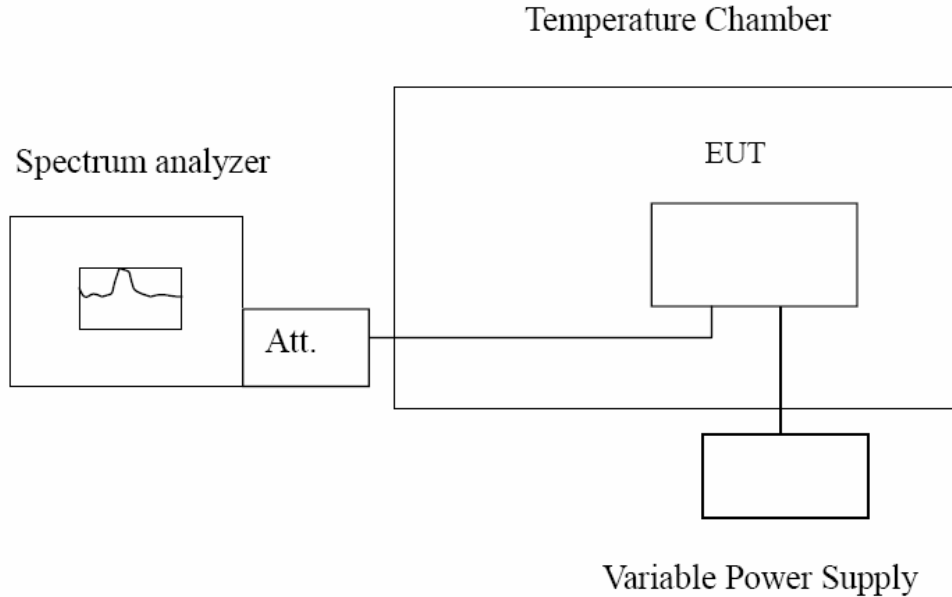

**7.3. Limit**

The frequency stability shall be sufficient to ensure that the fundamental emission stays within the authorized frequency block.

Limit	$< \pm 2.5 \text{ ppm}$
-------	-------------------------

**7.4. Test Procedure**

**Frequency Stability Under Temperature Variations:**

The equipment under test was connected to an external AC or DC power supply and input rated voltage. RF output was connected to a frequency counter or spectrum analyzer via feed through attenuators. The EUT was placed inside the temperature chamber. Set the spectrum analyzer RBW low enough to obtain the desired frequency resolution and measure EUT 20°C operating frequency as reference frequency. Turn EUT off and set the chamber temperature to -30°C. After the temperature stabilized for approximately 30 minutes recorded the frequency. Repeat step measure with 10°C increased per stage until the highest temperature of +50°C reached.

**Frequency Stability Under Voltage Variations:**

Set chamber temperature to 20°C. Use a variable AC power supply / DC power source to power the EUT and set the voltage to rated voltage. Set the spectrum analyzer RBW low enough to obtain the desired frequency resolution and recorded the frequency. Reduce the input voltage to specify extreme voltage variation ( $\pm 15\%$ ) and endpoint, record the maximum frequency change.

**7.5. Uncertainty**

The measurement uncertainty is defined as  $\pm 10 \text{ Hz}$ .



**7.6. Test Result**

Product	GSM/GPRS Module		
Test Item	Frequency Stability Under Temperature & Voltage Variations		
Test Mode	Mode 1: GPRS850 Link		
Date of Test	2009/10/08	Test Site	AC-6

Frequency Stability under Temperature

Temperature Interval (°C)	Test Frequency (MHz)	Deviation (Hz)	Limit (kHz)
-30	836.40	-32	± 2091
-20	836.40	-28	± 2091
-10	836.40	-23	± 2091
0	836.40	-15	± 2091
10	836.40	-25	± 2091
20	836.40	-30	± 2091
30	836.40	-28	± 2091
40	836.40	-35	± 2091
50	836.40	-17	± 2091

Frequency Stability under Voltage

DC Voltage (V)	Test Frequency (MHz)	Deviation (Hz)	Limit (KHz)
4.500	836.40	-21	± 2091
3.700	836.40	-28	± 2091
3.300	836.40	-26	± 2091

Product	GSM/GPRS Module		
Test Item	Frequency Stability Under Temperature & Voltage Variations		
Test Mode	Mode 2: GPRS1900 Link		
Date of Test	2009/10/08	Test Site	AC-6

Frequency Stability under Temperature

Temperature Interval (°C)	Test Frequency (MHz)	Deviation (Hz)	Limit (kHz)
-30	1880.0	-28	± 2091
-20	1880.0	-35	± 2091
-10	1880.0	-25	± 2091
0	1880.0	-33	± 2091
10	1880.0	-25	± 2091
20	1880.0	-21	± 2091
30	1880.0	-28	± 2091
40	1880.0	-34	± 2091
50	1880.0	-36	± 2091

Frequency Stability under Voltage

DC Voltage (V)	Test Frequency (MHz)	Deviation (Hz)	Limit (KHz)
4.500	836.40	-33	± 2091
3.700	836.40	-28	± 2091
3.300	836.40	-25	± 2091

**8. Receiver Spurious Emission for RSS 132/133**

**8.1. Test Equipment**

Spurious Emission / AC-5

Instrument	Manufacturer	Type No.	Serial No	Cal. Date
Spectrum Analyzer	Agilent	N9010A	MY48030494	2010.04.23
Radio Communication Tester	R&S	CMU 200	106388	2010.10.21
Preamplifier	QuieTek	AP-025C	CHM-0503006	2010.05.05
Preamplifier	Miteq	NSP1800-25	1364185	2010.05.05
Bilog Antenna	Teseq GmbH	CBL6112D	27612	2009.11.12
Broad-Band Horn Antenna	Schwarzbeck	BBHA9120D	499	2009.11.24
Temperature/Humidity Meter	Zhicheng	ZC1-2	AC5-TH	2010.01.14

**8.2. Test Setup**

Under 1GHz Test Setup:

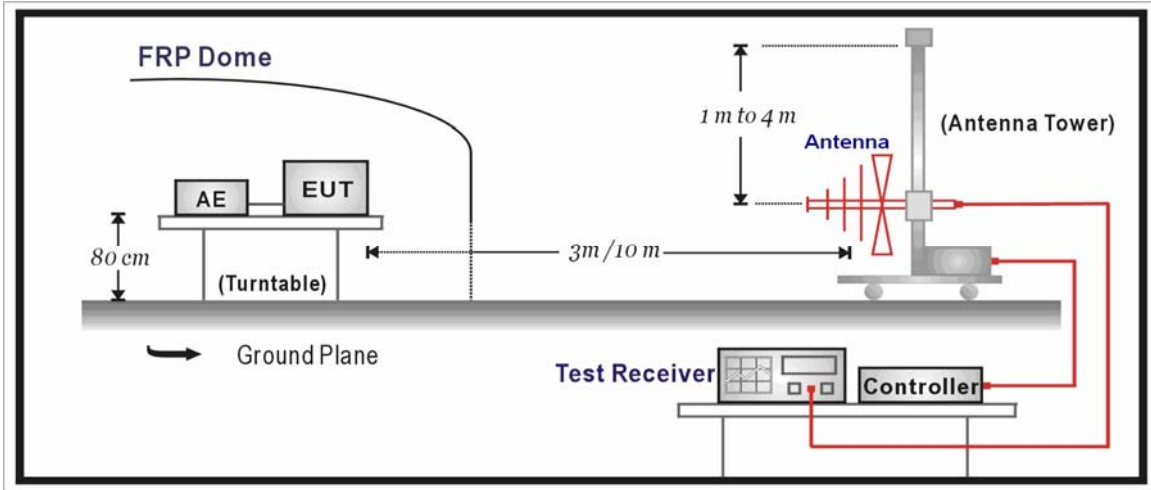

Above 1GHz Test Setup:

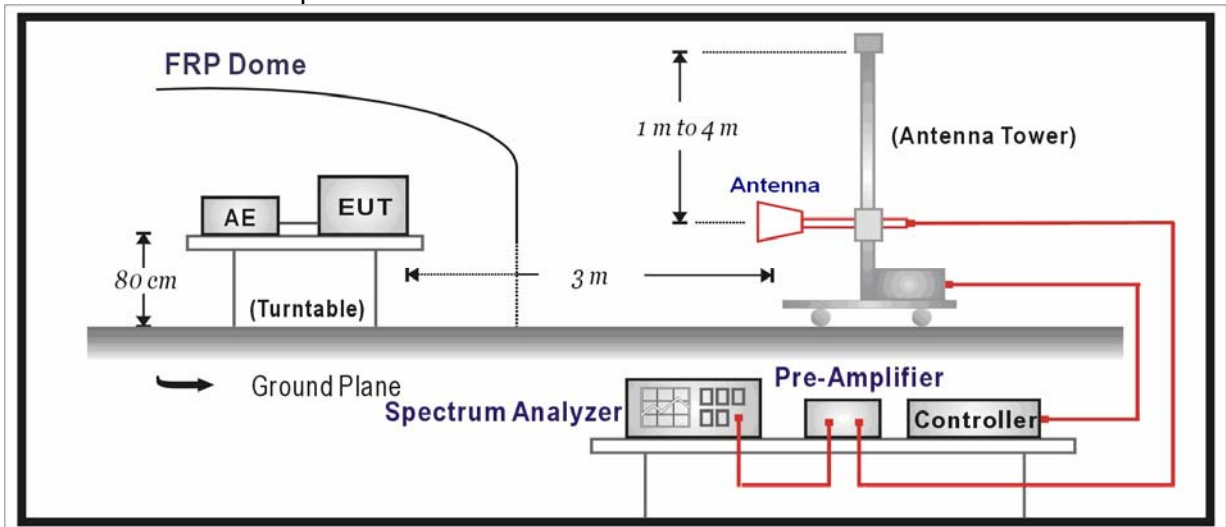

**8.3. Limit**

According to Standard RSS132/133 refer to RSS-Gen Issue 2.

<b>Field Strength micro-volts/m at 3 meters</b>		
<b>Frequency (MHz)</b>	<b>Distance (m)</b>	<b>Level (dBuV/m)</b>
30 - 88	3	40
88 - 216	3	43.5
216 - 960	3	46
Above 960	3	54

Note 1: The lower limit shall apply at the transition frequency.

Note 2: Distance refers to the distance in meters between the measuring instrument antenna and the closed point of any part of the device or system.

Note 3: E field strength (dBuV/m) = 20 log E field strength (uV/m)

**8.4. Test Procedure**

The EUT and its simulators are placed on a turn table which is 0.8 meter above ground. The turn table can rotate 360 degrees to determine the position of the maximum emission level. The EUT was positioned such that the distance from antenna to the EUT was 3 meters. The antenna can move up and down between 1 meter and 4 meters to find out the maximum emission level.

Both horizontal and vertical polarization of the antenna are set on measurement. In order to find the maximum emission, all of the interface cables must be manipulated on radiated measurement.

On any frequency or frequencies below or equal to 1000 MHz, the radiated limits shown are based on measuring equipment employing a quasi-peak detector function and above 1000 MHz, the radiated limits shown are based measuring equipment employing an average detector function.

When average radiated emission measurement are included emission measurement Above 1000 MHz, there also is a limit on the radio frequency emissions, as measured using instrumentation with a peak detector function, corresponding to 20 dB above the maximum permitted average limit.

For class A, the measurement distance between the EUT and antenna is 3 meters for under

1GHz and above 1GHz.

For class B, the measurement distance between the EUT and antenna is 3 meters for under 1GHz and 3 meters for above 1GHz.

The bandwidth below 1GHz setting on the field strength meter (R&S Test Receiver ESCI) is 120 kHz and above 1GHz is 1MHz.

Note: When measurement above 1GHz, the horn antenna will bend down a little (as horn antenna have the narrow beamwidth) in order to find the maximum emission of EUT

## **8.5. Uncertainty**

The measurement uncertainty is defined as 3.2 dB for Radiated Power Measurement.

8.6. Test Result

No significant emissions measurable. Plots reported here represent the worse case emissions.

Engineer: Jame	
Site: AC5	Time: 2010/10/08 - 14:30
Limit: RSS_GEN_Radiation_03M_QP	Margin: 0
Probe: CBL6112D_(30-2000MHz) - HORIZONTAL	Polarity: Horizontal
EUT: GSM/GPRS Module	Power: DC 3.7V
Note: Mode 1: GPRS 850 (Using Peak detector)	

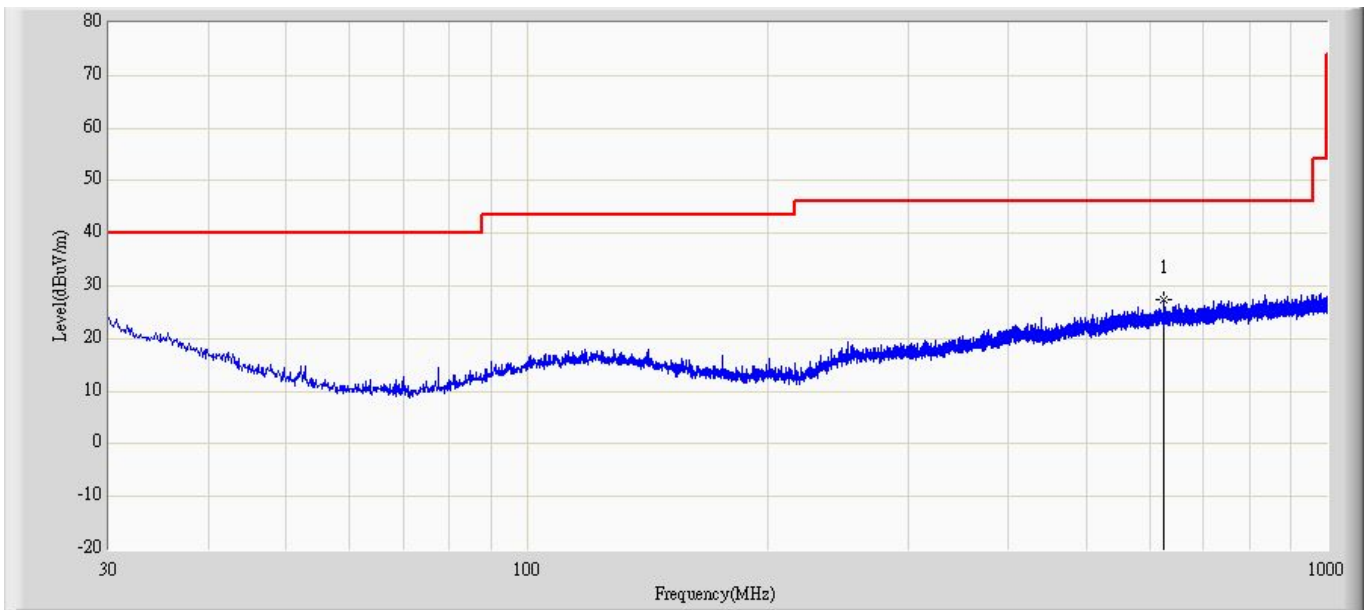

This plot is valid for low, mid & high channels (worst-case plot).

Engineer: Jame	
Site: AC5	Time: 2010/10/08 - 14:01
Limit: RSS_GEN_Radiation_03M_QP	Margin: 0
Probe: CBL6112D_(30-2000MHz) - HORIZONTAL	Polarity: Vertical
EUT: GSM/GPRS Module	Power: DC 3.7V
Note: Mode 1: GPRS 850 (Using Peak detector)	

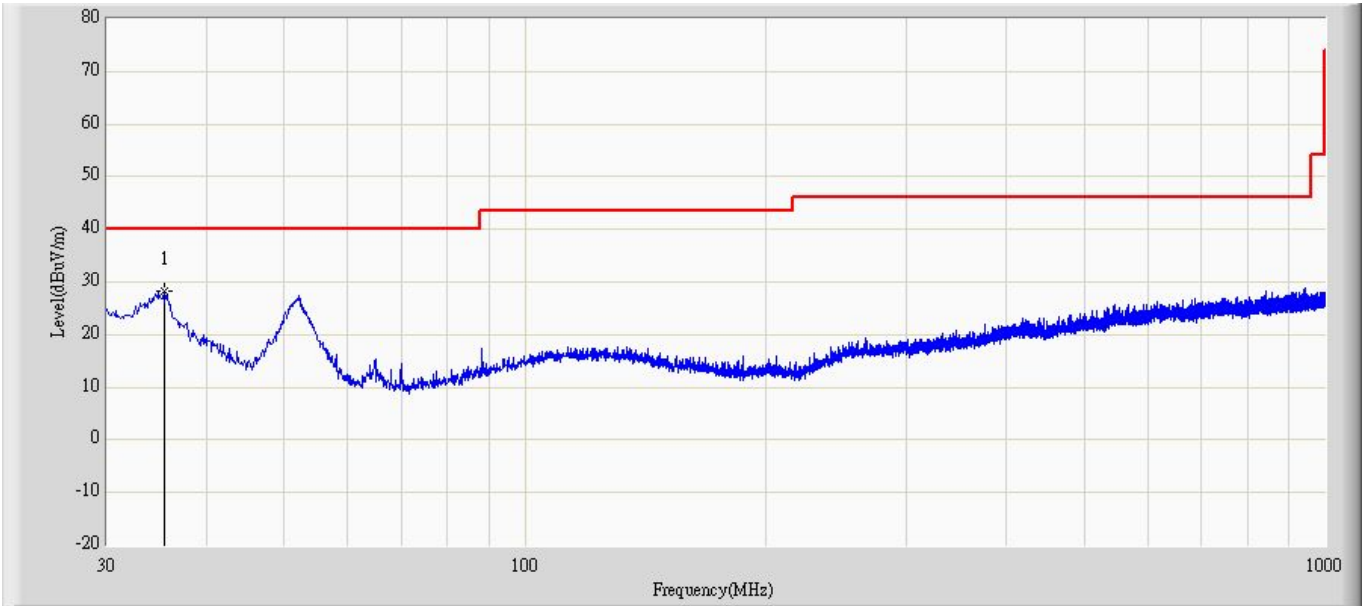

This plot is valid for low, mid & high channels (worst-case plot).



Engineer: Jame	
Site: AC5	Time: 2010/10/08 - 10:51
Limit: RSS_GEN_Radiation_03M_PK	Margin: 0
Probe: BBHA9120D_499(1-18GHz)	Polarity: Horizontal
EUT: GSM/GPRS Module	Power: DC 3.7V
Note: Mode 1: GPRS 850 (Using Peak detector)	

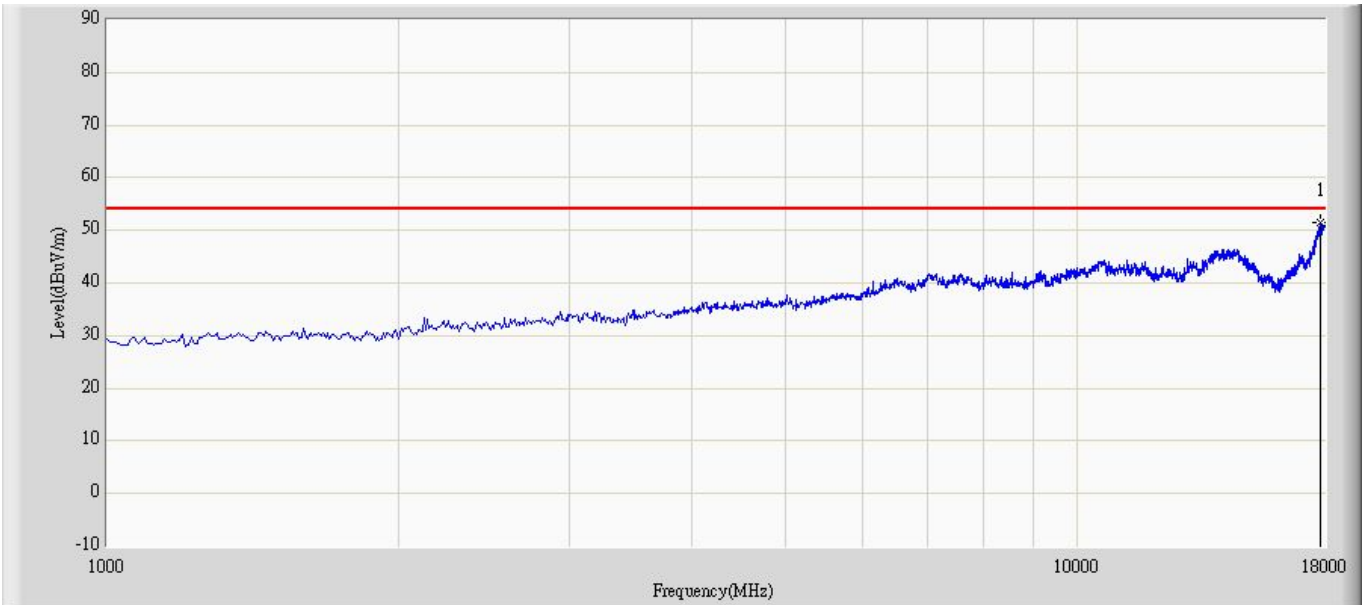

This plot is valid for low, mid & high channels (worst-case plot).

Engineer: Jame	
Site: AC5	Time: 2010/10/08 - 10:55
Limit: RSS_GEN_Radiation_03M_PK	Margin: 0
Probe: BBHA9120D_499(1-18GHz)	Polarity: Vertical
EUT: GSM/GPRS Module	Power: DC 3.7V
Note: Mode 1: GPRS 850 (Using Peak detector)	

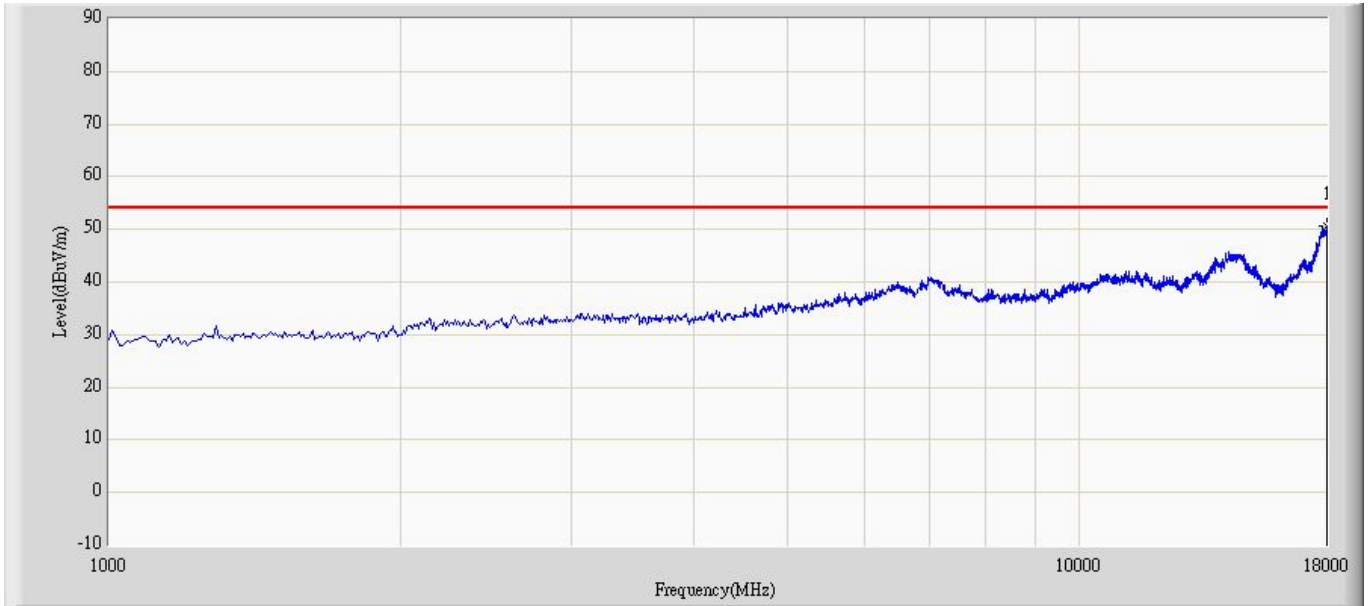

This plot is valid for low, mid & high channels (worst-case plot).

Engineer: Jame	
Site: AC5	Time: 2010/10/08 - 14:09
Limit: RSS_GEN_Radiation_03M_QP	Margin: 0
Probe: CBL6112D_(30-2000MHz) - HORIZONTAL	Polarity: Horizontal
EUT: GSM/GPRS Module	Power: DC 3.7V
Note: Mode 2: GPRS 1900 (Using Peak detector)	

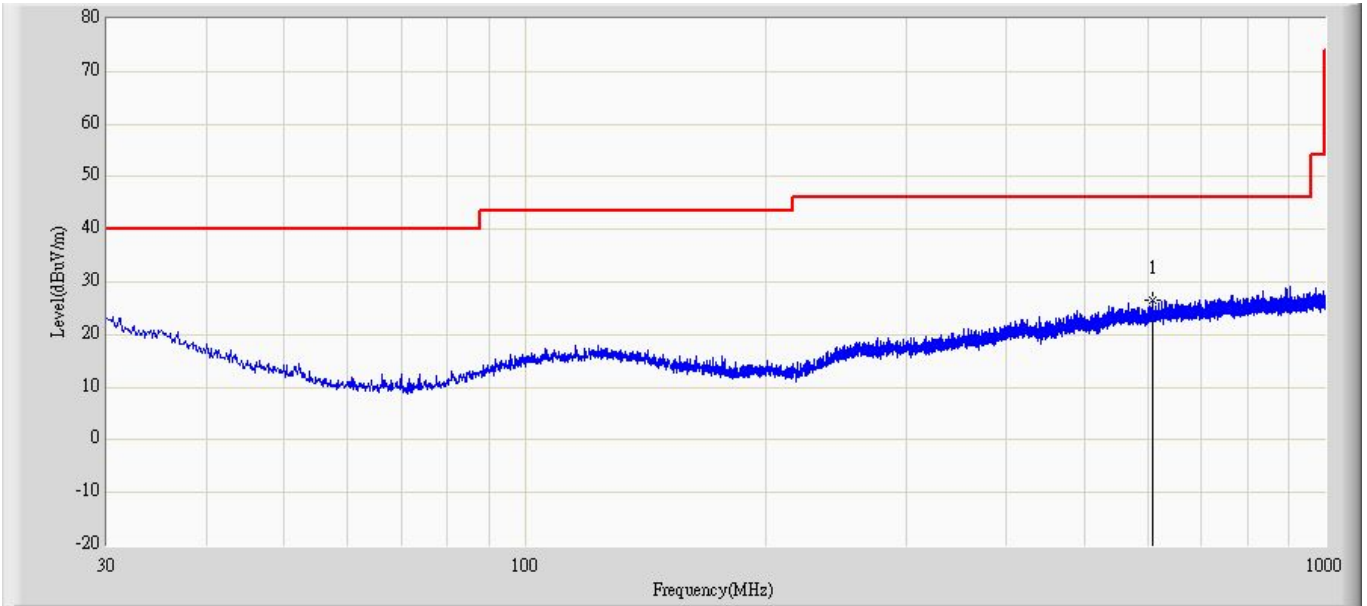

This plot is valid for low, mid & high channels (worst-case plot).

Engineer: Jame	
Site: AC5	Time: 2010/10/08 - 14:08
Limit: RSS_GEN_Radiation_03M_QP	Margin: 0
Probe: CBL6112D_(30-2000MHz) - HORIZONTAL	Polarity: Vertical
EUT: GSM/GPRS Module	Power: DC 3.7V
Note: Mode 2: GPRS 1900 (Using Peak detector)	

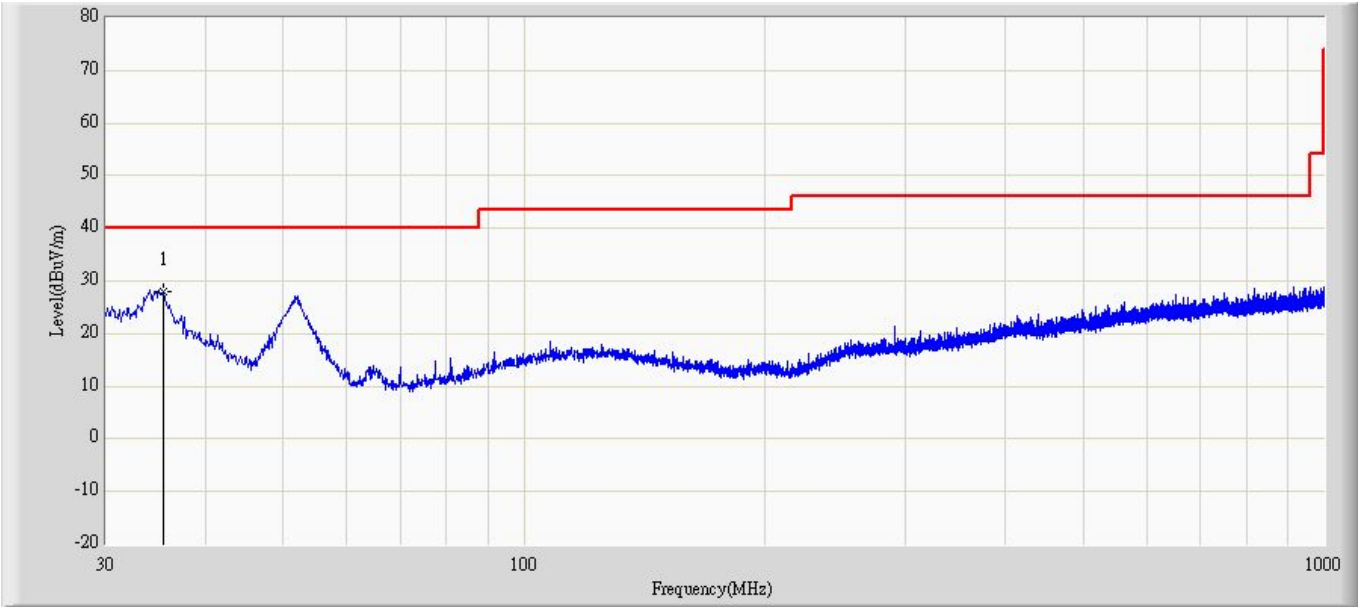

This plot is valid for low, mid & high channels (worst-case plot).

Engineer: Jame	
Site: AC5	Time: 2010/10/08 - 10:56
Limit: RSS_GEN_Radiation_03M_PK	Margin: 0
Probe: BBHA9120D_499(1-18GHz)	Polarity: Horizontal
EUT: GSM/GPRS Module	Power: DC 3.7V
Note: Mode 2: GPRS 1900 (Using Peak detector)	

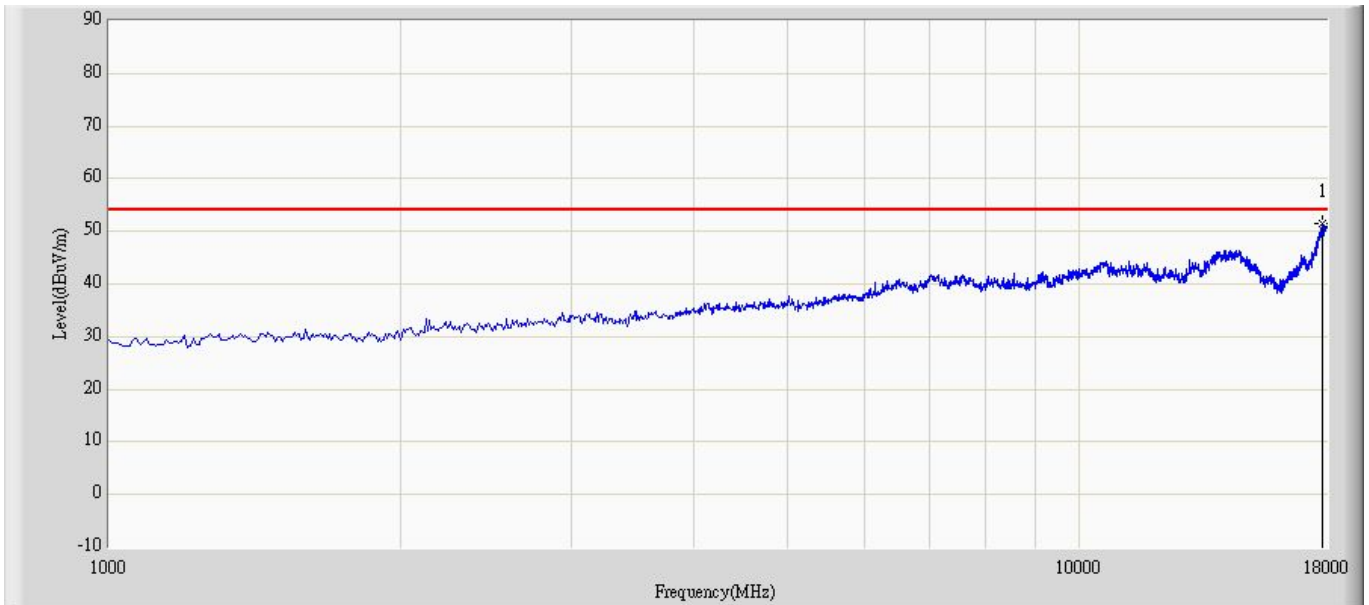

This plot is valid for low, mid & high channels (worst-case plot).

Engineer: Jame	
Site: AC5	Time: 2010/10/08 - 10:56
Limit: RSS_GEN_Radiation_03M_PK	Margin: 0
Probe: BBHA9120D_499(1-18GHz)	Polarity: Vertical
EUT: GSM/GPRS Module	Power: DC 3.7V
Note: Mode 2: GPRS 1900 (Using Peak detector)	

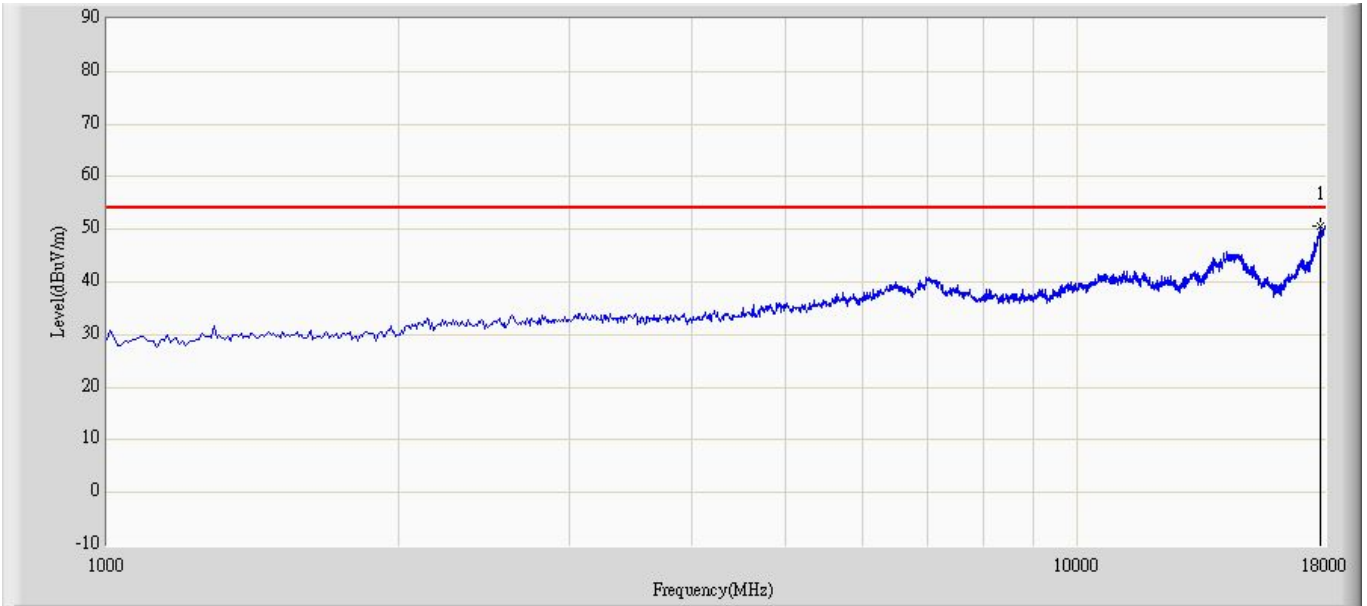

This plot is valid for low, mid & high channels (worst-case plot).

9. Attachment

➤ EUT Photograph

(1) EUT Photo



(2) EUT Photo





(3) EUT Photo



(4) EUT Test Platform

