



RF MEASUREMENT REPORT

FCC ID: VW3FAST5689E
Applicant: SAGEMCOM BROADBAND SAS
Product: Giga Hub
Model No.: FAST 5689E
Brand Name: SAGEMCOM
FCC Classification: Unlicensed National Information Infrastructure (NII)
FCC Rule Part(s): Part 15 Subpart E (Section 15.407)
Test Date: January 11 ~ 27, 2022

Reviewed By:

Sunny Sun

Approved By:

Robin Wu



The test results relate only to the samples tested.

This equipment has been shown to be capable of compliance with the applicable technical standards as indicated in the measurement report and was tested in accordance with the measurement procedures specified in KDB789033. Test results reported herein relate only to the item(s) tested.

The test report shall not be reproduced except in full without the written approval of MRT Technology (Suzhou) Co., Ltd.

Revision History

Report No.	Version	Description	Issue Date	Note
2201RSU021-U5	Rev. 01	Initial Report	03-30-2022	Invalid
2201RSU021-U5	Rev. 02	Added the Directional Gain Calculation	05-29-2022	Valid

CONTENTS

Description	Page
1. General Information	6
1.1. Applicant.....	6
1.2. Manufacturer.....	6
1.3. Testing Facility	6
1.4. Product Information.....	7
1.5. Radio Specification	8
1.6. Working Frequencies	9
1.7. Antenna Details.....	10
2. Test Configuration	11
2.1. Test Mode	11
2.2. Test System Connection Diagram.....	12
2.3. Test Software	12
2.4. Applied Standards.....	12
2.5. Test Environment Condition.....	12
3. Antenna Requirements	13
4. Measuring Instrument.....	14
5. Measurement Uncertainty.....	15
6. Test Result.....	16
6.1. Summary	16
6.2. 26dB & 99% Bandwidth Measurement	17
6.2.1. Test Limit	17
6.2.2. Test Procedure.....	17
6.2.3. Test Setting.....	17
6.2.4. Test Setup.....	18
6.2.5. Test Result.....	18
6.3. Output Power Measurement.....	19
6.3.1. Test Limit	19
6.3.2. Test Procedure.....	19
6.3.3. Test Setting.....	19
6.3.4. Test Setup.....	19
6.3.5. Test Result.....	19
6.4. Transmit Power Control Measurement.....	20
6.4.1. Test Limit	20
6.4.2. Test Procedure.....	20
6.4.3. Test Setting.....	20

6.4.4.	Test Setup.....	20
6.4.5.	Test Result.....	20
6.5.	Power Spectral Density Measurement.....	21
6.5.1.	Test Limit	21
6.5.2.	Test Procedure.....	21
6.5.3.	Test Setting.....	21
6.5.4.	Test Setup.....	22
6.5.5.	Test Result.....	22
6.6.	Frequency Stability Measurement	23
6.6.1.	Test Limit	23
6.6.2.	Test Procedure.....	23
6.6.3.	Test Setup.....	24
6.6.4.	Test Result.....	24
6.7.	Radiated Spurious Emission Measurement	25
6.7.1.	Test Limit	25
6.7.2.	Test Procedure.....	25
6.7.3.	Test Setting.....	25
6.7.4.	Test Setup.....	27
6.7.5.	Test Result.....	27
6.8.	Radiated Restricted Band Edge Measurement	28
6.8.1.	Test Limit	28
6.8.2.	Test Procedure.....	29
6.8.3.	Test Setting.....	29
6.8.4.	Test Setup.....	30
6.8.5.	Test Result.....	30
6.9.	AC Conducted Emissions Measurement	31
6.9.1.	Test Limit	31
6.9.2.	Test Setup.....	31
6.9.3.	Test Result.....	31
Appendix A – Test Result		32
A.1	Duty Cycle Test Result	32
A.2	26dB & 99% Bandwidth Test Result	33
A.3	Output Power Test Result.....	44
A.4	Power Spectral Density Test Result.....	46
A.5	Radiated Spurious Emission Test Result	84
A.6	Radiated Restricted Band Edge Test Result	125
Appendix B – Test Setup Photograph.....		199
Appendix C – EUT Photograph		200

1. General Information

1.1. Applicant

SAGEMCOM BROADBAND SAS

250 Route de l'Empereur - 92848 RUEIL MALMAISON CEDEX- FRANCE

1.2. Manufacturer

SAGEMCOM BROADBAND SAS

250 Route de l'Empereur - 92848 RUEIL MALMAISON CEDEX- FRANCE

1.3. Testing Facility

<input checked="" type="checkbox"/>	<p>Test Site – MRT Suzhou Laboratory</p> <hr/> <p>Laboratory Location (Suzhou - Wuzhong) D8 Building, No.2 Tian'edang Rd., Wuzhong Economic Development Zone, Suzhou, China</p> <p>Laboratory Location (Suzhou - SIP) 4b Building, Liando U Valley, No.200 Xingpu Rd., Shengpu Town, Suzhou Industrial Park, China</p> <hr/> <p>Laboratory Accreditations</p> <p>A2LA: 3628.01 CNAS: L10551</p> <p>FCC: CN1166 ISED: CN0001</p> <p>VCCI: <input type="checkbox"/>R-20025 <input type="checkbox"/>G-20034 <input type="checkbox"/>C-20020 <input type="checkbox"/>T-20020</p> <p style="margin-left: 100px;"><input type="checkbox"/>R-20141 <input type="checkbox"/>G-20134 <input type="checkbox"/>C-20103 <input type="checkbox"/>T-20104</p>
<input type="checkbox"/>	<p>Test Site – MRT Shenzhen Laboratory</p> <hr/> <p>Laboratory Location (Shenzhen) 1G, Building A, Junxiangda Building, Zhongshanyuan Road West, Nanshan District, Shenzhen, China</p> <hr/> <p>Laboratory Accreditations</p> <p>A2LA: 3628.02 CNAS: L10551</p> <p>FCC: CN1284 ISED: CN0105</p>
<input type="checkbox"/>	<p>Test Site – MRT Taiwan Laboratory</p> <hr/> <p>Laboratory Location (Taiwan) No. 38, Fuxing 2nd Rd., Guishan Dist., Taoyuan City 333, Taiwan (R.O.C.)</p> <hr/> <p>Laboratory Accreditations</p> <p>TAF: L3261-190725</p> <p>FCC: 291082, TW3261 ISED: TW3261</p>

1.4. Product Information

Product Name	Giga Hub
Model No.	FAST 5689E
EUT Identification No.	20220107Sample#17(Radiated) 20220107Sample#16(Conducted)
Wi-Fi Specification	802.11b/g/n/ac/ax
Zigbee Specification	802.15.4
Z-Wave Specification	800 ~ 900MHz radio frequency range
Antenna Information	Refer to Section 1.7
Power Type	AC Adapter
Operating Environment	Indoor Use
Accessories	
Adapter 1#	Model No.: NBS60E120500M2 Input: 100-127V, 50/60Hz, 1.5A Output: 12.0V=5.0A
Adapter 2#	Model No.: MS-Z5000R120-060C0-P Input: 100-127V, 50/60Hz, 1.5A Output: 12.0V=5.0A
Adapter 3#	Model No.: ADS-65HI-12A-2 12060E-L Input: 100-127V, 50/60Hz, 1.5A Output: 12.0V=5.0A
Remark: The information of EUT was provided by the manufacturer, and the accuracy of the information shall be the responsibility of the manufacturer.	

1.5. Radio Specification

Frequency Range	For 802.11a/n-HT20/ac-VHT20/ax-HE20: 5260 ~ 5320MHz, 5500 ~ 5580, 5660 ~ 5720MHz For 802.11n-HT40/ac-VHT40/ax-HE40: 5270 ~ 5310MHz, 5510 ~ 5550, 5670 ~ 5710MHz For 802.11ac-VHT80/ax-HE80: 5290MHz, 5530MHz, 5690MHz For 802.11ac-VHT160/ax-HE160: 5250MHz
Type of Modulation	802.11a/n/ac: OFDM 802.11ax: OFDMA
Data Rate	802.11a: 6/9/12/18/24/36/48/54Mbps 802.11n: up to 600Mbps 802.11ac: up to 3466.7Mbps 802.11ax: up to 4804Mbps
Remark: 1. For other features of this EUT, test report will be issued separately; 2. This device doesn't support 5600 ~ 5650MHz.	

1.6. Working Frequencies

802.11a/n-HT20/ac-VHT20/ax-HE20

Channel	Frequency	Channel	Frequency	Channel	Frequency
52	5260 MHz	56	5280 MHz	60	5300 MHz
64	5320 MHz	100	5500 MHz	104	5520 MHz
108	5540 MHz	112	5560 MHz	116	5580 MHz
132	5660 MHz	136	5680 MHz	140	5700 MHz
144	5720 MHz	--	--	--	--

802.11n-HT40/ac-VHT40/ax-HE40

Channel	Frequency	Channel	Frequency	Channel	Frequency
54	5270 MHz	62	5310 MHz	102	5510 MHz
110	5550MHz	134	5670 MHz	142	5710 MHz

802.11ac-VHT80/ax-HE80

Channel	Frequency	Channel	Frequency	Channel	Frequency
58	5290 MHz	106	5530 MHz	138	5690 MHz

802.11ac-VHT160/ax-HE160

Channel	Frequency	Channel	Frequency	Channel	Frequency
50	5250 MHz	--	--	--	--

1.7. Antenna Details

Antenna Type	Frequency Band (GHz)	Antenna Gain (dBi)				Directional Gain (dBi)	
		Ant 0	Ant 1	Ant 2	Ant 3	For Power	For PSD
Wi-Fi Antenna (4*4 MIMO)							
PIFA & Dipole	2.4 ~ 2.5	2.79	2.38	2.95	1.91	2.95	6.40
	5.15 ~ 5.25	3.37	4.41	3.51	3.53	4.41	6.46
	5.25 ~ 5.35	4.87	3.61	3.02	3.25	4.87	6.45
	5.47 ~ 5.725	4.73	4.07	3.46	3.88	4.73	6.76
	5.725 ~ 5.85	4.89	4.53	3.46	3.25	4.89	6.90
	5.925 ~ 7.125	4.13	3.18	4.51	4.83	4.83	7.03
ZigBee Antenna							
Dipole	2.4 ~ 2.5	2.98					
Z-Wave Antenna							
Dipole	0.9 ~ 1	-0.34					
Note 1: The antenna gain and directional gain refer to manufacturer's antenna specification. Note 2: Software automatically backs power down based on a $10\log(N)$ factor for beamforming operation. Note 3: The EUT supports Cyclic Delay Diversity (CDD) mode, and CDD signals are correlated.							
<ul style="list-style-type: none"> For power measurements: Array Gain = 0 dB for $N_{ANT} \leq 4$, the directional gain = max antenna gain + array gain For power density measurements: the max directional gain (each angle) = $10 \cdot \log[(10^{G1/20} + 10^{G2/20} + \dots + 10^{GN/20})^2 / N_{ANT}]$ dBi. 							

2. Test Configuration

2.1. Test Mode

Mode 1: Transmit by 802.11a (6Mbps)
Mode 2: Transmit by 802.11ac-VHT20 (MCS0)
Mode 3: Transmit by 802.11ac-VHT40 (MCS0)
Mode 4: Transmit by 802.11ac-VHT80 (MCS0)
Mode 5: Transmit by 802.11ac-VHT160 (MCS0)
Mode 6: Transmit by 802.11ax-HE20 (MCS0)
Mode 7: Transmit by 802.11ax-HE40 (MCS0)
Mode 8: Transmit by 802.11ax-HE80 (MCS0)
Mode 9: Transmit by 802.11 ax-HE160 (MCS0)

Note: Due to the same modulation between 802.11n and 802.11ac, so 802.11n are covered by 802.11ac in this report, meanwhile, power level for 802.11n will not be greater than 802.11ac.

2.2. Test System Connection Diagram

The device was tested per the guidance ANSI C63.10: 2013 was used to reference the appropriate EUT setup for radiated emissions testing and AC line conducted testing.

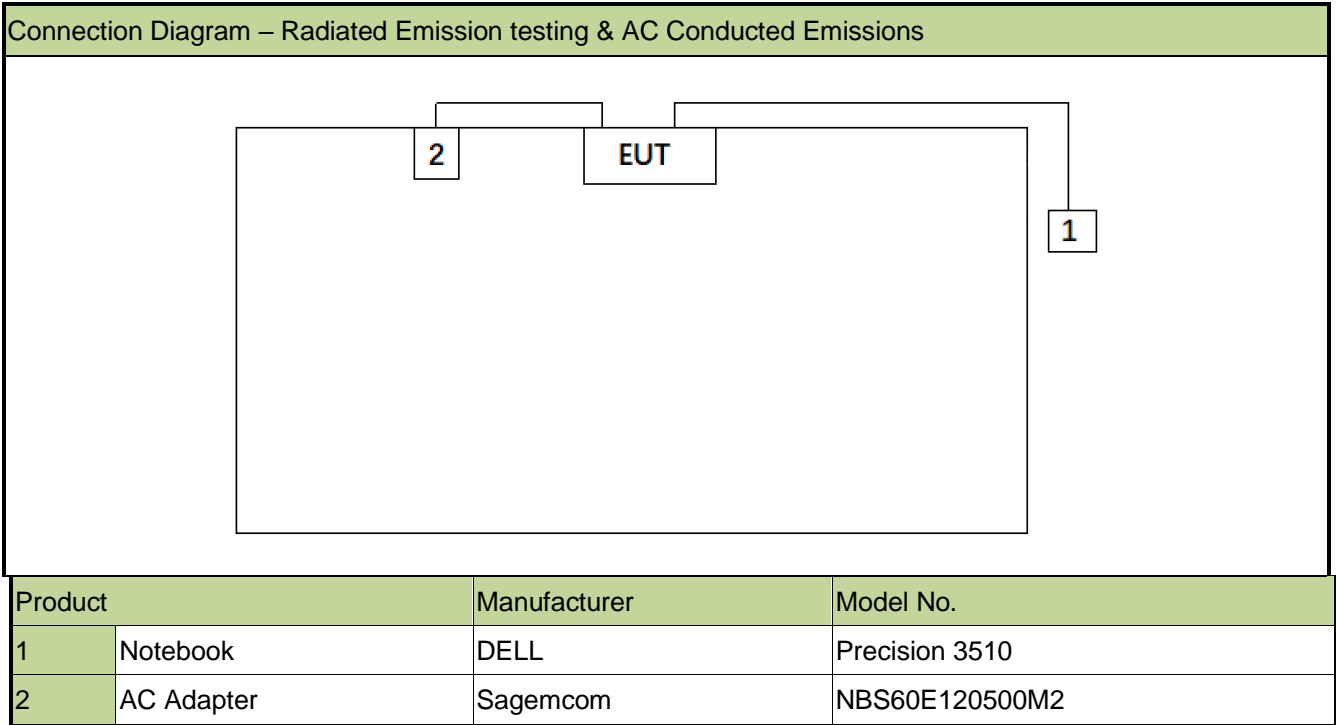

2.3. Test Software

The test utility software used during testing was “accessMTool”, and the version was 3.2.1.3.

Note: Final power setting please refer to operational description.

2.4. Applied Standards

According to the specifications of the manufacturer, the EUT must comply with the requirements of the following standards:

- FCC Part 15.407
- KDB 789033 D02v02r01
- KDB 662911 D01v02r01
- ANSI C63.10-2013

2.5. Test Environment Condition

Ambient Temperature	15 ~ 35°C
Relative Humidity	20 ~ 75%RH

3. Antenna Requirements

Excerpt from §15.203 of the FCC Rules/Regulations:

“An intentional radiator antenna shall be designed to ensure that no antenna other than that furnished by the responsible party can be used with the device. The use of a permanently attached antenna or of an antenna that uses a unique coupling to the intentional radiator shall be considered sufficient to comply with the provisions of this section.”

- The antenna of the device is **permanently attached**.
- There are no provisions for connection to an external antenna.

Conclusion:

The unit complies with the requirement of §15.203.

4. Measuring Instrument

Instrument	Manufacturer	Model No.	Asset No.	Cali. Interval	Cali. Due Date	Test Site
EMI Test Receiver	R&S	ESR7	MRTSUE06001	1 year	2022/12/29	WZ-AC1
Horn Antenna	Schwarzbeck	BBHA 9120D	MRTSUE06023	1 year	2022/9/16	WZ-AC1
Preamplifier	Agilent	83017A	MRTSUE06076	1 year	2022/11/12	WZ-AC1
TRILOG Antenna	Schwarzbeck	VULB 9168	MRTSUE06172	1 year	2022/8/5	WZ-AC1
Anechoic Chamber	TDK	WZ-AC1	MRTSUE06212	1 year	2022/4/29	WZ-AC1
Thermohygrometer	testo	608-H1	MRTSUE06403	1 year	2022/6/28	WZ-AC1
Signal Analyzer	Keysight	N9010B	MRTSUE06607	1 year	2022/12/29	WZ-AC1
Thermohygrometer	testo	Testo 608-H1	MRTSUE11039	1 year	2022/11/11	WZ-AC1
Loop Antenna	Schwarzbeck	FMZB 1519	MRTSUE06025	1 year	2022/10/28	WZ-AC1
Horn Antenna	Schwarzbeck	BBHA 9170	MRTSUE06597	1 year	2022/12/1	WZ-AC1
Preamplifier	EMCI	EMC184045SE	MRTSUE06640	1 year	2023/1/13	WZ-AC1
Temperature Chamber	BAOYT	BYH-150CL	MRTSUE06051	1 year	2022/10/10	WZ-TR3
Thermohygrometer	testo	608-H1	MRTSUE06401	1 year	2022/6/28	WZ-TR3
Signal Analyzer	Keysight	N9010B	MRTSUE06558	1 year	2022/6/24	WZ-TR3
Signal Analyzer	Agilent	N9020A	MRTSUE06106	1 year	2022/4/13	WZ-TR3
USB Power Sensor	Keysight	U2021XA	MRTSUE06446	1 year	2022/6/8	WZ-TR3
Two-Line V-Network	R&S	ENV216	MRTSUE06002	1 year	2022/6/8	WZ-SR2
Thermohygrometer	testo	608-H1	MRTSUE06404	1 year	2022/6/28	WZ-SR2
Four-Line V-Network	R&S	ENV432	MRTSUE06615	1 year	2022/10/13	WZ-SR2
EMI Test Receiver	R&S	ESR3	MRTSUE06909	1 year	2022/11/1	WZ-SR2

Software	Version	Function
EMI Software	V3	EMI Test Software

5. Measurement Uncertainty

Where relevant, the following test uncertainty levels have been estimated for tests performed on the EUT as specified in CISPR 16-4-2. This uncertainty represents an expanded uncertainty expressed at approximately the 95% confidence level using a coverage factor of $k = 2$.

AC Conducted Emission Measurement
Measurement Uncertainty for a Level of Confidence of 95% ($U=2Uc(y)$): 9kHz~150kHz: 3.74dB 150kHz~30MHz: 3.44dB
Radiated Disturbance
Measurement Uncertainty for a Level of Confidence of 95% ($U=2Uc(y)$): Horizontal: 30MHz~300MHz: 5.04dB 300MHz~1GHz: 4.95dB 1GHz~40GHz: 6.40dB Vertical: 30MHz~300MHz: 5.24dB 300MHz~1GHz: 6.03dB 1GHz~40GHz: 6.40dB
Spurious Emissions, Conducted
Measuring Uncertainty for a Level of Confidence of 95% ($U=2Uc(y)$): 0.78dB
Output Power
Measuring Uncertainty for a Level of Confidence of 95% ($U=2Uc(y)$): 1.13dB
Power Spectrum Density
Measuring Uncertainty for a Level of Confidence of 95% ($U=2Uc(y)$): 1.15dB
Occupied Bandwidth
Measuring Uncertainty for a Level of Confidence of 95% ($U=2Uc(y)$): 0.28%

6. Test Result

6.1. Summary

FCC Section(s)	Test Description	Test Condition	Verdict
15.407(a)	26dB & 99% Bandwidth	Conducted	Pass
15.407(2), (3)	Maximum Conducted Output Power		Pass
15.407(h)(1)	Transmit Power Control		Pass
15.407(2), (3)	Peak Power Spectral Density		Pass
15.407(b)(2), (3)	Undesirable Emissions		Pass
15.205, 15.209 15.407(b)(8), (9)	General Field Strength Limits (Restricted Bands and Radiated Emission Limits)	Radiated	Pass
15.207	AC Conducted Emissions 150kHz - 30MHz	Line Conducted	Pass

Remark:

- The analyzer plots shown in this section were all taken with a correction table loaded into the analyzer. The correction table was used to account for the losses of the cables and attenuators used as part of the system to connect the EUT to the analyzer at all frequencies of interest.
- Output power test was verified over all data rates of each mode (data refers to operational description), and then choose the maximum power output (low data rate) for final test of each channel.
- EUT supports one configuration only in 802.11ax full RU mode.

6.2. 26dB & 99% Bandwidth Measurement

6.2.1. Test Limit

N/A

6.2.2. Test Procedure

KDB 789033 D02v02r01- Section C.1 (26dB Bandwidth)

KDB 789033 D02v02r01- Section D (99% Bandwidth)

6.2.3. Test Setting

26dB Bandwidth

1. The analyzers' automatic bandwidth measurement capability was used to perform the 26dB bandwidth measurement. The "X" dB bandwidth parameter was set to $X = 26$. The automatic bandwidth measurement function also has the capability of simultaneously measuring the 99% occupied bandwidth. The bandwidth measurement was not influenced by any intermediated power nulls in the fundamental emission.
2. RBW = approximately 1% of the emission bandwidth.
3. VBW $\geq 3 \times$ RBW.
4. Detector = Peak.
5. Trace mode = max hold.

99% Bandwidth

1. Set center frequency to the nominal EUT channel center frequency.
2. Set span = 1.5 times to 5.0 times the OBW.
3. Set RBW = 1% to 5% of the OBW
4. Set VBW $\geq 3 \times$ RBW
5. Detector = Peak.
6. Use the 99% power bandwidth function of the instrument.

6.2.4. Test Setup

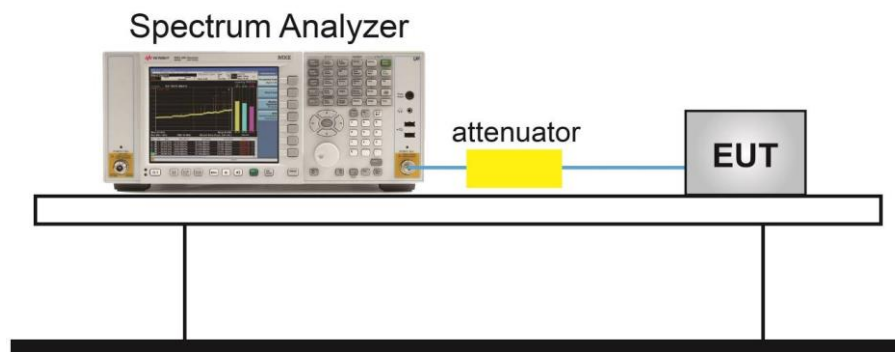

6.2.5. Test Result

Refer to Appendix A.2.

6.3. Output Power Measurement

6.3.1. Test Limit

For the 5.25-5.35 GHz and 5.47-5.725 GHz bands, the maximum conducted output power over the frequency bands of operation shall not exceed the lesser of 250 mW or $11 \text{ dBm} + 10 \log B$, where B is the 26 dB emission bandwidth in megahertz.

If transmitting antennas of directional gain greater than 6dBi are used, the maximum conducted output power shall be reduced by the amount in dB that the directional gain of the antenna exceeds 6dBi.

6.3.2. Test Procedure

KDB 789033D02v02r01- Section E)3)b) Method PM-G

6.3.3. Test Setting

Average Power Measurement

Average power measurements were performed only when the EUT was transmitting at its maximum power control level using a broadband power meter with a pulse sensor. The power meter implemented triggering and gating capabilities which were set up such that power measurements were recorded only during the ON time of the transmitter.

6.3.4. Test Setup

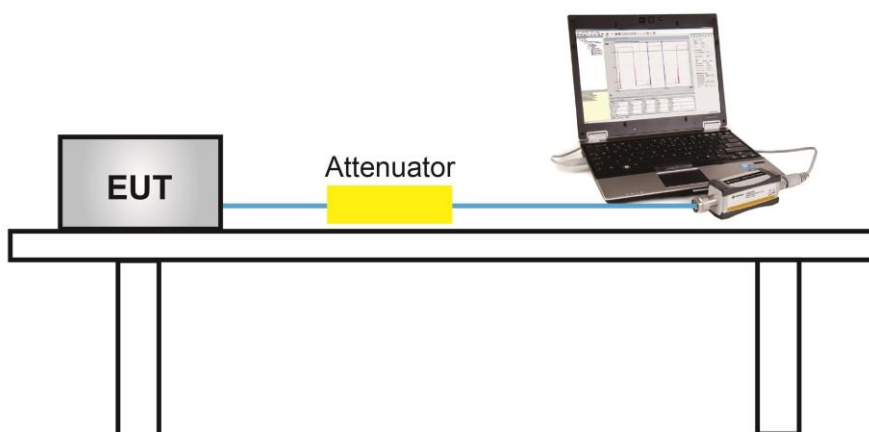

6.3.5. Test Result

Refer to Appendix A.3.

6.4. Transmit Power Control Measurement

6.4.1. Test Limit

The U-NII device is required to have the capability to operate at least 6 dB below the mean EIRP value of 30 dBm.

6.4.2. Test Procedure

KDB 789033 D02v01- Section E)3)b) Method PM-G

6.4.3. Test Setting

Average power measurements were performed only when the EUT was transmitting at its maximum power control level using a broadband power meter with a pulse sensor. The power meter implemented triggering and gating capabilities which were set up such that power measurements were recorded only during the ON time of the transmitter. The trace was averaged over 100 traces to obtain the final measured average power.

6.4.4. Test Setup

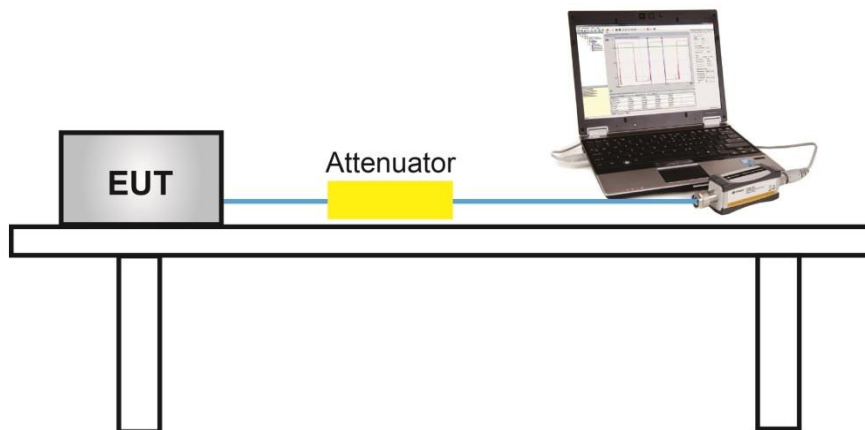

6.4.5. Test Result

Device supports TPC mechanism, details refer to the operational description.

6.5. Power Spectral Density Measurement

6.5.1. Test Limit

For the 5.25-5.35 GHz and 5.47-5.725 GHz bands, the maximum power spectral density shall not exceed 11 dBm in any 1 megahertz band.

If transmitting antennas of directional gain greater than 6dBi are used, the peak power spectral density shall be reduced by the amount in dB that the directional gain of the antenna exceeds 6dBi.

6.5.2. Test Procedure

KDB 789033 D02v02r01-SectionF

6.5.3. Test Setting

1. Analyzer was set to the center frequency of the UNII channel under investigation
2. Span was set to encompass the entire 26dB EBW of the signal.
3. RBW = 1MHz, if measurement bandwidth of Maximum PSD is specified in 500 kHz,
4. RBW = 510 kHz
5. VBW = 3MHz
6. Number of sweep points $\geq 2 \times (\text{span} / \text{RBW})$
7. Detector = power averaging (Average)
8. Sweep time = auto
9. Trigger = free run
10. Use the peak search function on the instrument to find the peak of the spectrum and record its value.
11. Add $10 \cdot \log(1/x)$, where x is the duty cycle, to the measured power in order to compute the average power during the actual transmission times (because the measurement represents an average over both the on and off times of the transmission). For example, add $10 \cdot \log(1/0.25) = 6$ dB if the duty cycle is 25 percent.

6.5.4. Test Setup

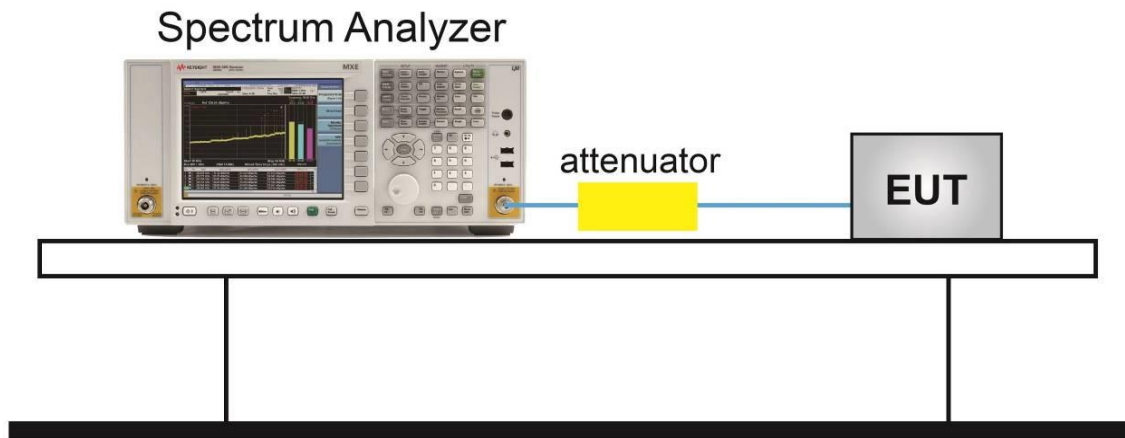

6.5.5. Test Result

Refer to Appendix A.4.

6.6. Frequency Stability Measurement

6.6.1. Test Limit

Manufacturers of U-NII devices are responsible for ensuring frequency stability such that an emission is maintained within the band of operation under all conditions of normal operation as specified in the user's manual.

6.6.2. Test Procedure

Frequency Stability Under Temperature Variations:

The equipment under test was connected to an external AC or DC power supply and input rated voltage. RF output was connected to a frequency counter or spectrum analyzer via feed through attenuators. The EUT was placed inside the temperature chamber. Set the spectrum analyzer RBW low enough to obtain the desired frequency resolution and measure EUT 20°C operating frequency as reference frequency. Turn EUT off and set the chamber temperature to highest. After the temperature stabilized for approximately 30 minutes recorded the frequency. Repeat step measure with 10°C decreased per stage until the lowest temperature reached.

Frequency Stability Under Voltage Variations:

Set chamber temperature to 20°C. Use a variable AC power supply / DC power source to power the EUT and set the voltage to rated voltage. Set the spectrum analyzer RBW low enough to obtain the desired frequency resolution and recorded the frequency.

Reduce the input voltage to specify extreme voltage variation ($\pm 15\%$) and endpoint, record the maximum frequency change.

6.6.3. Test Setup

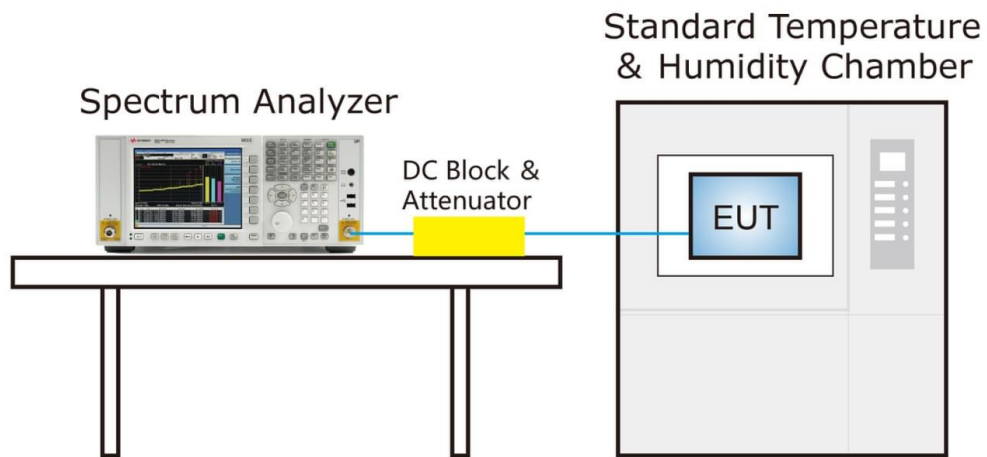

6.6.4. Test Result

Refer to 2201RSU021-U3 Appendix A.6.

6.7. Radiated Spurious Emission Measurement

6.7.1. Test Limit

All out of band emissions appearing in a restricted band as specified in Section 15.205 of the Title 47 CFR must not exceed the limits shown in Table per Section 15.209.

FCC Part 15 Subpart C Paragraph 15.209		
Frequency [MHz]	Field Strength [uV/m]	Measured Distance [Meters]
0.009 - 0.490	2400/F (kHz)	300
0.490 - 1.705	24000/F (kHz)	30
1.705 - 30	30	30
30 - 88	100	3
88 - 216	150	3
216 - 960	200	3
Above 960	500	3

6.7.2. Test Procedure

KDB 789033 D02v02r01- Section G

6.7.3. Test Setting

Table 1 - RBW as a function of frequency

Frequency	RBW
9 ~ 150 kHz	200 ~ 300 Hz
0.15 ~ 30 MHz	9 ~ 10 kHz
30 ~ 1000 MHz	100 ~ 120 kHz
> 1000MHz	1MHz

Quasi-Peak Measurements below 1GHz

1. Analyzer center frequency was set to the frequency of the radiated spurious emission of interest
2. Span was set greater than 1MHz
3. RBW = as specified in Table 1
4. Detector = CISPR quasi-peak
5. Sweep time = auto couple
6. Trace was allowed to stabilize

Peak Measurements above 1GHz

1. Analyzer center frequency was set to the frequency of the radiated spurious emission of interest
2. RBW = 1MHz
3. VBW = 3MHz
4. Detector = peak
5. Sweep time = auto couple
6. Trace mode = max hold
7. Trace was allowed to stabilize

Average Measurements above 1GHz (Method VB)

1. Analyzer center frequency was set to the frequency of the radiated spurious emission of interest
2. RBW = 1MHz
3. VBW; If the EUT is configured to transmit with duty cycle $\geq 98\%$, set VBW = 10 Hz.
If the EUT duty cycle is $< 98\%$, set VBW $\geq 1/T$. T is the minimum transmission duration.
4. Detector = Peak
5. Sweep time = auto
6. Trace mode = max hold
7. Trace was allowed to stabilize

6.7.4. Test Setup

Below 1GHz Test Setup:

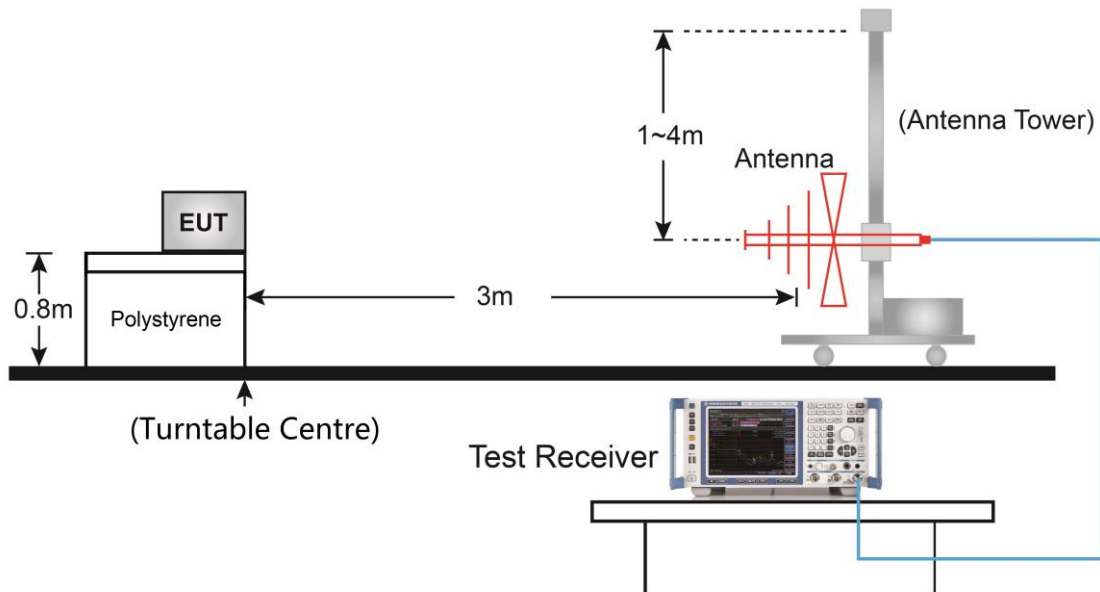

Above 1GHz Test Setup:

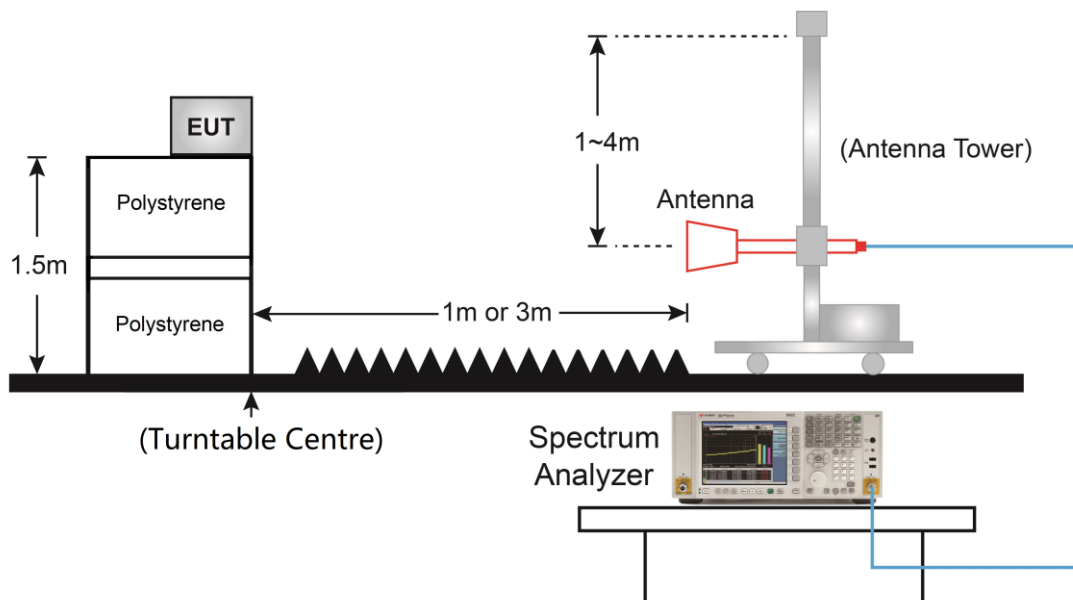

6.7.5. Test Result

Refer to Appendix A.5.

6.8. Radiated Restricted Band Edge Measurement

6.8.1. Test Limit

For 15.205 requirement:

Radiated emissions which fall in the restricted bands, as defined in Section 15.205(a) of FCC part 15, must also comply with the radiated emission limits specified in Section 15.209(a).

Frequency (MHz)	Frequency (MHz)	Frequency (MHz)	Frequency (GHz)
0.090 - 0.110	16.42 - 16.423	399.9 - 410	4.5 - 5.15
¹ 0.495 - 0.505	16.69475 - 16.69525	608 - 614	5.35 - 5.46
2.1735 - 2.1905	16.80425 - 16.80475	960 - 1240	7.25 - 7.75
4.125 - 4.128	25.5 - 25.67	1300 - 1427	8.025 - 8.5
4.17725 - 4.17775	37.5 - 38.25	1435 - 1626.5	9.0 - 9.2
4.20725 - 4.20775	73 - 74.6	1645.5 - 1646.5	9.3 - 9.5
6.215 - 6.218	74.8 - 75.2	1660 - 1710	10.6 - 12.7
6.26775 - 6.26825	108 - 121.94	1718.8 - 1722.2	13.25 - 13.4
6.31175 - 6.31225	123 - 138	2200 - 2300	14.47 - 14.5
8.291 - 8.294	149.9 - 150.05	2310 - 2390	15.35 - 16.2
8.362 - 8.366	156.52475 - 156.52525	2483.5 - 2500	17.7 - 21.4
8.37625 - 8.38675	156.7 - 156.9	2690 - 2900	22.01 - 23.12
8.41425 - 8.41475	162.0125 - 167.17	3260 - 3267	23.6 - 24.0
12.29 - 12.293	167.72 - 173.2	3332 - 3339	31.2 - 31.8
12.51975 - 12.52025	240 - 285	3345.8 - 3358	36.43 - 36.5
12.57675 - 12.57725	322 - 335.4	3600 - 4400	(²)
13.36 - 13.41	--	--	--

For 15.407(b) requirement:

For transmitters operating in the 5.25-5.35 GHz band: All emissions outside of the 5.15-5.35 GHz band shall not exceed an e.i.r.p. of -27 dBm/MHz.

For transmitters operating in the 5.47-5.725 GHz band: All emissions outside of the 5.47-5.725 GHz band shall not exceed an e.i.r.p. of -27 dBm/MHz.

Refer to KDB 789033 D02v02r01 G)2)c), as specified in § 15.407(b), emissions above 1000 MHz that are outside of the restricted bands are subject to a maximum emission limit of -27 dBm/MHz (or -17 dBm/MHz as specified in § 15.407(b)(4)). However, an out-of-band emission that complies with both the peak and average limits of § 15.209 is not required to satisfy the -27 dBm/MHz or -17 dBm/MHz maximum emission limit.

All out of band emissions appearing in a restricted band as specified in Section 15.205 of the Title 47CFR must not exceed the limits shown in Table per Section 15.209.

FCC Part 15 Subpart C Paragraph 15.209		
Frequency [MHz]	Field Strength [uV/m]	Measured Distance [Meters]
0.009 - 0.490	2400/F (kHz)	300
0.490 - 1.705	24000/F (kHz)	30
1.705 - 30	30	30
30 - 88	100	3
88 - 216	150	3
216 - 960	200	3
Above 960	500	3

6.8.2. Test Procedure

KDB 789033 D02v02r01- Section G

6.8.3. Test Setting

Peak Measurements above 1GHz

1. Analyzer center frequency was set to the frequency of the radiated spurious emission of interest
2. RBW = 1MHz
3. VBW = 3MHz
4. Detector = Peak
5. Sweep time = Auto couple
6. Trace mode = Max hold
7. Trace was allowed to stabilize

Average Measurements above 1GHz (Method VB)

1. Analyzer center frequency was set to the frequency of the radiated spurious emission of interest
2. RBW = 1MHz
3. VBW; if the EUT is configured to transmit with duty cycle $\geq 98\%$, set VBW = 10Hz
4. If the EUT duty cycle is $< 98\%$, set VBW $\geq 1/T$. T is the minimum transmission duration
5. Detector = Peak
6. Sweep time = Auto
7. Trace mode = Max hold
8. Trace was allowed to stabilize

6.8.4. Test Setup

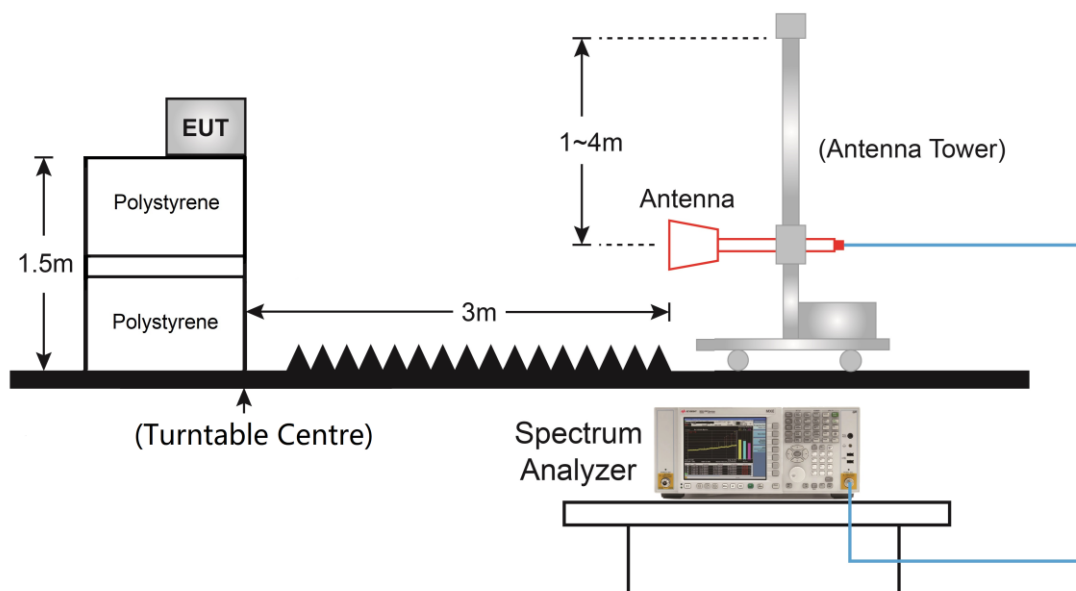

6.8.5. Test Result

Refer to Appendix A.6.

6.9. AC Conducted Emissions Measurement

6.9.1. Test Limit

FCC Part 15 Subpart C Paragraph 15.207 Limits		
Frequency (MHz)	QP (dBuV)	AV (dBuV)
0.15 ~ 0.50	66 ~ 56	56 ~ 46
0.50 ~ 5.0	56	46
5.0 ~ 30	60	50

Note 1: The lower limit shall apply at the transition frequencies.

Note 2: The limit decreases linearly with the logarithm of the frequency in the range 0.15MHz to 0.5MHz.

6.9.2. Test Setup

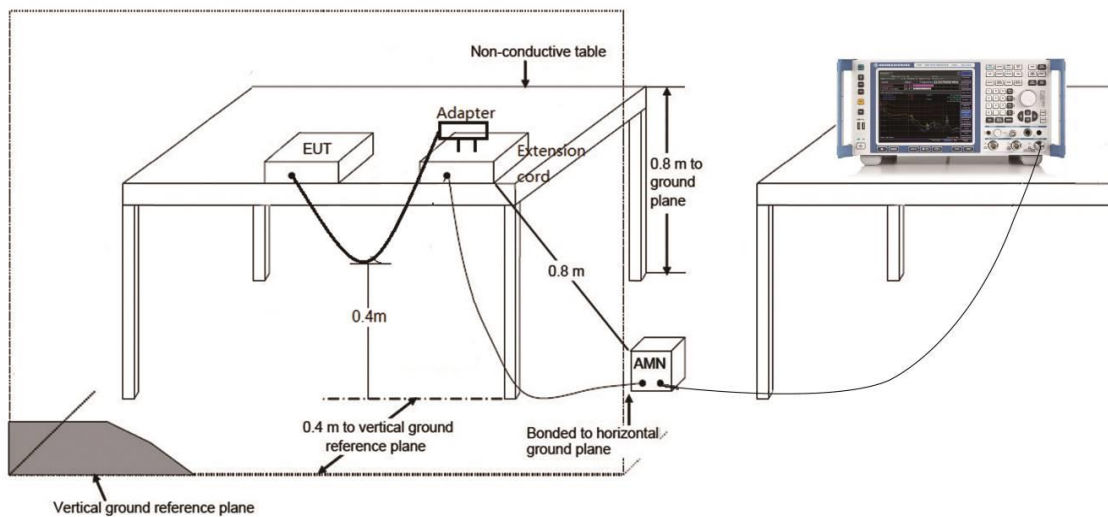

6.9.3. Test Result

Refer to 2201RSU021-U3 Appendix A.9.

Appendix A – Test Result

A.1 Duty Cycle Test Result

Test Mode	Duty Cycle
802.11ac-VHT160	89.82%
802.11ax-HE160	89.39%
Duty Cycle (T = Transmission Duration)	
802.11ac-VHT160 (T = 251.5us)	802.11ax-HE160 (T = 236.0us)

802.11ac-VHT160 (T = 251.5us)

802.11ax-HE160 (T = 236.0us)

Note: For other modes, refer to 2201RSU021-U3 Appendix A.1.

A.2 26dB & 99% Bandwidth Test Result

Test Site	WZ-TR3	Test Engineer	Luis Yang
Test Date	2022/01/18 ~ 2022/01/27		

Test Mode	Data Rate/ MCS	Channel No.	Frequency (MHz)	26dB Bandwidth (MHz)	99% Bandwidth (MHz)
11a	6Mbps	52	5260	20.98	16.66
11a	6Mbps	60	5300		
11a	6Mbps	64	5320	21.85	16.92
11a	6Mbps	100	5500	21.68	16.87
11a	6Mbps	116	5580	21.11	16.71
11a	6Mbps	140	5700	21.13	16.71
11a	6Mbps	144	5720	21.23	16.72
11ac-VHT20	MCS0	52	5260	21.62	17.93
11ac-VHT20	MCS0	60	5300	21.53	17.91
11ac-VHT20	MCS0	64	5320	21.90	18.01
11ac-VHT20	MCS0	100	5500	23.25	18.17
11ac-VHT20	MCS0	116	5580	21.54	17.81
11ac-VHT20	MCS0	140	5700	21.47	17.91
11ac-VHT20	MCS0	144	5720	21.40	17.91
11ac-VHT40	MCS0	54	5270	40.03	36.31
11ac-VHT40	MCS0	62	5310	56.89	36.92
11ac-VHT40	MCS0	102	5510	46.25	36.48
11ac-VHT40	MCS0	110	5550	39.77	36.28
11ac-VHT40	MCS0	134	5670	40.06	36.23
11ac-VHT40	MCS0	142	5710	39.69	36.29
11ac-VHT80	MCS0	58	5290	89.76	76.03
11ac-VHT80	MCS0	106	5530	86.36	75.76
11ac-VHT80	MCS0	138	5690	81.16	75.79
11ac-VHT160	MCS0	50	5250	162.80	153.68

Test Mode	Data Rate/ MCS	Channel No.	Frequency (MHz)	26dB Bandwidth (MHz)	99% Bandwidth (MHz)
11ax-HE20	MCS0	52	5260	21.93	19.04
11ax-HE20	MCS0	60	5300	21.72	19.08
11ax-HE20	MCS0	64	5320	22.41	19.10
11ax-HE20	MCS0	100	5500	23.90	19.19
11ax-HE20	MCS0	116	5580	21.38	19.08
11ax-HE20	MCS0	140	5700	21.57	19.06
11ax-HE20	MCS0	144	5720	21.39	19.05
11ax-HE40	MCS0	54	5270	40.16	37.78
11ax-HE40	MCS0	62	5310	42.46	37.81
11ax-HE40	MCS0	102	5510	43.58	37.86
11ax-HE40	MCS0	110	5550	40.00	37.67
11ax-HE40	MCS0	134	5670	40.19	37.66
11ax-HE40	MCS0	142	5710	40.51	37.73
11ax-HE80	MCS0	58	5290	85.28	77.32
11ax-HE80	MCS0	106	5530	84.36	77.18
11ax-HE80	MCS0	138	5690	81.19	77.19
11ax-HE160	MCS0	50	5250	163.20	156.17

802.11a 26dB Bandwidth

Channel 52 (5260MHz)

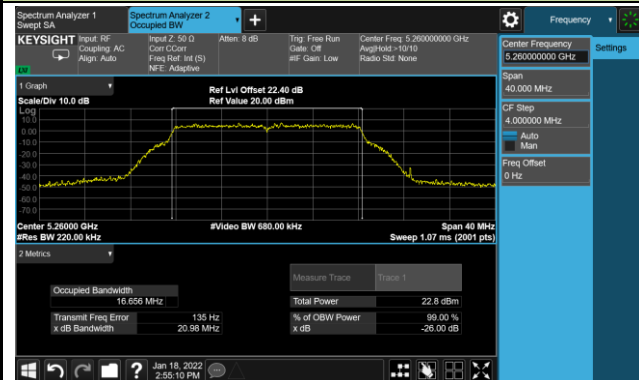

Channel 60 (5300MHz)

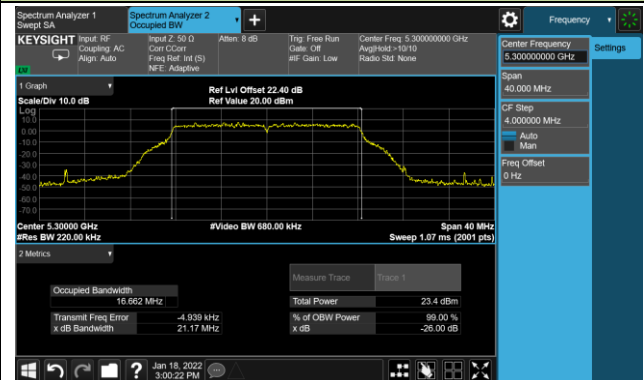

Channel 64 (5320MHz)

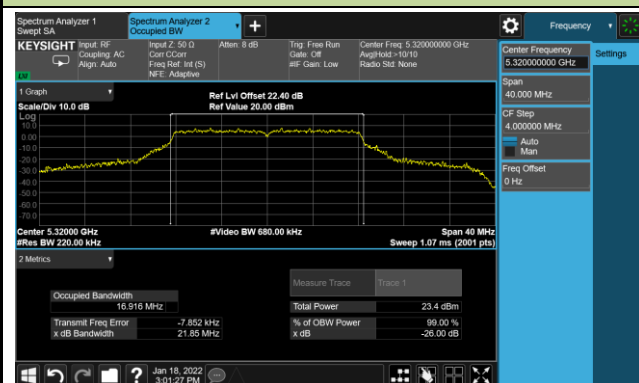

Channel 100 (5500MHz)

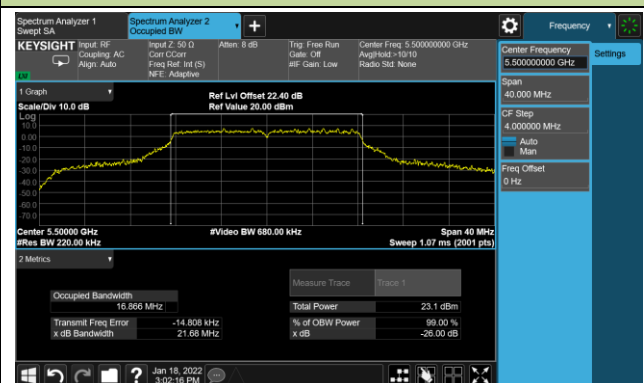

Channel 116 (5580MHz)

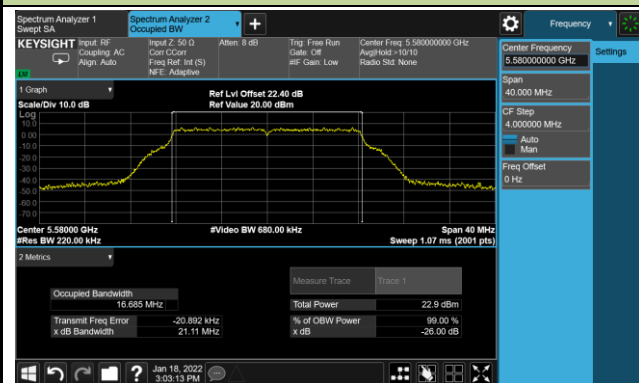

Channel 140 (5700MHz)

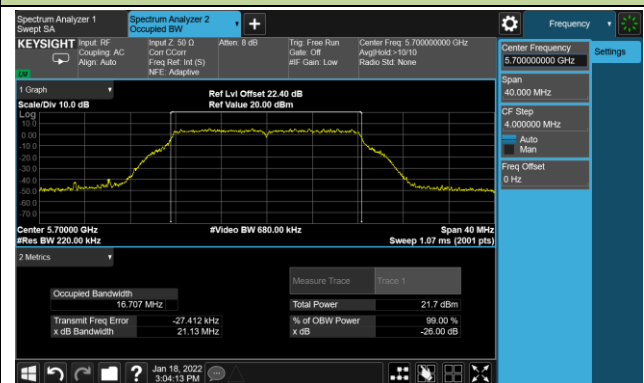

Channel 144(5720MHz)

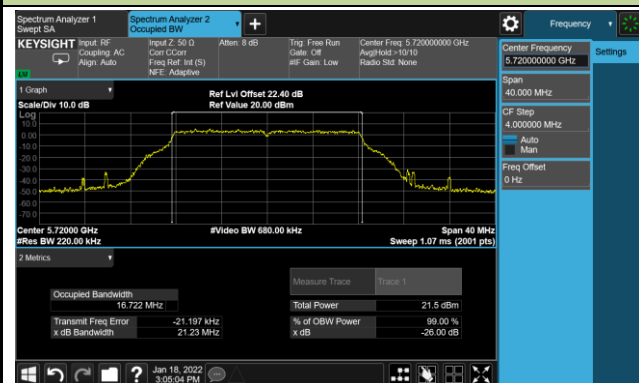

802.11ac-VHT20 26dB Bandwidth

Channel 52 (5260MHz)

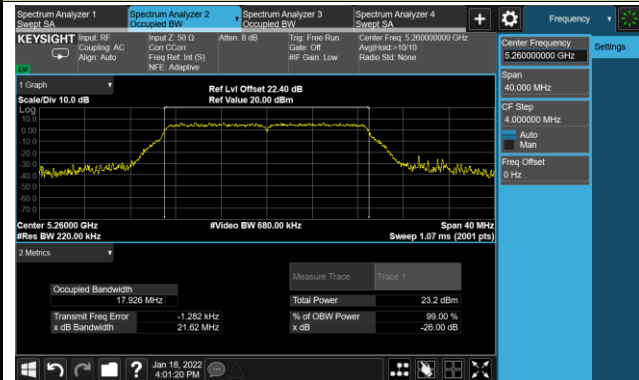

Channel 60 (5300MHz)

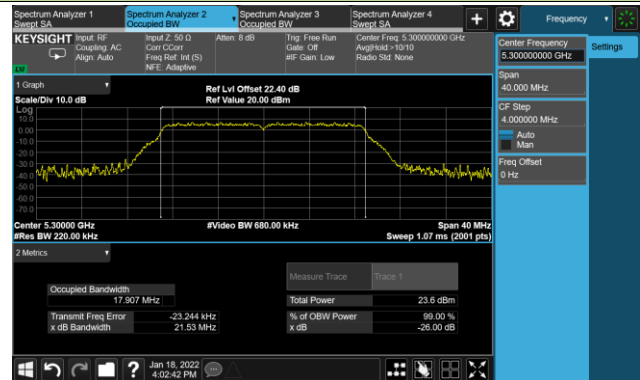

Channel 64 (5320MHz)

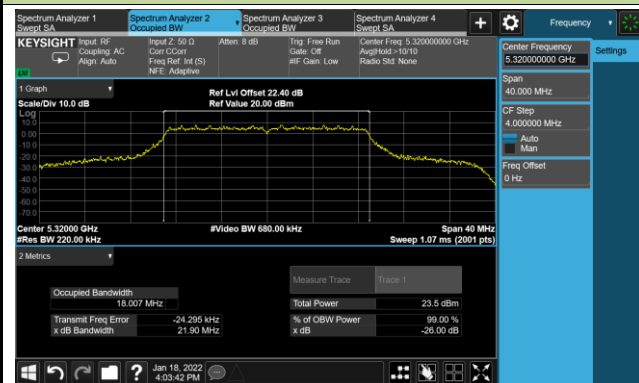

Channel 100 (5500MHz)

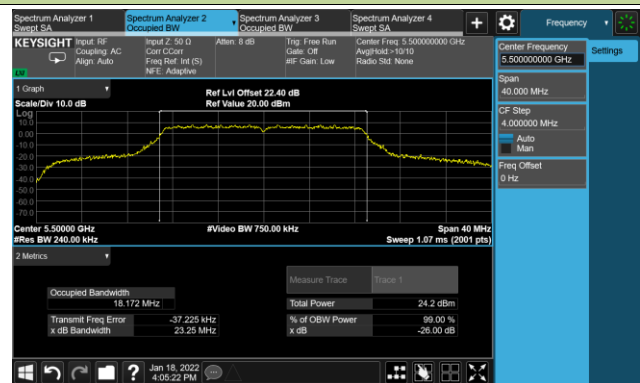

Channel 116 (5580MHz)

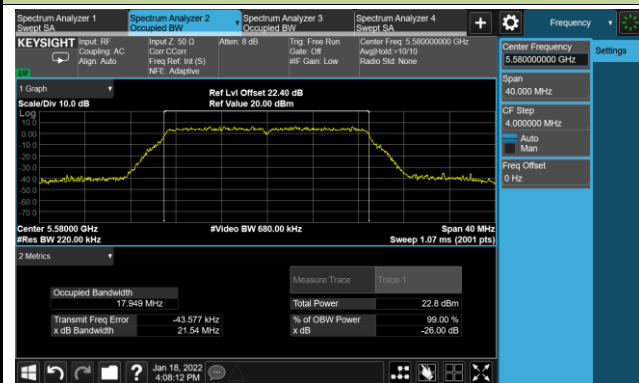

Channel 140 (5700MHz)

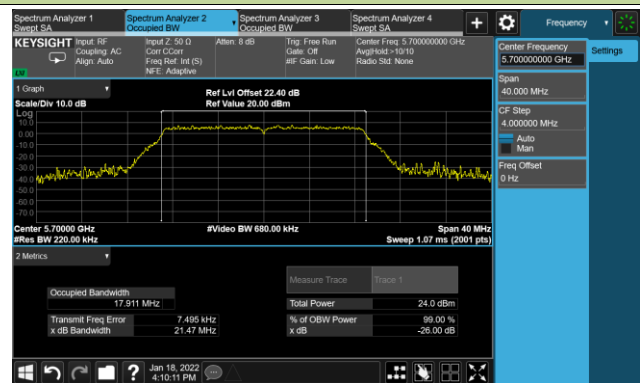

Channel 144(5720MHz)

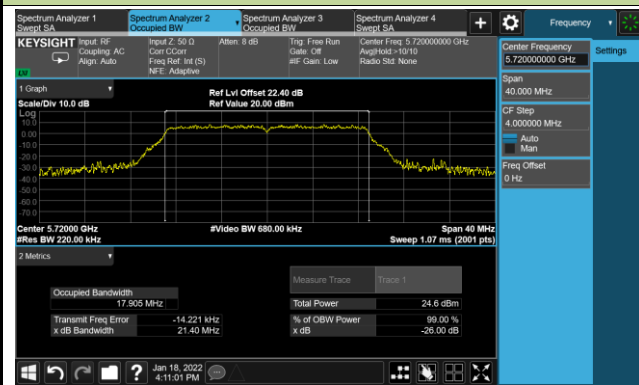

802.11ac-VHT40 26dB Bandwidth

Channel 54 (5270MHz)

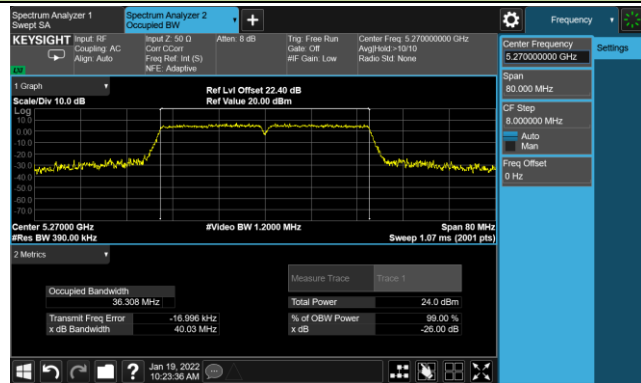

Channel 62 (5310MHz)

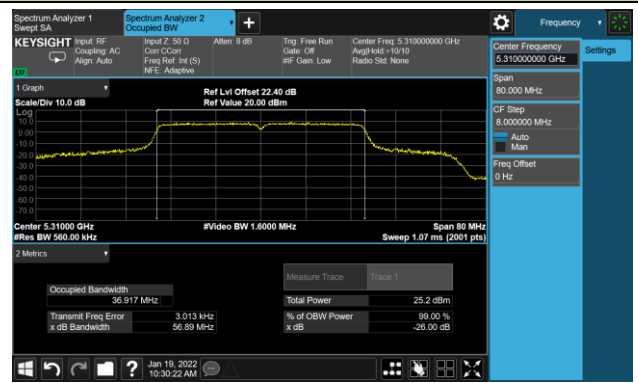

Channel 102 (5510MHz)

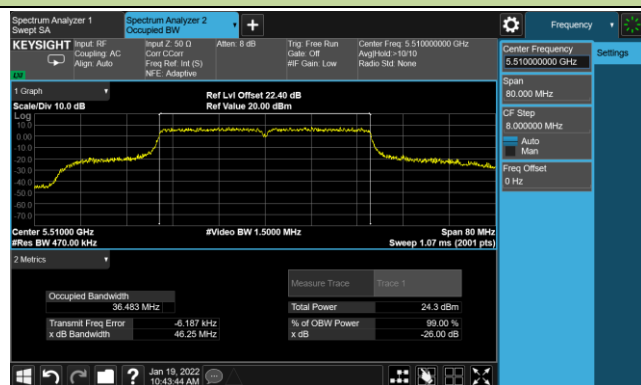

Channel 110 (5550MHz)

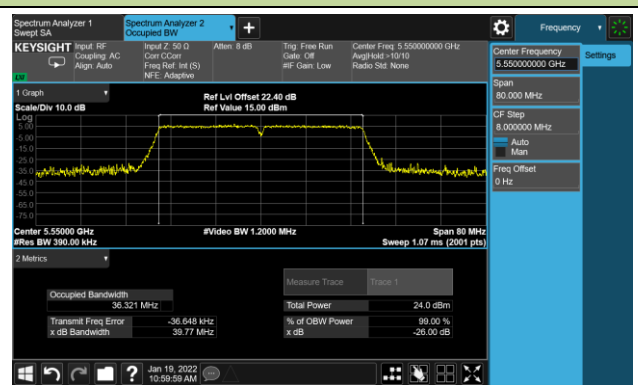

Channel 134 (5670MHz)

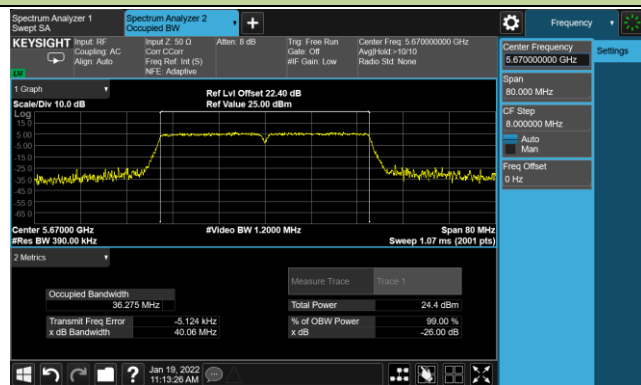

Channel 142(5710MHz)

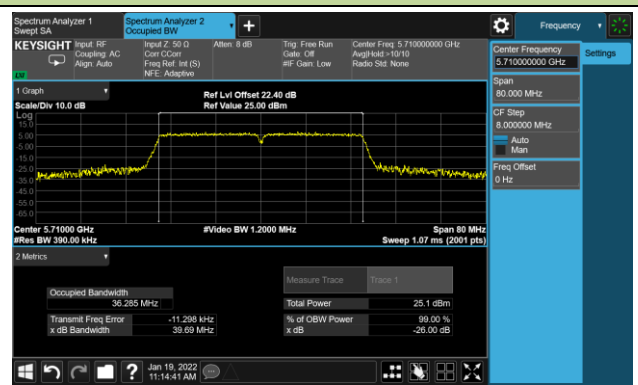

802.11ac-VHT80 26dB Bandwidth

Channel 58 (5290MHz)

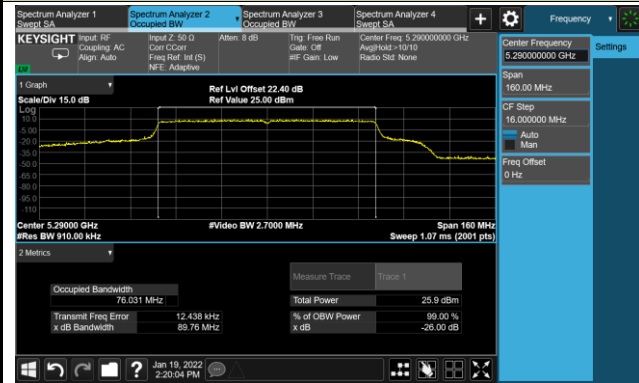

Channel 106 (5530MHz)

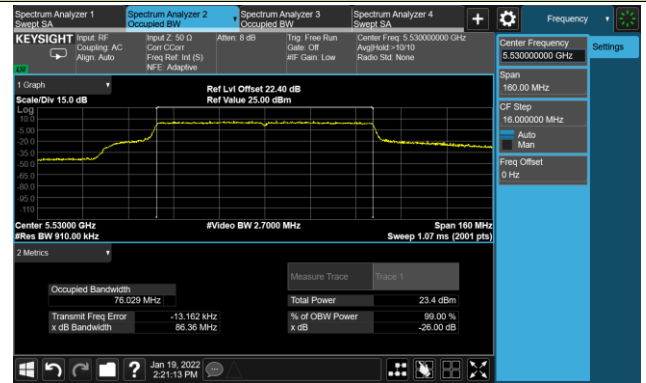

Channel 138 (5690MHz)

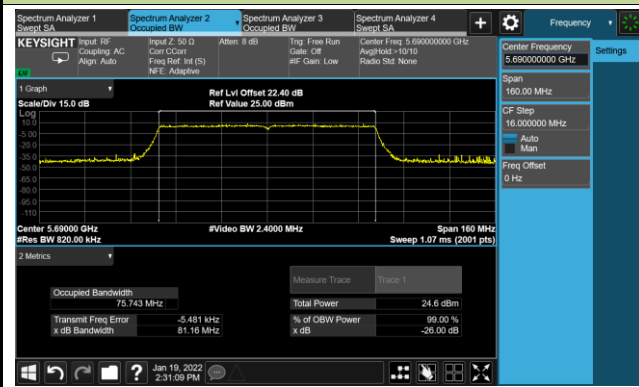

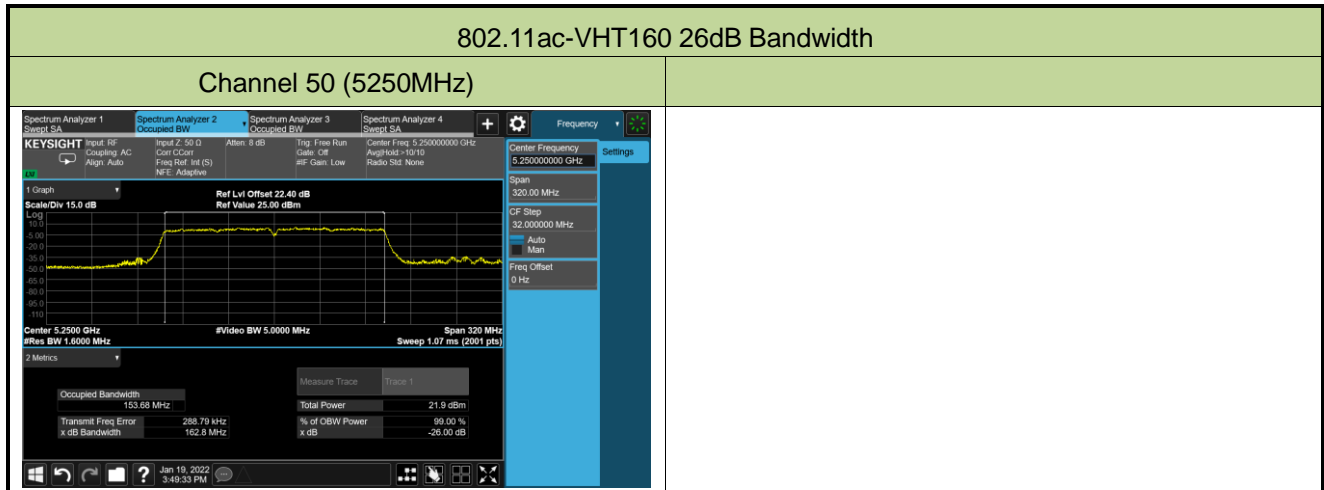

802.11ax-HE20 26dB Bandwidth

Channel 52 (5260MHz)

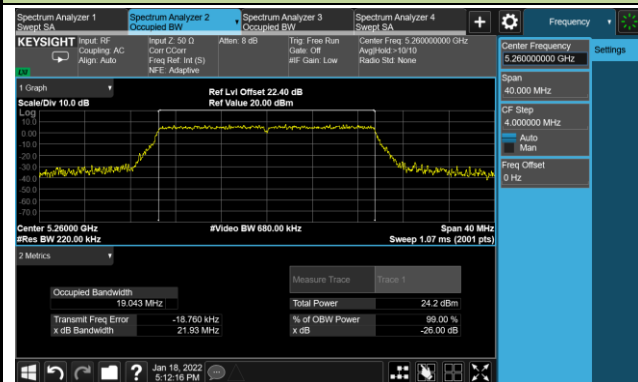

Channel 60 (5300MHz)

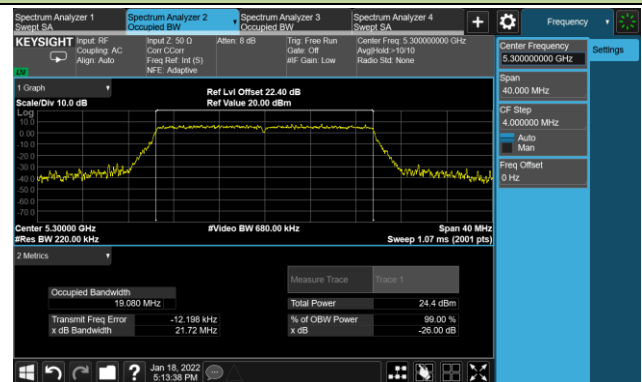

Channel 64 (5320MHz)

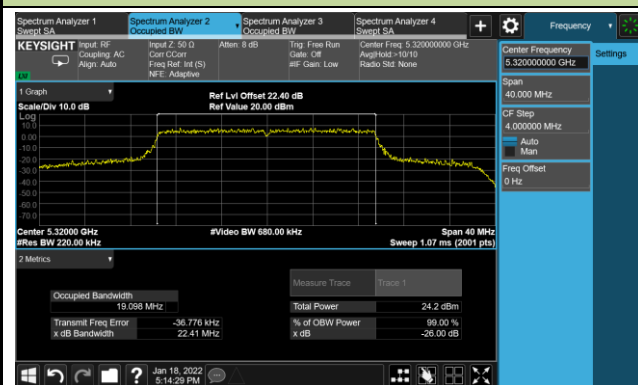

Channel 100 (5500MHz)

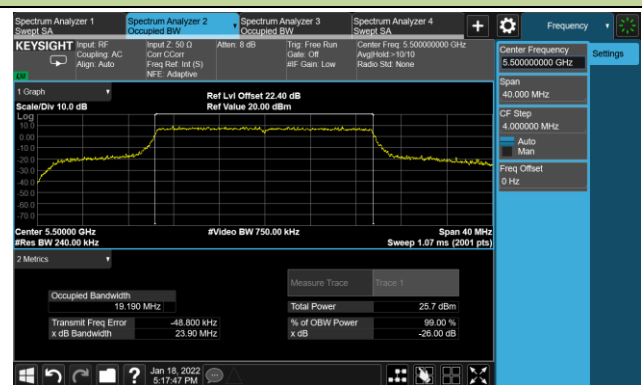

Channel 116 (5580MHz)

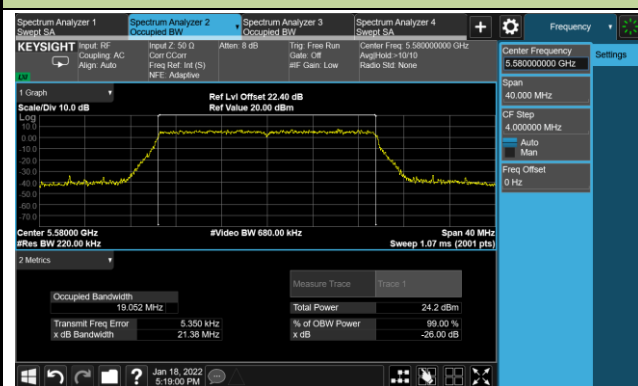

Channel 140 (5700MHz)

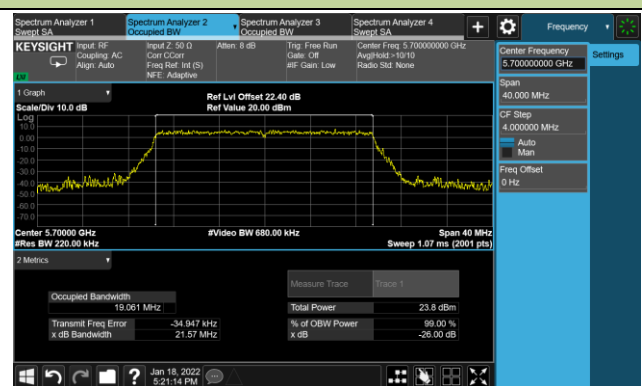

Channel 144(5720MHz)

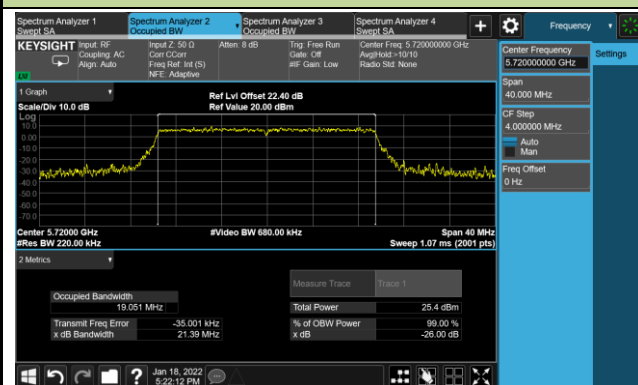

802.11ax-HE40 26dB Bandwidth

Channel 54 (5270MHz)

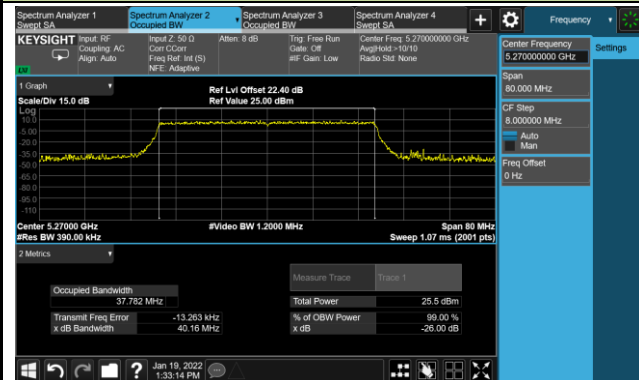

Channel 62 (5310MHz)

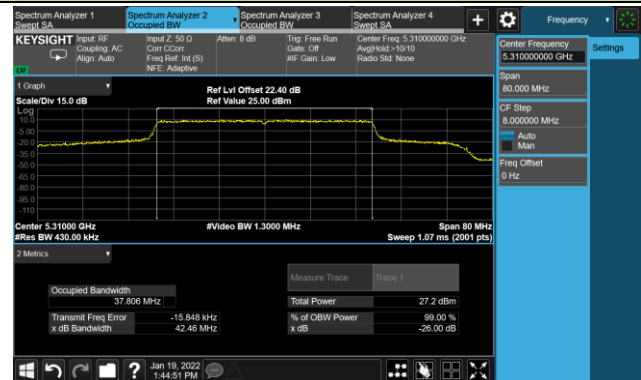

Channel 102 (5510MHz)

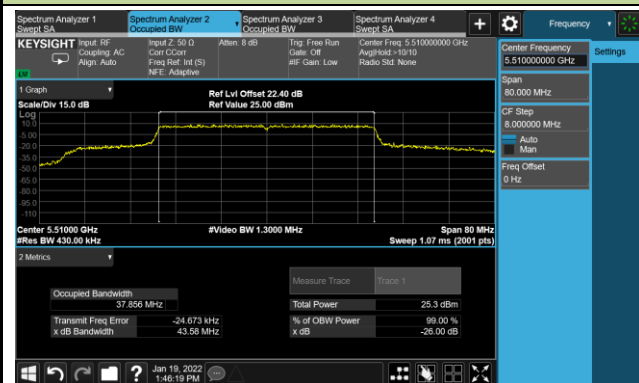

Channel 110 (5550MHz)

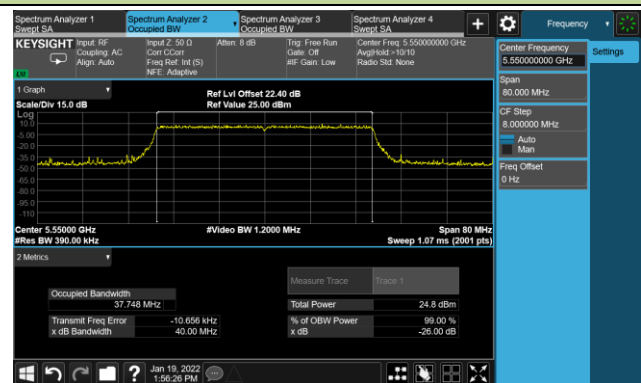

Channel 134 (5670MHz)

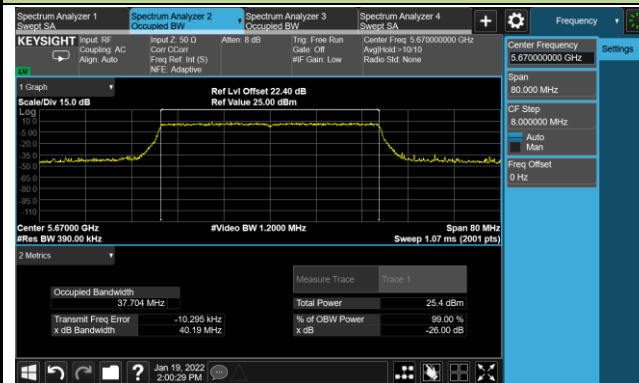

Channel 142(5710MHz)

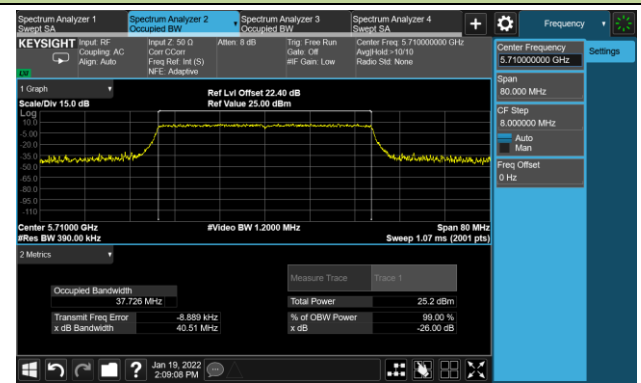

802.11ax-HE80 26dB Bandwidth

Channel 58 (5290MHz)

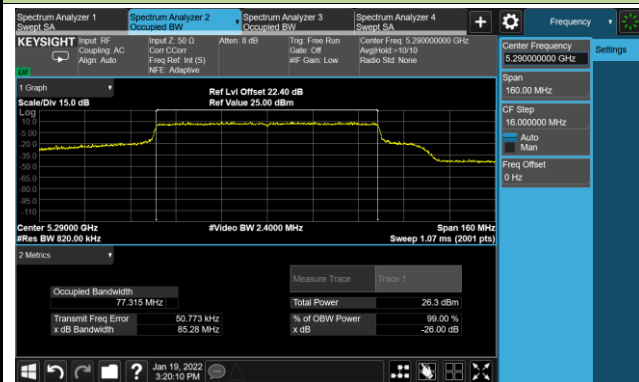

Channel 106 (5530MHz)

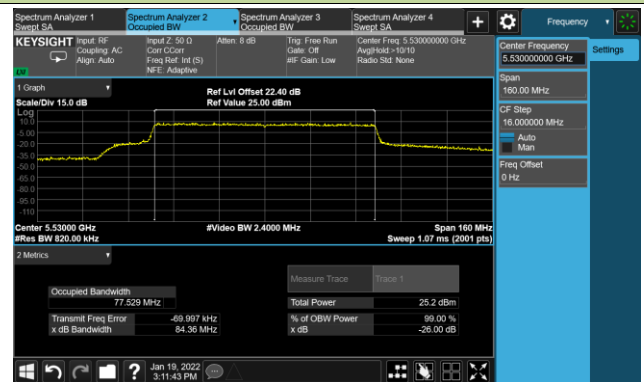

Channel 138 (5690MHz)

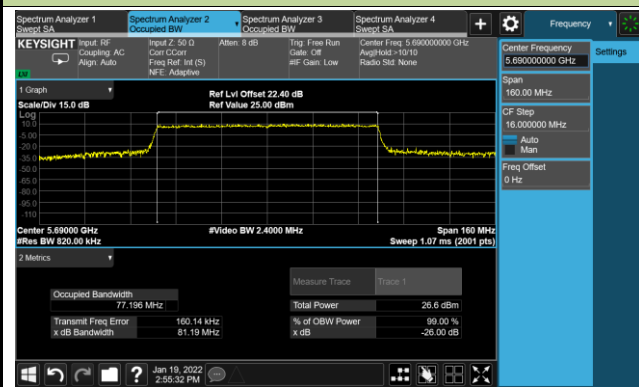

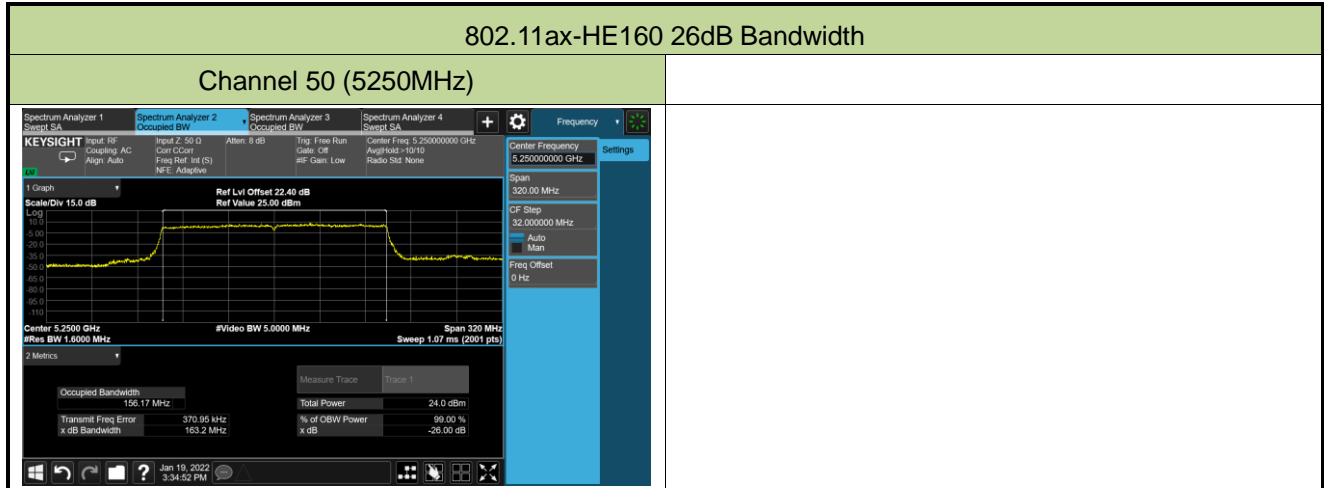

A.3 Output Power Test Result

Test Site	WZ-TR3	Test Engineer	Luis Yang
Test Date	2022/01/19 ~ 2022/01/27		

Test Mode	Data Rate MCS	Channel No.	Freq. (MHz)	Average Power (dBm)				Total Average Power (dBm)	Average Power Limit (dBm)
				Ant 0	Ant 1	Ant 2	Ant 3		
11a	6Mbps	52	5260	15.49	15.72	16.49	16.45	22.08	≤ 23.98
11a	6Mbps	60	5300	15.36	15.78	16.29	16.30	21.97	≤ 23.98
11a	6Mbps	64	5320	15.06	15.63	15.85	15.92	21.65	≤ 23.98
11a	6Mbps	100	5500	15.45	15.75	15.62	15.70	21.65	≤ 23.98
11a	6Mbps	116	5580	14.90	16.35	15.60	16.23	21.83	≤ 23.98
11a	6Mbps	140	5700	16.50	15.00	16.06	14.73	21.65	≤ 23.98
11a	6Mbps	144	5720	16.65	14.90	16.15	14.43	21.65	≤ 22.94
11ac-VHT20	MCS0	52	5260	15.98	16.52	17.01	17.15	22.71	≤ 23.98
11ac-VHT20	MCS0	60	5300	15.90	15.31	16.60	16.67	22.18	≤ 23.98
11ac-VHT20	MCS0	64	5320	15.83	16.48	16.52	16.72	22.42	≤ 23.98
11ac-VHT20	MCS0	100	5500	15.85	16.35	16.12	16.28	22.17	≤ 23.98
11ac-VHT20	MCS0	116	5580	15.05	16.05	15.75	16.23	21.81	≤ 23.98
11ac-VHT20	MCS0	140	5700	17.22	15.55	16.72	15.18	22.27	≤ 23.98
11ac-VHT20	MCS0	144	5720	16.92	15.26	16.43	14.80	21.96	≤ 22.96
11ac-VHT40	MCS0	54	5270	17.60	17.58	18.10	18.03	23.85	≤ 23.98
11ac-VHT40	MCS0	62	5310	17.75	17.45	17.73	17.83	23.71	≤ 23.98
11ac-VHT40	MCS0	102	5510	16.80	17.02	17.23	17.18	23.08	≤ 23.98
11ac-VHT40	MCS0	110	5550	17.18	17.49	17.38	17.45	23.40	≤ 23.98
11ac-VHT40	MCS0	134	5670	18.03	17.08	17.98	17.02	23.57	≤ 23.98
11ac-VHT40	MCS0	142	5710	18.47	16.90	17.92	16.68	23.58	≤ 23.98
11ac-VHT80	MCS0	58	5290	16.80	17.20	17.83	17.20	23.29	≤ 23.98
11ac-VHT80	MCS0	106	5530	14.79	15.30	15.39	15.26	21.21	≤ 23.98
11ac-VHT80	MCS0	138	5690	17.71	16.82	17.38	16.63	23.18	≤ 23.98
11ac-VHT160	MCS0	50	5250	12.90	13.29	13.96	13.70	19.50	≤ 23.98

Test Mode	Data Rate MCS	Channel No.	Freq. (MHz)	Average Power (dBm)				Total Average Power (dBm)	Average Power Limit (dBm)
				Ant 0	Ant 1	Ant 2	Ant 3		
11ax-HE20	MCS0	52	5260	16.46	16.97	17.33	17.23	23.03	≤ 23.98
11ax-HE20	MCS0	60	5300	16.08	16.86	16.95	17.13	22.79	≤ 23.98
11ax-HE20	MCS0	64	5320	15.95	16.42	16.72	16.91	22.54	≤ 23.98
11ax-HE20	MCS0	100	5500	15.95	16.48	16.28	16.33	22.28	≤ 23.98
11ax-HE20	MCS0	116	5580	15.99	17.08	16.52	16.68	22.61	≤ 23.98
11ax-HE20	MCS0	140	5700	16.11	14.56	15.78	14.28	21.27	≤ 23.98
11ax-HE20	MCS0	144	5720	17.25	15.71	17.02	15.32	22.42	≤ 22.96
11ax-HE40	MCS0	54	5270	17.46	17.42	18.06	17.63	23.67	≤ 23.98
11ax-HE40	MCS0	62	5310	17.77	17.58	18.01	17.89	23.84	≤ 23.98
11ax-HE40	MCS0	102	5510	17.49	17.43	17.83	17.52	23.59	≤ 23.98
11ax-HE40	MCS0	110	5550	17.37	17.89	17.62	17.83	23.70	≤ 23.98
11ax-HE40	MCS0	134	5670	18.38	17.01	17.93	17.00	23.64	≤ 23.98
11ax-HE40	MCS0	142	5710	18.49	17.16	18.45	17.01	23.85	≤ 23.98
11ax-HE80	MCS0	58	5290	16.99	17.20	17.82	17.15	23.32	≤ 23.98
11ax-HE80	MCS0	106	5530	16.09	16.63	16.52	16.20	22.39	≤ 23.98
11ax-HE80	MCS0	138	5690	17.86	17.02	17.59	16.90	23.38	≤ 23.98
11ax-HE160	MCS0	50	5250	14.63	15.18	15.80	15.50	21.32	≤ 23.98

Note 1: Total Average Power (dBm) = $10 \cdot \log \{ 10^{(\text{Ant 0 Average Power} / 10)} + 10^{(\text{Ant 1 Average Power} / 10)} + 10^{(\text{Ant 2 Average Power} / 10)} + 10^{(\text{Ant 3 Average Power} / 10)} \}$.

Note 2: For 5720MHz, Average Power Limit = $11 + 10 \cdot \log(5 + 26 \text{dBc} / 2)$.

A.4 Power Spectral Density Test Result

Test Site	WZ-TR3	Test Engineer	Luis Yang
Test Date	2022/01/17 ~ 2022/01/27		
Test Item	Power Spectral Density (UNII-Band UNII-2A & UNII-2C)		

Test Mode	Data Rate/MCS	Channel No.	Freq. (MHz)	AVPSD (dBm/ MHz)				Duty Cycle (%)	Total PSD (dBm/ MHz)	PSD Limit (dBm/ MHz)
				Ant 0	Ant 1	Ant 2	Ant 3			
11a	6Mbps	52	5260	3.56	3.69	4.42	4.19	95.07	10.22	≤10.55
11a	6Mbps	60	5300	3.52	3.96	4.46	4.48	95.07	10.36	≤10.55
11a	6Mbps	64	5320	3.25	3.72	3.90	4.47	95.07	10.10	≤10.55
11a	6Mbps	100	5500	3.76	3.90	3.70	3.83	95.07	10.04	≤10.24
11a	6Mbps	116	5580	2.92	4.43	3.48	4.31	95.07	10.07	≤10.24
11a	6Mbps	140	5700	4.86	2.97	4.15	2.67	95.07	9.99	≤10.24
11a	6Mbps	144	5720	4.67	3.20	4.31	2.90	95.07	10.07	≤10.24
11ac-VHT20	MCS0	52	5260	4.06	4.12	4.73	4.56	98.47	10.40	≤10.55
11ac-VHT20	MCS0	60	5300	3.50	4.31	4.57	4.55	98.47	10.28	≤10.55
11ac-VHT20	MCS0	64	5320	3.73	4.34	4.43	4.67	98.47	10.32	≤10.55
11ac-VHT20	MCS0	100	5500	3.82	4.32	4.07	4.09	98.47	10.10	≤10.24
11ac-VHT20	MCS0	116	5580	2.98	4.51	3.83	4.09	98.47	9.90	≤10.24
11ac-VHT20	MCS0	140	5700	5.01	3.20	4.43	3.19	98.47	10.05	≤10.24
11ac-VHT20	MCS0	144	5720	5.10	3.45	4.28	2.91	98.47	10.03	≤10.24
11ac-VHT40	MCS0	54	5270	2.27	2.25	3.03	2.99	97.18	8.79	≤10.55
11ac-VHT40	MCS0	62	5310	2.60	2.21	2.55	2.56	97.18	8.63	≤10.55
11ac-VHT40	MCS0	102	5510	1.76	1.67	2.18	1.98	97.18	8.05	≤10.24
11ac-VHT40	MCS0	110	5550	2.51	2.90	2.58	2.57	97.18	8.79	≤10.24
11ac-VHT40	MCS0	134	5670	3.02	1.81	2.97	2.21	97.18	8.68	≤10.24
11ac-VHT40	MCS0	142	5710	3.52	2.33	2.93	1.82	97.18	8.84	≤10.24
11ac-VHT80	MCS0	58	5290	-0.81	-0.57	0.21	-0.57	94.25	5.86	≤10.55
11ac-VHT80	MCS0	106	5530	-3.16	-2.78	-2.43	-2.63	94.25	3.54	≤10.24
11ac-VHT80	MCS0	138	5690	0.08	-0.88	-0.28	-0.80	94.25	5.83	≤10.24
11ac-VHT160	MCS0	50	5250	-7.57	-6.85	-6.26	-6.69	89.82	-0.33	≤10.54

Test Mode	Data Rate/ MCS	Channel No.	Freq. (MHz)	AVPSD (dBm/ MHz)				Duty Cycle (%)	Total PSD (dBm/ MHz)	PSD Limit (dBm/M Hz)
				Ant 0	Ant 1	Ant 2	Ant 3			
11ax-HE20	MCS0	52	5260	3.68	4.19	4.72	4.81	98.28	10.39	≤10.55
11ax-HE20	MCS0	60	5300	3.72	4.32	4.37	4.69	98.28	10.31	≤10.55
11ax-HE20	MCS0	64	5320	3.71	4.33	4.38	4.59	98.28	10.28	≤10.55
11ax-HE20	MCS0	100	5500	3.92	4.14	3.97	3.96	98.28	10.02	≤10.24
11ax-HE20	MCS0	116	5580	3.46	4.67	3.77	4.40	98.28	10.12	≤10.24
11ax-HE20	MCS0	140	5700	3.45	1.83	3.31	1.88	98.28	8.70	≤10.24
11ax-HE20	MCS0	144	5720	5.16	3.32	4.27	2.69	98.28	9.98	≤10.24
11ax-HE40	MCS0	54	5270	2.26	1.97	2.64	2.80	96.39	8.61	≤10.55
11ax-HE40	MCS0	62	5310	2.72	2.38	2.77	2.87	96.39	8.87	≤10.55
11ax-HE40	MCS0	102	5510	2.22	2.31	2.76	2.51	96.39	8.64	≤10.24
11ax-HE40	MCS0	110	5550	2.16	2.62	2.30	2.39	96.39	8.55	≤10.24
11ax-HE40	MCS0	134	5670	2.60	1.40	2.51	1.76	96.39	8.28	≤10.24
11ax-HE40	MCS0	142	5710	3.59	2.05	2.98	1.98	96.39	8.88	≤10.24
11ax-HE80	MCS0	58	5290	-1.11	-0.78	-0.43	-0.71	93.65	5.55	≤10.55
11ax-HE80	MCS0	106	5530	-1.81	-1.53	-1.46	-1.74	93.65	4.68	≤10.24
11ax-HE80	MCS0	138	5690	0.16	-0.66	-0.18	-0.97	93.65	5.91	≤10.24
11ax-HE160	MCS0	50	5250	-5.61	-4.70	-3.88	-4.61	89.39	1.85	≤10.54

Note: When EUT duty cycle < 98%, the total PSD (dBm/MHz) = $10 \cdot \log \{10^{(\text{Ant 0 AVGPSD}/10)} + 10^{(\text{Ant 1 AVGPSD}/10)} + 10^{(\text{Ant 2 AVGPSD}/10)} + 10^{(\text{Ant 3 AVGPSD}/10)}\} + 10 \cdot \log (1/\text{Duty cycle})$.

When EUT duty cycle ≥ 98%, the total PSD (dBm/MHz) = $10 \cdot \log \{10^{(\text{Ant 0 AVGPSD}/10)} + 10^{(\text{Ant 1 AVGPSD}/10)} + 10^{(\text{Ant 2 AVGPSD}/10)} + 10^{(\text{Ant 3 AVGPSD}/10)}\}$.

802.11a Power Spectral Density- Ant 0

Channel 52 (5260MHz)



Channel 60 (5300MHz)

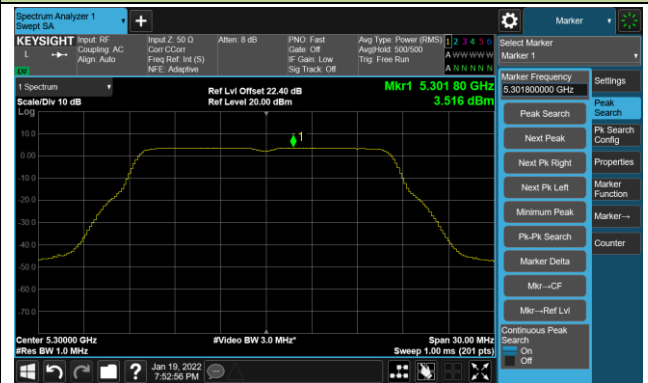

Channel 64 (5320MHz)

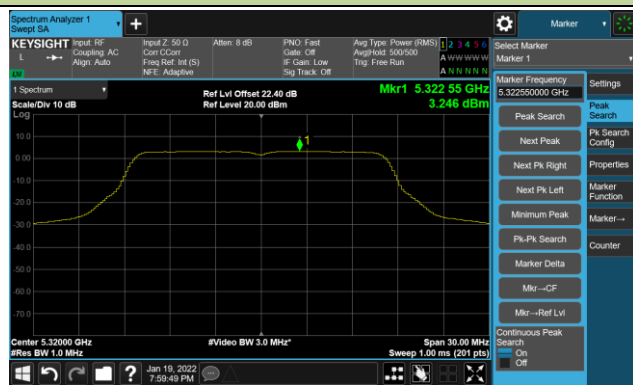

Channel 100 (5500MHz)

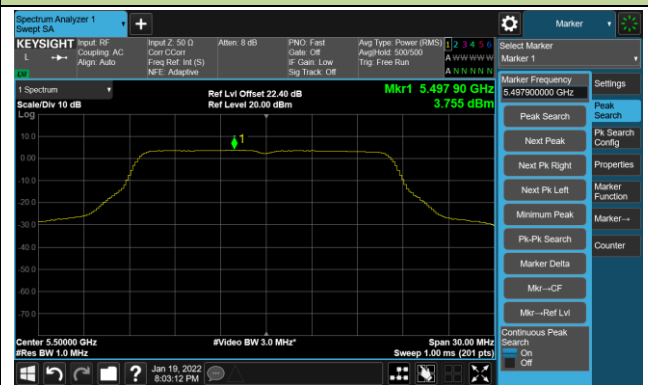

Channel 116 (5580MHz)

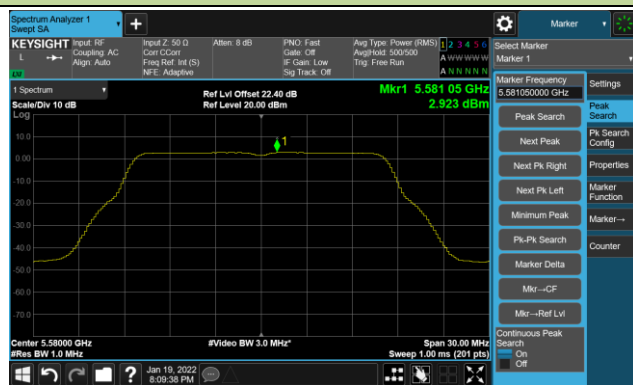

Channel 140 (5700MHz)

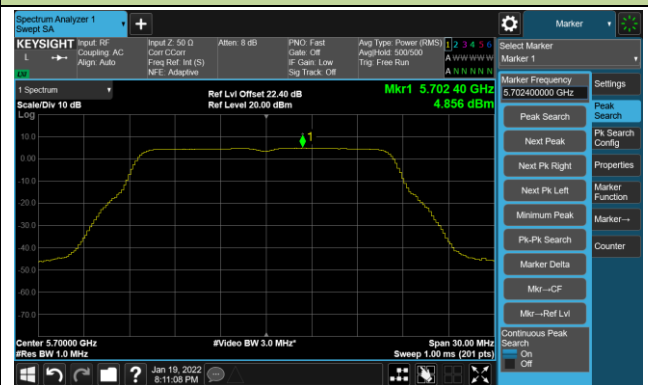

Channel 144(5720MHz)

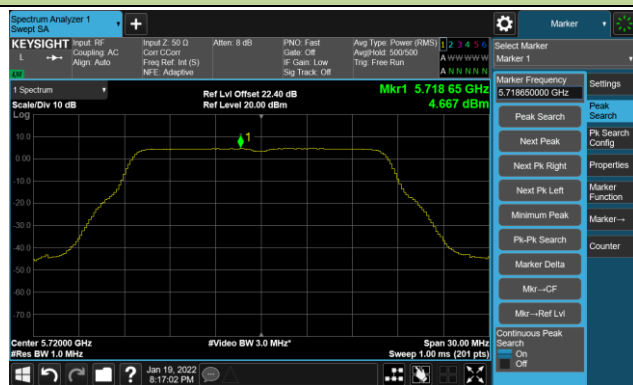

802.11ac-VHT20 Power Spectral Density- Ant 0

Channel 52 (5260MHz)

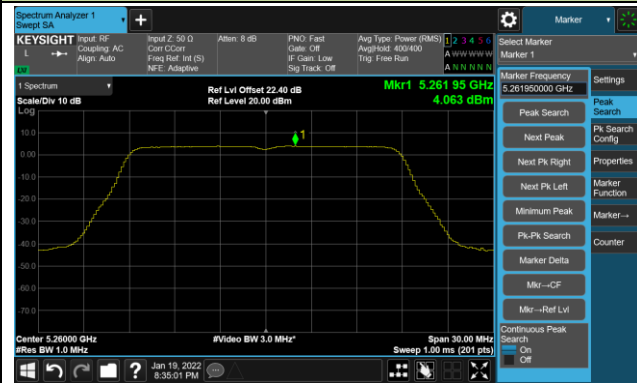

Channel 60 (5300MHz)

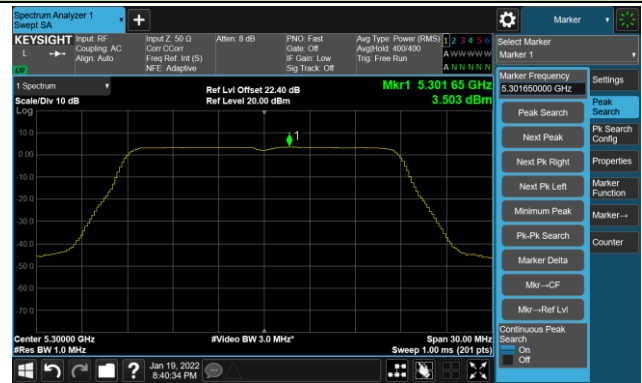

Channel 64 (5320MHz)

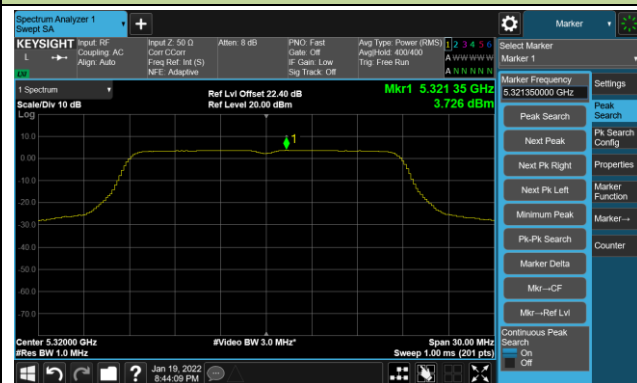

Channel 100 (5500MHz)

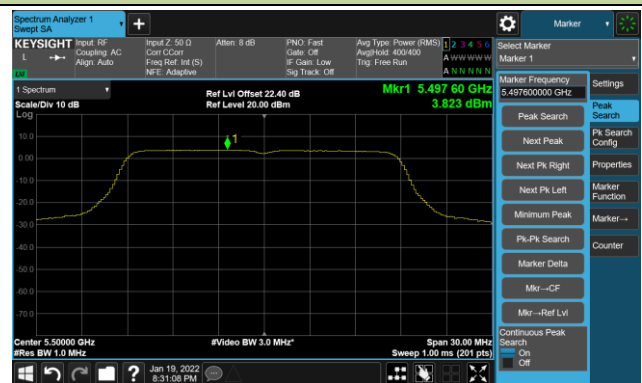

Channel 116 (5580MHz)

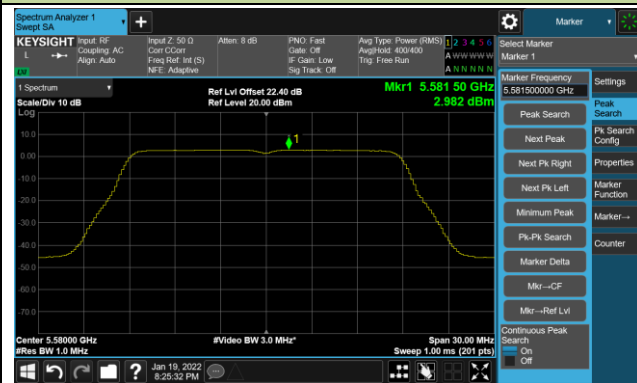

Channel 140 (5700MHz)

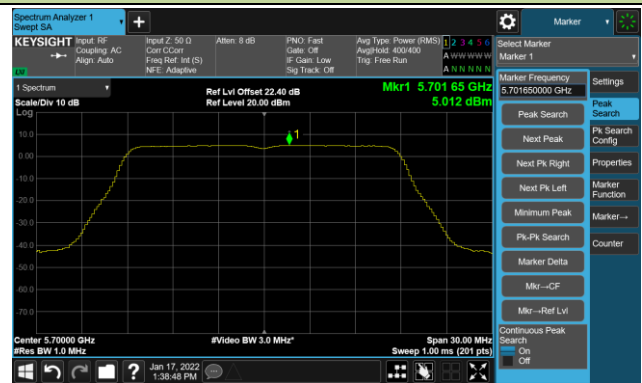

Channel 144(5720MHz)



802.11ac-VHT40 - Power Spectral Density- Ant 0

Channel 54 (5270MHz)

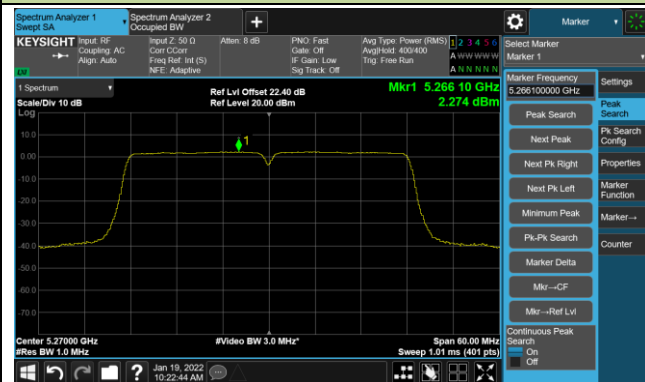

Channel 62 (5310MHz)

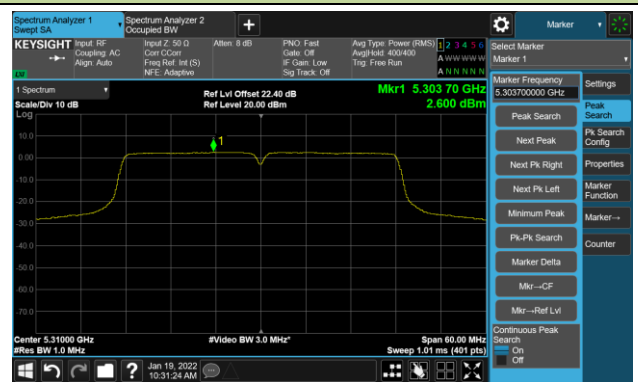

Channel 102 (5510MHz)

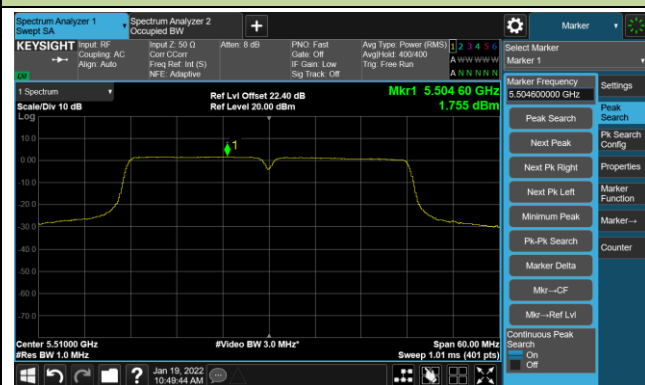

Channel 110 (5550MHz)

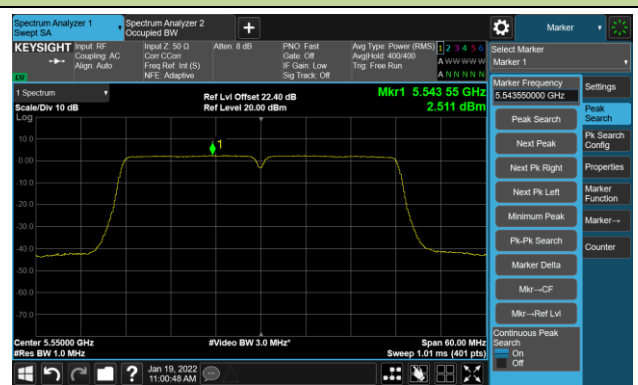

Channel 134 (5670MHz)



Channel 142 (5710MHz)

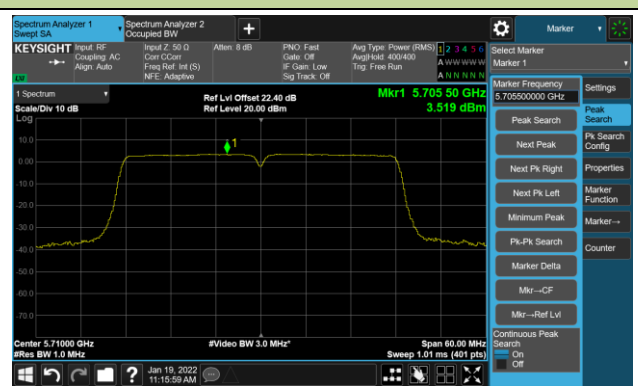

802.11ac-VHT80 Power Spectral Density- Ant 0

Channel 58 (5290MHz)

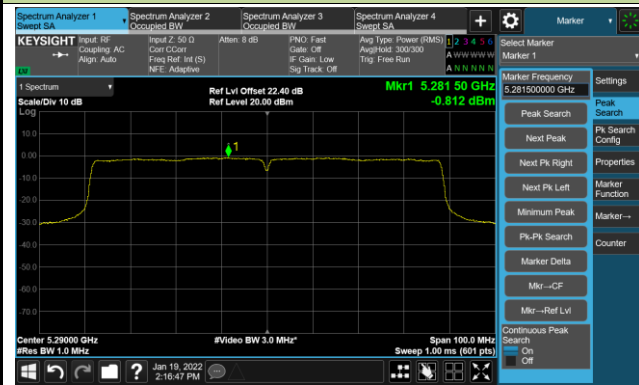

Channel 106 (5530MHz)



Channel 138 (5690MHz)

