

TEST REPORT

Test report no.: 1-3977/22-02-15

BNetzA-CAB-02/21-102

Testing laboratory

CTC advanced GmbH

Untertuerkheimer Strasse 6 – 10

66117 Saarbruecken / Germany

Phone: + 49 681 5 98 - 0

Fax: + 49 681 5 98 - 9075

Internet: <https://www.ctcadvanced.com>

e-mail: mail@ctcadvanced.com

Accredited Testing Laboratory:

The testing laboratory (area of testing) is accredited according to DIN EN ISO/IEC 17025 (2018-03) by the Deutsche Akkreditierungsstelle GmbH (DAkkS)

The accreditation is valid for the scope of testing procedures as stated in the accreditation certificate starting with the registration number: D-PL-12076-01.

Applicant

SAGEMCOM BROADBAND SAS

250, route de l' Empereur

92848 Rueil-Malmaison Cedex / FRANCE

Phone: -/-

Contact: Ludovic Bomba

e-mail: ludovic.bomba-ext@sagemcom.com

Manufacturer

SAGEMCOM BROADBAND SAS

250, route de l'Empereur

92848 Rueil-Malmaison Cedex / FRANCE

Test standard/s

FCC - Title 47 CFR Part 24 FCC - Title 47 of the Code of Federal Regulations; Chapter I; Part 24 - Personal communications services

For further applied test standards please refer to section 3 of this test report.

Test Item

Kind of test item:	Gateway
Model name:	F5688W
FCC ID:	VW3FAST5688W
Frequency:	Band 25
Technology tested:	5G NR
Antenna:	4 integrated antennas
Power supply:	120 V AC by power supply unit
Temperature range:	0°C to +50°C

This test report is electronically signed and valid without handwritten signature. For verification of the electronic signatures, the public keys can be requested at the testing laboratory.

Test report authorized:

Michael Dorongovski
Lab Manager
Radio Communications

Test performed:

Andreas Luckenbill
Head of Department
Radio Communications

1 Table of contents

1	Table of contents	2
2	General information	3
2.1	Notes and disclaimer	3
2.2	Application details	3
2.3	Test laboratories sub-contracted	3
3	Test standard/s, references and accreditations	4
4	Reporting statements of conformity – decision rule	5
5	Test environment	6
6	Test item	6
6.1	General description	6
6.2	Additional information	6
7	Sequence of testing	7
7.1	Sequence of testing radiated spurious 9 kHz to 30 MHz	7
7.2	Sequence of testing radiated spurious 30 MHz to 1 GHz	8
7.3	Sequence of testing radiated spurious 1 GHz to 18 GHz	9
7.4	Sequence of testing radiated spurious above 18 GHz	10
8	Description of the test setup	11
8.1	Shielded semi anechoic chamber	12
8.2	Shielded fully anechoic chamber	13
8.3	Radiated measurements > 18 GHz	14
8.4	Conducted measurements normal and extreme conditions	15
9	Measurement uncertainty	16
10	Additional information and comments	17
11	Summary of measurement results	18
11.1	Part 24: 5G NR band 25	18
12	RF measurements	19
12.1	Description of test setup	19
12.2	Results 5G NR band 25	19
12.2.1	RF output power	19
12.2.2	Frequency stability	25
12.2.3	Spurious emissions radiated	27
12.2.4	Spurious emissions conducted	40
12.2.5	Block edge compliance	43
12.2.6	Occupied bandwidth	44
13	Glossary	50
14	Document history	51
15	Accreditation Certificate – D-PL-12076-01-05	51

2 General information

2.1 Notes and disclaimer

The test results of this test report relate exclusively to the test item specified in this test report. CTC advanced GmbH does not assume responsibility for any conclusions and generalizations drawn from the test results with regard to other specimens or samples of the type of the equipment represented by the test item.

The test report may only be reproduced or published in full. Reproduction or publication of extracts from the report requires the prior written approval of CTC advanced GmbH.

The testing service provided by CTC advanced GmbH has been rendered under the current "General Terms and Conditions for CTC advanced GmbH".

CTC advanced GmbH will not be liable for any loss or damage resulting from false, inaccurate, inappropriate or incomplete product information provided by the customer.

Under no circumstances does the CTC advanced GmbH test report include any endorsement or warranty regarding the functionality, quality or performance of any other product or service provided.

Under no circumstances does the CTC advanced GmbH test report include or imply any product or service warranties from CTC advanced GmbH, including, without limitation, any implied warranties of merchantability, fitness for purpose, or non-infringement, all of which are expressly disclaimed by CTC advanced GmbH.

All rights and remedies regarding vendor's products and services for which CTC advanced GmbH has prepared this test report shall be provided by the party offering such products or services and not by CTC advanced GmbH. In no case this test report can be considered as a Letter of Approval.

This test report is electronically signed and valid without handwritten signature. For verification of the electronic signatures, the public keys can be requested at the testing laboratory.

2.2 Application details

Date of receipt of order:	2022-03-11
Date of receipt of test item:	2022-02-16
Start of test:*	2022-02-21
End of test:*	2022-07-19
Person(s) present during the test:	-/-

*Date of each measurement, if not shown in the plot, can be requested. Dates are stored in the measurement software.

2.3 Test laboratories sub-contracted

None

3 Test standard/s, references and accreditations

Test standard	Date	Description
FCC - Title 47 CFR Part 24		FCC - Title 47 of the Code of Federal Regulations; Chapter I; Part 24 - Personal communications services

Guidance	Version	Description
ANSI C63.4-2014	-/-	American National Standard for Methods of Measurement of Radio-Noise Emissions from Low-Voltage Electrical and Electronic Equipment in the Range of 9 kHz to 40 GHz
ANSI C63.26-2015	-/-	American National Standard for Compliance Testing of Transmitters Used in Licensed Radio Services
KDB 662911 D01	v02r01	Emissions Testing of Transmitters with Multiple Outputs in the Same Band
Power Meas License Systems: KDB 971168 D01	v03r01	Measurement Guidance for Certification of Licensed Digital Transmitters

Accreditation	Description
D-PL-12076-01-05	Telecommunication FCC requirements https://www.dakks.de/as/ast/d/D-PL-12076-01-05e.pdf



FCC designation number: DE0002

4 Reporting statements of conformity – decision rule

Only the measured values related to their corresponding limits will be used to decide whether the equipment under test meets the requirements of the test standards listed in chapter 3.

The measurement uncertainty is mentioned in this test report, see chapter 9, but is not taken into account - neither to the limits nor to the measurement results. Measurement results with a smaller margin to the corresponding limits than the measurement uncertainty have a potential risk of more than 5% that the decision might be wrong."

measured value, measurement uncertainty, verdict

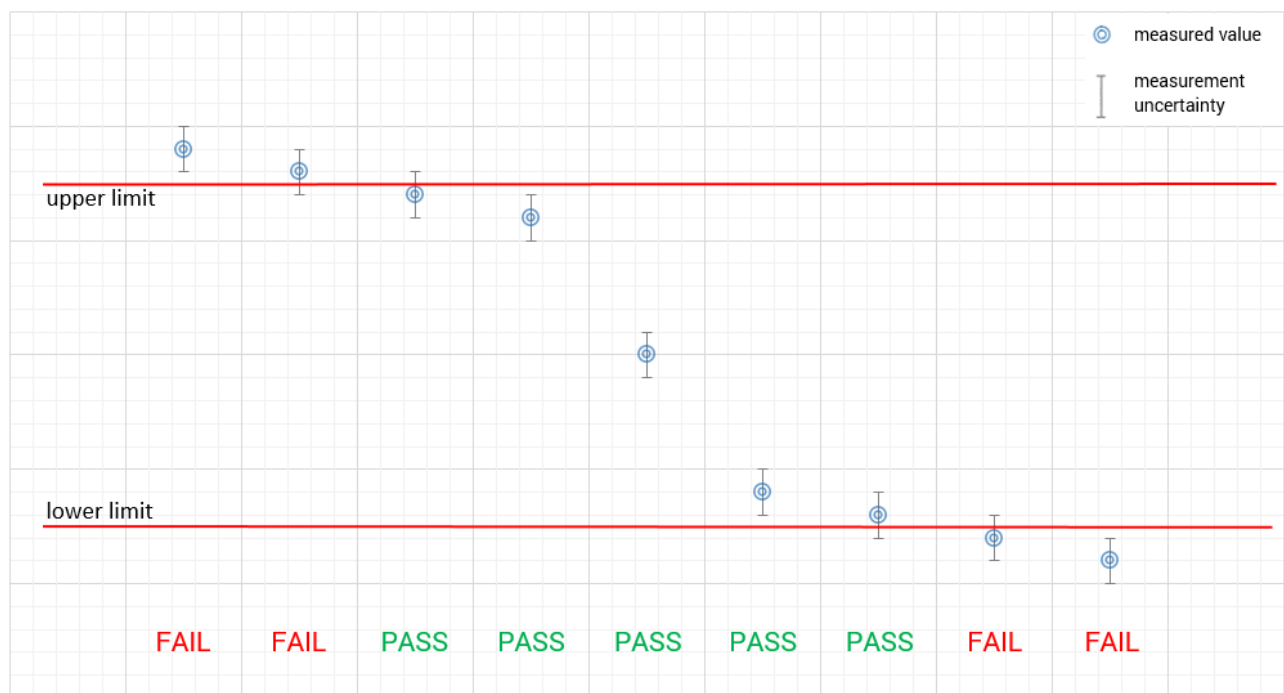

5 Test environment

Temperature	:	T_{nom} T_{max} T_{min}	+22 °C during room temperature tests +50 °C during high temperature tests -30 °C during low temperature tests
Relative humidity content	:		42 %
Barometric pressure	:		1021 hpa
Power supply	:	V_{nom} V_{max} V_{min}	120 V AC by power supply unit. 138 V AC by external power supply. 102 V AC by external power supply.

6 Test item

6.1 General description

Kind of test item	:	Gateway
Model name	:	F5688W
S/N serial number	:	Radiated units: DM2205259000020 (IMEI: 359509840011321) Conducted units: DM2205259000045 (IMEI: 359509840012014)
Hardware status	:	V1.0
Software status	:	SG520TMDAR01A04M4G_BETA_20220524A_01.001.01.001
Firmware status	:	SG520TMDAR01A04M4G_BETA_20220524A_01.001.01.001
Frequency band	:	Band 25
Type of radio transmission	:	Modulated carrier
Use of frequency spectrum	:	
Type of modulation	:	BPSK, QPSK, 16-QAM, 64-QAM, 256-QAM
Antenna	:	4 integrated antennas
Power supply	:	120 V AC by power supply unit
Temperature range	:	0°C to +50°C

6.2 Additional information

The content of the following annexes is defined in the QA. It may be that not all of the listed annexes are necessary for this report, thus some values in between may be missing.

Test setup and EUT photos are included in test report:

- 1-3977/22-02-01_AnnexA
- 1-3977/22-02-01_AnnexB
- 1-3977/22-02-01_AnnexC

7 Sequence of testing

7.1 Sequence of testing radiated spurious 9 kHz to 30 MHz

Setup

- The equipment is set up to simulate normal operation mode as described in the user manual or defined by the manufacturer.
- If the EUT is a tabletop system, it is placed on a table with 0.8 m height.
- If the EUT is a floor standing device, it is placed directly on the turn table.
- Auxiliary equipment and cables are positioned to simulate normal operation conditions as described in ANSI C 63.4.
- The AC power port of the EUT (if available) is connected to a power outlet below the turntable.
- Measurement distance is 3 m (see ANSI C 63.4) – see test details.
- EUT is set into operation.

Premeasurement*

- The turntable rotates from 0° to 315° using 45° steps.
- The antenna height is 1 m.
- At each turntable position the analyzer sweeps with positive-peak detector to find the maximum of all emissions.

Final measurement

- Identified emissions during the pre-measurement are maximized by the software by rotating the turntable from 0° to 360°.
- Loop antenna is rotated about its vertical axis for maximum response at each azimuth about the EUT. (For certain applications, the loop antenna plane may also need to be positioned horizontally at the specified distance from the EUT)
- The final measurement is done in the position (turntable and elevation) causing the highest emissions with quasi-peak (as described in ANSI C 63.4).
- Final levels, frequency, measuring time, bandwidth, turntable position, correction factor, margin to the limit and limit will be recorded. A plot with the graph of the premeasurement and the limit is stored.

*Note: The sequence will be repeated three times with different EUT orientations.

7.2 Sequence of testing radiated spurious 30 MHz to 1 GHz

Setup

- The equipment is set up to simulate normal operation mode as described in the user manual or defined by the manufacturer.
- If the EUT is a tabletop system, a table with 0.8 m height is used, which is placed on the ground plane.
- If the EUT is a floor standing device, it is placed on the ground plane with insulation between both.
- Auxiliary equipment and cables are positioned to simulate normal operation conditions as described in ANSI C 63.4.
- The AC power port of the EUT (if available) is connected to a power outlet below the turntable.
- Measurement distance is 10 m or 3 m (see ANSI C 63.4) – see test details.
- EUT is set into operation.

Premeasurement

- The turntable rotates from 0° to 315° using 45° steps.
- The antenna is polarized vertical and horizontal.
- The antenna height changes from 1 m to 3 m.
- At each turntable position, antenna polarization and height the analyzer sweeps three times in peak to find the maximum of all emissions.

Final measurement

- The final measurement is performed for at least six highest peaks according to the requirements of the ANSI C63.4.
- Based on antenna and turntable positions at which the peak values are measured the software maximize the peaks by changing turntable position $\pm 45^\circ$ and antenna height between 1 and 4 m.
- The final measurement is done with quasi-peak detector (as described in ANSI C 63.4).
- Final levels, frequency, measuring time, bandwidth, antenna height, antenna polarization, turntable angle, correction factor, margin to the limit and limit are recorded. A plot with the graph of the premeasurement with marked maximum final results and the limit is stored.

7.3 Sequence of testing radiated spurious 1 GHz to 18 GHz

Setup

- The equipment is set up to simulate normal operation mode as described in the user manual or defined by the manufacturer.
- If the EUT is a tabletop system, a 2-axis positioner with 1.5 m height is used.
- If the EUT is a floor standing device, it is placed directly on the turn table.
- Auxiliary equipment and cables are positioned to simulate normal operation conditions as described in ANSI C 63.4.
- The AC power port of the EUT (if available) is connected to a power outlet below the turntable.
- Measurement distance is 3 m (see ANSI C 63.4) – see test details.
- EUT is set into operation.

Premeasurement

- The turntable rotates from 0° to 315° using 45° steps.
- The antenna is polarized vertical and horizontal.
- The antenna height is 1.5 m.
- At each turntable position and antenna polarization the analyzer sweeps with positive peak detector to find the maximum of all emissions.

Final measurement

- The final measurement is performed for at least six highest peaks according to the requirements of the ANSI C63.4.
- Based on antenna and turntable positions at which the peak values are measured the software maximizes the peaks by rotating the turntable from 0° to 360°. This measurement is repeated for different EUT-table positions (0° to 150° in 30°-steps) and for both antenna polarizations.
- The final measurement is done in the position (turntable, EUT-table and antenna polarization) causing the highest emissions with Peak and RMS detector (as described in ANSI C 63.4).
- Final levels, frequency, measuring time, bandwidth, turntable position, EUT-table position, antenna polarization, correction factor, margin to the limit and limit are recorded. A plot with the graph of the premeasurement with marked maximum final results and the limit is stored.

7.4 Sequence of testing radiated spurious above 18 GHz

Setup

- The equipment is set up to simulate normal operation mode as described in the user manual or defined by the manufacturer.
- Auxiliary equipment and cables are positioned to simulate normal operation conditions as described in ANSI C 63.4.
- The AC power port of the EUT (if available) is connected to a power outlet.
- The measurement distance is as appropriate (e.g. 0.5 m).
- The EUT is set into operation.

Premeasurement

- The test antenna is handheld and moved carefully over the EUT to cover the EUT's whole sphere and different polarizations of the antenna.

Final measurement

- The final measurement is performed at the position and antenna orientation causing the highest emissions with Peak and RMS detector (as described in ANSI C 63.4).
- Final levels, frequency, measuring time, bandwidth, correction factor, margin to the limit and limit are recorded. A plot with the graph of the premeasurement and the limit is stored.

8 Description of the test setup

Typically, the calibrations of the test apparatus are commissioned to and performed by an accredited calibration laboratory. The calibration intervals are determined in accordance with the DIN EN ISO/IEC 17025. In addition to the external calibrations, the laboratory executes comparison measurements with other calibrated test systems or effective verifications. Weekly chamber inspections and range calibrations are performed. Where possible, RF generating and signaling equipment as well as measuring receivers and analyzers are connected to an external high-precision 10 MHz reference (GPS-based or rubidium frequency standard).

In order to simplify the identification of the equipment used at some special tests, some items of test equipment and ancillaries can be provided with an identifier or number in the equipment list below (Lab/Item).

Each block diagram listed can contain several test setup configurations. All devices belonging to a test setup are identified with the same letter syntax. For example: Column Setup and all devices with an A.

Agenda: Kind of Calibration

k	calibration / calibrated	EK	limited calibration
ne	not required (k, ev, izw, zw not required)	zw	cyclical maintenance (external cyclical maintenance)
ev	periodic self verification	izw	internal cyclical maintenance
Ve	long-term stability recognized	g	blocked for accredited testing
vlk!	Attention: extended calibration interval		
NK!	Attention: not calibrated	*)	next calibration ordered / currently in progress

8.1 Shielded semi anechoic chamber

The radiated measurements are performed in vertical and horizontal plane in the frequency range from 30 MHz to 1 GHz in semi-anechoic chambers. The EUT is positioned on a non-conductive support with a height of 0.80 m above a conductive ground plane that covers the whole chamber. The receiving antennas are conform to specifications ANSI C63. These antennas can be moved over the height range between 1.0 m and 4.0 m in order to search for maximum field strength emitted from EUT. The measurement distances between EUT and receiving antennas are indicated in the test setups for the various frequency ranges. For each measurement, the EUT is rotated in all three axes until the maximum field strength is received. The wanted and unwanted emissions are received by spectrum analyzers where the detector modes and resolution bandwidths over various frequency ranges are set according to requirement ANSI C63.

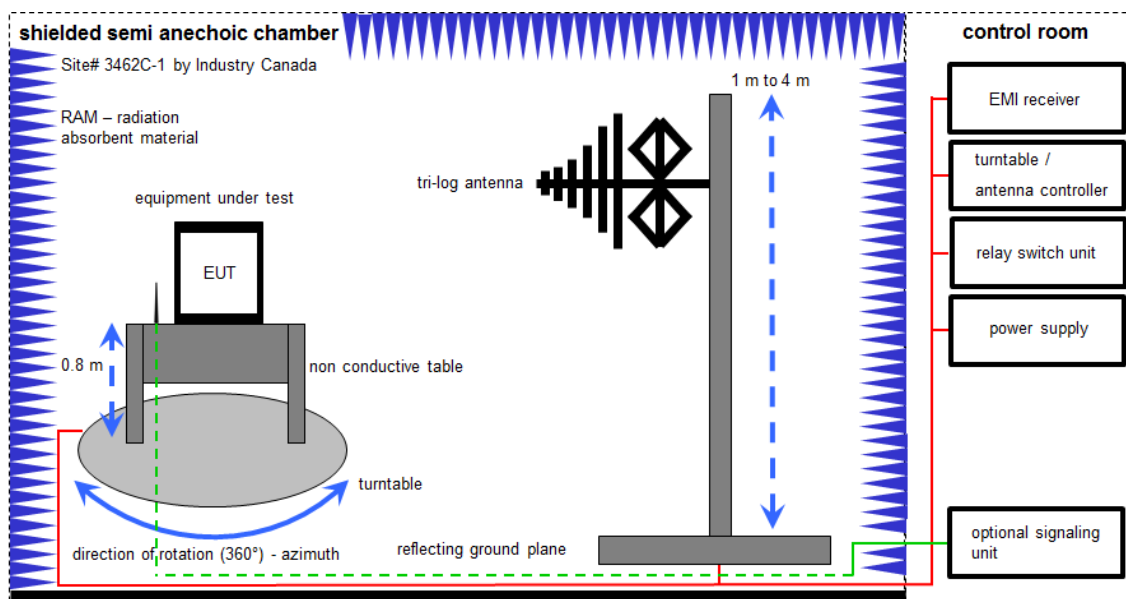

Measurement distance: tri-log antenna 10 meter; EMC32 software version: 10.59.00

$$FS = UR + CL + AF$$

(FS-field strength; UR-voltage at the receiver; CL-loss of the cable; AF-antenna factor)

Example calculation:

$$FS [dB\mu V/m] = 12.35 [dB\mu V/m] + 1.90 [dB] + 16.80 [dB/m] = 31.05 [dB\mu V/m] (35.69 \mu V/m)$$

Equipment table:

No.	Lab / Item	Equipment	Type	Manufacturer	Serial No.	INV. No.	Kind of Calibration	Last Calibration	Next Calibration
1	A	Switch-Unit	3488A	HP	2719A14505	300000368	ev	-/-	-/-
2	A	Meßkabine 1	HF-Absorberhalle	MWB AG 300023	Batch no. 699714	300000551	ne	-/-	-/-
3	A	Antenna Tower	Model 2175	ETS-Lindgren	64762	300003745	izw	-/-	-/-
4	A	Positioning Controller	Model 2090	ETS-Lindgren	64672	300003746	izw	-/-	-/-
5	A	Turntable Interface-Box	Model 105637	ETS-Lindgren	44583	300003747	izw	-/-	-/-
6	A	TRILOG Broadband Test-Antenna 30 MHz - 3 GHz	VULB9163	Schwarzbeck Mess-Elektronik	295	300003787	vIKI!	21.04.2021	20.04.2023
7	A	EMI Test Receiver	ESR3	Rohde & Schwarz	102587	300005771	k	10.12.2020	09.06.2022

8.2 Shielded fully anechoic chamber

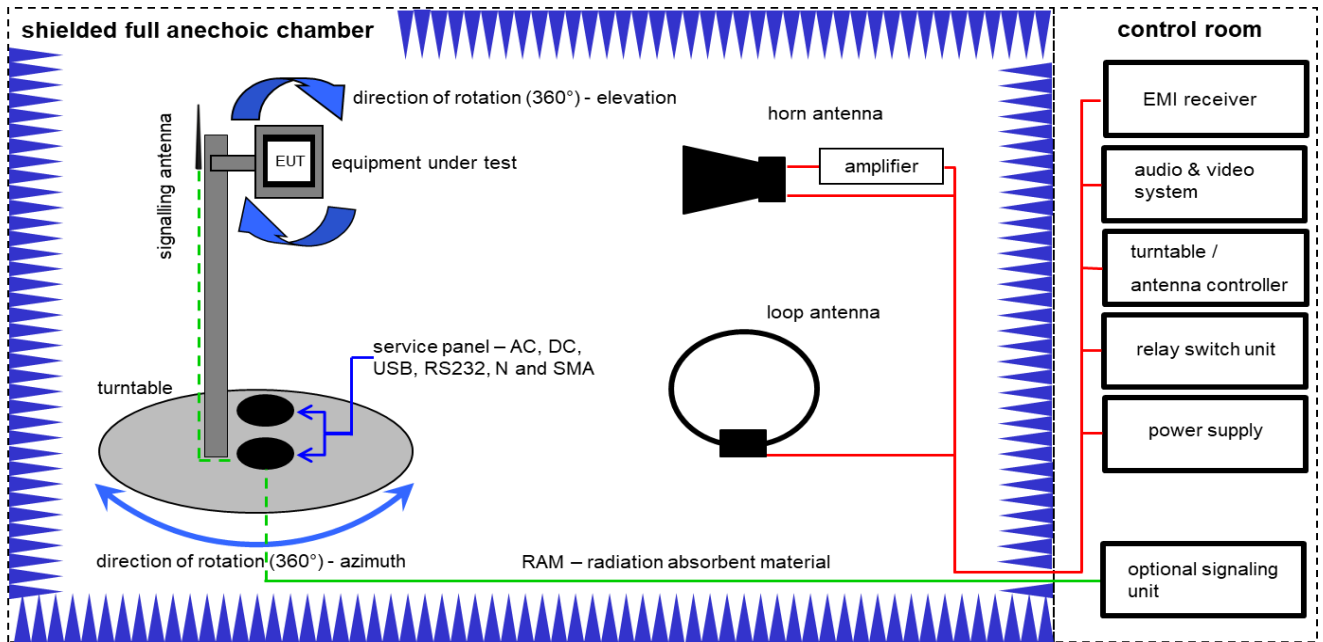

Measurement distance: horn antenna 3 meter; loop antenna 3 meter

$$OP = AV + D - G + CA$$

(OP-radiated output power; AV-analyzer value; D-free field attenuation of measurement distance; G-antenna gain+amplifier gain; CA-loss signal path)

Example calculation:

$$OP \text{ [dBm]} = -39.0 \text{ [dBm]} + 57.0 \text{ [dB]} - 12.0 \text{ [dBi]} + (-36.0) \text{ [dB]} = -30 \text{ [dBm]} (1 \mu\text{W})$$

Equipment table:

No.	Setup	Equipment	Type	Manufacturer	Serial No.	INV. No.	Kind of Calibration	Last Calibration	Next Calibration
1	B	Active Loop Antenna 9 kHz to 30 MHz	6502	EMCO	2210	300001015	vIKI!	01.07.2021	31.07.2023
2	A, B	Anechoic chamber	FAC 3/5m	MWB / TDK	87400/02	300000996	ev	-/-	-/-
3	A	Double-Ridged Waveguide Horn Antenna 1-18.0GHz	3115	EMCO	8812-3089	300000307	vIKI!	11.02.2022	29.02.2024
4	A, B	EMI Test Receiver 20Hz- 26,5GHz	ESU26	R&S	100037	300003555	k	09.12.2021	31.12.2022
5	A, B	Highpass Filter	WHK1.1/15G-10SS	Wainwright	3	300003255	ev	-/-	-/-
6	A, B	Highpass Filter	WHKX7.0/18G-8SS	Wainwright	19	300003790	ne	-/-	-/-
7	A	Band Reject filter	WRCG1850/1910-1835/1925-40/8SS	Wainwright	7	300003350	ev	-/-	-/-
8	A	Broadband Amplifier 0.5-18 GHz	CBLU5184540	CERNEX	22049	300004481	ev	-/-	-/-
9	A, B	4U RF Switch Platform	L4491A	Agilent Technologies	MY50000037	300004509	ne	-/-	-/-
10	A, B	NEXIO EMV-Software	BAT EMC V3.21.0.27	EMCO		300004682	ne	-/-	-/-
11	A	RF-Amplifier	AMF-6F06001800-30-10P-R	NARDA-MITEQ Inc	2011572	300005241	ev	-/-	-/-

8.3 Radiated measurements > 18 GHz

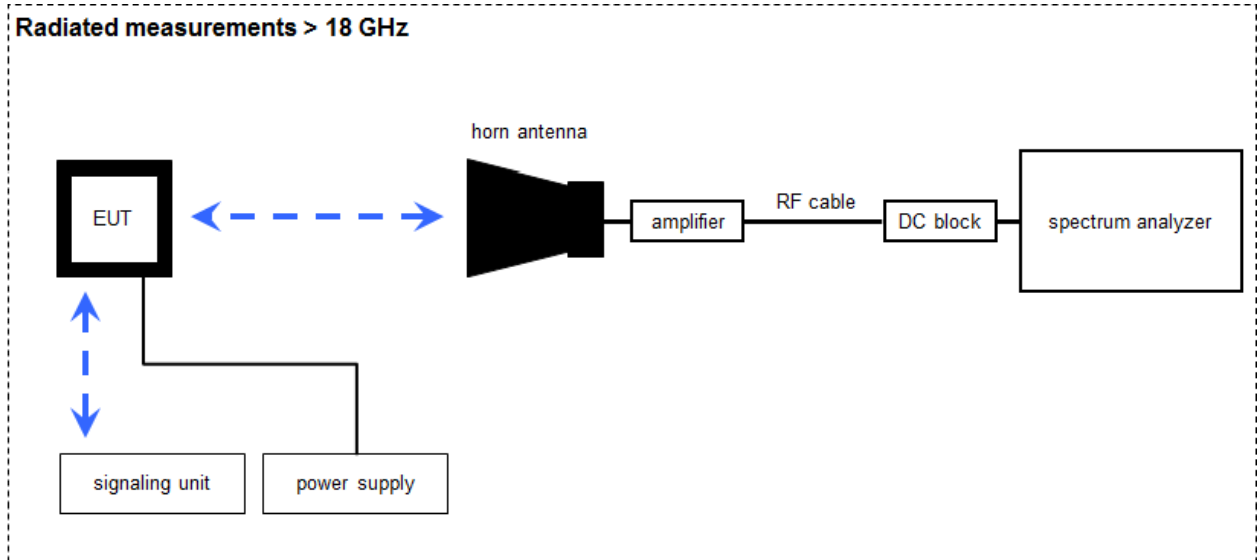

Measurement distance: horn antenna 50 cm

$$FS = UR + CA + AF$$

(FS-field strength; UR-voltage at the receiver; CA-loss signal path & distance correction; AF-antenna factor)

Example calculation:

$$FS [dB\mu V/m] = 40.0 [dB\mu V/m] + (-60.1) [dB] + 36.74 [dB/m] = 16.64 [dB\mu V/m] (6.79 \mu V/m)$$

Equipment table:

No.	Lab / Item	Equipment	Type	Manufacturer	Serial No.	INV. No.	Kind of Calibration	Last Calibration	Next Calibration
1	A	Microwave System Amplifier, 0.5-26.5 GHz	83017A	HP	00419	300002268	ev	-/-	-/-
2	A	Std. Gain Horn Antenna 18.0-26.5 GHz	638	Narda	01096	300000486	vIKI!	17.01.2022	31.01.2024
3	A	Std. Gain Horn Antenna 26.5-40.0 GHz	V637	Narda	82-16	300000510	vIKI!	17.01.2022	31.01.2024
4	A	Broadband Low Noise Amplifier 18-50 GHz	CBL18503070-XX	CERNEX	19338	300004273	ev	-/-	-/-
5	A	RF-Cable	ST18/SMAM/SMAM/48	Huber & Suhner	Batch no. 600918	400001182	ev	-/-	-/-
6	A	Signal Analyzer 40 GHz	FSV40	R&S	101042	300004517	k	25.01.2022	31.01.2023

8.4 Conducted measurements normal and extreme conditions

Conducted measurements normal & extreme conditions

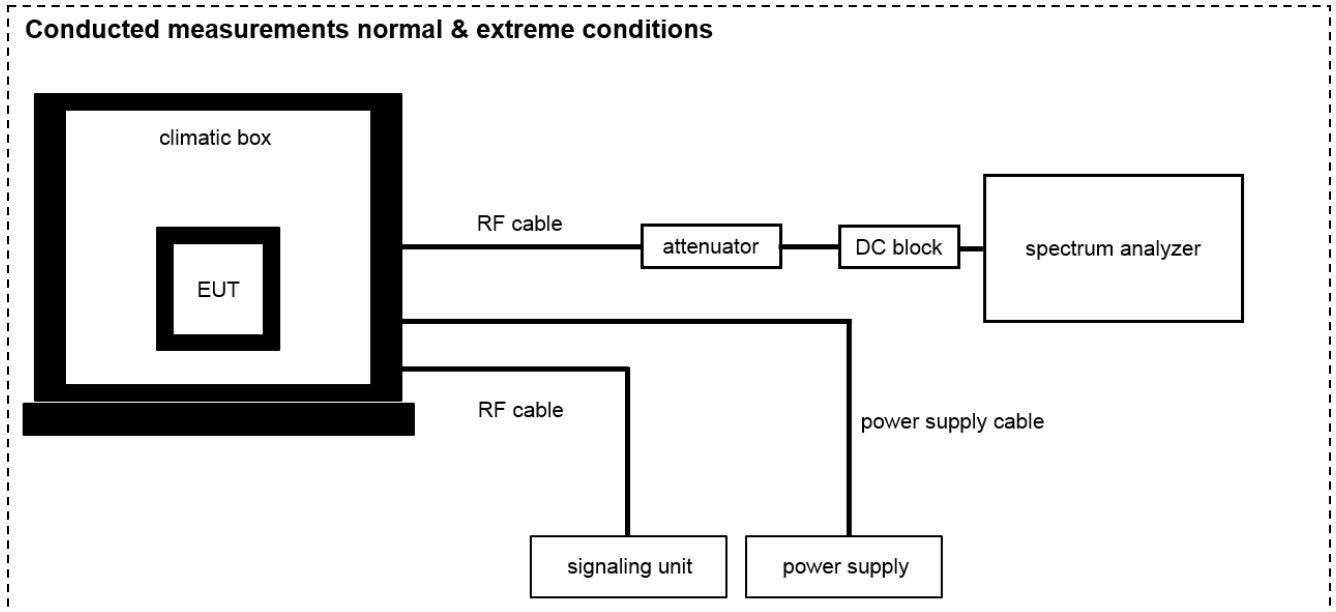

OP = AV + CA
(OP-output power; AV-analyzer value; CA-loss signal path)

Example calculation:

OP [dBm] = 6.0 [dBm] + 11.7 [dB] = 17.7 [dBm] (58.88 mW)

Equipment table:

No.	Setup	Equipment	Type	Manufacturer	Serial No.	INV. No.	Kind of Calibration	Last Calibration	Next Calibration
1	A	Signal analyzer	FSV40	Rohde&Schwarz	101042	300004517	k	25.01.2022	31.01.2023
2	A	Teststand	Teststand Custom Sequence Editor	National Instruments GmbH		300004590	ne	-/-	-/-
3	A	RF-Cable	ST18/SMAm/SMAm /72	Huber & Suhner	Batch no. 699714	400001184	ev	-/-	-/-
4	A	DC-Blocker 0.1-40 GHz	8141A	Inmet		400001185	ev	-/-	-/-
5	A	RF-Cable	ST18/SMAm/SMAm /36	Huber & Suhner	Batch no. 601494	400001309	ev	-/-	-/-
6	A	Temperature Test Chamber	T-40/50	CTS GmbH	064023	300003540	ev	09.05.2022	08.05.2024

9 Measurement uncertainty

Measurement uncertainty		
Test case	Uncertainty	
Antenna gain	± 3 dB	
99 % bandwidth	± RBW	
-26 dB bandwidth	± RBW	
Frequency stability	10 ⁻⁶	
Maximum output power conducted	± 1.56 dB	
Block edge compliance	± 1.56 dB	
Spurious emissions conducted	> 3.6 GHz	± 1.56 dB
	> 7 GHz	± 1.56 dB
	> 18 GHz	± 2.31 dB
	≥ 40 GHz	± 2.97 dB
Spurious emissions radiated below 30 MHz	± 3 dB	
Spurious emissions radiated 30 MHz to 1 GHz	± 3 dB	
Spurious emissions radiated 1 GHz to 12.75 GHz	± 3.7 dB	
Spurious emissions radiated above 12.75 GHz	± 4.5 dB	

10 Additional information and comments

Reference documents: Customer Questionnaire_F5688W_Sagemcom_v3.docx
F5866WTMO_ANTENNA MAPPING_v2.xlsx
1-3977_22-02-15_Annex_MR_A1

Special test descriptions: Although the device has 4 integrated antennas, only antenna 1 (LTE_M) is used for TX mode for 5G NR.
Supported bandwidths for 5G NR band 25: 5, 10, 15, 20, 30 and 40 MHz
CP-OFDM and DFT-s-OFDM were investigated and DFT-s-OFDM was found to be the worst case.
Modulation types investigated: BPSK, QPSK, 16 QAM, 64 QAM, 256-QAM.

Configuration descriptions: None

EUT selection:

- Only one device available
- Devices selected by the customer
- Devices selected by the laboratory (Randomly)

11 Summary of measurement results

<input checked="" type="checkbox"/>	No deviations from the technical specifications were ascertained
<input type="checkbox"/>	There were deviations from the technical specifications ascertained
<input type="checkbox"/>	This test report is only a partial test report. The content and verdict of the performed test cases are listed below.

TC identifier	Description	verdict	date	Remark
RF-Testing	FCC: CFR Part 2 & Part 24	See table!	2022-07-28	-/-

11.1 Part 24: 5G NR band 25

Test Case	temperature conditions	power source voltages	C	NC	NA	NP	Remark
RF Output Power	Nominal	Nominal	<input checked="" type="checkbox"/>	<input type="checkbox"/>	<input type="checkbox"/>	<input type="checkbox"/>	-/-
Frequency Stability	Extreme	Extreme	<input checked="" type="checkbox"/>	<input type="checkbox"/>	<input type="checkbox"/>	<input type="checkbox"/>	-/-
Spurious Emissions Radiated	Nominal	Nominal	<input checked="" type="checkbox"/>	<input type="checkbox"/>	<input type="checkbox"/>	<input type="checkbox"/>	-/-
Spurious Emissions Conducted	Nominal	Nominal	<input checked="" type="checkbox"/>	<input type="checkbox"/>	<input type="checkbox"/>	<input type="checkbox"/>	-/-
Block Edge Compliance	Nominal	Nominal	<input checked="" type="checkbox"/>	<input type="checkbox"/>	<input type="checkbox"/>	<input type="checkbox"/>	-/-
Occupied Bandwidth	Nominal	Nominal	<input checked="" type="checkbox"/>	<input type="checkbox"/>	<input type="checkbox"/>	<input type="checkbox"/>	-/-

Notes:

C	Compliant	NC	Not compliant	NA	Not applicable	NP	Not performed
----------	-----------	-----------	---------------	-----------	----------------	-----------	---------------

12 RF measurements

12.1 Description of test setup

For the spurious measurements we use the substitution method according TIA/EIA 603.

12.2 Results 5G NR band 25

The EUT was set to transmit the maximum power.

12.2.1 RF output power

Description:

This paragraph contains average power, peak output power and EIRP measurements for the mobile station. In all cases, the peak output power is within the required mask (this mask is specified in the JTC standards, TIA PN3389 Vol. 1 Chap 7, and is no FCC requirement).

Measurement:

The mobile was set up for the maximum output power with pseudo random data modulation.

To determine the Peak-To-Average Power Ratio (PAPR) the measurement was performed with the Power Complementary Cumulative Distribution Function (CCDF).

Measurement parameters	
Detector:	Sample
AQT:	See plot
Resolution bandwidth:	40 MHz
Used equipment:	See chapter 8.2 setup A & 8.4 setup A
Measurement uncertainty:	See chapter 9
Measurement procedure:	FCC: § 2.1046

Limits:

FCC
§ 24.232(c)
(c) Mobile and portable stations are limited to 2 watts EIRP and the equipment must employ a means for limiting power to the minimum necessary for successful communications.
(d) In measuring transmissions in this band using an average power technique, the peak-to-average ratio (PAR) of the transmission may not exceed 13 dB.
Power: 33 dBm EIRP PAPR: 13 dB

Results:

Output Power (conducted)							
Bandwidth (MHz)	Channel No. / Frequency (MHz)	Resource block allocation	Average Output Power (dBm)	Average Output Power (dBm)	Average Output Power (dBm)	Average Output Power (dBm)	Average Output Power (dBm)
			BPSK	QPSK	16-QAM	64-QAM	256-QAM
5	370500 / 1852.5	1 RB low	22.0	21.7	20.7	20.0	18.5
		1 RB low+1	22.6	22.7	21.8	20.0	18.5
		1 RB high-1	22.6	22.7	21.7	19.9	18.7
		1 RB high	22.1	21.7	20.8	20.0	18.6
		50% RB mid	22.7	22.6	21.7	20.1	18.9
		100% RB	22.1	21.6	20.6	20.1	18.9
	376500 / 1882.5	1 RB low	22.3	21.9	20.9	20.2	18.9
		1 RB low+1	22.7	23.0	22.0	20.1	18.8
		1 RB high-1	22.8	22.9	22.0	20.1	18.9
		1 RB high	22.3	21.9	20.9	20.2	18.9
		50% RB mid	22.9	22.8	21.8	20.4	19.3
		100% RB	22.2	21.7	20.7	20.3	19.3
	382500 / 1912.5	1 RB low	22.0	21.7	20.7	19.9	18.9
		1 RB low+1	22.6	22.8	21.8	19.9	18.9
		1 RB high-1	22.4	22.6	21.6	19.9	18.9
		1 RB high	22.0	21.6	20.6	19.8	18.8
		50% RB mid	22.7	22.7	21.8	20.1	19.2
		100% RB	22.5	21.9	21.0	20.5	19.3
10	371000 / 1855.0	1 RB low	22.1	21.8	20.8	20.0	18.9
		1 RB low+1	22.6	22.8	21.7	20.0	18.5
		1 RB high-1	22.5	22.6	21.7	19.9	18.5
		1 RB high	22.1	21.7	20.7	20.0	18.6
		50% RB mid	22.7	22.6	21.7	20.2	18.9
		100% RB	22.1	21.6	20.5	20.1	19.0
	376500 / 1882.5	1 RB low	22.1	21.8	20.7	19.8	18.7
		1 RB low+1	22.6	22.8	21.8	19.9	18.8
		1 RB high-1	22.6	22.7	21.8	19.9	18.8
		1 RB high	22.1	21.7	20.7	19.9	18.9
		50% RB mid	22.7	22.8	21.8	20.2	19.3
		100% RB	22.2	21.7	20.5	20.1	19.3
	382000 / 1910.0	1 RB low	22.0	21.7	20.7	19.7	18.8
		1 RB low+1	22.6	22.6	21.7	19.7	18.8
		1 RB high-1	22.5	22.6	21.6	19.8	18.7
		1 RB high	21.9	21.7	20.6	19.9	18.8
		50% RB mid	22.7	22.7	21.7	20.1	19.3
		100% RB	22.4	21.9	20.8	20.4	19.2
15	371500 / 1857.5	1 RB low	22.2	21.9	21.0	20.1	18.6
		1 RB low+1	22.6	22.8	22.0	20.1	18.6

Output Power (conducted)							
Bandwidth (MHz)	Channel No. / Frequency (MHz)	Resource block allocation	Average Output Power (dBm) BPSK	Average Output Power (dBm) QPSK	Average Output Power (dBm) 16-QAM	Average Output Power (dBm) 64-QAM	Average Output Power (dBm) 256-QAM
		1 RB high-1	22.8	23.0	22.1	20.2	18.9
		1 RB high	22.4	22.0	21.1	20.2	18.9
		50% RB mid	22.9	22.9	21.8	20.3	19.1
		100% RB	22.1	21.7	20.6	20.1	19.2
	376500 / 1882.5	1 RB low	22.5	22.1	21.1	20.3	19.0
		1 RB low+1	22.9	22.9	22.1	20.4	19.1
		1 RB high-1	22.9	22.9	22.1	20.3	19.2
		1 RB high	22.4	22.0	21.0	20.2	19.1
		50% RB mid	22.9	22.9	22.0	20.3	19.4
	381500 / 1907.5	100% RB	22.3	21.8	20.6	20.3	19.5
		1 RB low	22.4	22.1	21.1	20.3	19.0
		1 RB low+1	22.9	22.9	22.2	20.3	19.1
		1 RB high-1	22.7	22.9	21.9	20.1	18.9
		1 RB high	22.2	21.9	20.8	20.0	19.0
	20	372000 / 1860.0	50% RB mid	22.9	22.9	21.9	20.3
100% RB			22.5	22.0	20.9	20.5	19.5
1 RB low			22.1	21.8	20.8	20.0	18.7
1 RB low+1			22.6	22.8	21.8	20.1	18.6
1 RB high-1			22.8	23.0	22.0	20.2	19.0
1 RB high			22.3	22.0	21.0	20.2	19.0
376500 / 1882.5		50% RB mid	22.8	22.8	21.9	20.4	19.2
		100% RB	22.1	21.6	20.6	20.1	19.2
		1 RB low	22.4	22.0	21.0	20.2	19.0
		1 RB low+1	22.9	23.0	22.1	20.2	19.0
		1 RB high-1	22.9	23.0	22.1	20.3	19.1
381000 / 1905.0		1 RB high	22.4	22.1	21.1	20.3	19.0
		50% RB mid	23.0	23.0	22.0	20.5	19.4
		100% RB	22.3	21.7	20.7	20.2	19.5
		1 RB low	22.5	22.1	21.1	20.4	19.0
	1 RB low+1	23.0	23.0	22.2	20.4	19.0	
	1 RB high-1	22.8	22.9	21.9	20.2	19.0	
30	373000 / 1865.0	1 RB high	22.2	22.0	20.9	20.1	19.0
		50% RB mid	23.0	23.0	22.0	20.5	19.4
		100% RB	22.3	21.9	20.8	20.4	19.5
		1 RB low	22.6	22.7	21.7	20.9	18.6
		1 RB low+1	22.7	22.8	22.9	21.4	18.6
		1 RB high-1	23.2	23.2	23.1	21.9	19.1
	1 RB high	23.2	23.2	22.1	21.7	19.1	
376500 /	50% RB mid	23.1	23.1	23.2	21.6	19.2	
	100% RB	23.1	22.1	21.6	19.6	19.3	
	1 RB low	23.3	23.0	22.0	21.5	19.0	

Output Power (conducted)								
Bandwidth (MHz)	Channel No. / Frequency (MHz)	Resource block allocation	Average Output Power (dBm) BPSK	Average Output Power (dBm) QPSK	Average Output Power (dBm) 16-QAM	Average Output Power (dBm) 64-QAM	Average Output Power (dBm) 256-QAM	
	1882.5	1 RB low+1	23.1	23.1	23.3	21.6	18.9	
		1 RB high-1	23.2	23.3	23.3	22.1	19.1	
		1 RB high	23.2	23.2	22.4	21.9	19.1	
		50% RB mid	23.2	23.2	22.4	21.7	19.4	
		100% RB	23.3	23.4	22.3	21.8	19.5	
	380000 / 1900.0	1 RB low	23.2	23.1	22.2	21.5	19.1	
		1 RB low+1	23.2	23.3	23.1	21.9	19.1	
		1 RB high-1	23.2	23.2	23.3	21.8	19.0	
		1 RB high	23.2	23.3	22.4	21.9	19.0	
		50% RB mid	23.3	23.3	23.4	21.9	19.4	
	40	374000 / 1870.0	100% RB	23.3	23.4	22.4	22.0	19.4
			1 RB low	22.6	22.6	21.5	21.1	18.7
			1 RB low+1	22.6	22.6	22.6	21.3	18.6
			1 RB high-1	23.2	23.1	23.2	21.8	19.3
1 RB high			23.1	23.1	22.1	21.9	19.3	
50% RB mid			23.2	23.2	23.1	21.7	19.2	
376500 / 1882.5		100% RB	23.0	23.0	22.0	21.6	19.4	
		1 RB low	23.0	23.1	22.0	21.6	18.8	
		1 RB low+1	23.1	23.1	23.0	21.6	18.9	
		1 RB high-1	23.2	23.2	23.3	21.9	19.2	
		1 RB high	23.3	23.3	22.2	21.9	19.1	
		50% RB mid	23.1	23.2	23.1	21.6	19.5	
379000 / 1895.0		100% RB	23.2	23.2	22.1	21.6	19.5	
		1 RB low	23.1	23.2	22.3	21.8	19.0	
	1 RB low+1	23.2	23.2	23.1	21.8	19.0		
	1 RB high-1	23.3	23.4	22.1	23.3	19.1		
	1 RB high	23.3	23.4	22.3	21.9	19.0		
	50% RB mid	23.3	23.4	23.4	21.8	19.2		
		100% RB	23.4	23.3	22.4	21.9	19.2	

The radiated output power is measured in the mode with the highest conducted output power.

Output Power (EIRP)						
Bandwidth (MHz)	Channel / Frequency (MHz)	Average Output Power (dBm)	Average Output Power (dBm)	Average Output Power (dBm)	Average Output Power (dBm)	Average Output Power (dBm)
		BPSK	QPSK	16-QAM	64-QAM	256-QAM
5	1852.5	25.7	25.7	24.8	23.1	21.9
	1882.5	26.0	26.1	25.1	23.5	22.4
	1912.5	24.9	25.0	24.0	22.7	21.5
10	1855.0	25.7	25.8	24.7	23.2	22.0
	1882.5	25.8	25.9	24.9	23.3	22.4
	1910.0	24.9	24.9	23.9	22.6	21.5
15	1857.5	25.9	26.0	25.1	23.3	22.2
	1882.5	26.0	26.0	25.2	23.5	22.6
	1907.5	25.1	25.1	24.4	22.7	21.7
20	1860.0	25.8	26.0	25.0	23.4	22.2
	1882.5	26.1	26.1	25.2	23.6	22.6
	1905.0	25.2	25.2	24.4	22.7	21.7
30	1865.0	26.2	26.2	26.2	24.9	22.3
	1882.5	26.4	26.5	26.4	25.2	22.6
	1900.0	25.5	25.6	25.6	24.2	21.6
40	1870.0	26.2	26.2	26.2	24.9	22.4
	1882.5	26.4	26.4	26.4	25.0	22.6
	1895.0	25.6	25.6	25.6	25.5	21.4

PAPR (conducted)							
Bandwidth (MHz)	Channel / Frequency (MHz)	Resource block allocation	Peak to Average Ratio (dB)	Peak to Average Ratio (dB)	Peak to Average Ratio (dB)	Peak to Average Ratio (dB)	Peak to Average Ratio (dB)
		RB Allocation	BPSK	QPSK	16-QAM	64-QAM	256-QAM
5	370500 / 1852.5	100% RB	3.97	4.61	5.65	5.97	6.64
	376500 / 1882.5	100% RB	4.03	4.55	5.62	5.94	7.04
	382500 / 1912.5	100% RB	4.14	4.96	5.39	5.74	6.96
10	371000 / 1855.0	100% RB	4.06	4.67	5.74	6.09	7.22
	376500 / 1882.5	100% RB	4.14	4.78	5.86	6.23	7.16
	382000 / 1910.0	100% RB	4.29	5.13	6.09	6.32	6.93
15	371500 / 1857.5	100% RB	4.06	4.52	5.51	6.03	7.28
	376500 / 1882.5	100% RB	3.94	4.55	5.65	6.03	7.01
	381500 / 1907.5	100% RB	4.29	5.13	6.00	6.29	6.90
20	372000 / 1860.0	100% RB	4.17	4.61	5.68	6.09	7.28
	376500 / 1882.5	100% RB	3.91	4.58	5.65	6.06	7.30
	381000 / 1905.0	100% RB	4.06	4.70	5.74	6.06	7.25
30	373000 / 1865.0	100% RB	4.09	4.96	6.00	6.35	6.61
	376500 / 1882.5	100% RB	3.94	5.10	6.12	6.46	6.61
	380000 / 1900.0	100% RB	3.59	4.32	5.36	5.77	6.90
40	374000 / 1870.0	100% RB	3.88	4.64	5.83	6.23	6.58
	376500 / 1882.5	100% RB	4.20	4.96	5.91	6.26	6.46
	379000 / 1895.0	100% RB	4.52	5.13	6.09	6.41	6.55

12.2.2 Frequency stability

Description:

In order to measure the carrier frequency under the condition of AFC lock, it is necessary to make measurements with the mobile station in a "call mode". This is accomplished with the use of a ANRITSU MT8000A.

1. Measure the carrier frequency at room temperature.
2. Subject the mobile station to overnight soak at -30 C.
3. With the mobile station, powered with V_{nom} , connected to the MT8000A and in a simulated call on channel 18900 (center channel), measure the carrier frequency. These measurements should be made within two minutes of powering up the mobile station, to prevent significant self warming.
4. Repeat the above measurements at 10°C increments from -30°C to +50°C. Allow at least 1.5 hours at each temperature, unpowered, before making measurements.
5. Re-measure carrier frequency at room temperature with V_{nom} . Vary supply voltage from V_{min} to V_{max} , in 0.1 Volt steps re-measuring carrier frequency at each voltage. Pause at V_{nom} for 1.5 hours unpowered, to allow any self heating to stabilize, before continuing.
6. At all temperature levels hold the temperature to +/- 0.5°C during the measurement procedure.

Measurement:

Measurement parameters	
Detector:	Measured with MT8000A
Sweep time:	
Video bandwidth:	
Resolution bandwidth:	
Span:	
Trace-Mode:	
Used equipment:	See chapter 8.4 setup A
Measurement uncertainty:	See chapter 9
Measurement procedure:	FCC: § 2.1055

Limits:

FCC
§ 24.235
The frequency stability shall be sufficient to ensure that the fundamental emission stays within the authorized frequency block.
Reporting only

Results:**AFC FREQ ERROR versus VOLTAGE**

Voltage (V)	Frequency Error (Hz)	Frequency Error (ppm)
102	-1	-0.0005
120	-2	-0.0011
138	-9	-0.0048

AFC FREQ ERROR versus TEMPERATURE

Temperature (°C)	Frequency Error (Hz)	Frequency Error (ppm)
-30	-5	-0.0027
-20	-6	-0.0032
-10	-6	-0.0032
± 0	-2	-0.0011
10	-6	-0.0032
20	3	0.0016
30	-6	-0.0032
40	-4	-0.0021
50	-6	-0.0032

12.2.3 Spurious emissions radiated

Description:

The following steps outline the procedure used to measure the radiated emissions from the mobile station. The site is constructed in accordance with ANSI C63.4:2014 requirements and is recognized by the FCC to be in compliance for a 3 and a 10 meter site. The spectrum was scanned from 30 MHz to the 10th harmonic of the highest frequency generated within the equipment. The resolution bandwidth is set as outlined in Part 24.238. The spectrum was scanned with the mobile station transmitting at carrier frequencies that pertain to low, middle and highest channels of the 5G NR band 25.

Measurement:

Measurement parameters	
Detector:	Peak
Sweep time:	2 sec.
Resolution bandwidth:	1 MHz
Video bandwidth:	3 MHz
Span:	100 MHz Steps
Trace mode:	Max Hold
Used equipment:	See chapter 8.1 setup A & 8.2 setup A+B & setup 8.3 A
Measurement uncertainty:	See chapter 9
Measurement procedure	FCC: § 2.1053

Limits:

FCC
§ 24.238 (a) & (b)
<p>(a) The power of any emission outside of the authorized operating frequency ranges must be attenuated below the transmitting power (P) by a factor of at least 43 + 10 log(P) dB.</p> <p>(b) Compliance with these rules is based on the use of measurement instrumentation employing a resolution bandwidth of 1 MHz or greater. However, in the 1 MHz bands immediately outside and adjacent to the frequency block a resolution bandwidth of at least one percent of the emission bandwidth of the fundamental emission of the transmitter may be employed. A narrower resolution bandwidth is permitted in all cases to improve measurement accuracy provided the measured power is integrated over the full required measurement bandwidth (i.e. 1 MHz or 1 percent of emission bandwidth, as specified). The emission bandwidth is defined as the width of the signal between two points, one below the carrier center frequency and one above the carrier center frequency, outside of which all emissions are attenuated at least 26 dB below the transmitter power.</p>
-13 dBm

Results:

QPSK:

Spurious Emission Level					
Lowest channel		Middle channel		Highest channel	
Spurious emissions	Level [dBm]	Spurious emissions	Level [dBm]	Spurious emissions	Level [dBm]
-/-		-/-		-/-	

BPSK:

Spurious Emission Level					
Lowest channel		Middle channel		Highest channel	
Spurious emissions	Level [dBm]	Spurious emissions	Level [dBm]	Spurious emissions	Level [dBm]
-/-		-/-		-/-	

16-QAM:

Spurious Emission Level					
Lowest channel		Middle channel		Highest channel	
Spurious emissions	Level [dBm]	Spurious emissions	Level [dBm]	Spurious emissions	Level [dBm]
-/-		-/-		-/-	

64-QAM:

Spurious Emission Level					
Lowest channel		Middle channel		Highest channel	
Spurious emissions	Level [dBm]	Spurious emissions	Level [dBm]	Spurious emissions	Level [dBm]
-/-		-/-		-/-	

256-QAM:

Spurious Emission Level					
Lowest channel		Middle channel		Highest channel	
Spurious emissions	Level [dBm]	Spurious emissions	Level [dBm]	Spurious emissions	Level [dBm]
-/-		-/-		-/-	

Plots:

Plot 1: QPSK - Middle channel (9 kHz - 30 MHz)

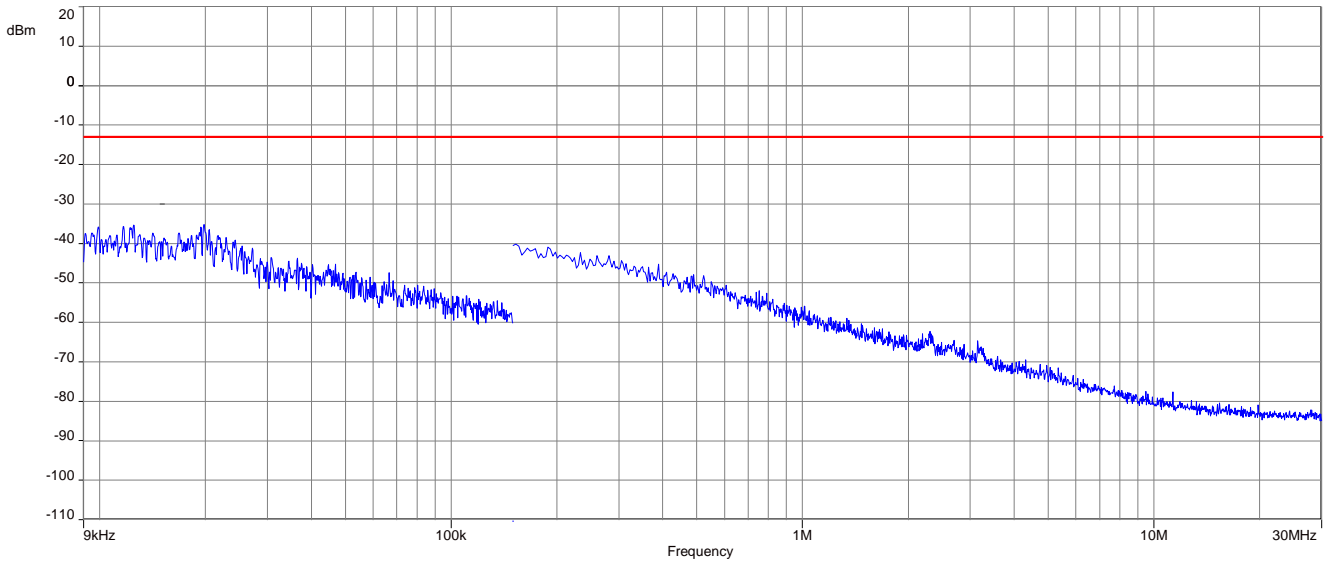

Plot 2: QPSK - Middle channel (30 MHz – 1 GHz)

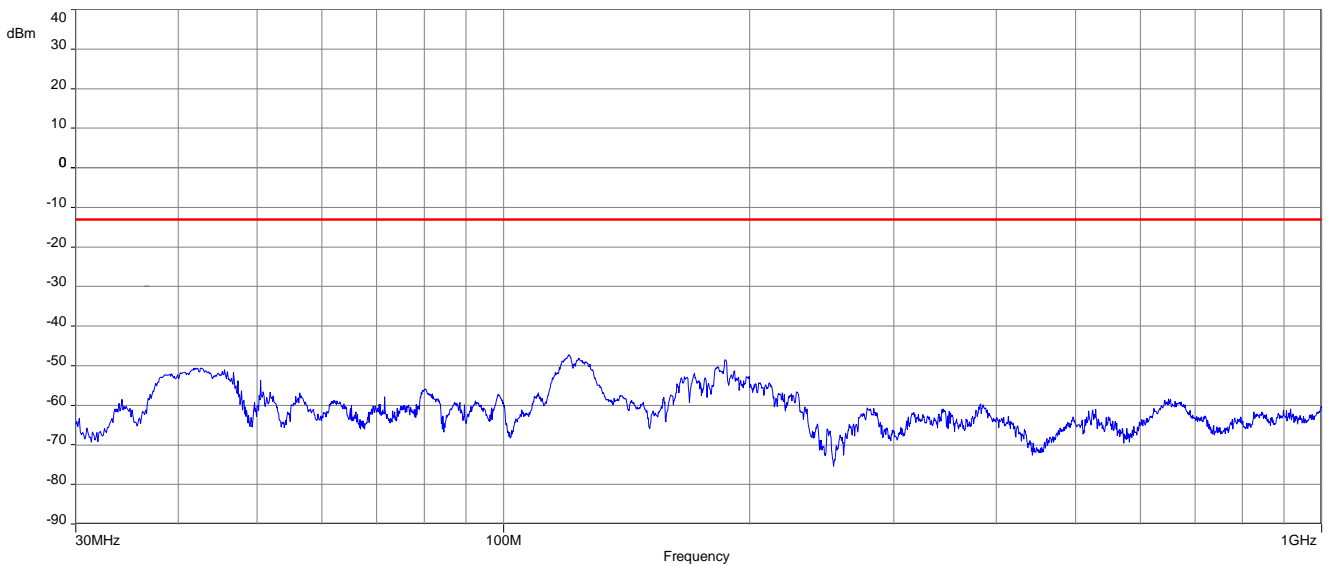

Plot 3: QPSK - Middle channel (1 GHz – 18 GHz)

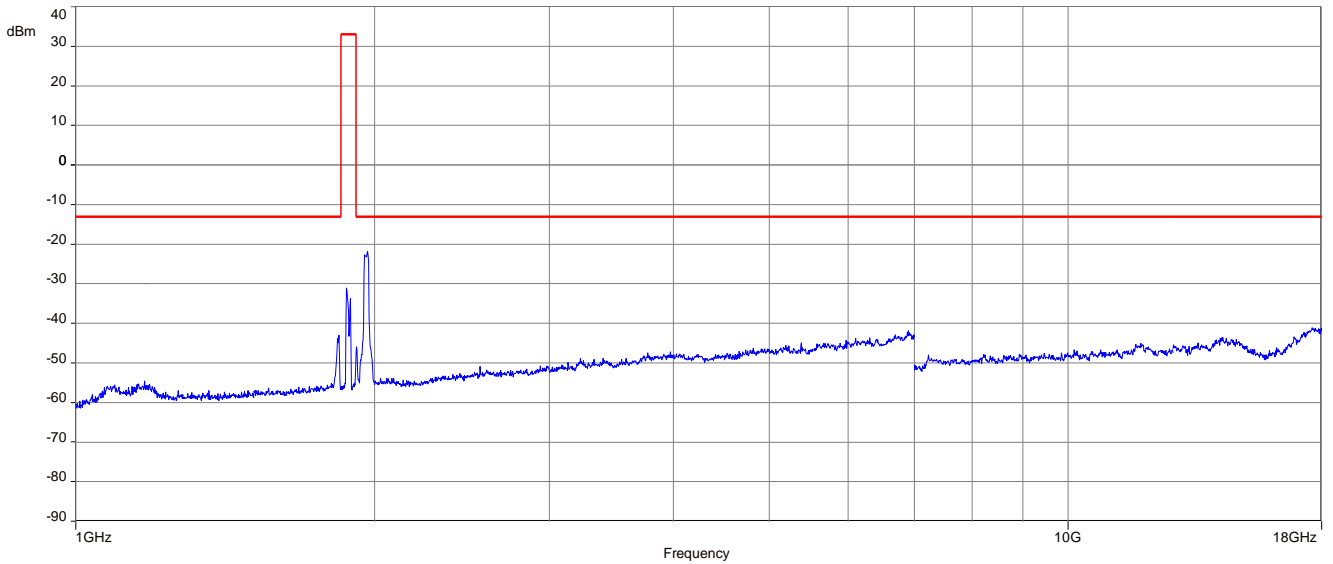

Plot 4: QPSK - Middle channel (18 GHz – 26 GHz)

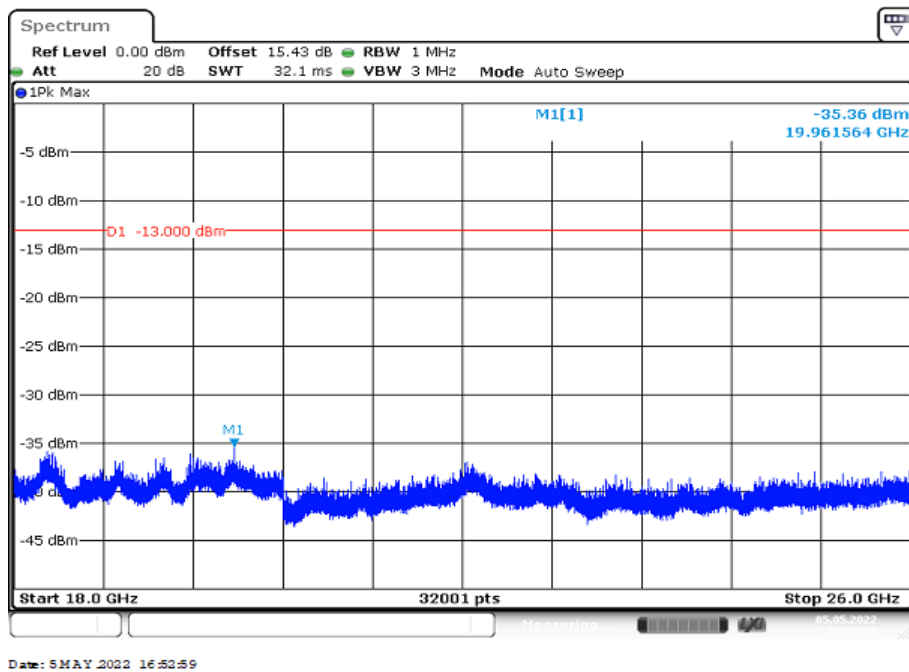

Plot 5: 16-QAM - Middle channel (9 kHz - 30 MHz)

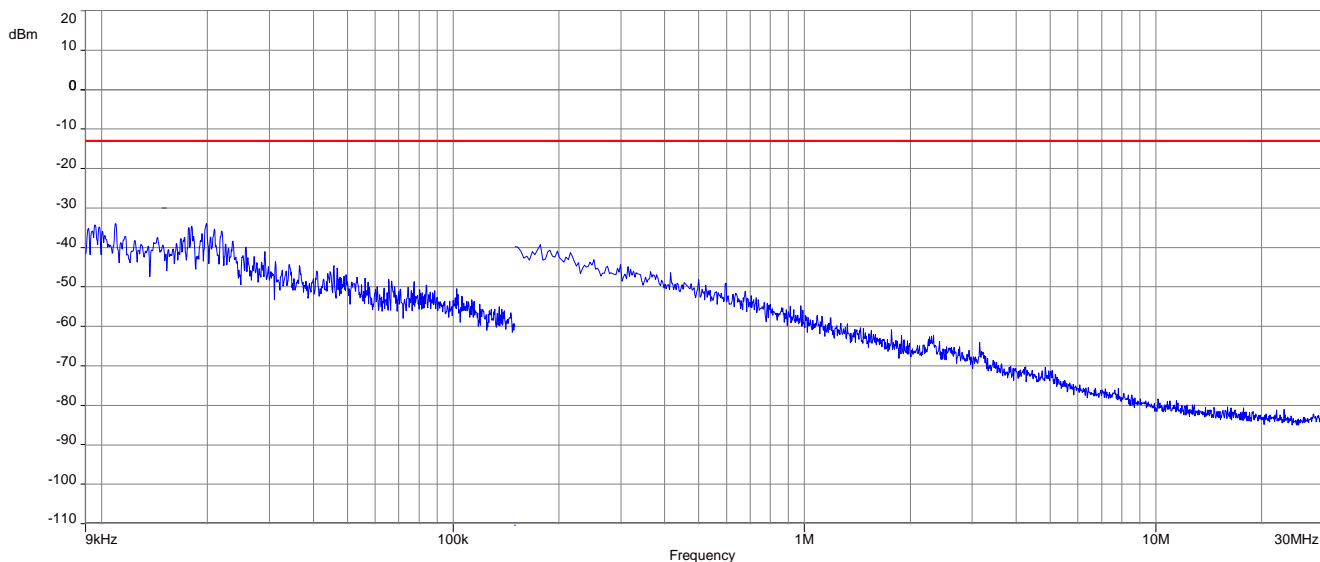

Plot 6: 16-QAM - Middle channel (30 MHz – 1 GHz)

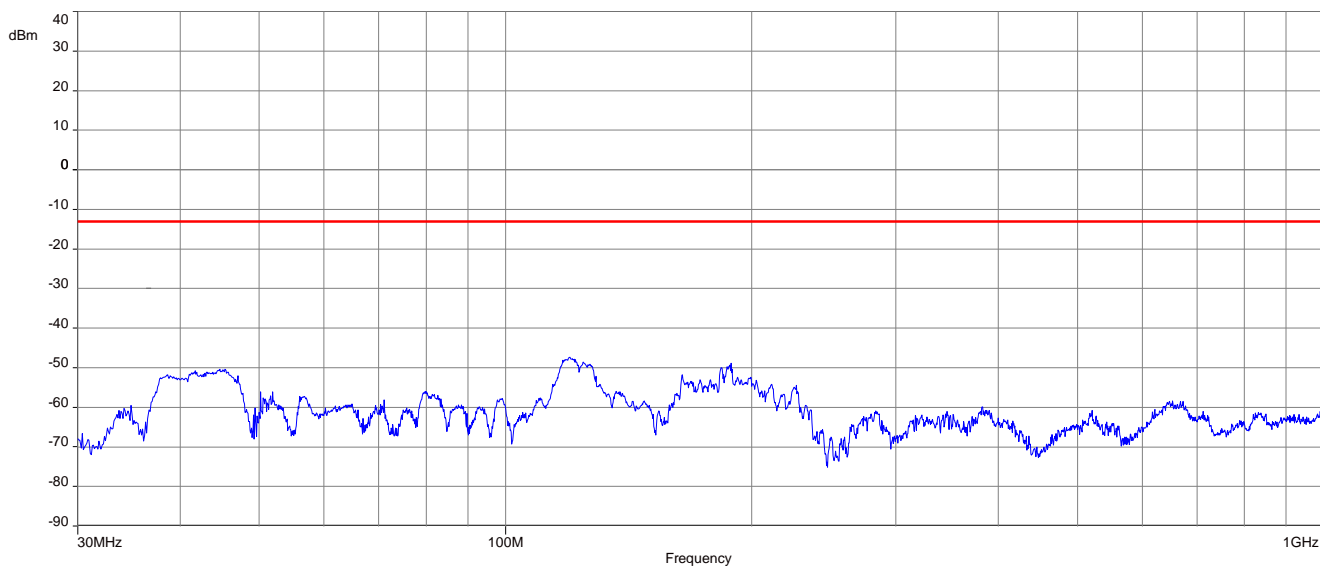

Plot 7: 16-QAM - Middle channel (1 GHz – 18 GHz)

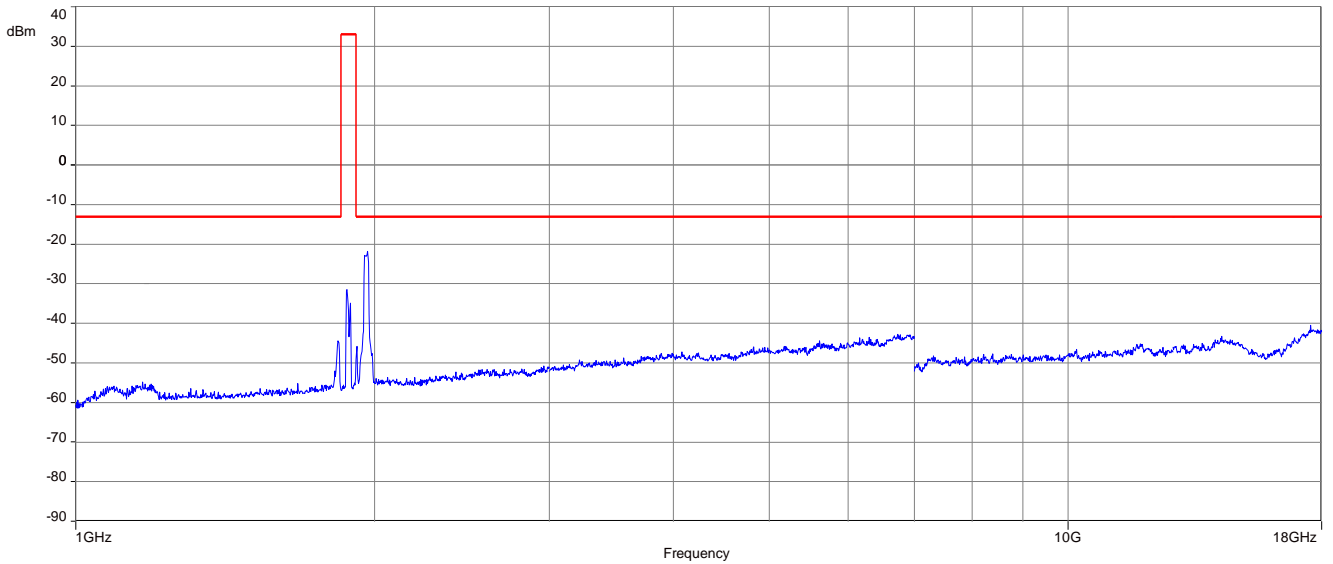

Plot 8: 16-QAM - Middle channel (18 GHz – 26 GHz)

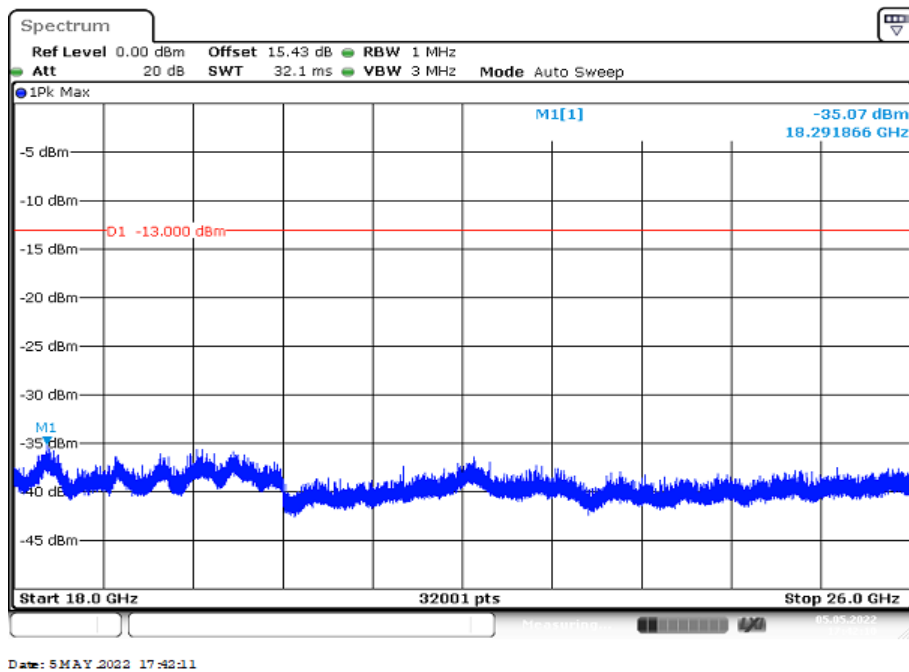

Plot 9: 64-QAM - Middle channel (9 kHz - 30 MHz)

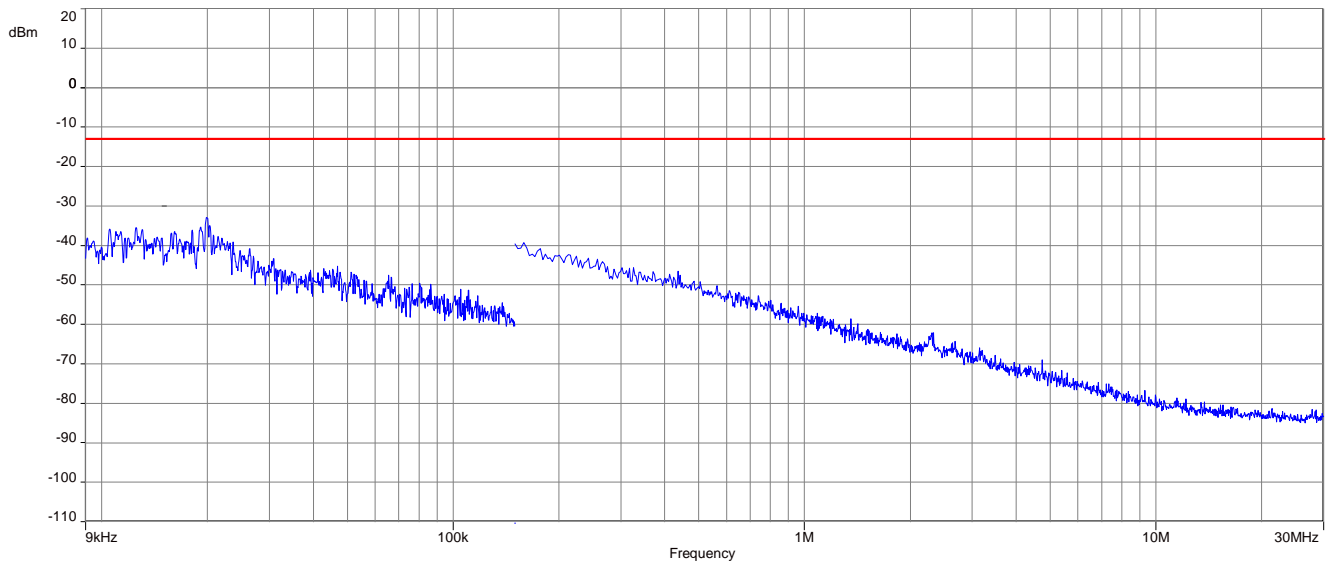

Plot 10: 64-QAM - Middle channel (30 MHz – 1 GHz)

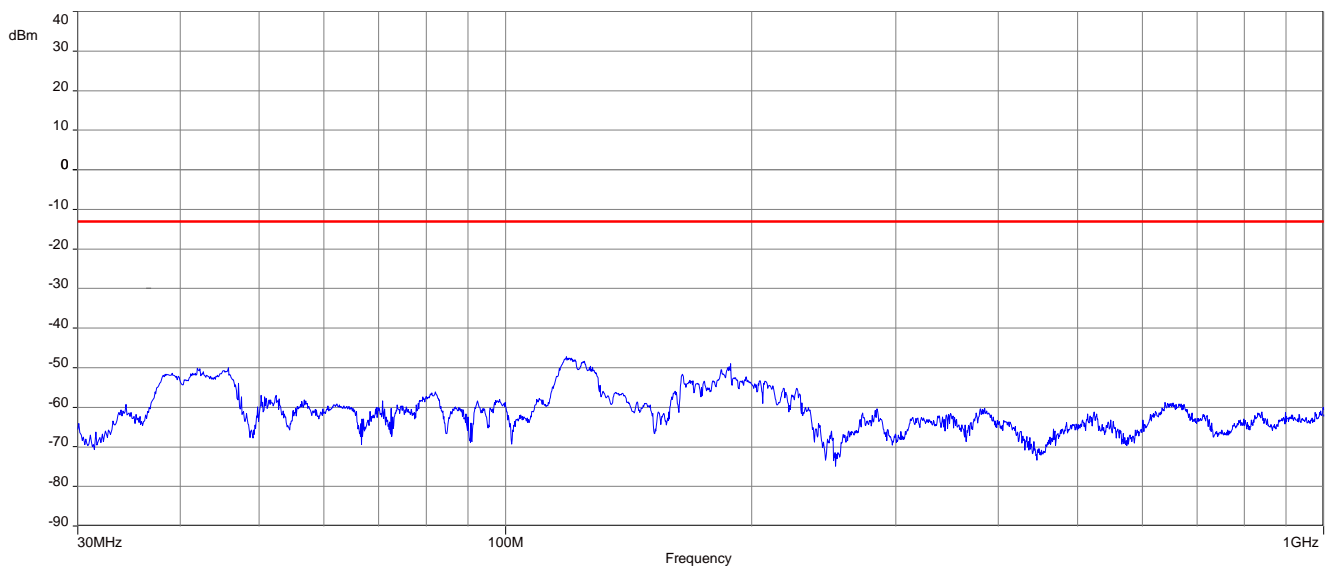

Plot 11: 64-QAM - Middle channel (1 GHz – 18 GHz)

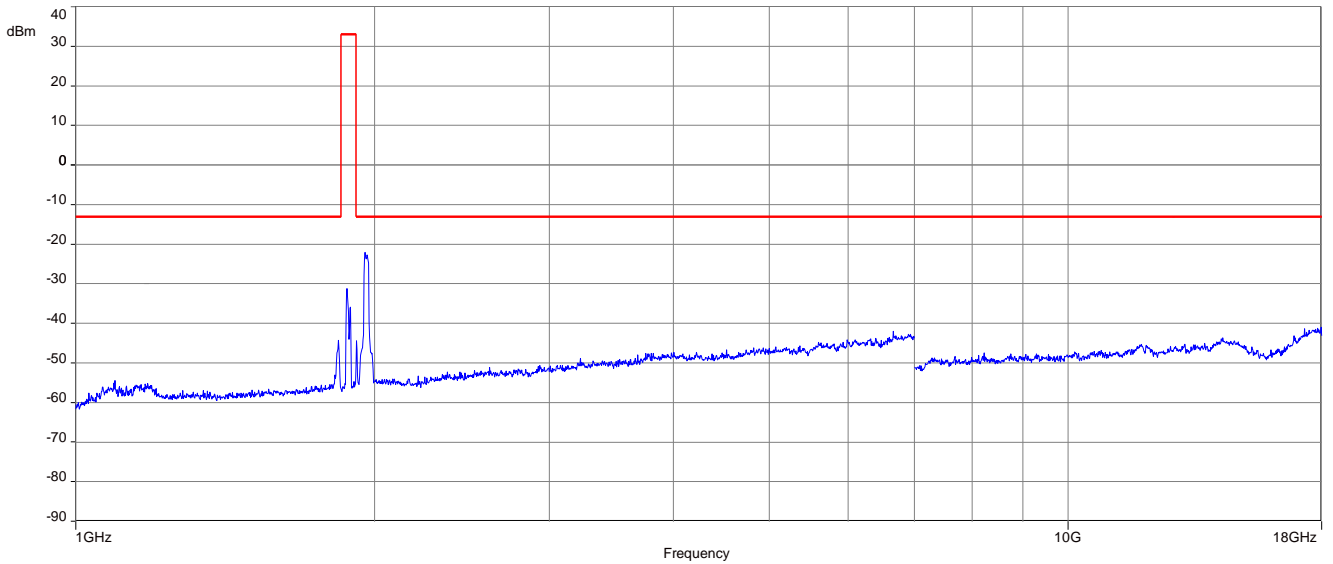

Plot 12: 64-QAM - Middle channel (18 GHz – 26 GHz)

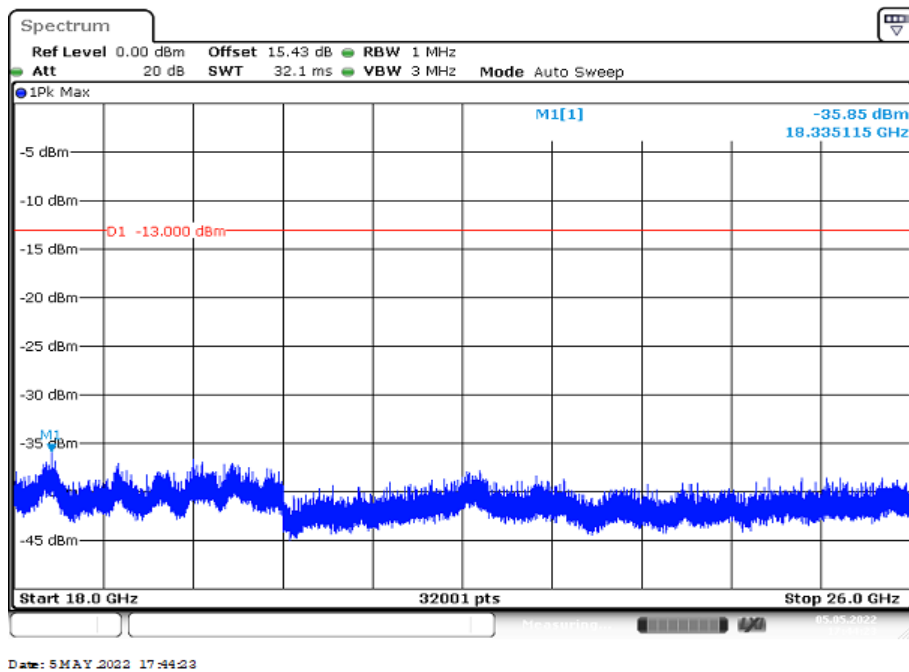

Plot 13: BPSK - Middle channel (9 kHz - 30 MHz)

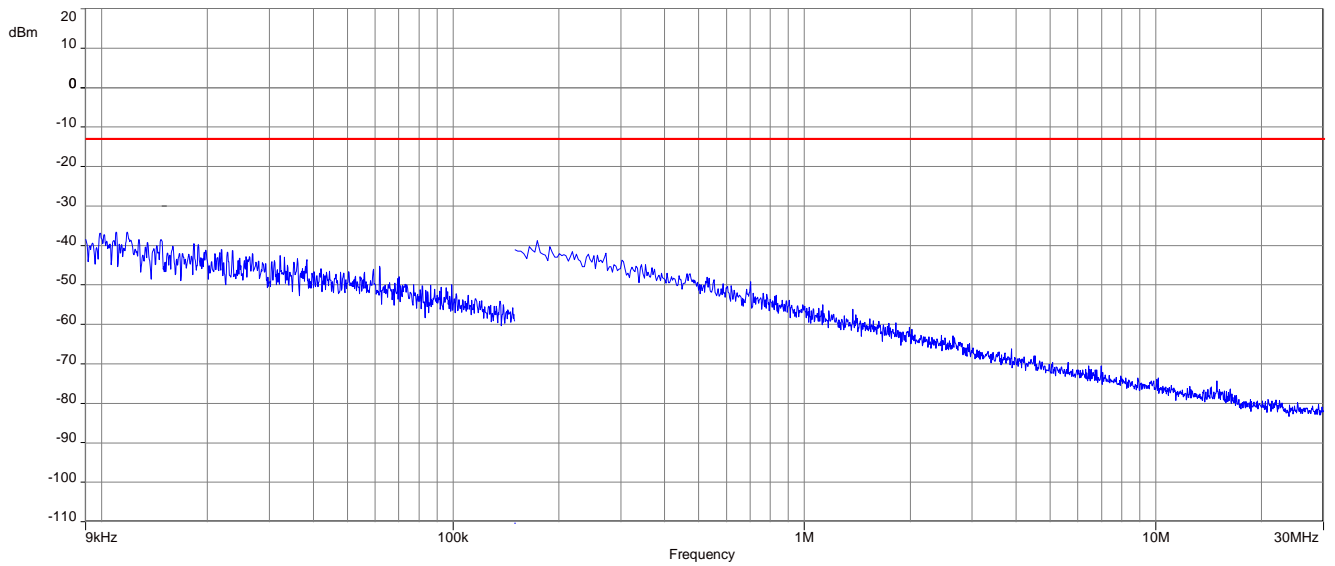

Plot 14: BPSK - Middle channel (30 MHz – 1 GHz)

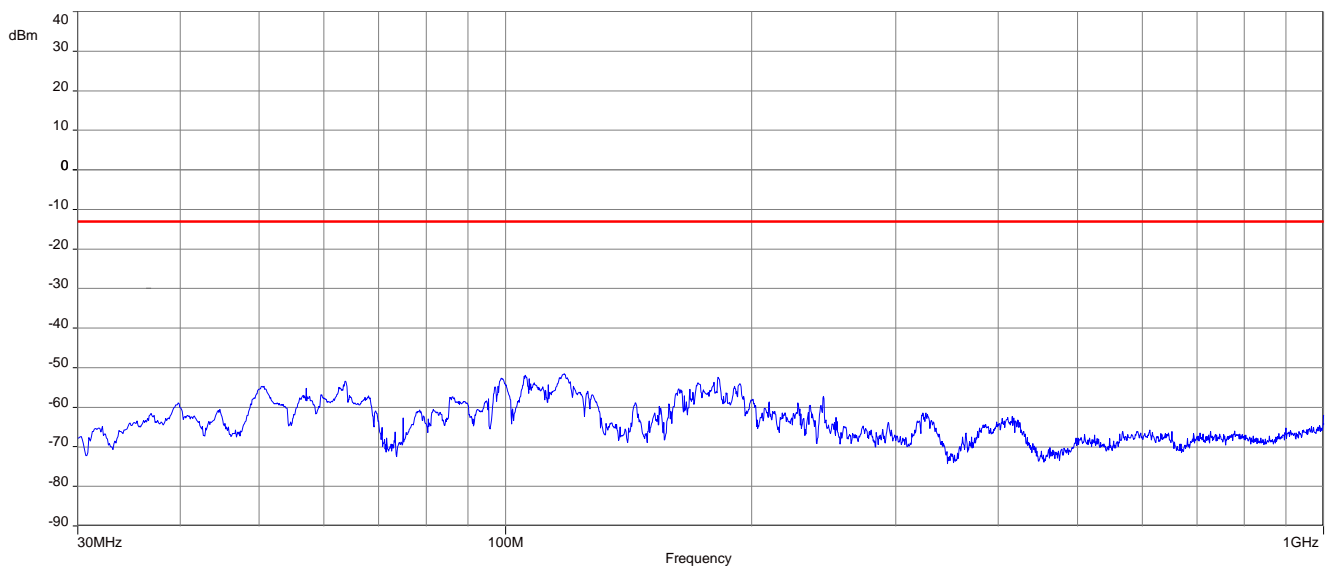

Plot 15: BPSK - Middle channel (1 GHz – 18 GHz)

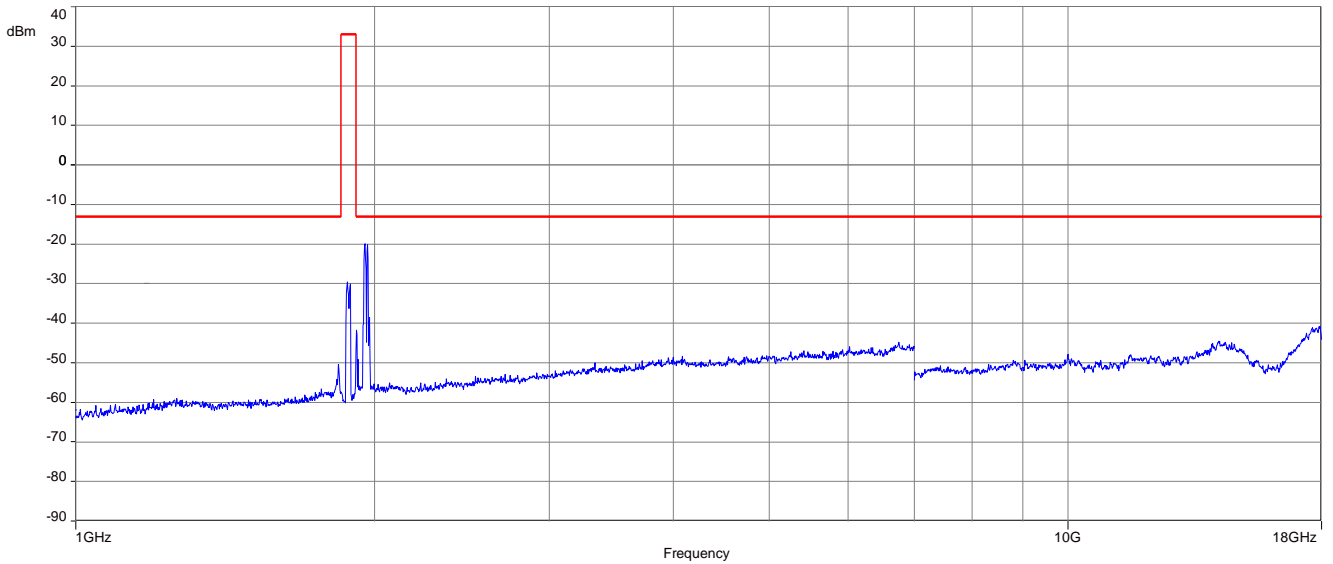

Plot 16: BPSK - Middle channel (18 GHz – 26 GHz)

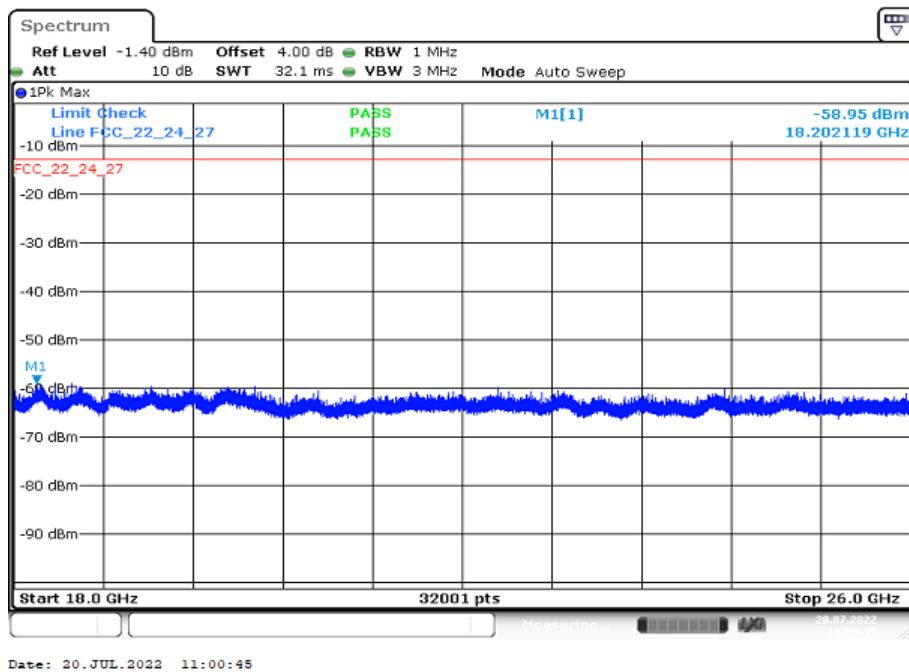

Plot 17: 256-QAM - Middle channel (9 kHz - 30 MHz)

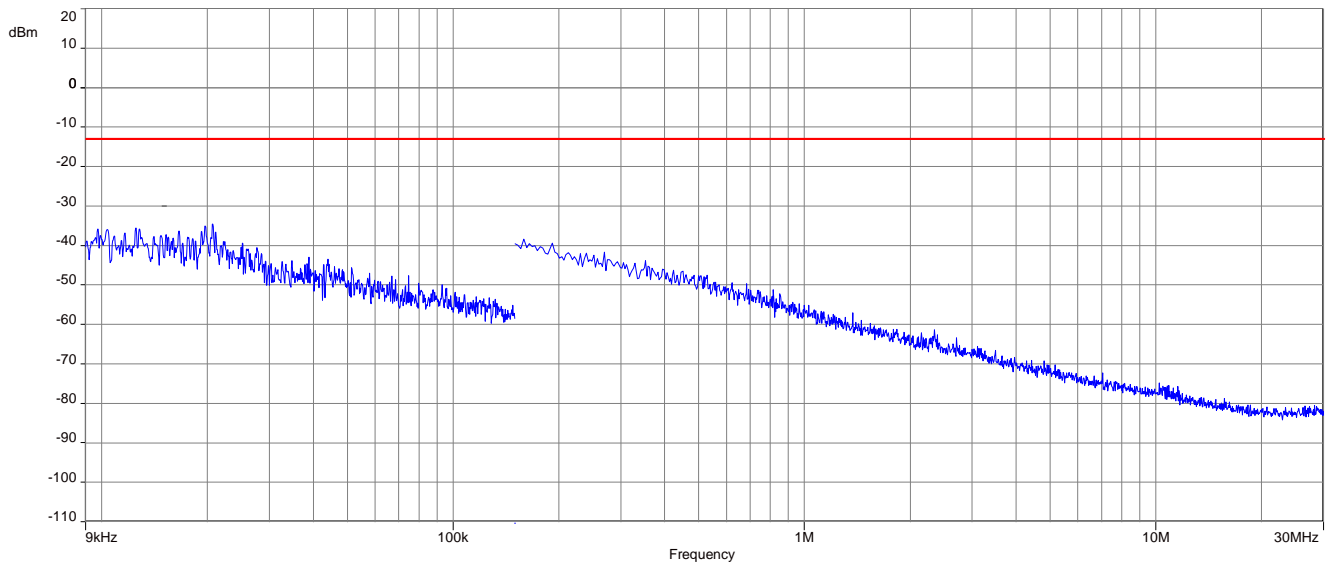

Plot 18: 256-QAM - Middle channel (30 MHz – 1 GHz)

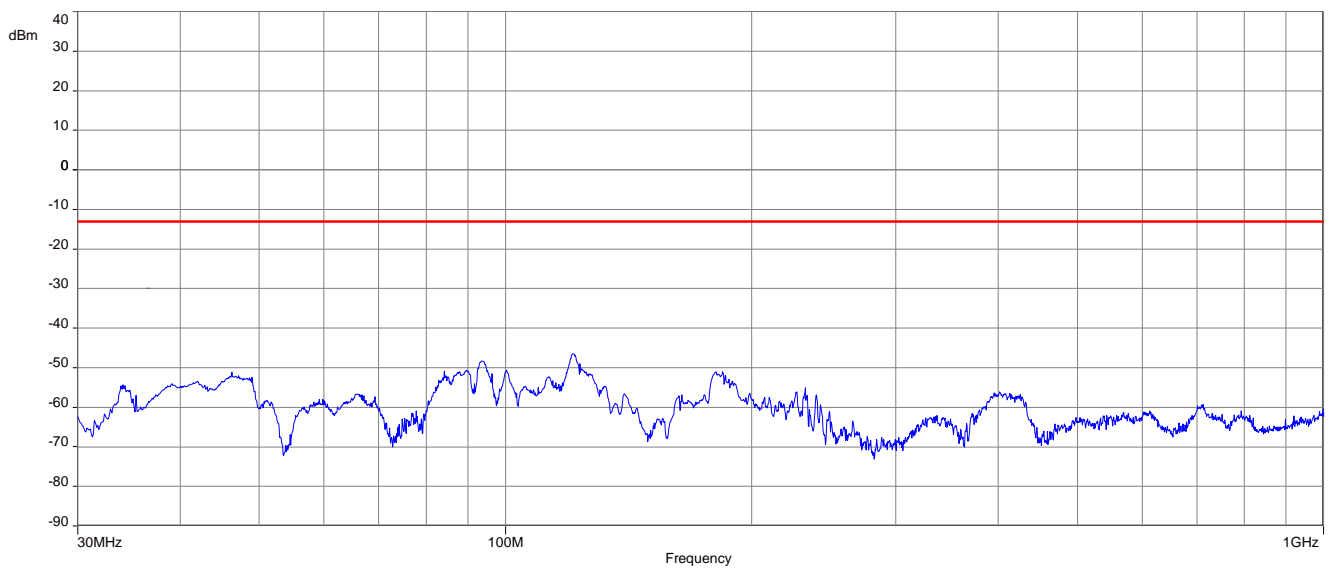

Plot 19: 256-QAM - Middle channel (1 GHz – 18 GHz)

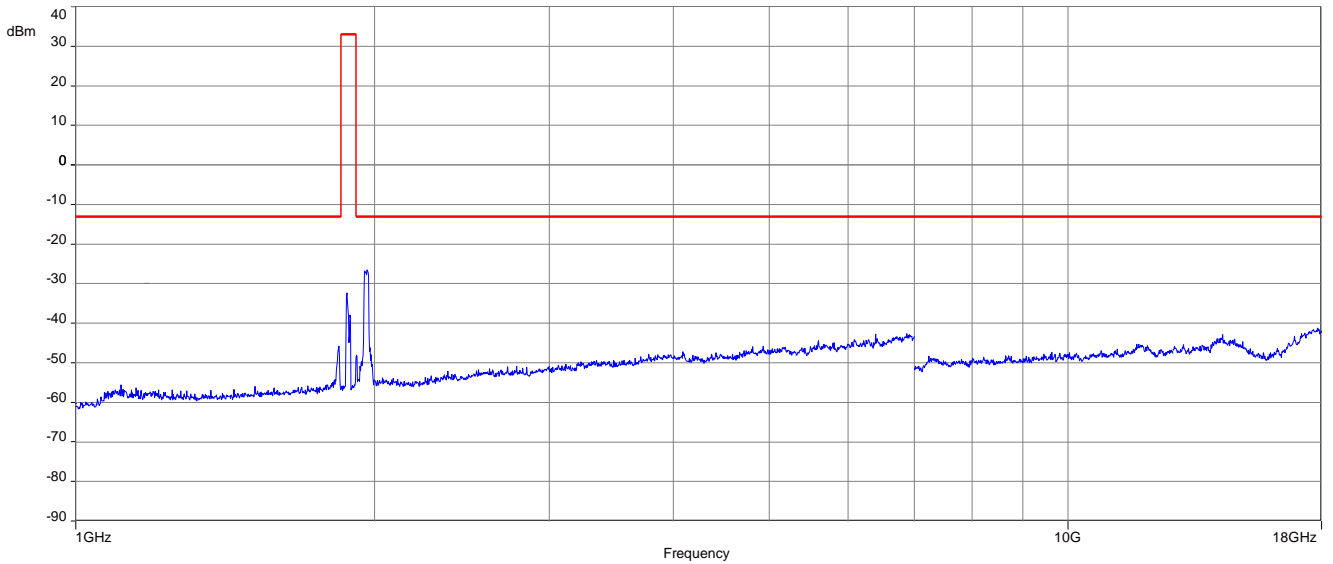

Plot 20: 256-QAM - Middle channel (18 GHz – 26 GHz)

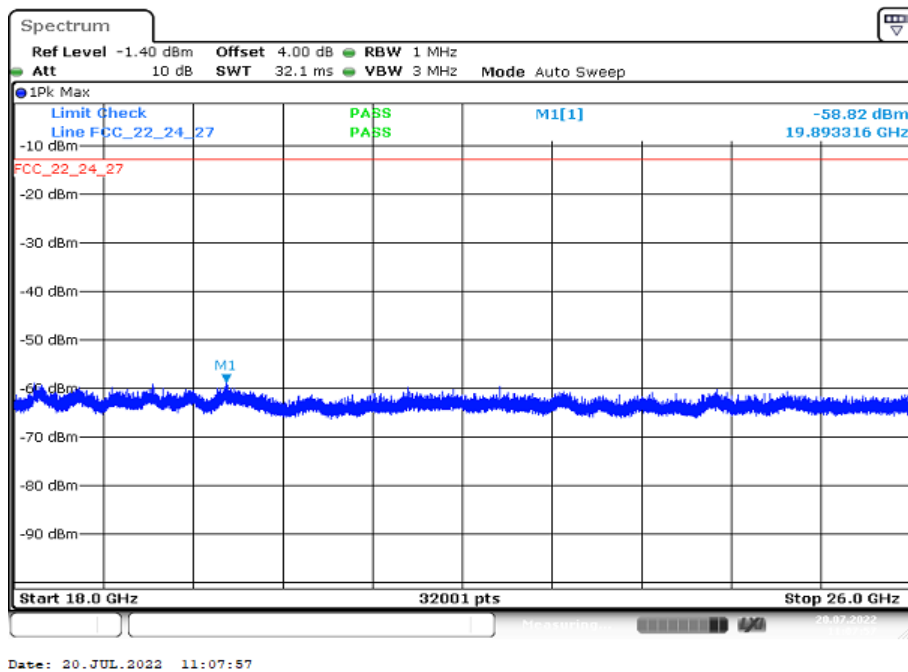

12.2.4 Spurious emissions conducted

Description:

The following steps outline the procedure used to measure the conducted emissions from the mobile station.

1. Determine frequency range for measurements: From § 2.1057 the spectrum should be investigated from the lowest radio frequency generated in the equipment up to at least the 10th harmonic of the carrier frequency.
2. Determine mobile station transmits frequencies: below outlines the band edge frequencies pertinent to conducted emissions testing.

Measurement:

Measurement parameters	
Detector:	Peak
Sweep time:	Auto
Video bandwidth:	300 kHz
Resolution bandwidth:	100 kHz
Span:	30 MHz – 19.5 GHz
Trace-Mode:	Max Hold
Used equipment:	See chapter 8.4 setup A
Measurement uncertainty:	see chapter 9
Measurement procedure	FCC: § 2.1051

Limits:

FCC
§ 24.238 (a) & (b)
<p>(a) The power of any emission outside of the authorized operating frequency ranges must be attenuated below the transmitting power (P) by a factor of at least 43 + 10 log(P) dB.</p> <p>(b) Compliance with these rules is based on the use of measurement instrumentation employing a resolution bandwidth of 1 MHz or greater. However, in the 1 MHz bands immediately outside and adjacent to the frequency block a resolution bandwidth of at least one percent of the emission bandwidth of the fundamental emission of the transmitter may be employed. A narrower resolution bandwidth is permitted in all cases to improve measurement accuracy provided the measured power is integrated over the full required measurement bandwidth (i.e. 1 MHz or 1 percent of emission bandwidth, as specified). The emission bandwidth is defined as the width of the signal between two points, one below the carrier center frequency and one above the carrier center frequency, outside of which all emissions are attenuated at least 26 dB below the transmitter power.</p>
-13 dBm

Results:

BPSK:

Spurious Emission Level					
Lowest channel		Middle channel		Highest channel	
Spurious emissions	Level [dBm]	Spurious emissions	Level [dBm]	Spurious emissions	Level [dBm]
-/-		-/-		-/-	

QPSK:

Spurious Emission Level					
Lowest channel		Middle channel		Highest channel	
Spurious emissions	Level [dBm]	Spurious emissions	Level [dBm]	Spurious emissions	Level [dBm]
-/-		-/-		-/-	

16-QAM:

Spurious Emission Level					
Lowest channel		Middle channel		Highest channel	
Spurious emissions	Level [dBm]	Spurious emissions	Level [dBm]	Spurious emissions	Level [dBm]
-/-		-/-		-/-	

64-QAM:

Spurious Emission Level					
Lowest channel		Middle channel		Highest channel	
Spurious emissions	Level [dBm]	Spurious emissions	Level [dBm]	Spurious emissions	Level [dBm]
-/-		-/-		-/-	

256-QAM:

Spurious Emission Level					
Lowest channel		Middle channel		Highest channel	
Spurious emissions	Level [dBm]	Spurious emissions	Level [dBm]	Spurious emissions	Level [dBm]
-/-		-/-		-/-	

12.2.5 Block edge compliance

Description:

The spectrum at the band edges must comply with the spurious emissions limits.

Measurement:

Measurement parameters	
Detector:	RMS
Sweep time:	30 sec.
Video bandwidth:	See plots
Resolution bandwidth:	See plots
Span:	1 MHz steps
Trace-Mode:	Max Hold
Used equipment:	See chapter 8.4 setup A
Measurement uncertainty:	See chapter 9
Measurement procedure	FCC: § 2.1051

Limits:

FCC
§ 24.238 (a) & (b)
(a) The power of any emission outside of the authorized operating frequency ranges must be attenuated below the transmitting power (P) by a factor of at least 43 + 10 log(P) dB . (b) Compliance with these rules is based on the use of measurement instrumentation employing a resolution bandwidth of 1 MHz or greater. However, in the 1 MHz bands immediately outside and adjacent to the frequency block a resolution bandwidth of at least one percent of the emission bandwidth of the fundamental emission of the transmitter may be employed. A narrower resolution bandwidth is permitted in all cases to improve measurement accuracy provided the measured power is integrated over the full required measurement bandwidth (i.e. 1 MHz or 1 percent of emission bandwidth, as specified). The emission bandwidth is defined as the width of the signal between two points, one below the carrier center frequency and one above the carrier center frequency, outside of which all emissions are attenuated at least 26 dB below the transmitter power.
-13 dBm
Correction factor according to KDB 890810 if RBW < 1 % emission bandwidth: <input checked="" type="checkbox"/> N/A here <input type="checkbox"/> $10 \log (RBW1/RBW2) = X \text{ dB}$; whereas: $RBW1 = Y, RBW2 = Z$

Results: See log files.

12.2.6 Occupied bandwidth

Description:

Measurement of the occupied bandwidth of the transmitted signal.

Measurement:

Similar to conducted emissions, occupied bandwidth measurements are only provided for selected frequencies in order to reduce the amount of submitted data. Data were taken at the extreme and mid frequencies of the 5G NR band 25 frequency band. The table below lists the measured 99% power and -26dBc occupied bandwidths. Spectrum analyzer plots are included on the following pages.

Measurement parameters	
Detector:	Peak
Sweep time:	180s
Video bandwidth:	100 kHz
Resolution bandwidth:	30 kHz
Span:	2 x nominal bandwidth
Trace-Mode:	Max Hold
Used equipment:	See chapter 8.4 setup A
Measurement uncertainty:	See chapter 9
Measurement procedure	FCC: § 2.1049

Limits:

FCC
§ 2.1049
Reporting only

Results:

Occupied Bandwidth – BPSK			
Bandwidth	Channel	99% OBW (kHz)	-26 dBc BW (kHz)
5	low	4503.0	5209.0
	mid	4526.0	5271.0
	high	4511.0	5306.0
10	low	9016.0	9975.0
	mid	8991.0	9850.0
	high	8991.0	9875.0
15	low	13524.0	14513.0
	mid	13487.0	14625.0
	high	13524.0	14625.0
20	low	18088.2	19350.0
	mid	18032.0	19400.0
	high	18032.0	19400.0
30	low	28696	30150
	mid	28696	30225
	high	28696	30225
40	low	38861	41100
	mid	38661	41000
	high	38761	41100

Occupied Bandwidth – QPSK			
Bandwidth	Channel	99% OBW (kHz)	-26 dBc BW (kHz)
5	low	4516.0	5296.0
	mid	4496.0	5171.0
	high	4511.0	5219.0
10	low	9016.0	10025.0
	mid	9016.0	9875.0
	high	9016.0	9925.0
15	low	13599.0	14625.0
	mid	13599.0	14513.0
	high	13599.0	14550.0
20	low	17982.0	19350.0
	mid	17982.0	19450.0
	high	17982.0	19300.0
30	low	28696	30150
	mid	28621	30225
	high	28621	30000
40	low	38861	41200
	mid	38961	41300
	high	38861	41300

Occupied Bandwidth – 16-QAM			
Bandwidth	Channel	99% OBW (kHz)	-26 dBc BW (kHz)
5	low	4503.0	5222.0
	mid	4493.0	5246.0
	high	4488.0	5070.0
10	low	9016.0	9900.0
	mid	9106.0	9875.0
	high	9016.0	9850.0
15	low	13524.0	14625.0
	mid	13524.0	14588.0
	high	13524.0	14625.0
20	low	18132.0	19400.0
	mid	18082.0	19500.0
	high	18082.0	19550.0
30	low	28621	30000
	mid	28621	30150
	high	28546	30000
40	low	38761	41300
	mid	38761	41300
	high	38861	41300

Occupied Bandwidth – 64-QAM			
Bandwidth	Channel	99% OBW (kHz)	-26 dBc BW (kHz)
5	low	4518.0	5253.0
	mid	4522.0	5250.0
	high	4533.0	5285.0
10	low	8991.0	9900.0
	mid	8991.0	9950.0
	high	9016.0	9950.0
15	low	13487.0	14625.0
	mid	13487.0	14625.0
	high	13487.0	14662.0
20	low	18032.0	19400.0
	mid	17982.0	19400.0
	high	17982.0	19400.0
30	low	28621	30100
	mid	28696	30200
	high	28546	30100
40	low	38761	41000
	mid	38661	41000
	high	38761	41200

Occupied Bandwidth – 256-QAM			
Bandwidth	Channel	99% OBW (MHz)	-26 dBc BW (MHz)
5	low	4.5	5.2
	mid	4.5	5.1
	high	4.5	5.2
10	low	9.0	9.8
	mid	9.0	9.9
	high	9.0	10.0
15	low	13.5	14.7
	mid	13.5	14.6
	high	13.5	14.6
20	low	18.0	19.3
	mid	18.0	19.3
	high	18.0	19.3
30	low	28.6	30.2
	mid	28.6	30.1
	high	28.5	30.2
40	low	38.9	41.1
	mid	38.9	41.2
	high	39.0	41.1

13 Glossary

EUT	Equipment under test
DUT	Device under test
UUT	Unit under test
GUE	GNSS User Equipment
ETSI	European Telecommunications Standards Institute
EN	European Standard
FCC	Federal Communications Commission
FCC ID	Company Identifier at FCC
IC	Industry Canada
PMN	Product marketing name
HMN	Host marketing name
HVIN	Hardware version identification number
FVIN	Firmware version identification number
EMC	Electromagnetic Compatibility
HW	Hardware
SW	Software
Inv. No.	Inventory number
S/N or SN	Serial number
C	Compliant
NC	Not compliant
NA	Not applicable
NP	Not performed
PP	Positive peak
QP	Quasi peak
AVG	Average
OC	Operating channel
OCW	Operating channel bandwidth
OBW	Occupied bandwidth
OOB	Out of band
DFS	Dynamic frequency selection
CAC	Channel availability check
OP	Occupancy period
NOP	Non occupancy period
DC	Duty cycle
PER	Packet error rate
CW	Clean wave
MC	Modulated carrier
WLAN	Wireless local area network
RLAN	Radio local area network
DSSS	Dynamic sequence spread spectrum
OFDM	Orthogonal frequency division multiplexing
FHSS	Frequency hopping spread spectrum
GNSS	Global Navigation Satellite System
C/N₀	Carrier to noise-density ratio, expressed in dB-Hz

14 Document history

Version	Applied changes	Date of release
-/-	Initial release	2022-07-28

15 Accreditation Certificate – D-PL-12076-01-05

first page	last page
 <p>The first page of the accreditation certificate includes the DAKKS logo, the name 'Deutsche Akkreditierungsstelle GmbH', and accreditation details for 'CTC advanced GmbH' in Saarbrücken. It also features a signature of the Head of Division and the registration number D-PL-12076-01-05.</p>	 <p>The last page contains legal disclaimers regarding the publication of extracts, accreditation details for three offices (Berlin, Frankfurt am Main, and Braunschweig), and website information for EA, ILAC, and IAF.</p>

Note: The current certificate annex is published on the websites (link see below).

<https://www.dakks.de/files/data/as/pdf/D-PL-12076-01-05e.pdf>

or

https://ctcadvanced.com/app/uploads/2020/06/D-PL-12076-01-05_TCB_USA.pdf

END OF TEST REPORT