

## TEST REPORT

Test report no.: 1-3977/22-01-07

BNNetzA-CAB-02/21-102

### Testing laboratory

**CTC advanced GmbH**

Untertuerkheimer Strasse 6 – 10

66117 Saarbruecken / Germany

Phone: + 49 681 5 98 - 0

Fax: + 49 681 5 98 - 9075

Internet: <https://www.ctcadvanced.com>

e-mail: [mail@ctcadvanced.com](mailto:mail@ctcadvanced.com)

**Accredited Testing Laboratory:**

The testing laboratory (area of testing) is accredited according to DIN EN ISO/IEC 17025 (2018-03) by the Deutsche Akkreditierungsstelle GmbH (DAkkS)

The accreditation is valid for the scope of testing procedures as stated in the accreditation certificate starting with the registration number: D-PL-12076-01.

### Applicant

**SAGEMCOM BROADBAND SAS**

250, route de l' Empereur

92848 Rueil-Malmaison Cedex / FRANCE

Phone: -/-

Contact: Ludovic Bomba

e-mail: [ludovic.bomba-ext@sagemcom.com](mailto:ludovic.bomba-ext@sagemcom.com)

### Manufacturer

**SAGEMCOM BROADBAND SAS**

250, route de l' Empereur

92848 Rueil-Malmaison Cedex / FRANCE

### Test standard/s

FCC - Title 47 CFR Part 15      FCC - Title 47 of the Code of Federal Regulations; Chapter I; Part 15 - Radio frequency devices

For further applied test standards please refer to section 3 of this test report.

### Test Item

**Kind of test item:**                      **Gateway**

**Model name:**                              **F5688W**

**FCC ID:**                                      **VW3FAST5688W**

**Frequency:**                                UNII bands: 5150 MHz to 5250 MHz; 5250 MHz to 5350 MHz; 5470 MHz to 5725 MHz

**Technology tested:**                      **WLAN**

**Antenna:**                                    **4 integrated antennas**

**Power supply:**                            **120 V AC by power supply unit**

**Temperature range:**                      **0°C to +50°C**

This test report is electronically signed and valid without handwritten signature. For verification of the electronic signatures, the public keys can be requested at the testing laboratory.

### Test report authorized:

Marco Bertolino  
Lab Manager  
Radio Communications

### Test performed:

Michael Dorongovski  
Lab Manager  
Radio Communications

## 1 Table of contents

1	Table of contents .....	2
2	General information .....	4
2.1	Notes and disclaimer .....	4
2.2	Application details .....	4
2.3	Test laboratories sub-contracted .....	4
3	Test standard/s, references and accreditations .....	5
4	Reporting statements of conformity – decision rule .....	6
5	Test environment .....	7
6	Test item .....	7
6.1	General description .....	7
6.2	Additional information .....	7
7	Description of the test setup.....	8
7.1	Shielded semi anechoic chamber .....	9
7.2	Shielded fully anechoic chamber.....	10
7.3	Radiated measurements > 18 GHz.....	12
7.4	Conducted measurements .....	13
7.5	AC conducted .....	14
8	Sequence of testing .....	15
8.1	Sequence of testing radiated spurious 9 kHz to 30 MHz .....	15
8.2	Sequence of testing radiated spurious 30 MHz to 1 GHz .....	16
8.3	Sequence of testing radiated spurious 1 GHz to 18 GHz .....	17
8.4	Sequence of testing radiated spurious above 18 GHz .....	18
9	Measurement uncertainty .....	19
10	Summary of measurement results .....	20
11	Additional comments.....	21
12	Measurement results .....	24
12.1	Identify worst case data rate .....	24
12.2	Antenna gain.....	24
12.3	Duty cycle .....	24
12.4	Maximum output power.....	25
12.5	Power spectral density .....	27
12.6	Spectrum bandwidth / 26 dB bandwidth.....	29
12.7	Occupied bandwidth / 99% emission bandwidth .....	30
12.8	Band edge compliance radiated .....	31
12.9	Spurious emissions radiated below 30 MHz.....	35
12.10	Spurious emissions radiated 30 MHz to 1 GHz .....	37
12.11	Spurious emissions radiated 1 GHz to 40 GHz .....	40
12.12	Spurious emissions conducted < 30 MHz.....	44
13	Glossary .....	47
14	Document history.....	48

15      **Accreditation Certificate – D-PL-12076-01-05** .....49

## 2 General information

### 2.1 Notes and disclaimer

The test results of this test report relate exclusively to the test item specified in this test report. CTC advanced GmbH does not assume responsibility for any conclusions and generalizations drawn from the test results with regard to other specimens or samples of the type of the equipment represented by the test item.

The test report may only be reproduced or published in full. Reproduction or publication of extracts from the report requires the prior written approval of CTC advanced GmbH.

The testing service provided by CTC advanced GmbH has been rendered under the current "General Terms and Conditions for CTC advanced GmbH".

CTC advanced GmbH will not be liable for any loss or damage resulting from false, inaccurate, inappropriate or incomplete product information provided by the customer.

Under no circumstances does the CTC advanced GmbH test report include any endorsement or warranty regarding the functionality, quality or performance of any other product or service provided.

Under no circumstances does the CTC advanced GmbH test report include or imply any product or service warranties from CTC advanced GmbH, including, without limitation, any implied warranties of merchantability, fitness for purpose, or non-infringement, all of which are expressly disclaimed by CTC advanced GmbH.

All rights and remedies regarding vendor's products and services for which CTC advanced GmbH has prepared this test report shall be provided by the party offering such products or services and not by CTC advanced GmbH. In no case this test report can be considered as a Letter of Approval.

This test report is electronically signed and valid without handwritten signature. For verification of the electronic signatures, the public keys can be requested at the testing laboratory.

### 2.2 Application details

Date of receipt of order: 2022-02-08

Date of receipt of test item: 2022-02-16

Start of test:\* 2022-02-21

End of test:\* 2022-04-11

Person(s) present during the test: -/-

\*Date of each measurement, if not shown in the plot, can be requested. Dates are stored in the measurement software.



### 2.3 Test laboratories sub-contracted

None

### 3 Test standard/s, references and accreditations

Test standard	Date	Description
FCC - Title 47 CFR Part 15		FCC - Title 47 of the Code of Federal Regulations; Chapter I; Part 15 - Radio frequency devices

Guidance	Version	Description
KDB 789033 D02	v02r01	Guidelines for Compliance Testing of Unlicensed National Information Infrastructure (U-NII) Devices - Part 15, Subpart E
ANSI C63.4-2014	-/-	American National Standard for Methods of Measurement of Radio-Noise Emissions from Low-Voltage Electrical and Electronic Equipment in the Range of 9 kHz to 40 GHz
ANSI C63.10-2013	-/-	American National Standard of Procedures for Compliance Testing of Unlicensed Wireless Devices
KDB 662911 D01	v02r01	Emissions Testing of Transmitters with Multiple Outputs in the Same Band

Accreditation	Description	
D-PL-12076-01-04	Telecommunication and EMC Canada <a href="https://www.dakks.de/as/ast/d/D-PL-12076-01-04e.pdf">https://www.dakks.de/as/ast/d/D-PL-12076-01-04e.pdf</a>	 
D-PL-12076-01-05	Telecommunication FCC requirements <a href="https://www.dakks.de/as/ast/d/D-PL-12076-01-05e.pdf">https://www.dakks.de/as/ast/d/D-PL-12076-01-05e.pdf</a>	 

FCC designation number: DE0002

#### 4 Reporting statements of conformity – decision rule

Only the measured values related to their corresponding limits will be used to decide whether the equipment under test meets the requirements of the test standards listed in chapter 3.

The measurement uncertainty is mentioned in this test report, see chapter 9, but is not taken into account - neither to the limits nor to the measurement results. Measurement results with a smaller margin to the corresponding limits than the measurement uncertainty have a potential risk of more than 5% that the decision might be wrong."

measured value, measurement uncertainty, verdict

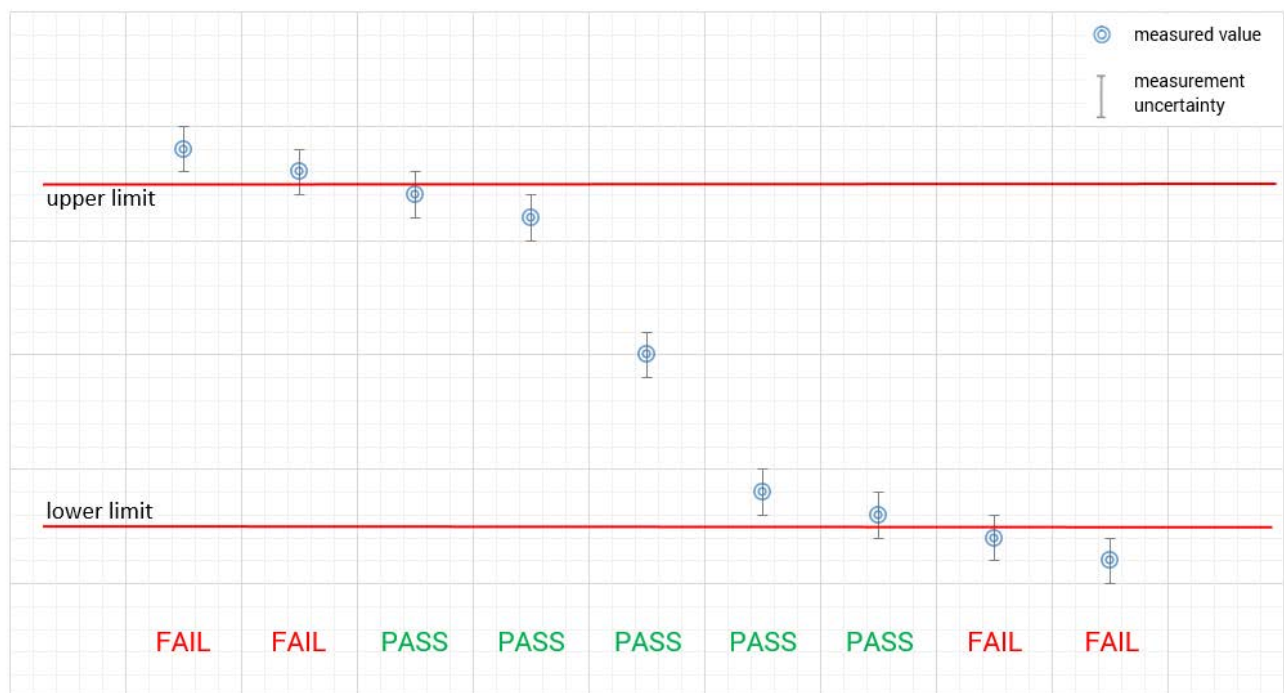

## 5 Test environment

Temperature	:	$T_{nom}$ $T_{max}$ $T_{min}$	+22 °C during room temperature tests No tests under extreme environmental conditions required. No tests under extreme environmental conditions required.
Relative humidity content	:		45 %
Barometric pressure	:		1021 hpa
Power supply	:	$V_{nom}$ $V_{max}$ $V_{min}$	120 V AC by power supply unit No tests under extreme environmental conditions required. No tests under extreme environmental conditions required.

## 6 Test item

### 6.1 General description

Kind of test item	:	Gateway
Model name	:	F5688W
S/N serial number	:	Rad. DM2202059000016 Cond. DM2201959000008
Hardware status	:	V1.0
Software status	:	NA
Firmware status	:	NA
Frequency band	:	UNII bands: 5150 MHz to 5250 MHz; 5250 MHz to 5350 MHz; 5470 MHz to 5725 MHz
Type of radio transmission	:	OFDM
Use of frequency spectrum	:	
Type of modulation	:	CCK, (D)BPSK, (D)QPSK, 16 – QAM, 64 – QAM, 256 – QAM
Number of channels	:	2 with 160 MHz bandwidth
Antenna	:	4 integrated antennas
Power supply	:	120 V AC by power supply unit
Temperature range	:	0°C to +50°C

### 6.2 Additional information

The content of the following annexes is defined in the QA. It may be that not all of the listed annexes are necessary for this report, thus some values in between may be missing.

Test setup and EUT photos are included in test report:

- 1-3977/22-01-01\_AnnexA
- 1-3977/22-01-01\_AnnexB
- 1-3977/22-01-01\_AnnexD

## 7 Description of the test setup

Typically, the calibrations of the test apparatus are commissioned to and performed by an accredited calibration laboratory. The calibration intervals are determined in accordance with the DIN EN ISO/IEC 17025. In addition to the external calibrations, the laboratory executes comparison measurements with other calibrated test systems or effective verifications. Weekly chamber inspections and range calibrations are performed. Where possible, RF generating and signaling equipment as well as measuring receivers and analyzers are connected to an external high-precision 10 MHz reference (GPS-based or rubidium frequency standard).

In order to simplify the identification of the equipment used at some special tests, some items of test equipment and ancillaries can be provided with an identifier or number in the equipment list below (Lab/Item).

### **Agenda:** Kind of Calibration

k	calibration / calibrated	EK	limited calibration
ne	not required (k, ev, izw, zw not required)	zw	cyclical maintenance (external cyclical maintenance)
ev	periodic self verification	izw	internal cyclical maintenance
Ve	long-term stability recognized	g	blocked for accredited testing
vlk!	Attention: extended calibration interval		
NK!	Attention: not calibrated	*)	next calibration ordered / currently in progress



## 7.1 Shielded semi anechoic chamber

The radiated measurements are performed in vertical and horizontal plane in the frequency range from 30 MHz to 1 GHz in semi-anechoic chambers. The EUT is positioned on a non-conductive support with a height of 0.80 m above a conductive ground plane that covers the whole chamber. The receiving antennas are conform to specifications ANSI C63. These antennas can be moved over the height range between 1.0 m and 4.0 m in order to search for maximum field strength emitted from EUT. The measurement distances between EUT and receiving antennas are indicated in the test setups for the various frequency ranges. For each measurement, the EUT is rotated in all three axes until the maximum field strength is received. The wanted and unwanted emissions are received by spectrum analyzers where the detector modes and resolution bandwidths over various frequency ranges are set according to requirement ANSI C63.

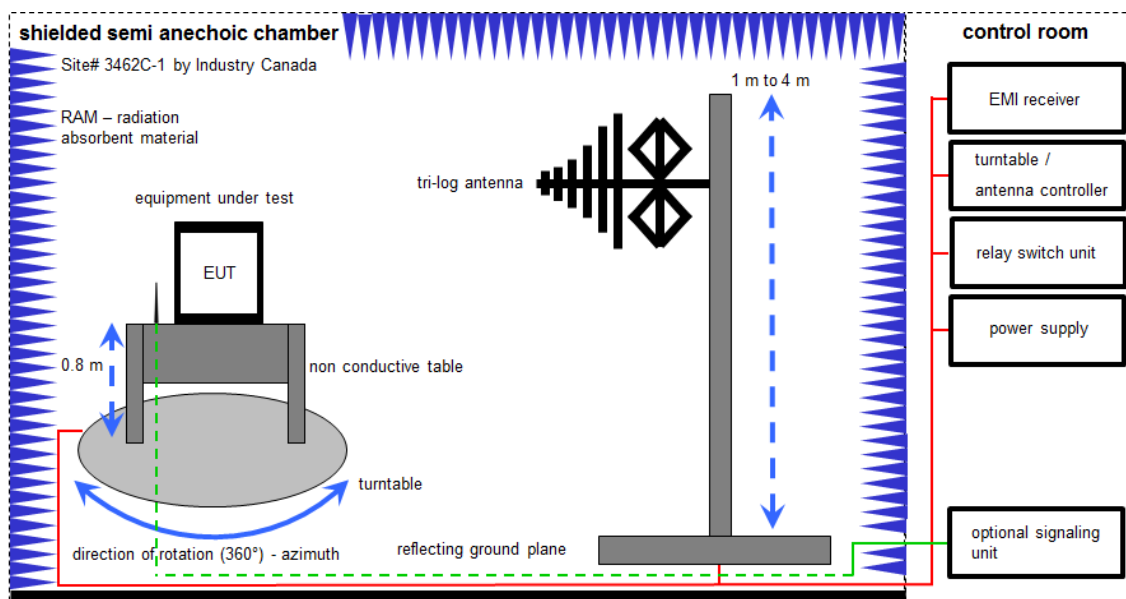

Measurement distance: tri-log antenna 10 meter; EMC32 software version: 10.59.00

$$FS = UR + CL + AF$$

(FS-field strength; UR-voltage at the receiver; CL-loss of the cable; AF-antenna factor)

Example calculation:

$$FS [dB\mu V/m] = 12.35 [dB\mu V/m] + 1.90 [dB] + 16.80 [dB/m] = 31.05 [dB\mu V/m] (35.69 \mu V/m)$$

### Equipment table:

No.	Lab / Item	Equipment	Type	Manufacturer	Serial No.	INV. No.	Kind of Calibration	Last Calibration	Next Calibration
1	A	Switch-Unit	3488A	HP	2719A14505	300000368	ev	-/-	-/-
2	A	Meßkabine 1	HF-Absorberhalle	MWB AG 300023	Batch no. 699714	300000551	ne	-/-	-/-
3	A	Antenna Tower	Model 2175	ETS-Lindgren	64762	300003745	izw	-/-	-/-
4	A	Positioning Controller	Model 2090	ETS-Lindgren	64672	300003746	izw	-/-	-/-
5	A	Turntable Interface-Box	Model 105637	ETS-Lindgren	44583	300003747	izw	-/-	-/-
6	A	TRILOG Broadband Test-Antenna 30 MHz - 3 GHz	VULB9163	Schwarzbeck Mess-Elektronik	295	300003787	vKI!	21.04.2021	20.04.2023
7	A	EMI Test Receiver	ESR3	Rohde & Schwarz	102587	300005771	k	10.12.2020	09.06.2022

## 7.2 Shielded fully anechoic chamber

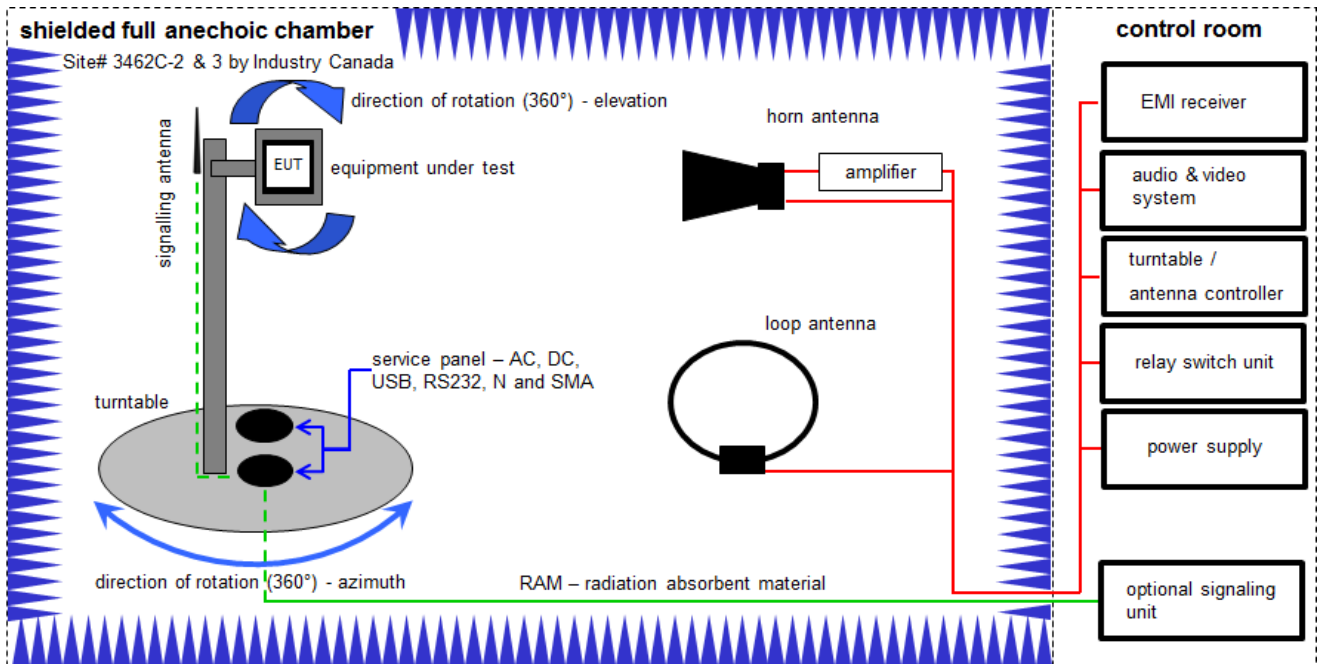

Measurement distance: horn antenna 3 meter; loop antenna 3 meter

$$FS = UR + CA + AF$$

(FS-field strength; UR-voltage at the receiver; CA-loss of the signal path; AF-antenna factor)

Example calculation:

$$FS [dB\mu V/m] = 40.0 [dB\mu V/m] + (-35.8) [dB] + 32.9 [dB/m] = 37.1 [dB\mu V/m] (71.61 \mu V/m)$$

### Equipment table:

No.	Setup	Equipment	Type	Manufacturer	Serial No.	INV. No.	Kind of Calibration	Last Calibration	Next Calibration
1	C	Active Loop Antenna 9 kHz to 30 MHz	6502	EMCO	2210	300001015	vKI!	01.07.2021	31.07.2023
2	A, B	Double-Ridged Waveguide Horn Antenna 1-18.0GHz	3115	EMCO	9107-3696	300001604	vKI!	12.03.2021	11.03.2023
3	A	Highpass Filter	WHKX7.0/18G-8SS	Wainwright	18	300003789	ne	-/-	-/-
4	A, B	Broadband Amplifier 0.5-18 GHz	CBLU5184540	CERNEK	22051	300004483	ev	-/-	-/-
5	A, B, C	4U RF Switch Platform	L4491A	Agilent Technologies	MY50000032	300004510	ne	-/-	-/-
6	A, B, C	Computer	Intel Core i3 3220/3,3 GHz, Prozessor		2V2403033A54 21	300004591	ne	-/-	-/-
7	A, B, C	NEXIO EMV-Software	BAT EMC V3.21.0.27	EMCO		300004682	ne	-/-	-/-
8	A, B, C	Anechoic chamber		TDK		300003726	ne	-/-	-/-
9	A, B, C	EMI Test Receiver 9kHz-26,5GHz	ESR26	Rohde & Schwarz	101376	300005063	k	15.12.2021	31.12.2022
10	A	Band Reject Filter	WRCJV12-5120-5150-5350-5380-40SS	Wainwright	5	300005168	ev	-/-	-/-
11	A	Band Reject Filter	WRCJV12-5695-5725-5850-5880-40SS	Wainwright	5	300005169	ev	-/-	-/-

12	A	Band Reject Filter	WRCJV16-5440-5470-5725-5755-40SS	Wainwright	9	300005170	ev	-/-	-/-
13	A, B	RF-Amplifier	AMF-6F06001800-30-10P-R	NARDA-MITEQ Inc	2011571	300005240	ev	-/-	-/-

### 7.3 Radiated measurements > 18 GHz

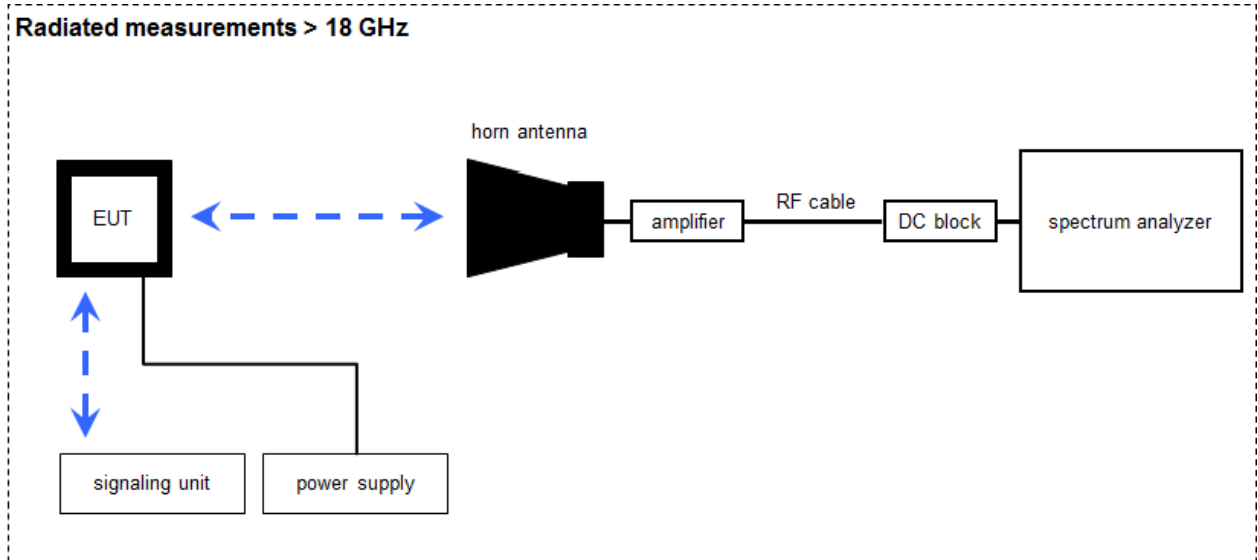

Measurement distance: horn antenna 50 cm

$$FS = UR + CA + AF$$

(FS-field strength; UR-voltage at the receiver; CA-loss signal path & distance correction; AF-antenna factor)

Example calculation:

$$FS [dB\mu V/m] = 40.0 [dB\mu V/m] + (-60.1) [dB] + 36.74 [dB/m] = 16.64 [dB\mu V/m] (6.79 \mu V/m)$$

#### Equipment table:

No.	Lab / Item	Equipment	Type	Manufacturer	Serial No.	INV. No.	Kind of Calibration	Last Calibration	Next Calibration
1	A	Microwave System Amplifier, 0.5-26.5 GHz	83017A	HP	00419	300002268	ev	-/-	-/-
2	A	Std. Gain Horn Antenna 18.0-26.5 GHz	638	Narda	01096	300000486	vKI!	17.01.2022	31.01.2024
3	A	Std. Gain Horn Antenna 26.5-40.0 GHz	V637	Narda	82-16	300000510	vKI!	17.01.2022	31.01.2024
4	A	Broadband Low Noise Amplifier 18-50 GHz	CBL18503070-XX	CERNEX	19338	300004273	ev	-/-	-/-
5	A	RF-Cable	ST18/SMAM/SMAM/48	Huber & Suhner	Batch no. 600918	400001182	ev	-/-	-/-
6	A	Signal Analyzer 40 GHz	FSV40	R&S	101042	300004517	k	25.01.2022	31.01.2023

## 7.4 Conducted measurements

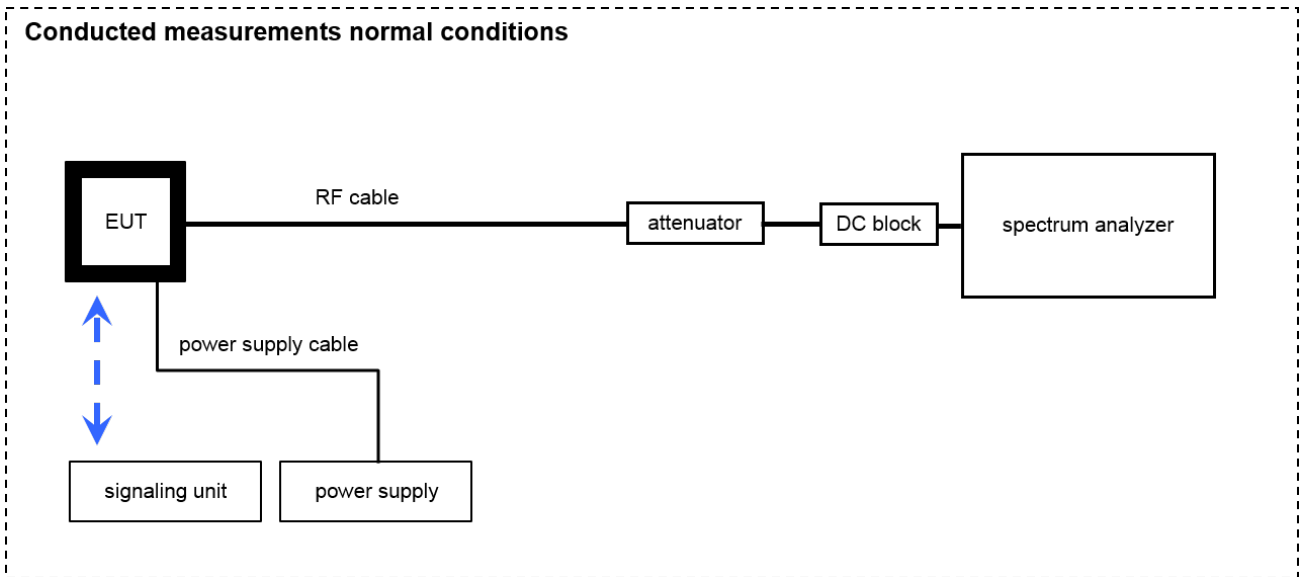

OP = AV + CA  
(OP-output power; AV-analyzer value; CA-loss signal path)

Example calculation:

OP [dBm] = 6.0 [dBm] + 11.7 [dB] = 17.7 [dBm] (58.88 mW)

**Equipment table:**

No.	Setup	Equipment	Type	Manufacturer	Serial No.	INV. No.	Kind of Calibration	Last Calibration	Next Calibration
1	A	Hygro-Thermometer	-/, 5-45°C, 20-100%rF	Thies Klima	-/	400000109	ev	13.08.2020	12.08.2022
2	A	USB/GPIB interface	82357B	Agilent Technologies	MY52103346	300004390	ne	-/	-/
3	A	PC Laboratory	Exone	Fröhlich + Walter	S2642279-03 / 10	300004179	ne	-/	-/
4	A	Signal analyzer	FSV30	Rohde&Schwarz	1321.3008K30/103809	300005359	vIKI!	08.12.2020	07.12.2022
5	A	Tester Software RadioStar (C.BER2 for BT Conformance)	Version 1.0.0.X	CTC advanced GmbH	0001	400001380	ne	-/	-/

## 7.5 AC conducted

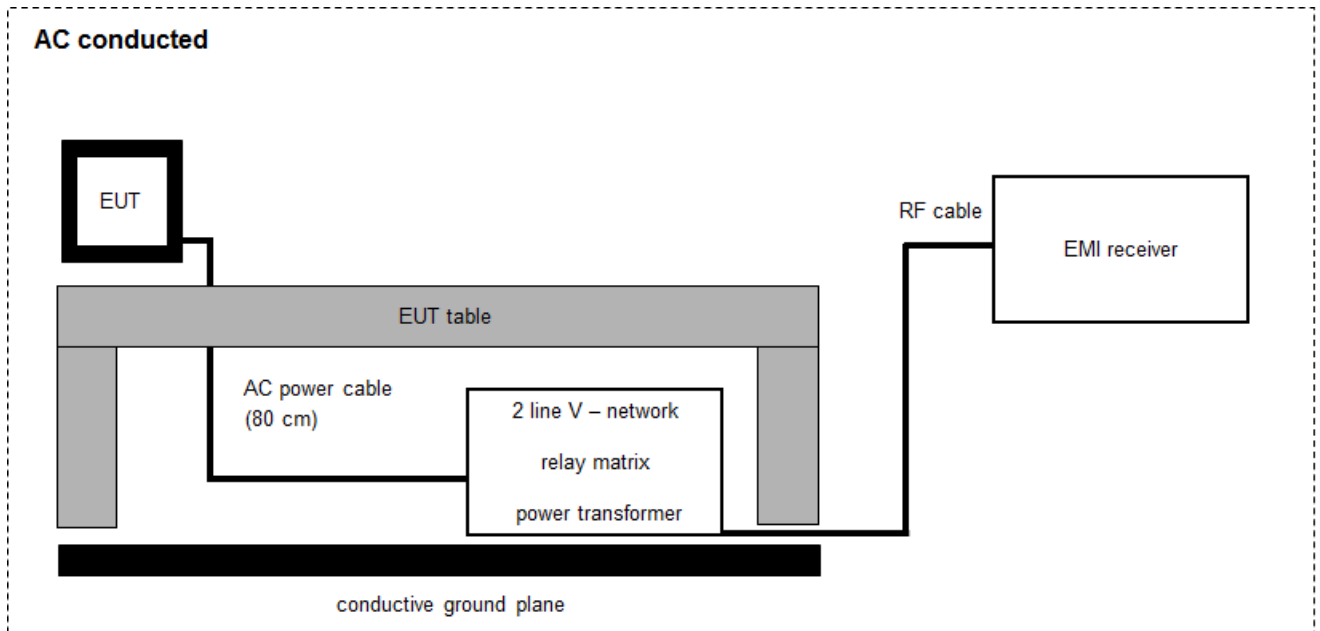

$$FS = UR + CF + VC$$

(FS-field strength; UR-voltage at the receiver; CR-loss of the cable and filter; VC-correction factor of the ISN)

Example calculation:

$$FS [dB\mu V/m] = 37.62 [dB\mu V/m] + 9.90 [dB] + 0.23 [dB] = 47.75 [dB\mu V/m] (244.06 \mu V/m)$$

**Equipment table:**

No.	Setup	Equipment	Type	Manufacturer	Serial No.	INV. No.	Kind of Calibration	Last Calibration	Next Calibration
1	A	Two-line V-Network (LISN) 9 kHz to 30 MHz	ESH3-Z5	Rohde & Schwarz	892475/017	300002209	vKI!	14.12.2021	13.12.2023
2	A	RF-Filter-section	85420E	HP	3427A00162	300002214	NK!	-/-	-/-
3	A	EMI Test Receiver	ESCI 3	R&S	100083	300003312	k	09.12.2021	08.12.2022
4	A	Analyzer-Reference-System (Harmonics and Flicker)	ARS 16/1	SPS	A3509 07/0 0205	300003314	vKI!	29.12.2021	28.12.2023
5	A	Hochpass 150 kHz	EZ-25	R&S	100010	300003798	ev	-/-	-/-
6	A	PC	TecLine	F+W		300003532	ne	-/-	-/-
7	A	Switch-Unit	3488A	HP	2719A14505	300000368	ev	-/-	-/-

## 8 Sequence of testing

### 8.1 Sequence of testing radiated spurious 9 kHz to 30 MHz

#### Setup

- The equipment is set up to simulate normal operation mode as described in the user manual or defined by the manufacturer.
- If the EUT is a tabletop system, it is placed on a table with 0.8 m height.
- If the EUT is a floor standing device, it is placed directly on the turn table.
- Auxiliary equipment and cables are positioned to simulate normal operation conditions as described in ANSI C 63.4.
- The AC power port of the EUT (if available) is connected to a power outlet below the turntable.
- Measurement distance is 3 m (see ANSI C 63.4) – see test details.
- EUT is set into operation.

#### Premeasurement\*

- The turntable rotates from 0° to 315° using 45° steps.
- The antenna height is 1 m.
- At each turntable position the analyzer sweeps with positive-peak detector to find the maximum of all emissions.

#### Final measurement

- Identified emissions during the pre-measurement are maximized by the software by rotating the turntable from 0° to 360°.
- Loop antenna is rotated about its vertical axis for maximum response at each azimuth about the EUT. (For certain applications, the loop antenna plane may also need to be positioned horizontally at the specified distance from the EUT)
- The final measurement is done in the position (turntable and elevation) causing the highest emissions with quasi-peak (as described in ANSI C 63.4).
- Final levels, frequency, measuring time, bandwidth, turntable position, correction factor, margin to the limit and limit will be recorded. A plot with the graph of the premeasurement and the limit is stored.

\*Note: The sequence will be repeated three times with different EUT orientations.

## 8.2 Sequence of testing radiated spurious 30 MHz to 1 GHz

### Setup

- The equipment is set up to simulate normal operation mode as described in the user manual or defined by the manufacturer.
- If the EUT is a tabletop system, a table with 0.8 m height is used, which is placed on the ground plane.
- If the EUT is a floor standing device, it is placed on the ground plane with insulation between both.
- Auxiliary equipment and cables are positioned to simulate normal operation conditions as described in ANSI C 63.4.
- The AC power port of the EUT (if available) is connected to a power outlet below the turntable.
- Measurement distance is 10 m or 3 m (see ANSI C 63.4) – see test details.
- EUT is set into operation.

### Premeasurement

- The turntable rotates from 0° to 315° using 45° steps.
- The antenna is polarized vertical and horizontal.
- The antenna height changes from 1 m to 3 m.
- At each turntable position, antenna polarization and height the analyzer sweeps three times in peak to find the maximum of all emissions.

### Final measurement

- The final measurement is performed for at least six highest peaks according to the requirements of the ANSI C63.4.
- Based on antenna and turntable positions at which the peak values are measured the software maximize the peaks by changing turntable position  $\pm 45^\circ$  and antenna height between 1 and 4 m.
- The final measurement is done with quasi-peak detector (as described in ANSI C 63.4).
- Final levels, frequency, measuring time, bandwidth, antenna height, antenna polarization, turntable angle, correction factor, margin to the limit and limit are recorded. A plot with the graph of the premeasurement with marked maximum final results and the limit is stored.



### 8.3 Sequence of testing radiated spurious 1 GHz to 18 GHz

#### Setup

- The equipment is set up to simulate normal operation mode as described in the user manual or defined by the manufacturer.
- If the EUT is a tabletop system, a 2-axis positioner with 1.5 m height is used.
- If the EUT is a floor standing device, it is placed directly on the turn table.
- Auxiliary equipment and cables are positioned to simulate normal operation conditions as described in ANSI C 63.4.
- The AC power port of the EUT (if available) is connected to a power outlet below the turntable.
- Measurement distance is 3 m (see ANSI C 63.4) – see test details.
- EUT is set into operation.

#### Premeasurement

- The turntable rotates from 0° to 315° using 45° steps.
- The antenna is polarized vertical and horizontal.
- The antenna height is 1.5 m.
- At each turntable position and antenna polarization the analyzer sweeps with positive peak detector to find the maximum of all emissions.

#### Final measurement

- The final measurement is performed for at least six highest peaks according to the requirements of the ANSI C63.4.
- Based on antenna and turntable positions at which the peak values are measured the software maximizes the peaks by rotating the turntable from 0° to 360°. This measurement is repeated for different EUT-table positions (0° to 150° in 30°-steps) and for both antenna polarizations.
- The final measurement is done in the position (turntable, EUT-table and antenna polarization) causing the highest emissions with Peak and RMS detector (as described in ANSI C 63.4).
- Final levels, frequency, measuring time, bandwidth, turntable position, EUT-table position, antenna polarization, correction factor, margin to the limit and limit are recorded. A plot with the graph of the premeasurement with marked maximum final results and the limit is stored.

## 8.4 Sequence of testing radiated spurious above 18 GHz

### Setup

- The equipment is set up to simulate normal operation mode as described in the user manual or defined by the manufacturer.
- Auxiliary equipment and cables are positioned to simulate normal operation conditions as described in ANSI C 63.4.
- The AC power port of the EUT (if available) is connected to a power outlet.
- The measurement distance is as appropriate (e.g. 0.5 m).
- The EUT is set into operation.

### Premeasurement

- The test antenna is handheld and moved carefully over the EUT to cover the EUT's whole sphere and different polarizations of the antenna.

### Final measurement

- The final measurement is performed at the position and antenna orientation causing the highest emissions with Peak and RMS detector (as described in ANSI C 63.4).
- Final levels, frequency, measuring time, bandwidth, correction factor, margin to the limit and limit are recorded. A plot with the graph of the premeasurement and the limit is stored.

## 9 Measurement uncertainty

Measurement uncertainty		
Test case	Uncertainty	
Antenna gain	± 3 dB	
Power spectral density	± 1.56 dB	
DTS bandwidth	± 100 kHz (depends on the used RBW)	
Occupied bandwidth	± 100 kHz (depends on the used RBW)	
Maximum output power conducted	± 1.56 dB	
Detailed spurious emissions @ the band edge - conducted	± 1.56 dB	
Band edge compliance radiated	± 3 dB	
Spurious emissions conducted	> 3.6 GHz	± 1.56 dB
	> 7 GHz	± 1.56 dB
	> 18 GHz	± 2.31 dB
	≥ 40 GHz	± 2.97 dB
Spurious emissions radiated below 30 MHz	± 3 dB	
Spurious emissions radiated 30 MHz to 1 GHz	± 3 dB	
Spurious emissions radiated 1 GHz to 12.75 GHz	± 3.7 dB	
Spurious emissions radiated above 12.75 GHz	± 4.5 dB	
Spurious emissions conducted below 30 MHz (AC conducted)	± 2.6 dB	

## 10 Summary of measurement results

<input type="checkbox"/>	No deviations from the technical specifications were ascertained
<input type="checkbox"/>	There were deviations from the technical specifications ascertained
<input checked="" type="checkbox"/>	This test report is only a partial test report. The content and verdict of the performed test cases are listed below.

TC Identifier	Description	Verdict	Date	Remark
RF-Testing	CFR Title 47 Part 15	See table	2022-07-28	-/-

Test specification clause	Test case	C	NC	NA	NP	Remark
-/-	Output power verification (cond.)	-/-				Declared
-/-	Antenna gain	-/-				Declared
U-NII Part 15	Duty cycle	-/-				-/-
§15.407(a)	Maximum output power	<input checked="" type="checkbox"/>	<input type="checkbox"/>	<input type="checkbox"/>	<input type="checkbox"/>	-/-
§15.407(a)	Power spectral density	<input checked="" type="checkbox"/>	<input type="checkbox"/>	<input type="checkbox"/>	<input type="checkbox"/>	-/-
§15.407(e)	Spectrum bandwidth 6dB bandwidth	<input checked="" type="checkbox"/>	<input type="checkbox"/>	<input type="checkbox"/>	<input type="checkbox"/>	-/-
§15.407(a)	Spectrum bandwidth 26dB bandwidth	<input checked="" type="checkbox"/>	<input type="checkbox"/>	<input type="checkbox"/>	<input type="checkbox"/>	-/-
§15.407(a)	Spectrum bandwidth 99% bandwidth	-/-				-/-
§15.205	Band edge compliance radiated	<input checked="" type="checkbox"/>	<input type="checkbox"/>	<input type="checkbox"/>	<input type="checkbox"/>	-/-
§15.407(b)	TX spurious emissions radiated	<input checked="" type="checkbox"/>	<input type="checkbox"/>	<input type="checkbox"/>	<input type="checkbox"/>	-/-
§15.209(a)	Spurious emissions radiated < 30 MHz	<input checked="" type="checkbox"/>	<input type="checkbox"/>	<input type="checkbox"/>	<input type="checkbox"/>	-/-
§15.107(a) §15.207	Spurious emissions conducted emissions< 30 MHz	<input checked="" type="checkbox"/>	<input type="checkbox"/>	<input type="checkbox"/>	<input type="checkbox"/>	-/-
§15.407	DFS	-/-				See report 1-3977/22-01-06

Notes:

<b>C:</b>	Compliant	<b>NC:</b>	Not compliant	<b>NA:</b>	Not applicable	<b>NP:</b>	Not performed
-----------	-----------	------------	---------------	------------	----------------	------------	---------------

## 11 Additional comments

- Reference documents: DFS report: 1-3977/22-01-06  
F5688W\_wifi\_certif\_FCC\_Ed02.xlsx  
Customer Questionnaire\_F5688W\_Sagemcom\_v3.docx  
F5866W Certification Radio Wi-Fi 5GHz (How To Do).pdf  
WifiCommands.pdf  
Annex list :  
1-3977\_22-01-05\_Annex\_MR\_A7.pdf (acVHT160-mode)  
1-3977\_22-01-05\_Annex\_MR\_A11.pdf (axHE160-mode)
- Special test descriptions: All tests were performed with the EUT transmitting on all ports/antennas simultaneously with >98% duty cycle.  
For 160 MHz modes the conducted tests were performed with a 2x2 splitter on two ports simultaneously.  
Note: This report is only for 160 MHz modes. For all other modes please see 1-test report no. 3977/22-01-05.
- Configuration descriptions: Supported modes:  
a-mode  
nHT20-mode  
nHT40-mode  
acVHT20-mode  
acVHT40-mode  
acVHT80-mode  
acVHT160-mode  
axHE20-mode  
axHE40-mode  
axHE80-mode  
axHE160-mode
- EUT selection:  Only one device available  
 Devices selected by the customer  
 Devices selected by the laboratory (Randomly)

Provided channels and used power settings for all modes:

acVHT160-mode:

U-NII-1 & U-NII-2A (5150 MHz to 5250 MHz & 5250 MHz to 5350 MHz) channel number & center frequency	
channel	<b>50</b>
f <sub>c</sub> / MHz	<b>5250</b>
Power setting	<b>36</b>

U-NII-2C (5470 MHz to 5725 MHz) channel number & center frequency	
channel	<b>114</b>
f <sub>c</sub> / MHz	<b>5570</b>
Power setting	<b>36</b>

axHE160-mode:

U-NII-1 & U-NII-2A (5150 MHz to 5250 MHz & 5250 MHz to 5350 MHz) channel number & center frequency	
channel	<b>50</b>
f <sub>c</sub> / MHz	<b>5250</b>
Power setting	<b>36</b>

U-NII-2C (5470 MHz to 5725 MHz) channel number & center frequency	
channel	<b>114</b>
f <sub>c</sub> / MHz	<b>5570</b>
Power setting	<b>36</b>

Note: The channels used for the tests were marked in bold in the list.

Test mode:

- No test mode available.  
Iperf is used to transmit data to a companion device
- Special software is used.  
EUT is transmitting pseudo random data by itself

Antennas and transmit operating modes:

- Operating mode 1 (single antenna)
  - Equipment with 1 antenna,
  - Equipment with 2 diversity antennas operating in switched diversity mode by which at any moment in time only 1 antenna is used,
  - Smart antenna system with 2 or more transmit/receive chains, but operating in a mode where only 1 transmit/receive chain is used)
- Operating mode 2 (multiple antennas, no beamforming)
  - Equipment operating in this mode contains a smart antenna system using two or more transmit/receive chains simultaneously but without beamforming.
- Operating mode 3 (multiple antennas, with beamforming)
  - Equipment operating in this mode contains a smart antenna system using two or more transmit/receive chains simultaneously with beamforming.  
In addition to the antenna assembly gain (G), the beamforming gain (Y) may have to be taken into account when performing the measurements.

## 12 Measurement results

### 12.1 Identify worst case data rate

Declared by manufacturer:

acVHT160/ax160: MCS0

### 12.2 Antenna gain

Limits:

Antenna Gain
6 dBi / > 6 dBi output power and power density reduction required

Declared by manufacturer:

#### **Results:**

Combined gain for 4x4 MIMO	UNII-1 & UNII-2A	UNII-2C	UNII-3
Gain [dBi] / Declared	0.8	0.9	0.9

Beamforming gain for 4x4 MIMO	UNII-1 & UNII-2A	UNII-2C	UNII-3
Gain [dBi] / Declared	4.8	4.2	4.5

**Conclusion: The sum of combined gain and beamforming gain is always lower than 6 dBi.**

### 12.3 Duty cycle

Results:

Duty cycle: >98% for all modes and channels



## 12.4 Maximum output power

Measurement parameter	
According to: KDB789033 D02, E.2.e.	
External result file(s)	1-3977_22-01-05_Annex_MR_A_1.pdf FCC Part 15.407 Max Output Power and PSD
Used test setup:	See chapter 7.4 – A
Measurement uncertainty:	See chapter 9
Standard parts:	FCC: § 15.407 (a)

Limits:

Limits	
Radiated output power	Conducted output power
Band 5150 MHz – 5250 MHz	
Conducted power + 6 dBi antenna gain	<p><b>For an outdoor access point:</b> output power <math>\leq 1\text{W}/30\text{dBm}^*</math> The maximum e.i.r.p. at any elevation angle above 30 degrees as measured from the horizon must not exceed 125 mW (21 dBm)</p> <p><b>For an indoor access point</b> output power <math>\leq 1\text{W}/30\text{dBm}^*</math></p> <p><b>For fixed point-to-point access points</b> output power <math>\leq 1\text{W}/30\text{dBm}</math></p> <p><b>For client devices</b> output power <math>\leq 250\text{ mW}/24\text{dBm}^*</math></p>
Band 5250MHz – 5350 MHz	
Conducted power + 6 dBi antenna gain	Minimum of 24dBm or $11\text{ dBm} + 10 \cdot \log(\text{BW})^*$
Band 5470MHz – 5725 MHz	
Conducted power + 6 dBi antenna gain	Minimum of 24dBm or $11\text{ dBm} + 10 \cdot \log(\text{BW})^*$
Band 5725MHz – 5850 MHz	
Conducted power + 6 dBi antenna gain	30 dBm*

\*If transmitting antennas of directional gain greater than 6 dBi are used, the maximum conducted output power shall be reduced by the amount in dB that the directional gain of the antenna exceeds 6 dBi.

## Results:

<b>802.11ac VHT160</b>		
<b>Maximum output power [dBm]</b>		
Channel	50	114
Port 1+3	18.9	17.2
Port 2+4	19.3	17.2
SUM	22.1	20.2

<b>802.11ax HE160</b>		
<b>Maximum output power [dBm]</b>		
Channel	50	114
Port 1+3	19.1	17.4
Port 2+4	19.7	16.8
SUM	22.4	20.1

## 12.5 Power spectral density

Description:

Measurement of the power spectral density of a digital modulated system. The measurement is repeated at the lowest, middle and highest channel.

Measurement:

Measurement parameter	
According to: KDB789033 D02, F.	
External result file(s)	1-3977_22-01-05_Annex_MR_A1 to A11 FCC Part 15.407 Max Output Power and PSD
Used test setup:	See chapter 7.4 – A
Measurement uncertainty:	See chapter 9
Standard parts:	FCC: § 15.407 (a)

Limits:

Power Spectral Density
<b>Band 5150 MHz – 5250 MHz</b>
For an outdoor access point power spectral density conducted $\leq 17$ dBm in any 1 MHz band* For an indoor access point power spectral density conducted $\leq 17$ dBm in any 1 MHz band* For fixed point-to-point access points power spectral density conducted $\leq 17$ dBm in any 1 MHz band** For client devices point power spectral density conducted $\leq 11$ dBm in any 1 MHz band* *If transmitting antennas of directional gain greater than 6 dBi are used the maximum power spectral density shall be reduced by the amount in dB that the directional gain of the antenna exceeds 6 dBi **Fixed point-to-point U-NII devices may employ antennas with directional gain up to 23 dBi without any corresponding reduction in the maximum power spectral density. For fixed point-to-point transmitters that employ a directional antenna gain greater than 23 dBi, a 1 dB reduction in maximum power spectral density is required for each 1 dB of antenna gain in excess of 23 dBi.
<b>Band 5250MHz – 5350 MHz</b>
power spectral density conducted $\leq 11$ dBm in any 1 MHz band* *If transmitting antennas of directional gain greater than 6 dBi are used the maximum power spectral density shall be reduced by the amount in dB that the directional gain of the antenna exceeds 6 dBi
<b>Band 5470MHz – 5725 MHz</b>
power spectral density conducted $\leq 11$ dBm in any 1 MHz band* *If transmitting antennas of directional gain greater than 6 dBi are used the maximum power spectral density shall be reduced by the amount in dB that the directional gain of the antenna exceeds 6 dBi
<b>Band 5725MHz – 5850 MHz</b>
power spectral density conducted $\leq 30$ dBm in any 500 kHz band If transmitting antennas of directional gain greater than 6 dBi are used the maximum power spectral density shall be reduced by the amount in dB that the directional gain of the antenna exceeds 6 dBi

## Results:

<b>802.11ac VHT160</b>		
<b>Power spectral density [dBm/1MHz] or [dBm/500kHz]</b>		
Channel	50	114
Port 1+3	0.4	-2.1
Port 2+4	0.5	-1.6
SUM	3.5	1.2

<b>802.11ax HE160</b>		
<b>Power spectral density [dBm/1MHz] or [dBm/500kHz]</b>		
Channel	50	114
Port 1+3	0.5	-1.3
Port 2+4	-0.5	-2.5
SUM	3.0	1.2

## 12.6 Spectrum bandwidth / 26 dB bandwidth

Description:

Measurement of the 26 dB bandwidth of the modulated signal.

Measurement:

Measurement parameter	
According to: KDB789033 D02, C.1.	
External result file(s)	1-3977_22-01-05_Annex_MR_A1 to A11 FCC Part 15.407 & ISED Bandwidths
Used test setup:	See chapter 7.4 – A
Measurement uncertainty:	See chapter 9

Limits:

Spectrum Bandwidth – 26 dB Bandwidth
<p><b>IC:</b> Any unwanted emissions that fall into the band 5250-5350 MHz shall be attenuated below the channel power by at least 26 dB, when measured using a resolution bandwidth between 1 and 5% of the occupied bandwidth (i.e. 99% bandwidth), above 5250 MHz. The 26 dB bandwidth may fall into the 5250-5350 MHz band; however, if the occupied bandwidth also falls within the 5250-5350 MHz band, the transmission is considered as intentional and the devices shall comply with all requirements in the band 5250-5350 MHz including implementing dynamic frequency selection (DFS) and TPC, on the portion of the emission that resides in the 5250-5350 MHz band.</p> <p><b>FCC:</b> Radar Detection Function of Dynamic Frequency Selection (DFS). U-NII devices operating with any part of its 26 dB emission bandwidth in the 5.25-5.35 GHz and 5.47-5.725 GHz bands shall employ a DFS radar detection mechanism to detect the presence of radar systems and to avoid co-channel operation with radar systems.</p>

Results:

802.11ac VHT160 26 dB bandwidth [MHz]		
Channel	50	114
Port 1+3	164.0	162.4
Port 2+4	162.4	164.0

802.11ax HE160 26 dB bandwidth [MHz]		
Channel	50	114
Port 1+3	163.6	164.0
Port 2+4	163.6	162.4

## 12.7 Occupied bandwidth / 99% emission bandwidth

Description:

Measurement of the 99% bandwidth of the modulated signal acc. RSS-GEN.

Measurement:

Measurement parameter	
External result file(s)	1-3977_22-01-05_Annex_MR_A1 to A11 FCC Part 15.407 & ISED Bandwidths
Test setup:	See chapter 7.4 – A
Measurement uncertainty:	See chapter 9

Usage:

-/-	ISED
OBW is necessary for Emission Designator	

Results:

<b>802.11ac VHT160</b> <b>99% bandwidth [MHz]</b>		
Channel	50	114
Port 1+3	153.8	154.6
Port 2+4	154.2	153.1

<b>802.11ax HE160</b> <b>99% bandwidth [MHz]</b>		
Channel	50	114
Port 1+3	155.4	154.6
Port 2+4	155.4	153.4

## 12.8 Band edge compliance radiated

### Description:

Measurement of the radiated band edge compliance. The EUT is turned in the position that results in the maximum level at the band edge. Then a sweep over the corresponding restricted band is performed. The EUT is set to the lowest channel for the lower restricted band and to the highest channel for the upper restricted band. Measurement distance is 3m.

### Measurement:

Measurement parameter	
Detector:	Peak / RMS
Sweep time:	Auto
Resolution bandwidth:	1 MHz
Video bandwidth:	≥ 3 x RBW
Span:	See plots!
Trace mode:	Max Hold
Test setup:	See sub clause 7.2 – B
Measurement uncertainty:	See chapter 9

### Limits:

Band Edge Compliance Radiated
In any 100 kHz bandwidth outside the frequency band in which the spread spectrum or digitally modulated intentional radiator is operating, the radio frequency power that is produced by the intentional radiator shall be at least 20 dB below that in the 100 kHz bandwidth within the band that contains the highest level of the desired power, based on either an RF conducted or a radiated measurement. Attenuation below the general limits specified in Section 15.209(a) is not required. In addition, radiated emissions which fall in the restricted bands, as defined in Section 15.205(a), must also comply with the radiated emission limits specified in Section 15.209(a) (see Section 5.205(c)).
74 dBµV/m (peak) 54 dBµV/m (average)

Results:

Band Edge Compliance radiated	Emission frequency [MHz]	Detector	Level [dBuV/m]
Lower band edge; U-NII-1 & U-NII-2A; middle channel, 802.11ac VHT160	5130	Peak	65.9
		AVG	53.4
	5150	Peak	63.7
		AVG	48.5
	5350	Peak	68.2
		AVG	53.5
Upper band edge; U-NII-2C; middle channel, 802.11ac VHT160	5370	Peak	60.6
		AVG	53.1
	5450	Peak	64.6
		AVG	53.0
	5460	Peak	65.3
		AVG	51.0
Lower band edge; U-NII-1 & U-NII-2A; middle channel, 802.11ax HE160	5050	Peak	60.4
		AVG	52.9
	5130	Peak	54.5
		AVG	50.1
	5150	Peak	66.7
		AVG	50.7
	5350	Peak	68.6
		AVG	52.4
Upper band edge; U-NII-2C; middle channel, 802.11ax HE160	5370	Peak	60.0
		AVG	52.5
	5450	Peak	64.0
		AVG	51.2
	5460	Peak	66.5
		AVG	51.8



**Plots:**

**Plot 1:** lower band edge; U-NII-1 & U-NII-2A; middle channel, 802.11 ac VHT160

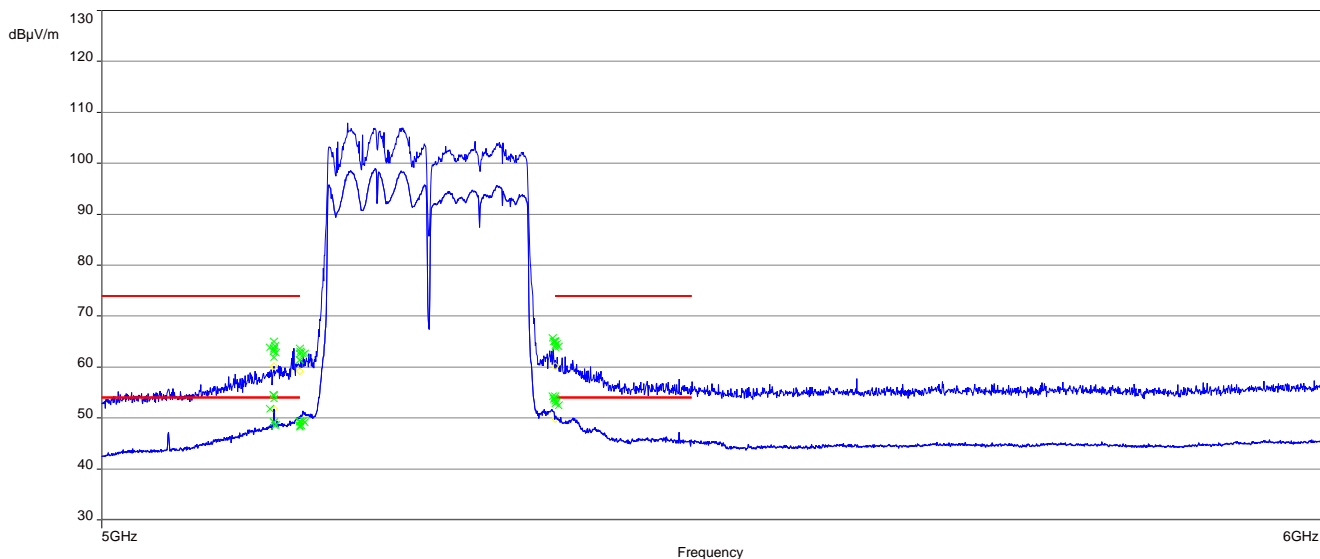

**Plot 2:** upper band edge; U-NII-2C; middle channel, 802.11 ac VHT160

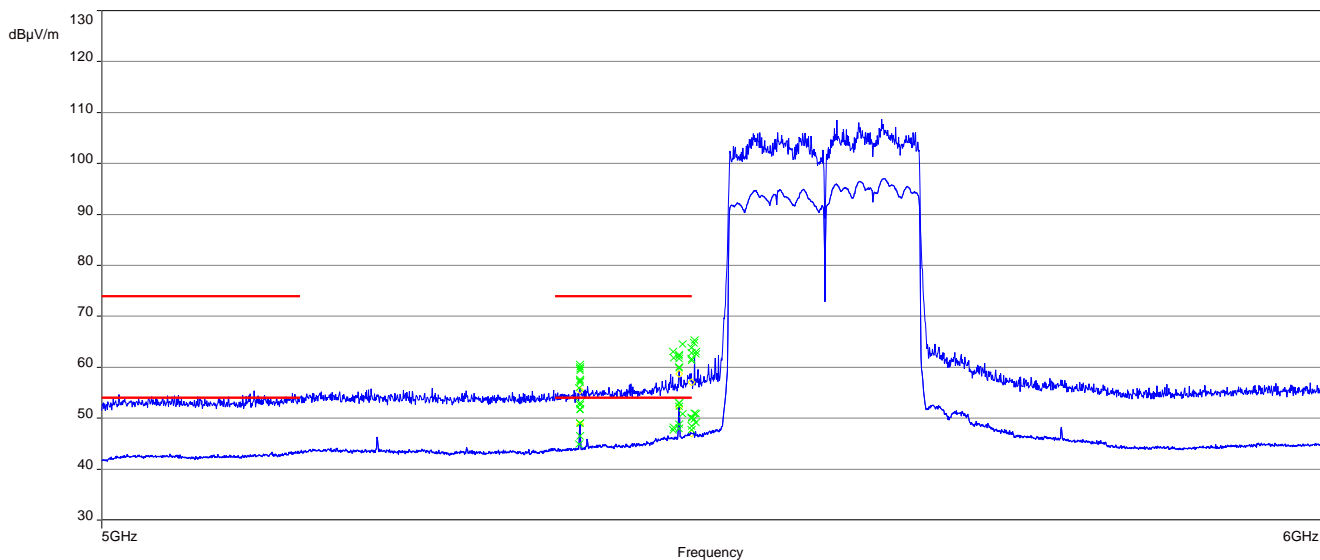

**Plot 3:** lower band edge; U-NII-1 & U-NII-2A; middle channel, 802.11 ax HE160

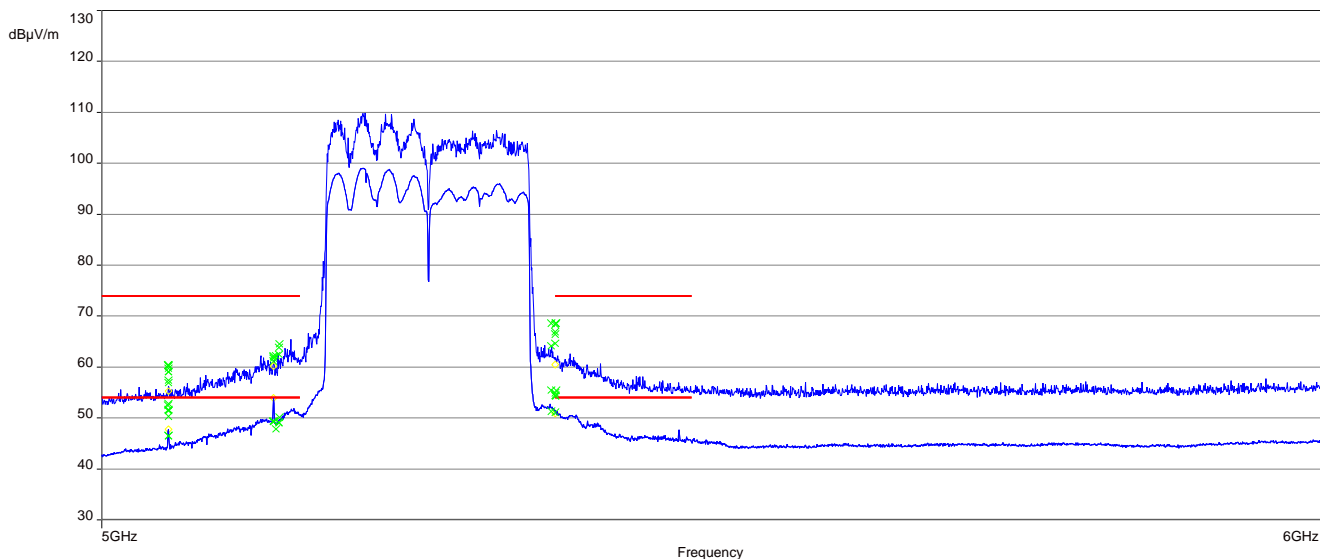

**Plot 4:** upper band edge; U-NII-2C; middle channel, 802.11 ax HE160

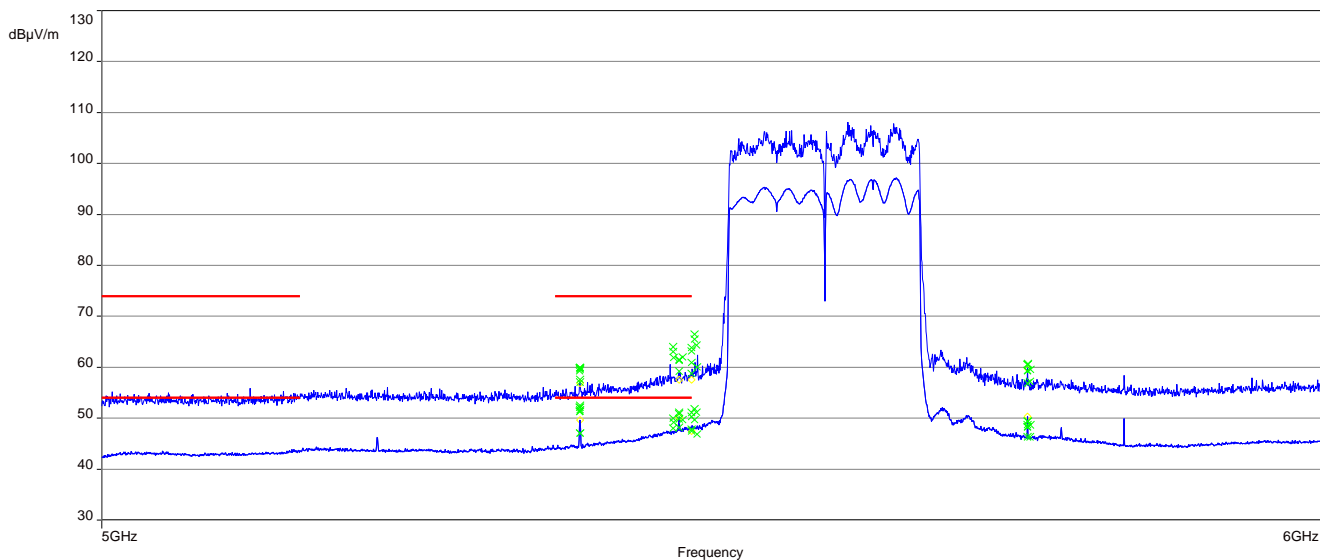

## 12.9 Spurious emissions radiated below 30 MHz

### Description:

Measurement of the radiated spurious emissions in transmit mode below 30 MHz. The limits are re-calculated to a measurement distance of 3 m with 40 dB/decade according CFR Part 2.

### Measurement:

Measurement parameter	
Detector:	Peak / Quasi Peak
Sweep time:	Auto
Video bandwidth:	F < 150 kHz: 200 Hz F > 150 kHz: 9 kHz
Resolution bandwidth:	F < 150 kHz: 1 kHz F > 150 kHz: 100 kHz
Span:	9 kHz to 30 MHz
Trace mode:	Max Hold
Test setup:	See sub clause 7.2 – C
Measurement uncertainty:	See chapter 9

### Limits:

Spurious Emissions Radiated < 30 MHz		
Frequency (MHz)	Field Strength (dB $\mu$ V/m)	Measurement distance
0.009 – 0.490	2400/F(kHz)	300
0.490 – 1.705	24000/F(kHz)	30
1.705 – 30.0	30	30

### Results:

Spurious Emissions Radiated < 30 MHz [dB $\mu$ V/m]		
F [MHz]	Detector	Level [dB $\mu$ V/m]
All detected emissions are more than 20 dB below the limit.		

**Plots:** 160 MHz channel bandwidth

**Plot 1:** 9 kHz to 30 MHz, U-NII-1 & U-NII-2A; middle channel

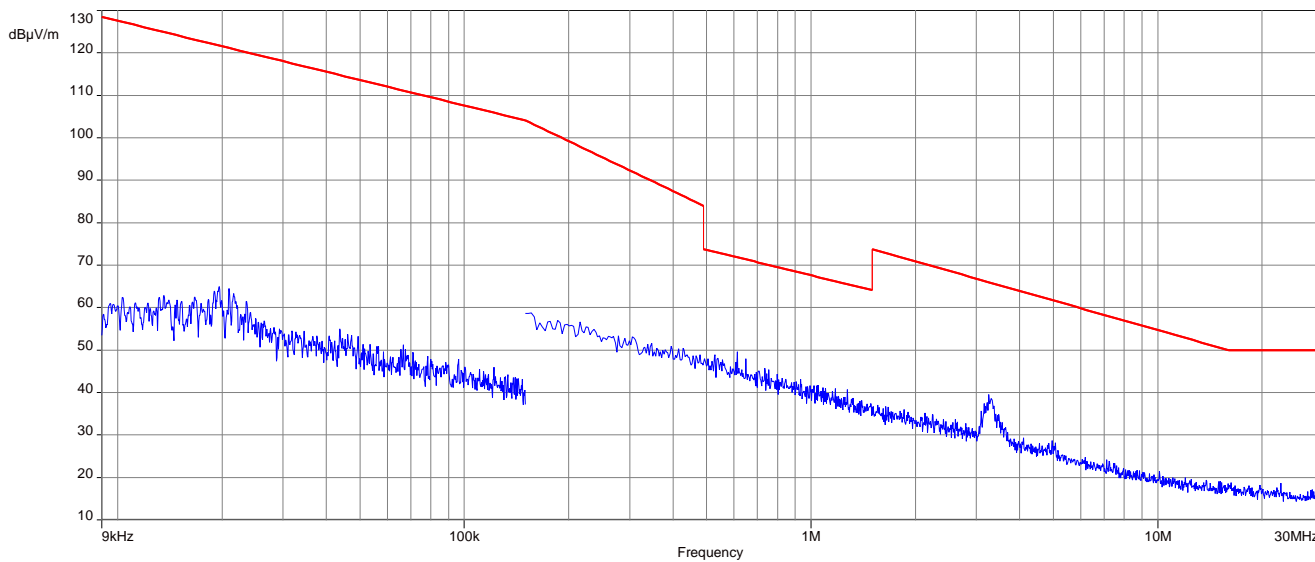

**Plot 2:** 9 kHz to 30 MHz, U-NII-2C; middle channel

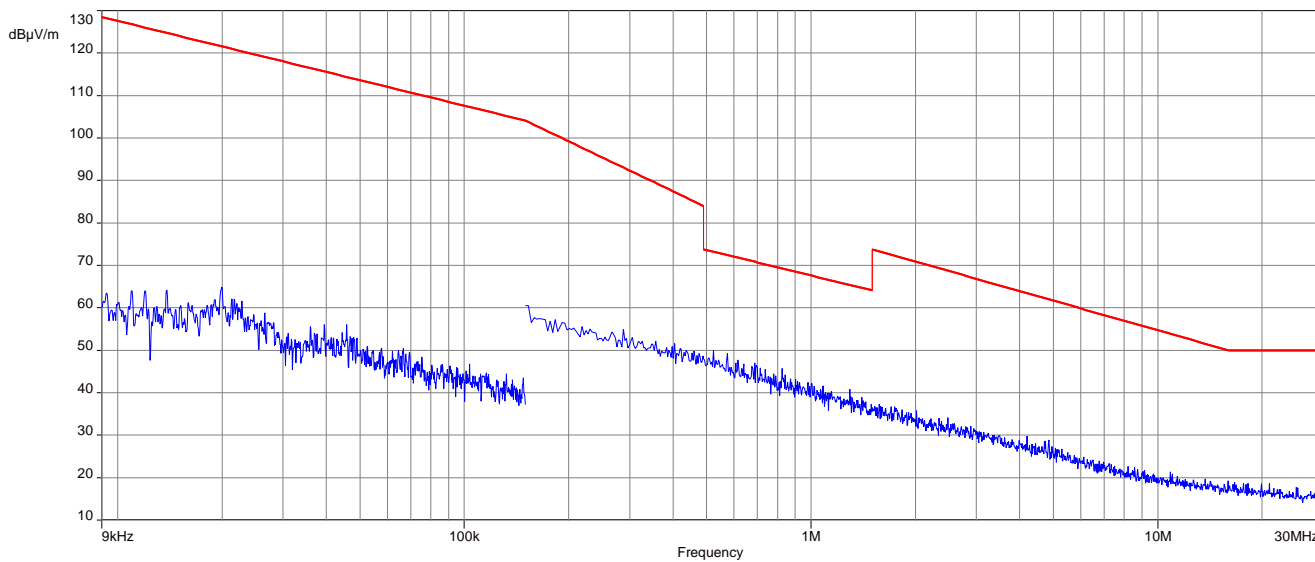

## 12.10 Spurious emissions radiated 30 MHz to 1 GHz

Description:

Measurement of the radiated spurious emissions and cabinet radiations below 1 GHz.

Measurement:

Measurement parameter	
Detector:	Quasi Peak
Sweep time:	Auto
Resolution bandwidth:	120 kHz
Video bandwidth:	500 kHz
Span:	30 MHz to 1 GHz
Test setup:	See sub clause 7.1 – A
Measurement uncertainty:	See chapter 9

Limits:

TX Spurious Emissions Radiated		
§15.209 / RSS-247		
Frequency (MHz)	Field Strength (dBµV/m)	Measurement distance
30 - 88	30.0	10
88 – 216	33.5	10
216 – 960	36.0	10
Above 960	54.0	3
§15.407		
Outside the restricted bands!	-27 dBm / MHz	

**Plots:**

**Plot 1:** 30 MHz to 1 GHz; vertical & horizontal polarization; U-NII-1 & U-NII-2A; 802.11ax HE160

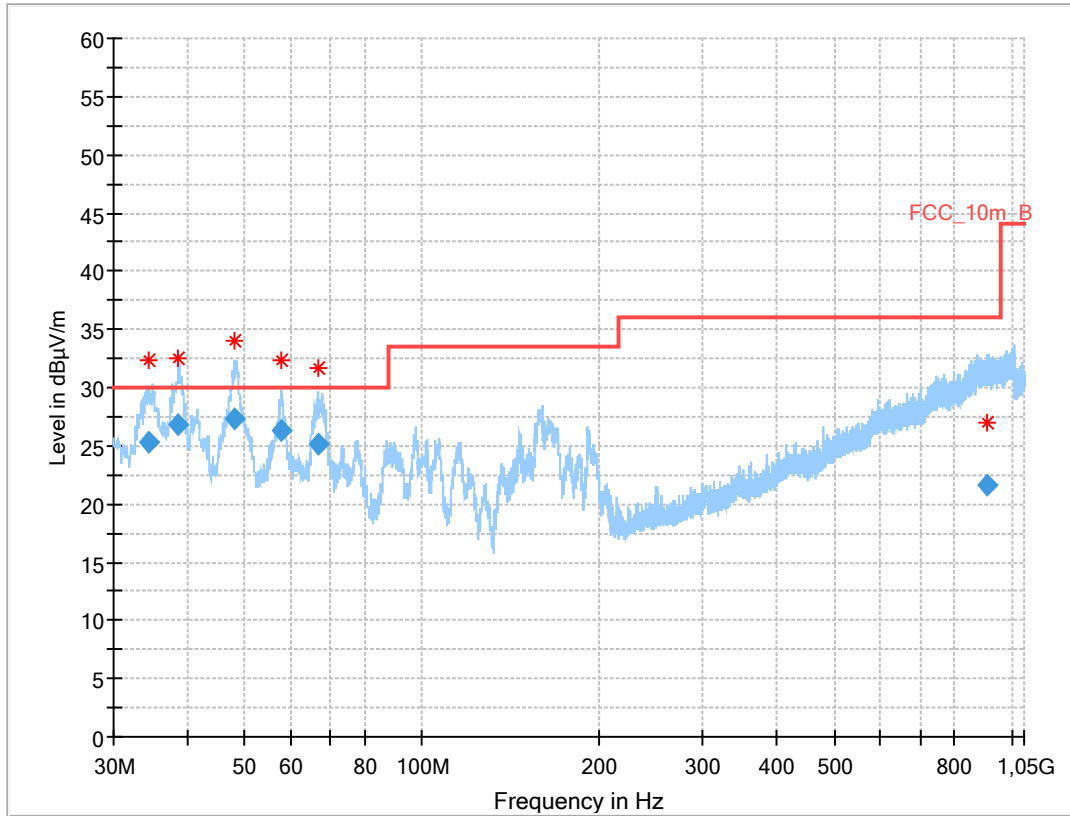

**Results:**

Frequency (MHz)	QuasiPeak (dBµV/m)	Limit (dBµV/m)	Margin (dB)	Meas. Time (ms)	Bandwidth (kHz)	Height (cm)	Pol	Azimuth (deg)	Corr. (dB)
34.296	25.32	30.0	4.7	1000	120.0	114.0	V	279	14
38.460	26.78	30.0	3.2	1000	120.0	109.0	V	84	15
48.241	27.34	30.0	2.7	1000	120.0	200.0	V	309	16
57.545	26.27	30.0	3.7	1000	120.0	200.0	V	320	15
66.920	25.13	30.0	4.9	1000	120.0	223.0	V	284	11
905.504	21.66	36.0	14.3	1000	120.0	200.0	V	-45	26

**Plot 2:** 30 MHz to 1 GHz; vertical & horizontal polarization; U-NII-2C; middle channel; 802.11ax HE160

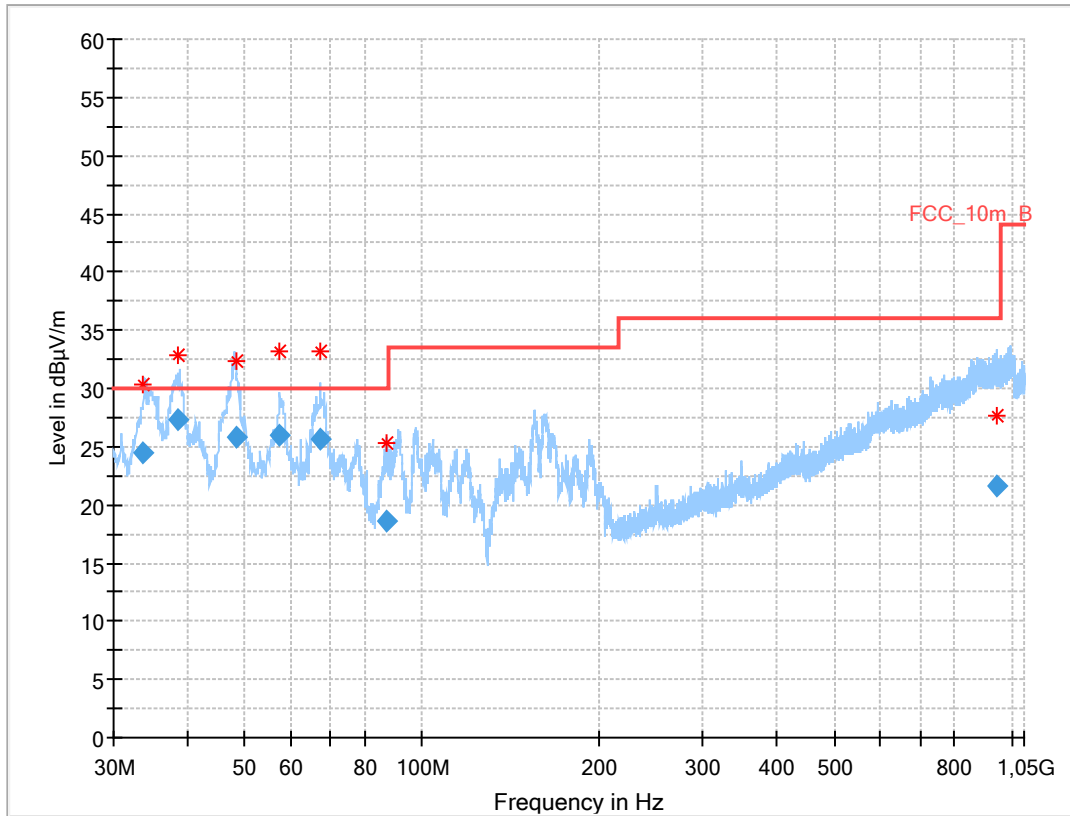

**Results:**

Frequency (MHz)	QuasiPeak (dBµV/m)	Limit (dBµV/m)	Margin (dB)	Meas. Time (ms)	Bandwidth (kHz)	Height (cm)	Pol	Azimuth (deg)	Corr. (dB)
33.575	24.52	30.0	5.5	1000	120.0	157.0	V	135	14
38.446	27.28	30.0	2.7	1000	120.0	107.0	V	235	15
48.524	25.81	30.0	4.2	1000	120.0	128.0	V	194	16
57.404	25.93	30.0	4.1	1000	120.0	200.0	V	327	15
67.210	25.63	30.0	4.4	1000	120.0	212.0	V	338	11
87.141	18.58	30.0	11.4	1000	120.0	352.0	V	-42	11
942.166	21.68	36.0	14.3	1000	120.0	200.0	V	272	26

## 12.11 Spurious emissions radiated 1 GHz to 40 GHz

Description:

Measurement of the radiated spurious emissions and cabinet radiations from 1 GHz to 40 GHz.

Measurement:

Measurement parameter	
Detector:	Peak/AVG
Sweep time:	Auto
Resolution bandwidth:	1 MHz
Video bandwidth:	3 MHz
Span:	1 GHz to 40 GHz
Trace mode:	Max Hold / Average with 100 counts + 20 log (1 / X) for duty cycle lower than 100 %
Test setup:	See sub clause 7.2 – A See sub clause 7.3 – A
Measurement uncertainty:	See chapter 9

Limits:

TX Spurious Emissions Radiated		
§15.209		
Frequency (MHz)	Field Strength (dBµV/m)	Measurement distance
Above 960	54.0 (AVG) 74 (Peak)	3
§15.407		
Outside the restricted bands!	-27 dBm / MHz	

**NOTE: For emissions between 5 and 6 GHz please see the results in Chapter 12.9.**



**Results:** 160 MHz channel bandwidth

TX Spurious Emissions Radiated [dBµV/m] / dBm		
U-NII-1 & U-NII-2A (5150 MHz to 5250 MHz & 5250 MHz to 5350 MHz)		
Middle channel		
F [MHz]	Detector	Level [dBµV/m]
-/-	Peak	-/-
	AVG	-/-
-/-	Peak	-/-
	AVG	-/-

TX Spurious Emissions Radiated [dBµV/m] / dBm		
U-NII-2C (5470 MHz to 5725 MHz)		
Middle channel		
F [MHz]	Detector	Level [dBµV/m]
11220	Peak	55.1
	AVG	52.4
-/-	Peak	-/-
	AVG	-/-

**Plots:** 160 MHz channel bandwidth

**Plot 1:** 1 GHz to 18 GHz; vertical & horizontal polarization; U-NII-1 & U-NII-2A; middle channel

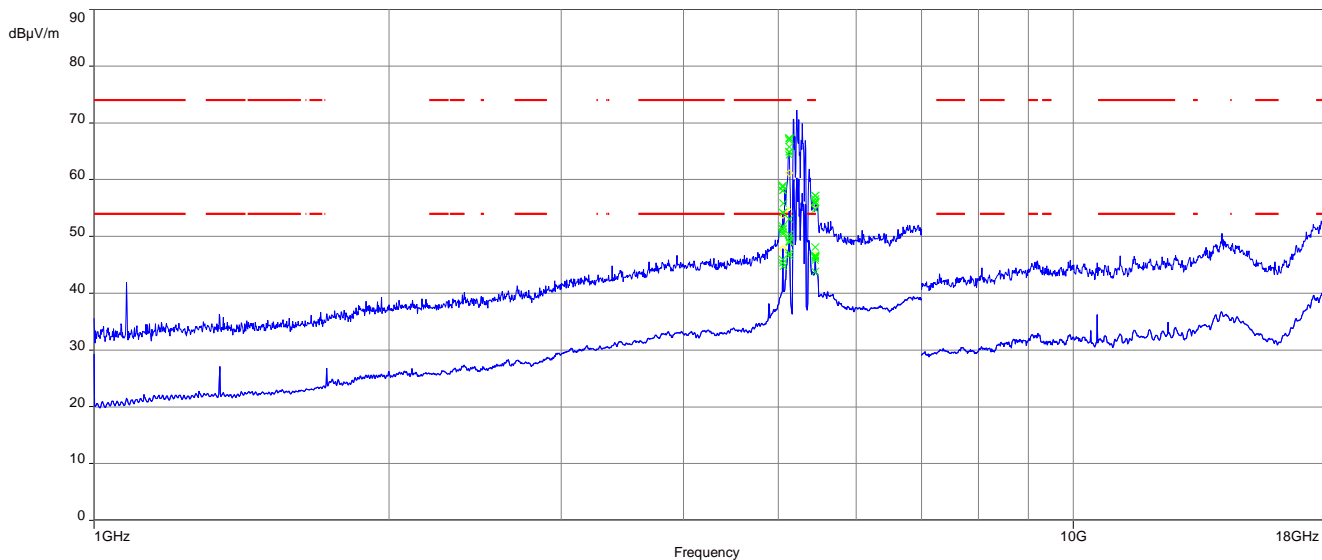

**Plot 2:** 1 GHz to 18 GHz; vertical & horizontal polarization; U-NII-2C; middle channel

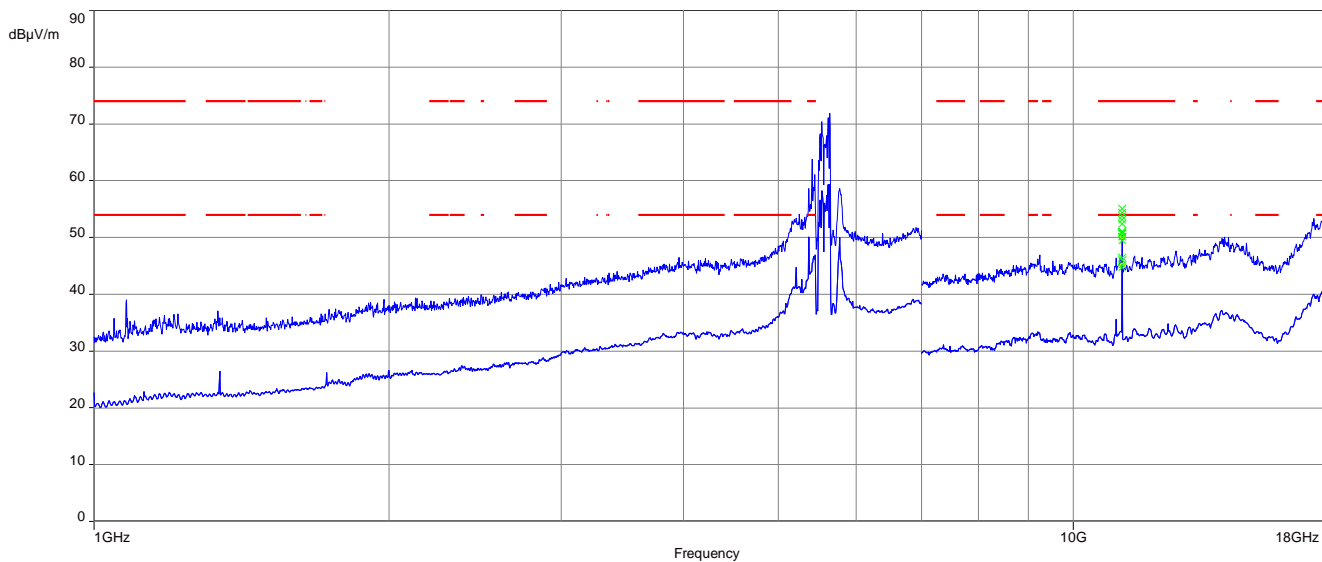

**Plots:** 18 GHz to 40 GHz

**Plot 1:** 18 GHz to 26 GHz, valid for all bands, channels and 160 MHz modes

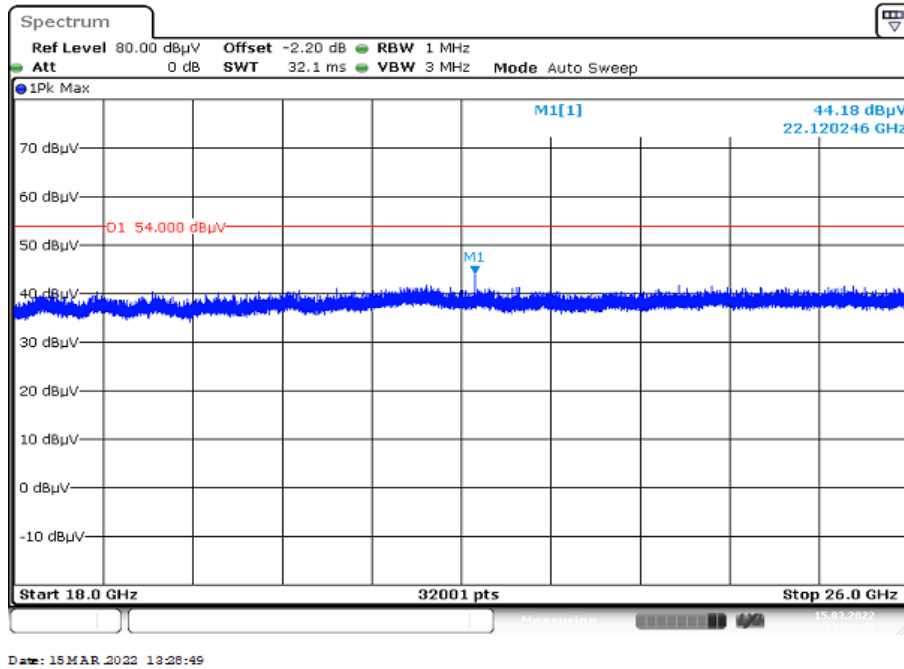

**Plot 2:** 26 GHz to 40 GHz, valid for all bands, channels and 160 MHz modes

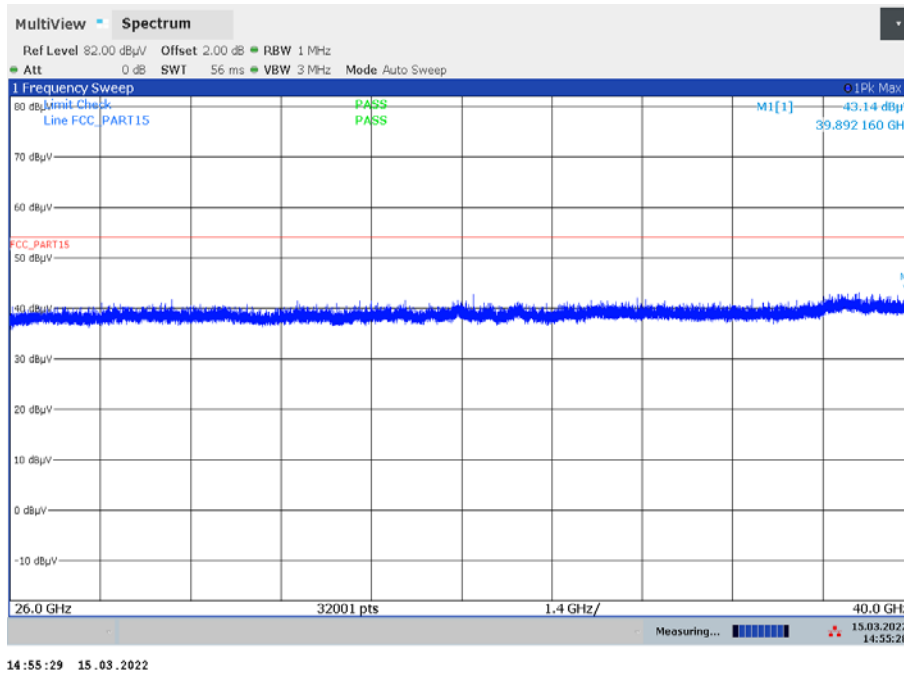

## 12.12 Spurious emissions conducted < 30 MHz

### Description:

Measurement of the conducted spurious emissions in transmit mode below 30 MHz. The EUT is set to middle channel. If critical peaks are found the lowest channel and the highest channel will be measured too. Both power lines, phase and neutral line, are measured. Found peaks are re-measured with average and quasi peak detection to show compliance to the limits.

### Measurement:

Measurement parameter	
Detector:	Peak - Quasi Peak / Average
Sweep time:	Auto
Video bandwidth:	9 kHz
Resolution bandwidth:	100 kHz
Span:	150 kHz to 30 MHz
Trace mode:	Max Hold
Test setup:	See sub clause 7.5 – A
Measurement uncertainty:	See chapter 9

### Limits:

Spurious Emissions Conducted < 30 MHz		
Frequency (MHz)	Quasi-Peak (dBµV/m)	Average (dBµV/m)
0.15 – 0.5	66 to 56*	56 to 46*
0.5 – 5	56	46
5 – 30.0	60	50

\*Decreases with the logarithm of the frequency

### Results:

Spurious Emissions Conducted < 30 MHz [dBµV/m]		
F [MHz]	Detector	Level [dBµV/m]
All detected emissions are more than 20 dB below the limit.		

**Plots:**

**Plot 1: 150 kHz to 30 MHz, phase line**

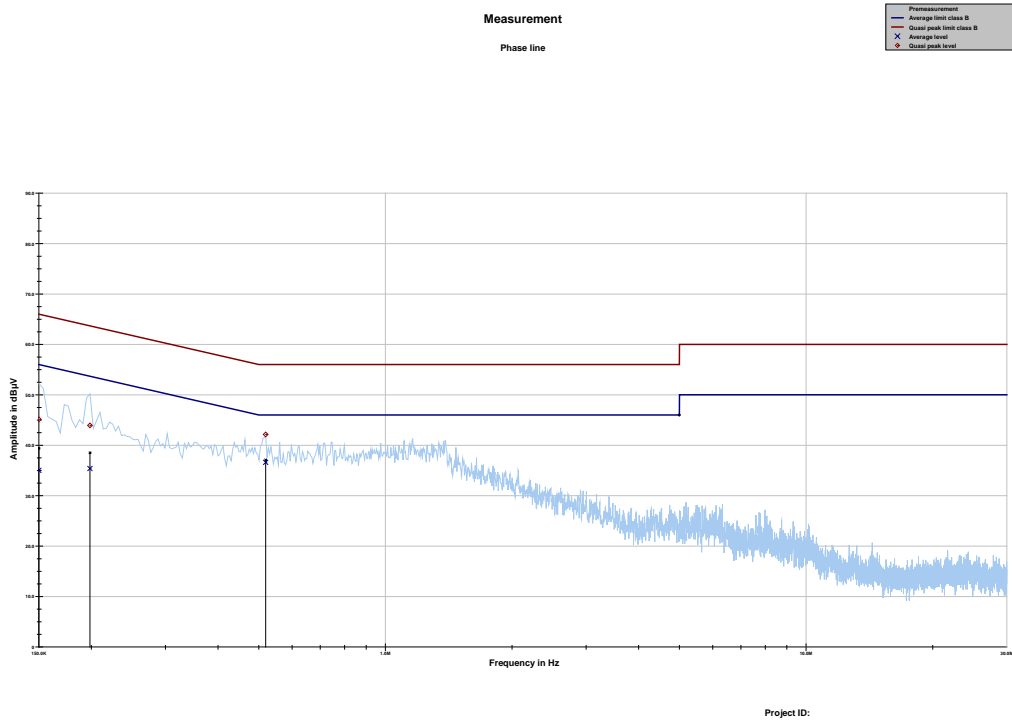

Frequency	Quasi peak level	Margin quasi peak	Limit QP	Average level	Margin average	Limit AV
MHz	dBµV	dB	dBµV	dBµV	dB	dBµV
0.150000	45.13	20.87	66.000	35.00	21.00	56.000
0.198506	43.93	19.74	63.673	35.39	19.22	54.614
0.519394	42.14	13.86	56.000	36.60	9.40	46.000

**Plot 2:** 150 kHz to 30 MHz, neutral line

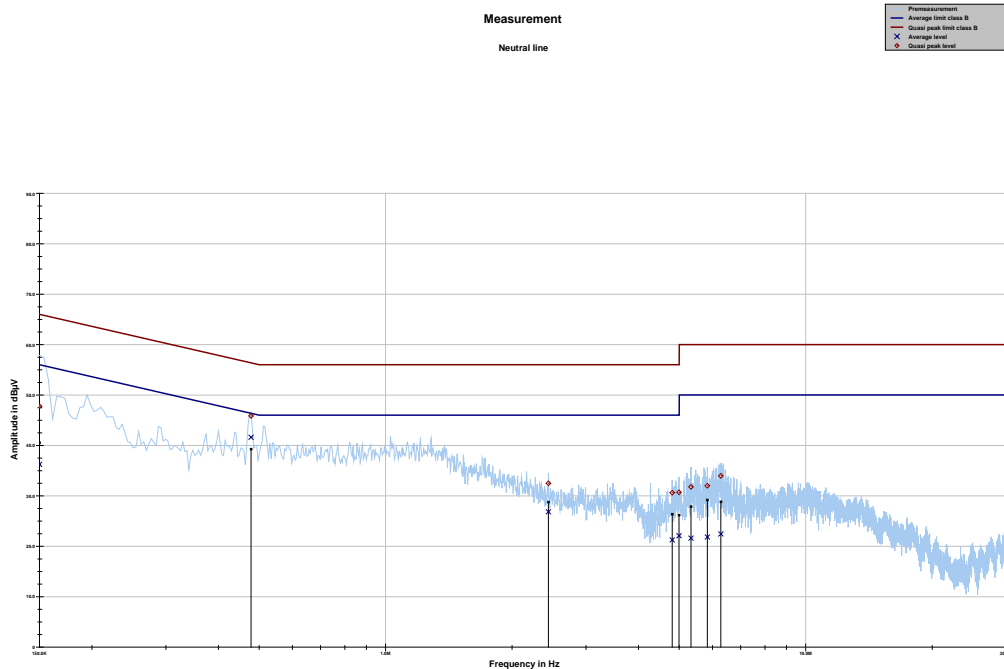

Project ID:

Frequency	Quasi peak level	Margin quasi peak	Limit QP	Average level	Margin Average	Limit AV
MHz	dBµV	dB	dBµV	dBµV	dB	dBµV
0.150000	47.78	18.22	66.000	36.24	19.76	56.000
0.478350	45.84	10.53	56.368	41.61	5.01	46.619
2.440987	32.49	23.51	56.000	26.83	19.17	46.000
4.810331	30.62	25.38	56.000	21.25	24.75	46.000
4.993163	30.69	25.31	56.000	22.10	23.90	46.000
5.332706	31.78	28.22	60.000	21.62	28.38	50.000
5.832694	32.00	28.00	60.000	21.84	28.16	50.000
6.280444	33.96	26.04	60.000	22.45	27.55	50.000

### 13 Glossary

<b>EUT</b>	Equipment under test
<b>DUT</b>	Device under test
<b>UUT</b>	Unit under test
<b>GUE</b>	GNSS User Equipment
<b>ETSI</b>	European Telecommunications Standards Institute
<b>EN</b>	European Standard
<b>FCC</b>	Federal Communications Commission
<b>FCC ID</b>	Company Identifier at FCC
<b>IC</b>	Industry Canada
<b>PMN</b>	Product marketing name
<b>HMN</b>	Host marketing name
<b>HVIN</b>	Hardware version identification number
<b>FVIN</b>	Firmware version identification number
<b>EMC</b>	Electromagnetic Compatibility
<b>HW</b>	Hardware
<b>SW</b>	Software
<b>Inv. No.</b>	Inventory number
<b>S/N or SN</b>	Serial number
<b>C</b>	Compliant
<b>NC</b>	Not compliant
<b>NA</b>	Not applicable
<b>NP</b>	Not performed
<b>PP</b>	Positive peak
<b>QP</b>	Quasi peak
<b>AVG</b>	Average
<b>OC</b>	Operating channel
<b>OCW</b>	Operating channel bandwidth
<b>OBW</b>	Occupied bandwidth
<b>OOB</b>	Out of band
<b>DFS</b>	Dynamic frequency selection
<b>CAC</b>	Channel availability check
<b>OP</b>	Occupancy period
<b>NOP</b>	Non occupancy period
<b>DC</b>	Duty cycle
<b>PER</b>	Packet error rate
<b>CW</b>	Clean wave
<b>MC</b>	Modulated carrier
<b>WLAN</b>	Wireless local area network
<b>RLAN</b>	Radio local area network
<b>DSSS</b>	Dynamic sequence spread spectrum
<b>OFDM</b>	Orthogonal frequency division multiplexing
<b>FHSS</b>	Frequency hopping spread spectrum
<b>GNSS</b>	Global Navigation Satellite System
<b>C/N<sub>0</sub></b>	Carrier to noise-density ratio, expressed in dB-Hz

## 14 Document history

Version	Applied changes	Date of release
-/-	Initial release	2022-07-28



15 Accreditation Certificate – D-PL-12076-01-05

first page	last page
 <p>Deutsche Akkreditierungsstelle GmbH</p> <p>Entrusted according to Section 8 subsection 1 AkkStelleG in connection with Section 1 subsection 1 AkkStelleGBV Signatory to the Multilateral Agreements of EA, ILAC and IAF for Mutual Recognition</p> <p><b>Accreditation</b> </p> <p>The Deutsche Akkreditierungsstelle GmbH attests that the testing laboratory <b>CTC advanced GmbH</b> Untertürkheimer Straße 6-10, 66117 Saarbrücken is competent under the terms of DIN EN ISO/IEC 17025:2018 to carry out tests in the following fields: <b>Telecommunication (FCC Requirements)</b></p> <p>The accreditation certificate shall only apply in connection with the notice of accreditation of 09.06.2020 with the accreditation number D-PL-12076-01. It comprises the cover sheet, the reverse side of the cover sheet and the following annex with a total of 05 pages. Registration number of the certificate: <b>D-PL-12076-01-05</b></p> <p>Frankfurt am Main, 09.06.2020  by <b>Dipl.-Ing. (FH) Alf Egner</b> Head of Division</p> <p><small>The certificate together with its annex reflects the status at the time of the date of issue. The current status of the scope of accreditation can be found in the database of accredited bodies of Deutsche Akkreditierungsstelle GmbH. <a href="https://www.dakks.de/en/content/accredited-bodies-dakks">https://www.dakks.de/en/content/accredited-bodies-dakks</a> 09.06.2020</small></p>	<p>Deutsche Akkreditierungsstelle GmbH</p> <p>Office Berlin Spittelmarkt 10 10117 Berlin</p> <p>Office Frankfurt am Main Europa-Allee 52 60327 Frankfurt am Main</p> <p>Office Braunschweig Bundesallee 100 38116 Braunschweig</p> <p>The publication of extracts of the accreditation certificate is subject to the prior written approval by Deutsche Akkreditierungsstelle GmbH (DAkKS). Exempted is the unchanged form of separate disseminations of the cover sheet by the conformity assessment body mentioned overleaf.</p> <p>No impression shall be made that the accreditation also extends to fields beyond the scope of accreditation attested by DAkKS.</p> <p>The accreditation was granted pursuant to the Act on the Accreditation Body (AkkStelleG) of 31 July 2009 (Federal Law Gazette I p. 2625) and the Regulation (EC) No 765/2008 of the European Parliament and of the Council of 9 July 2008 setting out the requirements for accreditation and market surveillance relating to the marketing of products (Official Journal of the European Union L 218 of 9 July 2008, p. 30). DAkKS is a signatory to the Multilateral Agreements for Mutual Recognition of the European co-operation for Accreditation (EA), International Accreditation Forum (IAF) and International Laboratory Accreditation Cooperation (ILAC). The signatories to these agreements recognise each other's accreditations.</p> <p>The up-to-date state of membership can be retrieved from the following websites: EA: <a href="http://www.european-accreditation.org">www.european-accreditation.org</a> ILAC: <a href="http://www.ilac.org">www.ilac.org</a> IAF: <a href="http://www.iaf.nu">www.iaf.nu</a></p>

Note: The current certificate annex is published on the websites (link see below).

<https://www.dakks.de/files/data/as/pdf/D-PL-12076-01-05e.pdf>

OR

[https://ctcadvanced.com/app/uploads/2020/06/D-PL-12076-01-05\\_TCB\\_USA.pdf](https://ctcadvanced.com/app/uploads/2020/06/D-PL-12076-01-05_TCB_USA.pdf)

##### END OF TEST REPORT #####