

RF MEASUREMENT REPORT

FCC ID: VW3FAST5670
Applicant: SAGEMCOM BROADBAND SAS
Product: Residential Cable Gateway
Model No.: F@ST5670V2 XXXXXXXXXXXX
(XXXXXXXXXX, X can be A~Z, space and other presentation, XXXXXXXXXXXX can be replaced by Millicom and other presentation, it is various by different marketing)
Brand Name: SAGEMCOM
FCC Classification: Unlicensed National Information Infrastructure (NII)
FCC Rule Part(s): Part 15 Subpart E (Section 15.407)
Result: Complies
Test Date: 2022-09-15 ~ 2022-11-30

Reviewed By:

Sunny Sun

Approved By:

Robin Wu



The test results relate only to the samples tested.

This equipment has been shown to be capable of compliance with the applicable technical standards as indicated in the measurement report and was tested in accordance with the measurement procedures specified in KDB789033. Test results reported herein relate only to the item(s) tested.

The test report shall not be reproduced except in full without the written approval of MRT Technology (Suzhou) Co., Ltd.

Revision History

Report No.	Version	Description	Issue Date	Note
2209RSU020-U2	Rev. 01	Initial Report	2022-12-02	Valid

CONTENTS

Description	Page
1. General Information	6
1.1. Applicant	6
1.2. Manufacturer.....	6
1.3. Testing Facility	6
1.4. Product Information	7
1.5. Radio Specification under Test.....	7
1.6. Working Frequencies.....	8
1.7. Antenna Details	9
2. Test Configuration	10
2.1. Test Mode	10
2.2. Test System Connection Diagram	11
2.3. Test Software	11
2.4. Applied Standards	12
2.5. Test Environment Condition.....	12
3. Antenna Requirements	13
4. Measuring Instrument	14
5. Decision Rules and Measurement Uncertainty	16
5.1. Decision Rules.....	16
5.2. Measurement Uncertainty	16
6. Test Result.....	17
6.1. Summary	17
6.2. 26dB & 99% Bandwidth Measurement.....	18
6.2.1. Test Limit.....	18
6.2.2. Test Procedure	18
6.2.3. Test Setting	18
6.2.4. Test Setup.....	19
6.2.5. Test Result	19
6.3. 6dB Bandwidth Measurement	20
6.3.1. Test Limit.....	20
6.3.2. Test Procedure	20
6.3.3. Test Setting	20
6.3.4. Test Setup.....	20
6.3.5. Test Result	20
6.4. Output Power Measurement.....	21
6.4.1. Test Limit.....	21

6.4.2.	Test Procedure	21
6.4.3.	Test Setting	21
6.4.4.	Test Setup	21
6.4.5.	Test Result	21
6.5.	Transmit Power Control Measurement	22
6.5.1.	Test Limit	22
6.5.2.	Test Procedure	22
6.5.3.	Test Setting	22
6.5.4.	Test Setup	22
6.5.5.	Test Result	22
6.6.	Power Spectral Density Measurement	23
6.6.1.	Test Limit	23
6.6.2.	Test Procedure	23
6.6.3.	Test Setting	23
6.6.4.	Test Setup	24
6.6.5.	Test Result	24
6.7.	Frequency Stability Measurement	25
6.7.1.	Test Limit	25
6.7.2.	Test Procedure	25
6.7.3.	Test Setup	25
6.7.4.	Test Result	26
6.8.	Radiated Spurious Emission Measurement	27
6.8.1.	Test Limit	27
6.8.2.	Test Procedure	27
6.8.3.	Test Setting	27
6.8.4.	Test Setup	29
6.8.5.	Test Result	30
6.9.	Radiated Restricted Band Edge Measurement	31
6.9.1.	Test Limit	31
6.9.2.	Test Procedure	33
6.9.3.	Test Setting	33
6.9.4.	Test Setup	34
6.9.5.	Test Result	34
6.10.	AC Conducted Emissions Measurement	35
6.10.1.	Test Limit	35
6.10.2.	Test Setup	35
6.10.3.	Test Result	35
Appendix A - Test Result		36
A.1	Duty Cycle Test Result	36

A.2	26dB Bandwidth Test Result	38
A.3	6dB Bandwidth Test Result	55
A.4	Output Power Test Result	61
A.5	Power Spectral Density Test Result.....	64
A.6	Frequency Stability Test Result.....	123
A.7	Radiated Spurious Emission Test Result.....	124
A.8	Radiated Restricted Band Edge Test Result.....	201
A.9	AC Conducted Emissions Test Result	339
Appendix B - Test Setup Photograph		341
Appendix C - EUT Photograph		342

1.4. Product Information

Product Name	Residential Cable Gateway
Model No.	F@ST5670V2 XXXXXXXXXXXX (XXXXXXXXXX, X can be A~Z, space and other presentation, XXXXXXXXXXXX can be replaced by Millicom and other presentation, it is various by different marketing)
Serial No.	N7222669R000032
Wi-Fi Specification	802.11a/b/g/n/ac/ax
Antenna Information	Refer to section 1.7
Working Voltage	12VDC
Accessory	
Adapter #1	Model: NBS24N120200VU Input: 100-240V ~ 50/60Hz 0.6A Output: 12.0V === 2.0A
Adapter #2	Model: MS-V2000R120-024Q0-US Input: 100-240V ~ 50/60Hz 0.7A Max Output: 12.0V === 2.0A
Note: The information of EUT was provided by the manufacturer, and the accuracy of the information shall be the responsibility of the manufacturer.	

1.5. Radio Specification under Test

Frequency Range	For 802.11a/n-HT20/ac-VHT20/ax-HE20: 5180~5240MHz, 5260~5320MHz, 5500~5720MHz, 5745~5825MHz For 802.11n-HT40/ac-VHT40/ax-HE40: 5190~5230MHz, 5270~5310MHz, 5510~5710MHz, 5755~5795MHz For 802.11ac-VHT80/ax-HE80: 5210MHz, 5290MHz, 5530MHz, 5610 MHz, 5690MHz, 5775MHz For 802.11ac-VHT160/ax-HE160: 5250MHz, 5570MHz
Type of Modulation	802.11a/n/ac: OFDM 802.11ax: OFDMA
Data Rate	802.11a: 6/9/12/18/24/36/48/54Mbps 802.11n: up to 600Mbps 802.11ac: up to 1733.4Mbps 802.11ax: up to 4804Mbps

The EUT incorporates the CDD, Beamforming, MIMO function. Physically, the EUT provides 4 completed transmitters and 4 receivers.

Mode	CDD Mode	Beamforming	TX Function
802.11a	√	x	4Tx
802.11ax-HE20	√	√	4Tx
802.11ax-HE40	√	√	4Tx
802.11ax-HE80	√	√	4Tx
802.11ax-HE160	√	√	4Tx

1.6. Working Frequencies

802.11a/n-HT20/ac-VHT20/ax-HE20

Channel	Frequency	Channel	Frequency	Channel	Frequency
36	5180 MHz	40	5200 MHz	44	5220 MHz
48	5240 MHz	52	5260 MHz	56	5280 MHz
60	5300 MHz	64	5320 MHz	100	5500 MHz
104	5520 MHz	108	5540 MHz	112	5560 MHz
116	5580 MHz	120	5600 MHz	124	5620 MHz
128	5640 MHz	132	5660 MHz	136	5680 MHz
140	5700 MHz	144	5720 MHz	149	5745 MHz
153	5765 MHz	157	5785 MHz	161	5805 MHz
165	5825 MHz	--	--	--	--

802.11n-HT40/ac-VHT40/ax-HE40

Channel	Frequency	Channel	Frequency	Channel	Frequency
38	5190 MHz	46	5230 MHz	54	5270 MHz
62	5310 MHz	102	5510 MHz	110	5550MHz
118	5590 MHz	126	5630 MHz	134	5670 MHz
142	5710 MHz	151	5755 MHz	159	5795 MHz

802.11ac-VHT80/ax-HE80

Channel	Frequency	Channel	Frequency	Channel	Frequency
42	5210 MHz	58	5290 MHz	106	5530 MHz
122	5610 MHz	138	5690 MHz	155	5775 MHz

802.11ac-VHT160/ax-HE160

Channel	Frequency	Channel	Frequency	Channel	Frequency
50	5250 MHz	114	5570 MHz	--	--

1.7. Antenna Details

Antenna Type	Frequency Band (GHz)	Ant 1	Ant 2	Ant 3	Ant 4	Directional Gain (dBi)	
		Max Peak Gain (dBi)	Max Peak Gain (dBi)	Max Peak Gain (dBi)	Max Peak Gain (dBi)	For Power	For PSD
Wi-Fi Antenna							
PIFA	2.4 ~ 2.5	2.66	1.55	1.57	--	2.66	4.08
	5.15 ~ 5.35	4.54	3.90	3.98	2.78	4.54	6.44
	5.47 ~ 5.725	4.25	3.20	4.48	3.55	4.48	5.95
	5.725 ~ 5.85	3.00	3.28	5.12	3.23	5.12	6.66
Note 1: The antenna gain and directional gain refer to manufacturer's antenna specification. Note 2: Software automatically backs power down based on a $10\log(N)$ factor for beamforming operation. Note 3: The EUT supports Cyclic Delay Diversity (CDD) mode, and CDD signals are correlated.							
<ul style="list-style-type: none"> For power measurements: Array Gain = 0 dB for $N_{ANT} \leq 4$, the directional gain = max antenna gain + array gain For power density measurements: the max directional gain (each angle) = $10 \cdot \log[(10^{G1/20} + 10^{G2/20} + \dots + 10^{GN/20})^2 / N_{ANT}]$ dBi. 							

2. Test Configuration

2.1. Test Mode

CDD Mode
Mode 1: Transmit by 802.11a_N _{SS} =1 (24Mbps)
Mode 2: Transmit by 802.11ac-VHT20_N _{SS} =1 (MCS5)
Mode 3: Transmit by 802.11ac-VHT40_N _{SS} =1 (MCS5)
Mode 4: Transmit by 802.11ac-VHT80_N _{SS} =1 (MCS5)
Mode 5: Transmit by 802.11ac-VHT160_N _{SS} =1 (MCS0)
Mode 6: Transmit by 802.11ax-HE20_N _{SS} =1 (MCS6)
Mode 7: Transmit by 802.11ax-HE40_N _{SS} =1 (MCS6)
Mode 8: Transmit by 802.11ax-HE80_N _{SS} =1 (MCS6)
Mode 9: Transmit by 802.11 ax-HE160_N _{SS} =1 (MCS0)
Remark: <ol style="list-style-type: none"> 1. For radiated spurious emission, the modulation and the data rate picked for testing are determined by the Max. RF conducted power. 2. Due to the same modulation between 802.11n and 802.11ac, so 802.11n are covered by 802.11ac in this report, meanwhile, power level for 802.11n will not be greater than 802.11ac. 3. This device supports 4 N_{SS} and power level is the same of spatial multiplexing. The worst case is N_{SS}=1. 4. RF power on each chain in MIMO mode is greater than SISO mode. The SISO Mode is covered by MIMO Mode. 5. After preliminary scan designated by the manufacturer, CDD mode is determined to be the worst case compared to Beamforming mode, hence, all the radiated test is performed in CDD mode. 6. For beamforming operation, manufacturer automatically backs power down based on a 10log (N_{ANT}) factor based on CDD power. Therefore, only the CDD mode was evaluated in this report. 7. EUT supports one configuration only in 802.11ax full RU mode.

2.2. Test System Connection Diagram

The device was tested per the guidance ANSI C63.10: 2013 was used to reference the appropriate EUT setup for radiated emissions testing and AC line conducted testing.

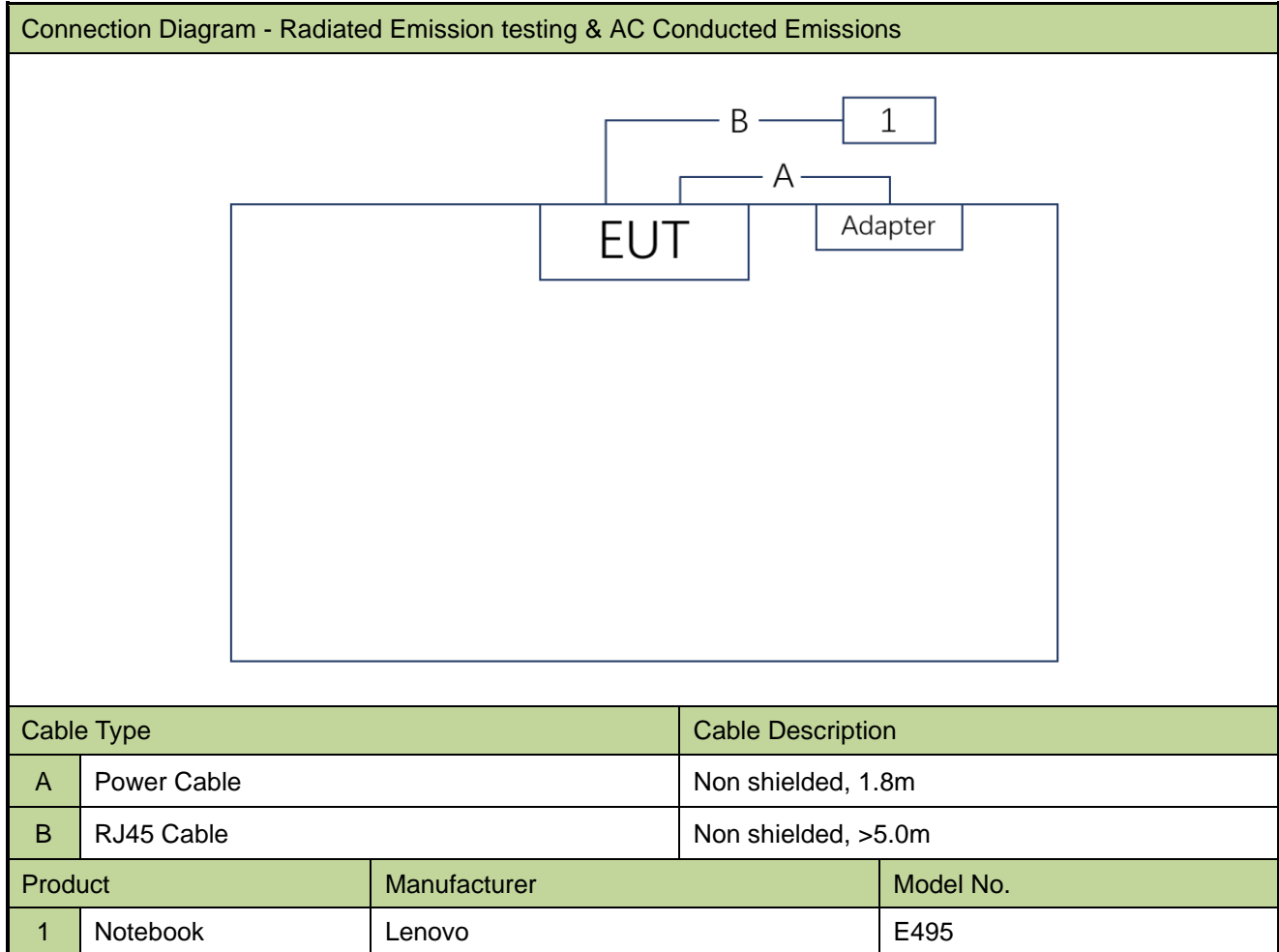

2.3. Test Software

The test utility software used during testing was “accessMTool”, and the version was 3.2.1.4.

2.4. Applied Standards

According to the specifications of the manufacturer, the EUT must comply with the requirements of the following standards:

- FCC Part 15.407
- KDB 789033 D02v02r01
- KDB 662911 D01v02r01
- ANSI C63.10-2013

2.5. Test Environment Condition

Ambient Temperature	15 ~ 35°C
Relative Humidity	20 ~ 75%RH

3. Antenna Requirements

Excerpt from §15.203 of the FCC Rules/Regulations:

“An intentional radiator antenna shall be designed to ensure that no antenna other than that furnished by the responsible party can be used with the device. The use of a permanently attached antenna or of an antenna that uses a unique coupling to the intentional radiator shall be considered sufficient to comply with the provisions of this section.”

- The antenna of the device is **permanently attached**.
- There are no provisions for connection to an external antenna.

Conclusion:

The unit complies with the requirement of §15.203.

4. Measuring Instrument

Instrument	Manufacturer	Model No.	Asset No.	Last Cali. Date	Cali. Due Date	Test Site
Signal Analyzer	Keysight	N9010B	MRTSUE06603	1 year	2023-10-25	SIP-AC1
Anechoic Chamber	RIKEN	SIP-AC1	MRTSUE06554	1 year	2022-12-23	SIP-AC1
Preamplifier	EMCI	EMC051845SE	MRTSUE06600	1 year	2023-11-07	SIP-AC1
Thermohygrometer	testo	608-H1	MRTSUE06616	1 year	2023-11-01	SIP-AC1
Thermohygrometer	testo	608-H1	MRTSUE06620	1 year	2023-11-27	SIP-AC1
Horn Antenna	R&S	HF907	MRTSUE06610	1 year	2023-07-13	SIP-AC1
EMI Test Receiver	R&S	ESR3	MRTSUE06185	1 year	2022-12-29	SIP-AC2
Preamplifier	EMCI	EMC184045SE	MRTSUE06602	1 year	2023-10-10	SIP-AC2
Loop Antenna	Schwarzbeck	FMZB 1519 B	MRTSUE06937	1 year	2023-03-14	SIP-AC2
Signal Analyzer	Keysight	N9010B	MRTSUE06559	1 year	2023-06-01	SIP-AC2
Horn Antenna	Schwarzbeck	BBHA 9170	MRTSUE06598	1 year	2023-11-05	SIP-AC2
Preamplifier	EMCI	EMC051845SE	MRTSUE06601	1 year	2023-11-22	SIP-AC2
Thermohygrometer	testo	608-H1	MRTSUE06623	1 year	2023-11-27	SIP-AC2
Thermohygrometer	testo	608-H1	MRTSUE06624	1 year	2023-11-27	SIP-AC2
TRILOG Antenna	Schwarzbeck	VULB 9168	MRTSUE06647	1 year	2023-07-13	SIP-AC2
Anechoic Chamber	RIKEN	SIP-AC2	MRTSUE06781	1 year	2022-12-23	SIP-AC2
Horn Antenna	Schwarzbeck	BBHA 9120D	MRTSUE06648	1 year	2023-10-22	SIP-AC2
Two-Line V-Network	R&S	ENV216	MRTSUE06003	1 year	2023-06-01	SIP-SR2
EMI Test Receiver	R&S	ESR3	MRTSUE06612	1 year	2023-06-01	SIP-SR2
Thermohygrometer	testo	608-H1	MRTSUE06621	1 year	2023-11-27	SIP-SR2
Shielding Room	MIX-BEP	SIP-SR2	MRTSUE06949	5 years	2024-10-23	SIP-SR2
Signal Analyzer	Keysight	N9010B	MRTSUE06558	1 year	2023-06-01	SIP-TR1
Thermohygrometer	testo	608-H1	MRTSUE11022	1 year	2023-11-01	SIP-TR1
USB Power Sensor	Keysight	U2021XA	MRTSUE06596	1 year	2023-08-23	SIP-TR1
Horn Antenna	ETS	3117	MRTSUE06257	1 year	2023-09-18	WZ-AC2
Preamplifier	EMCI	EMC051845SE	MRTSUE06987	1 year	2023-09-08	WZ-AC2
Signal Analyzer	Keysight	N9010B	MRTSUE06607	1 year	2022-12-29	WZ-AC2
Thermohygrometer	Mingle	ETH529	MRTSUE06170	1 year	2022-12-01	WZ-AC2
Horn Antenna	Schwarzbeck	BBHA 9120D	MRTSUE06171	1 year	2023-10-13	WZ-AC2
Preamplifier	Schwarzbeck	BBV 9718	MRTSUE06176	1 year	2023-05-08	WZ-AC2
Anechoic Chamber	RIKEN	WZ-AC2	MRTSUE06213	1 year	2023-04-21	WZ-AC2
Thermohygrometer	testo	608-H1	MRTSUE11038	1 year	2023-11-01	WZ-AC2

Software	Version	Function
EMI V3	V3.0.0	EMI Test Software



Controller_MF 7802BS	1.02	RE Antenna & Turntable
Agilent Power Panel	V R03.09.00	Power

5. Decision Rules and Measurement Uncertainty

5.1. Decision Rules

The Decision Rule is based on Simple Acceptance in accordance with ISO Guide 98-4: 2012 Clause 8.2. (Measurement uncertainty is not taken into account when stating conformity with a specified requirement.)

5.2. Measurement Uncertainty

Where relevant, the following test uncertainty levels have been estimated for tests performed on the EUT as specified in CISPR 16-4-2. This uncertainty represents an expanded uncertainty expressed at approximately the 95% confidence level using a coverage factor of $k = 2$.

AC Conducted Emission Measurement
Measurement Uncertainty for a Level of Confidence of 95% ($U=2Uc(y)$): 9kHz~150kHz: 3.74dB 150kHz~30MHz: 3.44dB
Radiated Disturbance
Measurement Uncertainty for a Level of Confidence of 95% ($U=2Uc(y)$): Horizontal: 30MHz~300MHz: 5.04dB 300MHz~1GHz: 4.95dB 1GHz~40GHz: 6.40dB Vertical: 30MHz~300MHz: 5.24dB 300MHz~1GHz: 6.03dB 1GHz~40GHz: 6.40dB
Spurious Emissions, Conducted
Measuring Uncertainty for a Level of Confidence of 95% ($U=2Uc(y)$): 0.78dB
Output Power
Measuring Uncertainty for a Level of Confidence of 95% ($U=2Uc(y)$): 1.13dB
Power Spectrum Density
Measuring Uncertainty for a Level of Confidence of 95% ($U=2Uc(y)$): 1.15dB
Occupied Bandwidth
Measuring Uncertainty for a Level of Confidence of 95% ($U=2Uc(y)$): 0.28%

6. Test Result

6.1. Summary

FCC Section(s)	Test Description	Test Condition	Verdict
15.407(a)	26dB Bandwidth	Conducted	Pass
15.407(e)	6dB Bandwidth		Pass
15.407(a)(1)(ii), (2), (3)(i)	Maximum Conducted Output Power		Pass
15.407(h)(1)	Transmit Power Control		Pass
15.407(a)(1)(ii), (2), (3)(i), (12)	Peak Power Spectral Density		Pass
15.407(b)(1), (2), (3), (4)(i)	Undesirable Emissions		Pass
15.205, 15.209 15.407(b)(8), (9), (10)	General Field Strength Limits (Restricted Bands and Radiated Emission Limits)	Radiated	Pass
15.207	AC Conducted Emissions 150kHz - 30MHz	Line Conducted	Pass

Remark:

The analyzer plots shown in this section were all taken with a correction table loaded into the analyzer. The correction table was used to account for the losses of the cables and attenuators used as part of the system to connect the EUT to the analyzer at all frequencies of interest.

6.2. 26dB & 99% Bandwidth Measurement

6.2.1. Test Limit

N/A

6.2.2. Test Procedure

KDB 789033 D02v02r01- Section II)C)1) (26dB Bandwidth)

KDB 789033 D02v02r01- Section II)D) (99% Bandwidth)

6.2.3. Test Setting

26dB Bandwidth

1. The analyzers' automatic bandwidth measurement capability was used to perform the 26dB bandwidth
2. RBW = approximately 1% of the emission bandwidth.
3. VBW > RBW
4. Detector = Peak.
5. Trace mode = max hold.
6. Measure the maximum width of the emission that is 26 dB down from the maximum of the emission.
Compare this with the RBW setting of the analyzer. Readjust RBW and repeat measurement as needed until the RBW/EBW ratio is approximately 1%.

99% Bandwidth

1. Set center frequency to the nominal EUT channel center frequency.
2. RBW = 1% to 5% of the OBW
3. VBW $\geq 3 \times$ RBW
4. Span = 1.5 times to 5 times the OBW
5. Detector = peak
6. Trace mode = max hold
7. Allow the trace to stabilize
8. Use the 99% power bandwidth function of the instrument.

6.2.4. Test Setup

Spectrum Analyzer

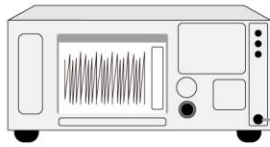

DC Block
&
Attenuator



6.2.5. Test Result

Refer to Appendix A.2.

6.3. 6dB Bandwidth Measurement

6.3.1. Test Limit

The minimum 6dB bandwidth shall be at least 500 kHz.

6.3.2. Test Procedure

KDB 789033 D02v02r01- Section II)C)2)

6.3.3. Test Setting

1. Set center frequency to the nominal EUT channel center frequency.
2. RBW = 100 kHz.
3. VBW $\geq 3 \times$ RBW.
4. Detector = Peak.
5. Trace mode = max hold.
6. Sweep = auto couple.
7. Allow the trace to stabilize.
8. Measure the maximum width of the emission that is constrained by the frequencies associated with the two outermost amplitude points (upper and lower frequencies) that are attenuated by 6 dB relative to the maximum level measured in the fundamental emission.

6.3.4. Test Setup

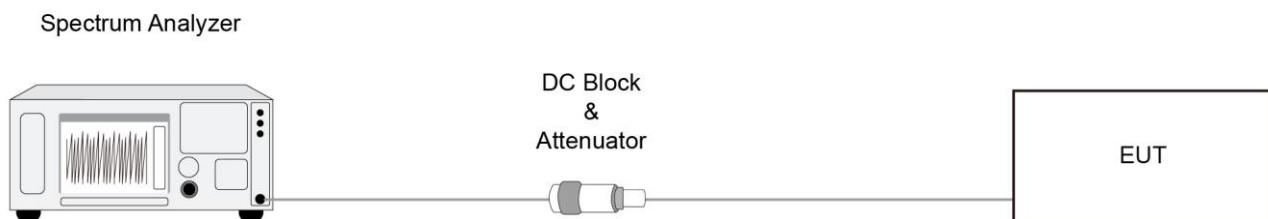

6.3.5. Test Result

Refer to Appendix A.3.

6.4. Output Power Measurement

6.4.1. Test Limit

For the band 5.15-5.25 GHz, the maximum conducted output power over the frequency band of operation shall not exceed 1 W provided the maximum antenna gain does not exceed 6 dBi.

For the 5.25-5.35 GHz and 5.47-5.725 GHz bands, the maximum conducted output power over the frequency bands of operation shall not exceed the lesser of 250 mW or $11 \text{ dBm} + 10 \log B$, where B is the 26 dB emission bandwidth in megahertz.

For the band 5.725-5.85 GHz, the maximum conducted output power over the frequency band of operation shall not exceed 1 W (30dBm).

If transmitting antennas of directional gain greater than 6dBi are used, the maximum conducted output power shall be reduced by the amount in dB that the directional gain of the antenna exceeds 6dBi.

6.4.2. Test Procedure

KDB 789033D02v02r01- Section II)E)3)b) Method PM-G

6.4.3. Test Setting

Average Power Measurement

Average power measurements were performed only when the EUT was transmitting at its maximum power control level using a broadband power meter with a pulse sensor. The power meter implemented triggering and gating capabilities which were set up such that power measurements were recorded only during the ON time of the transmitter.

6.4.4. Test Setup



6.4.5. Test Result

Refer to Appendix A.4.

6.5. Transmit Power Control Measurement

6.5.1. Test Limit

The U-NII device is required to have the capability to operate at least 6 dB below the mean EIRP value of 30 dBm.

6.5.2. Test Procedure

KDB 789033 D02v01- Section II)E)3)b) Method PM-G

6.5.3. Test Setting

Average power measurements were performed only when the EUT was transmitting at its maximum power control level using a broadband power meter with a pulse sensor. The power meter implemented triggering and gating capabilities which were set up such that power measurements were recorded only during the ON time of the transmitter. The trace was averaged over 100 traces to obtain the final measured average power.

6.5.4. Test Setup



6.5.5. Test Result

Device supports TPC mechanism, details refer to the operational description.

6.6. Power Spectral Density Measurement

6.6.1. Test Limit

For the band 5.15-5.25 GHz, the maximum power spectral density shall not exceed 17 dBm in any 1 megahertz band.

For the 5.25-5.35 GHz and 5.47-5.725 GHz bands, the maximum power spectral density shall not exceed 11 dBm in any 1 megahertz band.

For the band 5.725-5.85 GHz, the maximum power spectral density shall not exceed 30 dBm in any 500-kHz band.

If transmitting antennas of directional gain greater than 6dBi are used, the peak power spectral density shall be reduced by the amount in dB that the directional gain of the antenna exceeds 6dBi.

6.6.2. Test Procedure

KDB 789033 D02v02r01-Section II)F)

6.6.3. Test Setting

1. Analyzer was set to the center frequency of the UNII channel under investigation
2. Span was set to encompass the entire 26dB EBW of the signal.
3. RBW = 1MHz (510kHz, if measurement bandwidth of Maximum PSD is specified in 500 kHz)
4. VBW = 3 × RBW
5. Number of sweep points $\geq 2 \times (\text{span} / \text{RBW})$
6. Detector = power averaging (Average)
7. Sweep time = auto
8. Trigger = free run
9. Trace average at least 100 traces in power averaging (rms) mode; however, the number of traces to be averaged shall be increased above 100 as needed to ensure that the average accurately represents the true average over the on and off periods of the transmitter.
10. Use the peak search function on the instrument to find the peak of the spectrum and record its value.
11. Add $10 \cdot \log(1/x)$, where x is the duty cycle, to the measured power in order to compute the average power during the actual transmission times (because the measurement represents an average over both the on and off times of the transmission). For example, add $10 \cdot \log(1/0.25) = 6$ dB if the duty cycle is 25 percent.

6.6.4. Test Setup

Spectrum Analyzer

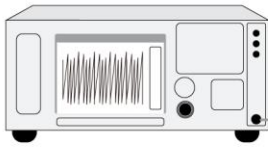

DC Block
&
Attenuator



6.6.5. Test Result

Refer to Appendix A.5.

6.7. Frequency Stability Measurement

6.7.1. Test Limit

Manufactures of U-NII devices are responsible for ensuring frequency stability such that an emission is maintained within the band of operation under all conditions of normal operation as specified in the user's manual.

6.7.2. Test Procedure

Frequency Stability Under Temperature Variations:

The equipment under test was connected to an external AC or DC power supply and input rated voltage. RF output was connected to a frequency counter or spectrum analyzer via feed through attenuators. The EUT was placed inside the temperature chamber. Set the spectrum analyzer RBW low enough to obtain the desired frequency resolution and measure EUT 20°C operating frequency as reference frequency. Turn EUT off and set the chamber temperature to highest. After the temperature stabilized for approximately 30 minutes recorded the frequency. Repeat step measure with 10°C decreased per stage until the lowest temperature reached.

Frequency Stability Under Voltage Variations:

Set chamber temperature to 20°C. Use a variable AC power supply / DC power source to power the EUT and set the voltage to rated voltage. Set the spectrum analyzer RBW low enough to obtain the desired frequency resolution and recorded the frequency.

Reduce the input voltage to specify extreme voltage variation ($\pm 15\%$) and endpoint, record the maximum frequency change.

6.7.3. Test Setup

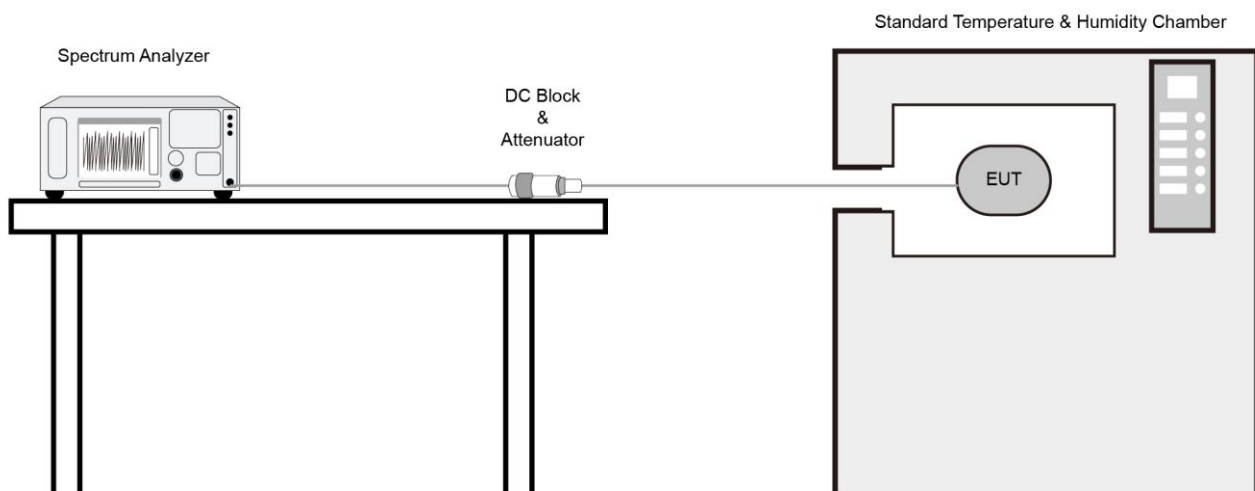

6.7.4. Test Result

Refer to Appendix A.6.

6.8. Radiated Spurious Emission Measurement

6.8.1. Test Limit

All out of band emissions appearing in a restricted band as specified in Section 15.205 of the Title 47 CFR must not exceed the limits shown in Table per Section 15.209.

FCC Part 15 Subpart C Paragraph 15.209		
Frequency [MHz]	Field Strength [uV/m]	Measured Distance [Meters]
0.009 - 0.490	2400/F (kHz)	300
0.490 - 1.705	24000/F (kHz)	30
1.705 - 30	30	30
30 - 88	100	3
88 - 216	150	3
216 - 960	200	3
Above 960	500	3

6.8.2. Test Procedure

KDB 789033 D02v02r01- Section II)G)

6.8.3. Test Setting

Table 1 - RBW as a function of frequency

Frequency	RBW
9 ~ 150 kHz	200 ~ 300 Hz
0.15 ~ 30 MHz	9 ~ 10 kHz
30 ~ 1000 MHz	100 ~ 120 kHz
> 1000MHz	1MHz

Quasi-Peak Measurements below 1GHz

1. Analyzer center frequency was set to the frequency of the radiated spurious emission of interest
2. Span was set greater than 1MHz
3. RBW = as specified in Table 1
4. Detector = CISPR quasi-peak
5. Sweep time = auto couple
6. Trace was allowed to stabilize

Peak Measurements above 1GHz

1. Analyzer center frequency was set to the frequency of the radiated spurious emission of interest
2. RBW = 1MHz
3. VBW = 3MHz
4. Detector = peak
5. Sweep time = auto couple
6. Trace mode = max hold
7. Trace was allowed to stabilize

Average Measurements above 1GHz (Method VB)

1. Analyzer center frequency was set to the frequency of the radiated spurious emission of interest
2. RBW = 1MHz
3. VBW; If the EUT is configured to transmit with duty cycle $\geq 98\%$, set VBW = 10 Hz.
If the EUT duty cycle is $< 98\%$, set VBW $\geq 1/T$. T is the minimum transmission duration.
4. Detector = Peak
5. Sweep time = auto
6. Trace mode = max hold
7. Trace was allowed to stabilize

6.8.4. Test Setup

Below 1GHz Test Setup:

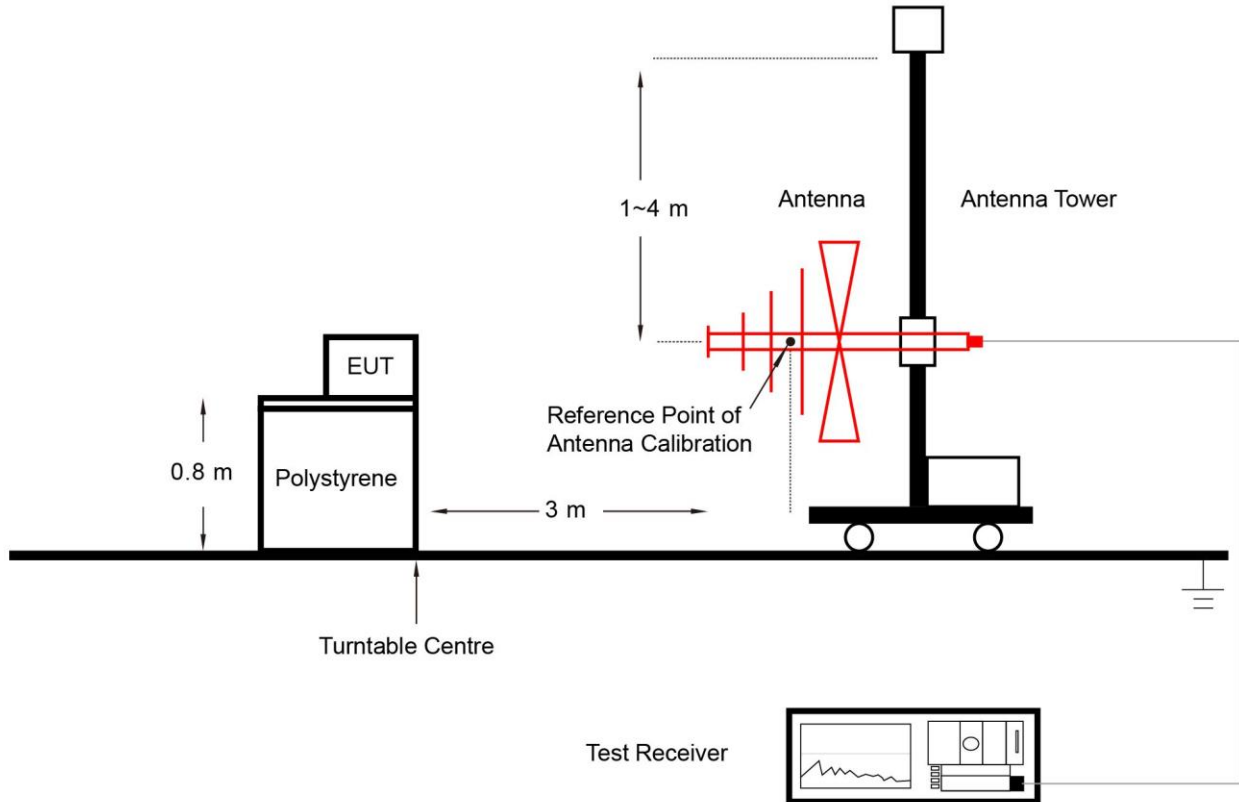

Above 1GHz Test Setup:

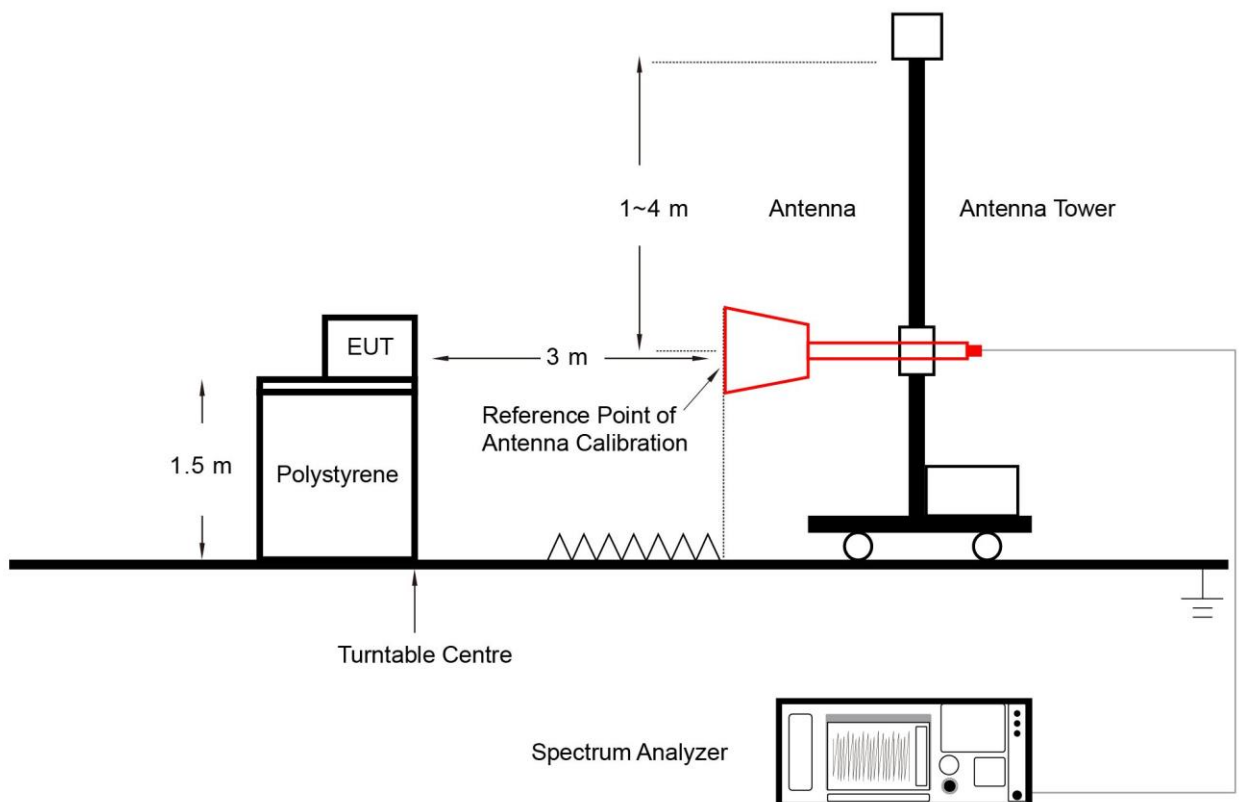

6.8.5. Test Result

Refer to Appendix A.7.

6.9. Radiated Restricted Band Edge Measurement

6.9.1. Test Limit

For 15.205 requirement:

Radiated emissions which fall in the restricted bands, as defined in Section 15.205(a) of FCC part 15, must also comply with the radiated emission limits specified in Section 15.209(a).

Frequency (MHz)	Frequency (MHz)	Frequency (MHz)	Frequency (GHz)
0.090 - 0.110	16.42 - 16.423	399.9 - 410	4.5 - 5.15
¹ 0.495 - 0.505	16.69475 - 16.69525	608 - 614	5.35 - 5.46
2.1735 - 2.1905	16.80425 - 16.80475	960 - 1240	7.25 - 7.75
4.125 - 4.128	25.5 - 25.67	1300 - 1427	8.025 - 8.5
4.17725 - 4.17775	37.5 - 38.25	1435 - 1626.5	9.0 - 9.2
4.20725 - 4.20775	73 - 74.6	1645.5 - 1646.5	9.3 - 9.5
6.215 - 6.218	74.8 - 75.2	1660 - 1710	10.6 - 12.7
6.26775 - 6.26825	108 - 121.94	1718.8 - 1722.2	13.25 - 13.4
6.31175 - 6.31225	123 - 138	2200 - 2300	14.47 - 14.5
8.291 - 8.294	149.9 - 150.05	2310 - 2390	15.35 - 16.2
8.362 - 8.366	156.52475 - 156.52525	2483.5 - 2500	17.7 - 21.4
8.37625 - 8.38675	156.7 - 156.9	2690 - 2900	22.01 - 23.12
8.41425 - 8.41475	162.0125 - 167.17	3260 - 3267	23.6 - 24.0
12.29 - 12.293	167.72 - 173.2	3332 - 3339	31.2 - 31.8
12.51975 - 12.52025	240 - 285	3345.8 - 3358	36.43 - 36.5
12.57675 - 12.57725	322 - 335.4	3600 - 4400	(²)
13.36 - 13.41	--	--	--

For 15.407(b) requirement:

For transmitters operating in the 5.15-5.25 GHz band: All emissions outside of the 5.15-5.35 GHz band shall not exceed an e.i.r.p. of -27 dBm/MHz.

For transmitters operating in the 5.25-5.35 GHz band: All emissions outside of the 5.15-5.35 GHz band shall not exceed an e.i.r.p. of -27 dBm/MHz.

For transmitters operating in the 5.47-5.725 GHz band: All emissions outside of the 5.47-5.725 GHz band shall not exceed an e.i.r.p. of -27 dBm/MHz.

For transmitters operating in the 5.725-5.85 GHz band: All emissions shall be limited to a level of -27 dBm/MHz at 75 MHz or more above or below the band edge increasing linearly to 10 dBm/MHz at 25 MHz above or below the band edge, and from 25 MHz above or below the band edge increasing linearly to a level of 15.6 dBm/MHz at 5 MHz above or below the band edge, and from 5 MHz above or below the band edge increasing linearly to a level of 27 dBm/MHz at the band edge.

Refer to KDB 789033 D02v02r01 G)2)c), as specified in § 15.407(b), emissions above 1000 MHz that are outside of the restricted bands are subject to a maximum emission limit of -27 dBm/MHz (or -17 dBm/MHz as specified in § 15.407(b)(4)). However, an out-of-band emission that complies with both the peak and average limits of § 15.209 is not required to satisfy the -27 dBm/MHz or -17 dBm/MHz maximum emission limit.

All out of band emissions appearing in a restricted band as specified in Section 15.205 of the Title 47CFR must not exceed the limits shown in Table per Section 15.209.

FCC Part 15 Subpart C Paragraph 15.209		
Frequency [MHz]	Field Strength [uV/m]	Measured Distance [Meters]
0.009 - 0.490	2400/F (kHz)	300
0.490 - 1.705	24000/F (kHz)	30
1.705 - 30	30	30
30 - 88	100	3
88 - 216	150	3
216 - 960	200	3
Above 960	500	3

6.9.2. Test Procedure

KDB 789033 D02v02r01- Section II)G)

6.9.3. Test Setting

Peak Measurements above 1GHz

1. Analyzer center frequency was set to the frequency of the radiated spurious emission of interest
2. RBW = 1MHz
3. VBW = 3MHz
4. Detector = Peak
5. Sweep time = Auto couple
6. Trace mode = Max hold
7. Trace was allowed to stabilize

Average Measurements above 1GHz (Method VB)

1. Analyzer center frequency was set to the frequency of the radiated spurious emission of interest
2. RBW = 1MHz
3. VBW; if the EUT is configured to transmit with duty cycle $\geq 98\%$, set VBW = 10Hz
4. If the EUT duty cycle is $< 98\%$, set VBW $\geq 1/T$. T is the minimum transmission duration
5. Detector = Peak
6. Sweep time = Auto
7. Trace mode = Max hold
8. Trace was allowed to stabilize

6.9.4. Test Setup

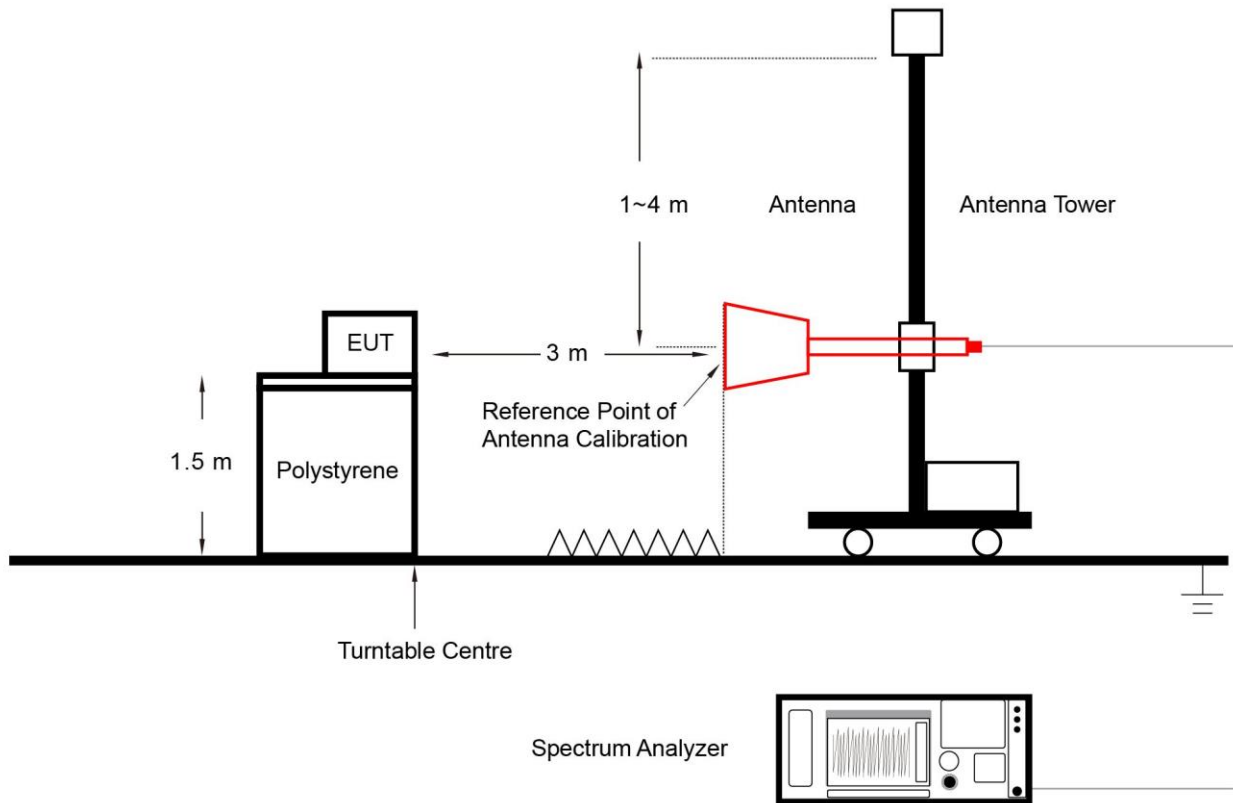

6.9.5. Test Result

Refer to Appendix A.8.

6.10. AC Conducted Emissions Measurement

6.10.1. Test Limit

FCC Part 15.207 Limits		
Frequency (MHz)	QP (dBuV)	AV (dBuV)
0.15 - 0.50	66 - 56	56 - 46
0.50 - 5.0	56	46
5.0 - 30	60	50

Note 1: The lower limit shall apply at the transition frequencies.

Note 2: The limit decreases linearly with the logarithm of the frequency in the range 0.15MHz to 0.5MHz.

6.10.2. Test Setup

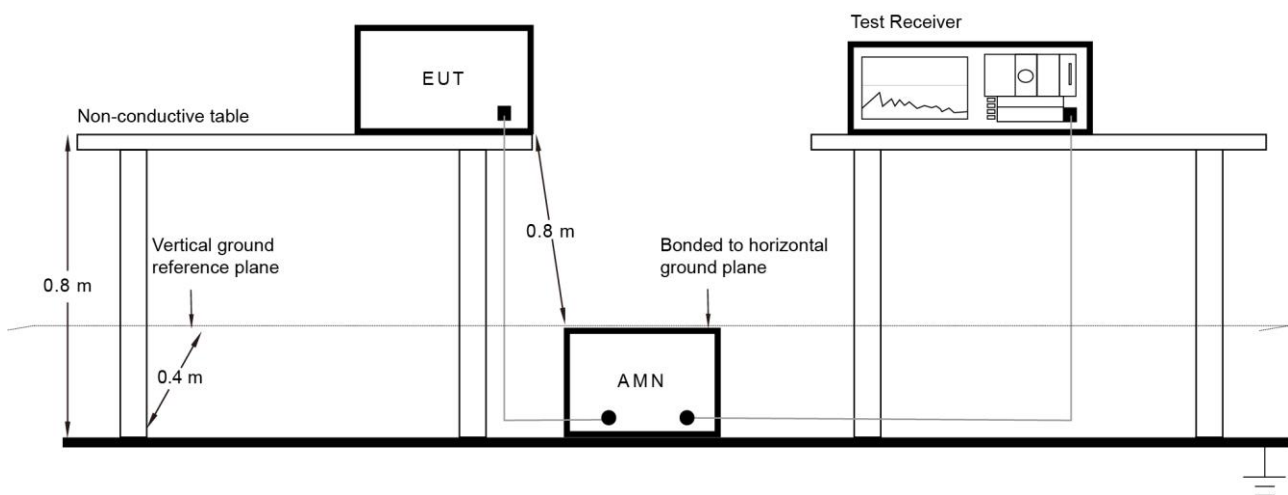

6.10.3. Test Result

Refer to Appendix A.9.

Appendix A - Test Result

A.1 Duty Cycle Test Result

Test Site	SIP-TR1	Test Engineer	Nandy Zhang
Test Date	2022-09-15		

Test Mode	Duty Cycle
802.11a	95.05%
802.11ac-VHT20	90.55%
802.11ac-VHT40	84.39%
802.11ac-VHT80	77.22%
802.11ac-VHT160	89.66%
802.11ax-HE20	88.18%
802.11ax-HE40	83.08%
802.11ax-HE80	77.75%
802.11ax-HE160	89.04%

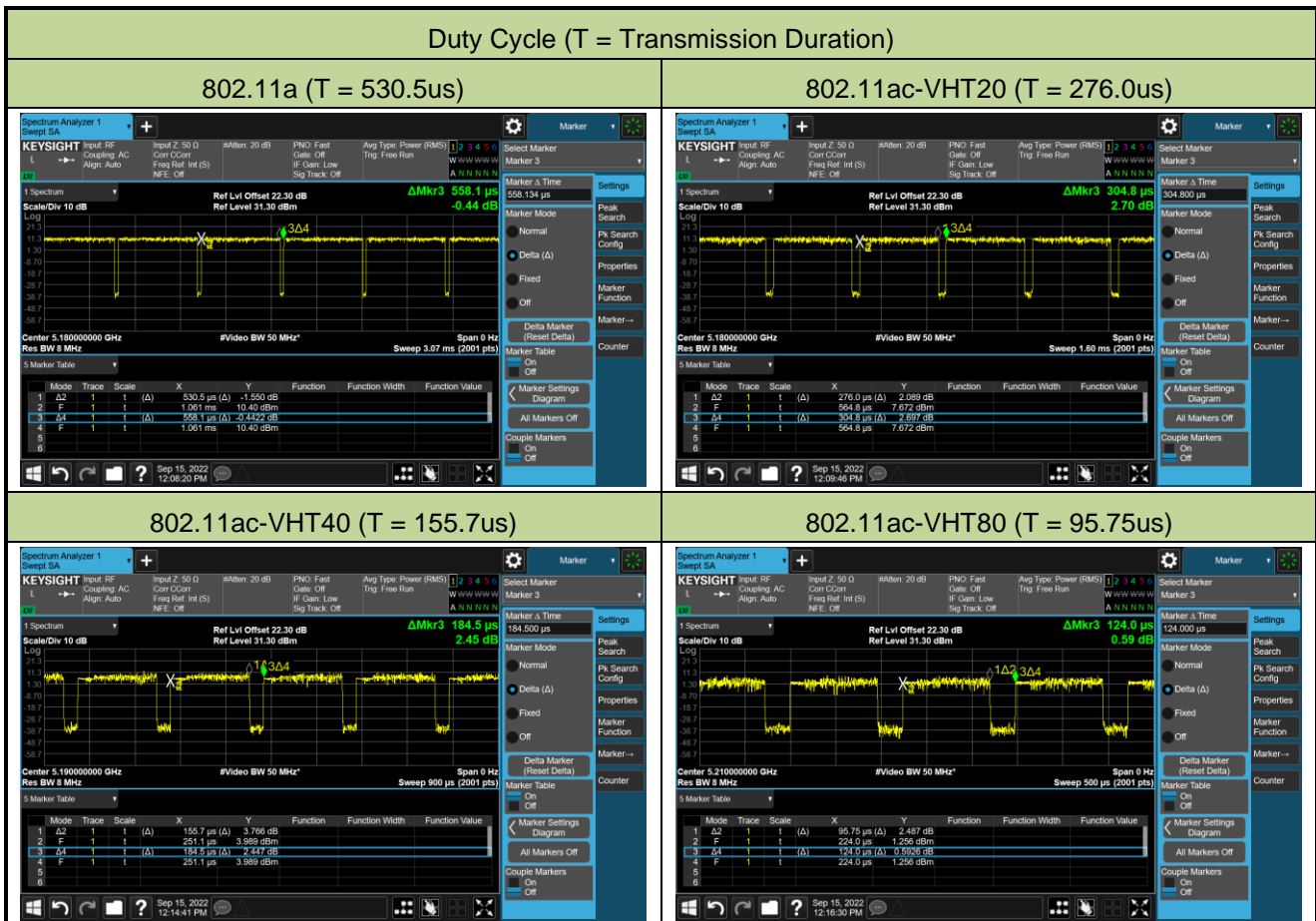

Duty Cycle (T = Transmission Duration)

802.11ac-VHT160 (T = 251.5us)

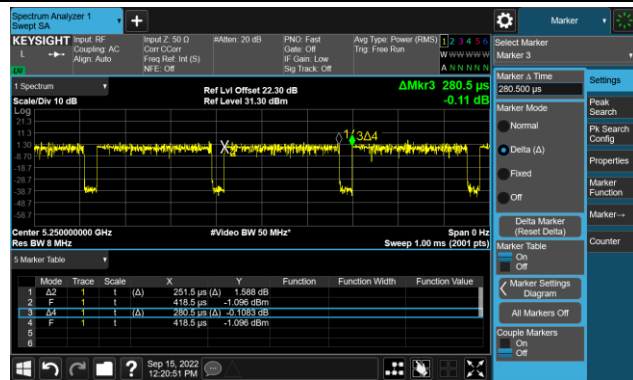

802.11ax-HE20 (T = 220.8us)

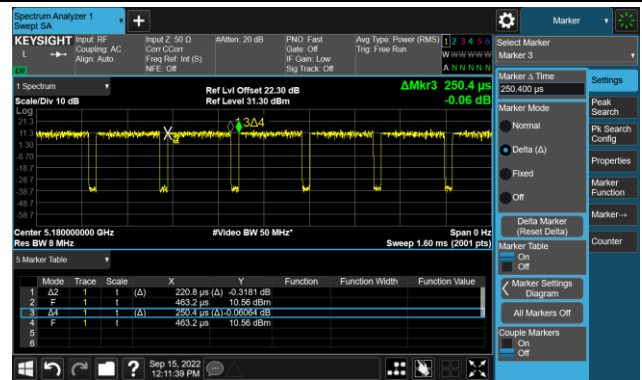

802.11ax-HE40 (T = 139.9us)

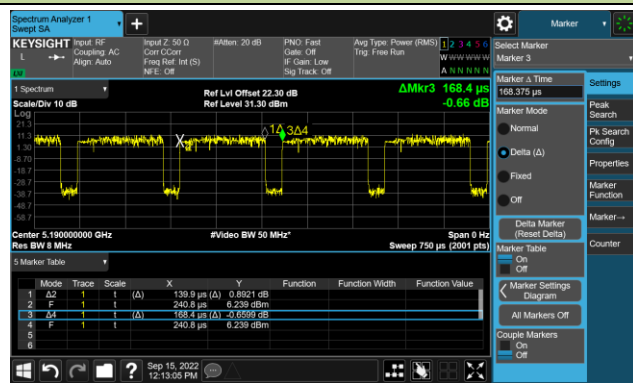

802.11ax-HE80 (T = 99.75us)

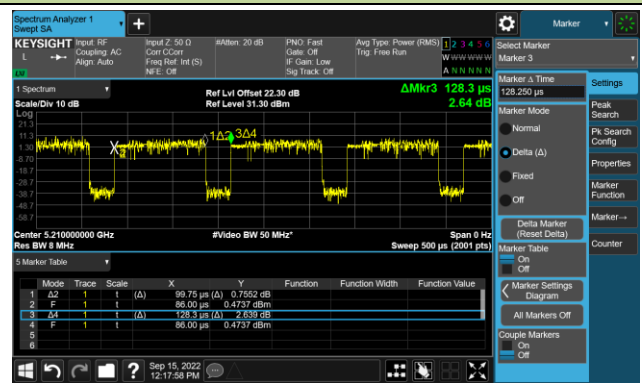

802.11ax-HE160 (T = 235.5us)

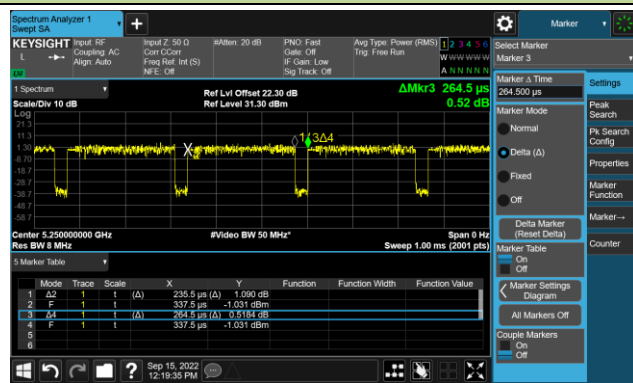

A.2 26dB Bandwidth Test Result

Test Site	SIP-TR1	Test Engineer	Nandy Zhang
Test Date	2022-11-17~2022-11-18		

Test Mode	Data Rate/ MCS	Channel No.	Frequency (MHz)	26dB Bandwidth (MHz)	99% Bandwidth (MHz)
11a	24Mbps	36	5180	21.66	16.717
11a	24Mbps	44	5220	21.10	16.654
11a	24Mbps	48	5240	21.20	16.663
11a	24Mbps	52	5260	21.12	16.651
11a	24Mbps	60	5300	21.24	16.653
11a	24Mbps	64	5320	21.67	16.756
11a	24Mbps	100	5500	21.47	16.764
11a	24Mbps	116	5580	21.13	16.687
11a	24Mbps	140	5700	20.87	16.680
11a	24Mbps	144	5720	21.11	16.637
11a	24Mbps	149	5745	21.46	16.702
11a	24Mbps	157	5785	22.31	16.832
11a	24Mbps	165	5825	22.71	16.834
11ac-VHT20	MCS5	36	5180	21.15	17.800
11ac-VHT20	MCS5	44	5220	21.15	17.839
11ac-VHT20	MCS5	48	5240	21.49	17.826
11ac-VHT20	MCS5	52	5260	21.35	17.782
11ac-VHT20	MCS5	60	5300	21.46	17.830
11ac-VHT20	MCS5	64	5320	21.16	17.829
11ac-VHT20	MCS5	100	5500	21.13	17.823
11ac-VHT20	MCS5	116	5580	21.55	17.789
11ac-VHT20	MCS5	140	5700	21.30	17.807
11ac-VHT20	MCS5	144	5720	21.39	17.827
11ac-VHT20	MCS5	149	5745	21.30	17.813
11ac-VHT20	MCS5	157	5785	21.46	17.823
11ac-VHT20	MCS5	165	5825	21.37	17.821

Test Mode	Data Rate/ MCS	Channel No.	Frequency (MHz)	26dB Bandwidth (MHz)	99% Bandwidth (MHz)
11ac-VHT40	MCS5	38	5190	40.31	36.356
11ac-VHT40	MCS5	46	5230	46.39	36.512
11ac-VHT40	MCS5	54	5270	39.57	36.348
11ac-VHT40	MCS5	62	5310	40.08	36.326
11ac-VHT40	MCS5	102	5510	39.83	36.317
11ac-VHT40	MCS5	110	5550	39.53	36.314
11ac-VHT40	MCS5	134	5670	39.56	36.349
11ac-VHT40	MCS5	142	5710	39.71	36.378
11ac-VHT40	MCS5	151	5755	39.55	36.390
11ac-VHT40	MCS5	159	5795	39.66	36.372
11ac-VHT80	MCS5	42	5210	81.94	75.878
11ac-VHT80	MCS5	58	5290	81.44	75.859
11ac-VHT80	MCS5	106	5530	81.25	75.879
11ac-VHT80	MCS5	122	5610	81.40	75.860
11ac-VHT80	MCS5	138	5690	81.06	75.855
11ac-VHT80	MCS5	155	5775	81.68	75.863
11ac-VHT160	MCS0	50	5250	163.2	154.22
11ac-VHT160	MCS0	114	5570	162.9	153.81
11ax-HE20	MCS6	36	5180	26.41	19.093
11ax-HE20	MCS6	44	5220	21.74	19.052
11ax-HE20	MCS6	48	5240	21.84	19.012
11ax-HE20	MCS6	52	5260	21.65	18.991
11ax-HE20	MCS6	60	5300	21.11	19.046
11ax-HE20	MCS6	64	5320	25.38	19.166
11ax-HE20	MCS6	100	5500	26.30	19.082
11ax-HE20	MCS6	116	5580	21.31	19.012
11ax-HE20	MCS6	140	5700	21.28	19.000
11ax-HE20	MCS6	144	5720	21.42	19.027
11ax-HE20	MCS6	149	5745	24.63	19.153
11ax-HE20	MCS6	157	5785	25.24	19.120
11ax-HE20	MCS6	165	5825	21.43	19.043

Test Mode	Data Rate/ MCS	Channel No.	Frequency (MHz)	26dB Bandwidth (MHz)	99% Bandwidth (MHz)
11ax-HE40	MCS6	38	5190	40.49	37.782
11ax-HE40	MCS6	46	5230	57.52	37.994
11ax-HE40	MCS6	54	5270	39.50	36.305
11ax-HE40	MCS6	62	5310	40.14	37.747
11ax-HE40	MCS6	102	5510	40.18	37.747
11ax-HE40	MCS6	110	5550	40.13	37.677
11ax-HE40	MCS6	134	5670	40.33	37.692
11ax-HE40	MCS6	142	5710	40.04	37.720
11ax-HE40	MCS6	151	5755	40.18	37.759
11ax-HE40	MCS6	159	5795	40.86	37.757
11ax-HE80	MCS6	42	5210	81.27	77.209
11ax-HE80	MCS6	58	5290	81.40	77.308
11ax-HE80	MCS6	106	5530	81.90	77.210
11ax-HE80	MCS6	122	5610	81.39	77.169
11ax-HE80	MCS6	138	5690	81.48	77.121
11ax-HE80	MCS6	155	5775	81.24	77.283
11ax-HE160	MCS0	50	5250	164.2	156.34
11ax-HE160	MCS0	114	5570	164.0	156.12

Test Mode	Data Rate/ MCS	Channel No.	Frequency (MHz)	F _H (MHz)	Limit (MHz)
11a	24Mbps	48	5240	5248.33	< 5250
11ac-VHT20	MCS5	48	5240	5248.91	< 5250
11ac-VHT40	MCS5	46	5230	5248.26	< 5250
11ac-VHT80	MCS5	42	5210	5247.94	< 5250
11ax-HE20	MCS6	48	5240	5249.51	< 5250
11ax-HE40	MCS6	46	5230	5249.00	< 5250
11ax-HE80	MCS6	42	5210	5248.60	< 5250

Note: $F_H = \text{Centre frequency} + 99\% \text{ OBW} / 2$.

For example, 802.11a 5240MHz, $F_H = 5240 \text{ MHz} + 16.663 \text{ MHz} / 2 = 5248.33 \text{ MHz}$.

802.11a 26dB Bandwidth

Channel 36 (5180MHz)

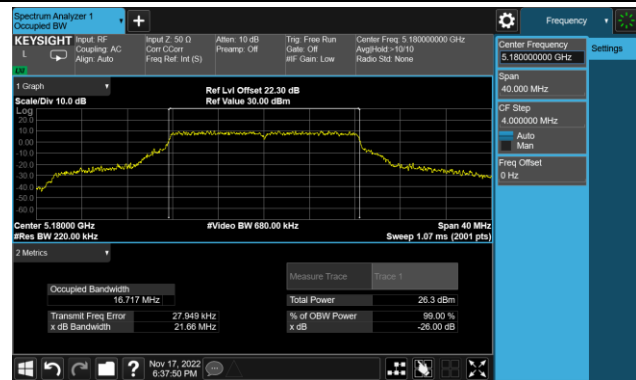

Channel 44 (5220MHz)

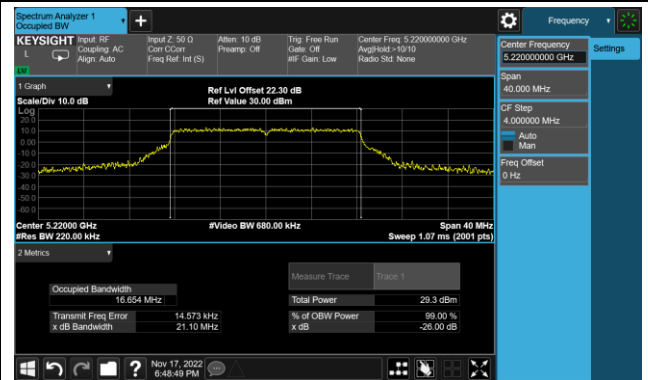

Channel 48 (5240MHz)



Channel 52 (5260MHz)

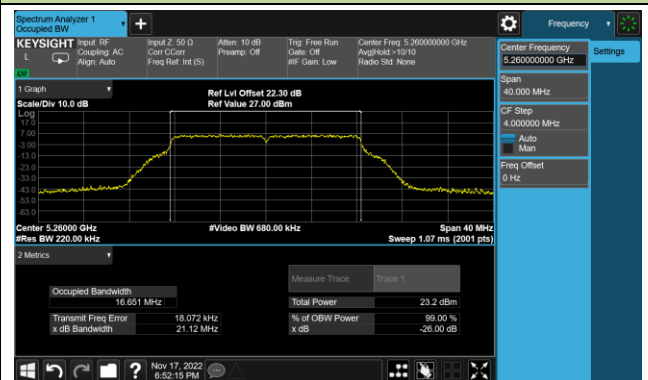

Channel 60 (5300MHz)

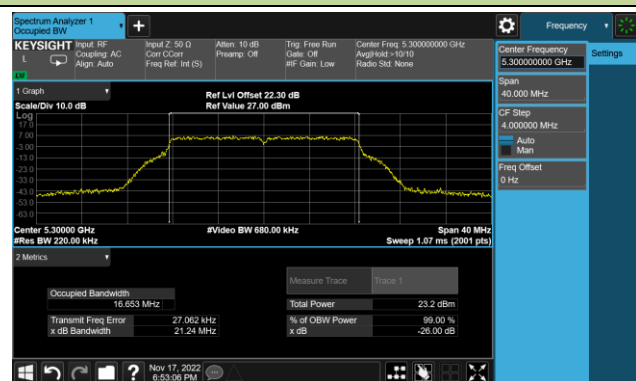

Channel 64 (5320MHz)

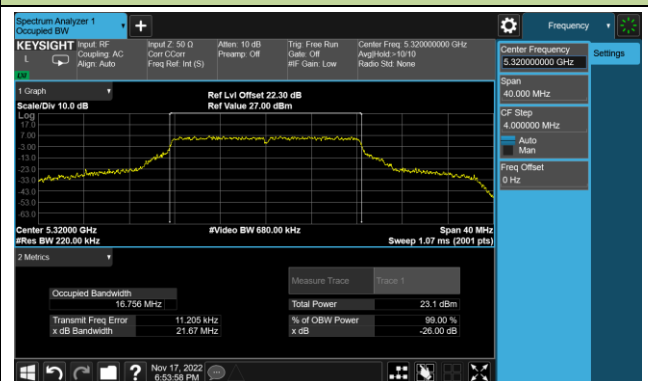

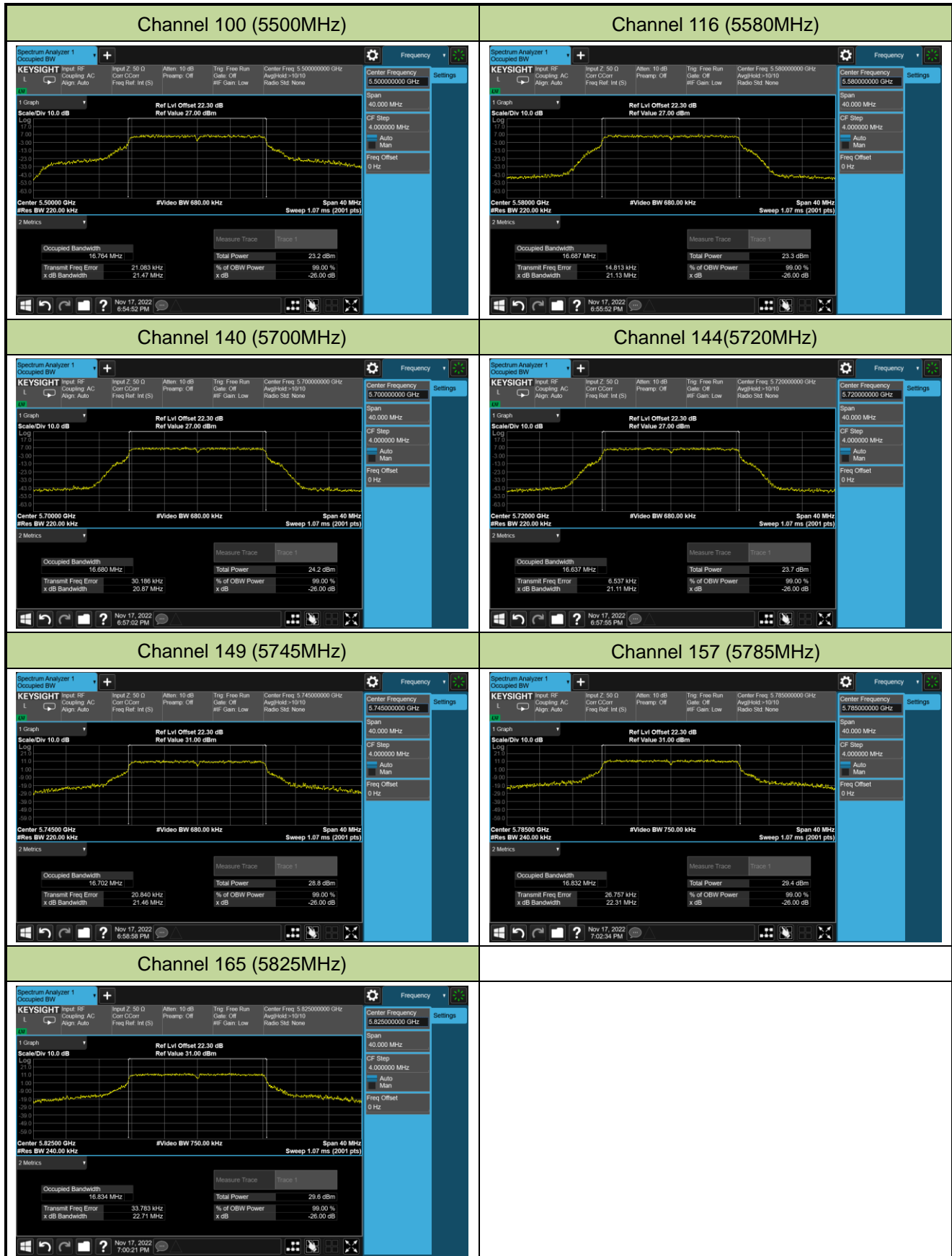

802.11ac-VHT20 26dB Bandwidth

Channel 36 (5180MHz)

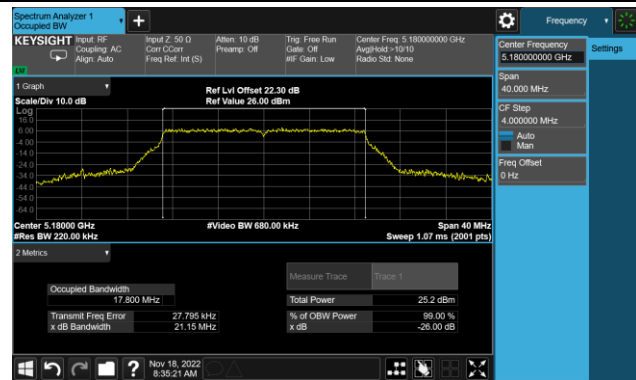

Channel 44 (5220MHz)

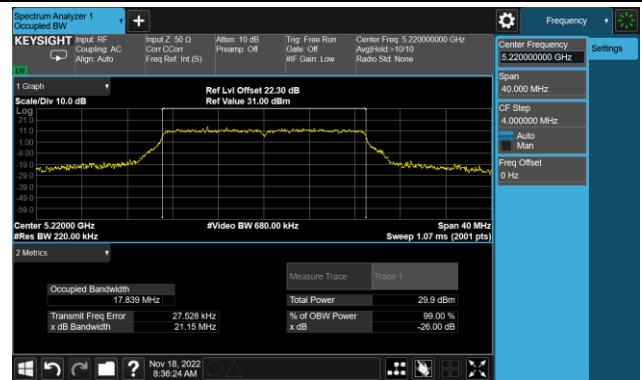

Channel 48 (5240MHz)

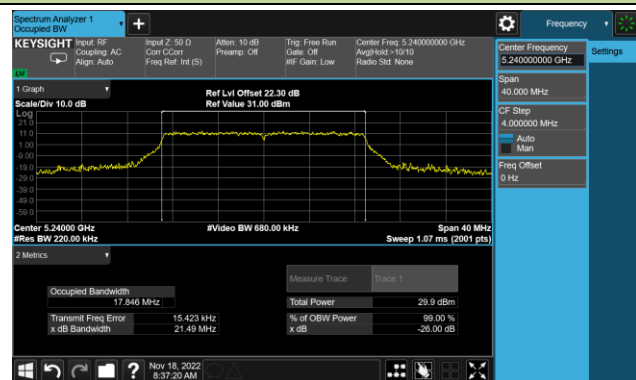

Channel 52 (5260MHz)

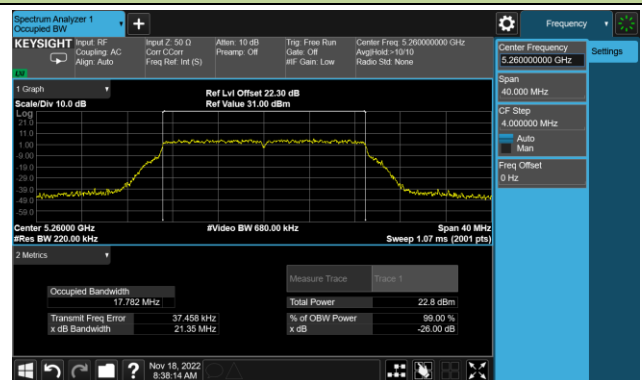

Channel 60 (5300MHz)



Channel 64 (5320MHz)

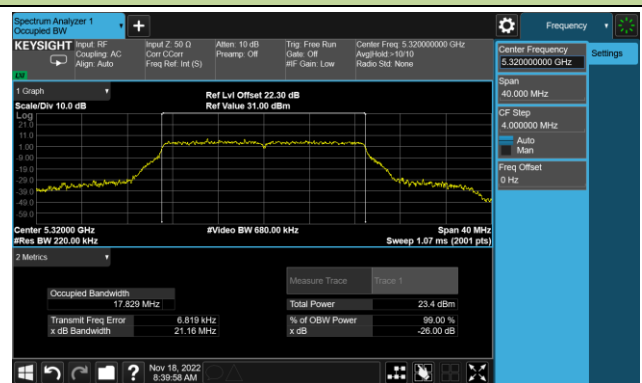

802.11ac-VHT20 26dB Bandwidth

Channel 100 (5500MHz)

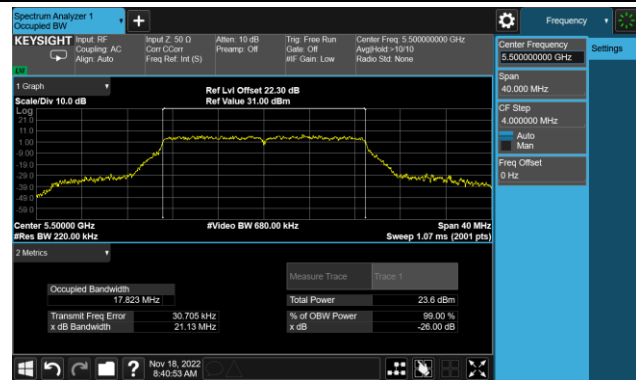

Channel 116 (5580MHz)

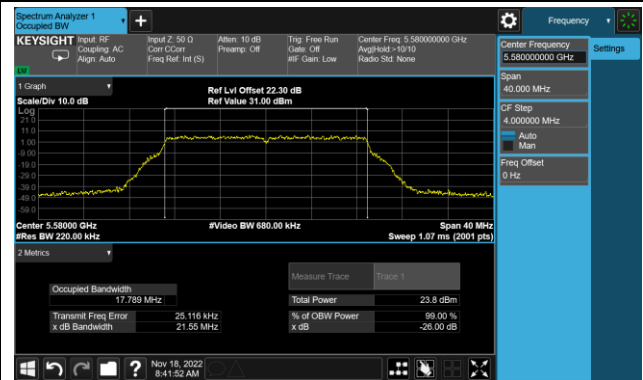

Channel 140 (5700MHz)

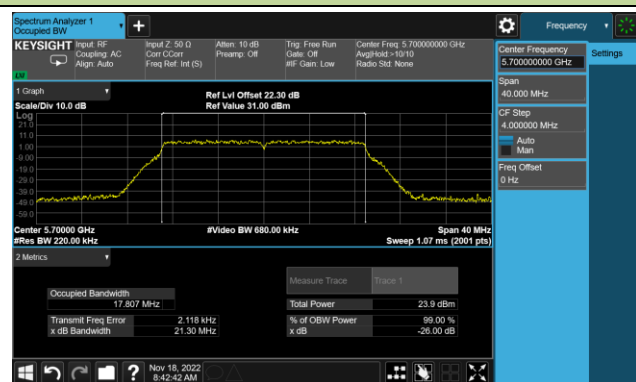

Channel 144(5720MHz)

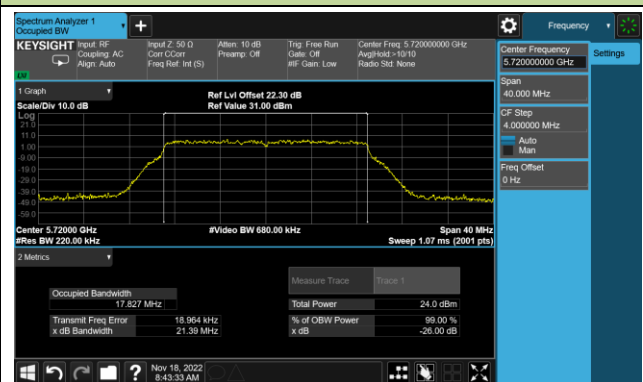

Channel 149 (5745MHz)

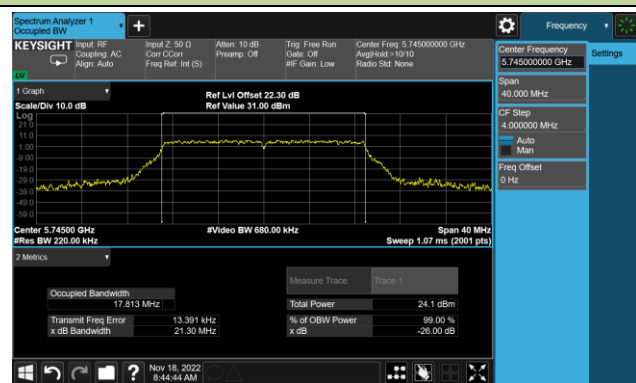

Channel 157 (5785MHz)

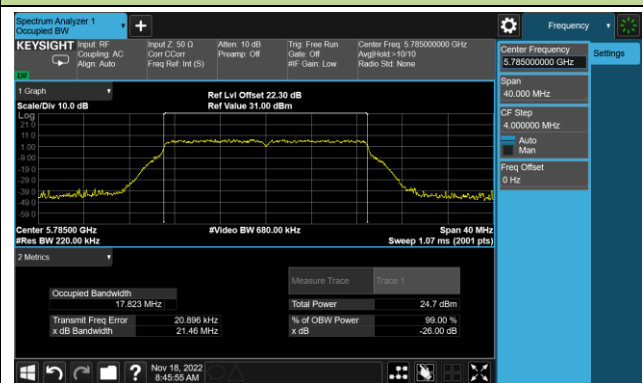

Channel 165 (5825MHz)



802.11ac-VHT40 26dB Bandwidth

Channel 38 (5190MHz)

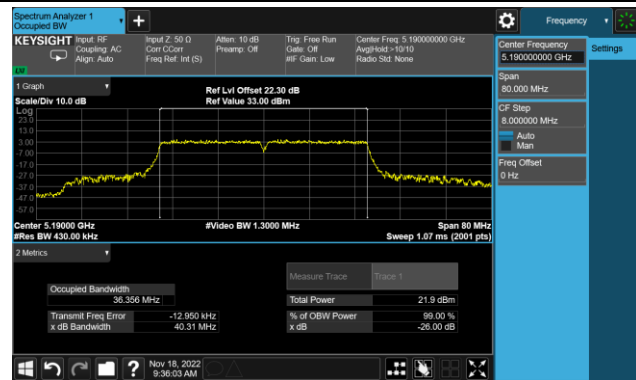

Channel 46 (5230MHz)

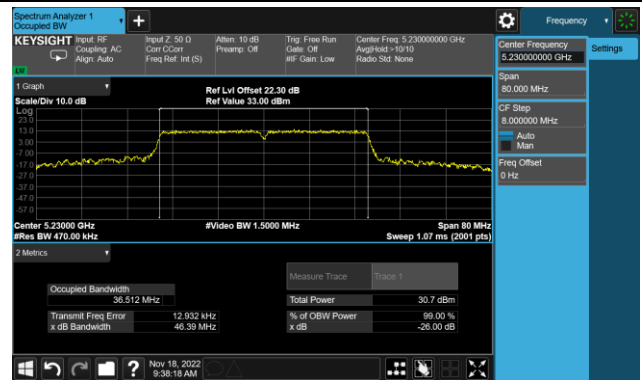

Channel 54 (5270MHz)

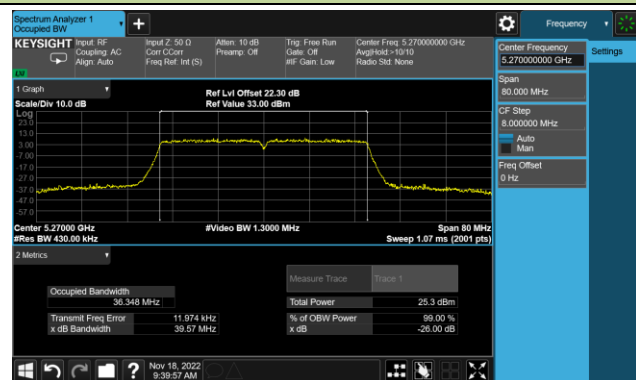

Channel 62 (5310MHz)

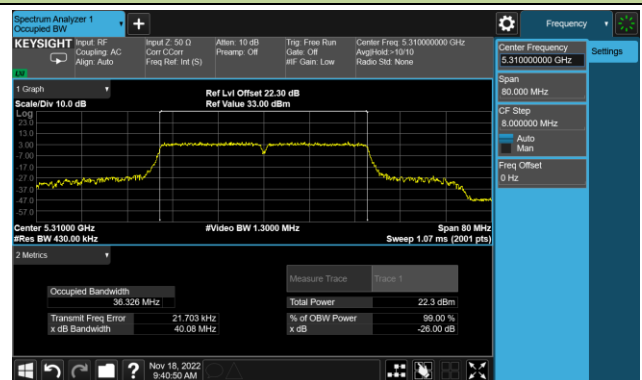

Channel 102 (5510MHz)

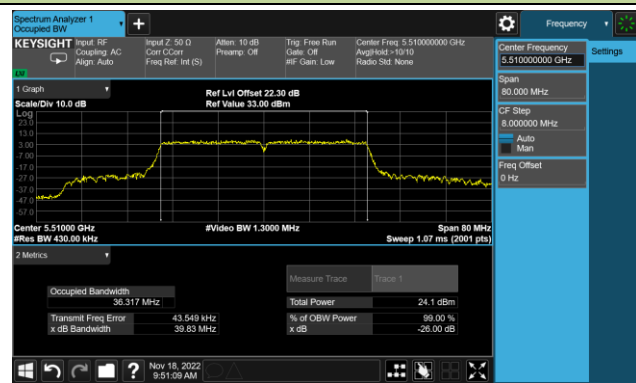

Channel 110 (5550MHz)

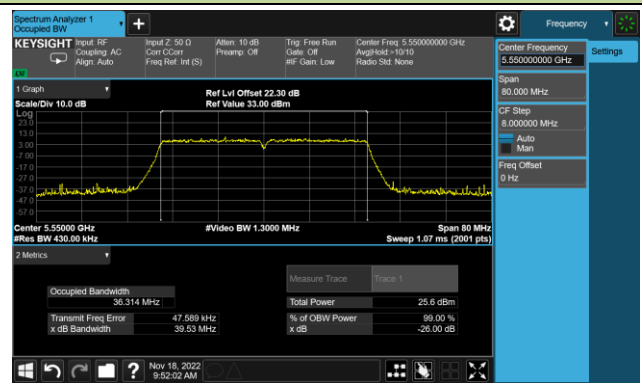

802.11ac-VHT40 26dB Bandwidth

Channel 134 (5670MHz)

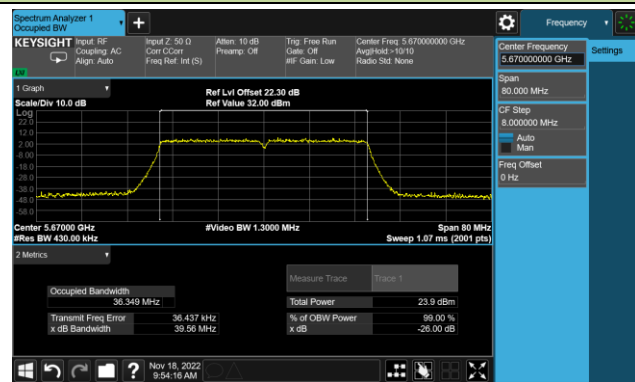

Channel 142(5710MHz)

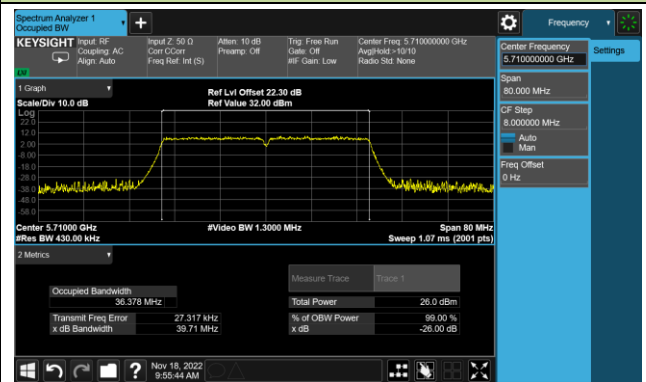

Channel 151 (5755MHz)

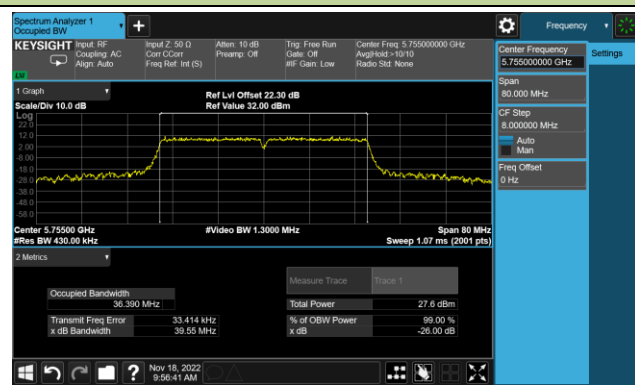

Channel 159 (5795MHz)

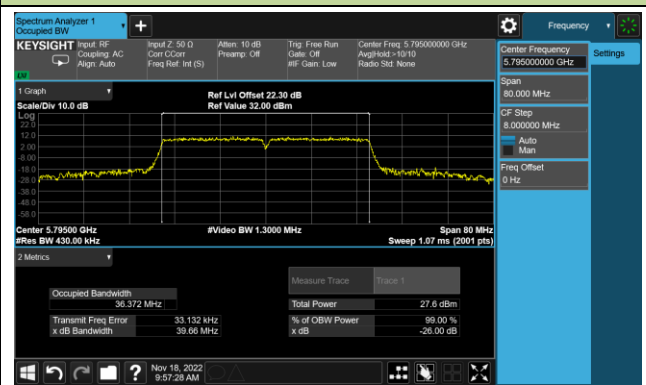

802.11ac-VHT80 26dB Bandwidth

Channel 42 (5210MHz)

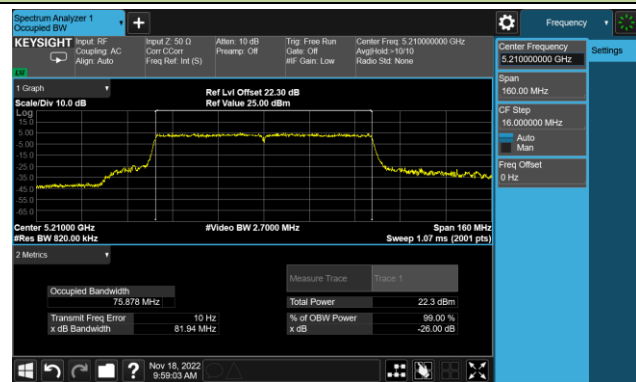

Channel 58 (5290MHz)

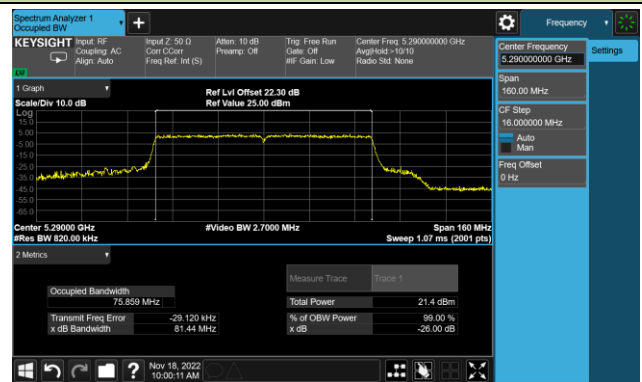

Channel 106 (5530MHz)

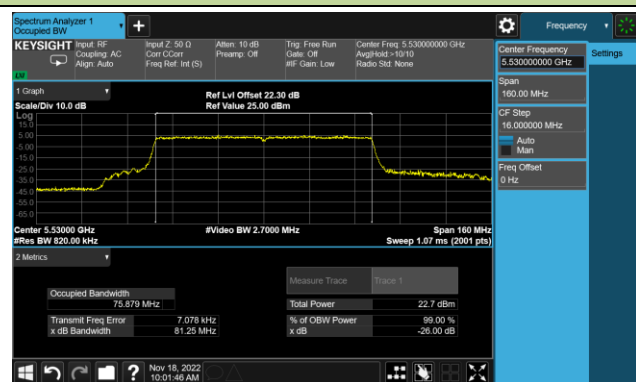

Channel 122 (5610MHz)

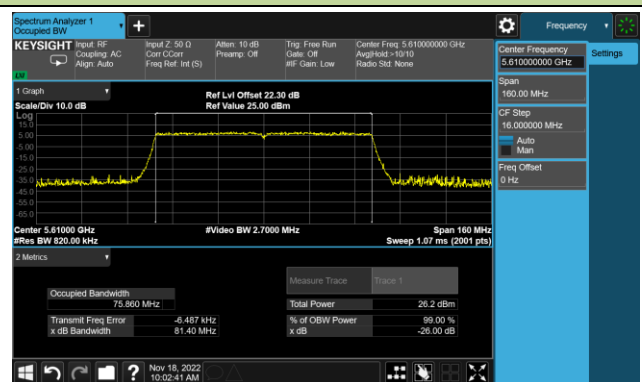

Channel 138 (5690MHz)

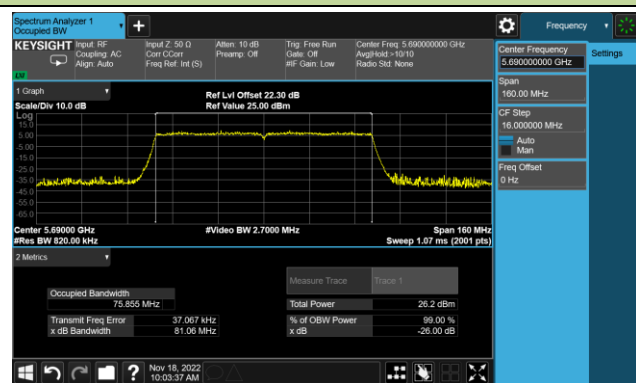

Channel 155 (5775MHz)

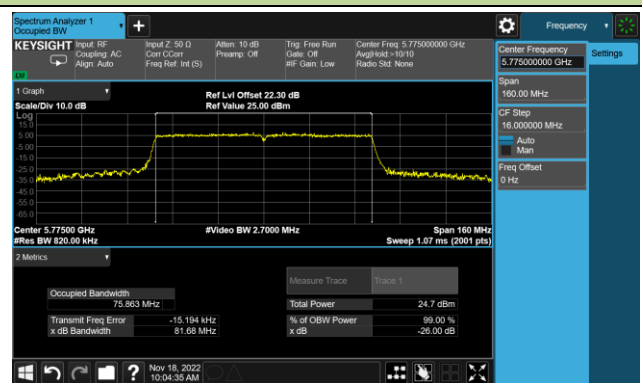

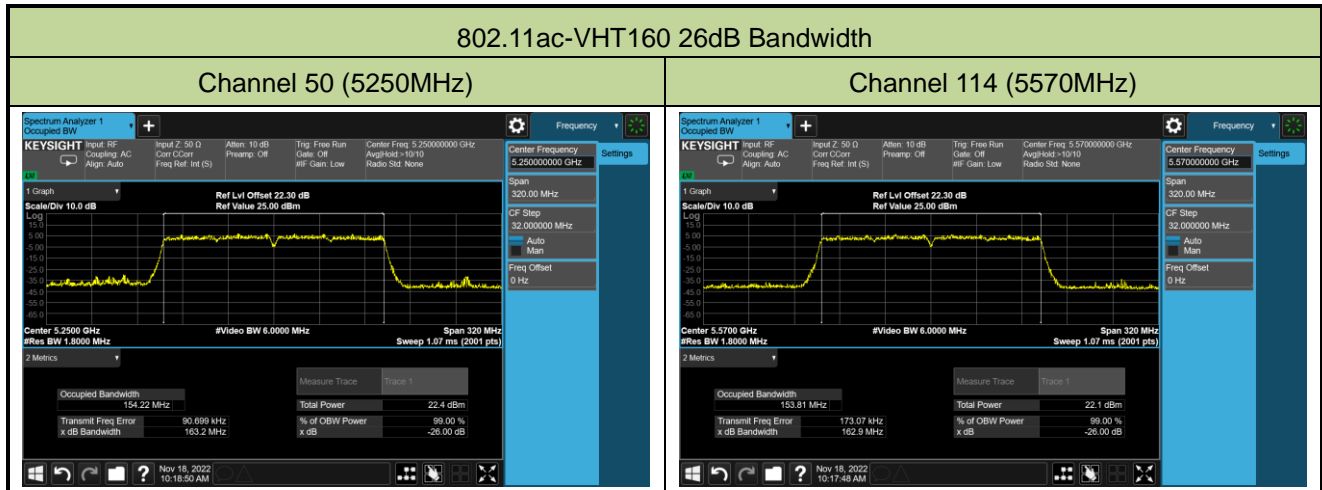

802.11ax-HE20 26dB Bandwidth

Channel 36 (5180MHz)

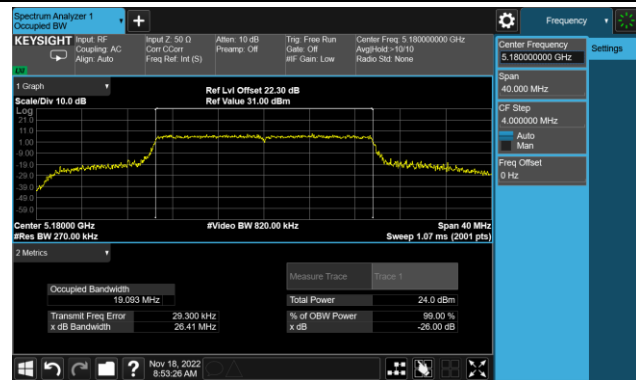

Channel 44 (5220MHz)

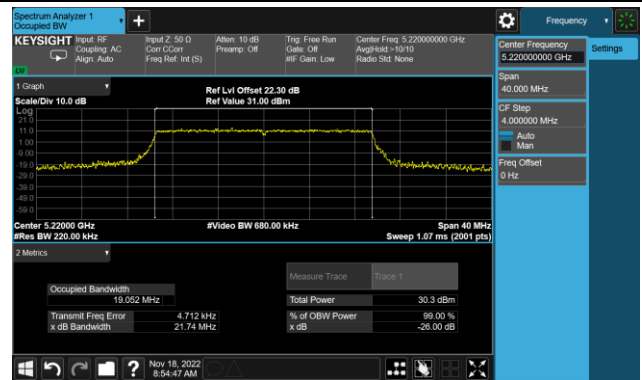

Channel 48 (5240MHz)

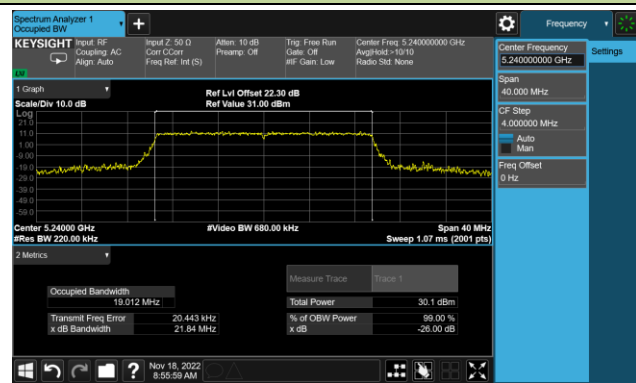

Channel 52 (5260MHz)

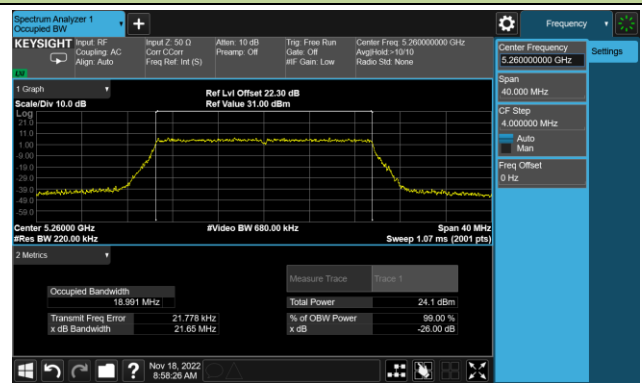

Channel 60 (5300MHz)

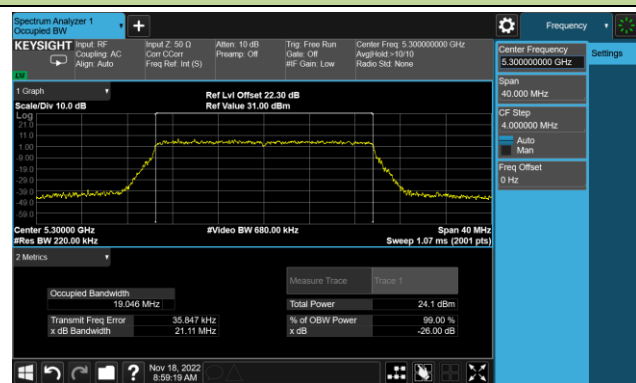

Channel 64 (5320MHz)

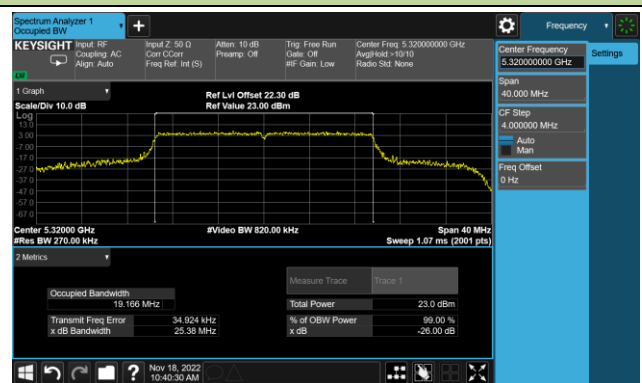

802.11ax-HE20 26dB Bandwidth

Channel 100 (5500MHz)

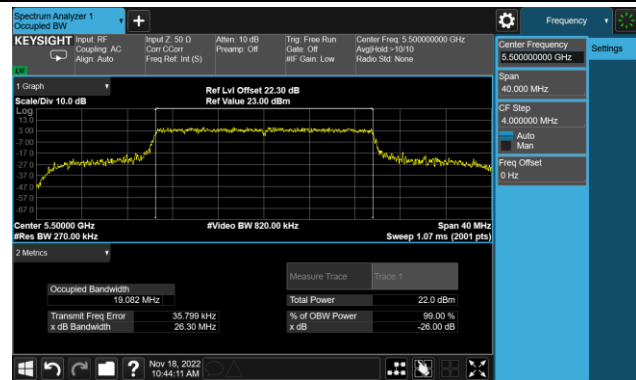

Channel 116 (5580MHz)

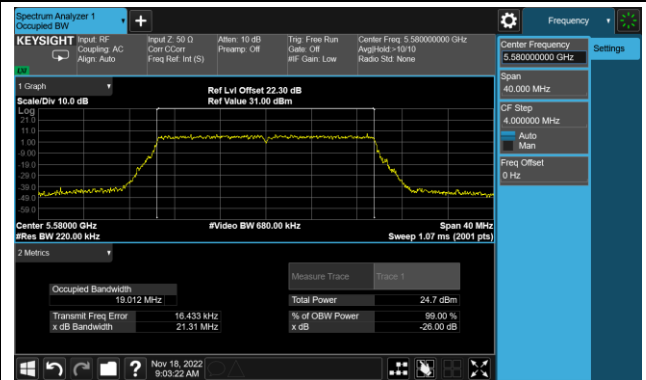

Channel 140 (5700MHz)

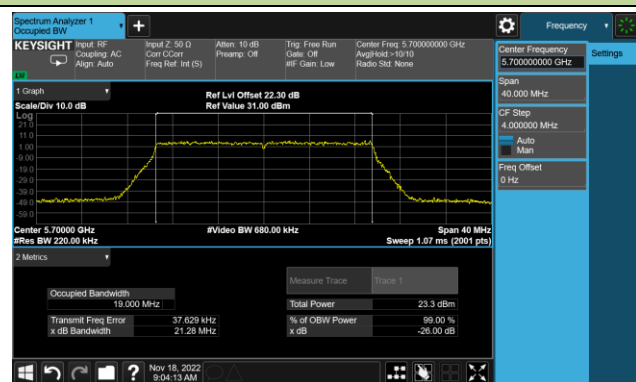

Channel 144(5720MHz)

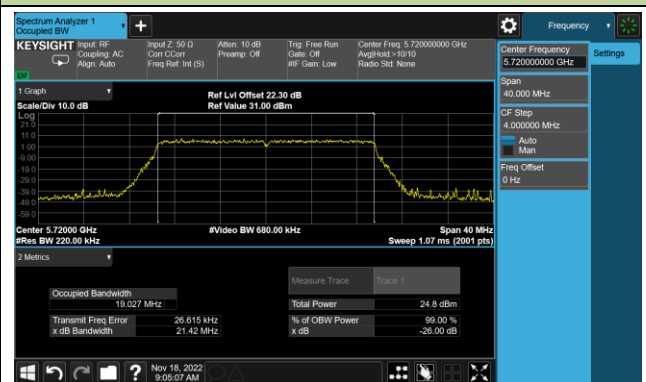

Channel 149 (5745MHz)

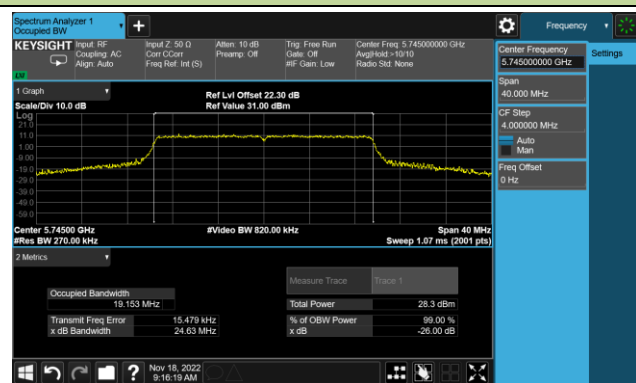

Channel 157 (5785MHz)

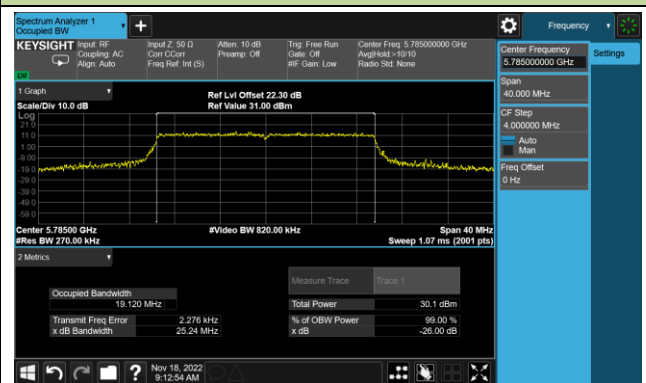

Channel 165 (5825MHz)

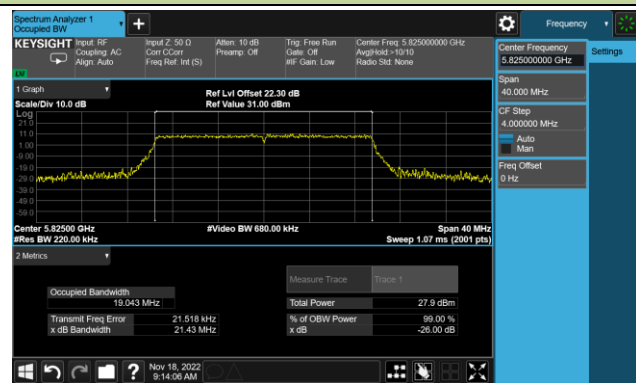

802.11ax-HE40 26dB Bandwidth

Channel 38 (5190MHz)

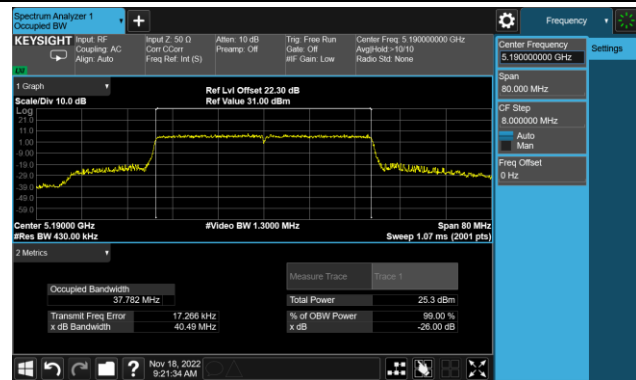

Channel 46 (5230MHz)

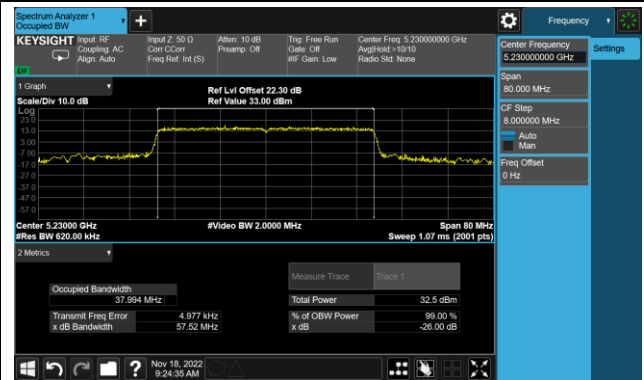

Channel 54 (5270MHz)

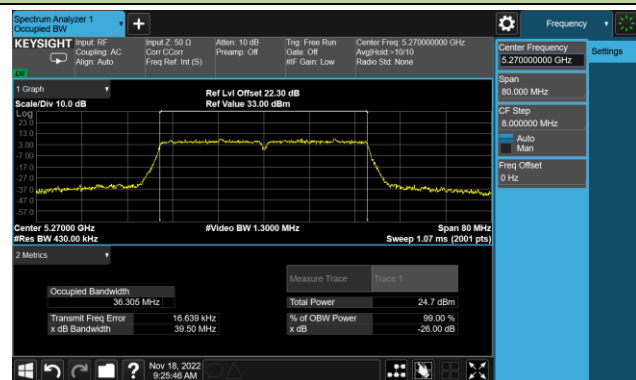

Channel 62 (5310MHz)

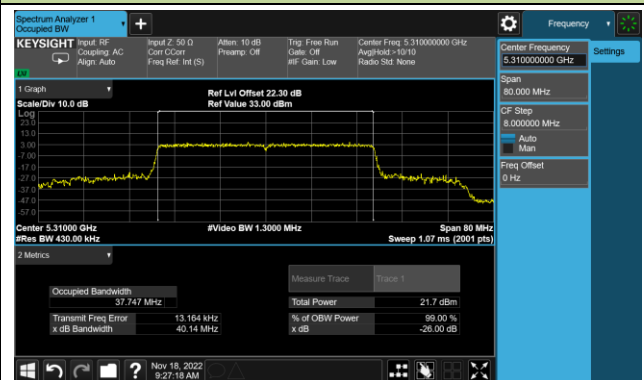

Channel 102 (5510MHz)

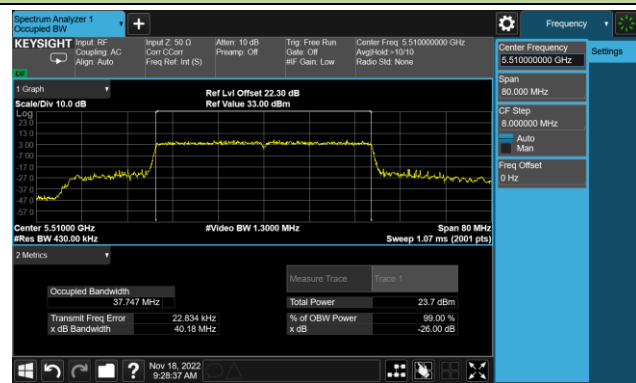

Channel 110 (5550MHz)

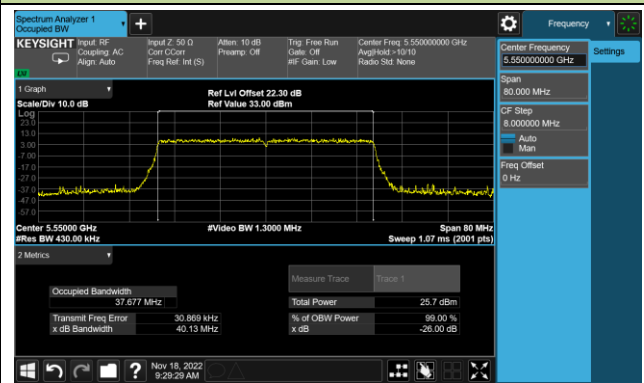

802.11ax-HE40 26dB Bandwidth

Channel 134 (5670MHz)

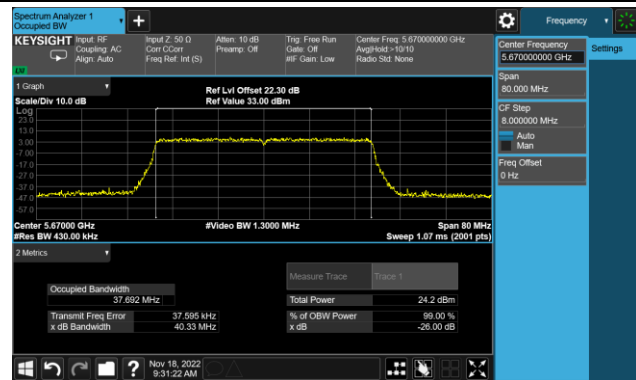

Channel 142(5710MHz)

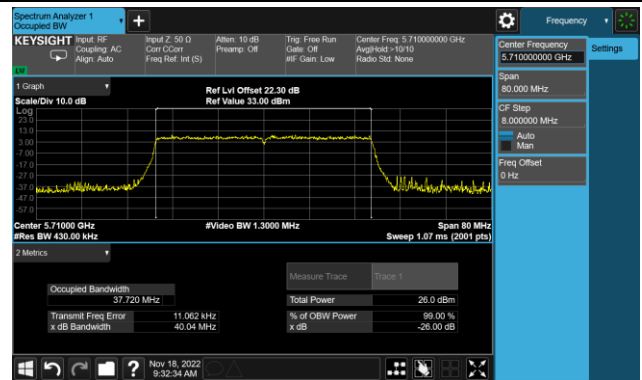

Channel 151 (5755MHz)

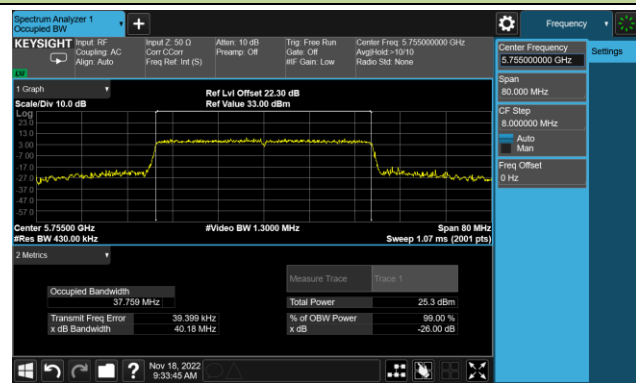

Channel 159 (5795MHz)

