

RF MEASUREMENT REPORT

FCC ID: VW3FAST5670

Applicant: SAGEMCOM BROADBAND SAS

Product: Residential Cable Gateway

Model No.: F@ST5670V2 XXXXXXXXXXXX
(XXXXXXXXXX, X can be A~Z, space and other presentation, XXXXXXXXXXXX can be replaced by Millicom and other presentation, it is various by different marketing)

Brand Name: SAGEMCOM

FCC Classification: Digital Transmission System (DTS)

FCC Rule Part(s): Part 15 Subpart C (Section 15.247)

Result: Complies

Test Date: 2022-09-15 ~ 2022-11-17

Reviewed By:

Sunny Sun

Approved By:

Robin Wu



The test results relate only to the samples tested.

This equipment has been shown to be capable of compliance with the applicable technical standards as indicated in the measurement report and was tested in accordance with the measurement procedures specified in ANSI C63.10-2013. Test results reported herein relate only to the item(s) tested.

The test report shall not be reproduced except in full without the written approval of MRT Technology (Suzhou) Co., Ltd.

Revision History

Report No.	Version	Description	Issue Date	Note
2209RSU020-U1	Rev. 01	Initial Report	2022-12-02	Valid

CONTENTS

Description	Page
1. General Information	5
1.1. Applicant	5
1.2. Manufacturer	5
1.3. Testing Facility	5
1.4. Product Information.....	6
1.5. Radio Specification under Test	6
1.6. Working Frequencies	7
1.7. Antenna Details.....	8
2. Test Configuration	9
2.1. Test Mode.....	9
2.2. Test System Connection Diagram.....	10
2.3. Test Software	11
2.4. Applied Standards.....	11
2.5. Test Environment Condition	11
3. Antenna Requirements	12
4. Measuring Instrument	13
5. Decision Rules and Measurement Uncertainty	14
5.1. Decision Rules	14
5.2. Measurement Uncertainty	14
6. Test Result.....	15
6.1. Summary.....	15
6.2. 6dB Bandwidth Measurement.....	16
6.2.1. Test Limit	16
6.2.2. Test Procedure.....	16
6.2.3. Test Setting	16
6.2.4. Test Setup	16
6.2.5. Test Result	16
6.3. Output Power Measurement	17
6.3.1. Test Limit	17
6.3.2. Test Procedure.....	17
6.3.3. Test Setting	17
6.3.4. Test Setup	17
6.3.5. Test Result	17
6.4. Power Spectral Density Measurement	18
6.4.1. Test Limit	18

6.4.2.	Test Procedure	18
6.4.3.	Test Setting	18
6.4.4.	Test Setup	18
6.4.5.	Test Result	19
6.5.	Conducted Band Edge and Out-of-Band Emissions Measurement	20
6.5.1.	Test Limit	20
6.5.2.	Test Procedure	20
6.5.3.	Test Setting	20
6.5.4.	Test Setup	20
6.5.5.	Test Result	21
6.6.	Radiated Spurious Emission Measurement.....	22
6.6.1.	Test Limit	22
6.6.2.	Test Procedure	22
6.6.3.	Test Setting	22
6.6.4.	Test Setup	24
6.6.5.	Test Result	25
6.7.	Radiated Restricted Band Edge Measurement	26
6.7.1.	Test Limit	26
6.7.2.	Test Procedure	27
6.7.3.	Test Setting	27
6.7.4.	Test Setup	28
6.7.5.	Test Result	28
6.8.	AC Conducted Emissions Measurement	29
6.8.1.	Test Limit	29
6.8.2.	Test Setup	29
6.8.3.	Test Result	29
Appendix A – Test Result		30
A.1	Duty Cycle Test Result	30
A.2	6dB Bandwidth Test Result	32
A.3	Output Power Test Result	39
A.4	Power Spectral Density Test Result.....	41
A.5	Conducted Band Edge and Out-of-Band Emissions Test Result.....	60
A.6	Radiated Spurious Emission Test Result.....	97
A.7	Radiated Restricted Band Edge Test Result.....	105
A.8	AC Conducted Emissions Test Result	177
Appendix B – Test Setup Photograph		179
Appendix C – EUT Photograph		180

1. General Information

1.1. Applicant

SAGEMCOM BROADBAND SAS

250 Route de l'Empereur - 92848 RUEIL MALMAISON CEDEX- FRANCE

1.2. Manufacturer

SAGEMCOM BROADBAND SAS

250 Route de l'Empereur - 92848 RUEIL MALMAISON CEDEX- FRANCE

1.3. Testing Facility

<input checked="" type="checkbox"/>	<p>Test Site – MRT Suzhou Laboratory</p> <hr/> <p>Laboratory Location (Suzhou - Wuzhong) D8 Building, No.2 Tian'edang Rd., Wuzhong Economic Development Zone, Suzhou, China</p> <p>Laboratory Location (Suzhou - SIP) 4b Building, Liando U Valley, No.200 Xingpu Rd., Shengpu Town, Suzhou Industrial Park, China</p> <hr/> <p>Laboratory Accreditations</p> <p>A2LA: 3628.01 CNAS: L10551 FCC: CN1166 ISED: CN0001</p> <p>VCCI: <input type="checkbox"/>R-20025 <input type="checkbox"/>G-20034 <input type="checkbox"/>C-20020 <input type="checkbox"/>T-20020 <input type="checkbox"/>R-20141 <input type="checkbox"/>G-20134 <input type="checkbox"/>C-20103 <input type="checkbox"/>T-20104</p>
<input type="checkbox"/>	<p>Test Site – MRT Shenzhen Laboratory</p> <hr/> <p>Laboratory Location (Shenzhen) 1G, Building A, Junxiangda Building, Zhongshanyuan Road West, Nanshan District, Shenzhen, China</p> <hr/> <p>Laboratory Accreditations</p> <p>A2LA: 3628.02 CNAS: L10551 FCC: CN1284 ISED: CN0105</p>
<input type="checkbox"/>	<p>Test Site – MRT Taiwan Laboratory</p> <hr/> <p>Laboratory Location (Taiwan) No. 38, Fuxing 2nd Rd., Guishan Dist., Taoyuan City 333, Taiwan (R.O.C.)</p> <hr/> <p>Laboratory Accreditations</p> <p>TAF: L3261-190725 FCC: 291082, TW3261 ISED: TW3261</p>

1.4. Product Information

Product Name	Residential Cable Gateway
Model No.	F@ST5670V2 XXXXXXXXXXXX (XXXXXXXXXXXX, X can be A~Z, space and other presentation, XXXXXXXXXXXX can be replaced by Millicom and other presentation, it is various by different marketing)
Serial No.	N7222669R000034
Wi-Fi Specification	802.11a/b/g/n/ac/ax
Antenna Information	Refer to section 1.7
Working Voltage	12VDC
Accessories	
Adapter #1	Model: NBS24N120200VU Input: 100-240V ~ 50/60Hz 0.6A Output: 12.0V === 2.0A
Adapter #2	Model: MS-V2000R120-024Q0-US Input: 100-240V ~ 50/60Hz 0.7A Max Output: 12.0V === 2.0A
Note: The information of EUT was provided by the manufacturer, and the accuracy of the information shall be the responsibility of the manufacturer.	

1.5. Radio Specification under Test

Frequency Range	802.11b/g/n-HT20/ax-HE20: 2412 ~ 2462MHz 802.11n-HT40/ax-HE40: 2422 ~ 2452MHz
Channel Number	802.11b/g/n-HT20/ax-HE20: 11 802.11n-HT40/ax-HE40: 7
Type of Modulation	802.11b: DSSS 802.11g/n: OFDM 802.11ax: OFDMA
Data Rate	802.11b: 1/2/5.5/11Mbps 802.11g: 6/9/12/18/24/36/48/54Mbps 802.11n: up to 450Mbps 802.11ax: up to 861Mbps

The EUT incorporates the CDD, Beamforming, MIMO function. Physically, the EUT provides 4 completed transmitters and 4 receivers.

Mode	CDD Mode	Beamforming	TX Function
802.11b/g	√	x	3Tx
802.11n-HT20	√	√	3Tx
802.11n-HT40	√	√	3Tx
802.11ax-HE20	√	√	3Tx
802.11ax-HE40	√	√	3Tx

1.6. Working Frequencies

802.11b/g/n-HT20/ax-HE20

Channel	Frequency	Channel	Frequency	Channel	Frequency
01	2412 MHz	02	2417 MHz	03	2422 MHz
04	2427 MHz	05	2432 MHz	06	2437 MHz
07	2442 MHz	08	2447 MHz	09	2452 MHz
10	2457 MHz	11	2462 MHz	--	--

802.11n-HT40/ax-HE40

Channel	Frequency	Channel	Frequency	Channel	Frequency
03	2422 MHz	04	2427 MHz	05	2432 MHz
06	2437 MHz	07	2442 MHz	08	2447 MHz
09	2452 MHz	--	--	--	--

1.7. Antenna Details

Antenna Type	Frequency Band (GHz)	Ant 1	Ant 2	Ant 3	Ant 4	Directional Gain (dBi)	
		Max Peak Gain (dBi)	Max Peak Gain (dBi)	Max Peak Gain (dBi)	Max Peak Gain (dBi)	For Power	For PSD
Wi-Fi Antenna							
PIFA	2.4 ~ 2.5	2.66	1.55	1.57	--	2.66	4.08
	5.15 ~ 5.35	4.54	3.90	3.98	2.78	4.54	6.44
	5.47 ~ 5.725	4.25	3.20	4.48	3.55	4.48	5.95
	5.725 ~ 5.85	3.00	3.28	5.12	3.23	5.12	6.66
<p>Note 1: The antenna gain and directional gain refer to manufacturer's antenna specification.</p> <p>Note 2: Software automatically backs power down based on a $10\log(N)$ factor for beamforming operation.</p> <p>Note 3: The EUT supports Cyclic Delay Diversity (CDD) mode, and CDD signals are correlated.</p> <ul style="list-style-type: none"> ● For power measurements: Array Gain = 0 dB for $N_{ANT} \leq 4$, the directional gain = max antenna gain + array gain ● For power density measurements: the max directional gain (each angle) = $10 \cdot \log[(10^{G1/20} + 10^{G2/20} + \dots + 10^{GN/20})^2 / N_{ANT}]$ dBi. 							

2. Test Configuration

2.1. Test Mode

CDD Mode
Mode 1: Transmit by 802.11b_N _{SS} =1 (1Mbps) (MIMO Mode)
Mode 2: Transmit by 802.11g_N _{SS} =1 (6Mbps) (MIMO Mode)
Mode 3: Transmit by 802.11n-HT20 (MCS0)_N _{SS} =1 (MIMO Mode)
Mode 4: Transmit by 802.11n-HT40 (MCS0)_N _{SS} =1 (MIMO Mode)
Mode 5: Transmit by 802.11ax-HE20 (MCS0)_N _{SS} =1 (MIMO Mode)
Mode 6: Transmit by 802.11ax-HE40 (MCS0)_N _{SS} =1 (MIMO Mode)
Remark: <ol style="list-style-type: none"> For radiated spurious emission, the modulation and the data rate picked for testing are determined by the Max. RF conducted power. This device supports 4 N_{SS} and power level is the same of spatial multiplexing. The worst case is N_{SS}=1. RF power on each chain in MIMO mode is greater than SISO mode. The SISO Mode is covered by MIMO Mode. After preliminary scan designated by the manufacturer, CDD mode is determined to be the worst case compared to Beamforming mode, hence, all the radiated test is performed in CDD mode. For beamforming operation, manufacturer automatically backs power down based on a 10log (N_{ANT}) factor based on CDD power. Therefore, only the CDD mode was evaluated in this report. EUT supports one configuration only in 802.11ax full RU mode.

2.2. Test System Connection Diagram

The device was tested per the guidance ANSI C63.10: 2013 was used to reference the appropriate EUT setup for radiated emissions testing and AC line conducted testing.

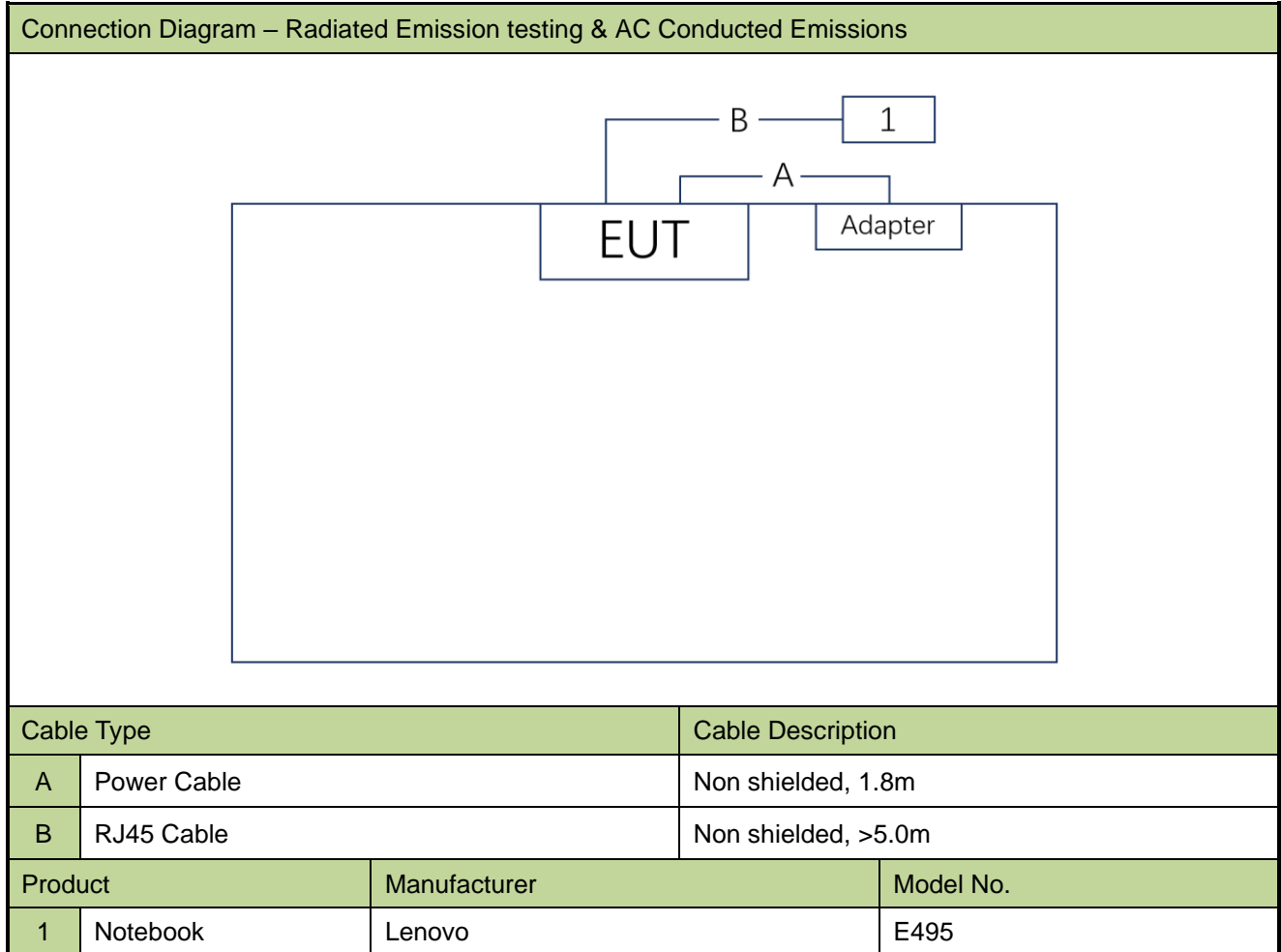

2.3. Test Software

The test utility software used during testing was “accessMTool.exe”, and the version was 3.2.1.4.

2.4. Applied Standards

According to the specifications of the manufacturer, the EUT must comply with the requirements of the following standards:

- FCC Part 15.247
- KDB 558074 D01v05r02
- KDB 662911 D01v02r01
- ANSI C63.10-2013

2.5. Test Environment Condition

Ambient Temperature	15 ~ 35°C
Relative Humidity	20 ~ 75%RH

3. Antenna Requirements

Excerpt from §15.203 of the FCC Rules/Regulations:

“An intentional radiator antenna shall be designed to ensure that no antenna other than that furnished by the responsible party can be used with the device. The use of a permanently attached antenna or of an antenna that uses a unique coupling to the intentional radiator shall be considered sufficient to comply with the provisions of this section.”

- The antenna of the device is **permanently attached**.
- There are no provisions for connection to an external antenna.

Conclusion:

The unit complies with the requirement of §15.203.

4. Measuring Instrument

Instrument	Manufacturer	Model No.	Asset No.	Cali. Interval	Cali. Due Date	Test Site
Signal Analyzer	Keysight	N9010B	MRTSUE06603	1 year	2023-10-25	SIP-AC1
Anechoic Chamber	RIKEN	SIP-AC1	MRTSUE06554	1 year	2022-12-23	SIP-AC1
Preamplifier	EMCI	EMC051845SE	MRTSUE06600	1 year	2023-11-07	SIP-AC1
Horn Antenna	R&S	HF907	MRTSUE06610	1 year	2023-07-13	SIP-AC1
Thermohygrometer	testo	608-H1	MRTSUE06616	1 year	2023-11-01	SIP-AC1
Thermohygrometer	testo	608-H1	MRTSUE06620	1 year	2022-11-28	SIP-AC1
Horn Antenna	Schwarzbeck	BBHA 9170	MRTSUE06598	1 year	2023-11-05	SIP-AC2
Preamplifier	EMCI	EMC051845SE	MRTSUE06601	1 year	2022-11-23	SIP-AC2
Thermohygrometer	testo	608-H1	MRTSUE06623	1 year	2022-11-28	SIP-AC2
Thermohygrometer	testo	608-H1	MRTSUE06624	1 year	2022-11-28	SIP-AC2
TRILOG Antenna	Schwarzbeck	VULB 9168	MRTSUE06647	1 year	2023-07-13	SIP-AC2
Anechoic Chamber	RIKEN	SIP-AC2	MRTSUE06781	1 year	2022-12-23	SIP-AC2
Horn Antenna	Schwarzbeck	BBHA 9120D	MRTSUE06648	1 year	2023-10-22	SIP-AC2
EMI Test Receiver	R&S	ESR3	MRTSUE06185	1 year	2022-12-29	SIP-AC2
Preamplifier	EMCI	EMC184045SE	MRTSUE06602	1 year	2023-10-10	SIP-AC2
Loop Antenna	Schwarzbeck	FMZB 1519 B	MRTSUE06937	1 year	2023-03-14	SIP-AC2
Signal Analyzer	Keysight	N9010B	MRTSUE06559	1 year	2023-06-01	SIP-AC2
Signal Analyzer	Keysight	N9020B	MRTSUE06604	1 year	2023-09-06	SIP-AC3
Horn Antenna	R&S	HF907	MRTSUE06611	1 year	2023-07-30	SIP-AC3
Thermohygrometer	testo	608-H1	MRTSUE06619	1 year	2023-11-01	SIP-AC3
Thermohygrometer	testo	608-H1	MRTSUE06622	1 year	2022-11-28	SIP-AC3
Preamplifier	EMCI	EMC012645SE	MRTSUE06642	1 year	2023-01-13	SIP-AC3
Anechoic Chamber	RIKEN	SIP-AC3	MRTSUE06782	1 year	2022-12-23	SIP-AC3
Two-Line V-Network	R&S	ENV216	MRTSUE06003	1 year	2023-06-01	SIP-SR2
EMI Test Receiver	R&S	ESR3	MRTSUE06612	1 year	2023-06-01	SIP-SR2
Thermohygrometer	testo	608-H1	MRTSUE06621	1 year	2022-11-28	SIP-SR2
Shielding Room	MIX-BEP	SIP-SR2	MRTSUE06949	5 years	2024-10-23	SIP-SR2
Signal Analyzer	Keysight	N9010B	MRTSUE06558	1 year	2023-06-01	SIP-TR1
Thermohygrometer	testo	608-H1	MRTSUE11022	1 year	2023-11-01	SIP-TR1
USB Power Sensor	Keysight	U2021XA	MRTSUE06596	1 year	2023-08-23	SIP-TR1

Software	Version	Function
EMI V3	V3.0.0	EMI Test Software
Controller_MF 7802BS	1.02	RE Antenna & Turntable
Agilent Power Panel	V R03.09.00	Power

5. Decision Rules and Measurement Uncertainty

5.1. Decision Rules

The Decision Rule is based on Simple Acceptance in accordance with ISO Guide 98-4: 2012 Clause 8.2. (Measurement uncertainty is not taken into account when stating conformity with a specified requirement.)

5.2. Measurement Uncertainty

Where relevant, the following test uncertainty levels have been estimated for tests performed on the EUT as specified in CISPR 16-4-2. This uncertainty represents an expanded uncertainty expressed at approximately the 95% confidence level using a coverage factor of $k = 2$.

AC Conducted Emission Measurement
Measurement Uncertainty for a Level of Confidence of 95% ($U=2Uc(y)$): 9kHz~150kHz: 3.74dB 150kHz~30MHz: 3.44dB
Radiated Disturbance
Measurement Uncertainty for a Level of Confidence of 95% ($U=2Uc(y)$): Horizontal: 30MHz~300MHz: 5.04dB 300MHz~1GHz: 4.95dB 1GHz~40GHz: 6.40dB Vertical: 30MHz~300MHz: 5.24dB 300MHz~1GHz: 6.03dB 1GHz~40GHz: 6.40dB
Spurious Emissions, Conducted
Measuring Uncertainty for a Level of Confidence of 95% ($U=2Uc(y)$): 0.78dB
Output Power
Measuring Uncertainty for a Level of Confidence of 95% ($U=2Uc(y)$): 1.13dB
Power Spectrum Density
Measuring Uncertainty for a Level of Confidence of 95% ($U=2Uc(y)$): 1.15dB
Occupied Bandwidth
Measuring Uncertainty for a Level of Confidence of 95% ($U=2Uc(y)$): 0.28%

6. Test Result

6.1. Summary

FCC Section(s)	Test Description	Test Condition	Verdict
15.247(a)(2)	6dB Bandwidth	Conducted	Pass
15.247(b)(3)	Output Power		Pass
15.247(e)	Power Spectral Density		Pass
15.247(d)	Band Edge / Out-of-Band Emissions		Pass
15.205 15.209	General Field Strength (Restricted Bands and Radiated Emission)	Radiated	Pass
15.207	AC Conducted Emissions 150kHz - 30MHz	Line Conducted	Pass

Remark:

The analyzer plots shown in this section were all taken with a correction table loaded into the analyzer. The correction table was used to account for the losses of the cables and attenuators used as part of the system to connect the EUT to the analyzer at all frequencies of interest.

6.2. 6dB Bandwidth Measurement

6.2.1. Test Limit

The minimum 6dB bandwidth shall be at least 500 kHz.

6.2.2. Test Procedure

ANSI C63.10 - 2013 - Section 11.8

6.2.3. Test Setting

1. The Spectrum's automatic bandwidth measurement capability was used to perform the 6dB bandwidth measurement. The "X" dB bandwidth parameter was set to $X = 6$. The bandwidth measurement was not influenced by any intermediate power nulls in the fundamental emission.
2. Set RBW = 100 kHz
3. $VBW \geq 3 \times RBW$
4. Detector = Peak
5. Trace mode = Max hold
6. Sweep = Auto couple
7. Allow the trace to stabilize

6.2.4. Test Setup

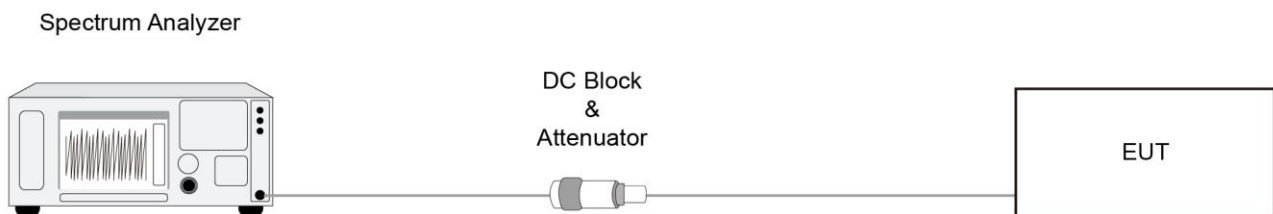

6.2.5. Test Result

Refer to Appendix A.2.

6.3. Output Power Measurement

6.3.1. Test Limit

The maximum output power shall be less 1 Watt (30dBm).

The conducted output power limit specified in paragraph FCC Part 15.247(b) of this section is based on the use of antennas with directional gains that do not exceed 6 dBi. If transmitting antennas of directional gain greater than 6 dBi are used, the conducted output power from the intentional radiator shall be reduced below the stated values in paragraphs FCC Part 15.247(b)(3) of this section, as appropriate, by the amount in dB that the directional gain of the antenna exceeds 6 dBi.

6.3.2. Test Procedure

ANSI C63.10 - 2013 - Section 11.9.2.3.2

6.3.3. Test Setting

Average Power Measurement

Average power measurements were performed only when the EUT was transmitting at its maximum power control level using a broadband power meter with a pulse sensor. The power meter implemented triggering and gating capabilities which were set up such that power measurements were recorded only during the ON time of the transmitter.

6.3.4. Test Setup



6.3.5. Test Result

Refer to Appendix A.3.

6.4. Power Spectral Density Measurement

6.4.1. Test Limit

The maximum permissible power spectral density is 8dBm in any 3 kHz band.

The same method of determining the conducted output power shall be used to determine the power spectral density.

6.4.2. Test Procedure

ANSI C63.10 - 2013 - Section 11.10.5

6.4.3. Test Setting

1. Measure the duty cycle (x) of the transmitter output signal.
2. Set instrument center frequency to DTS channel center frequency.
3. Set span to at least 1.5 times the OBW.
4. RBW = 10 kHz.
5. VBW = 30 kHz.
6. Detector = RMS.
7. Ensure that the number of measurement points in the sweep $\geq 2 \times \text{span}/\text{RBW}$.
8. Sweep time = auto couple.
9. Don't use sweep triggering. Allow sweep to "free run".
10. Employ trace averaging (RMS) mode over a minimum of 100 traces.
11. Use the peak marker function to determine the maximum amplitude level.
12. Add $10 \log (1/x)$, where x is the duty cycle measured in step (a), to the measured PSD to compute the average PSD during the actual transmission time. If measured value exceeds requirement specified by regulatory agency, then reduce RBW (but no less than 3 kHz) and repeat (note that this may require zooming in on the emission of interest and reducing the span to meet the minimum measurement point requirement as the RBW is reduced).

6.4.4. Test Setup

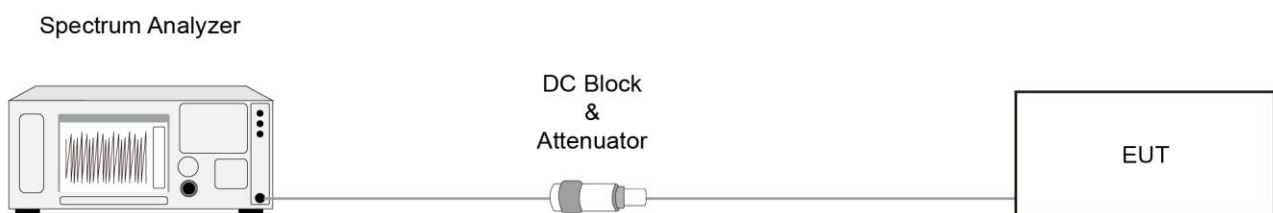

6.4.5. Test Result

Refer to Appendix A.4.

6.5. Conducted Band Edge and Out-of-Band Emissions Measurement

6.5.1. Test Limit

The limit for out-of-band spurious emissions at the band edge is 30dB below the fundamental emission level, as determined from the in-band power measurement of the DTS channel performed in a 100 kHz bandwidth per the PSD procedure.

6.5.2. Test Procedure

ANSI C63.10-2013 - Section 11.11

6.5.3. Test Setting

Reference level measurement

1. Set instrument center frequency to DTS channel center frequency
2. Set the span to ≥ 1.5 times the DTS bandwidth
3. Set the RBW = 100 kHz
4. Set the VBW $\geq 3 \times$ RBW
5. Detector = peak
6. Sweep time = auto couple
7. Trace mode = max hold
8. Allow trace to fully stabilize

Emission level measurement

1. Set the center frequency and span to encompass frequency range to be measured
2. RBW = 100kHz
3. VBW = 300kHz
4. Detector = Peak
5. Trace mode = max hold
6. Sweep time = auto couple
7. The trace was allowed to stabilize

6.5.4. Test Setup

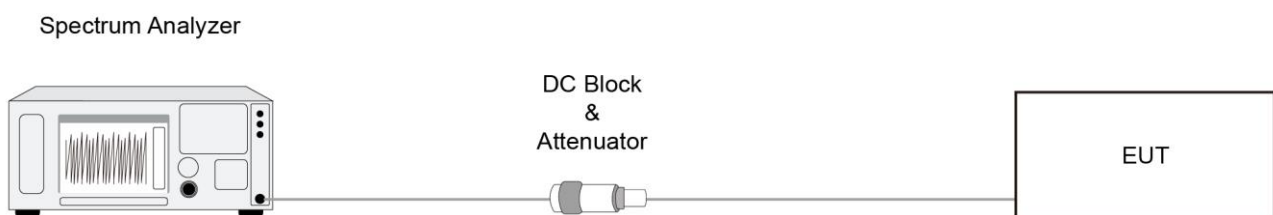

6.5.5. Test Result

Refer to Appendix A.5.

6.6. Radiated Spurious Emission Measurement

6.6.1. Test Limit

All out of band emissions appearing in a restricted band as specified in Section 15.205 of the Title 47 CFR must not exceed the limits shown in Table per Section 15.209.

FCC Part 15 Subpart C Paragraph 15.209		
Frequency [MHz]	Field Strength [uV/m]	Measured Distance [Meters]
0.009 - 0.490	2400/F (kHz)	300
0.490 - 1.705	24000/F (kHz)	30
1.705 - 30	30	30
30 - 88	100	3
88 - 216	150	3
216 - 960	200	3
Above 960	500	3

6.6.2. Test Procedure

ANSI C63.10 - 2013 - Section 11.11 & 11.12

ANSI C63.10 - 2013 - Section 6.3 (General Requirements)

ANSI C63.10 - 2013 - Section 6.4 (Standard test method below 30MHz)

ANSI C63.10 - 2013 - Section 6.5 (Standard test method above 30MHz to 1GHz)

ANSI C63.10 - 2013 - Section 6.6 (Standard test method above 1GHz)

6.6.3. Test Setting

Table 1 - RBW as a function of frequency

Frequency	RBW
9 ~ 150 kHz	200 ~ 300 Hz
0.15 ~ 30 MHz	9 ~ 10 kHz
30 ~ 1000 MHz	100 ~ 120 kHz
> 1000MHz	1MHz

Quasi-Peak Measurements below 1GHz

1. Analyzer center frequency was set to the frequency of the radiated spurious emission of interest
2. Span was set greater than 1MHz
3. RBW = as specified in Table 1
4. Detector = CISPR quasi-peak
5. Sweep time = auto couple
6. Trace was allowed to stabilize

Peak Measurements above 1GHz

1. Analyzer center frequency was set to the frequency of the radiated spurious emission of interest
2. RBW = 1MHz
3. VBW = 3MHz
4. Detector = peak
5. Sweep time = auto couple
6. Trace mode = max hold
7. Trace was allowed to stabilize

Average Measurements above 1GHz (Method VB)

1. Analyzer center frequency was set to the frequency of the radiated spurious emission of interest
2. RBW = 1MHz
3. VBW; If the EUT is configured to transmit with duty cycle $\geq 98\%$, set VBW = 10 Hz.
If the EUT duty cycle is $< 98\%$, set VBW $\geq 1/T$. T is the minimum transmission duration.
4. Detector = Peak
5. Sweep time = auto
6. Trace mode = max hold
7. Trace was allowed to stabilize

6.6.4. Test Setup

Below 1GHz Test Setup:

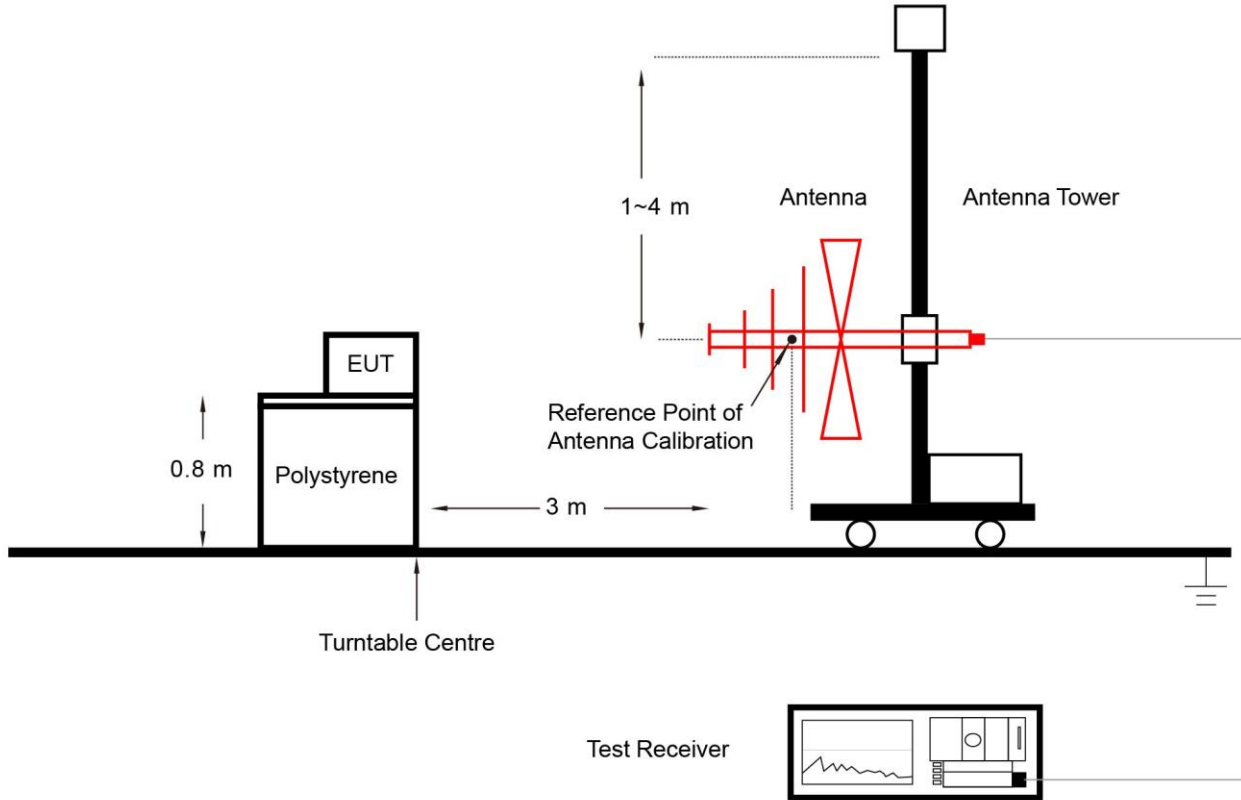

Above 1GHz Test Setup:

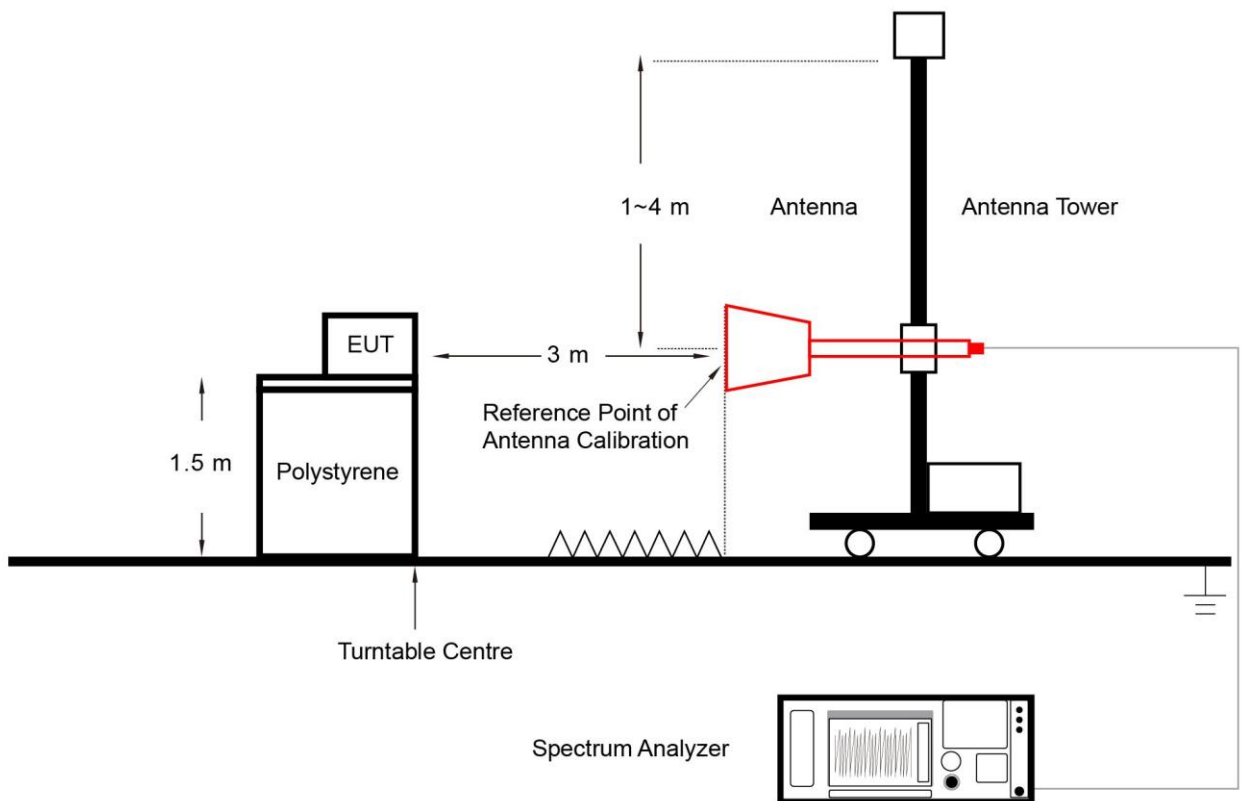

6.6.5. Test Result

Refer to Appendix A.6.

6.7. Radiated Restricted Band Edge Measurement

6.7.1. Test Limit

For 15.205 requirement:

Radiated emissions which fall in the restricted bands, as defined in Section 15.205(a) of FCC part 15, must also comply with the radiated emission limits specified in Section 15.209(a).

Frequency (MHz)	Frequency (MHz)	Frequency (MHz)	Frequency (GHz)
0.090 - 0.110	16.42 - 16.423	399.9 - 410	4.5 - 5.15
¹ 0.495 - 0.505	16.69475 - 16.69525	608 - 614	5.35 - 5.46
2.1735 - 2.1905	16.80425 - 16.80475	960 - 1240	7.25 - 7.75
4.125 - 4.128	25.5 - 25.67	1300 - 1427	8.025 - 8.5
4.17725 - 4.17775	37.5 - 38.25	1435 - 1626.5	9.0 - 9.2
4.20725 - 4.20775	73 - 74.6	1645.5 - 1646.5	9.3 - 9.5
6.215 - 6.218	74.8 - 75.2	1660 - 1710	10.6 - 12.7
6.26775 - 6.26825	108 - 121.94	1718.8 - 1722.2	13.25 - 13.4
6.31175 - 6.31225	123 - 138	2200 - 2300	14.47 - 14.5
8.291 - 8.294	149.9 - 150.05	2310 - 2390	15.35 - 16.2
8.362 - 8.366	156.52475 - 156.52525	2483.5 - 2500	17.7 - 21.4
8.37625 - 8.38675	156.7 - 156.9	2690 - 2900	22.01 - 23.12
8.41425 - 8.41475	162.0125 - 167.17	3260 - 3267	23.6 - 24.0
12.29 - 12.293	167.72 - 173.2	3332 - 3339	31.2 - 31.8
12.51975 - 12.52025	240 - 285	3345.8 - 3358	36.43 - 36.5
12.57675 - 12.57725	322 - 335.4	3600 - 4400	(²)
13.36 - 13.41	--	--	--

All out of band emissions appearing in a restricted band as specified in Section 15.205 of the Title 47CFR must not exceed the limits shown in Table per Section 15.209.

FCC Part 15 Subpart C Paragraph 15.209		
Frequency [MHz]	Field Strength [uV/m]	Measured Distance [Meters]
0.009 - 0.490	2400/F (kHz)	300
0.490 - 1.705	24000/F (kHz)	30
1.705 - 30	30	30
30 - 88	100	3
88 - 216	150	3
216 - 960	200	3
Above 960	500	3

6.7.2. Test Procedure

ANSI C63.10-2013 Section 6.3 & 6.6 & 11.13

6.7.3. Test Setting

Peak Field Strength Measurements

1. Analyzer center frequency was set to the frequency of the radiated spurious emission of interest
2. RBW = 1MHz
3. VBW = 3MHz
4. Detector = peak
5. Sweep time = auto couple
6. Trace mode = max hold
7. Trace was allowed to stabilize

Average Field Strength Measurements

1. Analyzer center frequency was set to the frequency of the radiated spurious emission of interest
2. RBW = 1MHz
3. VBW $\geq 1/T$
4. As an alternative, the instrument may be set to linear detector mode. Ensure that video filtering is applied in linear voltage domain (rather than in a log or dB domain). Some instruments require linear display mode in order to accomplish this. Others have a setting for Average-VBW Type, which can be set to "Voltage" regardless of the display mode
5. Detector = Peak
6. Sweep time = auto
7. Trace mode = max hold
8. Allow max hold to run for at least 50 times (1/duty cycle) traces

6.7.4. Test Setup

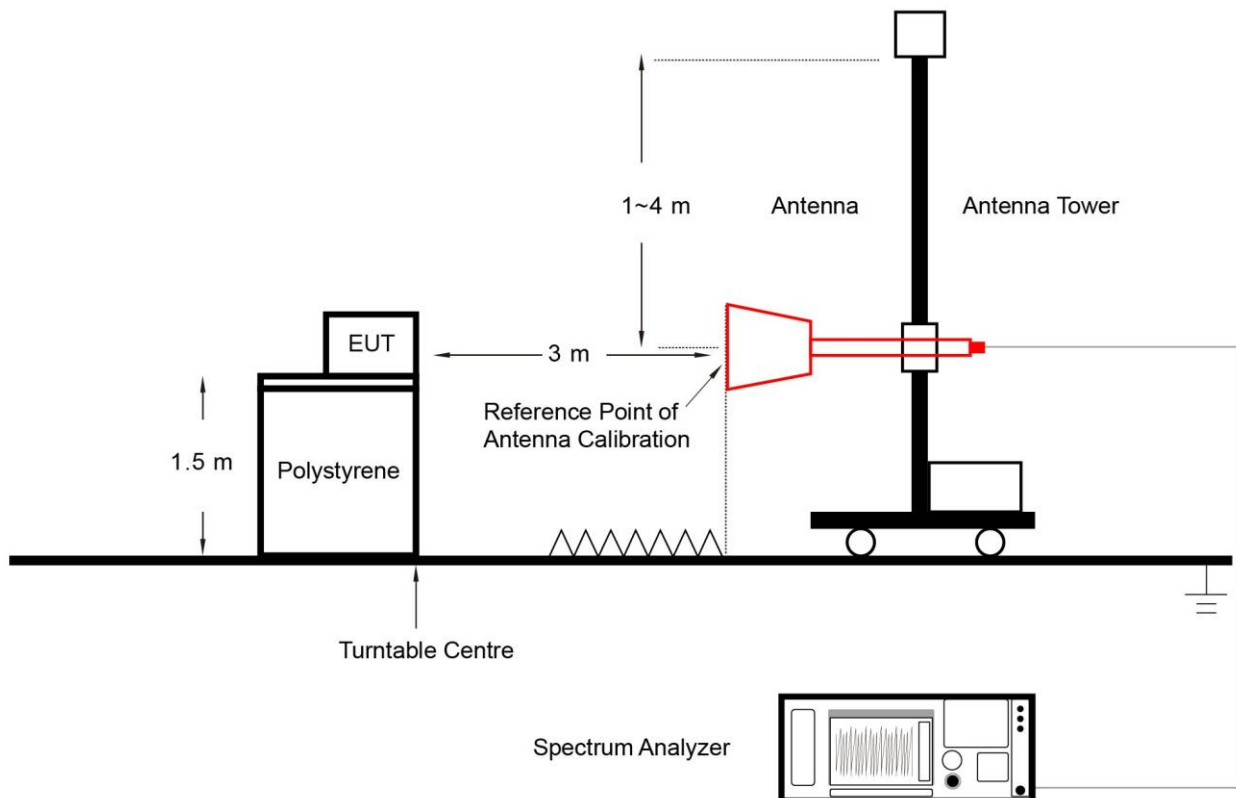

6.7.5. Test Result

Refer to Appendix A.7.

6.8. AC Conducted Emissions Measurement

6.8.1. Test Limit

FCC Part 15 Subpart C Paragraph 15.207 Limits		
Frequency (MHz)	QP (dBuV)	AV (dBuV)
0.15 - 0.50	66 - 56	56 - 46
0.50 - 5.0	56	46
5.0 - 30	60	50

Note 1: The lower limit shall apply at the transition frequencies.

Note 2: The limit decreases linearly with the logarithm of the frequency in the range 0.15MHz to 0.5MHz.

6.8.2. Test Setup

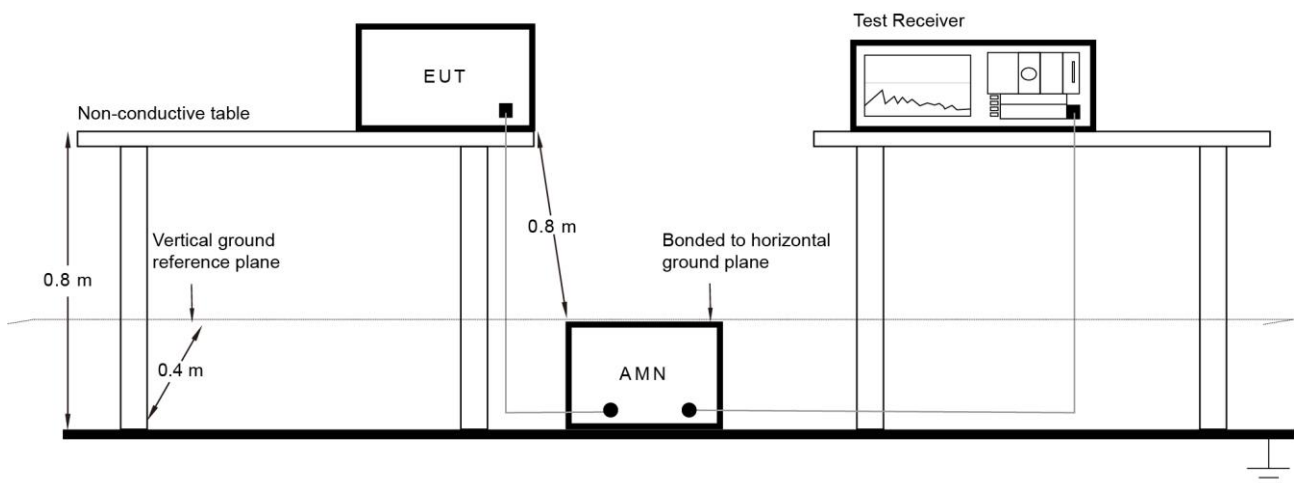

6.8.3. Test Result

Refer to Appendix A.8.

Appendix A – Test Result

A.1 Duty Cycle Test Result

Test Site	SIP-TR1	Test Engineer	Nandy Zhang
Test Date	2022-09-15		

Test Mode	Duty Cycle
802.11b	94.65%
802.11g	94.70%
802.11n-HT20	94.80%
802.11n-HT40	90.21%
802.11ax-HE20	97.69%
802.11ax-HE40	95.85%

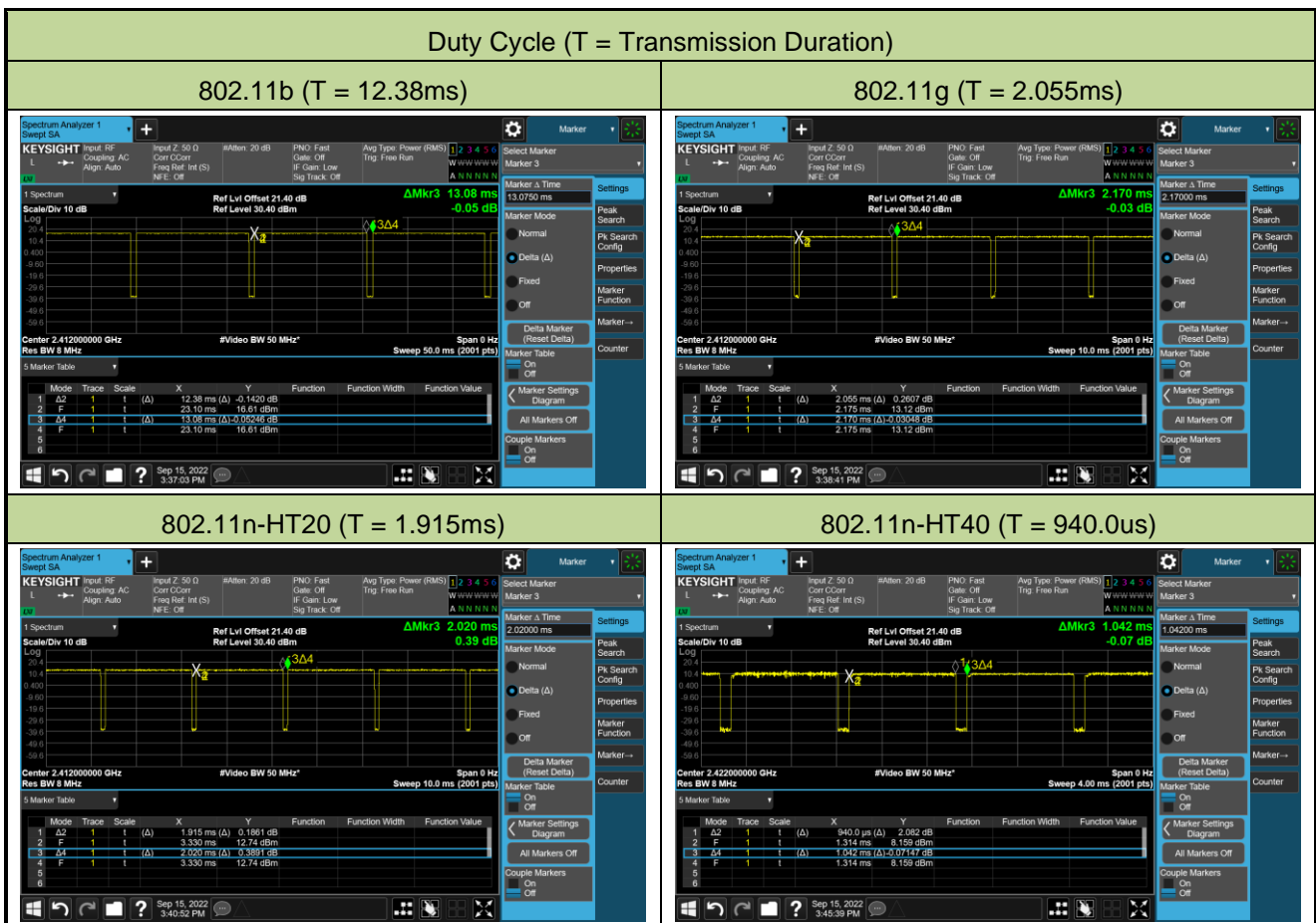

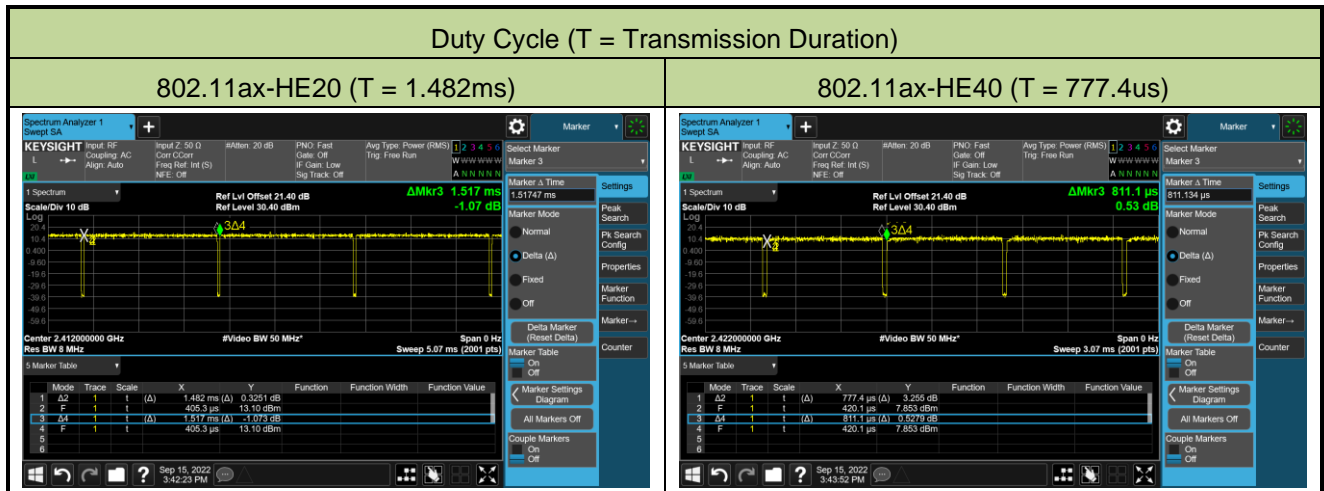

A.2 6dB Bandwidth Test Result

Test Site	SIP-TR1	Test Engineer	Nandy Zhang
Test Date	2022-11-10		

Test Mode	Data Rate / MCS	Channel No.	Frequency (MHz)	6dB Bandwidth (MHz)	Limit (MHz)
11b	1Mbps	01	2412	7.087	≥ 0.5
11b	1Mbps	06	2437	7.088	≥ 0.5
11b	1Mbps	11	2462	7.079	≥ 0.5
11g	6Mbps	01	2412	16.41	≥ 0.5
11g	6Mbps	06	2437	16.42	≥ 0.5
11g	6Mbps	11	2462	16.42	≥ 0.5
11n-HT20	MCS0	01	2412	17.63	≥ 0.5
11n-HT20	MCS0	06	2437	17.62	≥ 0.5
11n-HT20	MCS0	11	2462	17.62	≥ 0.5
11n-HT40	MCS0	03	2422	36.34	≥ 0.5
11n-HT40	MCS0	06	2437	36.38	≥ 0.5
11n-HT40	MCS0	09	2452	36.37	*≥ 0.5
11ax-HE20	MCS0	01	2412	18.98	≥ 0.5
11ax-HE20	MCS0	06	2437	18.99	≥ 0.5
11ax-HE20	MCS0	11	2462	18.99	≥ 0.5
11ax-HE40	MCS0	03	2422	37.42	≥ 0.5
11ax-HE40	MCS0	06	2437	37.43	≥ 0.5
11ax-HE40	MCS0	09	2452	37.42	≥ 0.5

802.11b 6dB Bandwidth

Channel 01 (2412MHz)

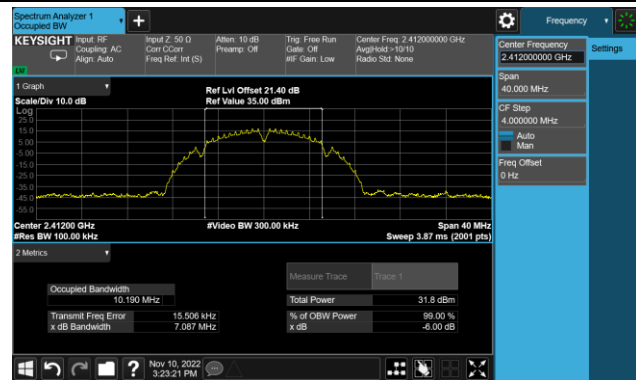

Channel 06 (2437MHz)

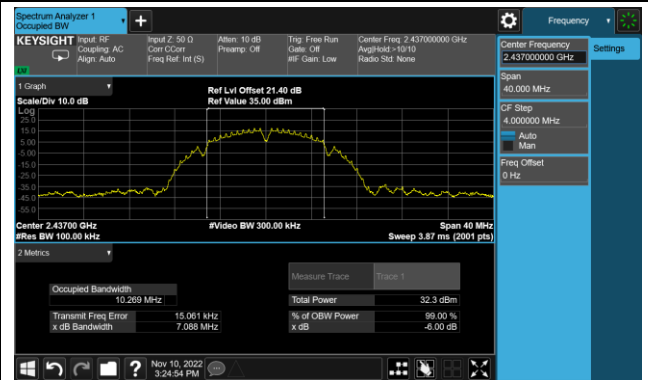

Channel 11 (2462MHz)

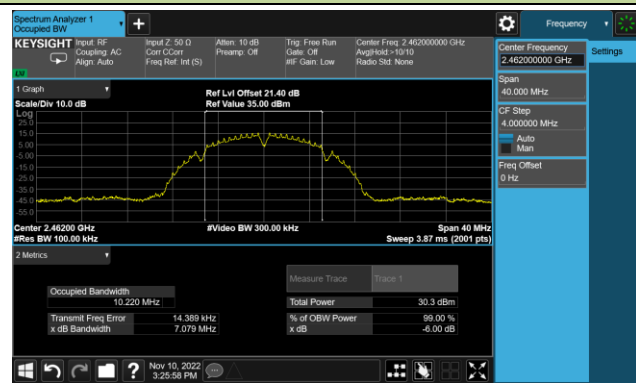

802.11g 6dB Bandwidth

Channel 01 (2412MHz)

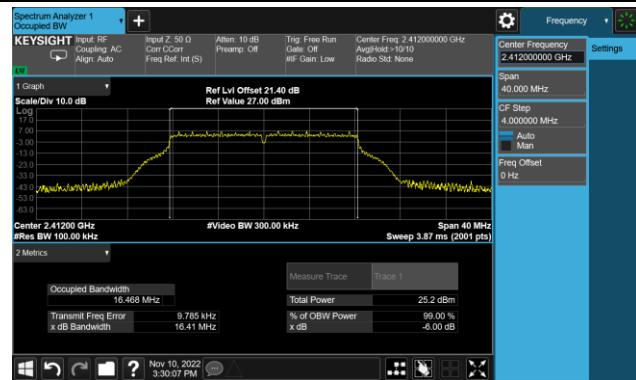

Channel 06 (2437MHz)

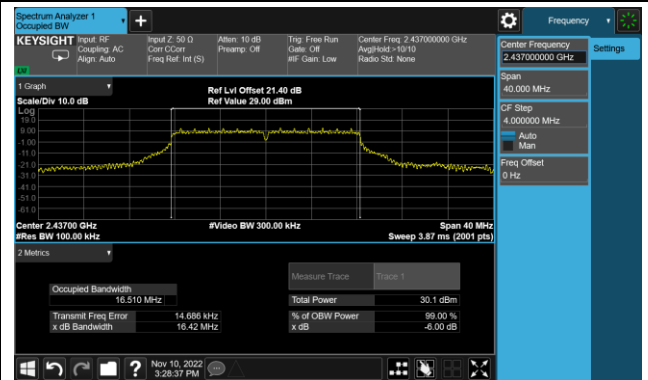

Channel 11 (2462MHz)

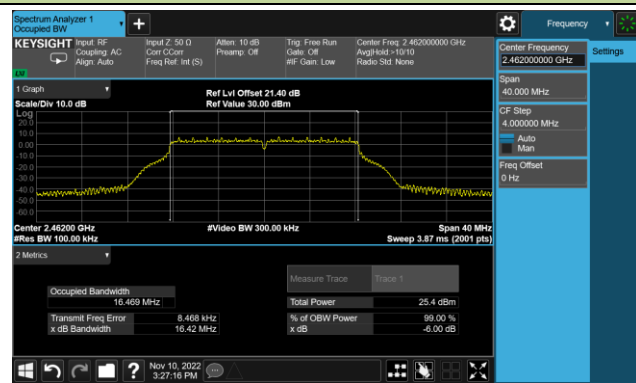

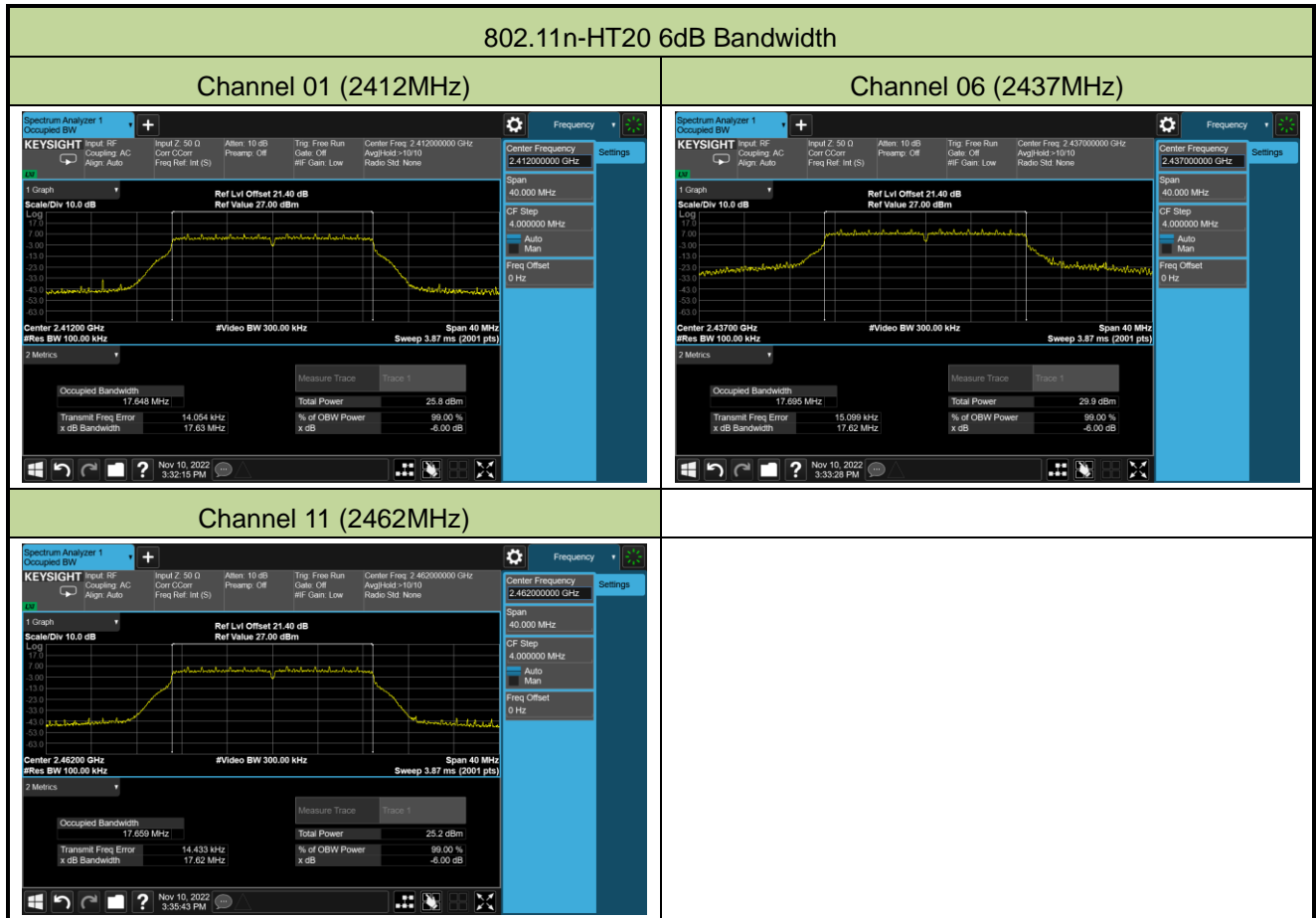

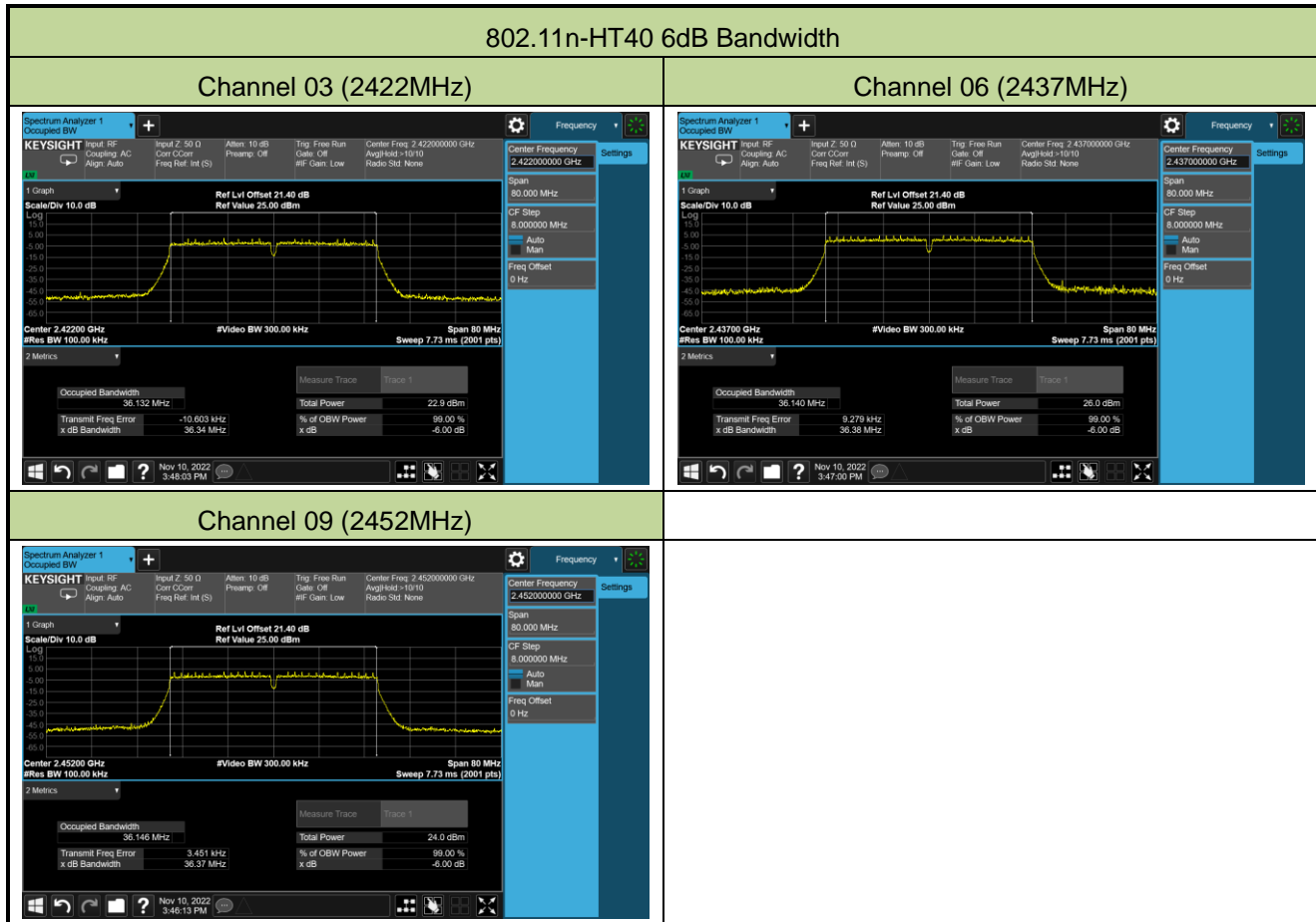

802.11ax-HE20 6dB Bandwidth

Channel 01 (2412MHz)

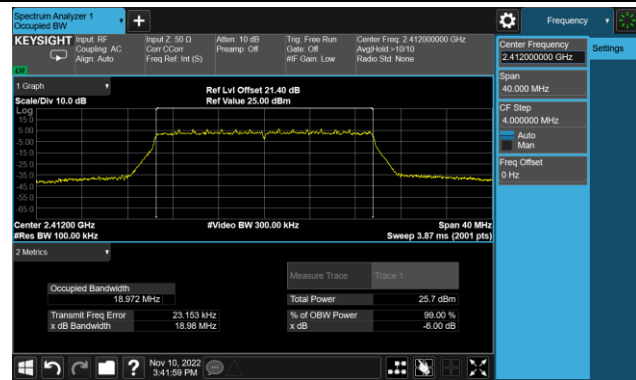

Channel 06 (2437MHz)

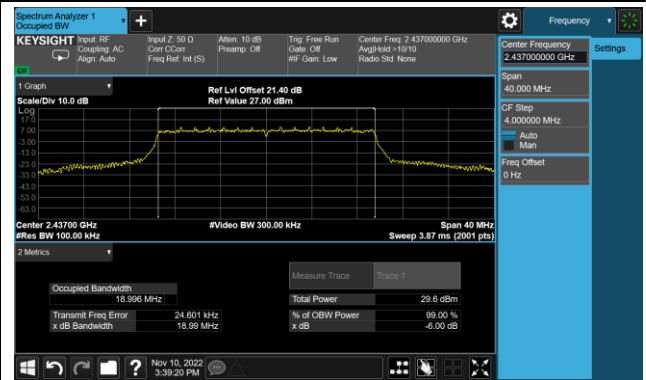

Channel 11 (2462MHz)

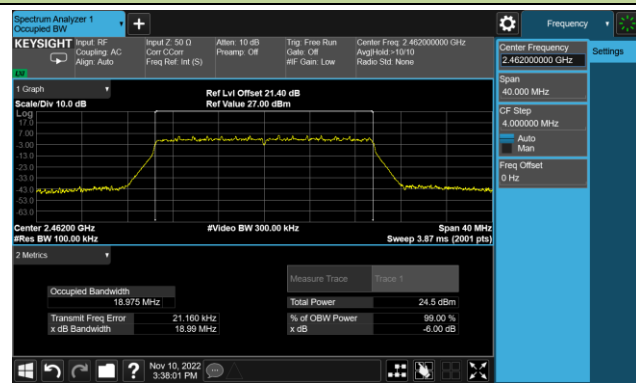

802.11ax-HE40 6dB Bandwidth

Channel 03 (2422MHz)

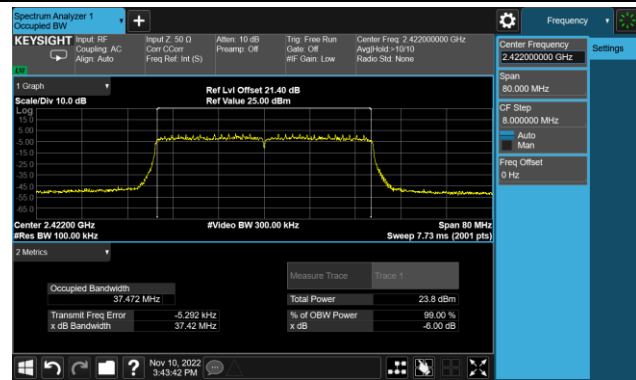

Channel 06 (2437MHz)

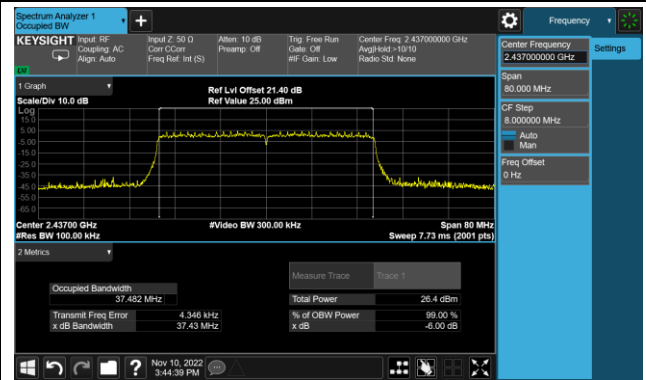

Channel 09 (2452MHz)

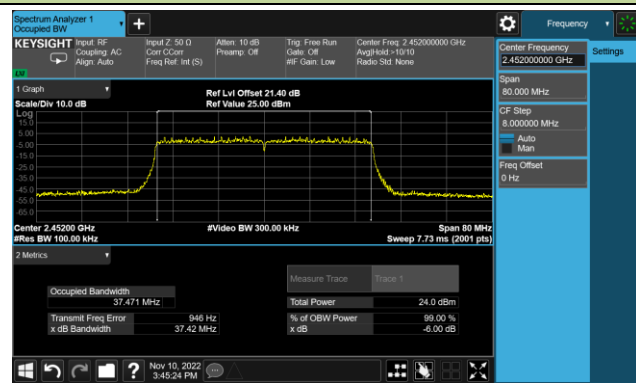

A.3 Output Power Test Result

Power output test was verified over all data rates of each mode shown as below, and then choose the maximum power output (gray marker) for final test of each channel.

Test Mode	Bandwidth (MHz)	Channel No.	Frequency (MHz)	Data Rate / MCS	Average Power (dBm)
802.11b	20	1	2412	1Mbps	14.51
				5.5Mbps	14.45
				11Mbps	14.36
802.11g	20	1	2412	6Mbps	14.84
				24Mbps	14.66
				54Mbps	14.51
802.11n	20	1	2412	MCS0	14.74
				MCS3	14.63
				MCS7	14.44
802.11n	40	3	2422	MCS0	15.07
				MCS3	14.77
				MCS7	14.92
802.11ax	20	1	2412	MCS0	14.91
				MCS3	14.77
				MCS7	14.35
802.11ax	40	3	2422	MCS0	15.11
				MCS3	15.02
				MCS7	14.91

Test Site	SIP-TR1	Test Engineer	Nandy Zhang
Test Date	2022-11-11		

Test Mode	Data Rate/ MCS	Channel No.	Freq. (MHz)	Average Power (dBm)			Total AV Power (dBm)	Limit (dBm)
				Ant 1	Ant 2	Ant 3		
11b	1Mbps	01	2412	24.73	24.25	24.21	29.17	≤ 30.00
11b	1Mbps	06	2437	25.17	24.81	24.93	29.74	≤ 30.00
11b	1Mbps	11	2462	22.93	22.68	22.65	27.53	≤ 30.00
11g	6Mbps	01	2412	18.75	18.06	18.51	23.22	≤ 30.00
11g	6Mbps	06	2437	23.58	22.80	22.93	27.89	≤ 30.00
11g	6Mbps	11	2462	18.43	18.16	18.34	23.08	≤ 30.00
11n-HT20	MCS0	01	2412	18.80	18.24	18.56	23.31	≤ 30.00
11n-HT20	MCS0	06	2437	23.13	22.48	22.64	27.53	≤ 30.00
11n-HT20	MCS0	11	2462	18.04	17.63	17.65	22.55	≤ 30.00
11n-HT40	MCS0	03	2422	16.83	16.45	16.52	21.37	≤ 30.00
11n-HT40	MCS0	06	2437	19.32	19.28	18.99	23.97	≤ 30.00
11n-HT40	MCS0	09	2452	17.38	17.11	16.95	21.92	≤ 30.00
11ax-HE20	MCS0	01	2412	18.66	18.02	18.16	23.06	≤ 30.00
11ax-HE20	MCS0	06	2437	22.59	22.01	21.97	26.97	≤ 30.00
11ax-HE20	MCS0	11	2462	17.02	16.77	16.93	21.68	≤ 30.00
11ax-HE40	MCS0	03	2422	16.68	16.13	16.37	21.17	≤ 30.00
11ax-HE40	MCS0	06	2437	19.45	19.37	19.01	24.05	≤ 30.00
11ax-HE40	MCS0	09	2452	17.23	17.01	16.95	21.84	≤ 30.00

Note: Total AV Power (dBm) = $10 \cdot \log \{ 10^{(\text{Ant 1 Average Power} / 10)} + 10^{(\text{Ant 2 Average Power} / 10)} + 10^{(\text{Ant 3 Average Power} / 10)} \}$ (dBm).

A.4 Power Spectral Density Test Result

Test Site	SIP-TR1	Test Engineer	Nandy Zhang
Test Date	2022-11-10		

Test Mode	Data Rate/ MCS	Channel No.	Freq. (MHz)	PSD (dBm/3kHz)			Total PSD (dBm/3kHz)	Limit (dBm/3kHz)	Result
				Ant 1	Ant 2	Ant 3			
11b	1Mbps	01	2412	-1.14	-1.34	-1.44	3.70	≤ 8.00	Pass
11b	1Mbps	06	2437	-0.28	-0.64	-0.74	4.46	≤ 8.00	Pass
11b	1Mbps	11	2462	-2.64	-3.03	-2.56	2.27	≤ 8.00	Pass
11g	6Mbps	01	2412	-9.55	-10.07	-9.81	-4.79	≤ 8.00	Pass
11g	6Mbps	06	2437	-4.80	-5.62	-5.06	-0.14	≤ 8.00	Pass
11g	6Mbps	11	2462	-9.58	-9.55	-10.21	-4.76	≤ 8.00	Pass
11n-HT20	MCS0	01	2412	-9.66	-10.28	-9.95	-4.95	≤ 8.00	Pass
11n-HT20	MCS0	06	2437	-5.18	-5.99	-5.96	-0.69	≤ 8.00	Pass
11n-HT20	MCS0	11	2462	-10.75	-10.74	-10.64	-5.71	≤ 8.00	Pass
11n-HT40	MCS0	03	2422	-13.89	-14.33	-14.08	-8.88	≤ 8.00	Pass
11n-HT40	MCS0	06	2437	-11.68	-11.35	-11.42	-6.26	≤ 8.00	Pass
11n-HT40	MCS0	09	2452	-13.06	-13.55	-13.78	-8.24	≤ 8.00	Pass
11ax-HE20	MCS0	01	2412	-10.65	-11.62	-10.88	-6.16	≤ 8.00	Pass
11ax-HE20	MCS0	06	2437	-6.70	-7.55	-7.41	-2.33	≤ 8.00	Pass
11ax-HE20	MCS0	11	2462	-12.21	-12.23	-11.88	-7.23	≤ 8.00	Pass
11ax-HE40	MCS0	03	2422	-14.75	-15.12	-15.10	-10.03	≤ 8.00	Pass
11ax-HE40	MCS0	06	2437	-12.02	-12.16	-12.67	-7.32	≤ 8.00	Pass
11ax-HE40	MCS0	09	2452	-14.23	-14.47	-14.60	-9.48	≤ 8.00	Pass

Note:

When EUT duty cycle ≤ 98%, Total PSD = $10 \cdot \log(10^{(\text{Ant 1 PSD}/10)} + 10^{(\text{Ant 2 PSD}/10)} + 10^{(\text{Ant 3 PSD}/10)}) + 10 \cdot \log(1/\text{Duty Cycle})$.

802.11b - PSD – Ant 1

Channel 01 (2412MHz)

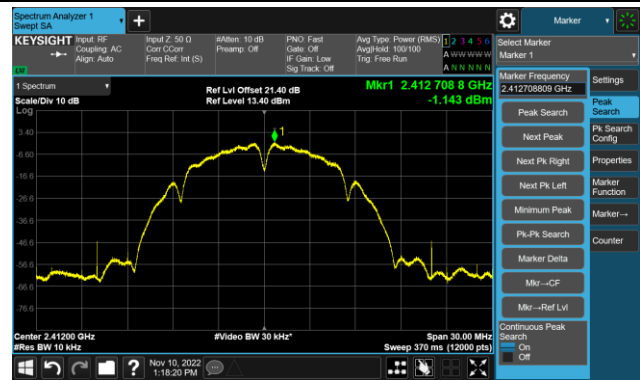

Channel 06 (2437MHz)

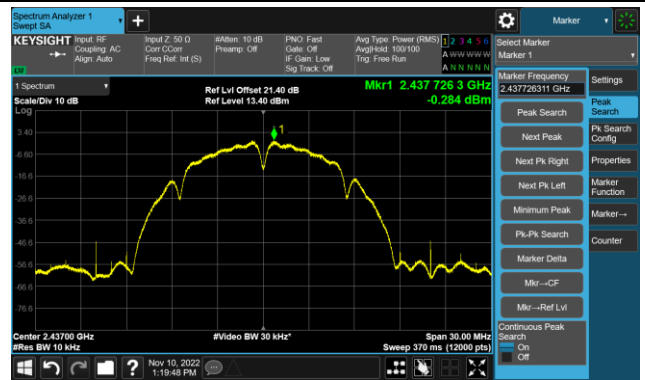

Channel 11 (2462MHz)

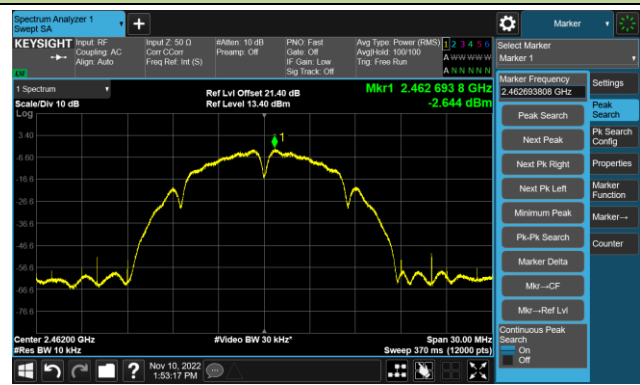

802.11g - PSD – Ant 1

Channel 01 (2412MHz)

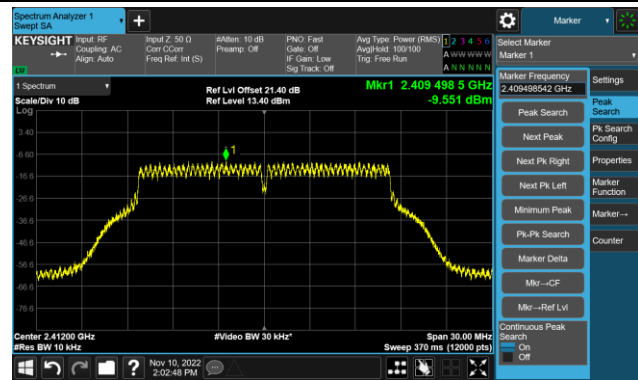

Channel 06 (2437MHz)

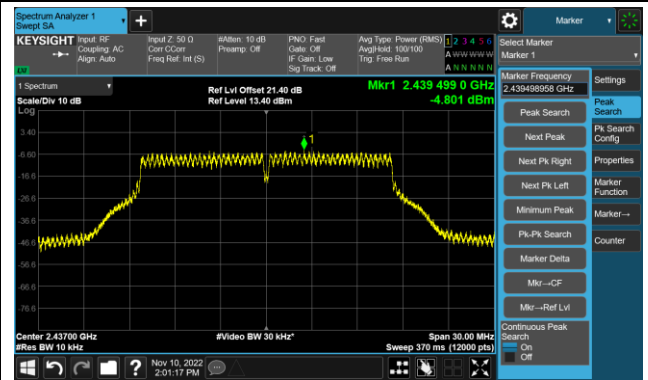

Channel 11 (2462MHz)

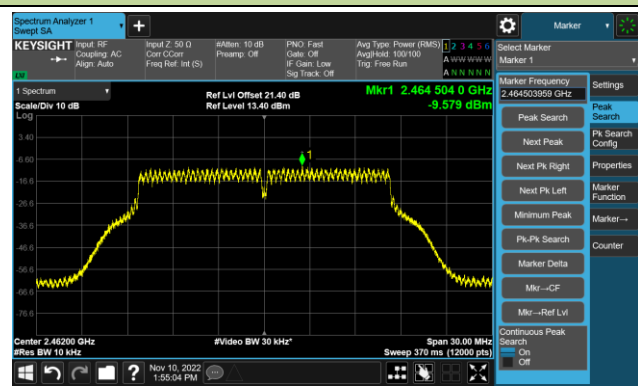

802.11n-HT20 - PSD – Ant 1

Channel 01 (2412MHz)

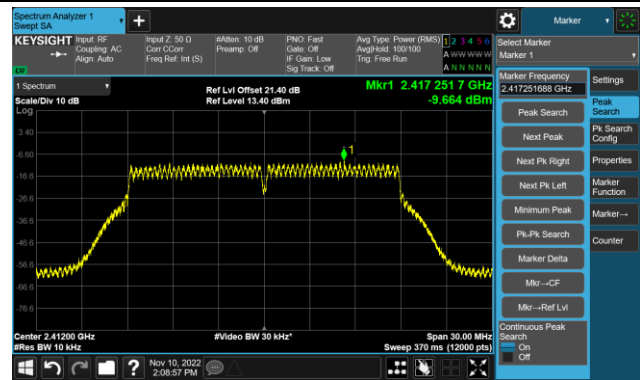

Channel 06 (2437MHz)

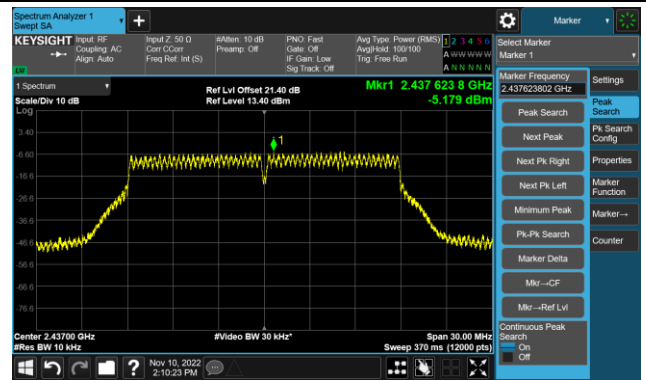

Channel 11 (2462MHz)

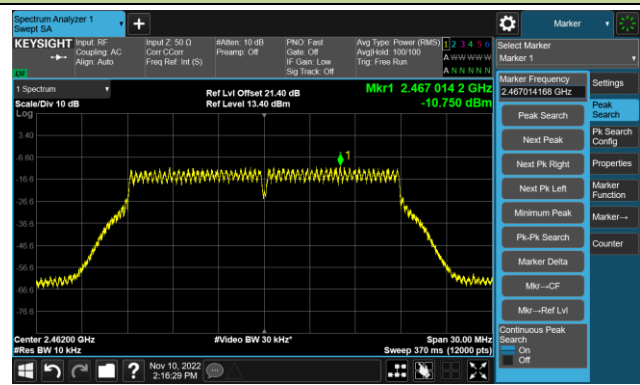

802.11n-HT40 - PSD – Ant 1

Channel 03 (2422MHz)

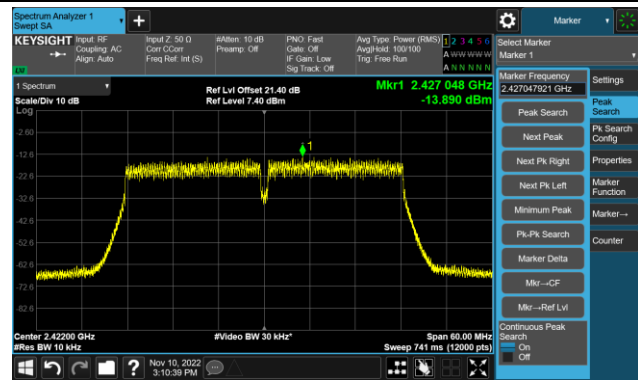

Channel 06 (2437MHz)

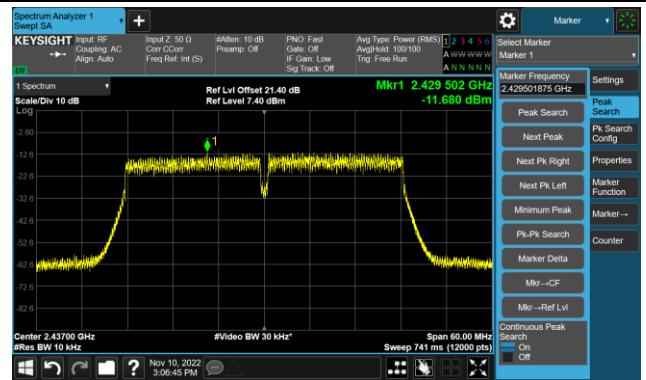

Channel 09 (2452MHz)

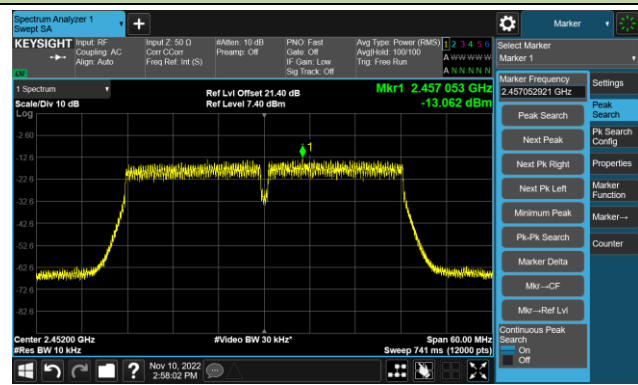

802.11ax-HE20 - PSD – Ant 1

Channel 01 (2412MHz)

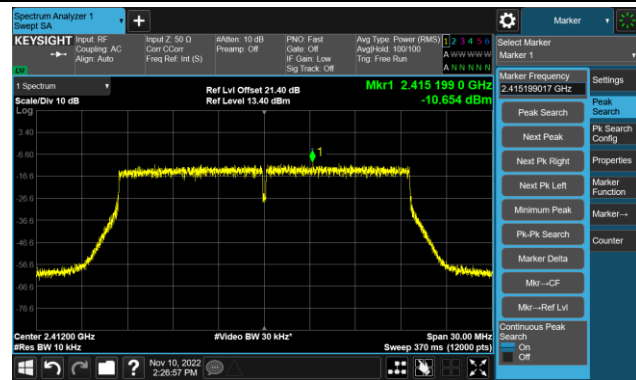

Channel 06 (2437MHz)

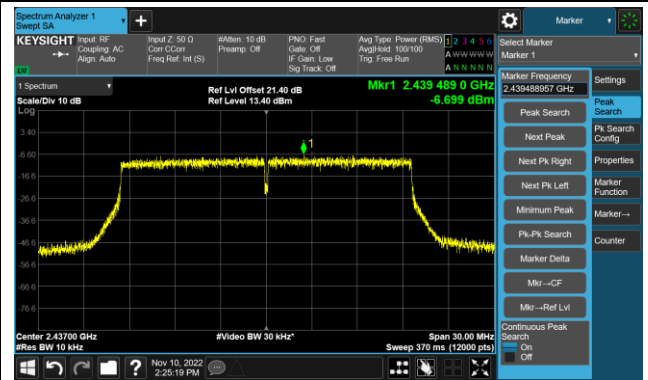

Channel 11 (2462MHz)

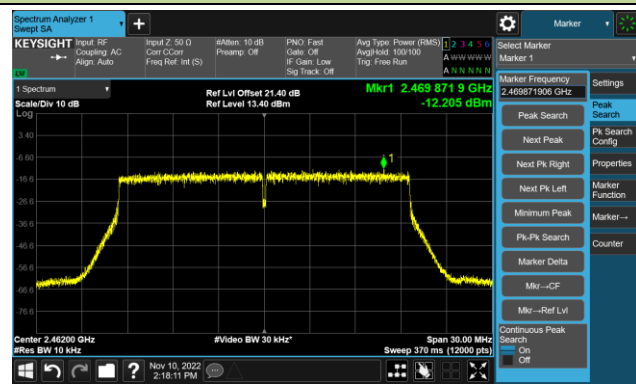

802.11ax-HE40 - PSD – Ant 1

Channel 03 (2422MHz)

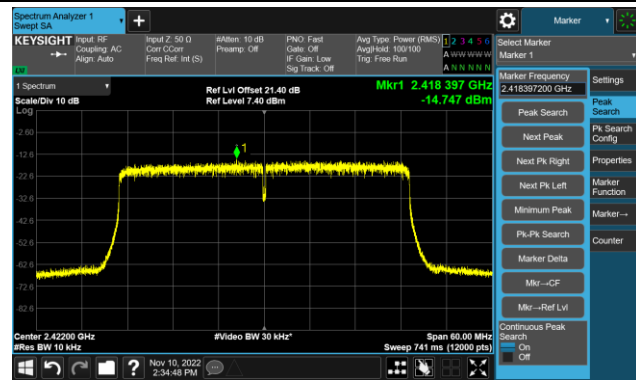

Channel 06 (2437MHz)

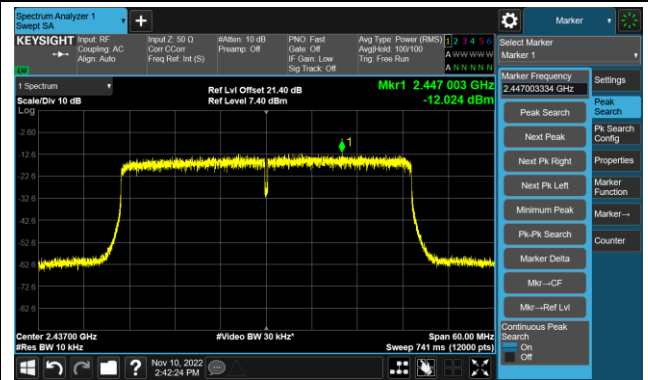

Channel 09 (2452MHz)

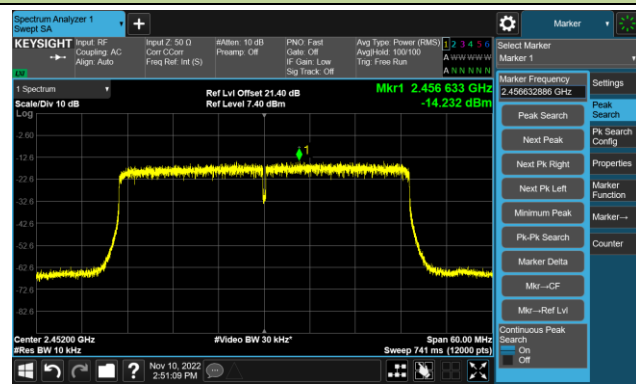

802.11b - PSD – Ant 2

Channel 01 (2412MHz)

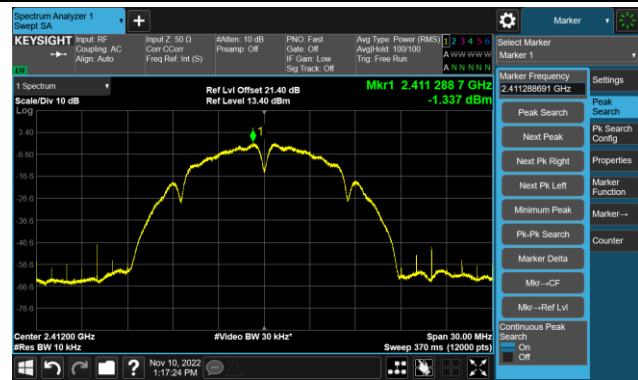

Channel 06 (2437MHz)



Channel 11 (2462MHz)



802.11g - PSD – Ant 2

Channel 01 (2412MHz)

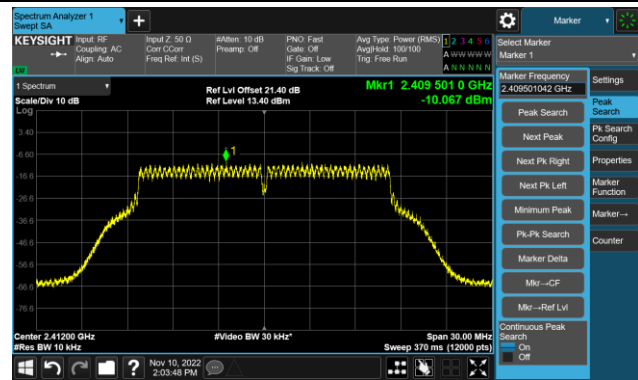

Channel 06 (2437MHz)



Channel 11 (2462MHz)

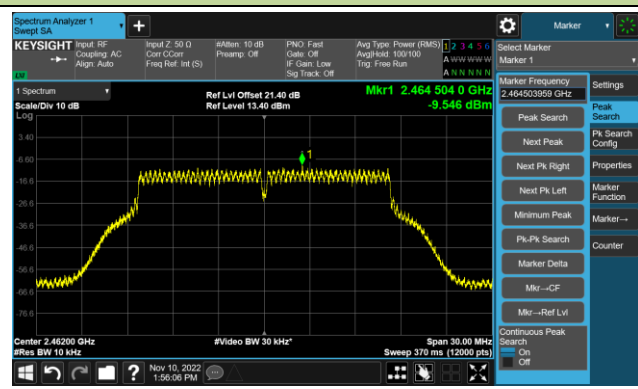

802.11n-HT20 - PSD – Ant 2

Channel 01 (2412MHz)

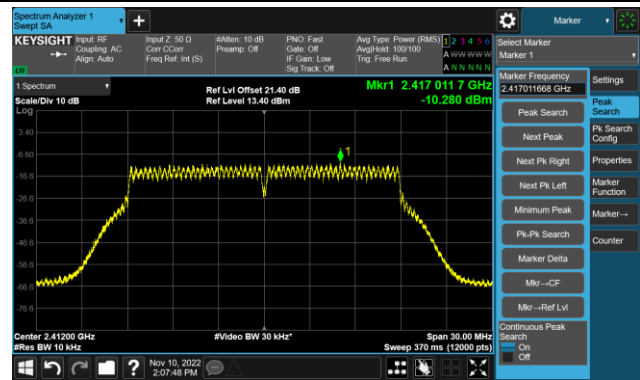

Channel 06 (2437MHz)

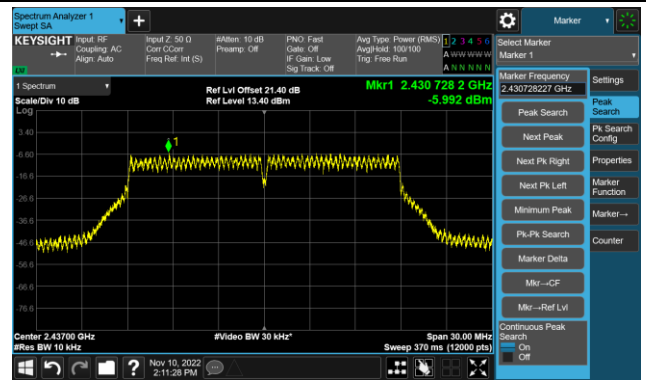

Channel 11 (2462MHz)

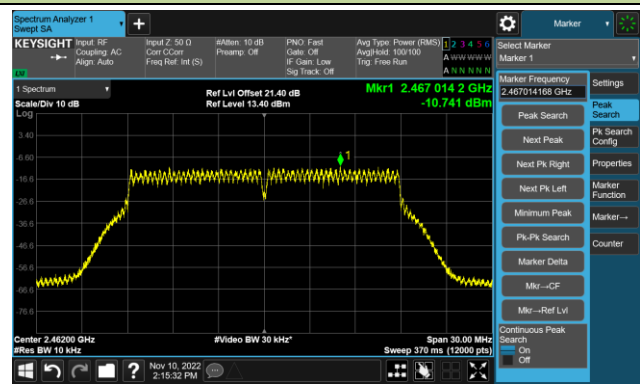

802.11n-HT40 - PSD – Ant 2

Channel 03 (2422MHz)

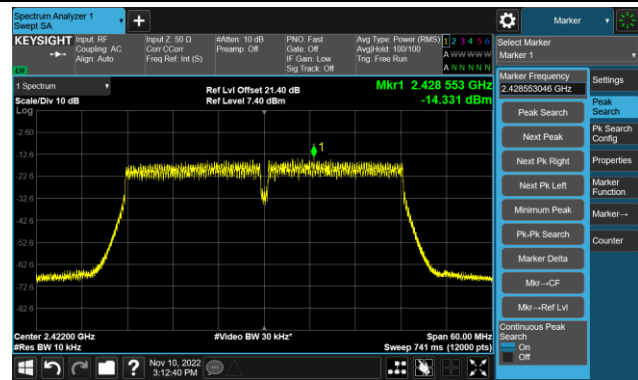

Channel 06 (2437MHz)

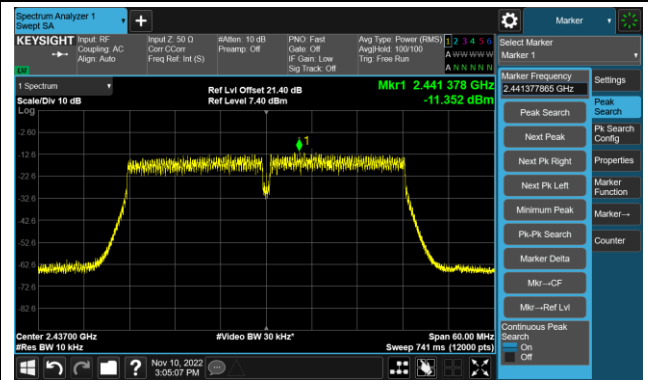

Channel 09 (2452MHz)

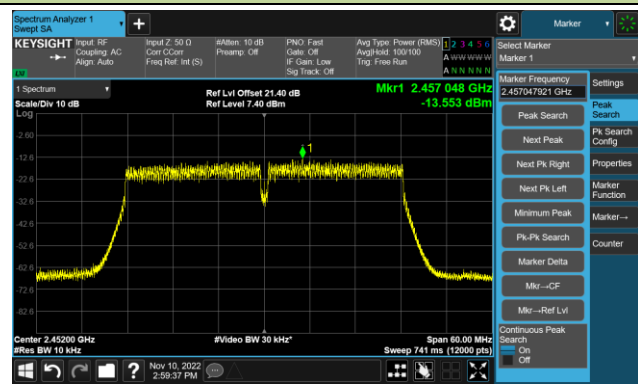

802.11ax-HE20 - PSD – Ant 2

Channel 01 (2412MHz)

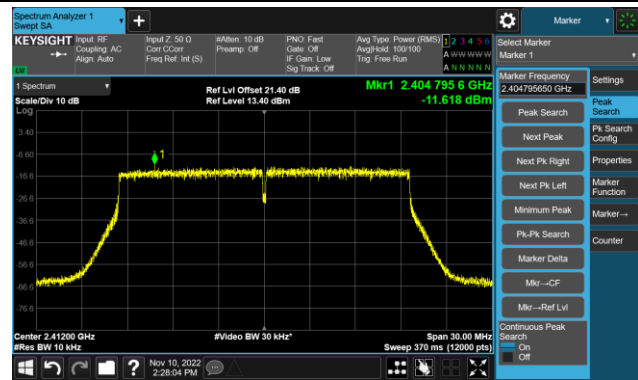

Channel 06 (2437MHz)

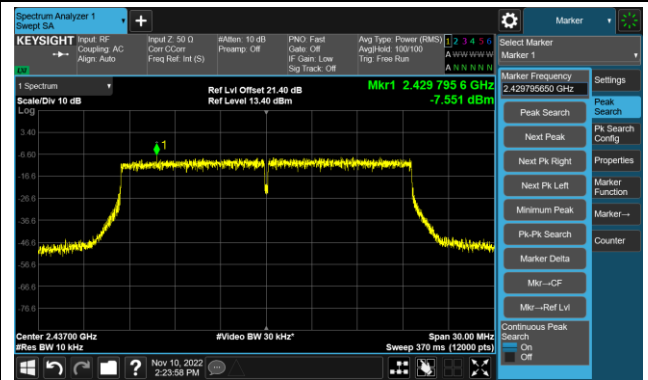

Channel 11 (2462MHz)

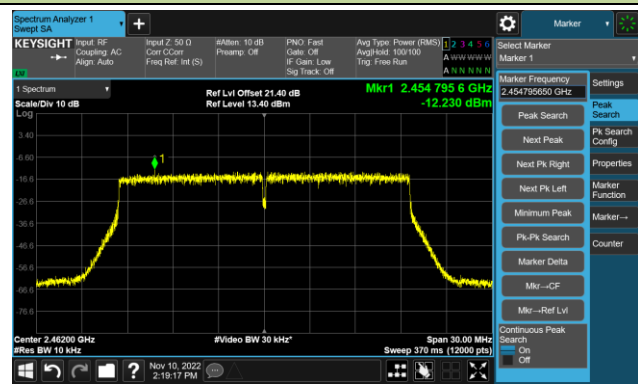

802.11ax-HE40 - PSD – Ant 2

Channel 03 (2422MHz)

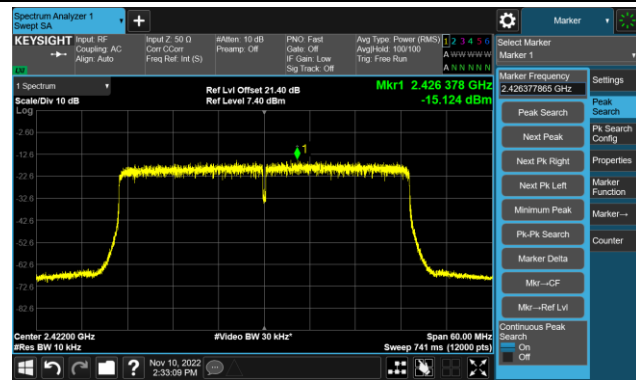

Channel 06 (2437MHz)

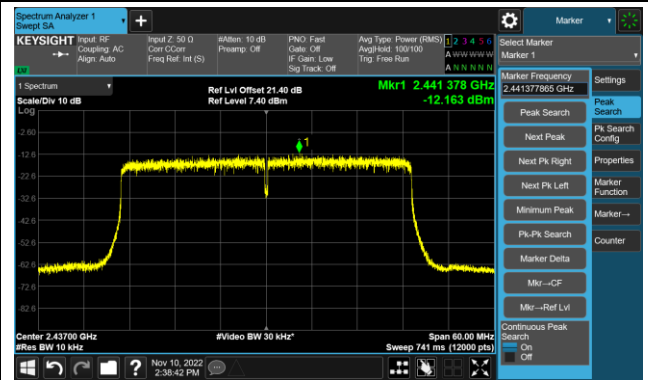

Channel 09 (2452MHz)

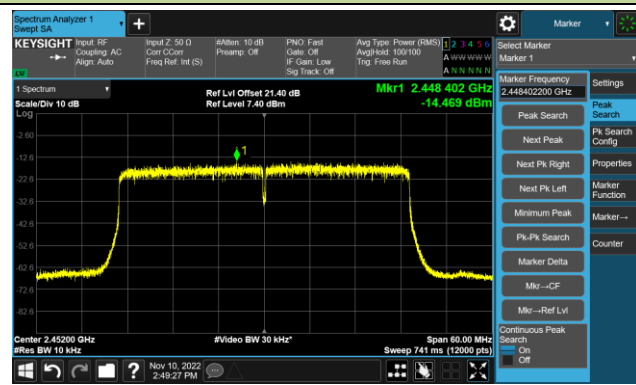

802.11b - PSD – Ant 3

Channel 01 (2412MHz)

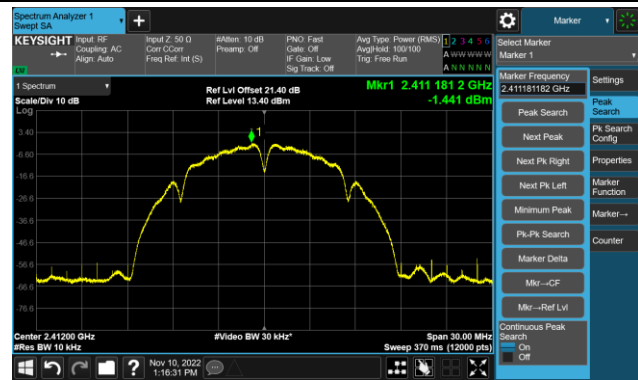

Channel 06 (2437MHz)



Channel 11 (2462MHz)



802.11g - PSD – Ant 3

Channel 01 (2412MHz)

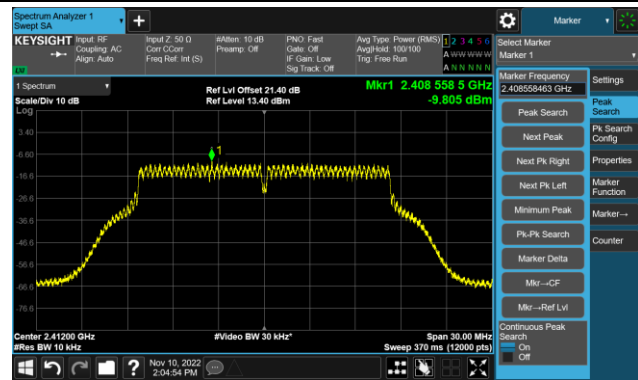

Channel 06 (2437MHz)

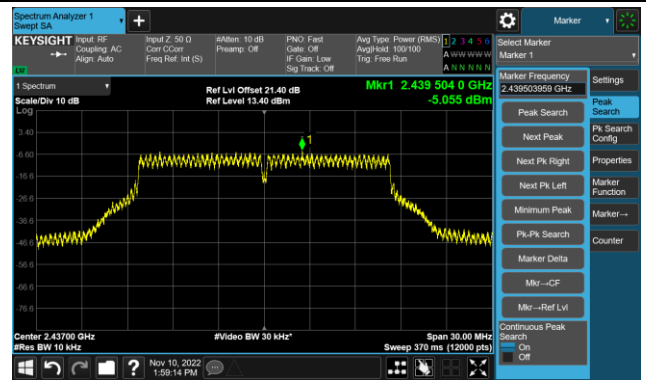

Channel 11 (2462MHz)

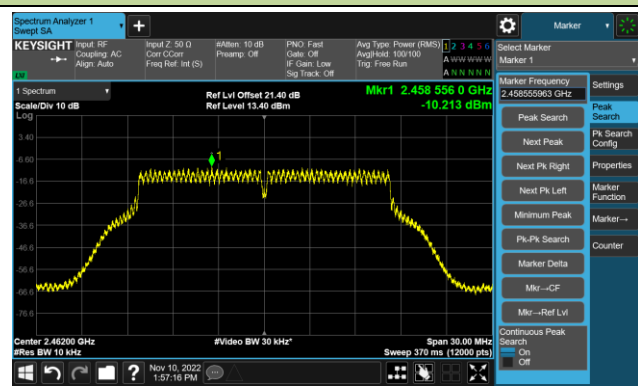

802.11n-HT20 - PSD – Ant 3

Channel 01 (2412MHz)

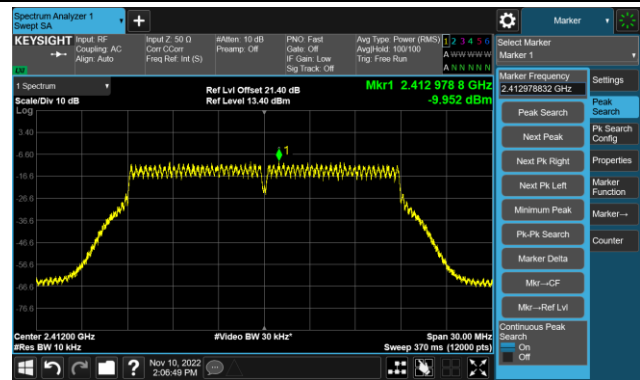

Channel 06 (2437MHz)

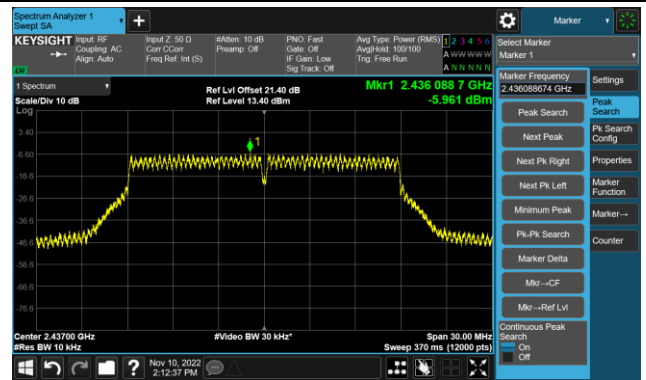

Channel 11 (2462MHz)

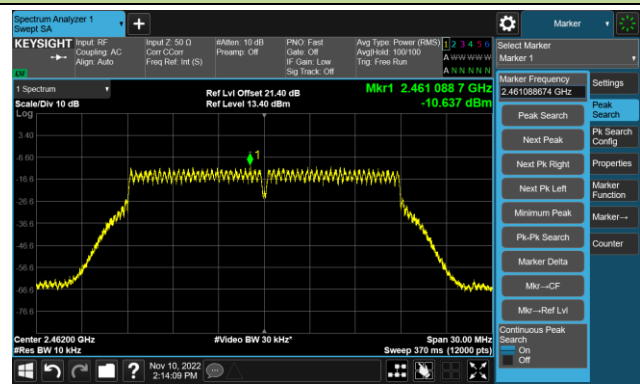

802.11n-HT40 - PSD – Ant 3

Channel 03 (2422MHz)

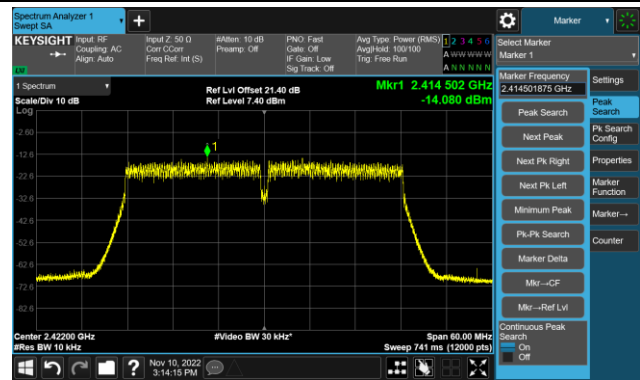

Channel 06 (2437MHz)

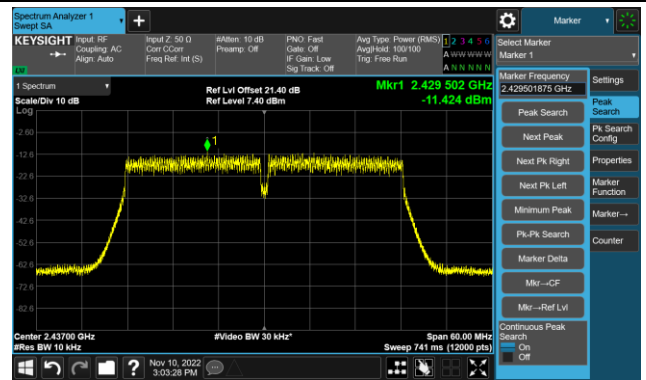

Channel 09 (2452MHz)

