

## MEASUREMENT REPORT

**FCC ID** : VW3FAST5298  
**Applicant** : SAGEMCOM BROADBAND SAS  
**Application Type** : Certification  
**Product** : Tri-band WIFI7 router  
**Model No.** : Fast 5298  
**Brand Name** : Sagemcom  
**FCC Classification** : Digital Transmission System (DTS)  
**FCC Rule Part(s)** : Part15 Subpart C (Section 15.247)  
**Received Date** : September 18, 2024  
**Test Date** : September 24, 2024~ September 30, 2024

**Tested By** : *Owen Tsai*  
( Owen Tsai )  
**Reviewed By** : *Paddy Chen*  
( Paddy Chen )  
**Approved By** : *Chenz Ker*  
( Chenz Ker )



The test results relate only to the samples tested.

This equipment has been shown to be capable of compliance with the applicable technical standards as indicated in the measurement report and was tested in accordance with the measurement procedures specified in ANSI C63.10-2013. Test results reported herein relate only to the item(s) tested.

The test report shall not be reproduced except in full without the written approval of MRT Technology (Taiwan) Co., Ltd.

---

## Revision History

Report No.	Version	Description	Issue Date	Note
2409TW0115-U3	1.0	Original Report	2024-10-08	

**Note:**

The original report number is 2406RSU023-U1 from MRT Technology (Suzhou) Co., Ltd, the bottom and side of PCB change absorbers to shielding cover, so evaluate the power, band edge and Spurious emissions to do spot check testing.

---

## CONTENTS

Description	Page
<b>1. INTRODUCTION.....</b>	<b>6</b>
1.1. Scope.....	6
1.2. MRT Test Location.....	6
<b>2. PRODUCT INFORMATION.....</b>	<b>7</b>
2.1. Feature of Equipment under Test.....	7
2.2. Product Specification Subjective to this Report.....	8
2.3. Working Frequencies for this report.....	9
2.4. Description of Available Antennas.....	10
2.5. Test Mode.....	11
2.6. Configuration of Test System.....	12
2.7. Test System Details.....	12
2.8. Description of Test Software.....	12
2.9. Applied Standards.....	13
2.10. Duty Cycle.....	14
2.11. Test Configuration.....	15
2.12. EMI Suppression Device(s)/Modifications.....	15
2.13. Labeling Requirements.....	15
<b>3. DESCRIPTION of TEST.....</b>	<b>16</b>
3.1. Evaluation Procedure.....	16
3.2. AC Line Conducted Emissions.....	16
3.3. Radiated Emissions.....	17
<b>4. ANTENNA REQUIREMENTS.....</b>	<b>18</b>
<b>5. TEST EQUIPMENT CALIBRATION DATE.....</b>	<b>19</b>
<b>6. MEASUREMENT UNCERTAINTY.....</b>	<b>20</b>
<b>7. TEST RESULT.....</b>	<b>21</b>
7.1. Summary.....	21
7.2. 6dB Bandwidth Measurement.....	22
7.2.1. Test Limit.....	22
7.2.2. Test Procedure used.....	22
7.2.3. Test Setting.....	22
7.2.4. Test Setup.....	22
7.2.5. Test Result.....	23
7.3. Output Power Measurement.....	24

7.3.1.	Test Limit .....	24
7.3.2.	Test Procedure Used .....	24
7.3.3.	Test Setting.....	24
7.3.4.	Test Setup .....	24
7.3.5.	Test Result.....	25
7.4.	Power Spectral Density Measurement.....	27
7.4.1.	Test Limit .....	27
7.4.2.	Test Procedure Used .....	27
7.4.3.	Test Setting.....	27
7.4.4.	Test Setup .....	28
7.4.5.	Test Result.....	29
7.5.	Conducted Band Edge and Out-of-Band Emissions .....	30
7.5.1.	Test Limit .....	30
7.5.2.	Test Procedure Used .....	30
7.5.3.	Test Setting.....	30
7.5.4.	Test Setup .....	31
7.5.5.	Test Result.....	32
7.6.	Radiated Spurious Emission Measurement .....	33
7.6.1.	Test Limit .....	33
7.6.2.	Test Procedure Used .....	33
7.6.3.	Test Setting.....	33
7.6.4.	Test Setup .....	35
7.6.5.	Test Result.....	36
7.7.	Radiated Restricted Band Edge Measurement.....	46
7.7.1.	Test Limit .....	46
7.7.2.	Test Procedure Used .....	47
7.7.3.	Test Setting.....	47
7.7.4.	Test Setup .....	48
7.7.5.	Test Result.....	49
7.8.	AC Conducted Emissions Measurement .....	69
7.8.1.	Test Limit .....	69
7.8.2.	Test Setup .....	69
7.8.3.	Test Result.....	70
<b>8.</b>	<b>CONCLUSION .....</b>	<b>71</b>
	<b>Appendix A : Test Setup Photograph .....</b>	<b>72</b>
	<b>Appendix B : External Photograph.....</b>	<b>72</b>
	<b>Appendix C : Internal Photograph.....</b>	<b>72</b>

## General Information

<b>Applicant</b>	SAGEMCOM BROADBAND SAS
<b>Applicant Address</b>	4 ALLEE DES MESSAGERIES 92271 BOIS-COLOMBES CEDEX - FRANCE
<b>Manufacturer</b>	SAGEMCOM BROADBAND SAS
<b>Manufacturer Address</b>	4 ALLEE DES MESSAGERIES 92271 BOIS-COLOMBES CEDEX - FRANCE
<b>Test Site</b>	MRT Technology (Taiwan) Co., Ltd
<b>Test Site Address</b>	No. 38, Fuxing Second Rd., Guishan Dist., Taoyuan City 333, Taiwan (R.O.C)
<b>MRT FCC Registration No.</b>	291082
<b>FCC Rule Part(s)</b>	Part 15.247

## Test Facility / Accreditations

1. MRT facility is a FCC registered (Reg. No. 291082) test facility with the site description report on file and is designated by the FCC as an Accredited Test Firm.
2. MRT facility is an IC registered (MRT Reg. No. 21723) test laboratory with the site description on file at Industry Canada.
3. MRT Lab is accredited to ISO 17025 by the Taiwan Accreditation Foundation (TAF Cert. No. 3261) in EMC, Telecommunications and Radio testing for FCC (Designation Number: TW3261), Industry Canada, EU and TELEC Rules.

# 1. INTRODUCTION

## 1.1. Scope

Measurement and determination of electromagnetic emissions (EMC) of radio frequency devices including intentional and/or unintentional radiators for compliance with the technical rules and regulations of the Federal Communications Commission and the Innovation, Science and Economic Development Canada and Certification and Engineering Bureau.

## 1.2. MRT Test Location

The map below shows the location of the MRT LABORATORY, its proximity to the Taoyuan City. These measurement tests were conducted at the MRT Technology (Taiwan) Co., Ltd. Facility located at No.38, Fuxing 2nd Rd., Guishan Dist., Taoyuan City 33377, Taiwan (R.O.C).

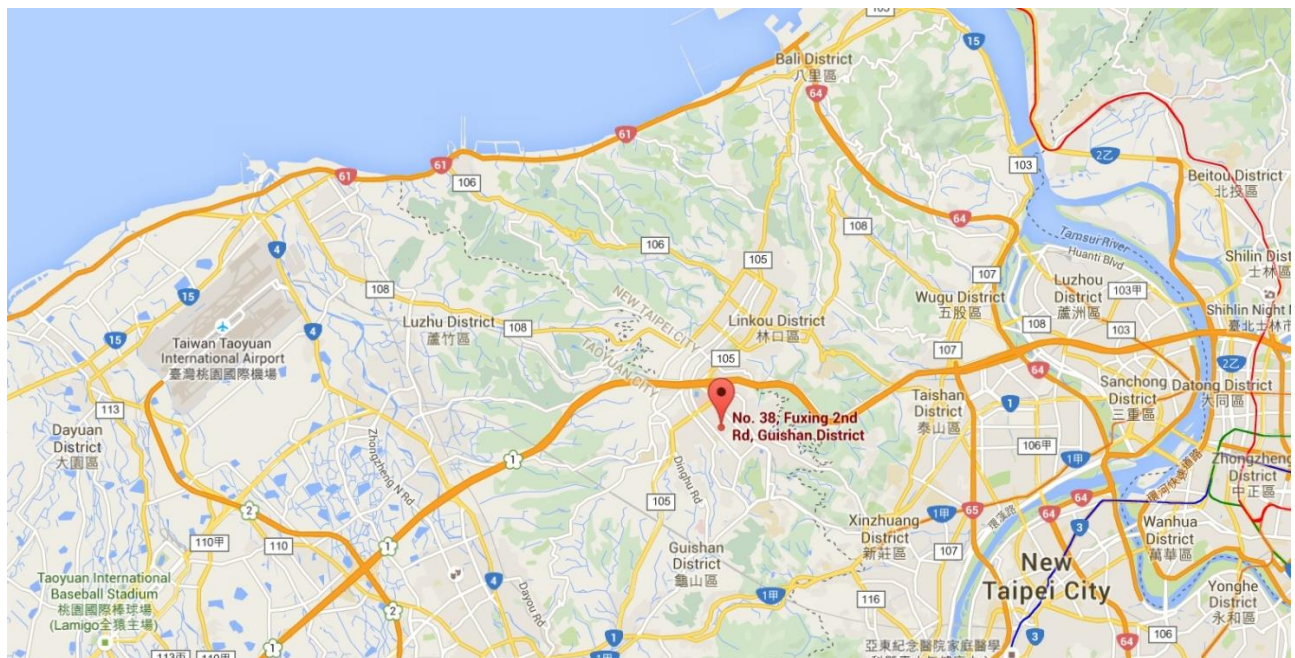

## 2. PRODUCT INFORMATION

### 2.1. Feature of Equipment under Test

Product Name:	Tri-band WIFI7 router
Model No.:	Fast 5298
Brand Name:	Sagemcom
Wi-Fi Specification:	802.11a/b/g/n/ac/ax/be
Bluetooth Specification	Bluetooth Mode: V5.1
EUT Identification No.:	#1-1 (Conducted) #1-2 (Radiated)
Accessory	
Power Adapter#1	Brand: Sagemcom Model No: ADS-50DG-12 12049EPCU-L Input: AC 100-127V, 50-60Hz, Max 1.2A Output: 12.0V=4.1A DC Cable Out: Non-Shielded, 1.8m
Power Adapter#2	Brand: Sagemcom Model No: MS-V4100R120-050A0-US Input: AC 100-127V, 50-60Hz, Max 1.3A Output: 12.0V=4.1A 49.2W DC Cable Out: Non-Shielded, 1.8m
Power Adapter#3	Brand: Sagemcom Model No: NBS42G120410VU Input: AC 100-127V, 50-60Hz, Max 1.5A Output: 12.0V=4.1A DC Cable Out: Non-Shielded, 1.8m
Remark:	
<ol style="list-style-type: none"> <li>1. The information of EUT was provided by the manufacturer, and the accuracy of the information shall be the responsibility of the manufacturer.</li> <li>2. For this report, we select Adapter 1# for testing</li> </ol>	

## 2.2. Product Specification Subjective to this Report

Frequency Range:	802.11b/g/n-HT20/ax-HE20/be-EHT20: 2412 ~ 2462MHz 802.11n-HT40/ax-HE40/be-EHT40: 2422 ~ 2452MHz	
Channel Number:	802.11b/g/n-HT20/ax-HE20/be-EHT20: 11 802.11n-HT40/ax-HE40/be-EHT40: 7	
Type of Modulation:	802.11b: DSSS 802.11g/n: OFDM 802.11ax/be: OFDMA	
Data Rate:	802.11b: 1/2/5.5/11Mbps 802.11g: 6/9/12/18/24/36/48/54Mbps 802.11n: up to 600Mbps 802.11ax: up to 1148Mbps 802.11be: up to 1376Mbps	
Channel Puncturing Function	<input type="checkbox"/> Supported	<input checked="" type="checkbox"/> Unsupported
Support RU	<input checked="" type="checkbox"/> Full RU	<input type="checkbox"/> Partial RU

Note: For other features of this EUT, test report will be issued separately.



### 2.3. Working Frequencies for this report

802.11b/g/n-HT20/ax-HE20/be-EHT20

Channel	Frequency	Channel	Frequency	Channel	Frequency
01	2412 MHz	02	2417 MHz	03	2422 MHz
04	2427 MHz	05	2432 MHz	06	2437 MHz
07	2442 MHz	08	2447 MHz	09	2452 MHz
10	2457 MHz	11	2462 MHz	--	--

802.11n-HT40/ax-HE40/be-EHT40

Channel	Frequency	Channel	Frequency	Channel	Frequency
03	2422 MHz	04	2427 MHz	05	2432 MHz
06	2437 MHz	07	2442 MHz	08	2447 MHz
09	2452 MHz	--	--	--	--

## 2.4. Description of Available Antennas

Antenna Type	Frequency Band (GHz)	Antenna Gain (dBi)				Directional Gain (dBi)	
		Ant 0	Ant 1	Ant 2	Ant 3	For Power	For PSD
Wi-Fi Internal Antenna							
PCB Antenna	2412 ~ 2462	4.42	4.37	4.42	4.40	4.42	5.96
	5180 ~ 5825	4.86	4.82	4.82	4.80	4.86	5.97
	5925 ~ 7125	4.90	4.93	4.91	4.90	4.93	5.86
<p>Note 1: The antenna gain and directional gain refer to manufacturer's antenna specification.</p> <p>Note 2: The EUT supports Cyclic Delay Diversity (CDD) mode for 802.11a/b/g/n/ac/ax.</p> <p>Note 3: Software automatically backs power down based on CDD power for beamforming operation.</p>							

## 2.5. Test Mode

CDD Mode
Mode 1: Transmit by 802.11b_N <sub>SS</sub> =1 (1Mbps) (CDD mode)
Mode 2: Transmit by 802.11g_ N <sub>SS</sub> =1 (6Mbps) (CDD mode)
Mode 3: Transmit by 802.11n-HT20_ N <sub>SS</sub> =1 (MCS0) (CDD mode)
Mode 4: Transmit by 802.11n-HT40_ N <sub>SS</sub> =1 (MCS0) (CDD mode)
Mode 5: Transmit by 802.11ax-HE20_ N <sub>SS</sub> =1 (MCS0) (CDD mode)
Mode 6: Transmit by 802.11ax-HE40_ N <sub>SS</sub> =1 (MCS0) (CDD mode)
Mode 7: Transmit by 802.11be-EHT20_ N <sub>SS</sub> =1 (MCS0)
Mode 8: Transmit by 802.11be-EHT40_ N <sub>SS</sub> =1 (MCS0)
Remark: <ol style="list-style-type: none"><li>1. For Radiated emission, the modulation and the data rate picked for testing are determined by the Max. RF conducted power.</li><li>2. For CDD mode, this device supports 4 N<sub>SS</sub> and power level is the same of spatial multiplexing. The worst case is N<sub>SS</sub>=1.</li><li>3. As Designated by manufacturer, the lowest data rate was the worst condition, so all the tests were done with lowest data rate.</li></ol>

## 2.6. Configuration of Test System

The device was tested per the guidance ANSI C63.10: 2013 was used to reference the appropriate EUT setup for radiated emissions testing and AC line conducted testing.

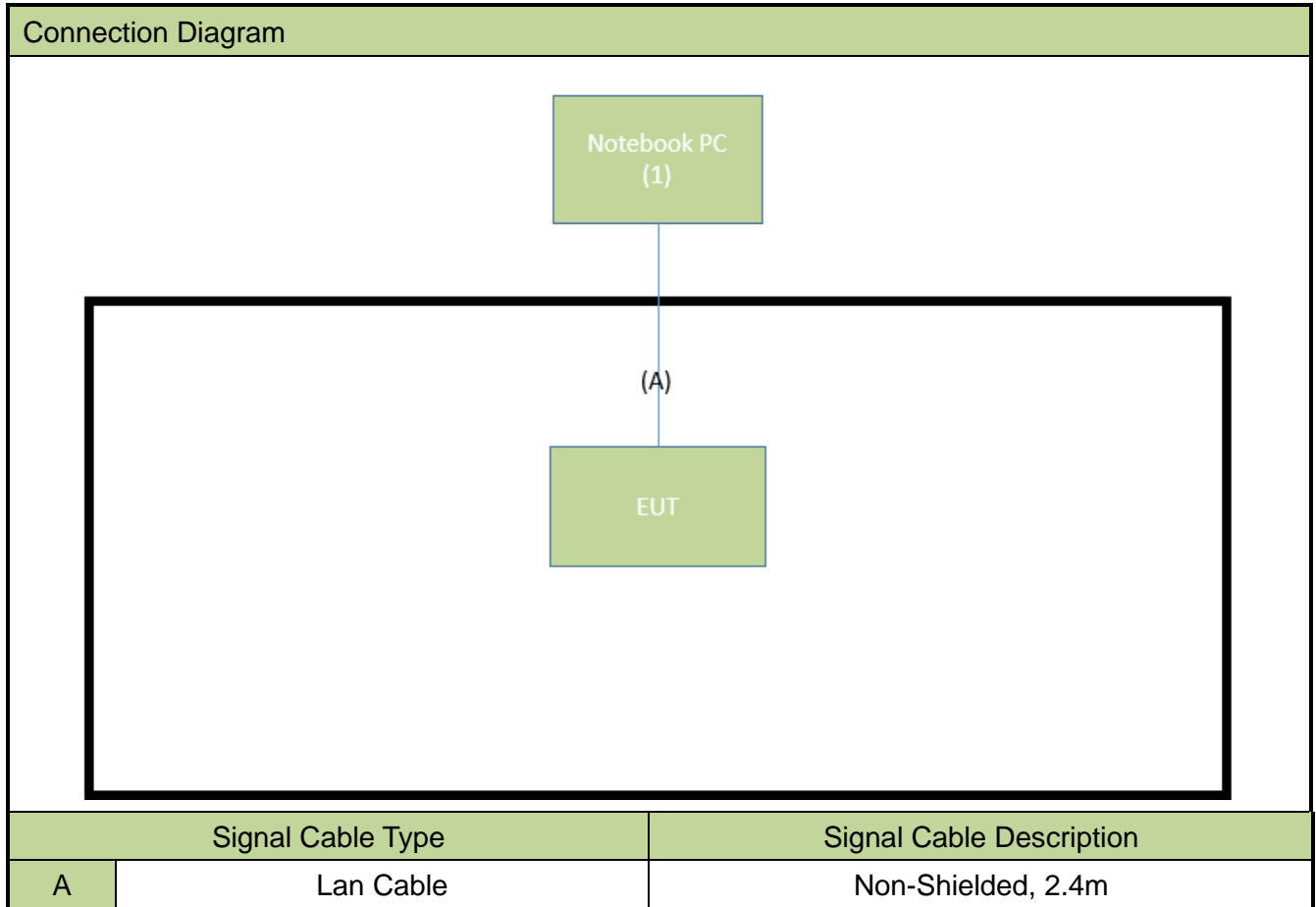

## 2.7. Test System Details

The types for all equipments, plus descriptions of all cables used in the tested system (including inserted cards) are:

No.	Product	Brand	Model No.	Serial No.	Power Cord
1	Notebook PC	Lenovo	21DH00A3TW	N/A	Non-shielded, 0.8m

## 2.8. Description of Test Software

The test utility software used during testing was “accessMTool.exe”, the version is ver3.3.0.6.

Note: Final power setting please refer to operational description.

## 2.9. Applied Standards

According to the specifications of the manufacturer, the EUT must comply with the requirements of the following standards:

- FCC Part 15.247
- KDB 662911 D01v02r01
- ANSI C63.10-2013

## 2.10. Duty Cycle

2.4GHz WLAN (DTS) operation is possible in 20MHz and 40MHz channel bandwidths. The maximum achievable duty cycles for all modes were determined based on measurements performed on a spectrum analyzer in zero-span mode with RBW = 8MHz, VBW = 50MHz. The RBW and VBW were both greater than 50/T, where T is the minimum transmission duration, and the number of sweep points across T was greater than 100. The duty cycles are as follows:

Test Mode	Duty Cycle
802.11b	95.18%
802.11g	94.64%
802.11n-HT20	94.96%
802.11n-HT40	90.19%
802.11ax-HE20	98.30%
802.11ax-HE40	96.22%
802.11be-EHT20	97.72%
802.11be-EHT40	95.94%

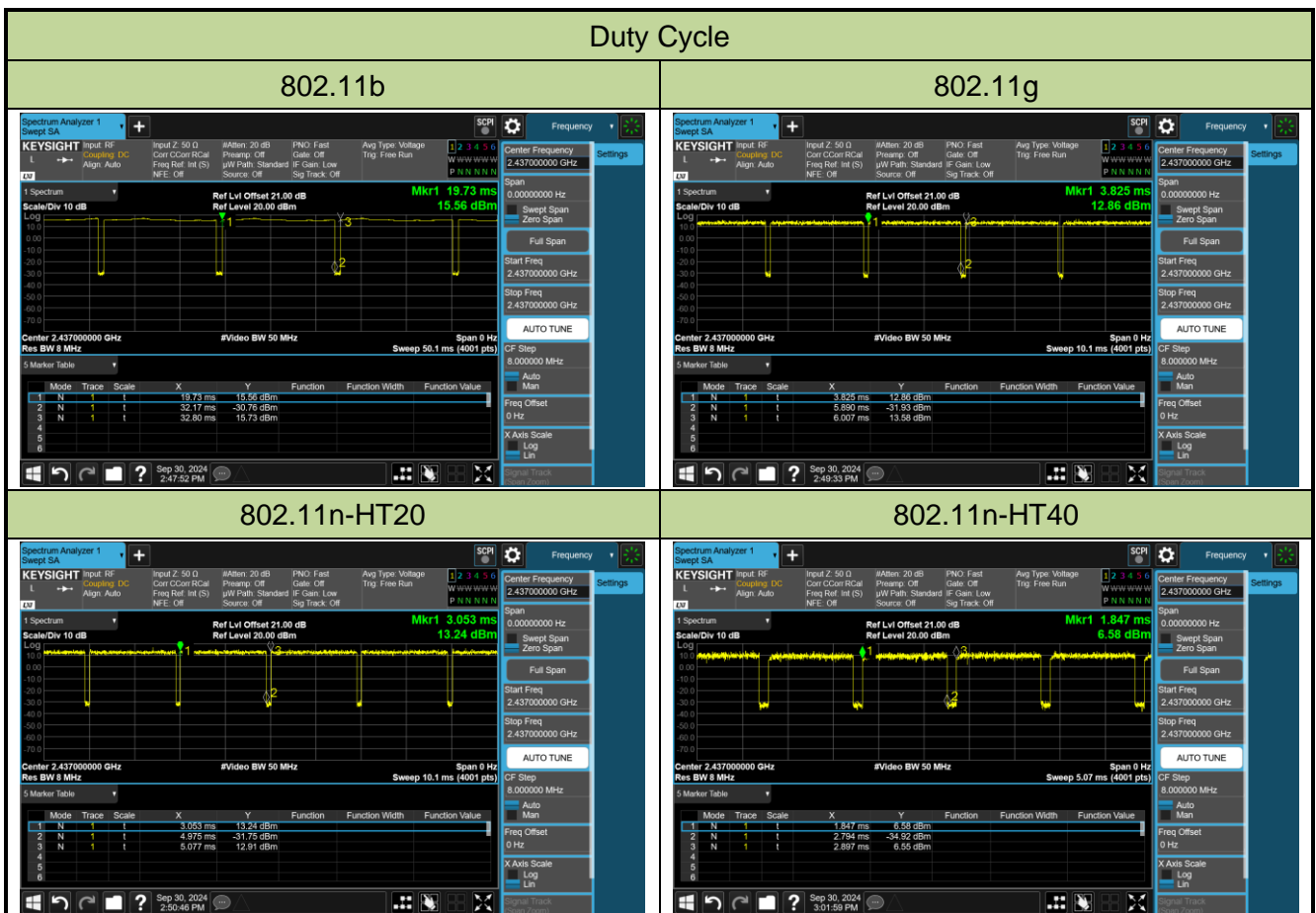

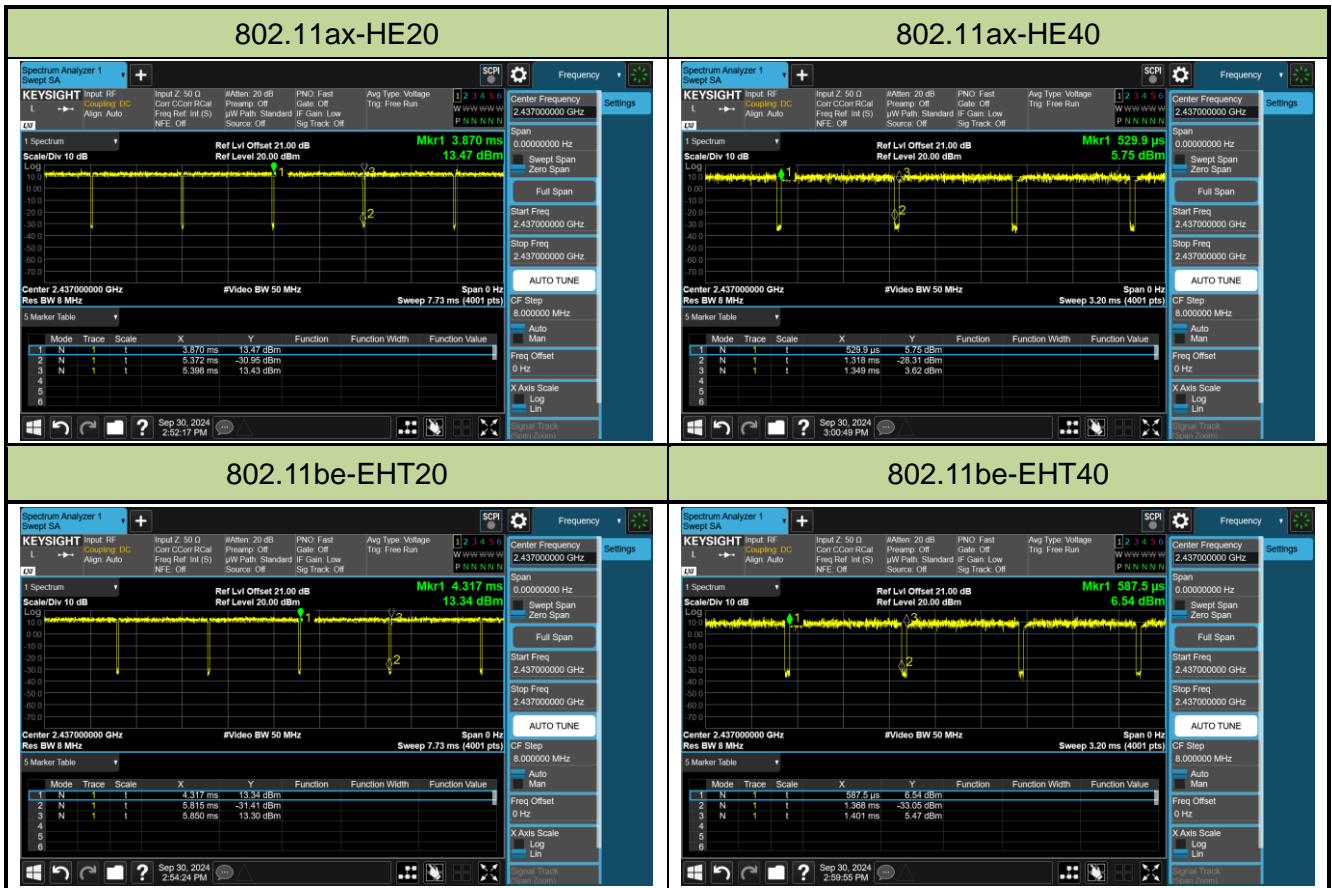

## 2.11. Test Configuration

The device was tested per the guidance of ANSI C63.10-2013. ANSI C63.10-2013 was used to reference the appropriate EUT setup for radiated spurious emissions testing and AC line conducted testing.

## 2.12. EMI Suppression Device(s)/Modifications

No EMI suppression device(s) were added and/or no modifications were made during testing.

## 2.13. Labeling Requirements

Per 2.1074 & 15.19; Docket 95-19

The label shall be permanently affixed at a conspicuous location on the device; instruction manual or pamphlet supplied to the user and be readily visible to the purchaser at the time of purchase. However, when the device is so small wherein placement of the label with specified statement is not practical, only the FCC ID must be displayed on the device per Section 15.19(a)(5). Please see attachment for FCC ID label and label location.

### **3. DESCRIPTION of TEST**

#### **3.1. Evaluation Procedure**

The measurement procedures described in the American National Standard of Procedures for Compliance Testing of Unlicensed Wireless Devices (ANSI C63.10-2013), and the guidance was used in the measurement.

#### **3.2. AC Line Conducted Emissions**

The line-conducted facility is located inside an 8'x4'x4' shielded enclosure. A 1m x 2m wooden table 80cm high is placed 40cm away from the vertical wall and 80cm away from the sidewall of the shielded room. Two 10kHz-30MHz, 50Ω/50uH Line-Impedance Stabilization Networks (LISNs) are bonded to the shielded room floor. Power to the LISNs is filtered by external high-current high-insertion loss power line filters. These filters attenuate ambient signal noise from entering the measurement lines. These filters are also bonded to the shielded enclosure.

The EUT is powered from one LISN and the support equipment is powered from the second LISN. All interconnecting cables more than 1 meter were shortened to a 1 meter length by non-inductive bundling (serpentine fashion) and draped over the back edge of the test table. All cables were at least 40cm above the horizontal reference ground-plane. Power cables for support equipment were routed down to the second LISN while ensuring that that cables were not draped over the second LISN.

Sufficient time for the EUT, support equipment, and test equipment was allowed in order for them to warm up to their normal operating condition. The RF output of the LISN was connected to the receiver and exploratory measurements were made to determine the frequencies producing the maximum emission from the EUT. The receiver was scanned from 150kHz to 30MHz. The detector function was set to peak mode for exploratory measurements while the bandwidth of the analyzer was set to 9kHz. The EUT, support equipment, and interconnecting cables were arranged and manipulated to maximize each emission. Each emission was also maximized by varying power lines, the mode of operation or data exchange speed, or support equipment whichever determined the worst-case emission. Once the worst-case emissions have been identified, the one EUT cable configuration/arrangement and mode of operation that produced these emissions are used for final measurements on the same test site. The analyzer is set to CISPR quasi-peak and average detectors with a 9kHz resolution bandwidth for final measurements.

An extension cord was used to connect to a single LISN which powered by EUT. The extension cord was calibrated with LISN, the impedance and insertion loss are compliance with the requirements as stated in ANSI C63.10-2013.



### 3.3. Radiated Emissions

The radiated test facilities consisted of an indoor 3 meter semi-anechoic chamber used for final measurements and exploratory measurements, when necessary. The measurement area is contained within the semi-anechoic chamber which is shielded from any ambient interference. For measurements above 1GHz absorbers are arranged on the floor between the turn table and the antenna mast in such a way so as to maximize the reduction of reflections. For measurements below 1GHz, the absorbers are removed. A MF Model 210SS turntable is used for radiated measurement. It is a continuously rotatable, remote controlled, metallic turntable and 2 meters (6.56 ft.) in diameter. The turn table is flush with the raised floor of the chamber in order to maintain its function as a ground plane. An 80cm high PVC support structure is placed on top of the turntable.

For all measurements, the spectrum was scanned through all EUT azimuths and from 1 to 4 meter receive antenna height using a broadband antenna from 30MHz up to the upper frequency shown in 15.33(b)(1) depending on the highest frequency generated or used in the device or on which the device operates or tunes. For frequencies above 1GHz, linearly polarized double ridge horn antennas were used. For frequencies below 30MHz, a calibrated loop antenna was used. When exploratory measurements were necessary, they were performed at 1 meter test distance inside the semi-anechoic chamber using broadband antennas, broadband amplifiers, and spectrum analyzers to determine the frequencies and modes producing the maximum emissions. Sufficient time for the EUT, support equipment, and test equipment was allowed in order for them to warm up to their normal operating condition. The test set-up for frequencies below 1GHz was placed on top of the 0.8 meter high, 1 x 1.5 meter table; and test set-up for frequencies 1-40GHz was placed on top of the 1.5 meter high, 1 x 1.5 meter table. The EUT, support equipment, and interconnecting cables were arranged and manipulated to maximize each emission. Appropriate precaution was taken to ensure that all emissions from the EUT were maximized and investigated. The system configuration, clock speed, mode of operation or video resolution, if applicable, turntable azimuth, and receive antenna height was noted for each frequency found.

Final measurements were made in the semi-anechoic chamber using calibrated, linearly polarized broadband and horn antennas. The test setup was configured to the setup that produced the worst case emissions. The spectrum analyzer was set to investigate all frequencies required for testing to compare the highest radiated disturbances with respect to the specified limits. The turntable containing the EUT was rotated through 360 degrees and the height of the receive antenna was varied 1 to 4 meters and stopped at the azimuth and height producing the maximum emission. Each emission was maximized by changing the orientation of the EUT through three orthogonal planes and changing the polarity of the receive antenna, whichever produced the worst-case emissions. According to 3dB Beam-Width of horn antenna, the horn antenna should be always directed to the EUT when rising height.

## 4. ANTENNA REQUIREMENTS

### **Excerpt from §15.203 of the FCC Rules/Regulations:**

“An intentional radiator antenna shall be designed to ensure that no antenna other than that furnished by the responsible party can be used with the device. The use of a permanently attached antenna or of an antenna that uses a unique coupling to the intentional radiator shall be considered sufficient to comply with the provisions of this section.”

- The antenna of the device is **permanently attached**.
- There are no provisions for connection to an external antenna.

### **Conclusion:**

The unit complies with the requirement of §15.203.

## 5. TEST EQUIPMENT CALIBRATION DATE

### Radiated Emissions

Instrument	Manufacturer	Type No.	Asset No.	Cali. Interval	Cali. Due Date
Active Loop Antenna	SCHWARZBECK	FMZB 1519B	MRTTWA00002	1 year	2025/5/7
Broadband TRILOG Antenna	SCHWARZBECK	VULB 9162	MRTTWA00001	1 year	2024/10/31
Broadband Hornantenna	RFSPIN	DRH18-E	MRTTWA00087	1 year	2025/5/20
Broadband Preamplifier	EMC Instruments corporation	EMC118A45SE	MRTTWA00088	1 year	2025/5/14
Breitband Hornantenna	SCHWARZBECK	BBHA 9170	MRTTWA00004	1 year	2025/3/26
Broadband Amplifier	SCHWARZBECK	BBV 9721	MRTTWA00006	1 year	2025/3/21
EMI Test Receiver	R&S	ESR3	MRTTWA00009	1 year	2025/3/5
Signal Analyzer	R&S	FSVA3044	MRTTWA00092	1 year	2025/6/20
Antenna Cable	HUBERSUHNER	SF106	MRTTWE00034	1 year	2025/6/25

### Conducted Test Equipment

Instrument	Manufacturer	Type No.	Asset No.	Cali. Interval	Cali. Due Date
X-Series USB Peak and Average Power Sensor	KEYSIGHT	U2021XA	MRTTWA00014	1 year	2025/4/16
X-Series USB Peak and Average Power Sensor	KEYSIGHT	U2021XA	MRTTWA00015	1 year	2025/3/12
EXA Signal Analyzer	KEYSIGHT	N9010A	MRTTWA00012	1 year	2025/9/24
EXA Signal Analyzer	KEYSIGHT	N9010B	MRTTWA00074	1 year	2025/8/12

Software	Version	Function
e3	9.160520a	EMI Test Software

## 6. MEASUREMENT UNCERTAINTY

Where relevant, the following test uncertainty levels have been estimated for tests performed on the EUT as specified in CISPR 16-4-2. This uncertainty represents an expanded uncertainty expressed at approximately the 95% confidence level using a coverage factor of  $k = 2$ .

<b>AC Conducted Emission Measurement</b>
Measuring Uncertainty for a Level of Confidence of 95% ( $U=2Uc(y)$ ): 150kHz~30MHz: $\pm 2.53\text{dB}$
<b>Radiated Emission Measurement</b>
Measuring Uncertainty for a Level of Confidence of 95% ( $U=2Uc(y)$ ): 9kHz ~ 1GHz: $\pm 4.25\text{dB}$ 1GHz ~ 40GHz: $\pm 4.45\text{dB}$
<b>Conducted Power (Carrier Power / Power Density)</b>
Measuring Uncertainty for a Level of Confidence of 95% ( $U=2Uc(y)$ ): $\pm 0.84\text{dB}$
<b>Conducted Spurious Emission</b>
Measuring Uncertainty for a Level of Confidence of 95% ( $U=2Uc(y)$ ): $\pm 2.65\text{ dB}$
<b>Occupied Bandwidth</b>
Measuring Uncertainty for a Level of Confidence of 95% ( $U=2Uc(y)$ ): $\pm 3.3\%$
<b>Temp. / Humidity</b>
Measuring Uncertainty for a Level of Confidence of 95% ( $U=2Uc(y)$ ): $\pm 0.82^\circ\text{C} / \pm 3\%$

## 7. TEST RESULT

### 7.1. Summary

FCC Section(s)	Test Description	Test Limit	Test Condition	Test Result	Reference
15.247(a)(2)	6dB Bandwidth	$\geq 500\text{kHz}$	Conducted	N/A	Section 7.2
15.247(b)(3)	Output Power	$\leq 30\text{dBm}$		Pass	Section 7.3
15.247(e)	Power Spectral Density	$\leq 8\text{dBm}/3\text{kHz}$		N/A	Section 7.4
15.247(d)	Band Edge / Out-of-Band Emissions	$\geq 30\text{dBc}$ (Average)		N/A	Section 7.5
15.205 15.209	General Field Strength Limits (Restricted Bands and Radiated Emission Limits)	Emissions in restricted bands must meet the radiated limits detailed in 15.209	Radiated	Pass	Section 7.6 & 7.7
15.207	AC Conducted Emissions 150kHz - 30MHz	< FCC 15.207 limits	Line Conducted	N/A	Section 7.8

#### Notes:

- 1) Determining compliance is based on the test results met the regulation limits or requirements declared by clients, and the test results don't take into account the value of measurement uncertainty.
- 2) The analyzer plots shown in this section were all taken with a correction table loaded into the analyzer. The correction table was used to account for the losses of the cables and attenuators used as part of the system to connect the EUT to the analyzer at all frequencies of interest.
- 3) Output power test was verified over all data rates of each mode (data refers to operational description), and then choose the maximum power output (low data rate) for final test of each channel.
- 4) For radiated emission test, every axis (X, Y, Z) was also verified. The test results shown in the following sections represent the worst-case emissions.
- 5) EUT supports one configuration only in 802.11ax/be full RU mode, i.e. 242 tone in 11ax-HE20 and 484 tone in 11ax-HE40.

## 7.2. 6dB Bandwidth Measurement

### 7.2.1. Test Limit

The minimum 6dB bandwidth shall be at least 500 kHz.

### 7.2.2. Test Procedure used

ANSI C63.10 - 2013 Section 11.8

### 7.2.3. Test Setting

1. The Spectrum's automatic bandwidth measurement capability was used to perform the 6dB bandwidth measurement. The "X" dB bandwidth parameter was set to  $X = 6$ . The bandwidth measurement was not influenced by any intermediate power nulls in the fundamental emission.
2. Set RBW = 100 kHz
3. VBW  $\geq 3 \times$  RBW
4. Detector = Peak
5. Trace mode = max hold
6. Sweep = auto couple
7. Allow the trace was allowed to stabilize

### 7.2.4. Test Setup

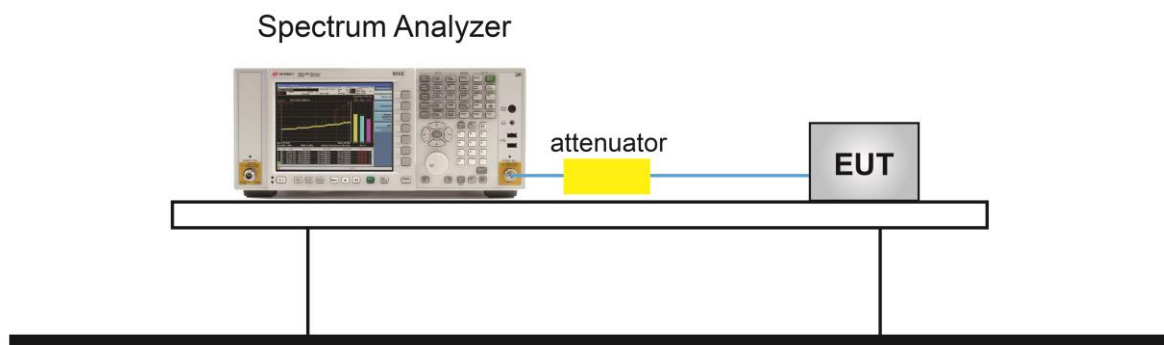

### **7.2.5. Test Result**

Note: Refer to the original report is 2406RSU023-U1.

## 7.3. Output Power Measurement

### 7.3.1. Test Limit

The maximum output power shall be less 1 Watt (30dBm).

The conducted output power limit specified in paragraph FCC Part 15.247(b) of this section is based on the use of antennas with directional gains that do not exceed 6 dBi. If transmitting antennas of directional gain greater than 6 dBi are used, the conducted output power from the intentional radiator shall be reduced below the stated values in paragraphs FCC Part 15.247(b)(3) of this section, as appropriate, by the amount in dB that the directional gain of the antenna exceeds 6 dBi.

### 7.3.2. Test Procedure Used

ANSI C63.10 - 2013 Section 11.9.2.3.2

### 7.3.3. Test Setting

#### Average Power Measurement

Average power measurements were performed only when the EUT was transmitting at its maximum power control level using a broadband power meter with a pulse sensor. The power meter implemented triggering and gating capabilities which were set up such that power measurements were recorded only during the ON time of the transmitter.

### 7.3.4. Test Setup

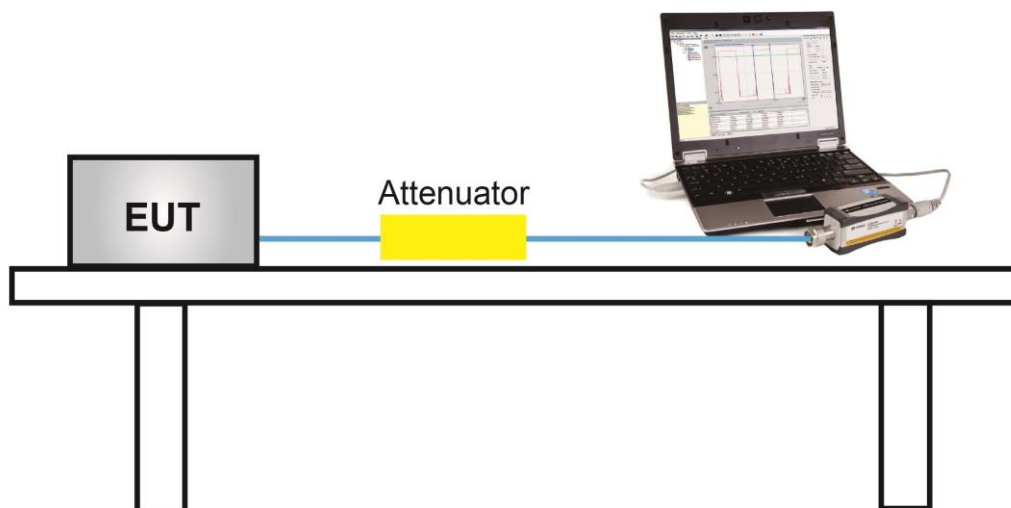



### 7.3.5. Test Result

Product	Tri-band WIFI7 router	Temperature	25°C
Test Engineer	Peter	Relative Humidity	54%
Test Site	SR6	Test Date	2024/9/30

Test Mode	Data Rate/ MCS	Channel No.	Freq. (MHz)	Ant 0 Average Power (dBm)	Ant 1 Average Power (dBm)	Ant 2 Average Power (dBm)	Ant 3 Average Power (dBm)	Total Average Power (dBm)	Limit (dBm)	Result
CDD Mode										
802.11b	1Mbps	01	2412	23.87	23.55	23.72	23.57	29.70	≤ 30.00	Pass
802.11b	1Mbps	06	2437	23.84	23.14	23.20	23.36	29.41	≤ 30.00	Pass
802.11b	1Mbps	11	2462	24.02	23.04	23.46	23.62	29.57	≤ 30.00	Pass
802.11g	6Mbps	01	2412	22.84	23.10	22.57	23.82	29.13	≤ 30.00	Pass
802.11g	6Mbps	06	2437	23.81	23.40	23.87	23.43	29.65	≤ 30.00	Pass
802.11g	6Mbps	11	2462	23.45	22.47	23.01	22.98	29.01	≤ 30.00	Pass
802.11n-HT20	MCS0	01	2412	22.61	22.93	22.88	23.44	29.00	≤ 30.00	Pass
802.11n-HT20	MCS0	06	2437	23.89	23.21	23.63	23.66	29.62	≤ 30.00	Pass
802.11n-HT20	MCS0	11	2462	23.77	23.23	23.41	23.85	29.59	≤ 30.00	Pass

Test Mode	Data Rate/ MCS	Channel No.	Freq. (MHz)	Ant 0 Average Power (dBm)	Ant 1 Average Power (dBm)	Ant 2 Average Power (dBm)	Ant 3 Average Power (dBm)	Total Average Power (dBm)	Limit (dBm)	Result
CDD Mode										
802.11n-HT40	MCS0	03	2422	23.09	23.01	23.21	23.46	29.22	≤ 30.00	Pass
802.11n-HT40	MCS0	06	2437	23.81	23.47	23.88	23.33	29.65	≤ 30.00	Pass
802.11n-HT40	MCS0	09	2452	23.77	23.23	23.79	23.37	29.57	≤ 30.00	Pass
802.11ax-HE20	MCS0	01	2412	22.89	23.21	23.28	23.71	29.30	≤ 30.00	Pass
802.11ax-HE20	MCS0	06	2437	23.63	23.33	23.62	23.39	29.52	≤ 30.00	Pass
802.11ax-HE20	MCS0	11	2462	23.79	23.04	23.35	23.69	29.50	≤ 30.00	Pass
802.11ax-HE40	MCS0	03	2422	23.55	23.37	23.19	23.59	29.45	≤ 30.00	Pass
802.11ax-HE40	MCS0	06	2437	23.64	23.23	23.89	23.66	29.63	≤ 30.00	Pass
802.11ax-HE40	MCS0	09	2452	23.72	23.63	23.91	22.88	29.57	≤ 30.00	Pass
802.11be-EHT20	MCS0	01	2412	23.08	23.96	23.18	24.09	29.62	≤ 30.00	Pass
802.11be-EHT20	MCS0	06	2437	23.19	23.78	23.45	23.49	29.50	≤ 30.00	Pass
802.11be-EHT20	MCS0	11	2462	23.44	23.57	23.01	23.98	29.53	≤ 30.00	Pass
802.11be-EHT40	MCS0	03	2422	23.39	23.87	22.99	23.79	29.54	≤ 30.00	Pass
802.11be-EHT40	MCS0	06	2437	23.19	23.72	23.43	23.66	29.53	≤ 30.00	Pass
802.11be-EHT40	MCS0	09	2452	23.27	23.79	23.27	23.66	29.52	≤ 30.00	Pass

Note: Total Average Power (dBm) =  $10 \cdot \log \{10^{(\text{Ant 0 Average Power} / 10)} + 10^{(\text{Ant 1 Average Power} / 10)} + 10^{(\text{Ant 2 Average Power} / 10)} + 10^{(\text{Ant 3 Average Power} / 10)}\}$ .

## **7.4. Power Spectral Density Measurement**

### **7.4.1. Test Limit**

The maximum permissible power spectral density is 8dBm in any 3 kHz band.

The same method of determining the conducted output power shall be used to determine the power spectral density.

### **7.4.2. Test Procedure Used**

ANSI C63.10 - 2013 Section 11.10.5

### **7.4.3. Test Setting**

1. Measure the duty cycle (x) of the transmitter output signal.
2. Set instrument center frequency to DTS channel center frequency.
3. Set span to at least 1.5 times the OBW.
4. RBW = 10 kHz.
5. VBW = 30 kHz.
6. Detector = RMS.
7. Ensure that the number of measurement points in the sweep  $\geq 2 \times \text{span}/\text{RBW}$ .
8. Sweep time = auto couple.
9. Don't use sweep triggering. Allow sweep to "free run".
10. Employ trace averaging (RMS) mode over a minimum of 100 traces.
11. Use the peak marker function to determine the maximum amplitude level.
12. Add  $10 \log (1/x)$ , where x is the duty cycle measured in step (a), to the measured PSD to compute the average PSD during the actual transmission time.

### 7.4.4. Test Setup

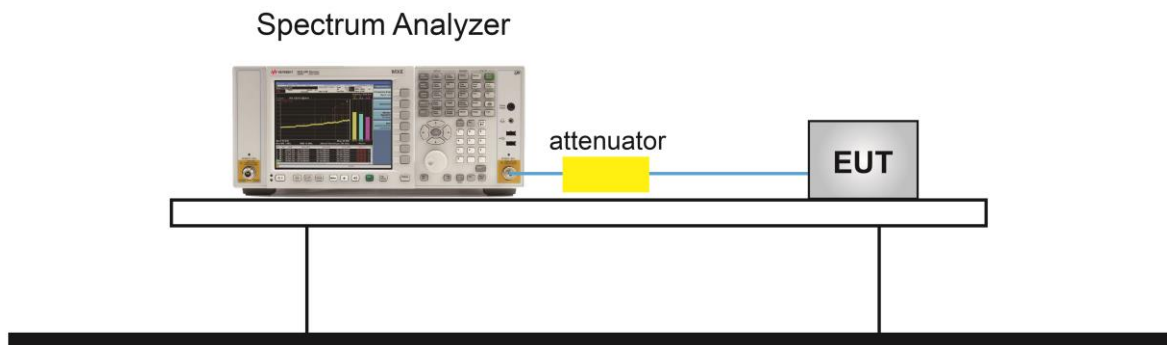

#### **7.4.5. Test Result**

Note: Refer to the original report is 2406RSU023-U1.

## **7.5. Conducted Band Edge and Out-of-Band Emissions**

### **7.5.1. Test Limit**

The limit for out-of-band spurious emissions at the band edge is 30dB below the fundamental emission level, as determined from the in-band power measurement of the DTS channel performed in a 100 kHz bandwidth per the PSD procedure.

### **7.5.2. Test Procedure Used**

ANSI C63.10 - 2013 Section 11.11

### **7.5.3. Test Setting**

#### **Reference level measurement**

1. Set instrument center frequency to DTS channel center frequency
2. Set the span to  $\geq 1.5$  times the DTS bandwidth
3. Set the RBW = 100 kHz
4. Set the VBW  $\geq 3 \times$  RBW
5. Detector = peak
6. Sweep time = auto couple
7. Trace mode = max hold
8. Allow trace to fully stabilize

#### **Emission level measurement**

1. Set the center frequency and span to encompass frequency range to be measured
2. RBW = 100kHz
3. VBW = 300kHz
4. Detector = Peak
5. Trace mode = max hold
6. Sweep time = auto couple
7. The trace was allowed to stabilize

### 7.5.4. Test Setup

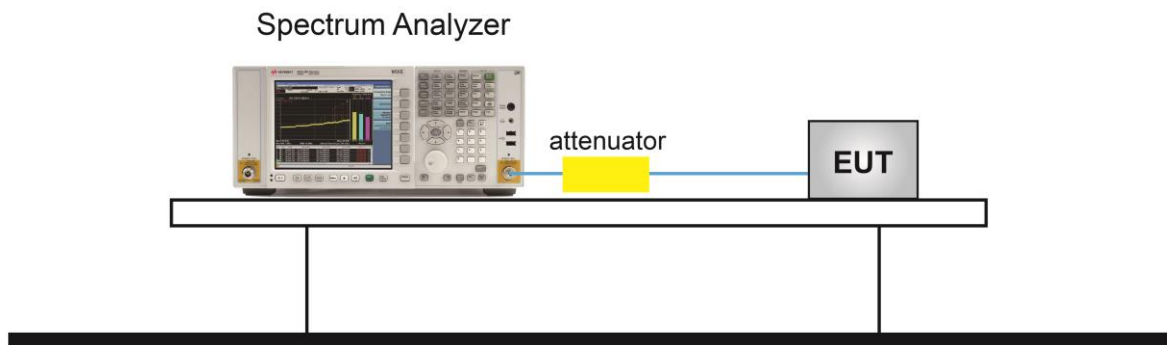

### **7.5.5. Test Result**

Note: Refer to the original report is 2406RSU023-U1.



## 7.6. Radiated Spurious Emission Measurement

### 7.6.1. Test Limit

All out of band emissions appearing in a restricted band as specified in Section 15.205 of the Title 47CFR must not exceed the limits shown in Table per Section 15.209.

FCC Part 15 Subpart C Paragraph 15.209		
Frequency [MHz]	Field Strength [Uv/m]	Measured Distance [Meters]
0.009 - 0.490	2400/F (kHz)	300
0.490 - 1.705	24000/F (kHz)	30
1.705 - 30	30	30
30 - 88	100	3
88 - 216	150	3
216 - 960	200	3
Above 960	500	3

### 7.6.2. Test Procedure Used

ANSI C63.10 - 2013 - Section 11.11 & 11.12

ANSI C63.10 - 2013 Section 6.3 (General Requirements)

ANSI C63.10 - 2013 Section 6.4 (Standard test method below 30MHz)

ANSI C63.10 - 2013 Section 6.5 (Standard test method above 30MHz to 1GHz)

ANSI C63.10 - 2013 Section 6.6 (Standard test method above 1GHz)

### 7.6.3. Test Setting

**Table 1 - RBW as a function of frequency**

Frequency	RBW
9 ~ 150 kHz	200 ~ 300 Hz
0.15 ~ 30 MHz	9 ~ 10 kHz
30 ~ 1000 MHz	100 ~ 120 kHz
> 1000MHz	1MHz

**Quasi-Peak Measurements below 1GHz**

1. Analyzer center frequency was set to the frequency of the radiated spurious emission of interest
2. Span was set greater than 1MHz
3. RBW = as specified in Table 1
4. Detector = CISPR quasi-peak
5. Sweep time = auto couple
6. Trace was allowed to stabilize

**Peak Measurements above 1GHz**

1. Analyzer center frequency was set to the frequency of the radiated spurious emission of interest
2. RBW = 1MHz
3. VBW = 3MHz
4. Detector = peak
5. Sweep time = auto couple
6. Trace mode = max hold
7. Trace was allowed to stabilize

**Average Measurements above 1GHz (Method VB)**

1. Analyzer center frequency was set to the frequency of the radiated spurious emission of interest
2. RBW = 1MHz
3. VBW; If the EUT is configured to transmit with duty cycle  $\geq 98\%$ , set VBW = 10 Hz.  
If the EUT duty cycle is  $< 98\%$ , set VBW  $\geq 1/T$ . T is the minimum transmission duration.
4. Detector = Peak
5. Sweep time = auto
6. Trace mode = max hold
7. Trace was allowed to stabilize

### 7.6.4. Test Setup

#### Below 1GHz Test Setup:

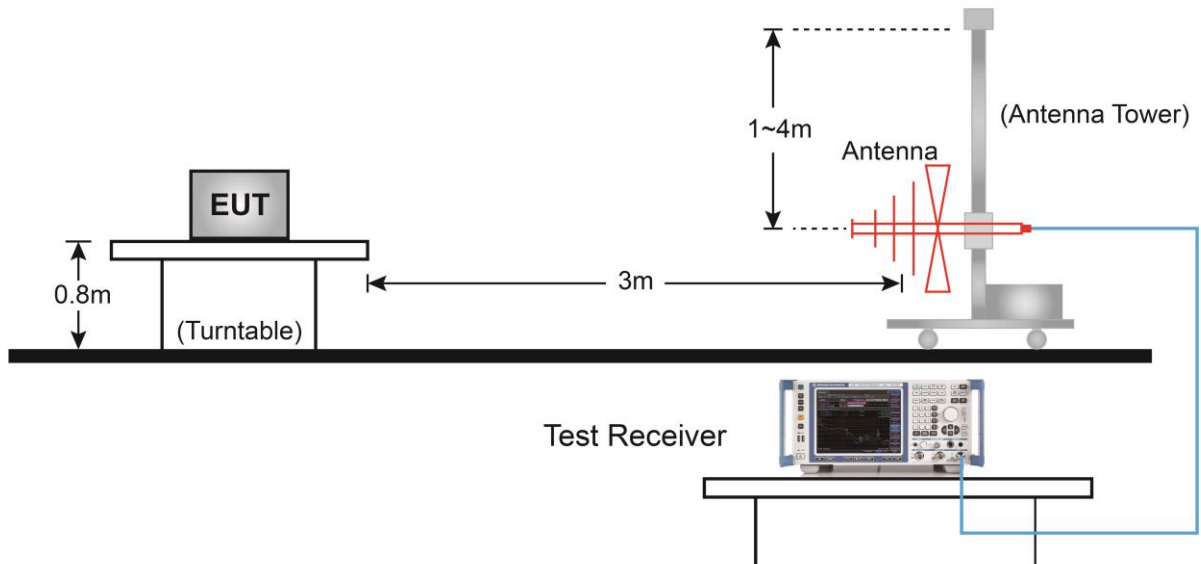

#### Above 1GHz Test Setup:

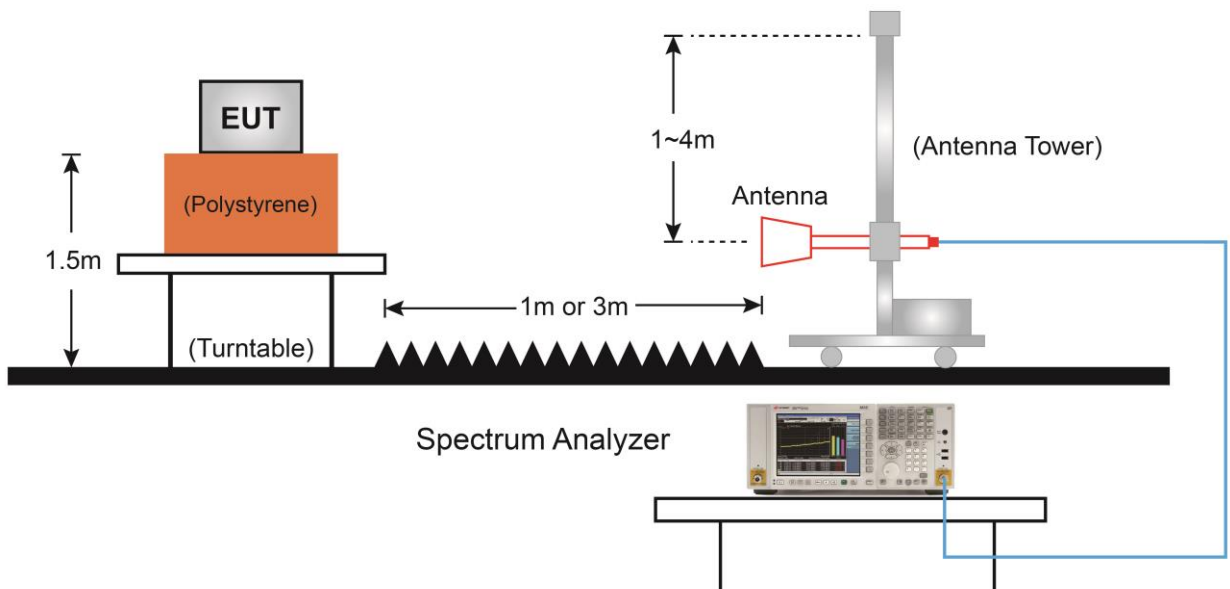

### 7.6.5. Test Result

EUT	Tri-band WIFI7 router	Date of Test	2024-09-27
Factor	DRH18-E & BBHA 9170	Temp. / Humidity	24°C /65%
Polarity	Horizontal	Site / Test Engineer	AC2 / Stanley
Test Mode	802.11b_TX_CH 1_ANT 0+1+2+3	Test Voltage	AC 120V/60Hz

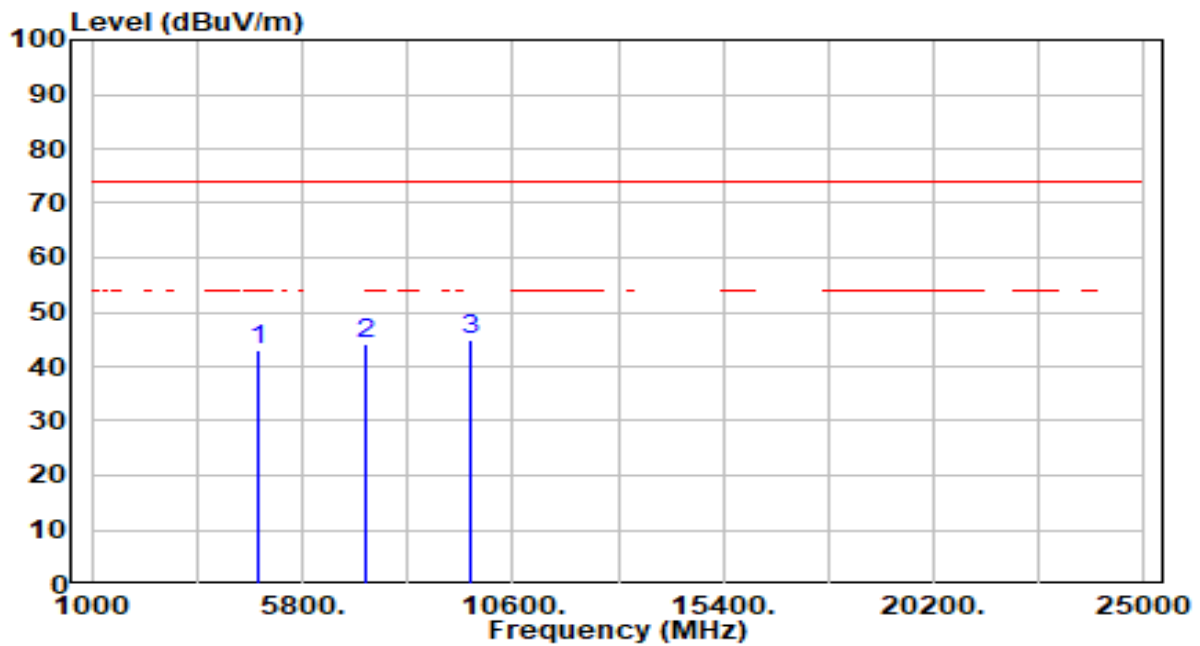

No	Frequency (MHz)	Reading (dBUV)	C.F (dB/m)	Measurement (dBUV/m)	Margin (dB)	Limit (dBUV/m)	Height (cm)	Angle (deg)	Remark (QP/PK/AV)
1	4824.000	42.93	0.15	43.08	-30.92	74.00	100	88	Peak
2	7236.000	38.44	5.81	44.25	-29.75	74.00	100	341	Peak
3	* 9648.000	39.77	5.16	44.93	-29.07	74.00	100	201	Peak

Note:

1. " \*", means this data is the worst emission level.
2. C.F (Correction Factor) = Antenna Factor (dB/m) + Cable Loss (dB) – Preamplifier(dB).
3. Measurement (dBUV/m) = Reading(dBUV) + C.F (Correction Factor).
4. The emission levels of other frequencies are very lower than the limit and not show in test report.

EUT	Tri-band WIFI7 router	Date of Test	2024-09-27
Factor	DRH18-E & BBHA 9170	Temp. / Humidity	24°C /65%
Polarity	Vertical	Site / Test Engineer	AC2 / Stanley
Test Mode	802.11b_TX_CH 1_ANT 0+1+2+3	Test Voltage	AC 120V/60Hz

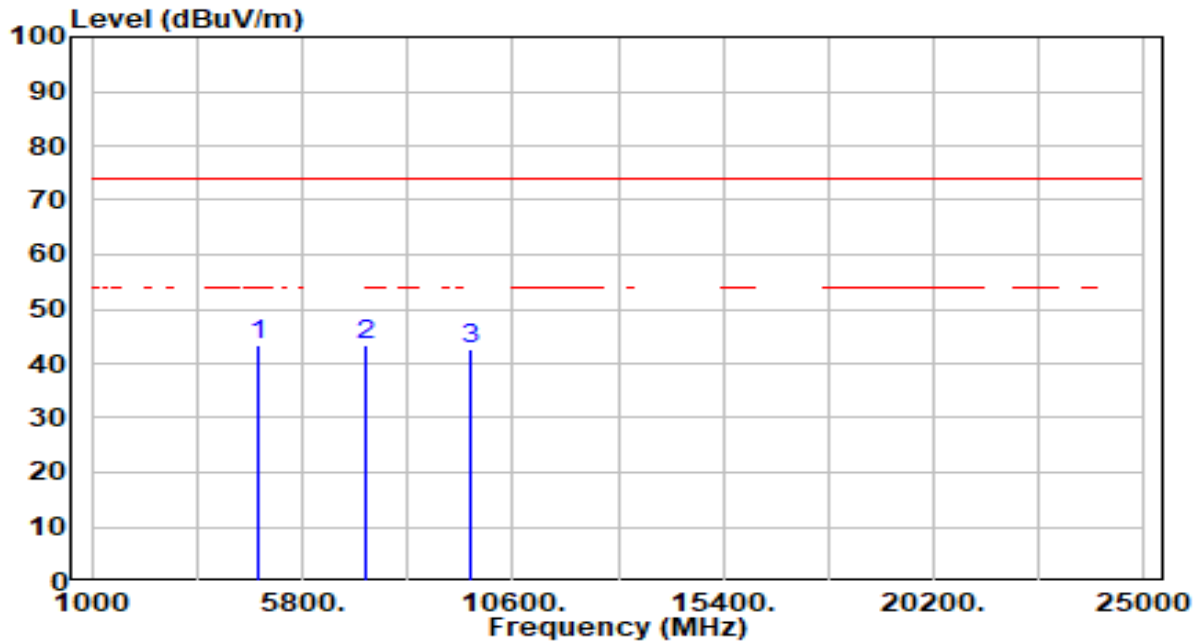

No	Frequency (MHz)	Reading (dBuV)	C.F (dB/m)	Measurement (dBuV/m)	Margin (dB)	Limit (dBuV/m)	Height (cm)	Angle (deg)	Remark (QP/PK/AV)
1	*	43.11	0.15	43.26	-30.74	74.00	100	93	Peak
2		37.44	5.81	43.25	-30.75	74.00	100	33	Peak
3		37.44	5.16	42.60	-31.40	74.00	100	153	Peak

Note:

1. " \*", means this data is the worst emission level.
2. C.F (Correction Factor) = Antenna Factor (dB/m) + Cable Loss (dB) – Preamplifier(dB).
3. Measurement (dBuV/m) = Reading(dBuV) + C.F (Correction Factor).
4. The emission levels of other frequencies are very lower than the limit and not show in test report.

EUT	Tri-band WIFI7 router	Date of Test	2024-09-24
Factor	DRH18-E & BBHA 9170	Temp. / Humidity	24°C /65%
Polarity	Horizontal	Site / Test Engineer	AC2 / Yang
Test Mode	802.11g_TX_CH 11_ANT 0+1+2+3	Test Voltage	AC 120V/60Hz

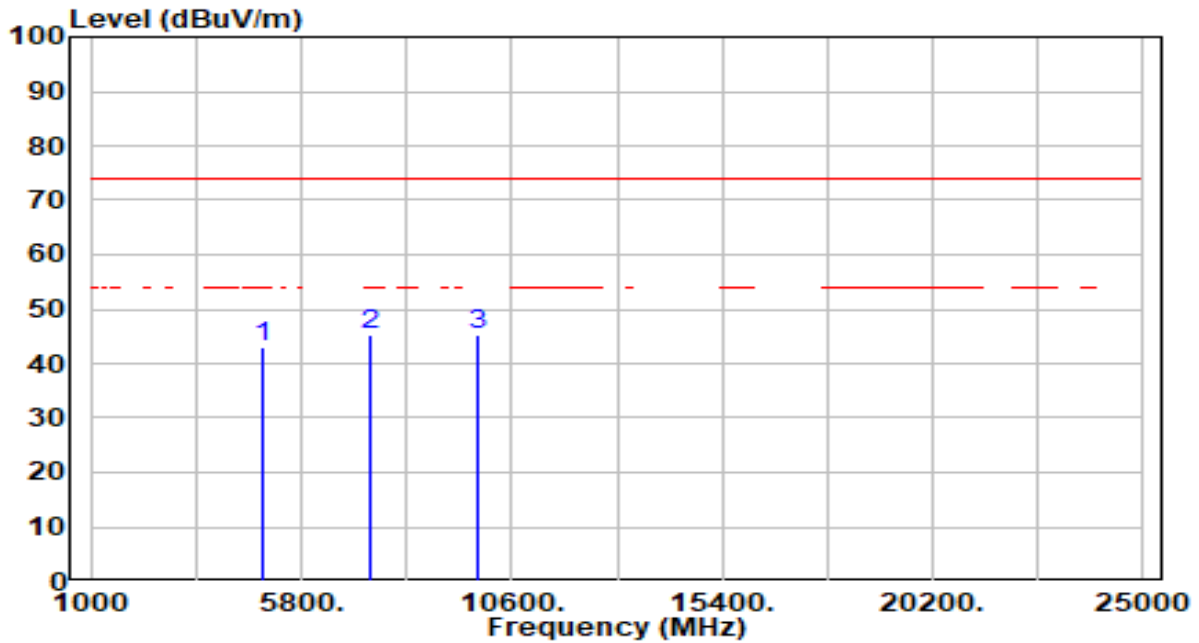

No	Frequency (MHz)	Reading (dBUV)	C.F (dB/m)	Measurement (dBUV/m)	Margin (dB)	Limit (dBUV/m)	Height (cm)	Angle (deg)	Remark (QP/PK/AV)
1	4924.000	42.67	0.35	43.02	-30.98	74.00	100	27	Peak
2	7386.000	39.35	5.82	45.17	-28.83	74.00	100	94	Peak
3	* 9848.000	40.00	5.22	45.22	-28.78	74.00	100	262	Peak

Note:

1. " \*", means this data is the worst emission level.
2. C.F (Correction Factor) = Antenna Factor (dB/m) + Cable Loss (dB) – Preamplifier(dB).
3. Measurement (dBUV/m) = Reading(dBUV) + C.F (Correction Factor).
4. The emission levels of other frequencies are very lower than the limit and not show in test report.

EUT	Tri-band WIFI7 router	Date of Test	2024-09-24
Factor	DRH18-E & BBHA 9170	Temp. / Humidity	24°C /65%
Polarity	Vertical	Site / Test Engineer	AC2 / Yang
Test Mode	802.11g_TX_CH 11_ANT 0+1+2+3	Test Voltage	AC 120V/60Hz

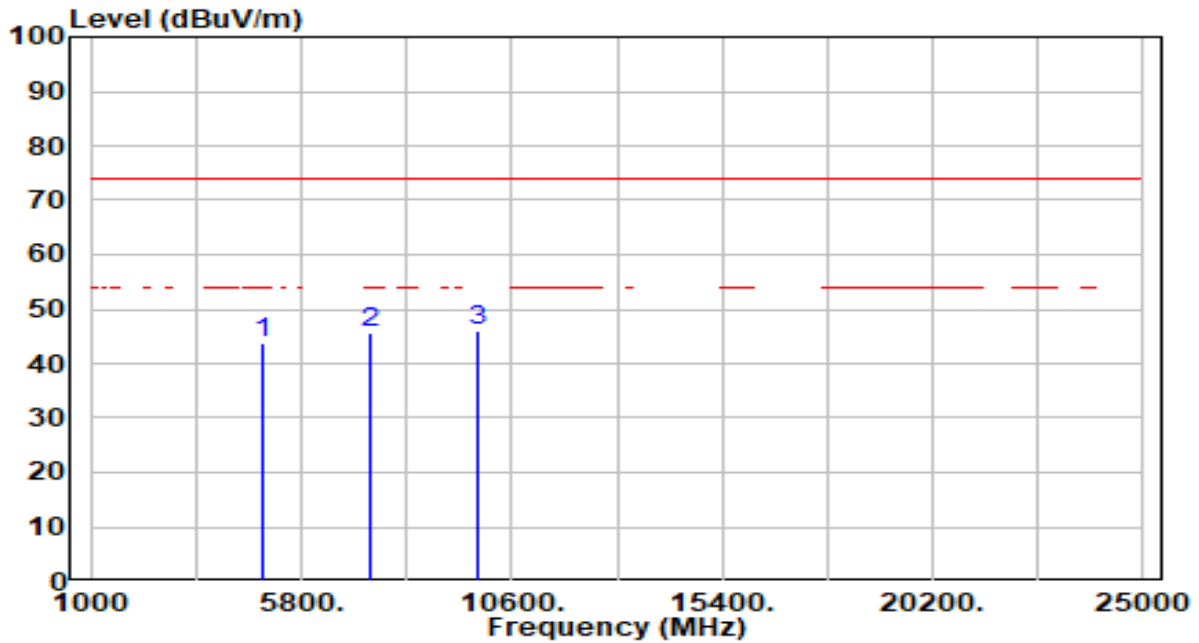

No	Frequency (MHz)	Reading (dBUV)	C.F (dB/m)	Measurement (dBUV/m)	Margin (dB)	Limit (dBUV/m)	Height (cm)	Angle (deg)	Remark (QP/PK/AV)
1	4924.000	43.42	0.35	43.77	-30.23	74.00	100	78	Peak
2	7386.000	39.67	5.82	45.49	-28.51	74.00	100	127	Peak
3	* 9848.000	40.77	5.22	45.99	-28.01	74.00	100	103	Peak

Note:

1. " \*", means this data is the worst emission level.
2. C.F (Correction Factor) = Antenna Factor (dB/m) + Cable Loss (dB) – Preamplifier(dB).
3. Measurement (dBUV/m) = Reading(dBUV) + C.F (Correction Factor).
4. The emission levels of other frequencies are very lower than the limit and not show in test report.

EUT	Tri-band WIFI7 router	Date of Test	2024-09-24
Factor	DRH18-E & BBHA 9170	Temp. / Humidity	24°C /65%
Polarity	Horizontal	Site / Test Engineer	AC2 / Yang
Test Mode	802.11n20_TX_CH 1_ANT 0+1+2+3	Test Voltage	AC 120V/60Hz

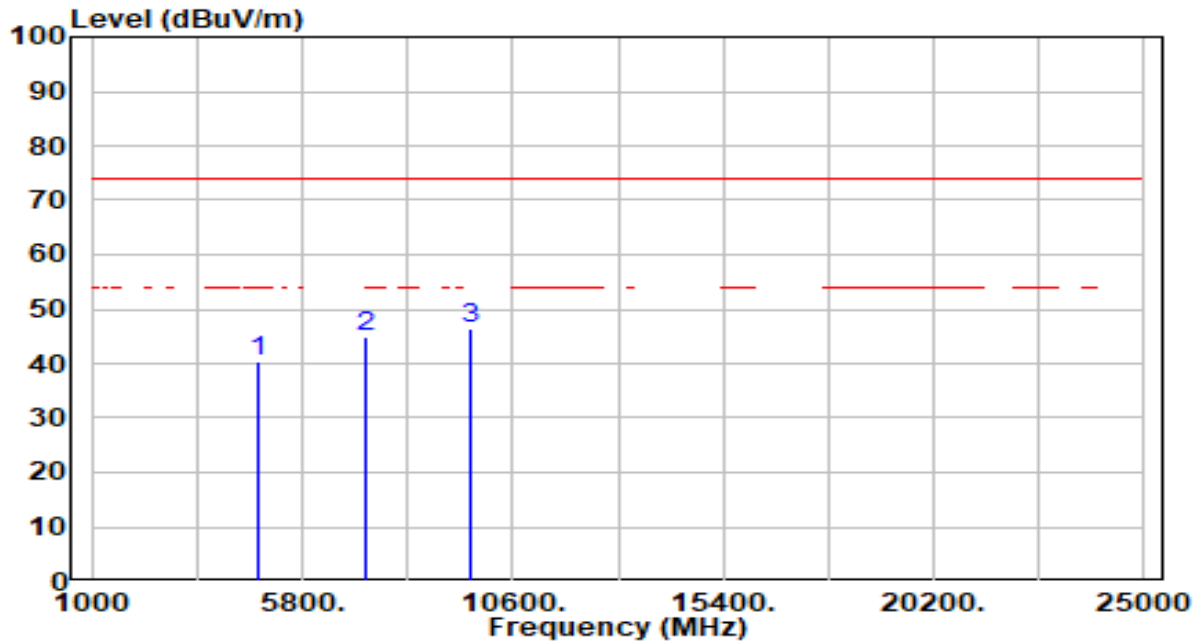

No	Frequency (MHz)	Reading (dBuV)	C.F (dB/m)	Measurement (dBuV/m)	Margin (dB)	Limit (dBuV/m)	Height (cm)	Angle (deg)	Remark (QP/PK/AV)
1	4824.000	40.08	0.15	40.23	-33.77	74.00	100	193	Peak
2	7236.000	39.13	5.81	44.94	-29.06	74.00	100	323	Peak
3	* 9648.000	41.10	5.16	46.26	-27.74	74.00	100	0	Peak

Note:

1. " \*", means this data is the worst emission level.
2. C.F (Correction Factor) = Antenna Factor (dB/m) + Cable Loss (dB) – Preamplifier(dB).
3. Measurement (dBuV/m) = Reading(dBuV) + C.F (Correction Factor).
4. The emission levels of other frequencies are very lower than the limit and not show in test report.



EUT	Tri-band WIFI7 router	Date of Test	2024-09-24
Factor	DRH18-E & BBHA 9170	Temp. / Humidity	24°C /65%
Polarity	Vertical	Site / Test Engineer	AC2 / Yang
Test Mode	802.11n20_TX_CH 1_ANT 0+1+2+3	Test Voltage	AC 120V/60Hz

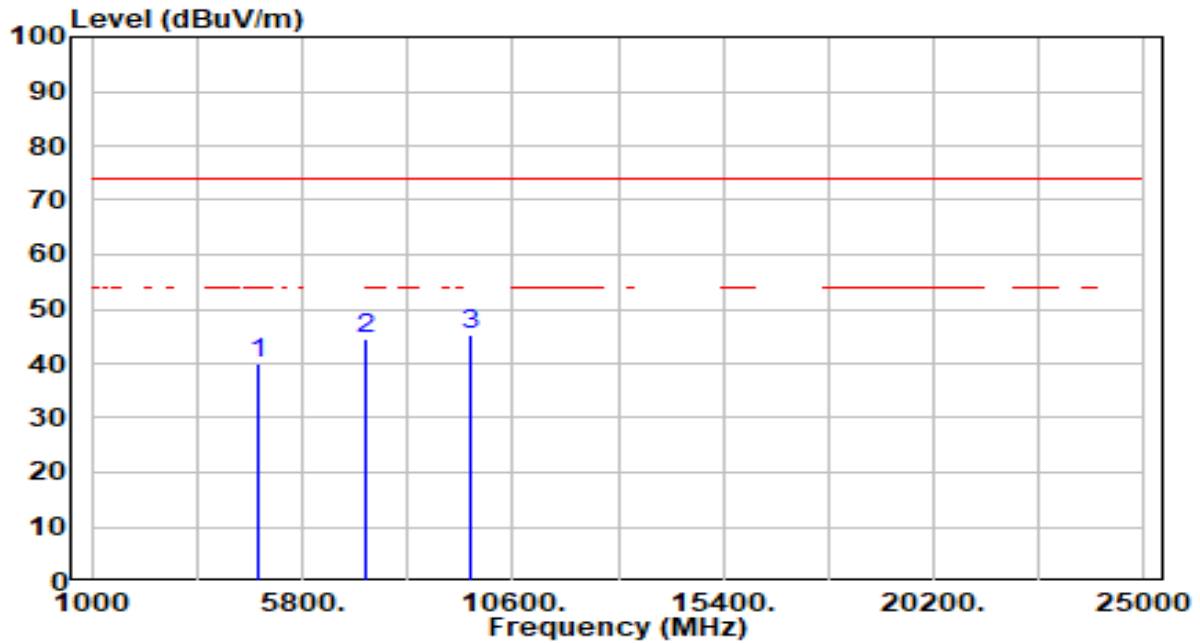

No	Frequency (MHz)	Reading (dBuV)	C.F (dB/m)	Measurement (dBuV/m)	Margin (dB)	Limit (dBuV/m)	Height (cm)	Angle (deg)	Remark (QP/PK/AV)
1	4824.000	39.93	0.15	40.08	-33.92	74.00	100	309	Peak
2	7236.000	38.87	5.81	44.68	-29.32	74.00	100	360	Peak
3	* 9648.000	40.14	5.16	45.30	-28.70	74.00	100	70	Peak

Note:

1. " \*", means this data is the worst emission level.
2. C.F (Correction Factor) = Antenna Factor (dB/m) + Cable Loss (dB) – Preamplifier(dB).
3. Measurement (dBuV/m) = Reading(dBuV) + C.F (Correction Factor).
4. The emission levels of other frequencies are very lower than the limit and not show in test report.

EUT	Tri-band WIFI7 router	Date of Test	2024-09-24
Factor	DRH18-E & BBHA 9170	Temp. / Humidity	24°C /65%
Polarity	Horizontal	Site / Test Engineer	AC2 / Yang
Test Mode	802.11ax20_TX_CH 1_ANT 0+1+2+3	Test Voltage	AC 120V/60Hz

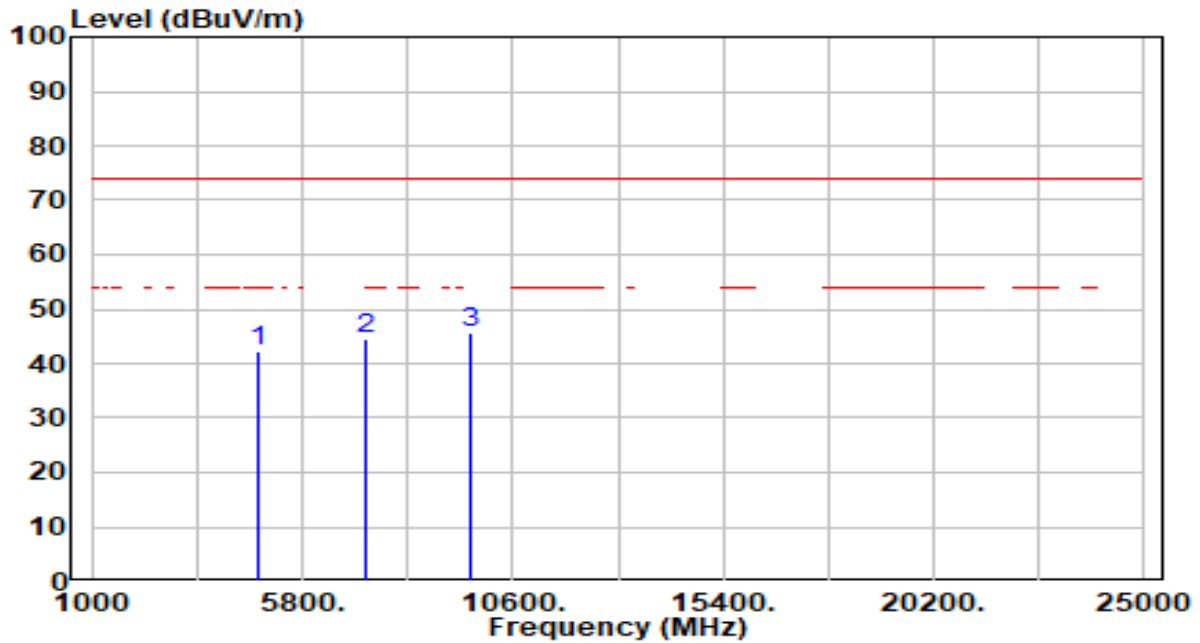

No	Frequency (MHz)	Reading (dBuV)	C.F (dB/m)	Measurement (dBuV/m)	Margin (dB)	Limit (dBuV/m)	Height (cm)	Angle (deg)	Remark (QP/PK/AV)
1	4824.000	42.00	0.15	42.15	-31.85	74.00	100	98	Peak
2	7236.000	38.69	5.81	44.50	-29.50	74.00	100	80	Peak
3	* 9648.000	40.38	5.16	45.55	-28.45	74.00	100	150	Peak

Note:

1. " \*", means this data is the worst emission level.
2. C.F (Correction Factor) = Antenna Factor (dB/m) + Cable Loss (dB) – Preamplifier(dB).
3. Measurement (dBuV/m) = Reading(dBuV) + C.F (Correction Factor).
4. The emission levels of other frequencies are very lower than the limit and not show in test report.

EUT	Tri-band WIFI7 router	Date of Test	2024-09-24
Factor	DRH18-E & BBHA 9170	Temp. / Humidity	24°C /65%
Polarity	Vertical	Site / Test Engineer	AC2 / Yang
Test Mode	802.11ax20_TX_CH 1_ANT 0+1+2+3	Test Voltage	AC 120V/60Hz

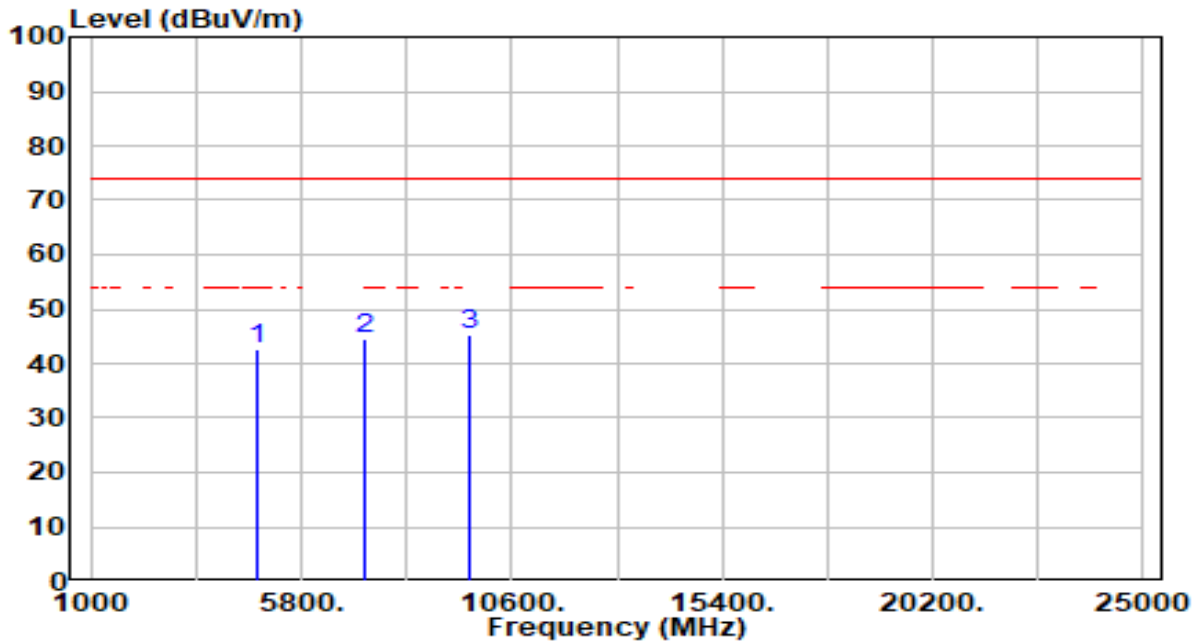

No	Frequency (MHz)	Reading (dBuV)	C.F (dB/m)	Measurement (dBuV/m)	Margin (dB)	Limit (dBuV/m)	Height (cm)	Angle (deg)	Remark (QP/PK/AV)
1	4824.000	42.52	0.15	42.67	-31.33	74.00	100	120	Peak
2	7236.000	38.85	5.81	44.67	-29.33	74.00	100	232	Peak
3	* 9648.000	39.98	5.16	45.14	-28.86	74.00	100	78	Peak

Note:

1. " \*", means this data is the worst emission level.
2. C.F (Correction Factor) = Antenna Factor (dB/m) + Cable Loss (dB) – Preamplifier(dB).
3. Measurement (dBuV/m) = Reading(dBuV) + C.F (Correction Factor).
4. The emission levels of other frequencies are very lower than the limit and not show in test report.

EUT	Tri-band WIFI7 router	Date of Test	2024-09-27
Factor	DRH18-E & BBHA 9170	Temp. / Humidity	24°C /65%
Polarity	Horizontal	Site / Test Engineer	AC2 / Stanley
Test Mode	802.11be-20MHz_TX_CH 1_ANT 0+1+2+3	Test Voltage	AC 120V/60Hz

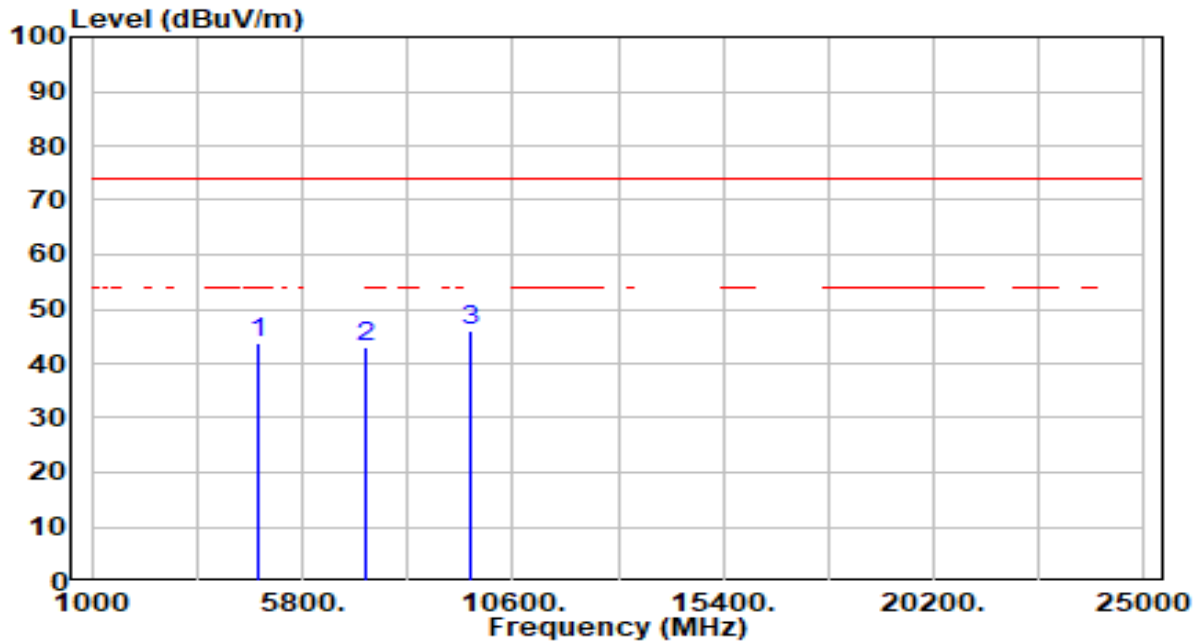

No	Frequency (MHz)	Reading (dBuV)	C.F (dB/m)	Measurement (dBuV/m)	Margin (dB)	Limit (dBuV/m)	Height (cm)	Angle (deg)	Remark (QP/PK/AV)
1	4824.000	43.44	0.15	43.59	-30.41	74.00	100	174	Peak
2	7236.000	37.21	5.81	43.02	-30.98	74.00	100	223	Peak
3	* 9648.000	40.79	5.16	45.95	-28.05	74.00	100	342	Peak

Note:

1. " \*", means this data is the worst emission level.
2. C.F (Correction Factor) = Antenna Factor (dB/m) + Cable Loss (dB) – Preamplifier(dB).
3. Measurement (dBuV/m) = Reading(dBuV) + C.F (Correction Factor).
4. The emission levels of other frequencies are very lower than the limit and not show in test report.

EUT	Tri-band WIFI7 router	Date of Test	2024-09-27
Factor	DRH18-E & BBHA 9170	Temp. / Humidity	24°C /65%
Polarity	Vertical	Site / Test Engineer	AC2 / Stanley
Test Mode	802.11be-20MHz_TX_CH 1_ANT 0+1+2+3	Test Voltage	AC 120V/60Hz

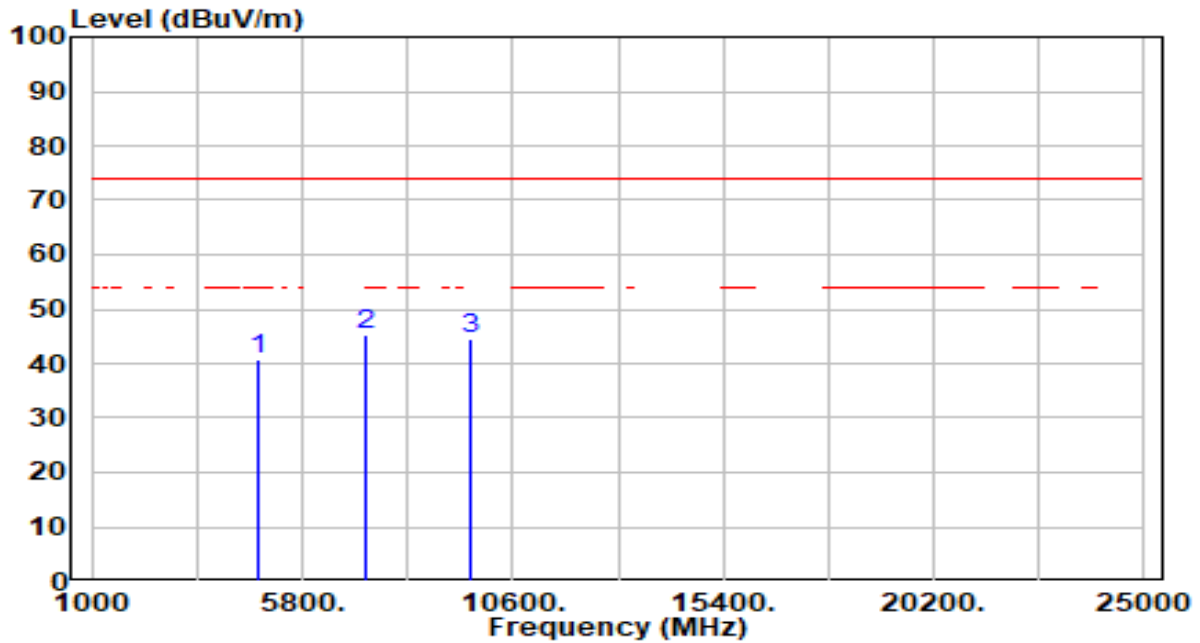

No	Frequency (MHz)	Reading (dBuV)	C.F (dB/m)	Measurement (dBuV/m)	Margin (dB)	Limit (dBuV/m)	Height (cm)	Angle (deg)	Remark (QP/PK/AV)
1	4824.000	40.75	0.15	40.90	-33.10	74.00	100	342	Peak
2	* 7236.000	39.57	5.81	45.38	-28.62	74.00	100	109	Peak
3	9648.000	39.24	5.16	44.40	-29.60	74.00	100	305	Peak

Note:

1. " \*", means this data is the worst emission level.
2. C.F (Correction Factor) = Antenna Factor (dB/m) + Cable Loss (dB) – Preamplifier(dB).
3. Measurement (dBuV/m) = Reading(dBuV) + C.F (Correction Factor).
4. The emission levels of other frequencies are very lower than the limit and not show in test report.

## 7.7. Radiated Restricted Band Edge Measurement

### 7.7.1. Test Limit

**For 15.205 requirement:**

Radiated emissions which fall in the restricted bands, as defined in Section 15.205(a) of FCC part 15, must also comply with the radiated emission limits specified in Section 15.209(a).

Frequency (MHz)	Frequency (MHz)	Frequency (MHz)	Frequency (GHz)
0.090 - 0.110	16.42 - 16.423	399.9 - 410	4.5 - 5.15
<sup>1</sup> 0.495 - 0.505	16.69475 - 16.69525	608 - 614	5.35 - 5.46
2.1735 - 2.1905	16.80425 - 16.80475	960 - 1240	7.25 - 7.75
4.125 - 4.128	25.5 - 25.67	1300 - 1427	8.025 - 8.5
4.17725 - 4.17775	37.5 - 38.25	1435 - 1626.5	9.0 - 9.2
4.20725 - 4.20775	73 - 74.6	1645.5 - 1646.5	9.3 - 9.5
6.215 - 6.218	74.8 - 75.2	1660 - 1710	10.6 - 12.7
6.26775 - 6.26825	108 - 121.94	1718.8 - 1722.2	13.25 - 13.4
6.31175 - 6.31225	123 - 138	2200 - 2300	14.47 - 14.5
8.291 - 8.294	149.9 - 150.05	2310 - 2390	15.35 - 16.2
8.362 - 8.366	156.52475 - 156.52525	2483.5 - 2500	17.7 - 21.4
8.37625 - 8.38675	156.7 - 156.9	2690 - 2900	22.01 - 23.12
8.41425 - 8.41475	162.0125 - 167.17	3260 - 3267	23.6 - 24.0
12.29 - 12.293	167.72 - 173.2	3332 - 3339	31.2 - 31.8
12.51975 - 12.52025	240 - 285	3345.8 - 3358	36.43 - 36.5
12.57675 - 12.57725	322 - 335.4	3600 - 4400	( <sup>2</sup> )
13.36 - 13.41	--	--	--

All out of band emissions appearing in a restricted band as specified in Section 15.205 of the Title 47CFR must not exceed the limits shown in Table per Section 15.209.

FCC Part 15 Subpart C Paragraph 15.209 Limits		
Frequency [MHz]	Field Strength [uV/m]	Measured Distance [Meters]
0.009 - 0.490	2400/F (kHz)	300
0.490 - 1.705	24000/F (kHz)	30
1.705 - 30	30	30
30 - 88	100	3
88 - 216	150	3
216 - 960	200	3
Above 960	500	3

### 7.7.2. Test Procedure Used

ANSI C63.10-2013 Section 6.3 & 6.6 & 11.13

### 7.7.3. Test Setting

#### Peak Field Strength Measurements

1. Analyzer center frequency was set to the frequency of the radiated spurious emission of interest
2. RBW = 1MHz
3. VBW = 3MHz
4. Detector = peak
5. Sweep time = auto couple
6. Trace mode = max hold
7. Trace was allowed to stabilize

### Average Measurements above 1GHz (Method VB)

1. Analyzer center frequency was set to the frequency of the radiated spurious emission of interest
2. RBW = 1MHz
3. VBW; If the EUT is configured to transmit with duty cycle  $\geq 98\%$ , set VBW = 10 Hz.  
If the EUT duty cycle is  $< 98\%$ , set VBW  $\geq 1/T$ . T is the minimum transmission duration.

4. Detector = Peak
5. Sweep time = auto
6. Trace mode = max hold
7. Trace was allowed to stabilize

#### 7.7.4. Test Setup

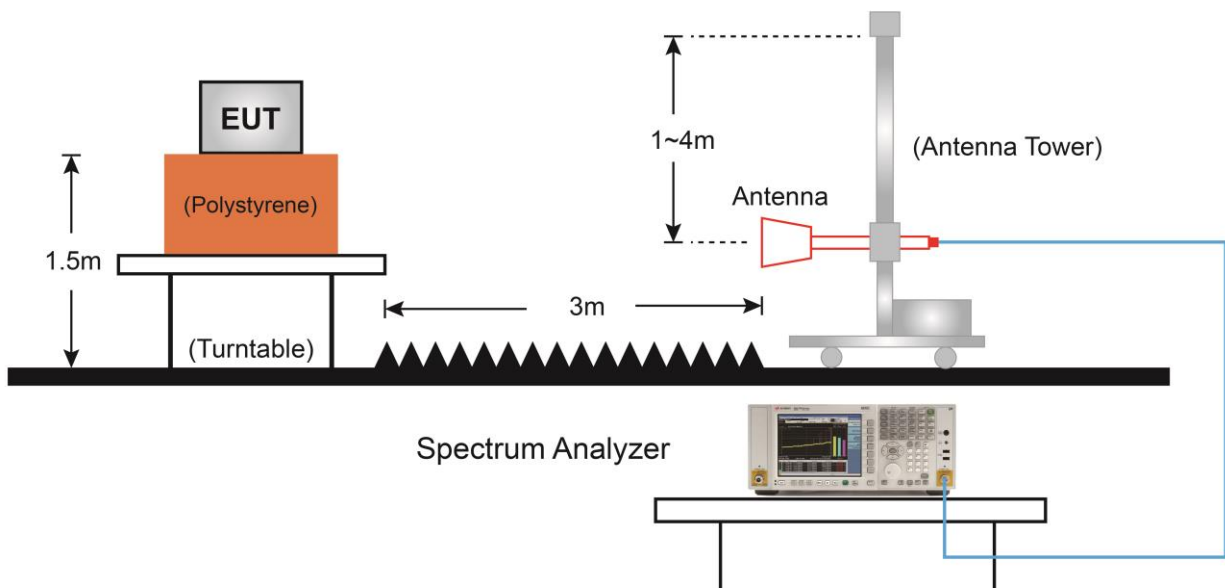



### 7.7.5. Test Result

EUT	Tri-band WIFI7 router	Date of Test	2024-09-27
Factor	DRH18-E	Temp. / Humidity	24°C /65%
Polarity	Horizontal	Site / Test Engineer	AC2 / Stanley
Test Mode	802.11b_TX_CH 1_ANT 0+1+2+3	Test Voltage	AC 120V/60Hz

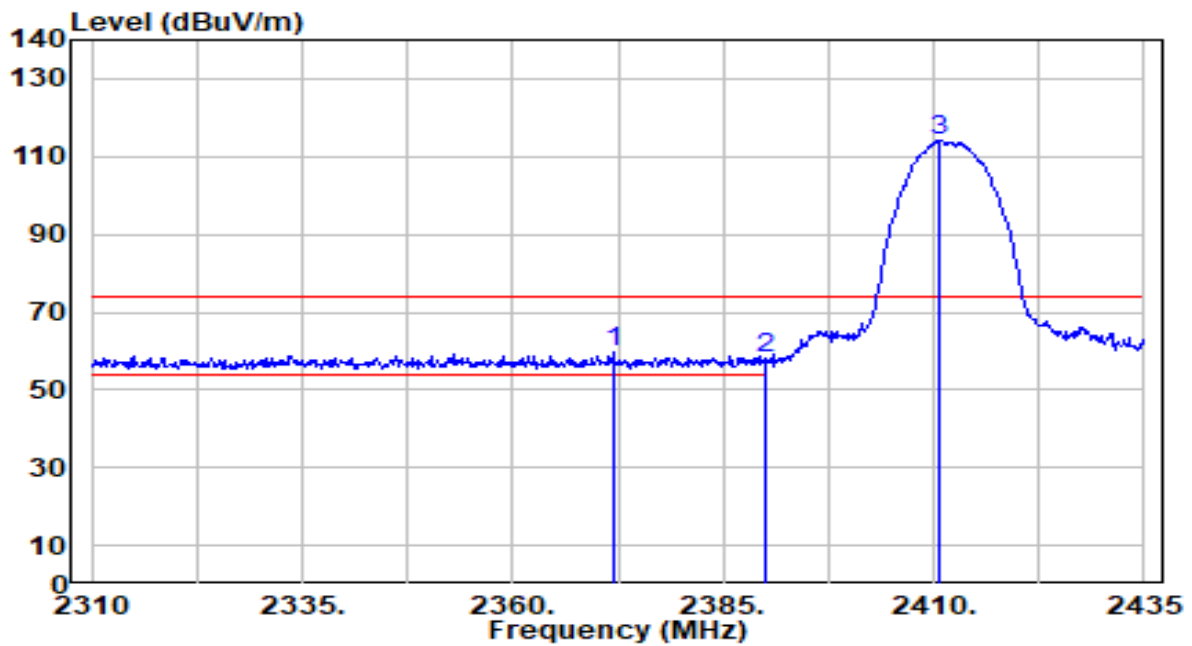

No	Frequency (MHz)	Reading (dBuV)	C.F (dB/m)	Measurement (dBuV/m)	Margin (dB)	Limit (dBuV/m)	Height (cm)	Angle (deg)	Remark (QP/PK/AV)
1	* 2372.000	29.32	30.50	59.82	-14.18	74.00	100	270	Peak
2	2390.000	27.34	30.55	57.89	-16.11	74.00	100	270	Peak
3	2410.750	83.53	30.61	114.13	N/A	N/A	100	270	Peak

Note:

1. " \*", means this data is the worst emission level.
2. C.F (Correction Factor) = Antenna Factor (dB/m) + Cable Loss (dB).
3. Measurement (dBuV/m) = Reading(dBuV) + C.F (Correction Factor).
4. The emission levels of other frequencies are very lower than the limit and not show in test report.

EUT	Tri-band WIFI7 router	Date of Test	2024-09-27
Factor	DRH18-E	Temp. / Humidity	24°C /65%
Polarity	Horizontal	Site / Test Engineer	AC2 / Stanley
Test Mode	802.11b_TX_CH 1_ANT 0+1+2+3	Test Voltage	AC 120V/60Hz

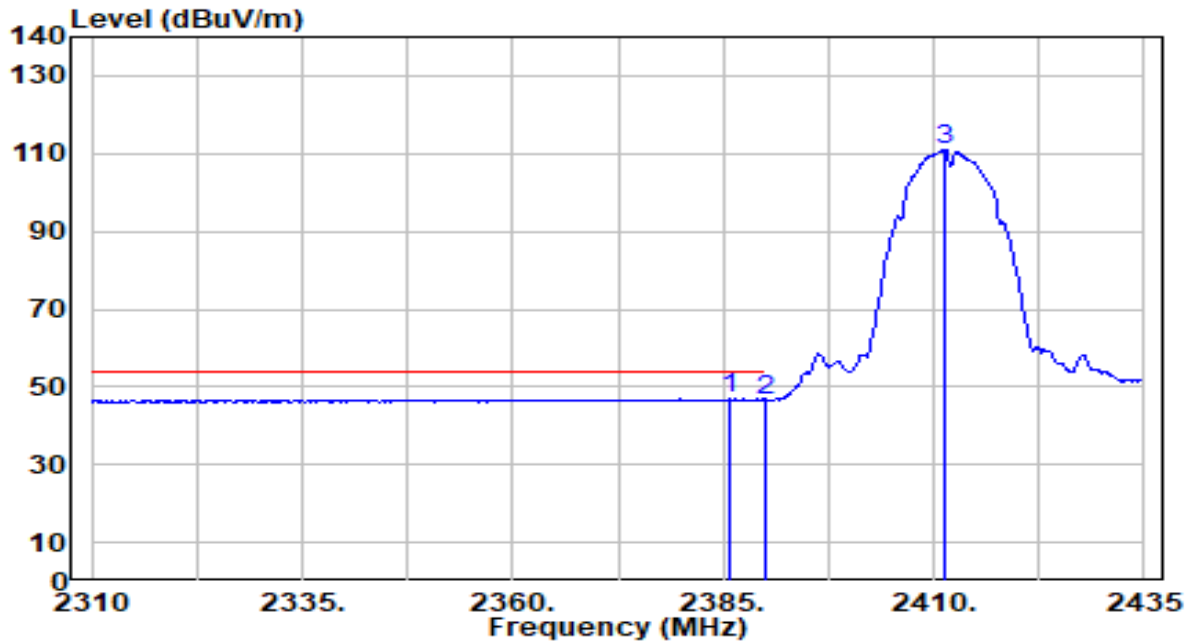

No	Frequency (MHz)	Reading (dBuV)	C.F (dB/m)	Measurement (dBuV/m)	Margin (dB)	Limit (dBuV/m)	Height (cm)	Angle (deg)	Remark (QP/PK/AV)	
1	*	2385.625	16.35	30.54	46.89	-7.11	54.00	100	270	Average
2		2390.000	16.17	30.55	46.72	-7.28	54.00	100	270	Average
3		2411.250	80.41	30.61	111.02	N/A	N/A	100	270	Average

Note:

1. " \*", means this data is the worst emission level.
2. C.F (Correction Factor) = Antenna Factor (dB/m) + Cable Loss (dB).
3. Measurement (dBuV/m) = Reading(dBuV) + C.F (Correction Factor).
4. The emission levels of other frequencies are very lower than the limit and not show in test report.

EUT	Tri-band WIFI7 router	Date of Test	2024-09-27
Factor	DRH18-E	Temp. / Humidity	24°C /65%
Polarity	Vertical	Site / Test Engineer	AC2 / Stanley
Test Mode	802.11b_TX_CH 1_ANT 0+1+2+3	Test Voltage	AC 120V/60Hz

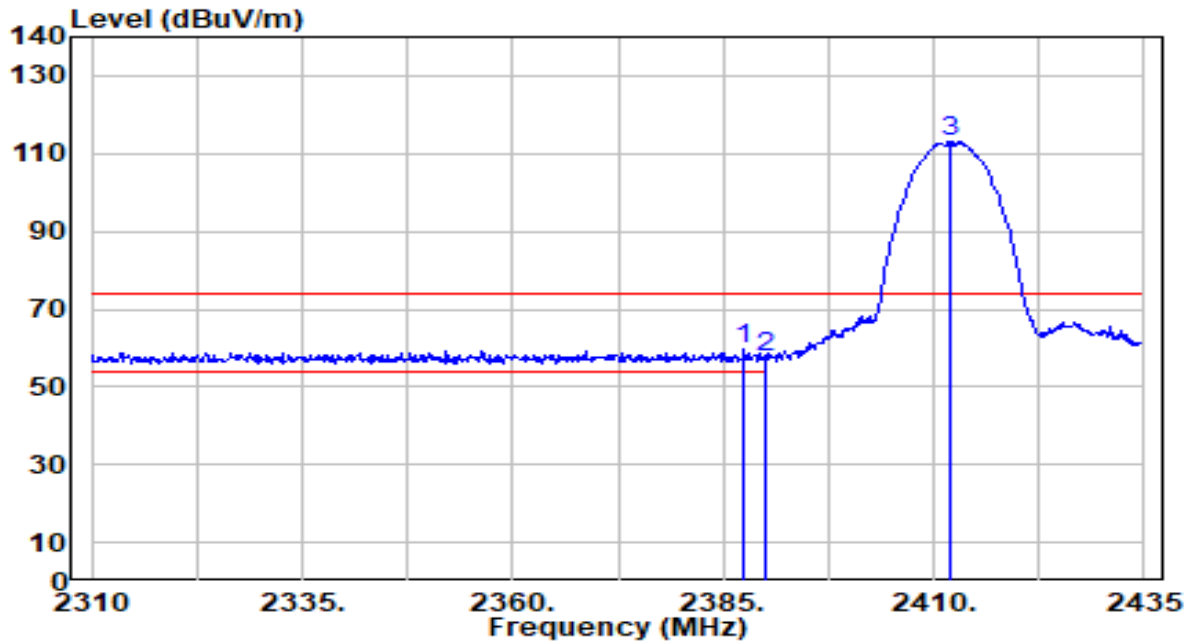

No	Frequency (MHz)	Reading (dBuV)	C.F (dB/m)	Measurement (dBuV/m)	Margin (dB)	Limit (dBuV/m)	Height (cm)	Angle (deg)	Remark (QP/PK/AV)	
1	*	2387.375	28.98	30.54	59.52	-14.48	74.00	100	34	Peak
2		2390.000	27.27	30.55	57.82	-16.18	74.00	100	34	Peak
3		2412.000	82.39	30.61	113.00	N/A	N/A	100	34	Peak

Note:

1. " \*", means this data is the worst emission level.
2. C.F (Correction Factor) = Antenna Factor (dB/m) + Cable Loss (dB).
3. Measurement (dBuV/m) = Reading(dBuV) + C.F (Correction Factor).
4. The emission levels of other frequencies are very lower than the limit and not show in test report.

EUT	Tri-band WIFI7 router	Date of Test	2024-09-27
Factor	DRH18-E	Temp. / Humidity	24°C /65%
Polarity	Vertical	Site / Test Engineer	AC2 / Stanley
Test Mode	802.11b_TX_CH 1_ANT 0+1+2+3	Test Voltage	AC 120V/60Hz

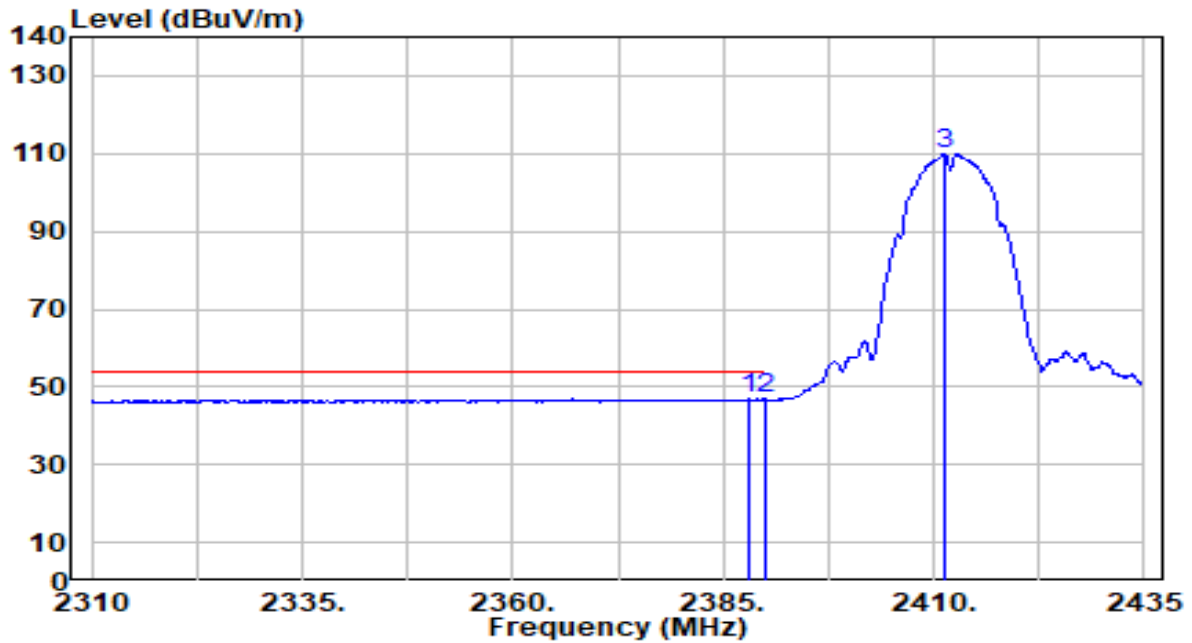

No	Frequency (MHz)	Reading (dBuV)	C.F (dB/m)	Measurement (dBuV/m)	Margin (dB)	Limit (dBuV/m)	Height (cm)	Angle (deg)	Remark (QP/PK/AV)
1	2388.000	16.33	30.54	46.87	-7.13	54.00	100	34	Average
2	* 2390.000	16.38	30.55	46.93	-7.07	54.00	100	34	Average
3	2411.250	79.21	30.61	109.81	N/A	N/A	100	34	Average

Note:

1. " \*", means this data is the worst emission level.
2. C.F (Correction Factor) = Antenna Factor (dB/m) + Cable Loss (dB).
3. Measurement (dBuV/m) = Reading(dBuV) + C.F (Correction Factor).
4. The emission levels of other frequencies are very lower than the limit and not show in test report.

EUT	Tri-band WIFI7 router	Date of Test	2024-09-24
Factor	DRH18-E	Temp. / Humidity	24°C /65%
Polarity	Horizontal	Site / Test Engineer	AC2 / Stanley
Test Mode	802.11g_TX_CH 11_ANT 0+1+2+3	Test Voltage	AC 120V/60Hz

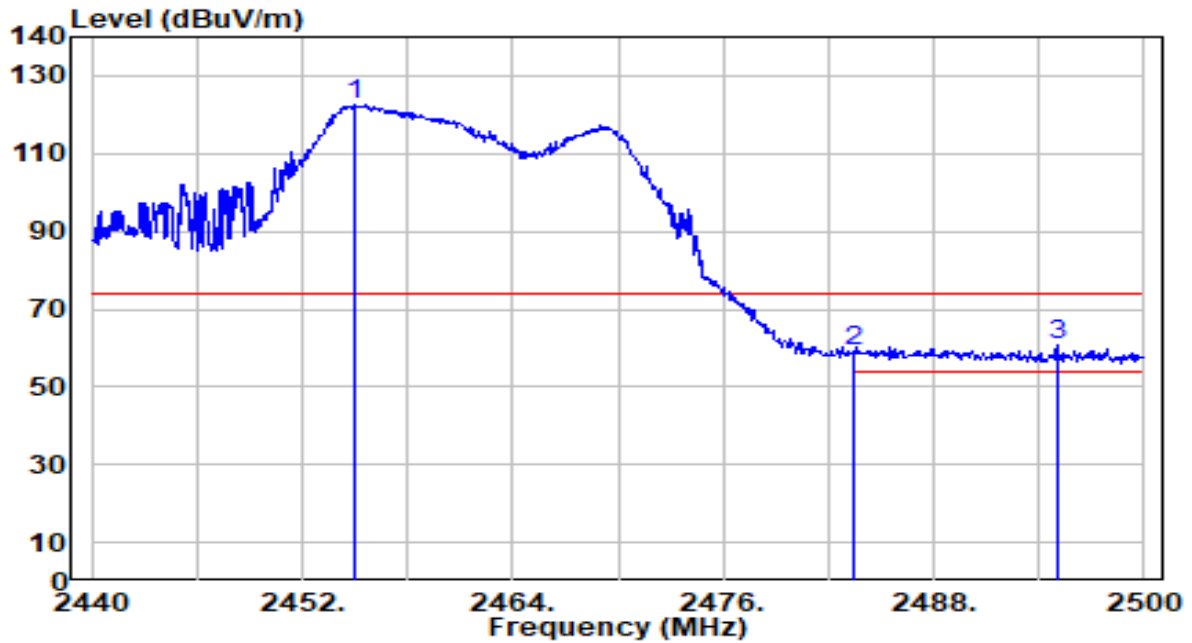

No	Frequency (MHz)	Reading (dBuV)	C.F (dB/m)	Measurement (dBuV/m)	Margin (dB)	Limit (dBuV/m)	Height (cm)	Angle (deg)	Remark (QP/PK/AV)
1	2454.940	91.68	30.73	122.42	N/A	N/A	100	274	Peak
2	2483.500	28.19	30.81	59.01	-14.99	74.00	100	274	Peak
3	* 2495.020	29.76	30.85	60.61	-13.39	74.00	100	274	Peak

Note:

1. " \*", means this data is the worst emission level.
2. C.F (Correction Factor) = Antenna Factor (dB/m) + Cable Loss (dB).
3. Measurement (dBuV/m) = Reading(dBuV) + C.F (Correction Factor).
4. The emission levels of other frequencies are very lower than the limit and not show in test report.

EUT	Tri-band WIFI7 router	Date of Test	2024-09-24
Factor	DRH18-E	Temp. / Humidity	24°C /65%
Polarity	Horizontal	Site / Test Engineer	AC2 / Stanley
Test Mode	802.11g_TX_CH 11_ANT 0+1+2+3	Test Voltage	AC 120V/60Hz

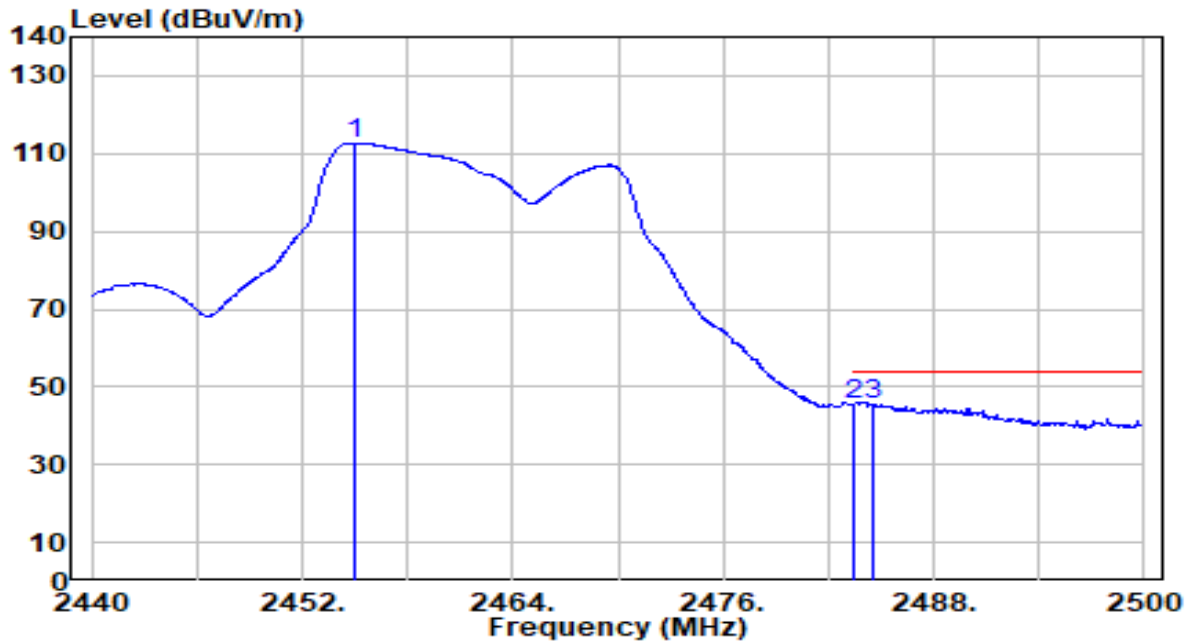

No	Frequency (MHz)	Reading (dBUV)	C.F (dB/m)	Measurement (dBUV/m)	Margin (dB)	Limit (dBUV/m)	Height (cm)	Angle (deg)	Remark (QP/PK/AV)
1	2455.060	81.99	30.73	112.72	N/A	N/A	100	274	Average
2	* 2483.500	14.79	30.81	45.60	-8.40	54.00	100	274	Average
3	2484.520	14.78	30.82	45.59	-8.41	54.00	100	274	Average

Note:

1. " \*", means this data is the worst emission level.
2. C.F (Correction Factor) = Antenna Factor (dB/m) + Cable Loss (dB).
3. Measurement (dBUV/m) = Reading(dBUV) + C.F (Correction Factor).
4. The emission levels of other frequencies are very lower than the limit and not show in test report.

EUT	Tri-band WIFI7 router	Date of Test	2024-09-24
Factor	DRH18-E	Temp. / Humidity	24°C /65%
Polarity	Vertical	Site / Test Engineer	AC2 / Stanley
Test Mode	802.11g_TX_CH 11_ANT 0+1+2+3	Test Voltage	AC 120V/60Hz

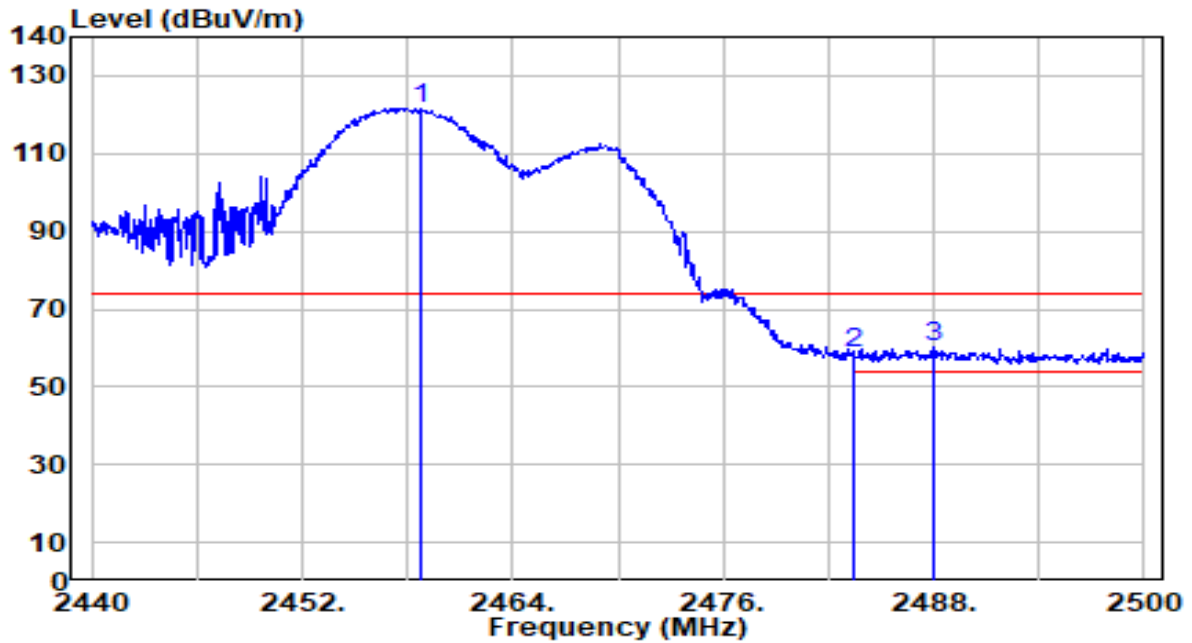

No	Frequency (MHz)	Reading (dBuV)	C.F (dB/m)	Measurement (dBuV/m)	Margin (dB)	Limit (dBuV/m)	Height (cm)	Angle (deg)	Remark (QP/PK/AV)
1	2458.780	90.93	30.74	121.68	N/A	N/A	373	335	Peak
2	2483.500	27.73	30.81	58.55	-15.45	74.00	373	335	Peak
3	* 2487.940	29.33	30.83	60.15	-13.85	74.00	373	335	Peak

Note:

1. " \*", means this data is the worst emission level.
2. C.F (Correction Factor) = Antenna Factor (dB/m) + Cable Loss (dB).
3. Measurement (dBuV/m) = Reading(dBuV) + C.F (Correction Factor).
4. The emission levels of other frequencies are very lower than the limit and not show in test report.

EUT	Tri-band WIFI7 router	Date of Test	2024-09-24
Factor	DRH18-E	Temp. / Humidity	24°C /65%
Polarity	Vertical	Site / Test Engineer	AC2 / Stanley
Test Mode	802.11g_TX_CH 11_ANT 0+1+2+3	Test Voltage	AC 120V/60Hz

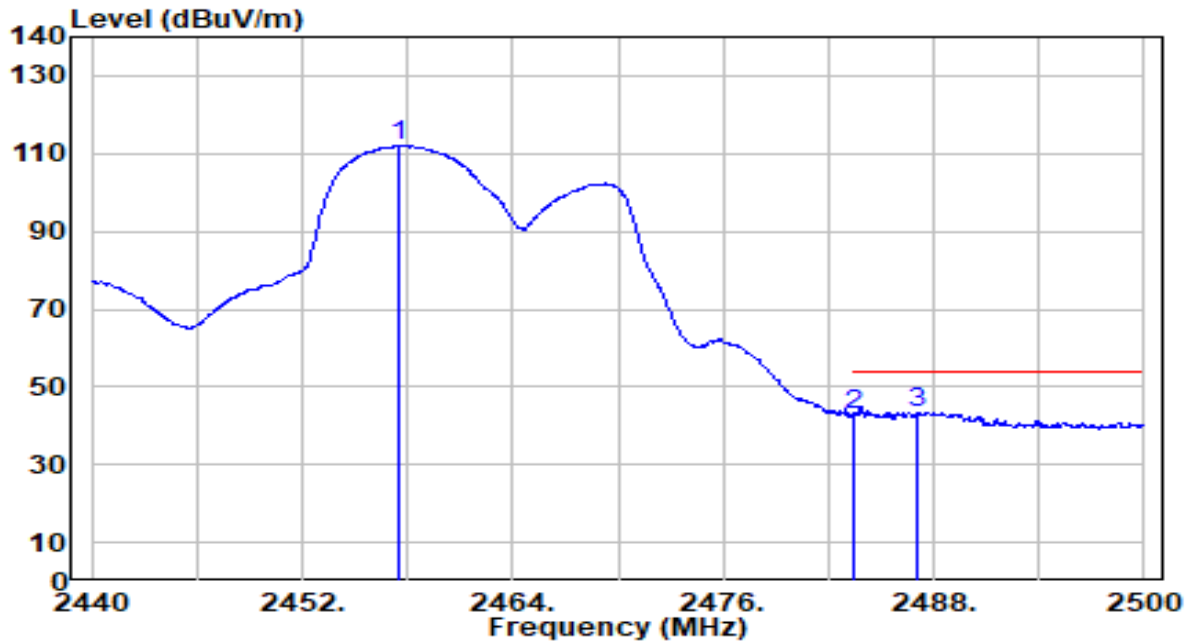

No	Frequency (MHz)	Reading (dBUV)	C.F (dB/m)	Measurement (dBUV/m)	Margin (dB)	Limit (dBUV/m)	Height (cm)	Angle (deg)	Remark (QP/PK/AV)
1	2457.460	81.23	30.74	111.96	N/A	N/A	373	335	Average
2	2483.500	12.10	30.81	42.91	-11.09	54.00	373	335	Average
3	* 2487.100	12.75	30.82	43.58	-10.42	54.00	373	335	Average

Note:

1. " \*", means this data is the worst emission level.
2. C.F (Correction Factor) = Antenna Factor (dB/m) + Cable Loss (dB).
3. Measurement (dBUV/m) = Reading(dBUV) + C.F (Correction Factor).
4. The emission levels of other frequencies are very lower than the limit and not show in test report.



EUT	Tri-band WIFI7 router	Date of Test	2024-09-27
Factor	DRH18-E	Temp. / Humidity	24°C /65%
Polarity	Horizontal	Site / Test Engineer	AC2 / Stanley
Test Mode	802.11n-20MHz_TX_CH 1_ANT 0+1+2+3	Test Voltage	AC 120V/60Hz

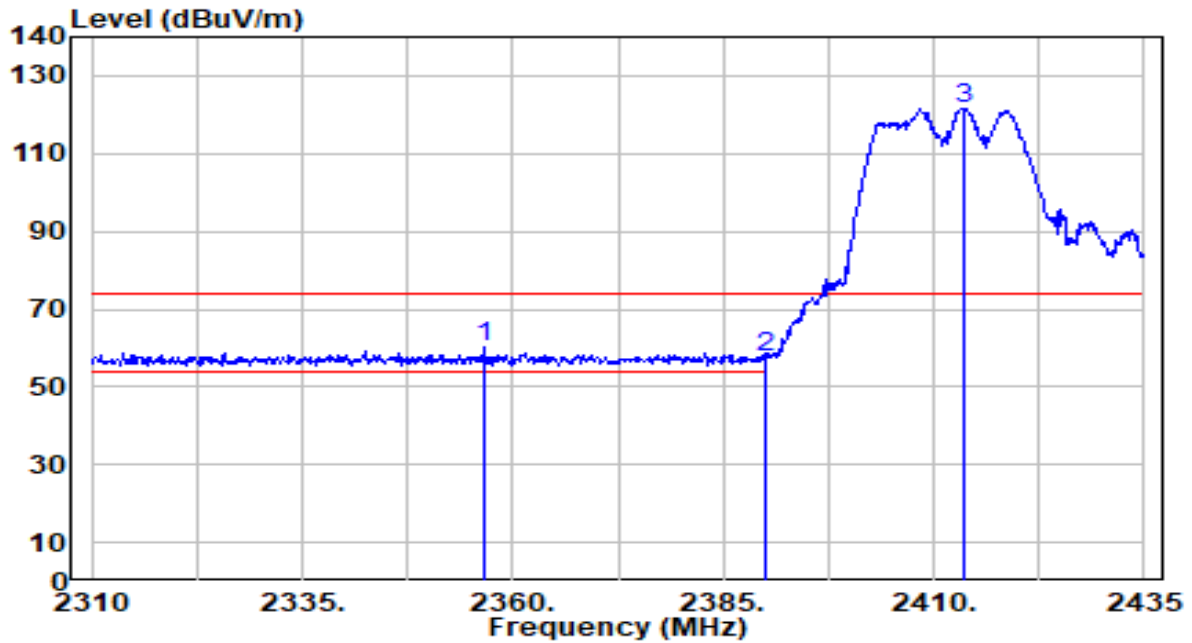

No	Frequency (MHz)	Reading (dBuV)	C.F (dB/m)	Measurement (dBuV/m)	Margin (dB)	Limit (dBuV/m)	Height (cm)	Angle (deg)	Remark (QP/PK/AV)	
1	*	2356.500	29.76	30.45	60.21	-13.79	74.00	100	270	Peak
2		2390.000	26.78	30.55	57.33	-16.67	74.00	100	270	Peak
3		2413.625	90.97	30.61	121.59	N/A	N/A	100	270	Peak

Note:

1. " \*", means this data is the worst emission level.
2. C.F (Correction Factor) = Antenna Factor (dB/m) + Cable Loss (dB).
3. Measurement (dBuV/m) = Reading(dBuV) + C.F (Correction Factor).
4. The emission levels of other frequencies are very lower than the limit and not show in test report.

EUT	Tri-band WIFI7 router	Date of Test	2024-09-27
Factor	DRH18-E	Temp. / Humidity	24°C /65%
Polarity	Horizontal	Site / Test Engineer	AC2 / Stanley
Test Mode	802.11n-20MHz_TX_CH 1_ANT 0+1+2+3	Test Voltage	AC 120V/60Hz

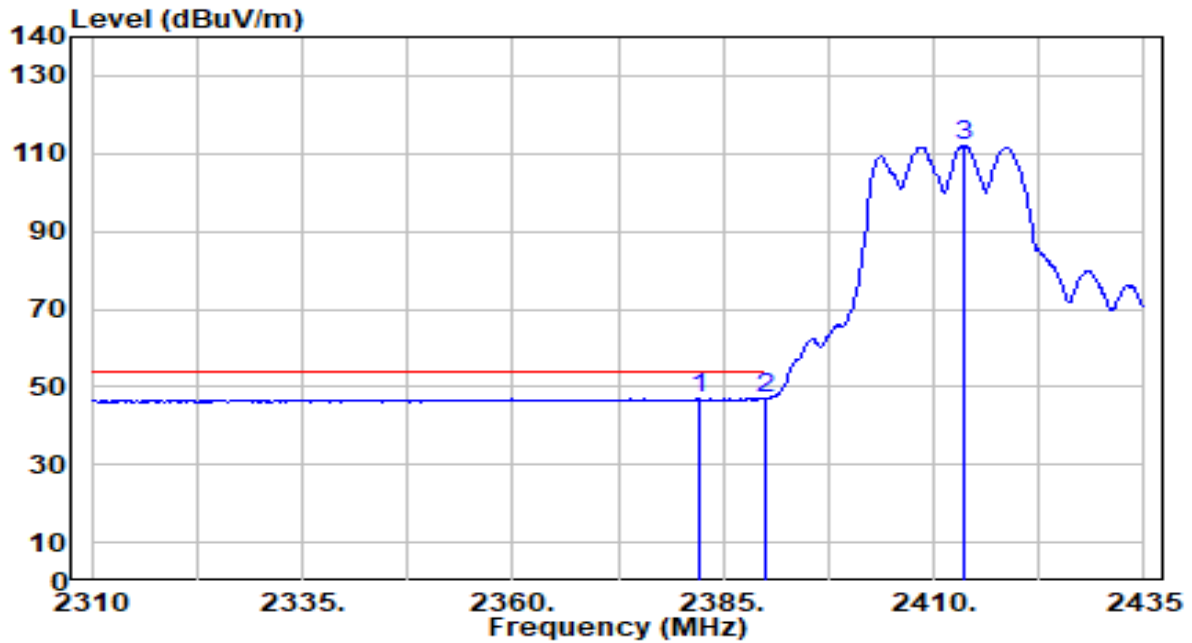

No	Frequency (MHz)	Reading (dBuV)	C.F (dB/m)	Measurement (dBuV/m)	Margin (dB)	Limit (dBuV/m)	Height (cm)	Angle (deg)	Remark (QP/PK/AV)	
1	*	2382.125	16.52	30.53	47.05	-6.95	54.00	100	270	Average
2		2390.000	16.44	30.55	46.99	-7.01	54.00	100	270	Average
3		2413.500	81.40	30.61	112.02	N/A	N/A	100	270	Average

Note:

1. " \*", means this data is the worst emission level.
2. C.F (Correction Factor) = Antenna Factor (dB/m) + Cable Loss (dB).
3. Measurement (dBuV/m) = Reading(dBuV) + C.F (Correction Factor).
4. The emission levels of other frequencies are very lower than the limit and not show in test report.

EUT	Tri-band WIFI7 router	Date of Test	2024-09-27
Factor	DRH18-E	Temp. / Humidity	24°C /65%
Polarity	Vertical	Site / Test Engineer	AC2 / Stanley
Test Mode	802.11n-20MHz_TX_CH 1_ANT 0+1+2+3	Test Voltage	AC 120V/60Hz

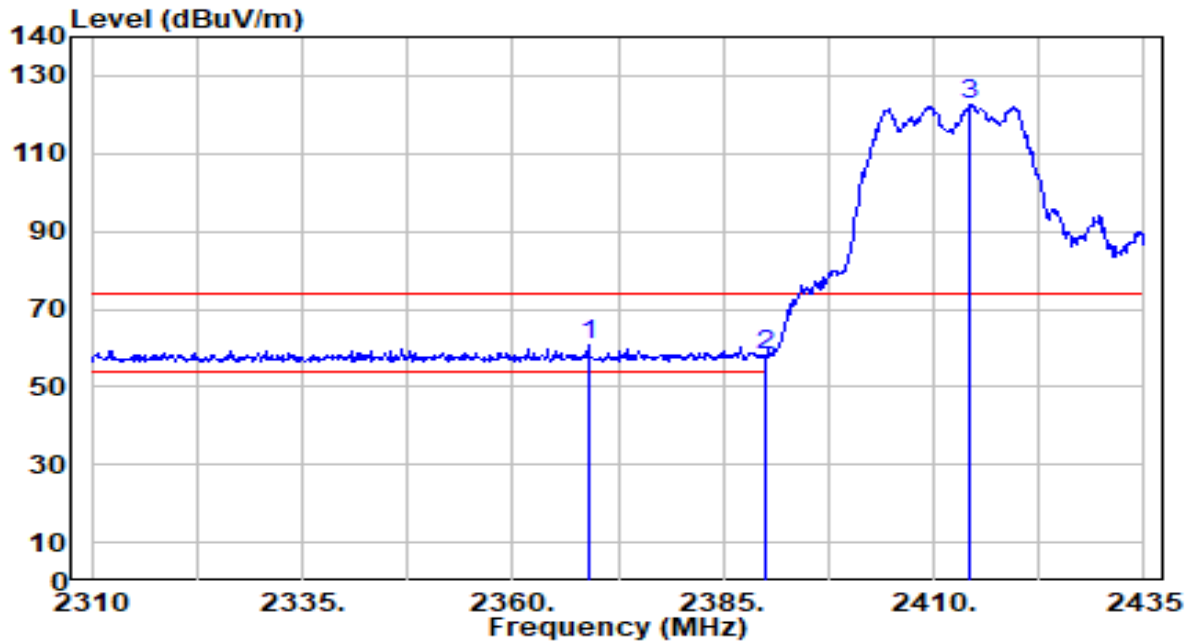

No	Frequency (MHz)	Reading (dBuV)	C.F (dB/m)	Measurement (dBuV/m)	Margin (dB)	Limit (dBuV/m)	Height (cm)	Angle (deg)	Remark (QP/PK/AV)	
1	*	2369.000	30.52	30.49	61.00	-13.00	74.00	100	34	Peak
2		2390.000	27.45	30.55	58.00	-16.00	74.00	100	34	Peak
3		2414.375	92.08	30.62	122.69	N/A	N/A	100	34	Peak

Note:

1. " \*", means this data is the worst emission level.
2. C.F (Correction Factor) = Antenna Factor (dB/m) + Cable Loss (dB).
3. Measurement (dBuV/m) = Reading(dBuV) + C.F (Correction Factor).
4. The emission levels of other frequencies are very lower than the limit and not show in test report.

EUT	Tri-band WIFI7 router	Date of Test	2024-09-27
Factor	DRH18-E	Temp. / Humidity	24°C /65%
Polarity	Vertical	Site / Test Engineer	AC2 / Stanley
Test Mode	802.11n-20MHz_TX_CH 1_ANT 0+1+2+3	Test Voltage	AC 120V/60Hz

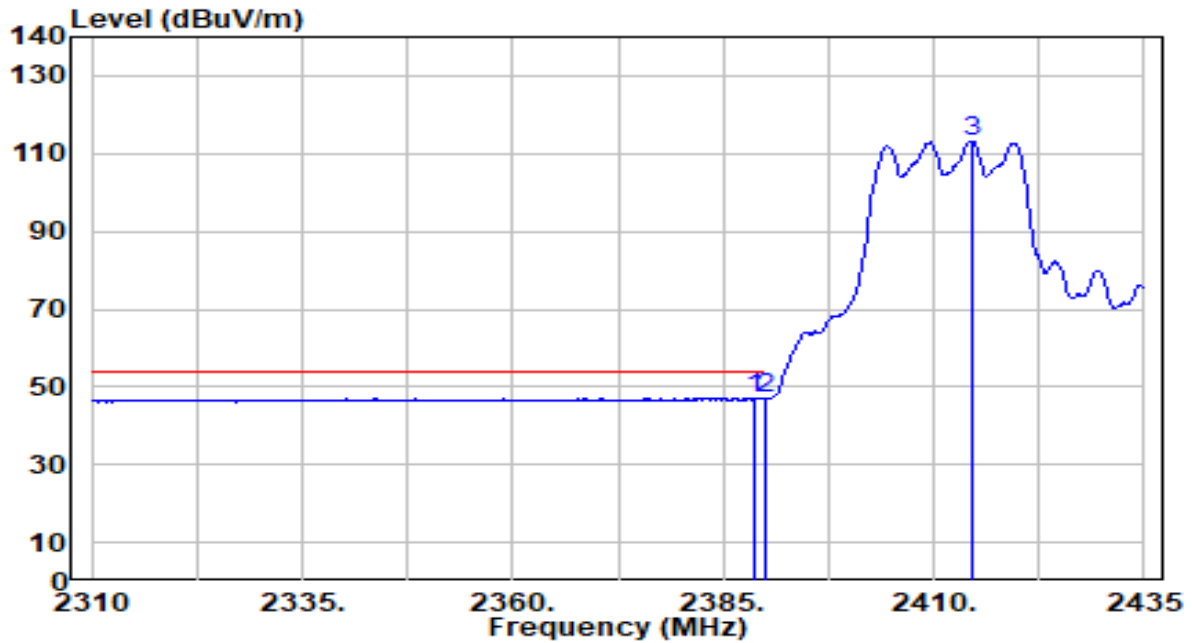

No	Frequency (MHz)	Reading (dBuV)	C.F (dB/m)	Measurement (dBuV/m)	Margin (dB)	Limit (dBuV/m)	Height (cm)	Angle (deg)	Remark (QP/PK/AV)	
1	*	2388.750	16.55	30.54	47.09	-6.91	54.00	100	34	Average
2		2390.000	16.48	30.55	47.03	-6.97	54.00	100	34	Average
3		2414.500	82.60	30.62	113.21	N/A	N/A	100	34	Average

Note:

1. " \*", means this data is the worst emission level.
2. C.F (Correction Factor) = Antenna Factor (dB/m) + Cable Loss (dB).
3. Measurement (dBuV/m) = Reading(dBuV) + C.F (Correction Factor).
4. The emission levels of other frequencies are very lower than the limit and not show in test report.

EUT	Tri-band WIFI7 router	Date of Test	2024-09-24
Factor	DRH18-E	Temp. / Humidity	24°C /65%
Polarity	Horizontal	Site / Test Engineer	AC2 / Stanley
Test Mode	802.11ax-20MHz_TX_CH 1_ANT 0+1+2+3	Test Voltage	AC 120V/60Hz

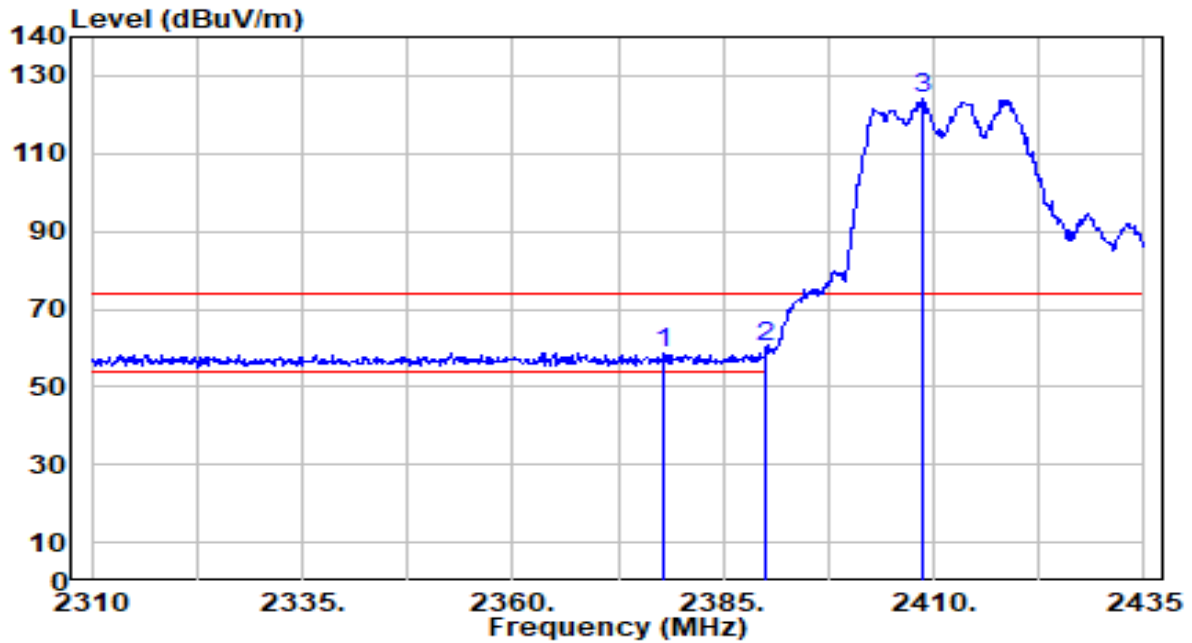

No	Frequency (MHz)	Reading (dBuV)	C.F (dB/m)	Measurement (dBuV/m)	Margin (dB)	Limit (dBuV/m)	Height (cm)	Angle (deg)	Remark (QP/PK/AV)
1	2377.875	28.20	30.51	58.72	-15.28	74.00	100	270	Peak
2	* 2390.000	29.76	30.55	60.31	-13.69	74.00	100	270	Peak
3	2408.750	93.64	30.60	124.24	N/A	N/A	100	270	Peak

Note:

1. " \*", means this data is the worst emission level.
2. C.F (Correction Factor) = Antenna Factor (dB/m) + Cable Loss (dB).
3. Measurement (dBuV/m) = Reading(dBuV) + C.F (Correction Factor).
4. The emission levels of other frequencies are very lower than the limit and not show in test report.

EUT	Tri-band WIFI7 router	Date of Test	2024-09-24
Factor	DRH18-E	Temp. / Humidity	24°C /65%
Polarity	Horizontal	Site / Test Engineer	AC2 / Stanley
Test Mode	802.11ax-20MHz_TX_CH 1_ANT 0+1+2+3	Test Voltage	AC 120V/60Hz

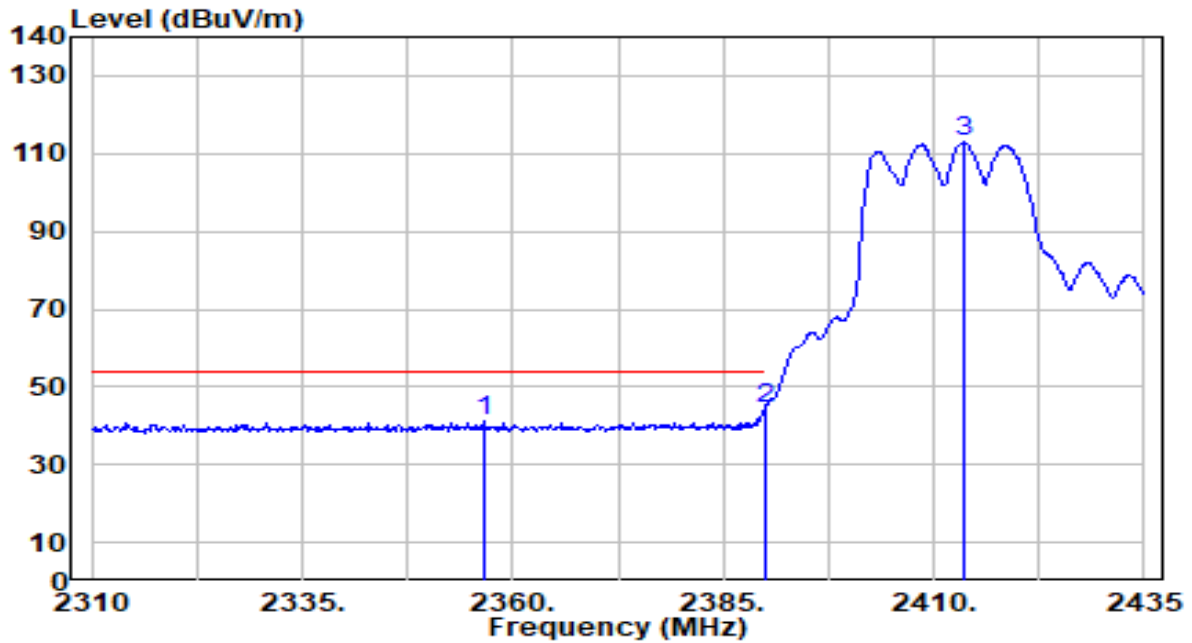

No	Frequency (MHz)	Reading (dBuV)	C.F (dB/m)	Measurement (dBuV/m)	Margin (dB)	Limit (dBuV/m)	Height (cm)	Angle (deg)	Remark (QP/PK/AV)
1	2356.500	10.54	30.45	41.00	-13.00	54.00	100	270	Average
2	* 2390.000	13.93	30.55	44.48	-9.52	54.00	100	270	Average
3	2413.625	82.43	30.61	113.04	N/A	N/A	100	270	Average

Note:

1. " \*", means this data is the worst emission level.
2. C.F (Correction Factor) = Antenna Factor (dB/m) + Cable Loss (dB).
3. Measurement (dBuV/m) = Reading(dBuV) + C.F (Correction Factor).
4. The emission levels of other frequencies are very lower than the limit and not show in test report.

EUT	Tri-band WIFI7 router	Date of Test	2024-09-24
Factor	DRH18-E	Temp. / Humidity	24°C /65%
Polarity	Vertical	Site / Test Engineer	AC2 / Stanley
Test Mode	802.11ax-20MHz_TX_CH 1_ANT 0+1+2+3	Test Voltage	AC 120V/60Hz

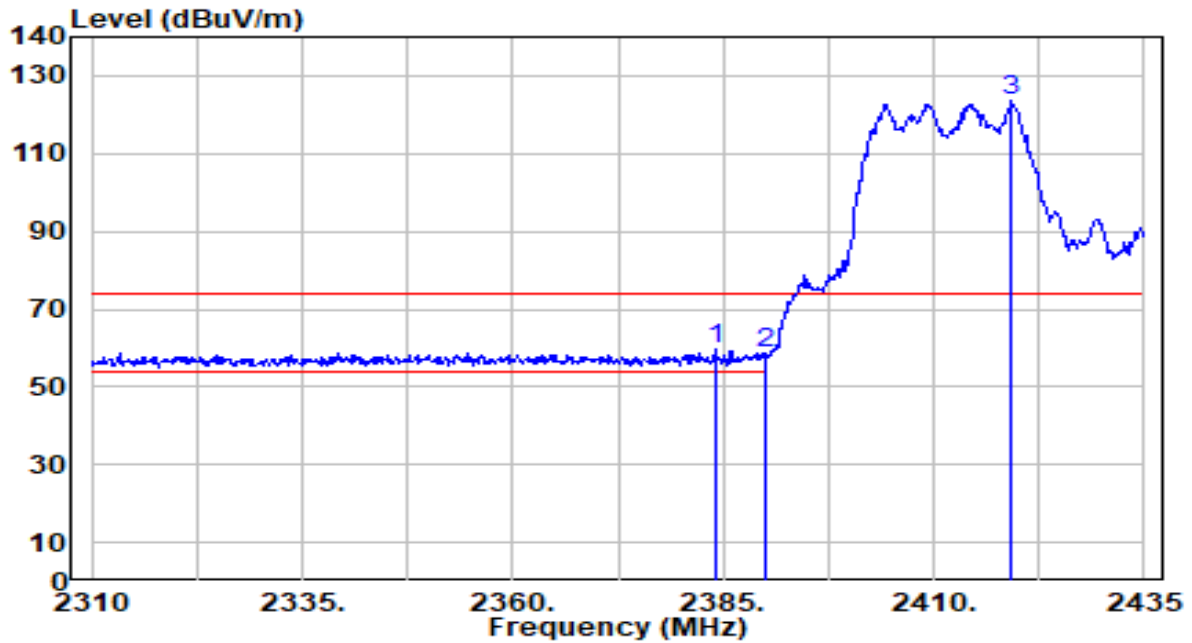

No	Frequency (MHz)	Reading (dBuV)	C.F (dB/m)	Measurement (dBuV/m)	Margin (dB)	Limit (dBuV/m)	Height (cm)	Angle (deg)	Remark (QP/PK/AV)	
1	*	2384.000	29.29	30.53	59.82	-14.18	74.00	100	34	Peak
2		2390.000	28.32	30.55	58.87	-15.13	74.00	100	34	Peak
3		2419.125	92.89	30.63	123.52	N/A	N/A	100	34	Peak

Note:

1. "\*" , means this data is the worst emission level.
2. C.F (Correction Factor) = Antenna Factor (dB/m) + Cable Loss (dB).
3. Measurement (dBuV/m) = Reading(dBuV) + C.F (Correction Factor).
4. The emission levels of other frequencies are very lower than the limit and not show in test report.

EUT	Tri-band WIFI7 router	Date of Test	2024-09-24
Factor	DRH18-E	Temp. / Humidity	24°C /65%
Polarity	Vertical	Site / Test Engineer	AC2 / Stanley
Test Mode	802.11ax-20MHz_TX_CH 1_ANT 0+1+2+3	Test Voltage	AC 120V/60Hz

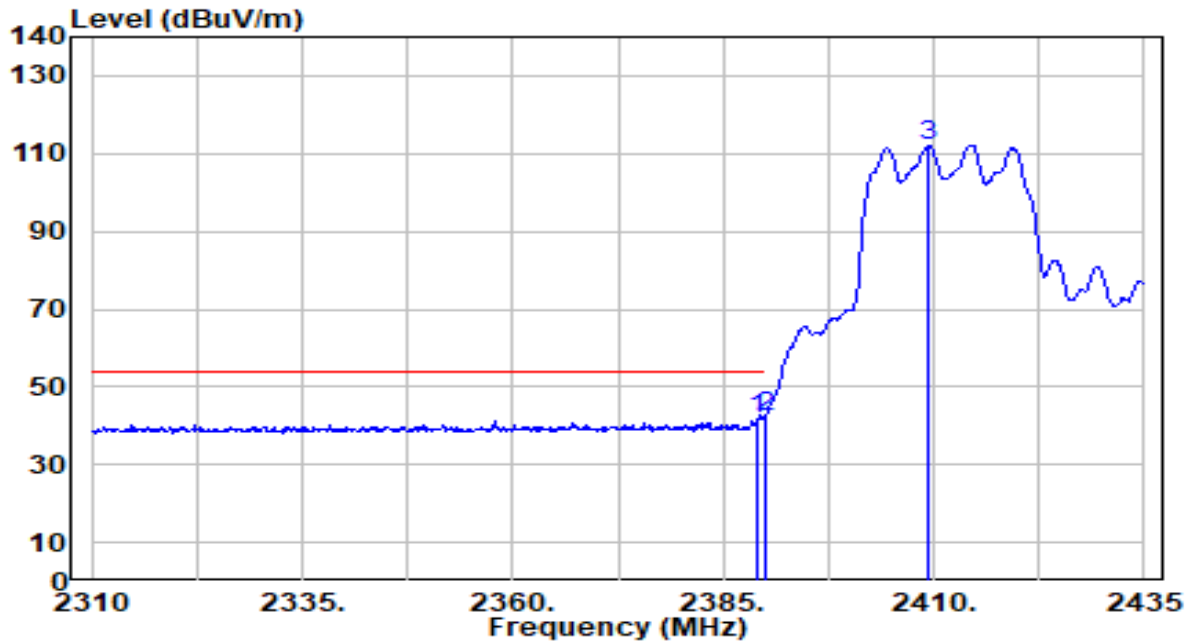

No	Frequency (MHz)	Reading (dBuV)	C.F (dB/m)	Measurement (dBuV/m)	Margin (dB)	Limit (dBuV/m)	Height (cm)	Angle (deg)	Remark (QP/PK/AV)
1	2389.000	11.12	30.54	41.67	-12.33	54.00	100	34	Average
2	* 2390.000	11.64	30.55	42.19	-11.81	54.00	100	34	Average
3	2409.375	81.57	30.60	112.17	N/A	N/A	100	34	Average

Note:

1. " \*", means this data is the worst emission level.
2. C.F (Correction Factor) = Antenna Factor (dB/m) + Cable Loss (dB).
3. Measurement (dBuV/m) = Reading(dBuV) + C.F (Correction Factor).
4. The emission levels of other frequencies are very lower than the limit and not show in test report.



EUT	Tri-band WIFI7 router	Date of Test	2024-09-27
Factor	DRH18-E	Temp. / Humidity	24°C /65%
Polarity	Horizontal	Site / Test Engineer	AC2 / Stanley
Test Mode	802.11be-20MHz_TX_CH 1_ANT 0+1+2+3	Test Voltage	AC 120V/60Hz

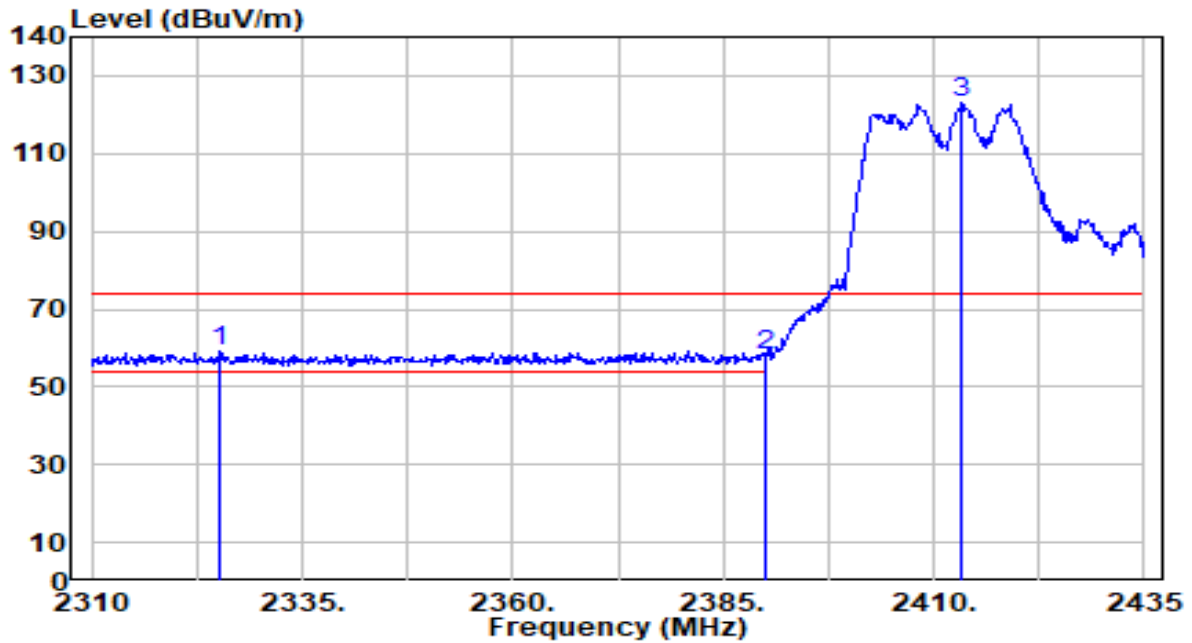

No	Frequency (MHz)	Reading (dBuV)	C.F (dB/m)	Measurement (dBuV/m)	Margin (dB)	Limit (dBuV/m)	Height (cm)	Angle (deg)	Remark (QP/PK/AV)	
1	*	2325.125	28.62	30.36	58.98	-15.02	74.00	100	270	Peak
2		2390.000	27.50	30.55	58.05	-15.95	74.00	100	270	Peak
3		2413.375	92.65	30.61	123.26	N/A	N/A	100	270	Peak

Note:

1. "\*" , means this data is the worst emission level.
2. C.F (Correction Factor) = Antenna Factor (dB/m) + Cable Loss (dB).
3. Measurement (dBuV/m) = Reading(dBuV) + C.F (Correction Factor).
4. The emission levels of other frequencies are very lower than the limit and not show in test report.

EUT	Tri-band WIFI7 router	Date of Test	2024-09-27
Factor	DRH18-E	Temp. / Humidity	24°C /65%
Polarity	Horizontal	Site / Test Engineer	AC2 / Stanley
Test Mode	802.11be-20MHz_TX_CH 1_ANT 0+1+2+3	Test Voltage	AC 120V/60Hz

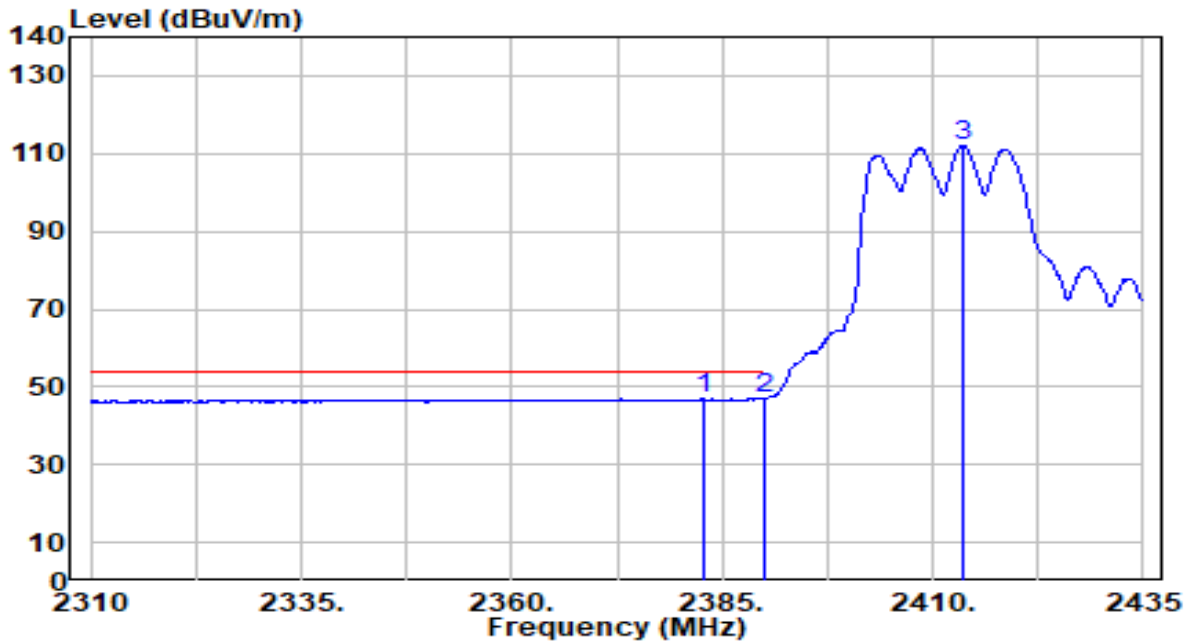

No	Frequency (MHz)	Reading (dBuV)	C.F (dB/m)	Measurement (dBuV/m)	Margin (dB)	Limit (dBuV/m)	Height (cm)	Angle (deg)	Remark (QP/PK/AV)
1	2382.750	16.39	30.53	46.92	-7.08	54.00	100	270	Average
2	* 2390.000	16.47	30.55	47.02	-6.98	54.00	100	270	Average
3	2413.625	81.38	30.61	112.00	N/A	N/A	100	270	Average

Note:

1. " \*", means this data is the worst emission level.
2. C.F (Correction Factor) = Antenna Factor (dB/m) + Cable Loss (dB).
3. Measurement (dBuV/m) = Reading(dBuV) + C.F (Correction Factor).
4. The emission levels of other frequencies are very lower than the limit and not show in test report.

EUT	Tri-band WIFI7 router	Date of Test	2024-09-27
Factor	DRH18-E	Temp. / Humidity	24°C /65%
Polarity	Vertical	Site / Test Engineer	AC2 / Stanley
Test Mode	802.11be-20MHz_TX_CH 1_ANT 0+1+2+3	Test Voltage	AC 120V/60Hz

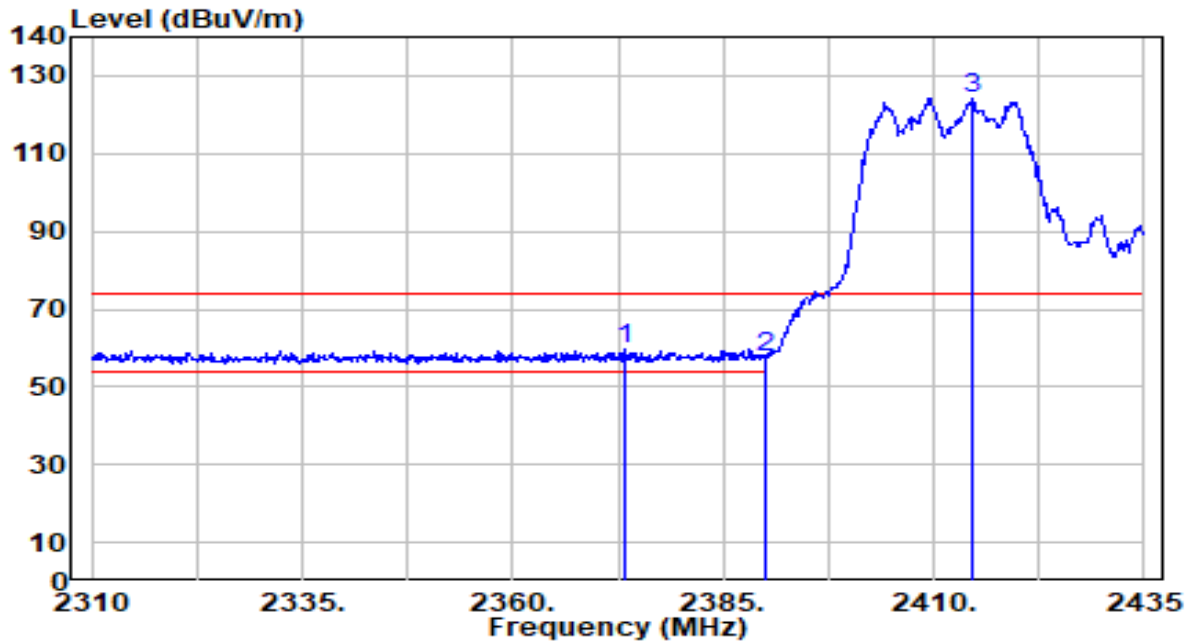

No	Frequency (MHz)	Reading (dBuV)	C.F (dB/m)	Measurement (dBuV/m)	Margin (dB)	Limit (dBuV/m)	Height (cm)	Angle (deg)	Remark (QP/PK/AV)	
1	*	2373.375	29.22	30.50	59.72	-14.28	74.00	100	34	Peak
2		2390.000	26.87	30.55	57.42	-16.58	74.00	100	34	Peak
3		2414.625	93.78	30.62	124.40	N/A	N/A	100	34	Peak

Note:

1. " \*", means this data is the worst emission level.
2. C.F (Correction Factor) = Antenna Factor (dB/m) + Cable Loss (dB).
3. Measurement (dBuV/m) = Reading(dBuV) + C.F (Correction Factor).
4. The emission levels of other frequencies are very lower than the limit and not show in test report.

EUT	Tri-band WIFI7 router	Date of Test	2024-09-27
Factor	DRH18-E	Temp. / Humidity	24°C /65%
Polarity	Vertical	Site / Test Engineer	AC2 / Stanley
Test Mode	802.11be-20MHz_TX_CH 1_ANT 0+1+2+3	Test Voltage	AC 120V/60Hz

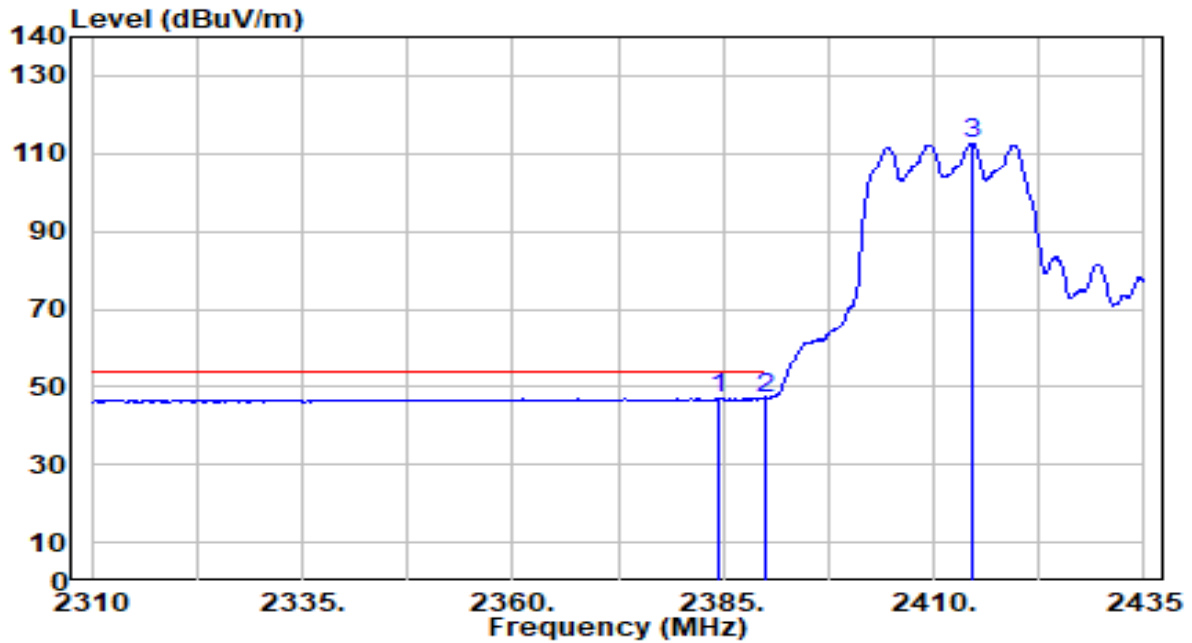

No	Frequency (MHz)	Reading (dBuV)	C.F (dB/m)	Measurement (dBuV/m)	Margin (dB)	Limit (dBuV/m)	Height (cm)	Angle (deg)	Remark (QP/PK/AV)
1	2384.500	16.53	30.53	47.06	-6.94	54.00	100	34	Average
2	* 2390.000	16.53	30.55	47.08	-6.92	54.00	100	34	Average
3	2414.500	82.08	30.62	112.70	N/A	N/A	100	34	Average

Note:

1. " \*", means this data is the worst emission level.
2. C.F (Correction Factor) = Antenna Factor (dB/m) + Cable Loss (dB).
3. Measurement (dBuV/m) = Reading(dBuV) + C.F (Correction Factor).
4. The emission levels of other frequencies are very lower than the limit and not show in test report.

## 7.8. AC Conducted Emissions Measurement

### 7.8.1. Test Limit

FCC Part 15 Subpart C Paragraph 15.207 Limits		
Frequency (MHz)	QP (dBuV)	AV (dBuV)
0.15 - 0.50	66 - 56	56 - 46
0.50 - 5.0	56	46
5.0 - 30	60	50

Note 1: The lower limit shall apply at the transition frequencies.

Note 2: The limit decreases linearly with the logarithm of the frequency in the range 0.15MHz to 0.5MHz.

### 7.8.2. Test Setup

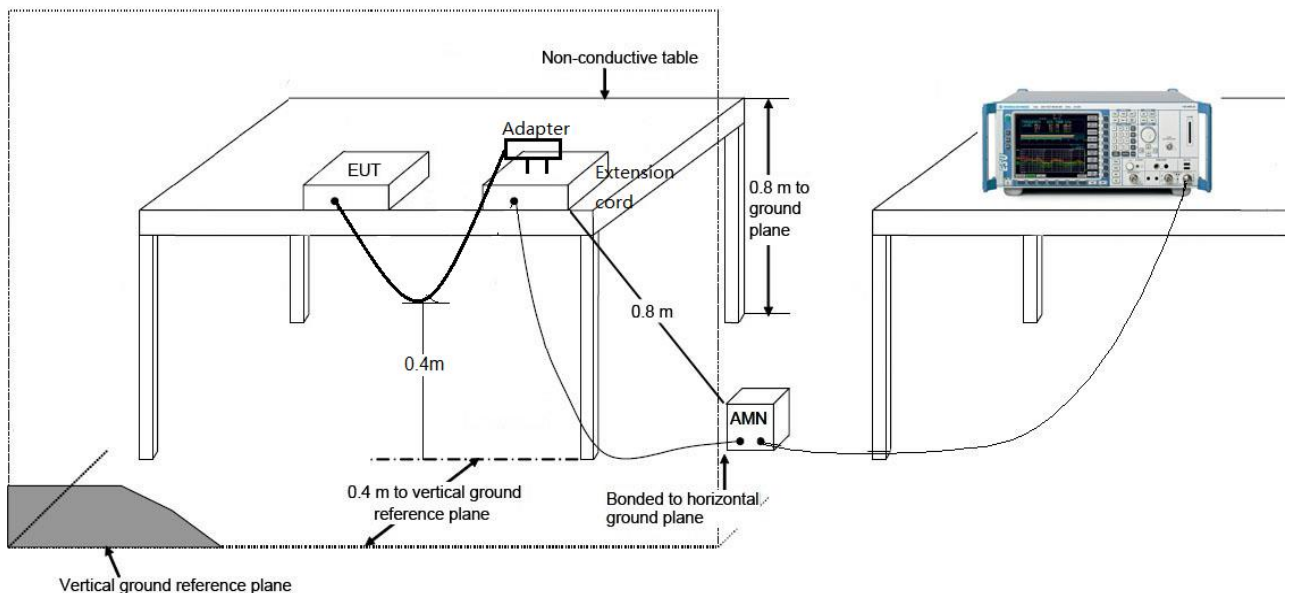

### 7.8.3. Test Result

Note: Refer to the original report is 2406RSU023-U1.

## **8. CONCLUSION**

The data collected relate only the item(s) tested and show that the device is compliance with Part 15C of the FCC Rules.

## **Appendix A : Test Setup Photograph**

Refer to “2409TW0115-UT” file.

## **Appendix B : External Photograph**

Refer to “2409TW0115-UE” file.

## **Appendix C : Internal Photograph**

Refer to “2409TW0115-UI” file.

————— The End —————