

FCC Test Report (DFS Band)

Report No.: RF190415E04A-1

FCC ID: VW3FAST3686V2H

Test Model: F@ST 3686 V2.2 HP

Received Date: Apr. 15, 2019

Test Date: Sep. 11 to 12, 2019

Issued Date: Oct. 02, 2019

Applicant: SAGEMCOM Broadband SAS

Address: 250 Route de l'Empereur - 92848 RUEIL MALMAISON CEDEX- FRANCE

Issued By: Bureau Veritas Consumer Products Services (H.K.) Ltd., Taoyuan Branch
Hsin Chu Laboratory

Lab Address: E-2, No.1, Li Hsin 1st Road, Hsinchu Science Park, Hsinchu City 300,
Taiwan

Test Location : E-2, No.1, Li Hsin 1st Road, Hsinchu Science Park, Hsinchu City 300,
Taiwan

**FCC Registration /
Designation Number:** 723255 / TW2022



This report is for your exclusive use. Any copying or replication of this report to or for any other person or entity, or use of our name or trademark, is permitted only with our prior written permission. This report sets forth our findings solely with respect to the test samples identified herein. The results set forth in this report are not indicative or representative of the quality or characteristics of the lot from which a test sample was taken or any similar or identical product unless specifically and expressly noted. Our report includes all of the tests requested by you and the results thereof based upon the information that you provided to us. You have 60 days from date of issuance of this report to notify us of any material error or omission caused by our negligence, provided, however, that such notice shall be in writing and shall specifically address the issue you wish to raise. A failure to raise such issue within the prescribed time shall constitute your unqualified acceptance of the completeness of this report, the tests conducted and the correctness of the report contents. Unless specific mention, the uncertainty of measurement has been explicitly taken into account to declare the compliance or non-compliance to the specification. The report must not be used by the client to claim product certification, approval, or endorsement by TAF or any government agencies.

Table of Contents

Release Control Record	4
1 Certificate of Conformity	5
2 Summary of Test Results	6
2.1 Measurement Uncertainty	6
2.2 Modification Record	6
3 General Information	7
3.1 General Description of EUT (DFS Band)	7
3.2 Description of Test Modes	9
3.2.1 Test Mode Applicability and Tested Channel Detail	10
3.3 Duty Cycle of Test Signal	12
3.4 Description of Support Units	13
3.4.1 Configuration of System under Test	14
3.5 General Description of Applied Standard	15
4 Test Types and Results	16
4.1 Radiated Emission and Bandedge Measurement	16
4.1.1 Limits of Radiated Emission and Bandedge Measurement	16
4.1.2 Test Instruments	17
4.1.3 Test Procedure	19
4.1.4 Deviation from Test Standard	19
4.1.5 Test Setup	20
4.1.6 EUT Operating Condition	21
4.1.7 Test Results	22
4.2 Conducted Emission Measurement	72
4.2.1 Limits of Conducted Emission Measurement	72
4.2.2 Test Instruments	72
4.2.3 Test Procedure	73
4.2.4 Deviation from Test Standard	73
4.2.5 Test Setup	73
4.2.6 EUT Operating Condition	73
4.2.7 Test Results	74
4.3 Transmit Power Measurement	76
4.3.1 Limits of Transmit Power Measurement	76
4.3.2 Test Setup	77
4.3.3 Test Instruments	77
4.3.4 Test Procedure	78
4.3.5 Deviation from Test Standard	78
4.3.6 EUT Operating Condition	78
4.3.7 Test Result	79
4.4 Occupied Bandwidth Measurement	92
4.4.1 Test Setup	92
4.4.2 Test Instruments	92
4.4.3 Test Procedure	92
4.4.4 Test Results	93
4.5 Peak Power Spectral Density Measurement	100
4.5.1 Limits of Peak Power Spectral Density Measurement	100
4.5.2 Test Setup	100
4.5.3 Test Instruments	100
4.5.4 Test Procedure	100
4.5.5 Deviation from Test Standard	101
4.5.6 EUT Operating Condition	101
4.5.7 Test Results	102
4.6 Frequency Stability Measurement	107
4.6.1 Limits of Frequency Stability Measurement	107

4.6.2	Test Setup.....	107
4.6.3	Test Instruments	107
4.6.4	Test Procedure	107
4.6.5	Deviation from Test Standard	107
4.6.6	EUT Operating Condition	107
4.6.7	Test Results	108
4.7	6dB Bandwidth Measurement	109
4.7.1	Limits of 6dB Bandwidth Measurement.....	109
4.7.2	Test Setup.....	109
4.7.3	Test Instruments	109
4.7.4	Test Procedure	109
4.7.5	Deviation from Test Standard	109
4.7.6	EUT Operating Condition	109
4.7.7	Test Results	110
5	Pictures of Test Arrangements.....	112
	Appendix – Information of the Testing Laboratories	113

Release Control Record

Issue No.	Description	Date Issued
RF190415E04A-1	Original release.	Oct. 02, 2019

1 Certificate of Conformity

Product: Euro-DOCSIS3.0

Brand: Sagemcom

Test Model: F@ST 3686 V2.2 HP

Sample Status: ENGINEERING SAMPLE

Applicant: SAGEMCOM Broadband SAS

Test Date: Sep. 11 to 12, 2019

Standard: 47 CFR FCC Part 15, Subpart E (Section 15.407)
ANSI C63.10: 2013

The above equipment has been tested by **Bureau Veritas Consumer Products Services (H.K.) Ltd., Taoyuan Branch**, and found compliance with the requirement of the above standards. The test record, data evaluation & Equipment Under Test (EUT) configurations represented herein are true and accurate accounts of the measurements of the sample's EMC characteristics under the conditions specified in this report.

Prepared by : Wendy Wu , **Date:** Oct. 02, 2019
Wendy Wu / Specialist

Approved by : May Chen , **Date:** Oct. 02, 2019
May Chen / Manager

2 Summary of Test Results

47 CFR FCC Part 15, Subpart E (Section 15.407)			
FCC Clause	Test Item	Result	Remarks
15.407(b)(6)	AC Power Conducted Emissions	PASS	Meet the requirement of limit. Minimum passing margin is -16.06dB at 0.16172MHz.
15.407(b) (1/2/3/4(i/ii)/6)	Radiated Emissions & Band Edge Measurement	PASS	Meet the requirement of limit. Minimum passing margin is -0.1dB at 5460.00MHz.
15.407(a)(1/2/3)	Max Average Transmit Power	PASS	Meet the requirement of limit.
---	Occupied Bandwidth Measurement	-	Reference only.
15.407(a)(1/2/3)	Peak Power Spectral Density	PASS	Meet the requirement of limit.
15.407(g)	Frequency Stability	PASS	Meet the requirement of limit.
15.203	Antenna Requirement	PASS	Antenna connector is i-pex(MHF) not a standard connector.

Note:

Determining compliance based on the results of the compliance measurement, not taking into account measurement instrumentation uncertainty.

2.1 Measurement Uncertainty

Where relevant, the following measurement uncertainty levels have been estimated for tests performed on the EUT as specified in CISPR 16-4-2:

Measurement	Frequency	Expanded Uncertainty (k=2) (\pm)
Conducted Emissions at mains ports	150kHz ~ 30MHz	1.8 dB
Radiated Emissions up to 1 GHz	9kHz ~ 30MHz	3.0 dB
	30MHz ~ 1GHz	4.8 dB
Radiated Emissions above 1 GHz	1GHz ~ 6GHz	5.0 dB
	6GHz ~ 18GHz	5.0 dB
	18GHz ~ 40GHz	5.3 dB

2.2 Modification Record

There were no modifications required for compliance.

3 General Information

3.1 General Description of EUT (DFS Band)

Product	Euro-DOCSIS3.0
Brand	Sagemcom
Test Model	F@ST 3686 V2.2 HP
Status of EUT	ENGINEERING SAMPLE
Power Supply Rating	12Vdc from power adapter
Modulation Type	64QAM, 16QAM, QPSK, BPSK for OFDM 256QAM for OFDM in 11ac mode only
Modulation Technology	OFDM
Transfer Rate	802.11a: up to 54Mbps 802.11n: up to 450Mbps 802.11ac: up to 1300Mbps
Operating Frequency	5.26 ~ 5.32GHz, 5.50 ~ 5.72GHz
Number of Channel	802.11a, 802.11n (HT20), 802.11ac (VHT20): 16 802.11n (HT40), 802.11ac (VHT40): 8 802.11ac (VHT80): 4
Output Power	CDD Mode: 5.26GHz ~ 5.32GHz: 203.928mW 5.50 ~ 5.72GHz: 247.321mW Beamforming Mode: 5.26GHz ~ 5.32GHz: 102.205mW 5.50 ~ 5.72GHz: 102.221mW
Antenna Type	Refer to Note
Antenna Connector	Refer to Note
Accessory Device	Adapter x 1
Data Cable Supplied	RJ-45 Cable x 1 (Unshielded, 1.5 m)

Note:

- This report is prepared for FCC class II change. The difference compared with the Report No.: RF190415E04-1 as the following information:
 - ◆ Add DFS band <5.26~ 5.32GHz, 5.50 ~ 5.72GHz>.
- According to above condition, for DFS band, the all test items need to be performed. And all data were verified to meet the requirements.
- Simultaneously transmission condition.

Condition	Technology	
1	WLAN (2.4GHz)	WLAN (5GHz)

Note: The emission of the simultaneous operation has been evaluated and no non-compliance was found.

- The EUT power needs to be supplied from a power adapters, the information is as below table:

No.	Brand	Model No.	Spec.
1	SAGEMCOM	MSG-V2500AR120-030A0-US	Input: 100-120Vac, 1.0A max, 50/60Hz Output: 12V, 2.5A DC output cable: Unshielded 2 m
2	SAGEMCOM	NBS30E120250VU	Input: 100-120Vac, 0.9A, 60Hz Output: 12V, 2.5A DC output cable: Unshielded 2 m

Note:

- From the above conditions, the conducted emissions worse case was found in **Adapter No. 2**. Therefore only the test data of the mode was recorded in this report.
- From the above conditions, the radiated emissions worse case was found in **Adapter No. 1**. Therefore only the test data of the mode was recorded in this report.

5. The antennas provided to the EUT, please refer to the following table:

Ant. No.	Chain No.	Brand	Antenna Gain (dBi)	Frequency Range (MHz)	Antenna Type	Connector Type	Cable Length (mm)
1	Chain (0)	TSKY	3.13	2400~2500	PCB	i-pex(MHF)	56.5
			5.72	5150~5850			
2	Chain (1)	TSKY	3.57	5150~5850	PCB	i-pex(MHF)	250
3	Chain (2)	TSKY	3.54	2400~2500	PCB	i-pex(MHF)	40
			5.87	5150~5850			

Note: For 802.11b modulation the Max. gain was selected for the final test.

6. The EUT incorporates a MIMO function:

2.4GHz Band		
MODULATION MODE	TX & RX CONFIGURATION	
802.11b	1TX (Diversity)	2RX
802.11g	2TX	2RX
802.11n (HT20)	2TX	2RX
802.11n (HT40)	2TX	2RX
5GHz Band		
MODULATION MODE	TX & RX CONFIGURATION	
802.11a	3TX	3RX
802.11n (HT20)	3TX	3RX
802.11n (HT40)	3TX	3RX
802.11ac (VHT20)	3TX	3RX
802.11ac (VHT40)	3TX	3RX
802.11ac (VHT80)	3TX	3RX

Note:

- All of modulation mode support beamforming function except 2.4GHz and 802.11a modulation mode.
- The EUT support Beamforming and CDD mode, therefore both mode were investigated and the worst case scenario was identified. The worst case data were presented in test report.
- The modulation and bandwidth are similar for 802.11n mode for 20MHz (40MHz) and 802.11ac mode for 20MHz (40MHz), therefore investigated worst case to representative mode in test report. (Final test mode refer section 3.2.1)

7. The above EUT information is declared by manufacturer and for more detailed features description, please refers to the manufacturer's specifications or user's manual.

3.2 Description of Test Modes

FOR 5260 ~ 5320MHz

4 channels are provided for 802.11a, 802.11n (HT20), 802.11ac (VHT20):

Channel	Frequency	Channel	Frequency
52	5260 MHz	60	5300 MHz
56	5280 MHz	64	5320 MHz

2 channels are provided for 802.11n (HT40), 802.11ac (VHT40):

Channel	Frequency	Channel	Frequency
54	5270 MHz	62	5310 MHz

1 channel is provided for 802.11ac (VHT80):

Channel	Frequency
58	5290 MHz

FOR 5500 ~ 5720MHz

12 channels are provided for 802.11a, 802.11n (HT20), 802.11ac (VHT20):

Channel	Frequency	Channel	Frequency
100	5500 MHz	124	5620 MHz
104	5520 MHz	128	5640 MHz
108	5540 MHz	132	5660 MHz
112	5560 MHz	136	5680 MHz
116	5580 MHz	140	5700 MHz
120	5600 MHz	144	5720 MHz

6 channels are provided for 802.11n (HT40), 802.11ac (VHT40):

Channel	Frequency	Channel	Frequency
102	5510 MHz	126	5630 MHz
110	5550 MHz	134	5670 MHz
118	5590 MHz	142	5710 MHz

3 channels are provided for 802.11ac (VHT80):

Channel	Frequency	Channel	Frequency
106	5530MHz	138	5690MHz
122	5610 MHz		

3.2.1 Test Mode Applicability and Tested Channel Detail

EUT Configure Mode	Applicable To				Description
	RE \geq 1G	RE $<$ 1G	PLC	APCM	
-	√	√	√	√	-

Where **RE \geq 1G**: Radiated Emission above 1GHz **RE $<$ 1G**: Radiated Emission below 1GHz
PLC: Power Line Conducted Emission **APCM**: Antenna Port Conducted Measurement

Radiated Emission Test (Above 1GHz):

- Pre-Scan has been conducted to determine the worst-case mode from all possible combinations between available modulations, data rates and antenna ports (if EUT with antenna diversity architecture).
- Following channel(s) was (were) selected for the final test as listed below.

CDD Mode						
Mode	FREQ. Band (MHz)	Available Channel	Tested Channel	Modulation Technology	Modulation Type	Data Rate (Mbps)
802.11a	5260-5320	52 to 64	52, 60, 64	OFDM	BPSK	6
802.11ac (VHT20)		52 to 64	52, 60, 64	OFDM	BPSK	6.5
802.11ac (VHT40)		54 to 62	54, 62	OFDM	BPSK	13.5
802.11ac (VHT80)		58	58	OFDM	BPSK	29.3
802.11a	5500-5720	100 to 144	100, 116, 140, 144	OFDM	BPSK	6
802.11ac (VHT20)		100 to 144	100, 116, 140, 144	OFDM	BPSK	6.5
802.11ac (VHT40)		102 to 142	102, 110, 134, 142	OFDM	BPSK	13.5
802.11ac (VHT80)		106 to 138	106, 122, 138	OFDM	BPSK	29.3

Radiated Emission Test (Below 1GHz):

- Pre-Scan has been conducted to determine the worst-case mode from all possible combinations between available modulations, data rates and antenna ports (if EUT with antenna diversity architecture).
- Following channel(s) was (were) selected for the final test as listed below.

CDD Mode						
Mode	FREQ. Band (MHz)	Available Channel	Tested Channel	Modulation Technology	Modulation Type	Data Rate (Mbps)
802.11ac (VHT80)	5260-5320 5500-5720	58 106 to 138	122	OFDM	BPSK	29.3

Power Line Conducted Emission Test:

- Pre-Scan has been conducted to determine the worst-case mode from all possible combinations between available modulations, data rates and antenna ports (if EUT with antenna diversity architecture).
- Following channel(s) was (were) selected for the final test as listed below.

CDD Mode						
Mode	FREQ. Band (MHz)	Available Channel	Tested Channel	Modulation Technology	Modulation Type	Data Rate (Mbps)
802.11ac (VHT80)	5260-5320 5500-5720	58 106 to 138	122	OFDM	BPSK	29.3

Antenna Port Conducted Measurement:

- This item includes all test value of each mode, but only includes spectrum plot of worst value of each mode.
- Pre-Scan has been conducted to determine the worst-case mode from all possible combinations between available modulations, data rates and antenna ports (if EUT with antenna diversity architecture).
- Following channel(s) was (were) selected for the final test as listed below.

CDD Mode						
Mode	FREQ. Band (MHz)	Available Channel	Tested Channel	Modulation Technology	Modulation Type	Data Rate (Mbps)
802.11a	5260-5320	52 to 64	52, 60, 64	OFDM	BPSK	6
802.11ac (VHT20)		52 to 64	52, 60, 64	OFDM	BPSK	6.5
802.11ac (VHT40)		54 to 62	54, 62	OFDM	BPSK	13.5
802.11ac (VHT80)		58	58	OFDM	BPSK	29.3
802.11a	5500-5720	100 to 144	100, 116, 140, 144	OFDM	BPSK	6
802.11ac (VHT20)		100 to 144	100, 116, 140, 144	OFDM	BPSK	6.5
802.11ac (VHT40)		102 to 142	102, 110, 134, 142	OFDM	BPSK	13.5
802.11ac (VHT80)		106 to 138	106, 122, 138	OFDM	BPSK	29.3
Beamforming Mode (Output power only)						
Mode	FREQ. Band (MHz)	Available Channel	Tested Channel	Modulation Technology	Modulation Type	Data Rate (Mbps)
802.11ac (VHT20)	5260-5320	52 to 64	52, 60, 64	OFDM	BPSK	6.5
802.11ac (VHT40)		54 to 62	54, 62	OFDM	BPSK	13.5
802.11ac (VHT80)		58	58	OFDM	BPSK	29.3
802.11ac (VHT20)	5500-5720	100 to 144	100, 116, 140, 144	OFDM	BPSK	6.5
802.11ac (VHT40)		102 to 142	102, 110, 134, 142	OFDM	BPSK	13.5
802.11ac (VHT80)		106 to 138	106, 122, 138	OFDM	BPSK	29.3

Test Condition:

Applicable To	Environmental Conditions	Input Power	Tested By
RE \geq 1G	22deg. C, 73%RH	120Vac, 60Hz	Jeff Lee
RE $<$ 1G	21deg. C, 71%RH	120Vac, 60Hz	Jeff Lee
PLC	24deg. C, 76%RH	120Vac, 60Hz	Andy Ho
APCM	24deg. C, 66%RH	120Vac, 60Hz	Jyunchun Lin

3.3 Duty Cycle of Test Signal

If duty cycle of test signal is $\geq 98\%$, duty factor is not required.
 Duty cycle of test signal is $< 98\%$, duty factor shall be considered.

802.11a: Duty cycle = $2.063/2.083 = 0.99$

802.11ac (VHT20): Duty cycle = $1.927/1.947 = 0.99$

802.11ac (VHT40): Duty cycle = $0.951/0.972 = 0.978$, Duty factor = $10 * \log(1/ \text{Duty cycle}) = 0.09$

802.11ac (VHT80): Duty cycle = $0.459/0.478 = 0.96$, Duty factor = $10 * \log(1/ \text{Duty cycle}) = 0.18$

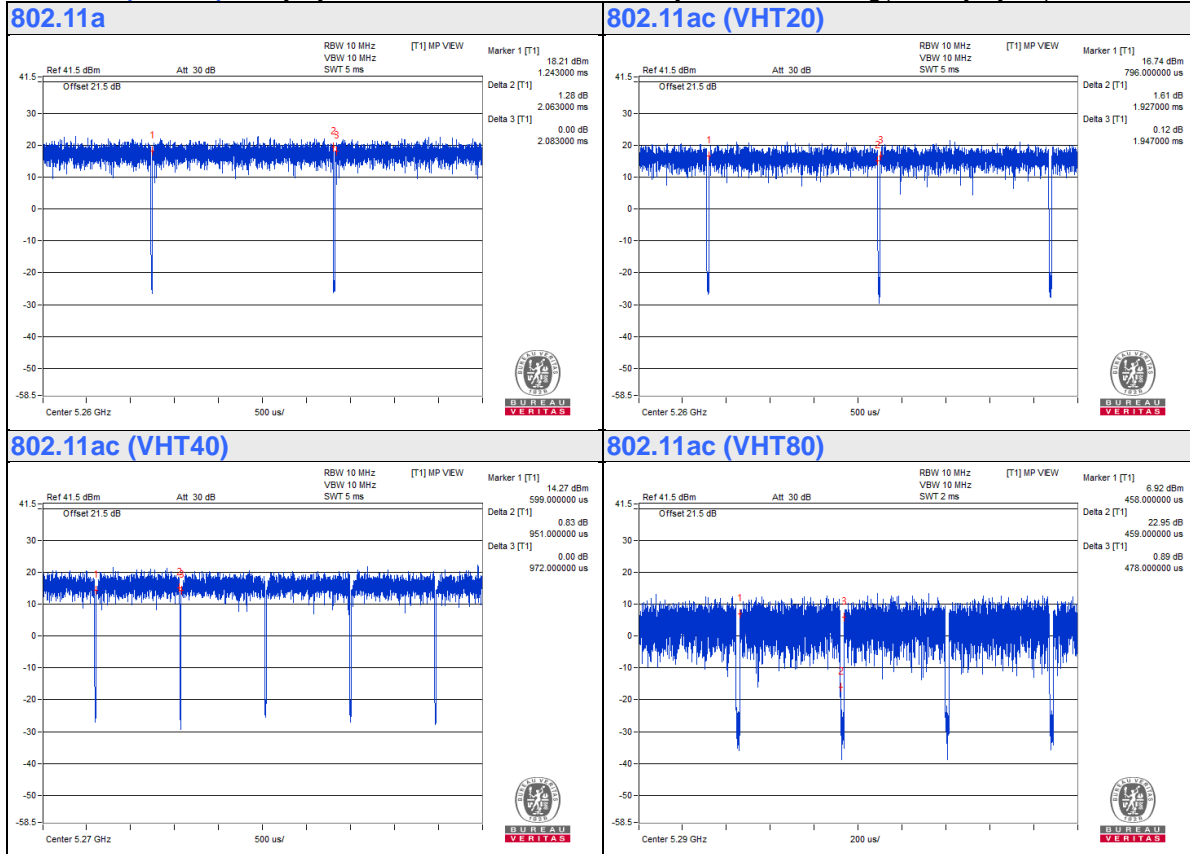

3.4 Description of Support Units

The EUT has been tested as an independent unit together with other necessary accessories or support units. The following support units or accessories were used to form a representative test configuration during the tests.

ID	Product	Brand	Model No.	Serial No.	FCC ID	Remarks
A.	Laptop	Lenovo	81A4	YD02YN7P	PD93165NGU	Provided by Lab
B.	USB Disk	SanDisk	Ultra Flair CZ73	NA	NA	Provided by Lab
C.	Telephone	WONDER	WD-303	7C17KA 04011	NA	Provided by Lab

Note:

1. All power cords of the above support units are non-shielded (1.8m).

ID	Descriptions	Qty.	Length (m)	Shielding (Yes/No)	Cores (Qty.)	Remarks
1.	DC Cable	1	2	No	0	Supplied by client
2.	Coaxial Cable	1	10	Yes	0	Provided by Lab
3.	RJ-45 Cable	1	10	No	0	Provided by Lab
4.	RJ-11 Cable	1	10	No	0	Supplied by client

3.4.1 Configuration of System under Test

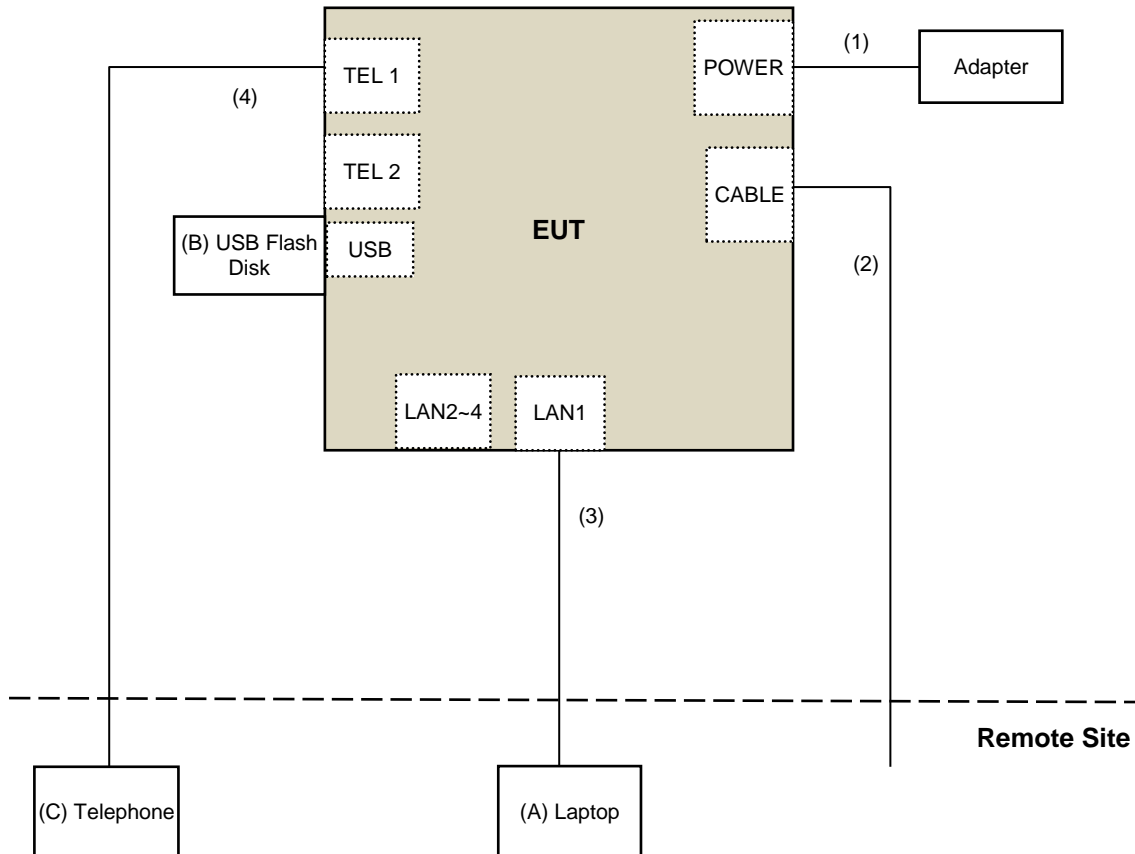

3.5 General Description of Applied Standard

The EUT is a RF Product. According to the specifications of the manufacturer, it must comply with the requirements of the following standards:

FCC Part 15, Subpart E (15.407)

KDB 789033 D02 General UNII Test Procedure New Rules v02r01

KDB 662911 D01 Multiple Transmitter Output v02r01

ANSI C63.10-2013

All test items have been performed and recorded as per the above standards.

4 Test Types and Results

4.1 Radiated Emission and Bandedge Measurement

4.1.1 Limits of Radiated Emission and Bandedge Measurement

Radiated emissions which fall in the restricted bands must comply with the radiated emission limits specified as below table.

Frequencies (MHz)	Field Strength (microvolts/meter)	Measurement Distance (meters)
0.009 ~ 0.490	2400/F(kHz)	300
0.490 ~ 1.705	24000/F(kHz)	30
1.705 ~ 30.0	30	30
30 ~ 88	100	3
88 ~ 216	150	3
216 ~ 960	200	3
Above 960	500	3

NOTE:

- The lower limit shall apply at the transition frequencies.
- Emission level (dBuV/m) = 20 log Emission level (uV/m).
- For frequencies above 1000MHz, the field strength limits are based on average detector, however, the peak field strength of any emission shall not exceed the maximum permitted average limits, specified above by more than 20dB under any condition of modulation.

Limits of unwanted emission out of the restricted bands

Applicable To		Limit	
789033 D02 General UNII Test Procedure New Rules v02r01		Field Strength at 3m	
		PK:74 (dBuV/m)	AV:54 (dBuV/m)
Frequency Band	Applicable To	EIRP Limit	Equivalent Field Strength at 3m
5150~5250 MHz	15.407(b)(1)	PK:-27 (dBm/MHz)	PK:68.2(dBuV/m)
5250~5350 MHz	15.407(b)(2)		
5470~5725 MHz	15.407(b)(3)		
5725~5850 MHz	<input checked="" type="checkbox"/> 15.407(b)(4)(i)	PK:-27 (dBm/MHz) ^{*1} PK:10 (dBm/MHz) ^{*2} PK:15.6 (dBm/MHz) ^{*3} PK:27 (dBm/MHz) ^{*4}	PK: 68.2(dBuV/m) ^{*1} PK:105.2 (dBuV/m) ^{*2} PK: 110.8(dBuV/m) ^{*3} PK:122.2 (dBuV/m) ^{*4}
	<input type="checkbox"/> 15.407(b)(4)(ii)	Emission limits in section 15.247(d)	
^{*1} beyond 75 MHz or more above of the band edge. ^{*3} below the band edge increasing linearly to a level of 15.6 dBm/MHz at 5 MHz above.		^{*2} below the band edge increasing linearly to 10 dBm/MHz at 25 MHz above. ^{*4} from 5 MHz above or below the band edge increasing linearly to a level of 27 dBm/MHz at the band edge.	

Note:

The following formula is used to convert the equipment isotropic radiated power (eirp) to field strength:

$$E = \frac{1000000\sqrt{30P}}{3} \mu\text{V/m, where } P \text{ is the eirp (Watts).}$$

4.1.2 Test Instruments

DESCRIPTION & MANUFACTURER	MODEL NO.	SERIAL NO.	CALIBRATED DATE	CALIBRATED UNTIL
Test Receiver ESR7 R&S	ESR7	102026	Apr. 24, 2019	Apr. 23, 2020
Spectrum Analyzer Keysight	N9030B	MY57141948	May 25, 2019	May 24, 2020
Pre-Amplifier EMCI	EMC001340	980142	May 30, 2019	May 29, 2020
Loop Antenna Electro-Metrics	EM-6879	264	Jan. 22, 2019	Jan. 21, 2020
RF Cable	NA	LOOPCAB-001	Jan. 14, 2019	Jan. 13, 2020
RF Cable	NA	LOOPCAB-002	Jan. 14, 2019	Jan. 13, 2020
Pre-Amplifier EMCI	EMC330N	980538	Apr. 30, 2019	Apr. 29, 2020
Trilog Broadband Antenna SCHWARZBECK	VULB9168	9168-0842	Nov. 21, 2018	Nov. 20, 2019
RF Cable	8D	966-5-1	May 03, 2019	May 02, 2020
RF Cable	8D	966-5-2	May 03, 2019	May 02, 2020
RF Cable	8D	966-5-3	May 03, 2019	May 02, 2020
Fixed attenuator Mini-Circuits	UNAT-5+	PAD-ATT5-02	Jan. 28, 2019	Jan. 27, 2020
Horn_Antenna SCHWARZBECK	BBHA 9120D	9120D-1819	Nov. 25, 2018	Nov. 24, 2019
Pre-Amplifier EMCI	EMC12630SE	980509	May 03, 2019	May 02, 2020
RF Cable EMCI	EMC104-SM-SM-1500	180503	May 03, 2019	May 02, 2020
RF Cable EMCI	EMC104-SM-SM-2000	180501	May 03, 2019	May 02, 2020
RF Cable EMCI	EMC104-SM-SM-6000	180505	May 03, 2019	May 02, 2020
Pre-Amplifier EMCI	EMC184045SE	980387	Jan. 28, 2019	Jan. 27, 2020
Horn_Antenna SCHWARZBECK	BBHA 9170	BBHA9170519	Nov. 25, 2018	Nov. 24, 2019
RF Cable	EMC102-KM-KM-1200	160924	Jan. 28, 2019	Jan. 27, 2020
RF Cable	EMC102-KM-KM-1200	160925	Jan. 28, 2019	Jan. 27, 2020
Software	ADT_Radiated_V8.7.08	NA	NA	NA
Boresight Antenna Tower & Turn Table Max-Full	MF-7802BS	MF780208530	NA	NA
Spectrum Analyzer R&S	FSV40	100964	June 04, 2019	June 03, 2020
Power meter Anritsu	ML2495A	1014008	May 13, 2019	May 12, 2020
Power sensor Anritsu	MA2411B	0917122	May 13, 2019	May 12, 2020
Fixed Attenuator Mini-Circuits	MDCS18N-10	MDCS18N-10-01	Apr. 15, 2019	Apr. 14, 2020

Temperature & Humidity Chamber Giant Force	GTH-150-40-SP-AR	MAA0812-008	Jan. 09, 2019	Jan. 08, 2020
AC Power Source Extech Electronics	6205	1440452	NA	NA
True RMS Clamp Meter FLUKE	325	31130711WS	May 21, 2019	May 20, 2020

Note:

1. The calibration interval of the above test instruments is 12 months and the calibrations are traceable to NML/ROC and NIST/USA.
2. The test was performed in 966 Chamber No. 5.
3. Loop antenna was used for all emissions below 30 MHz.
4. Tested Date: Sep. 11 to 12, 2019

4.1.3 Test Procedure

For Radiated emission below 30MHz

- a. The EUT was placed on the top of a rotating table 0.8 meters above the ground at a 3 meter chamber room. The table was rotated 360 degrees to determine the position of the highest radiation.
- b. The EUT was set 3 meters away from the interference-receiving antenna, which was mounted on the top of a variable-height antenna tower.
- c. Parallel, perpendicular, and ground-parallel orientations of the antenna are set to make the measurement.
- d. For each suspected emission, the EUT was arranged to its worst case and the rotatable table was turned from 0 degrees to 360 degrees to find the maximum reading.
- e. The test-receiver system was set to Quasi-Peak Detect Function and Specified Bandwidth with Maximum Hold Mode.

NOTE:

1. The resolution bandwidth and video bandwidth of test receiver/spectrum analyzer is 9kHz at frequency below 30MHz.

For Radiated emission above 30MHz

- a. The EUT was placed on the top of a rotating table 0.8 meters (for 30MHz ~ 1GHz) / 1.5 meters (for above 1GHz) above the ground at 3 meter chamber room for test. The table was rotated 360 degrees to determine the position of the highest radiation.
- b. The EUT was set 3 meters away from the interference-receiving antenna, which was mounted on the top of a variable-height antenna tower.
- c. The height of antenna is varied from one meter to four meters above the ground to determine the maximum value of the field strength. Both horizontal and vertical polarizations of the antenna are set to make the measurement.
- d. For each suspected emission, the EUT was arranged to its worst case and then the antenna was tuned to heights from 1 meter to 4 meters and the rotatable table was turned from 0 degrees to 360 degrees to find the maximum reading.
- e. The test-receiver system was set to quasi-peak detect function and specified bandwidth with maximum hold mode when the test frequency is below 1 GHz.
- f. The test-receiver system was set to peak and average detects function and specified bandwidth with maximum hold mode when the test frequency is above 1 GHz. If the peak reading value also meets average limit, measurement with the average detector is unnecessary.

Note:

1. The resolution bandwidth and video bandwidth of test receiver/spectrum analyzer is 120kHz for Quasi-peak detection (QP) at frequency below 1GHz.
2. The resolution bandwidth of test receiver/spectrum analyzer is 1 MHz and the video bandwidth is 3 MHz for Peak detection (PK) at frequency above 1GHz.
3. The resolution bandwidth of test receiver/spectrum analyzer is 1MHz and the video bandwidth is $\geq 1/T$ (Duty cycle < 98%) or 10Hz (Duty cycle $\geq 98\%$) for Average detection (AV) at frequency above 1GHz.
4. All modes of operation were investigated and the worst-case emissions are reported.

4.1.4 Deviation from Test Standard

No deviation.

4.1.5 Test Setup

For Radiated emission below 30MHz

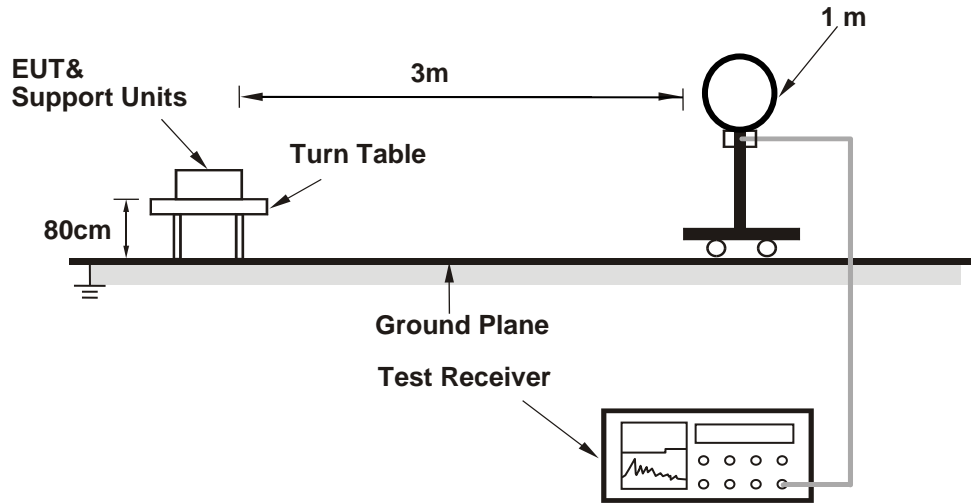

For Radiated emission 30MHz to 1GHz

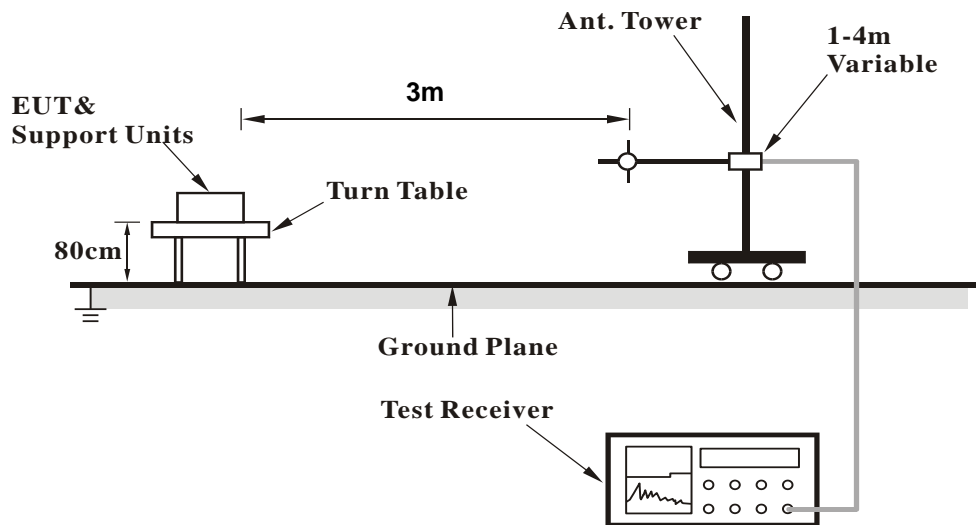

For Radiated emission above 1GHz

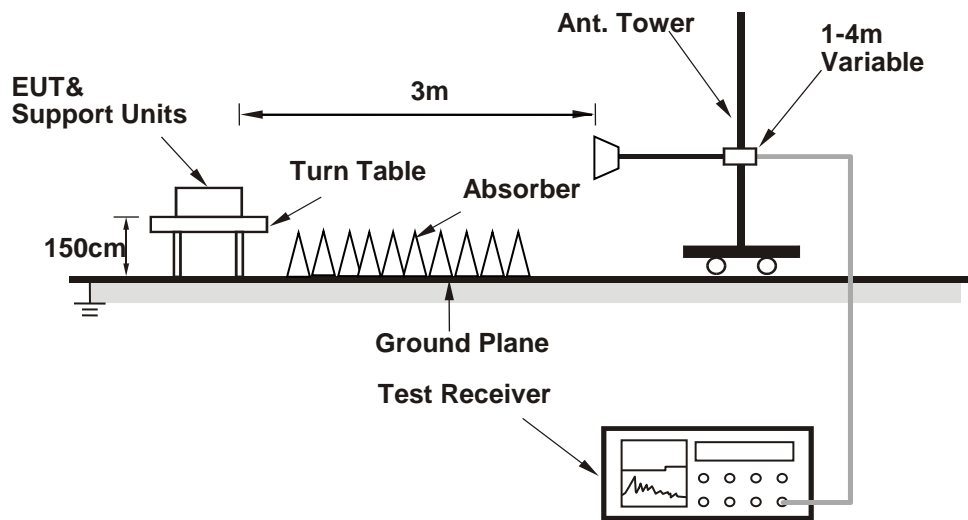

For the actual test configuration, please refer to the attached file (Test Setup Photo).

4.1.6 EUT Operating Condition

- a. Connected the EUT with the Laptop which is placed on remote site.
- b. Controlling software (Mtool[2.0.1.0]) has been activated to set the EUT on specific status.

4.1.7 Test Results

Above 1GHz Data:

802.11a

CHANNEL	TX Channel 52	DETECTOR FUNCTION	Peak (PK)
FREQUENCY RANGE	1GHz ~ 40GHz		Average (AV)

ANTENNA POLARITY & TEST DISTANCE: HORIZONTAL AT 3 M								
NO.	FREQ. (MHz)	EMISSION LEVEL (dBuV/m)	LIMIT (dBuV/m)	MARGIN (dB)	ANTENNA HEIGHT (m)	TABLE ANGLE (Degree)	RAW VALUE (dBuV)	CORRECTION FACTOR (dB/m)
1	5150.00	57.6 PK	74.0	-16.4	3.91 H	144	55.5	2.1
2	5150.00	47.3 AV	54.0	-6.7	3.91 H	144	45.2	2.1
3	*5260.00	108.0 PK			3.91 H	144	106.7	1.3
4	*5260.00	99.0 AV			3.91 H	144	97.7	1.3
5	#10520.00	46.4 PK	68.2	-21.8	2.51 H	255	33.6	12.8
6	15780.00	47.4 PK	74.0	-26.6	1.64 H	313	35.7	11.7
7	15780.00	35.0 AV	54.0	-19.0	1.64 H	313	23.3	11.7

REMARKS:

1. Emission Level(dBuV/m) = Raw Value(dBuV) + Correction Factor(dB/m)
2. Correction Factor(dB/m) = Antenna Factor(dB/m) + Cable Factor(dB) – Pre-Amplifier Factor(dB)
3. Margin value = Emission Level – Limit value
4. The other emission levels were very low against the limit.
5. " * ": Fundamental frequency.
6. " # ": The radiated frequency is out of the restricted band.

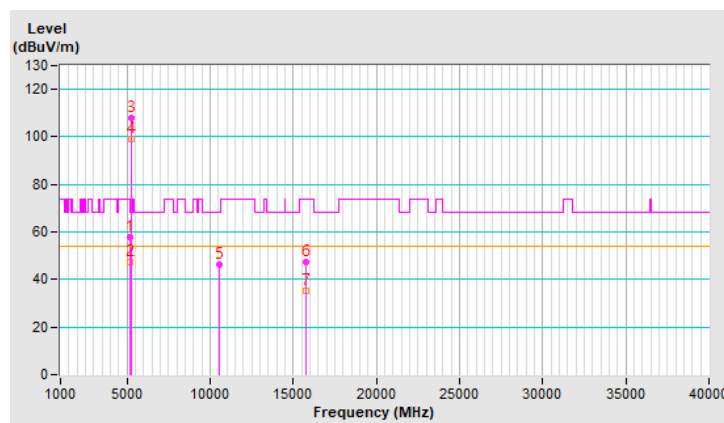

CHANNEL	TX Channel 52	DETECTOR FUNCTION	Peak (PK)
FREQUENCY RANGE	1GHz ~ 40GHz		Average (AV)

ANTENNA POLARITY & TEST DISTANCE: VERTICAL AT 3 M

NO.	FREQ. (MHz)	EMISSION LEVEL (dBuV/m)	LIMIT (dBuV/m)	MARGIN (dB)	ANTENNA HEIGHT (m)	TABLE ANGLE (Degree)	RAW VALUE (dBuV)	CORRECTION FACTOR (dB/m)
1	5150.00	57.4 PK	74.0	-16.6	1.66 V	71	55.3	2.1
2	5150.00	47.2 AV	54.0	-6.8	1.66 V	71	45.1	2.1
3	*5260.00	108.5 PK			1.66 V	71	107.2	1.3
4	*5260.00	98.9 AV			1.66 V	71	97.6	1.3
5	#10520.00	46.8 PK	68.2	-21.4	2.14 V	169	34.0	12.8
6	15780.00	47.5 PK	74.0	-26.5	1.05 V	341	35.8	11.7
7	15780.00	35.3 AV	54.0	-18.7	1.05 V	341	23.6	11.7

REMARKS:

1. Emission Level(dBuV/m) = Raw Value(dBuV) + Correction Factor(dB/m)
2. Correction Factor(dB/m) = Antenna Factor(dB/m) + Cable Factor(dB) – Pre-Amplifier Factor(dB)
3. Margin value = Emission Level – Limit value
4. The other emission levels were very low against the limit.
5. " * ": Fundamental frequency.
6. " # ": The radiated frequency is out of the restricted band.

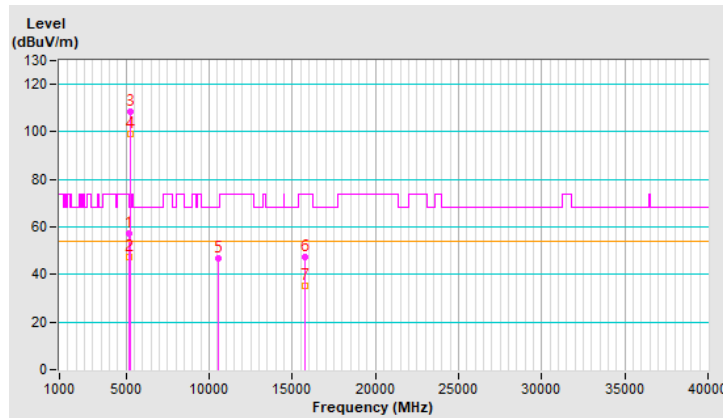

CHANNEL	TX Channel 60	DETECTOR FUNCTION	Peak (PK)
FREQUENCY RANGE	1GHz ~ 40GHz		Average (AV)

ANTENNA POLARITY & TEST DISTANCE: HORIZONTAL AT 3 M

NO.	FREQ. (MHz)	EMISSION LEVEL (dBuV/m)	LIMIT (dBuV/m)	MARGIN (dB)	ANTENNA HEIGHT (m)	TABLE ANGLE (Degree)	RAW VALUE (dBuV)	CORRECTION FACTOR (dB/m)
1	*5300.00	108.5 PK			3.96 H	141	107.1	1.4
2	*5300.00	99.1 AV			3.96 H	141	97.7	1.4
3	10600.00	45.8 PK	74.0	-28.2	2.64 H	270	32.7	13.1
4	10600.00	34.0 AV	54.0	-20.0	2.64 H	270	20.9	13.1
5	15900.00	47.3 PK	74.0	-26.7	1.56 H	302	35.8	11.5
6	15900.00	35.1 AV	54.0	-18.9	1.56 H	302	23.6	11.5

REMARKS:

1. Emission Level(dBuV/m) = Raw Value(dBuV) + Correction Factor(dB/m)
2. Correction Factor(dB/m) = Antenna Factor(dB/m) + Cable Factor(dB) – Pre-Amplifier Factor(dB)
3. Margin value = Emission Level – Limit value
4. The other emission levels were very low against the limit.
5. " * ": Fundamental frequency.

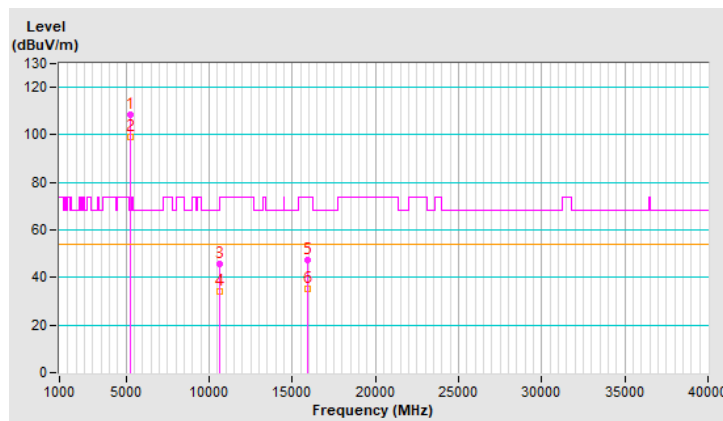

CHANNEL	TX Channel 60	DETECTOR FUNCTION	Peak (PK)
FREQUENCY RANGE	1GHz ~ 40GHz		Average (AV)

ANTENNA POLARITY & TEST DISTANCE: VERTICAL AT 3 M

NO.	FREQ. (MHz)	EMISSION LEVEL (dBuV/m)	LIMIT (dBuV/m)	MARGIN (dB)	ANTENNA HEIGHT (m)	TABLE ANGLE (Degree)	RAW VALUE (dBuV)	CORRECTION FACTOR (dB/m)
1	*5300.00	108.2 PK			1.65 V	87	106.8	1.4
2	*5300.00	99.1 AV			1.65 V	87	97.7	1.4
3	10600.00	46.5 PK	74.0	-27.5	2.17 V	175	33.4	13.1
4	10600.00	34.0 AV	54.0	-20.0	2.17 V	175	20.9	13.1
5	15900.00	47.0 PK	74.0	-27.0	1.00 V	350	35.5	11.5
6	15900.00	34.9 AV	54.0	-19.1	1.00 V	350	23.4	11.5

REMARKS:

1. Emission Level(dBuV/m) = Raw Value(dBuV) + Correction Factor(dB/m)
2. Correction Factor(dB/m) = Antenna Factor(dB/m) + Cable Factor(dB) – Pre-Amplifier Factor(dB)
3. Margin value = Emission Level – Limit value
4. The other emission levels were very low against the limit.
5. " * ": Fundamental frequency.

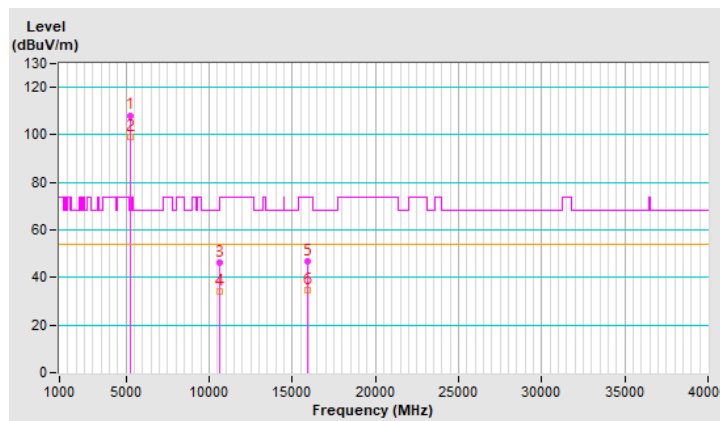

CHANNEL	TX Channel 64	DETECTOR FUNCTION	Peak (PK)
FREQUENCY RANGE	1GHz ~ 40GHz		Average (AV)

ANTENNA POLARITY & TEST DISTANCE: HORIZONTAL AT 3 M

NO.	FREQ. (MHz)	EMISSION LEVEL (dBuV/m)	LIMIT (dBuV/m)	MARGIN (dB)	ANTENNA HEIGHT (m)	TABLE ANGLE (Degree)	RAW VALUE (dBuV)	CORRECTION FACTOR (dB/m)
1	*5320.00	108.3 PK			3.27 H	144	106.8	1.5
2	*5320.00	99.2 AV			3.27 H	144	97.7	1.5
3	5350.00	63.3 PK	74.0	-10.7	3.27 H	144	61.8	1.5
4	5350.00	48.5 AV	54.0	-5.5	3.27 H	144	47.0	1.5
5	10640.00	45.8 PK	74.0	-28.2	2.55 H	272	32.6	13.2
6	10640.00	34.1 AV	54.0	-19.9	2.55 H	272	20.9	13.2
7	15960.00	47.3 PK	74.0	-26.7	1.60 H	308	35.8	11.5
8	15960.00	35.0 AV	54.0	-19.0	1.60 H	308	23.5	11.5

REMARKS:

1. Emission Level(dBuV/m) = Raw Value(dBuV) + Correction Factor(dB/m)
2. Correction Factor(dB/m) = Antenna Factor(dB/m) + Cable Factor(dB) – Pre-Amplifier Factor(dB)
3. Margin value = Emission Level – Limit value
4. The other emission levels were very low against the limit.
5. " * ": Fundamental frequency.

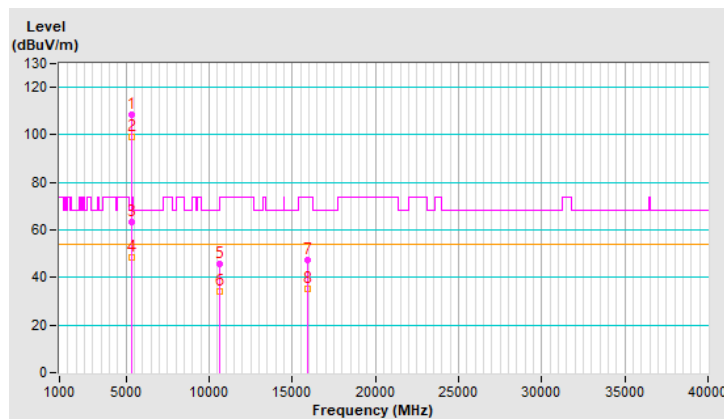

CHANNEL	TX Channel 64	DETECTOR FUNCTION	Peak (PK)
FREQUENCY RANGE	1GHz ~ 40GHz		Average (AV)

ANTENNA POLARITY & TEST DISTANCE: VERTICAL AT 3 M

NO.	FREQ. (MHz)	EMISSION LEVEL (dBuV/m)	LIMIT (dBuV/m)	MARGIN (dB)	ANTENNA HEIGHT (m)	TABLE ANGLE (Degree)	RAW VALUE (dBuV)	CORRECTION FACTOR (dB/m)
1	*5320.00	108.6 PK			1.59 V	64	107.1	1.5
2	*5320.00	99.2 AV			1.59 V	64	97.7	1.5
3	5350.00	63.3 PK	74.0	-10.7	1.59 V	64	61.8	1.5
4	5350.00	48.5 AV	54.0	-5.5	1.59 V	64	47.0	1.5
5	10640.00	46.6 PK	74.0	-27.4	2.17 V	154	33.4	13.2
6	10640.00	34.4 AV	54.0	-19.6	2.17 V	154	21.2	13.2
7	15960.00	47.5 PK	74.0	-26.5	1.02 V	344	36.0	11.5
8	15960.00	35.7 AV	54.0	-18.3	1.02 V	344	24.2	11.5

REMARKS:

1. Emission Level(dBuV/m) = Raw Value(dBuV) + Correction Factor(dB/m)
2. Correction Factor(dB/m) = Antenna Factor(dB/m) + Cable Factor(dB) – Pre-Amplifier Factor(dB)
3. Margin value = Emission Level – Limit value
4. The other emission levels were very low against the limit.
5. " * ": Fundamental frequency.

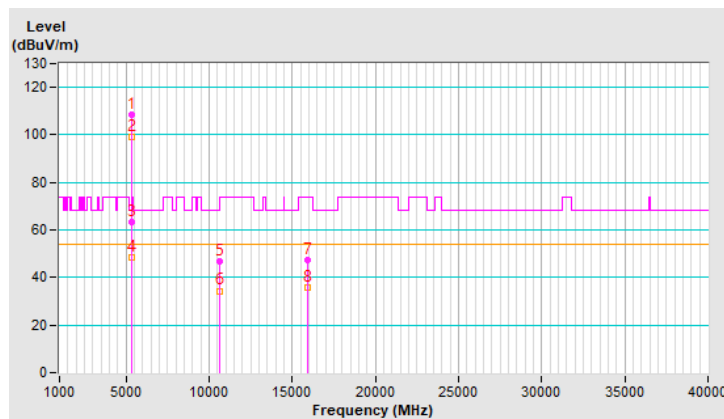

CHANNEL	TX Channel 100	DETECTOR FUNCTION	Peak (PK)
FREQUENCY RANGE	1GHz ~ 40GHz		Average (AV)

ANTENNA POLARITY & TEST DISTANCE: HORIZONTAL AT 3 M

NO.	FREQ. (MHz)	EMISSION LEVEL (dBuV/m)	LIMIT (dBuV/m)	MARGIN (dB)	ANTENNA HEIGHT (m)	TABLE ANGLE (Degree)	RAW VALUE (dBuV)	CORRECTION FACTOR (dB/m)
1	5460.00	56.2 PK	74.0	-17.8	3.96 H	129	54.3	1.9
2	5460.00	44.1 AV	54.0	-9.9	3.96 H	129	42.2	1.9
3	#5470.00	65.5 PK	68.2	-2.7	3.96 H	129	63.6	1.9
4	*5500.00	108.9 PK			3.96 H	129	107.0	1.9
5	*5500.00	99.9 AV			3.96 H	129	98.0	1.9
6	11000.00	46.4 PK	74.0	-27.6	2.44 H	269	32.8	13.6
7	11000.00	34.7 AV	54.0	-19.3	2.44 H	269	21.1	13.6
8	#16500.00	47.2 PK	68.2	-21.0	1.54 H	308	33.0	14.2

REMARKS:

1. Emission Level(dBuV/m) = Raw Value(dBuV) + Correction Factor(dB/m)
2. Correction Factor(dB/m) = Antenna Factor(dB/m) + Cable Factor(dB) – Pre-Amplifier Factor(dB)
3. Margin value = Emission Level – Limit value
4. The other emission levels were very low against the limit.
5. " * ": Fundamental frequency.
6. " # ": The radiated frequency is out of the restricted band.

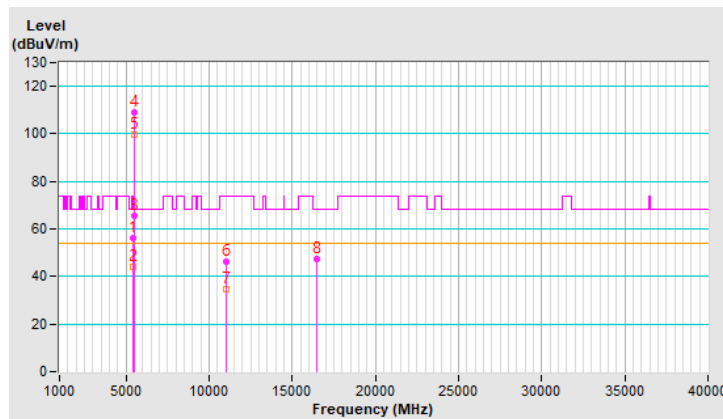

CHANNEL	TX Channel 100	DETECTOR FUNCTION	Peak (PK)
FREQUENCY RANGE	1GHz ~ 40GHz		Average (AV)

ANTENNA POLARITY & TEST DISTANCE: VERTICAL AT 3 M

NO.	FREQ. (MHz)	EMISSION LEVEL (dBuV/m)	LIMIT (dBuV/m)	MARGIN (dB)	ANTENNA HEIGHT (m)	TABLE ANGLE (Degree)	RAW VALUE (dBuV)	CORRECTION FACTOR (dB/m)
1	5460.00	57.3 PK	74.0	-16.7	1.59 V	81	55.4	1.9
2	5460.00	44.1 AV	54.0	-9.9	1.59 V	81	42.2	1.9
3	#5470.00	65.3 PK	68.2	-2.9	1.59 V	81	63.4	1.9
4	*5500.00	108.7 PK			1.59 V	81	106.8	1.9
5	*5500.00	99.5 AV			1.59 V	81	97.6	1.9
6	11000.00	46.5 PK	74.0	-27.5	2.12 V	173	32.9	13.6
7	11000.00	34.3 AV	54.0	-19.7	2.12 V	173	20.7	13.6
8	#16500.00	47.0 PK	68.2	-21.2	1.00 V	334	32.8	14.2

REMARKS:

1. Emission Level(dBuV/m) = Raw Value(dBuV) + Correction Factor(dB/m)
2. Correction Factor(dB/m) = Antenna Factor(dB/m) + Cable Factor(dB) – Pre-Amplifier Factor(dB)
3. Margin value = Emission Level – Limit value
4. The other emission levels were very low against the limit.
5. " * ": Fundamental frequency.
6. " # ": The radiated frequency is out of the restricted band.

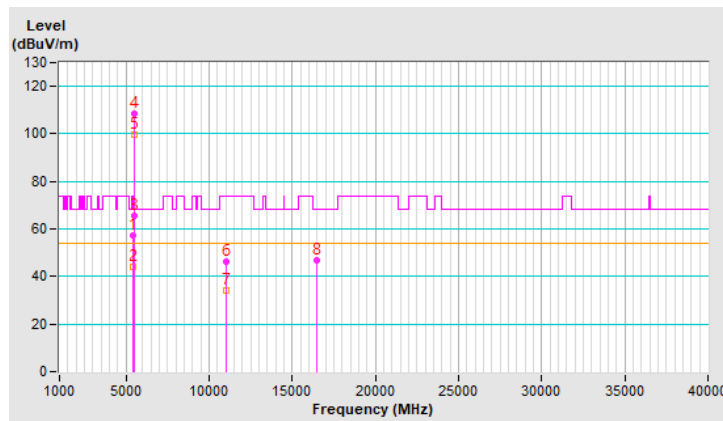

CHANNEL	TX Channel 116	DETECTOR FUNCTION	Peak (PK)
FREQUENCY RANGE	1GHz ~ 40GHz		Average (AV)

ANTENNA POLARITY & TEST DISTANCE: HORIZONTAL AT 3 M

NO.	FREQ. (MHz)	EMISSION LEVEL (dBuV/m)	LIMIT (dBuV/m)	MARGIN (dB)	ANTENNA HEIGHT (m)	TABLE ANGLE (Degree)	RAW VALUE (dBuV)	CORRECTION FACTOR (dB/m)
1	*5580.00	108.7 PK			3.39 H	134	106.6	2.1
2	*5580.00	99.7 AV			3.39 H	134	97.6	2.1
3	11160.00	45.9 PK	74.0	-28.1	2.41 H	288	33.2	12.7
4	11160.00	34.0 AV	54.0	-20.0	2.41 H	288	21.3	12.7
5	#16740.00	47.8 PK	68.2	-20.4	1.49 H	307	31.9	15.9

REMARKS:

1. Emission Level(dBuV/m) = Raw Value(dBuV) + Correction Factor(dB/m)
2. Correction Factor(dB/m) = Antenna Factor(dB/m) + Cable Factor(dB) – Pre-Amplifier Factor(dB)
3. Margin value = Emission Level – Limit value
4. The other emission levels were very low against the limit.
5. " * ": Fundamental frequency.
6. " # ": The radiated frequency is out of the restricted band.

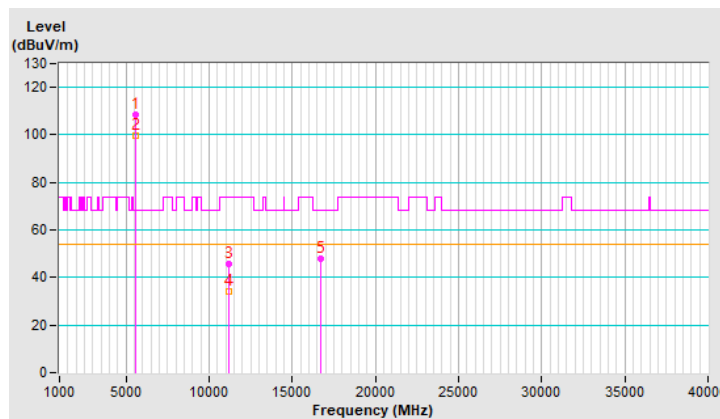

CHANNEL	TX Channel 116	DETECTOR FUNCTION	Peak (PK)
FREQUENCY RANGE	1GHz ~ 40GHz		Average (AV)

ANTENNA POLARITY & TEST DISTANCE: VERTICAL AT 3 M

NO.	FREQ. (MHz)	EMISSION LEVEL (dBuV/m)	LIMIT (dBuV/m)	MARGIN (dB)	ANTENNA HEIGHT (m)	TABLE ANGLE (Degree)	RAW VALUE (dBuV)	CORRECTION FACTOR (dB/m)
1	*5580.00	107.9 PK			1.67 V	65	105.8	2.1
2	*5580.00	98.8 AV			1.67 V	65	96.7	2.1
3	11160.00	46.5 PK	74.0	-27.5	2.09 V	180	33.8	12.7
4	11160.00	34.4 AV	54.0	-19.6	2.09 V	180	21.7	12.7
5	#16740.00	47.0 PK	68.2	-21.2	1.05 V	336	31.1	15.9

REMARKS:

1. Emission Level(dBuV/m) = Raw Value(dBuV) + Correction Factor(dB/m)
2. Correction Factor(dB/m) = Antenna Factor(dB/m) + Cable Factor(dB) – Pre-Amplifier Factor(dB)
3. Margin value = Emission Level – Limit value
4. The other emission levels were very low against the limit.
5. " * ": Fundamental frequency.
6. " # ": The radiated frequency is out of the restricted band.

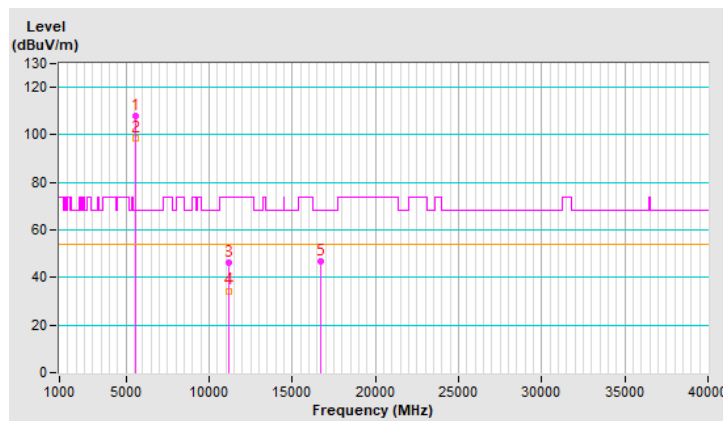

CHANNEL	TX Channel 140	DETECTOR FUNCTION	Peak (PK)
FREQUENCY RANGE	1GHz ~ 40GHz		Average (AV)

ANTENNA POLARITY & TEST DISTANCE: HORIZONTAL AT 3 M

NO.	FREQ. (MHz)	EMISSION LEVEL (dBuV/m)	LIMIT (dBuV/m)	MARGIN (dB)	ANTENNA HEIGHT (m)	TABLE ANGLE (Degree)	RAW VALUE (dBuV)	CORRECTION FACTOR (dB/m)
1	*5700.00	108.5 PK			3.66 H	129	106.3	2.2
2	*5700.00	99.4 AV			3.66 H	129	97.2	2.2
3	#5725.00	62.1 PK	68.2	-6.1	3.66 H	129	59.9	2.2
4	11400.00	46.1 PK	74.0	-27.9	2.45 H	277	32.6	13.5
5	11400.00	34.2 AV	54.0	-19.8	2.45 H	277	20.7	13.5
6	#17100.00	47.3 PK	68.2	-20.9	1.49 H	308	30.5	16.8

REMARKS:

1. Emission Level(dBuV/m) = Raw Value(dBuV) + Correction Factor(dB/m)
2. Correction Factor(dB/m) = Antenna Factor(dB/m) + Cable Factor(dB) – Pre-Amplifier Factor(dB)
3. Margin value = Emission Level – Limit value
4. The other emission levels were very low against the limit.
5. " * ": Fundamental frequency.
6. " # ": The radiated frequency is out of the restricted band.

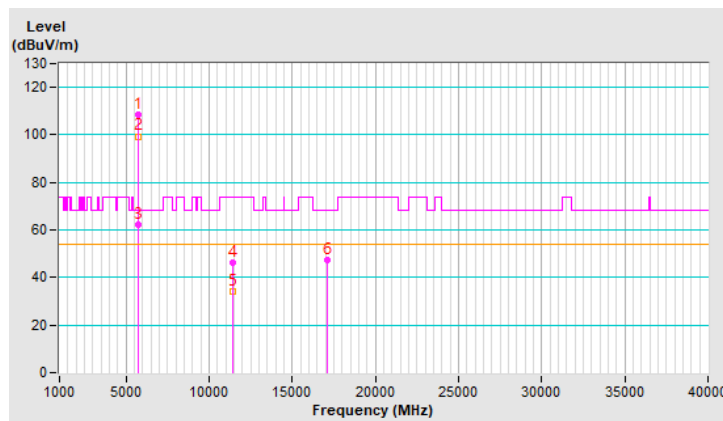

CHANNEL	TX Channel 140	DETECTOR FUNCTION	Peak (PK)
FREQUENCY RANGE	1GHz ~ 40GHz		Average (AV)

ANTENNA POLARITY & TEST DISTANCE: VERTICAL AT 3 M

NO.	FREQ. (MHz)	EMISSION LEVEL (dBuV/m)	LIMIT (dBuV/m)	MARGIN (dB)	ANTENNA HEIGHT (m)	TABLE ANGLE (Degree)	RAW VALUE (dBuV)	CORRECTION FACTOR (dB/m)
1	*5700.00	108.7 PK			1.66 V	78	106.5	2.2
2	*5700.00	99.3 AV			1.66 V	78	97.1	2.2
3	#5725.00	62.2 PK	68.2	-6.0	1.66 V	78	60.0	2.2
4	11400.00	46.5 PK	74.0	-27.5	2.13 V	163	33.0	13.5
5	11400.00	34.2 AV	54.0	-19.8	2.13 V	163	20.7	13.5
6	#17100.00	47.3 PK	68.2	-20.9	1.00 V	333	30.5	16.8

REMARKS:

1. Emission Level(dBuV/m) = Raw Value(dBuV) + Correction Factor(dB/m)
2. Correction Factor(dB/m) = Antenna Factor(dB/m) + Cable Factor(dB) – Pre-Amplifier Factor(dB)
3. Margin value = Emission Level – Limit value
4. The other emission levels were very low against the limit.
5. " * ": Fundamental frequency.
6. " # ": The radiated frequency is out of the restricted band.

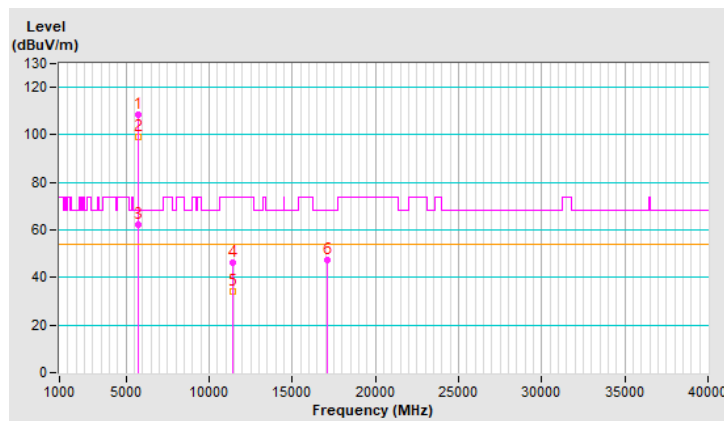

CHANNEL	TX Channel 144	DETECTOR FUNCTION	Peak (PK)
FREQUENCY RANGE	1GHz ~ 40GHz		Average (AV)

ANTENNA POLARITY & TEST DISTANCE: HORIZONTAL AT 3 M

NO.	FREQ. (MHz)	EMISSION LEVEL (dBuV/m)	LIMIT (dBuV/m)	MARGIN (dB)	ANTENNA HEIGHT (m)	TABLE ANGLE (Degree)	RAW VALUE (dBuV)	CORRECTION FACTOR (dB/m)
1	#5470.00	48.9 PK	68.2	-19.3	3.45 H	133	47.0	1.9
2	*5720.00	108.6 PK			3.45 H	133	106.4	2.2
3	*5720.00	99.5 AV			3.45 H	133	97.3	2.2
4	#5850.00	54.5 PK	68.2	-13.7	3.45 H	133	51.9	2.6
5	11440.00	46.3 PK	74.0	-27.7	2.39 H	301	32.6	13.7
6	11440.00	34.4 AV	54.0	-19.6	2.39 H	301	20.7	13.7
7	#17160.00	47.9 PK	68.2	-20.3	1.49 H	320	30.6	17.3

REMARKS:

1. Emission Level(dBuV/m) = Raw Value(dBuV) + Correction Factor(dB/m)
2. Correction Factor(dB/m) = Antenna Factor(dB/m) + Cable Factor(dB) – Pre-Amplifier Factor(dB)
3. Margin value = Emission Level – Limit value
4. The other emission levels were very low against the limit.
5. " * ": Fundamental frequency.
6. " # ": The radiated frequency is out of the restricted band.

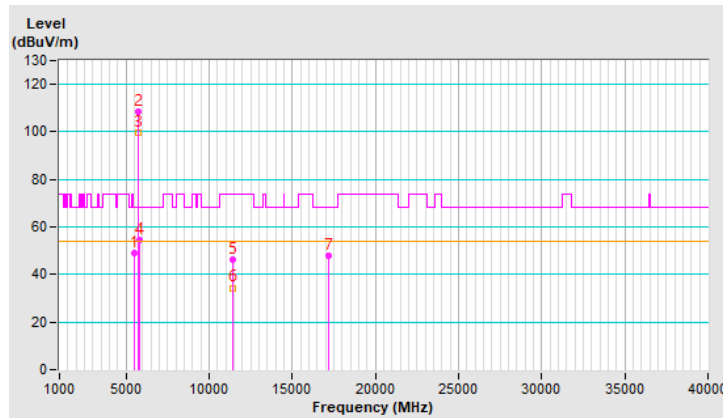

CHANNEL	TX Channel 144	DETECTOR FUNCTION	Peak (PK)
FREQUENCY RANGE	1GHz ~ 40GHz		Average (AV)

ANTENNA POLARITY & TEST DISTANCE: VERTICAL AT 3 M

NO.	FREQ. (MHz)	EMISSION LEVEL (dBuV/m)	LIMIT (dBuV/m)	MARGIN (dB)	ANTENNA HEIGHT (m)	TABLE ANGLE (Degree)	RAW VALUE (dBuV)	CORRECTION FACTOR (dB/m)
1	#5470.00	48.7 PK	68.2	-19.5	1.62 V	67	46.8	1.9
2	*5720.00	109.0 PK			1.62 V	67	106.8	2.2
3	*5720.00	99.4 AV			1.62 V	67	97.2	2.2
4	#5850.00	54.2 PK	68.2	-14.0	1.62 V	67	51.6	2.6
5	11440.00	46.8 PK	74.0	-27.2	2.12 V	181	33.1	13.7
6	11440.00	34.4 AV	54.0	-19.6	2.12 V	181	20.7	13.7
7	#17160.00	47.3 PK	68.2	-20.9	1.07 V	330	30.0	17.3

REMARKS:

1. Emission Level(dBuV/m) = Raw Value(dBuV) + Correction Factor(dB/m)
2. Correction Factor(dB/m) = Antenna Factor(dB/m) + Cable Factor(dB) – Pre-Amplifier Factor(dB)
3. Margin value = Emission Level – Limit value
4. The other emission levels were very low against the limit.
5. " * ": Fundamental frequency.
6. " # ": The radiated frequency is out of the restricted band.

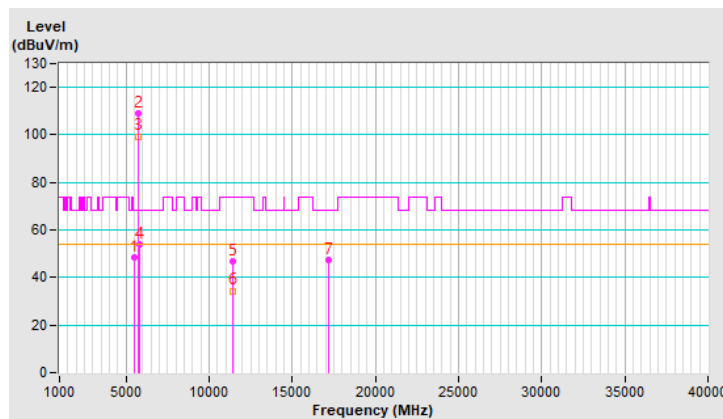

802.11ac (VHT20)

CHANNEL	TX Channel 52	DETECTOR FUNCTION	Peak (PK)
FREQUENCY RANGE	1GHz ~ 40GHz		Average (AV)

ANTENNA POLARITY & TEST DISTANCE: HORIZONTAL AT 3 M								
NO.	FREQ. (MHz)	EMISSION LEVEL (dBuV/m)	LIMIT (dBuV/m)	MARGIN (dB)	ANTENNA HEIGHT (m)	TABLE ANGLE (Degree)	RAW VALUE (dBuV)	CORRECTION FACTOR (dB/m)
1	5150.00	59.6 PK	74.0	-14.4	3.79 H	139	57.5	2.1
2	5150.00	48.4 AV	54.0	-5.6	3.79 H	139	46.3	2.1
3	*5260.00	108.2 PK			3.79 H	139	106.9	1.3
4	*5260.00	99.0 AV			3.79 H	139	97.7	1.3
5	#10520.00	45.8 PK	68.2	-22.4	2.49 H	271	33.0	12.8
6	15780.00	47.9 PK	74.0	-26.1	1.77 H	310	36.2	11.7
7	15780.00	35.6 AV	54.0	-18.4	1.77 H	310	23.9	11.7

REMARKS:

1. Emission Level(dBuV/m) = Raw Value(dBuV) + Correction Factor(dB/m)
2. Correction Factor(dB/m) = Antenna Factor(dB/m) + Cable Factor(dB) – Pre-Amplifier Factor(dB)
3. Margin value = Emission Level – Limit value
4. The other emission levels were very low against the limit.
5. " * ": Fundamental frequency.
6. " # ": The radiated frequency is out of the restricted band.

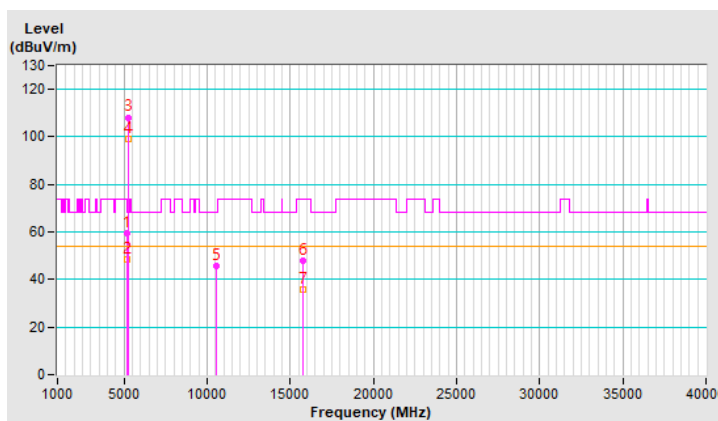

CHANNEL	TX Channel 52	DETECTOR FUNCTION	Peak (PK)
FREQUENCY RANGE	1GHz ~ 40GHz		Average (AV)

ANTENNA POLARITY & TEST DISTANCE: VERTICAL AT 3 M

NO.	FREQ. (MHz)	EMISSION LEVEL (dBuV/m)	LIMIT (dBuV/m)	MARGIN (dB)	ANTENNA HEIGHT (m)	TABLE ANGLE (Degree)	RAW VALUE (dBuV)	CORRECTION FACTOR (dB/m)
1	5150.00	58.8 PK	74.0	-15.2	1.58 V	63	56.7	2.1
2	5150.00	47.9 AV	54.0	-6.1	1.58 V	63	45.8	2.1
3	*5260.00	109.0 PK			1.58 V	63	107.7	1.3
4	*5260.00	99.6 AV			1.58 V	63	98.3	1.3
5	#10520.00	46.7 PK	68.2	-21.5	2.14 V	163	33.9	12.8
6	15780.00	46.9 PK	74.0	-27.1	1.10 V	327	35.2	11.7
7	15780.00	34.9 AV	54.0	-19.1	1.10 V	327	23.2	11.7

REMARKS:

1. Emission Level(dBuV/m) = Raw Value(dBuV) + Correction Factor(dB/m)
2. Correction Factor(dB/m) = Antenna Factor(dB/m) + Cable Factor(dB) – Pre-Amplifier Factor(dB)
3. Margin value = Emission Level – Limit value
4. The other emission levels were very low against the limit.
5. " * ": Fundamental frequency.
6. " # ": The radiated frequency is out of the restricted band.

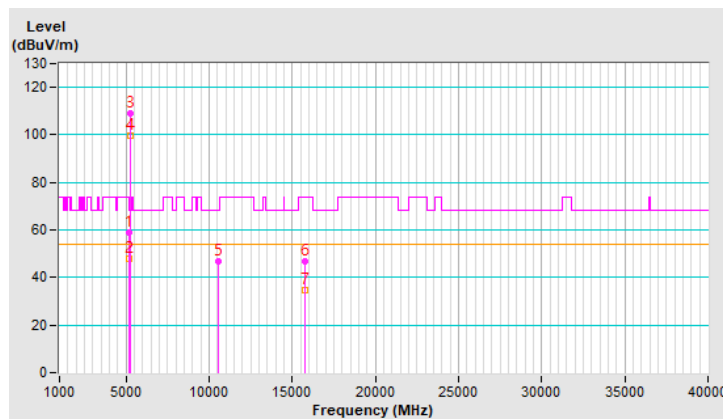

CHANNEL	TX Channel 60	DETECTOR FUNCTION	Peak (PK)
FREQUENCY RANGE	1GHz ~ 40GHz		Average (AV)

ANTENNA POLARITY & TEST DISTANCE: HORIZONTAL AT 3 M

NO.	FREQ. (MHz)	EMISSION LEVEL (dBuV/m)	LIMIT (dBuV/m)	MARGIN (dB)	ANTENNA HEIGHT (m)	TABLE ANGLE (Degree)	RAW VALUE (dBuV)	CORRECTION FACTOR (dB/m)
1	*5300.00	108.6 PK			3.82 H	144	107.2	1.4
2	*5300.00	99.2 AV			3.82 H	144	97.8	1.4
3	5350.00	60.9 PK	74.0	-13.1	3.82 H	144	59.4	1.5
4	5350.00	48.8 AV	54.0	-5.2	3.82 H	144	47.3	1.5
5	10600.00	45.9 PK	74.0	-28.1	2.49 H	266	32.8	13.1
6	10600.00	34.0 AV	54.0	-20.0	2.49 H	266	20.9	13.1
7	15900.00	47.4 PK	74.0	-26.6	1.70 H	304	35.9	11.5
8	15900.00	35.1 AV	54.0	-18.9	1.70 H	304	23.6	11.5

REMARKS:

1. Emission Level(dBuV/m) = Raw Value(dBuV) + Correction Factor(dB/m)
2. Correction Factor(dB/m) = Antenna Factor(dB/m) + Cable Factor(dB) – Pre-Amplifier Factor(dB)
3. Margin value = Emission Level – Limit value
4. The other emission levels were very low against the limit.
5. " * ": Fundamental frequency.

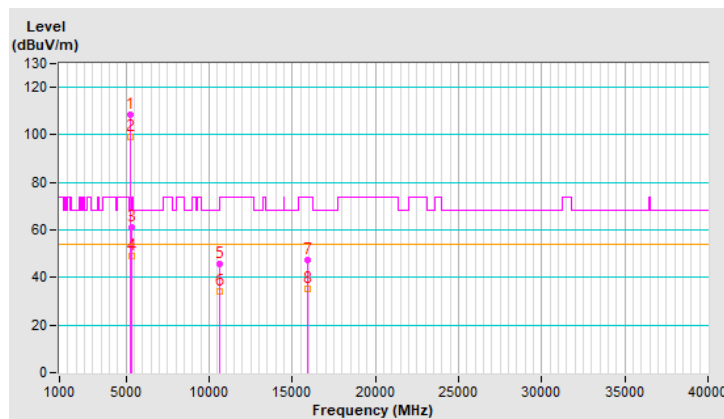

CHANNEL	TX Channel 60	DETECTOR FUNCTION	Peak (PK)
FREQUENCY RANGE	1GHz ~ 40GHz		Average (AV)

ANTENNA POLARITY & TEST DISTANCE: VERTICAL AT 3 M

NO.	FREQ. (MHz)	EMISSION LEVEL (dBuV/m)	LIMIT (dBuV/m)	MARGIN (dB)	ANTENNA HEIGHT (m)	TABLE ANGLE (Degree)	RAW VALUE (dBuV)	CORRECTION FACTOR (dB/m)
1	*5300.00	108.1 PK			1.67 V	58	106.7	1.4
2	*5300.00	98.9 AV			1.67 V	58	97.5	1.4
3	5350.00	60.4 PK	74.0	-13.6	1.67 V	58	58.9	1.5
4	5350.00	48.4 AV	54.0	-5.6	1.67 V	58	46.9	1.5
5	10600.00	46.8 PK	74.0	-27.2	2.13 V	181	33.7	13.1
6	10600.00	34.5 AV	54.0	-19.5	2.13 V	181	21.4	13.1
7	15900.00	47.8 PK	74.0	-26.2	1.05 V	331	36.3	11.5
8	15900.00	35.6 AV	54.0	-18.4	1.05 V	331	24.1	11.5

REMARKS:

1. Emission Level(dBuV/m) = Raw Value(dBuV) + Correction Factor(dB/m)
2. Correction Factor(dB/m) = Antenna Factor(dB/m) + Cable Factor(dB) – Pre-Amplifier Factor(dB)
3. Margin value = Emission Level – Limit value
4. The other emission levels were very low against the limit.
5. " * ": Fundamental frequency.

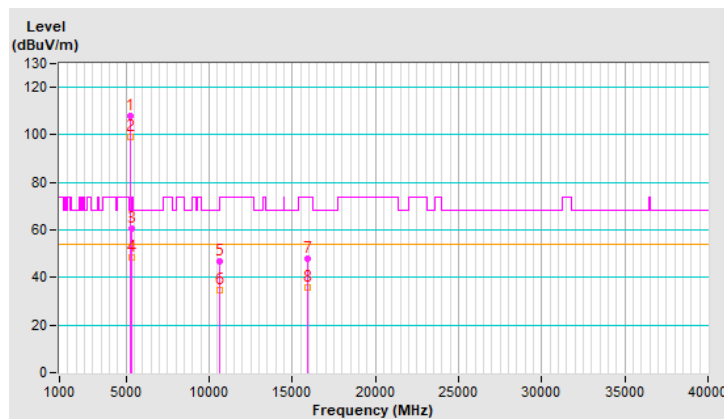

CHANNEL	TX Channel 64	DETECTOR FUNCTION	Peak (PK)
FREQUENCY RANGE	1GHz ~ 40GHz		Average (AV)

ANTENNA POLARITY & TEST DISTANCE: HORIZONTAL AT 3 M

NO.	FREQ. (MHz)	EMISSION LEVEL (dBuV/m)	LIMIT (dBuV/m)	MARGIN (dB)	ANTENNA HEIGHT (m)	TABLE ANGLE (Degree)	RAW VALUE (dBuV)	CORRECTION FACTOR (dB/m)
1	*5320.00	109.2 PK			3.85 H	139	107.7	1.5
2	*5320.00	99.8 AV			3.85 H	139	98.3	1.5
3	5350.00	65.2 PK	74.0	-8.8	3.85 H	139	63.7	1.5
4	5350.00	50.6 AV	54.0	-3.4	3.85 H	139	49.1	1.5
5	10640.00	46.0 PK	74.0	-28.0	2.66 H	261	32.8	13.2
6	10640.00	33.8 AV	54.0	-20.2	2.66 H	261	20.6	13.2
7	15960.00	47.6 PK	74.0	-26.4	1.66 H	297	36.1	11.5
8	15960.00	35.4 AV	54.0	-18.6	1.66 H	297	23.9	11.5

REMARKS:

1. Emission Level(dBuV/m) = Raw Value(dBuV) + Correction Factor(dB/m)
2. Correction Factor(dB/m) = Antenna Factor(dB/m) + Cable Factor(dB) – Pre-Amplifier Factor(dB)
3. Margin value = Emission Level – Limit value
4. The other emission levels were very low against the limit.
5. " * ": Fundamental frequency.

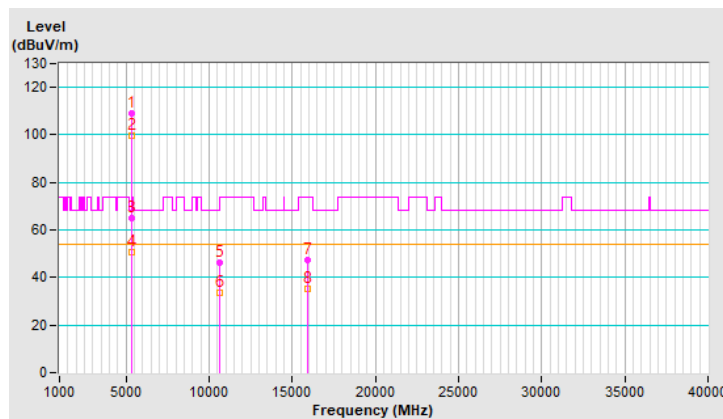

CHANNEL	TX Channel 64	DETECTOR FUNCTION	Peak (PK)
FREQUENCY RANGE	1GHz ~ 40GHz		Average (AV)

ANTENNA POLARITY & TEST DISTANCE: VERTICAL AT 3 M

NO.	FREQ. (MHz)	EMISSION LEVEL (dBuV/m)	LIMIT (dBuV/m)	MARGIN (dB)	ANTENNA HEIGHT (m)	TABLE ANGLE (Degree)	RAW VALUE (dBuV)	CORRECTION FACTOR (dB/m)
1	*5320.00	108.6 PK			1.64 V	78	107.1	1.5
2	*5320.00	99.1 AV			1.64 V	78	97.6	1.5
3	5350.00	65.4 PK	74.0	-8.6	1.64 V	78	63.9	1.5
4	5350.00	50.2 AV	54.0	-3.8	1.64 V	78	48.7	1.5
5	10640.00	46.0 PK	74.0	-28.0	2.17 V	159	32.8	13.2
6	10640.00	33.9 AV	54.0	-20.1	2.17 V	159	20.7	13.2
7	15960.00	47.9 PK	74.0	-26.1	1.05 V	341	36.4	11.5
8	15960.00	35.6 AV	54.0	-18.4	1.05 V	341	24.1	11.5

REMARKS:

1. Emission Level(dBuV/m) = Raw Value(dBuV) + Correction Factor(dB/m)
2. Correction Factor(dB/m) = Antenna Factor(dB/m) + Cable Factor(dB) – Pre-Amplifier Factor(dB)
3. Margin value = Emission Level – Limit value
4. The other emission levels were very low against the limit.
5. " * ": Fundamental frequency.

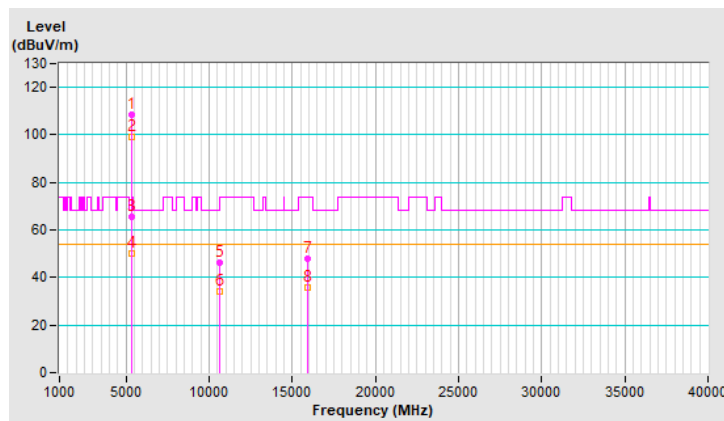

CHANNEL	TX Channel 100	DETECTOR FUNCTION	Peak (PK)
FREQUENCY RANGE	1GHz ~ 40GHz		Average (AV)

ANTENNA POLARITY & TEST DISTANCE: HORIZONTAL AT 3 M

NO.	FREQ. (MHz)	EMISSION LEVEL (dBuV/m)	LIMIT (dBuV/m)	MARGIN (dB)	ANTENNA HEIGHT (m)	TABLE ANGLE (Degree)	RAW VALUE (dBuV)	CORRECTION FACTOR (dB/m)
1	5460.00	60.7 PK	74.0	-13.3	3.45 H	144	58.8	1.9
2	5460.00	50.2 AV	54.0	-3.8	3.45 H	144	48.3	1.9
3	#5470.00	65.5 PK	68.2	-2.7	3.45 H	144	63.6	1.9
4	*5500.00	108.1 PK			3.45 H	144	106.2	1.9
5	*5500.00	98.9 AV			3.45 H	144	97.0	1.9
6	11000.00	46.1 PK	74.0	-27.9	2.66 H	262	32.5	13.6
7	11000.00	34.2 AV	54.0	-19.8	2.66 H	262	20.6	13.6
8	#16500.00	47.8 PK	68.2	-20.4	1.65 H	299	33.6	14.2

REMARKS:

1. Emission Level(dBuV/m) = Raw Value(dBuV) + Correction Factor(dB/m)
2. Correction Factor(dB/m) = Antenna Factor(dB/m) + Cable Factor(dB) – Pre-Amplifier Factor(dB)
3. Margin value = Emission Level – Limit value
4. The other emission levels were very low against the limit.
5. " * ": Fundamental frequency.
6. " # ": The radiated frequency is out of the restricted band.

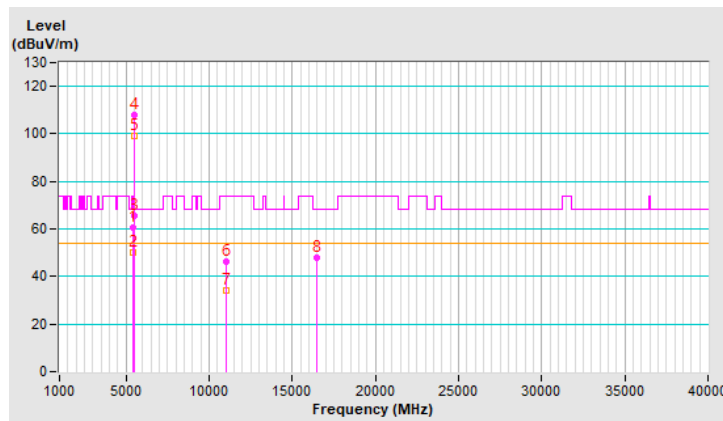

CHANNEL	TX Channel 100	DETECTOR FUNCTION	Peak (PK)
FREQUENCY RANGE	1GHz ~ 40GHz		Average (AV)

ANTENNA POLARITY & TEST DISTANCE: VERTICAL AT 3 M

NO.	FREQ. (MHz)	EMISSION LEVEL (dBuV/m)	LIMIT (dBuV/m)	MARGIN (dB)	ANTENNA HEIGHT (m)	TABLE ANGLE (Degree)	RAW VALUE (dBuV)	CORRECTION FACTOR (dB/m)
1	5460.00	60.4 PK	74.0	-13.6	1.62 V	68	58.5	1.9
2	5460.00	49.7 AV	54.0	-4.3	1.62 V	68	47.8	1.9
3	#5470.00	65.7 PK	68.2	-2.5	1.62 V	68	63.8	1.9
4	*5500.00	109.2 PK			1.62 V	68	107.3	1.9
5	*5500.00	99.7 AV			1.62 V	68	97.8	1.9
6	11000.00	46.9 PK	74.0	-27.1	2.12 V	161	33.3	13.6
7	11000.00	34.3 AV	54.0	-19.7	2.12 V	161	20.7	13.6
8	#16500.00	47.4 PK	68.2	-20.8	1.00 V	327	33.2	14.2

REMARKS:

1. Emission Level(dBuV/m) = Raw Value(dBuV) + Correction Factor(dB/m)
2. Correction Factor(dB/m) = Antenna Factor(dB/m) + Cable Factor(dB) – Pre-Amplifier Factor(dB)
3. Margin value = Emission Level – Limit value
4. The other emission levels were very low against the limit.
5. " * ": Fundamental frequency.
6. " # ": The radiated frequency is out of the restricted band.

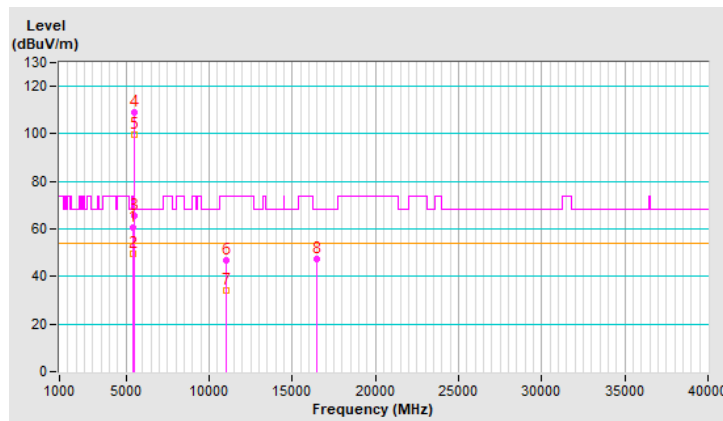

CHANNEL	TX Channel 116	DETECTOR FUNCTION	Peak (PK)
FREQUENCY RANGE	1GHz ~ 40GHz		Average (AV)

ANTENNA POLARITY & TEST DISTANCE: HORIZONTAL AT 3 M

NO.	FREQ. (MHz)	EMISSION LEVEL (dBuV/m)	LIMIT (dBuV/m)	MARGIN (dB)	ANTENNA HEIGHT (m)	TABLE ANGLE (Degree)	RAW VALUE (dBuV)	CORRECTION FACTOR (dB/m)
1	5460.00	58.1 PK	74.0	-15.9	3.46 H	138	56.2	1.9
2	5460.00	49.3 AV	54.0	-4.7	3.46 H	138	47.4	1.9
3	#5470.00	52.8 PK	68.2	-15.4	3.46 H	138	50.9	1.9
4	*5580.00	109.0 PK			3.46 H	138	106.9	2.1
5	*5580.00	99.7 AV			3.46 H	138	97.6	2.1
6	11160.00	46.5 PK	74.0	-27.5	2.62 H	244	33.8	12.7
7	11160.00	34.3 AV	54.0	-19.7	2.62 H	244	21.6	12.7
8	#16740.00	47.6 PK	68.2	-20.6	1.57 H	308	31.7	15.9

REMARKS:

1. Emission Level(dBuV/m) = Raw Value(dBuV) + Correction Factor(dB/m)
2. Correction Factor(dB/m) = Antenna Factor(dB/m) + Cable Factor(dB) – Pre-Amplifier Factor(dB)
3. Margin value = Emission Level – Limit value
4. The other emission levels were very low against the limit.
5. " * ": Fundamental frequency.
6. " # ": The radiated frequency is out of the restricted band.

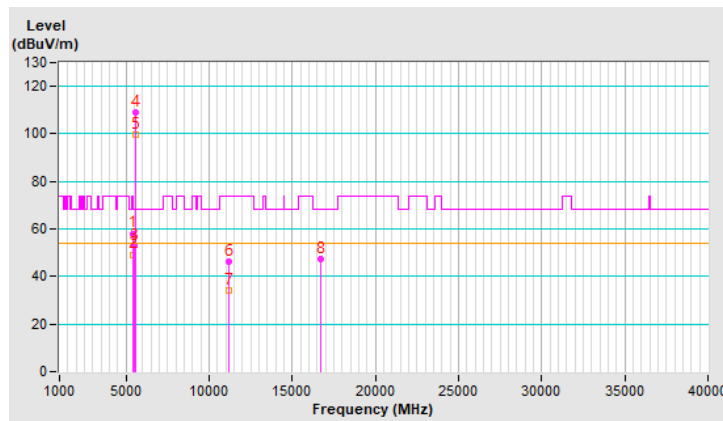

CHANNEL	TX Channel 116	DETECTOR FUNCTION	Peak (PK)
FREQUENCY RANGE	1GHz ~ 40GHz		Average (AV)

ANTENNA POLARITY & TEST DISTANCE: VERTICAL AT 3 M

NO.	FREQ. (MHz)	EMISSION LEVEL (dBuV/m)	LIMIT (dBuV/m)	MARGIN (dB)	ANTENNA HEIGHT (m)	TABLE ANGLE (Degree)	RAW VALUE (dBuV)	CORRECTION FACTOR (dB/m)
1	5460.00	58.9 PK	74.0	-15.1	1.68 V	79	57.0	1.9
2	5460.00	49.8 AV	54.0	-4.2	1.68 V	79	47.9	1.9
3	#5470.00	52.5 PK	68.2	-15.7	1.68 V	79	50.6	1.9
4	*5580.00	108.6 PK			1.68 V	79	106.5	2.1
5	*5580.00	99.3 AV			1.68 V	79	97.2	2.1
6	11160.00	46.1 PK	74.0	-27.9	2.09 V	176	33.4	12.7
7	11160.00	34.0 AV	54.0	-20.0	2.09 V	176	21.3	12.7
8	#16740.00	47.5 PK	68.2	-20.7	1.09 V	351	31.6	15.9

REMARKS:

1. Emission Level(dBuV/m) = Raw Value(dBuV) + Correction Factor(dB/m)
2. Correction Factor(dB/m) = Antenna Factor(dB/m) + Cable Factor(dB) – Pre-Amplifier Factor(dB)
3. Margin value = Emission Level – Limit value
4. The other emission levels were very low against the limit.
5. " * ": Fundamental frequency.
6. " # ": The radiated frequency is out of the restricted band.

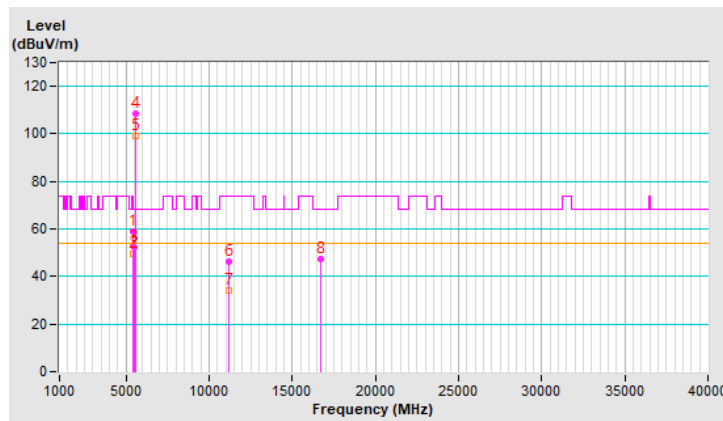

CHANNEL	TX Channel 140	DETECTOR FUNCTION	Peak (PK)
FREQUENCY RANGE	1GHz ~ 40GHz		Average (AV)

ANTENNA POLARITY & TEST DISTANCE: HORIZONTAL AT 3 M

NO.	FREQ. (MHz)	EMISSION LEVEL (dBuV/m)	LIMIT (dBuV/m)	MARGIN (dB)	ANTENNA HEIGHT (m)	TABLE ANGLE (Degree)	RAW VALUE (dBuV)	CORRECTION FACTOR (dB/m)
1	*5700.00	108.6 PK			3.29 H	141	106.4	2.2
2	*5700.00	99.6 AV			3.29 H	141	97.4	2.2
3	#5725.00	65.8 PK	68.2	-2.4	3.29 H	141	63.6	2.2
4	11400.00	46.5 PK	74.0	-27.5	2.62 H	249	33.0	13.5
5	11400.00	34.4 AV	54.0	-19.6	2.62 H	249	20.9	13.5
6	#17100.00	47.8 PK	68.2	-20.4	1.68 H	299	31.0	16.8

REMARKS:

1. Emission Level(dBuV/m) = Raw Value(dBuV) + Correction Factor(dB/m)
2. Correction Factor(dB/m) = Antenna Factor(dB/m) + Cable Factor(dB) – Pre-Amplifier Factor(dB)
3. Margin value = Emission Level – Limit value
4. The other emission levels were very low against the limit.
5. " * ": Fundamental frequency.
6. " # ": The radiated frequency is out of the restricted band.

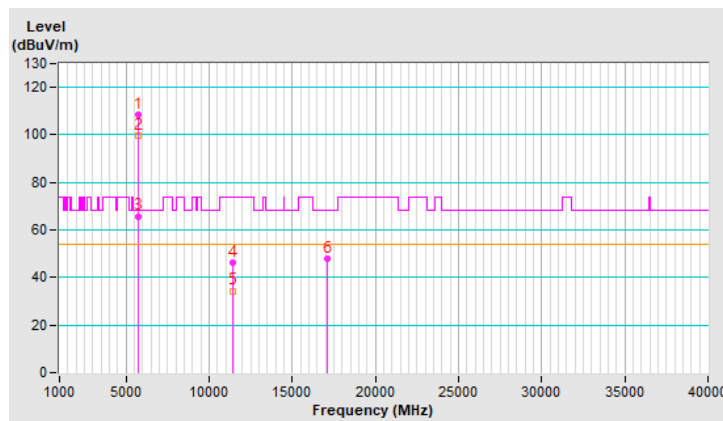

CHANNEL	TX Channel 140	DETECTOR FUNCTION	Peak (PK)
FREQUENCY RANGE	1GHz ~ 40GHz		Average (AV)

ANTENNA POLARITY & TEST DISTANCE: VERTICAL AT 3 M

NO.	FREQ. (MHz)	EMISSION LEVEL (dBuV/m)	LIMIT (dBuV/m)	MARGIN (dB)	ANTENNA HEIGHT (m)	TABLE ANGLE (Degree)	RAW VALUE (dBuV)	CORRECTION FACTOR (dB/m)
1	*5700.00	108.5 PK			1.65 V	82	106.3	2.2
2	*5700.00	99.1 AV			1.65 V	82	96.9	2.2
3	#5725.00	65.6 PK	68.2	-2.6	1.65 V	82	63.4	2.2
4	11400.00	46.3 PK	74.0	-27.7	2.19 V	176	32.8	13.5
5	11400.00	33.9 AV	54.0	-20.1	2.19 V	176	20.4	13.5
6	#17100.00	47.8 PK	68.2	-20.4	1.03 V	346	31.0	16.8

REMARKS:

1. Emission Level(dBuV/m) = Raw Value(dBuV) + Correction Factor(dB/m)
2. Correction Factor(dB/m) = Antenna Factor(dB/m) + Cable Factor(dB) – Pre-Amplifier Factor(dB)
3. Margin value = Emission Level – Limit value
4. The other emission levels were very low against the limit.
5. " * ": Fundamental frequency.
6. " # ": The radiated frequency is out of the restricted band.

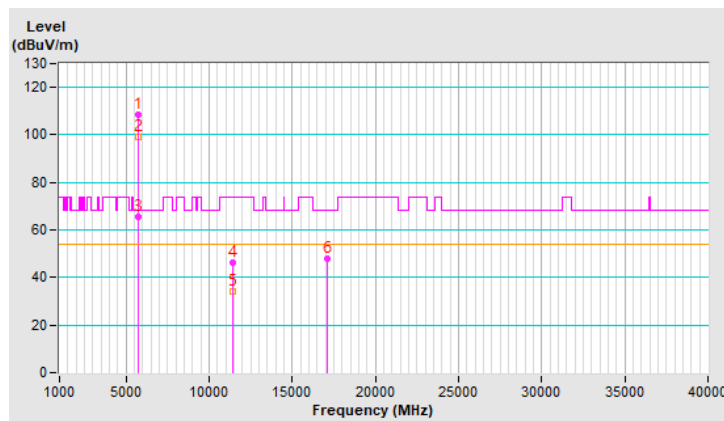

CHANNEL	TX Channel 144	DETECTOR FUNCTION	Peak (PK)
FREQUENCY RANGE	1GHz ~ 40GHz		Average (AV)

ANTENNA POLARITY & TEST DISTANCE: HORIZONTAL AT 3 M

NO.	FREQ. (MHz)	EMISSION LEVEL (dBuV/m)	LIMIT (dBuV/m)	MARGIN (dB)	ANTENNA HEIGHT (m)	TABLE ANGLE (Degree)	RAW VALUE (dBuV)	CORRECTION FACTOR (dB/m)
1	5460.00	48.1 PK	74.0	-25.9	3.66 H	137	46.2	1.9
2	5460.00	38.2 AV	54.0	-15.8	3.66 H	137	36.3	1.9
3	#5470.00	48.7 PK	68.2	-19.5	3.66 H	137	46.8	1.9
4	*5720.00	109.0 PK			3.66 H	137	106.8	2.2
5	*5720.00	99.7 AV			3.66 H	137	97.5	2.2
6	#5850.00	62.1 PK	68.2	-6.1	3.66 H	137	59.5	2.6
7	11440.00	46.2 PK	74.0	-27.8	2.66 H	246	32.5	13.7
8	11440.00	34.1 AV	54.0	-19.9	2.66 H	246	20.4	13.7
9	#17160.00	48.4 PK	68.2	-19.8	1.66 H	296	31.1	17.3

REMARKS:

1. Emission Level(dBuV/m) = Raw Value(dBuV) + Correction Factor(dB/m)
2. Correction Factor(dB/m) = Antenna Factor(dB/m) + Cable Factor(dB) – Pre-Amplifier Factor(dB)
3. Margin value = Emission Level – Limit value
4. The other emission levels were very low against the limit.
5. " * ": Fundamental frequency.
6. " # ": The radiated frequency is out of the restricted band.

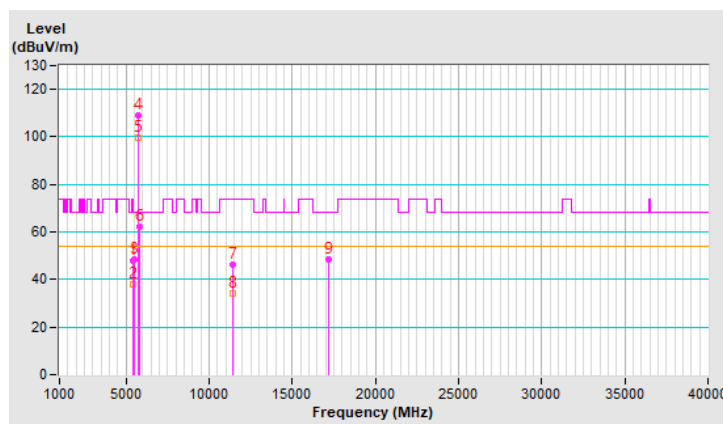

CHANNEL	TX Channel 144	DETECTOR FUNCTION	Peak (PK)
FREQUENCY RANGE	1GHz ~ 40GHz		Average (AV)

ANTENNA POLARITY & TEST DISTANCE: VERTICAL AT 3 M

NO.	FREQ. (MHz)	EMISSION LEVEL (dBuV/m)	LIMIT (dBuV/m)	MARGIN (dB)	ANTENNA HEIGHT (m)	TABLE ANGLE (Degree)	RAW VALUE (dBuV)	CORRECTION FACTOR (dB/m)
1	5460.00	47.7 PK	74.0	-26.3	1.59 V	83	45.8	1.9
2	5460.00	38.1 AV	54.0	-15.9	1.59 V	83	36.2	1.9
3	#5470.00	49.1 PK	68.2	-19.1	1.59 V	83	47.2	1.9
4	*5720.00	108.5 PK			1.59 V	83	106.3	2.2
5	*5720.00	99.3 AV			1.59 V	83	97.1	2.2
6	#5850.00	62.0 PK	68.2	-6.2	1.59 V	83	59.4	2.6
7	11440.00	46.8 PK	74.0	-27.2	2.12 V	174	33.1	13.7
8	11440.00	34.4 AV	54.0	-19.6	2.12 V	174	20.7	13.7
9	#17160.00	47.5 PK	68.2	-20.7	1.07 V	338	30.2	17.3

REMARKS:

1. Emission Level(dBuV/m) = Raw Value(dBuV) + Correction Factor(dB/m)
2. Correction Factor(dB/m) = Antenna Factor(dB/m) + Cable Factor(dB) – Pre-Amplifier Factor(dB)
3. Margin value = Emission Level – Limit value
4. The other emission levels were very low against the limit.
5. " * ": Fundamental frequency.
6. " # ": The radiated frequency is out of the restricted band.

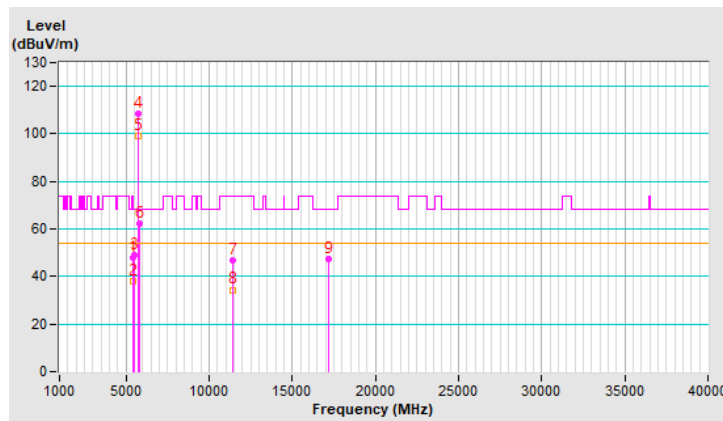

802.11ac (VHT40)

CHANNEL	TX Channel 54	DETECTOR FUNCTION	Peak (PK)
FREQUENCY RANGE	1GHz ~ 40GHz		Average (AV)

ANTENNA POLARITY & TEST DISTANCE: HORIZONTAL AT 3 M								
NO.	FREQ. (MHz)	EMISSION LEVEL (dBuV/m)	LIMIT (dBuV/m)	MARGIN (dB)	ANTENNA HEIGHT (m)	TABLE ANGLE (Degree)	RAW VALUE (dBuV)	CORRECTION FACTOR (dB/m)
1	5150.00	56.7 PK	74.0	-17.3	3.85 H	129	54.6	2.1
2	5150.00	47.2 AV	54.0	-6.8	3.85 H	129	45.1	2.1
3	*5270.00	111.5 PK			3.85 H	129	110.2	1.3
4	*5270.00	101.2 AV			3.85 H	129	99.9	1.3
5	5350.00	63.5 PK	74.0	-10.5	3.85 H	129	62.0	1.5
6	5350.00	52.4 AV	54.0	-1.6	3.85 H	129	50.9	1.5
7	#10540.00	46.0 PK	68.2	-22.2	2.49 H	227	33.1	12.9
8	15810.00	48.3 PK	74.0	-25.7	1.51 H	329	36.6	11.7
9	15810.00	35.9 AV	54.0	-18.1	1.51 H	329	24.2	11.7

REMARKS:

1. Emission Level(dBuV/m) = Raw Value(dBuV) + Correction Factor(dB/m)
2. Correction Factor(dB/m) = Antenna Factor(dB/m) + Cable Factor(dB) – Pre-Amplifier Factor(dB)
3. Margin value = Emission Level – Limit value
4. The other emission levels were very low against the limit.
5. " * ": Fundamental frequency.
6. " # ": The radiated frequency is out of the restricted band.

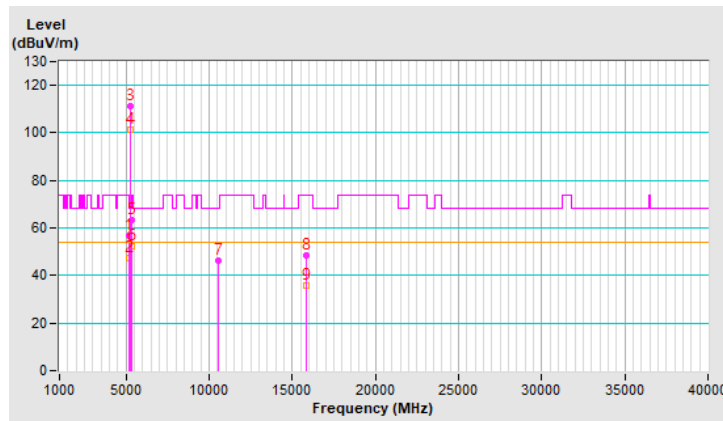

CHANNEL	TX Channel 54	DETECTOR FUNCTION	Peak (PK)
FREQUENCY RANGE	1GHz ~ 40GHz		Average (AV)

ANTENNA POLARITY & TEST DISTANCE: VERTICAL AT 3 M

NO.	FREQ. (MHz)	EMISSION LEVEL (dBuV/m)	LIMIT (dBuV/m)	MARGIN (dB)	ANTENNA HEIGHT (m)	TABLE ANGLE (Degree)	RAW VALUE (dBuV)	CORRECTION FACTOR (dB/m)
1	5150.00	56.7 PK	74.0	-17.3	1.62 V	69	54.6	2.1
2	5150.00	46.9 AV	54.0	-7.1	1.62 V	69	44.8	2.1
3	*5270.00	112.3 PK			1.62 V	69	111.0	1.3
4	*5270.00	102.1 AV			1.62 V	69	100.8	1.3
5	5350.00	64.0 PK	74.0	-10.0	1.62 V	69	62.5	1.5
6	5350.00	52.1 AV	54.0	-1.9	1.62 V	69	50.6	1.5
7	#10540.00	46.1 PK	68.2	-22.1	2.12 V	163	33.2	12.9
8	15810.00	47.8 PK	74.0	-26.2	1.04 V	353	36.1	11.7
9	15810.00	35.7 AV	54.0	-18.3	1.04 V	353	24.0	11.7

REMARKS:

1. Emission Level(dBuV/m) = Raw Value(dBuV) + Correction Factor(dB/m)
2. Correction Factor(dB/m) = Antenna Factor(dB/m) + Cable Factor(dB) – Pre-Amplifier Factor(dB)
3. Margin value = Emission Level – Limit value
4. The other emission levels were very low against the limit.
5. " * ": Fundamental frequency.
6. " # ": The radiated frequency is out of the restricted band.

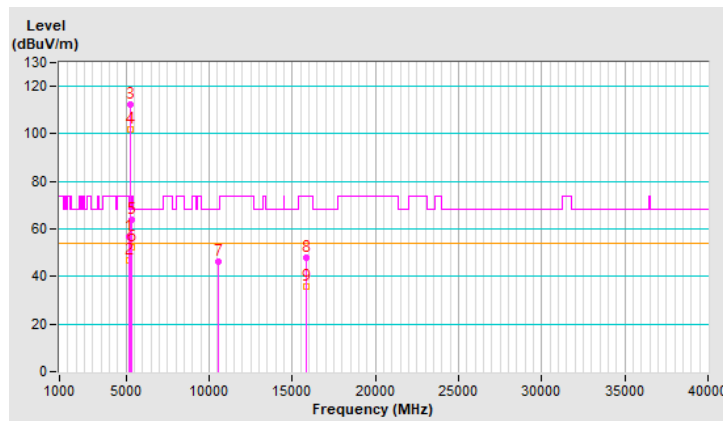

CHANNEL	TX Channel 62	DETECTOR FUNCTION	Peak (PK)
FREQUENCY RANGE	1GHz ~ 40GHz		Average (AV)

ANTENNA POLARITY & TEST DISTANCE: HORIZONTAL AT 3 M

NO.	FREQ. (MHz)	EMISSION LEVEL (dBuV/m)	LIMIT (dBuV/m)	MARGIN (dB)	ANTENNA HEIGHT (m)	TABLE ANGLE (Degree)	RAW VALUE (dBuV)	CORRECTION FACTOR (dB/m)
1	*5310.00	108.3 PK			2.65 H	3	106.9	1.4
2	*5310.00	99.0 AV			2.65 H	3	97.6	1.4
3	5350.00	71.0 PK	74.0	-3.0	2.65 H	3	69.5	1.5
4	5350.00	52.4 AV	54.0	-1.6	2.65 H	3	50.9	1.5
5	10620.00	46.2 PK	74.0	-27.8	2.57 H	241	33.1	13.1
6	10620.00	34.1 AV	54.0	-19.9	2.57 H	241	21.0	13.1
7	15930.00	47.9 PK	74.0	-26.1	1.55 H	302	36.4	11.5
8	15930.00	35.8 AV	54.0	-18.2	1.55 H	302	24.3	11.5

REMARKS:

1. Emission Level(dBuV/m) = Raw Value(dBuV) + Correction Factor(dB/m)
2. Correction Factor(dB/m) = Antenna Factor(dB/m) + Cable Factor(dB) – Pre-Amplifier Factor(dB)
3. Margin value = Emission Level – Limit value
4. The other emission levels were very low against the limit.
5. " * ": Fundamental frequency.

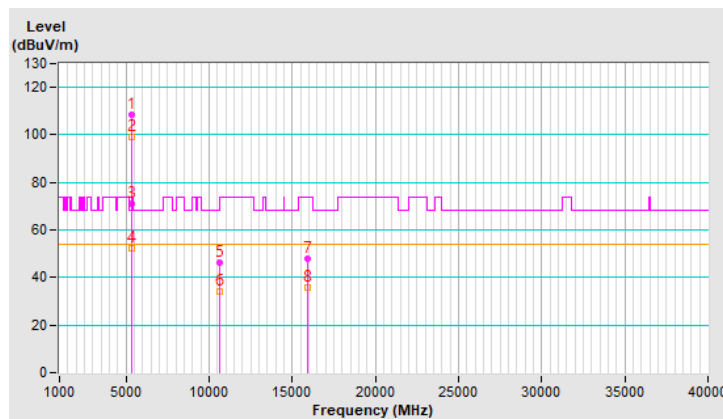

CHANNEL	TX Channel 62	DETECTOR FUNCTION	Peak (PK)
FREQUENCY RANGE	1GHz ~ 40GHz		Average (AV)

ANTENNA POLARITY & TEST DISTANCE: VERTICAL AT 3 M

NO.	FREQ. (MHz)	EMISSION LEVEL (dBuV/m)	LIMIT (dBuV/m)	MARGIN (dB)	ANTENNA HEIGHT (m)	TABLE ANGLE (Degree)	RAW VALUE (dBuV)	CORRECTION FACTOR (dB/m)
1	*5310.00	111.0 PK			1.63 V	73	109.6	1.4
2	*5310.00	100.5 AV			1.63 V	73	99.1	1.4
3	5350.00	72.6 PK	74.0	-1.4	1.63 V	73	71.1	1.5
4	5350.00	53.7 AV	54.0	-0.3	1.63 V	73	52.2	1.5
5	10620.00	46.5 PK	74.0	-27.5	2.15 V	177	33.4	13.1
6	10620.00	34.3 AV	54.0	-19.7	2.15 V	177	21.2	13.1
7	15930.00	47.6 PK	74.0	-26.4	1.11 V	333	36.1	11.5
8	15930.00	35.7 AV	54.0	-18.3	1.11 V	333	24.2	11.5

REMARKS:

1. Emission Level(dBuV/m) = Raw Value(dBuV) + Correction Factor(dB/m)
2. Correction Factor(dB/m) = Antenna Factor(dB/m) + Cable Factor(dB) – Pre-Amplifier Factor(dB)
3. Margin value = Emission Level – Limit value
4. The other emission levels were very low against the limit.
5. " * ": Fundamental frequency.

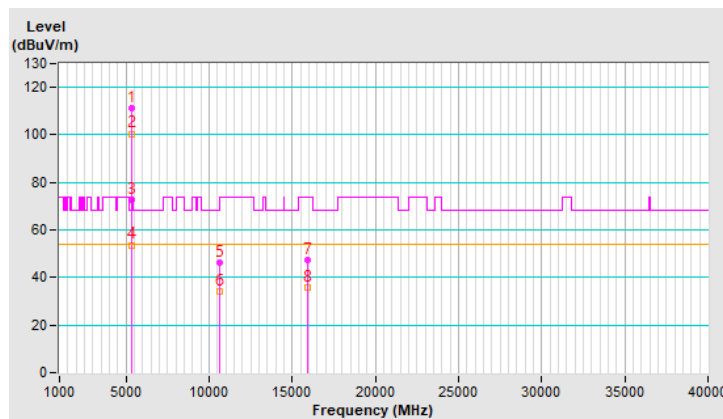

CHANNEL	TX Channel 102	DETECTOR FUNCTION	Peak (PK)
FREQUENCY RANGE	1GHz ~ 40GHz		Average (AV)

ANTENNA POLARITY & TEST DISTANCE: HORIZONTAL AT 3 M

NO.	FREQ. (MHz)	EMISSION LEVEL (dBuV/m)	LIMIT (dBuV/m)	MARGIN (dB)	ANTENNA HEIGHT (m)	TABLE ANGLE (Degree)	RAW VALUE (dBuV)	CORRECTION FACTOR (dB/m)
1	5460.00	62.3 PK	74.0	-11.7	3.48 H	141	60.4	1.9
2	5460.00	49.7 AV	54.0	-4.3	3.48 H	141	47.8	1.9
3	#5470.00	66.3 PK	68.2	-1.9	3.48 H	141	64.4	1.9
4	*5510.00	106.8 PK			3.48 H	141	104.9	1.9
5	*5510.00	99.1 AV			3.48 H	141	97.2	1.9
6	11020.00	45.6 PK	74.0	-28.4	2.41 H	238	32.2	13.4
7	11020.00	33.8 AV	54.0	-20.2	2.41 H	238	20.4	13.4
8	#16530.00	48.2 PK	68.2	-20.0	1.88 H	287	33.7	14.5

REMARKS:

1. Emission Level(dBuV/m) = Raw Value(dBuV) + Correction Factor(dB/m)
2. Correction Factor(dB/m) = Antenna Factor(dB/m) + Cable Factor(dB) – Pre-Amplifier Factor(dB)
3. Margin value = Emission Level – Limit value
4. The other emission levels were very low against the limit.
5. " * ": Fundamental frequency.
6. " # ": The radiated frequency is out of the restricted band.

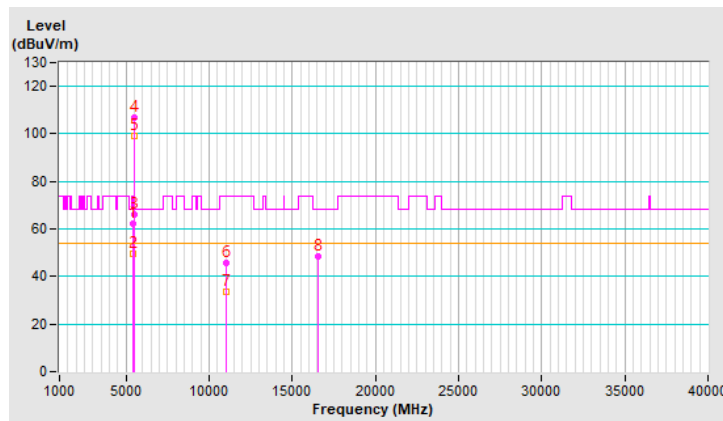

CHANNEL	TX Channel 102	DETECTOR FUNCTION	Peak (PK)
FREQUENCY RANGE	1GHz ~ 40GHz		Average (AV)

ANTENNA POLARITY & TEST DISTANCE: VERTICAL AT 3 M

NO.	FREQ. (MHz)	EMISSION LEVEL (dBuV/m)	LIMIT (dBuV/m)	MARGIN (dB)	ANTENNA HEIGHT (m)	TABLE ANGLE (Degree)	RAW VALUE (dBuV)	CORRECTION FACTOR (dB/m)
1	5460.00	64.9 PK	74.0	-9.1	1.59 V	3	63.0	1.9
2	5460.00	45.5 AV	54.0	-8.5	1.59 V	3	43.6	1.9
3	#5470.00	67.8 PK	68.2	-0.4	1.59 V	3	65.9	1.9
4	*5510.00	110.7 PK			1.59 V	3	108.8	1.9
5	*5510.00	100.0 AV			1.59 V	3	98.1	1.9
6	11020.00	50.2 PK	74.0	-23.8	2.10 V	156	36.8	13.4
7	11020.00	37.2 AV	54.0	-16.8	2.10 V	156	23.8	13.4
8	#16530.00	52.4 PK	68.2	-15.8	1.10 V	356	37.9	14.5

REMARKS:

1. Emission Level(dBuV/m) = Raw Value(dBuV) + Correction Factor(dB/m)
2. Correction Factor(dB/m) = Antenna Factor(dB/m) + Cable Factor(dB) – Pre-Amplifier Factor(dB)
3. Margin value = Emission Level – Limit value
4. The other emission levels were very low against the limit.
5. " * ": Fundamental frequency.
6. " # ": The radiated frequency is out of the restricted band.

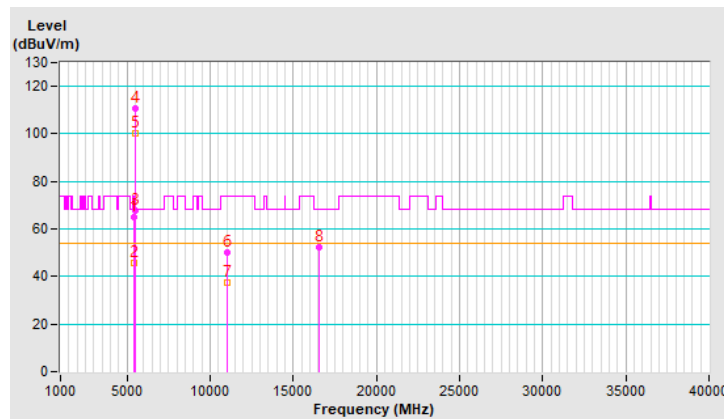

CHANNEL	TX Channel 110	DETECTOR FUNCTION	Peak (PK)
FREQUENCY RANGE	1GHz ~ 40GHz		Average (AV)

ANTENNA POLARITY & TEST DISTANCE: HORIZONTAL AT 3 M

NO.	FREQ. (MHz)	EMISSION LEVEL (dBuV/m)	LIMIT (dBuV/m)	MARGIN (dB)	ANTENNA HEIGHT (m)	TABLE ANGLE (Degree)	RAW VALUE (dBuV)	CORRECTION FACTOR (dB/m)
1	5460.00	60.4 PK	74.0	-13.6	3.27 H	138	58.5	1.9
2	5460.00	49.9 AV	54.0	-4.1	3.27 H	138	48.0	1.9
3	#5470.00	63.5 PK	68.2	-4.7	3.27 H	138	61.6	1.9
4	*5550.00	111.8 PK			3.27 H	138	109.8	2.0
5	*5550.00	101.4 AV			3.27 H	138	99.4	2.0
6	11100.00	46.5 PK	74.0	-27.5	2.44 H	218	33.6	12.9
7	11100.00	34.4 AV	54.0	-19.6	2.44 H	218	21.5	12.9
8	#16650.00	47.7 PK	68.2	-20.5	1.89 H	273	32.5	15.2

REMARKS:

1. Emission Level(dBuV/m) = Raw Value(dBuV) + Correction Factor(dB/m)
2. Correction Factor(dB/m) = Antenna Factor(dB/m) + Cable Factor(dB) – Pre-Amplifier Factor(dB)
3. Margin value = Emission Level – Limit value
4. The other emission levels were very low against the limit.
5. " * ": Fundamental frequency.
6. " # ": The radiated frequency is out of the restricted band.

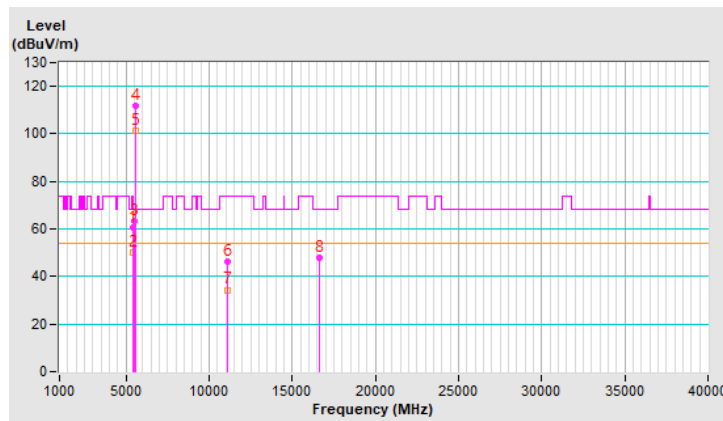

CHANNEL	TX Channel 110	DETECTOR FUNCTION	Peak (PK)
FREQUENCY RANGE	1GHz ~ 40GHz		Average (AV)

ANTENNA POLARITY & TEST DISTANCE: VERTICAL AT 3 M

NO.	FREQ. (MHz)	EMISSION LEVEL (dBuV/m)	LIMIT (dBuV/m)	MARGIN (dB)	ANTENNA HEIGHT (m)	TABLE ANGLE (Degree)	RAW VALUE (dBuV)	CORRECTION FACTOR (dB/m)
1	5460.00	60.2 PK	74.0	-13.8	1.67 V	60	58.3	1.9
2	5460.00	49.9 AV	54.0	-4.1	1.67 V	60	48.0	1.9
3	#5470.00	64.0 PK	68.2	-4.2	1.67 V	60	62.1	1.9
4	*5550.00	112.6 PK			1.67 V	60	110.6	2.0
5	*5550.00	102.4 AV			1.67 V	60	100.4	2.0
6	11100.00	46.3 PK	74.0	-27.7	2.13 V	168	33.4	12.9
7	11100.00	33.9 AV	54.0	-20.1	2.13 V	168	21.0	12.9
8	#16650.00	47.7 PK	68.2	-20.5	1.08 V	329	32.5	15.2

REMARKS:

1. Emission Level(dBuV/m) = Raw Value(dBuV) + Correction Factor(dB/m)
2. Correction Factor(dB/m) = Antenna Factor(dB/m) + Cable Factor(dB) – Pre-Amplifier Factor(dB)
3. Margin value = Emission Level – Limit value
4. The other emission levels were very low against the limit.
5. " * ": Fundamental frequency.
6. " # ": The radiated frequency is out of the restricted band.

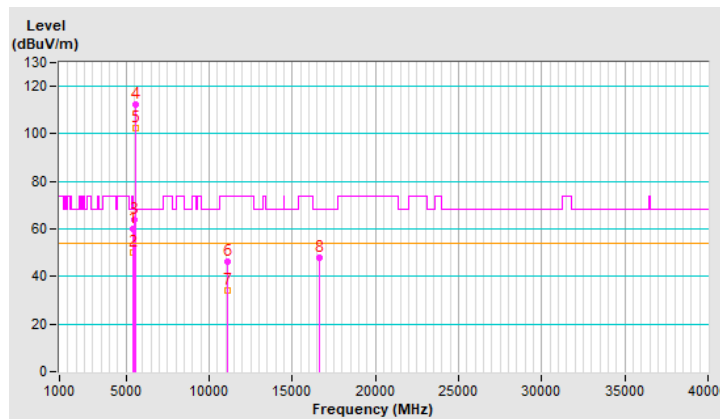

CHANNEL	TX Channel 134	DETECTOR FUNCTION	Peak (PK)
FREQUENCY RANGE	1GHz ~ 40GHz		Average (AV)

ANTENNA POLARITY & TEST DISTANCE: HORIZONTAL AT 3 M

NO.	FREQ. (MHz)	EMISSION LEVEL (dBuV/m)	LIMIT (dBuV/m)	MARGIN (dB)	ANTENNA HEIGHT (m)	TABLE ANGLE (Degree)	RAW VALUE (dBuV)	CORRECTION FACTOR (dB/m)
1	*5670.00	111.8 PK			3.37 H	141	109.7	2.1
2	*5670.00	101.2 AV			3.37 H	141	99.1	2.1
3	#5725.00	66.6 PK	68.2	-1.6	3.37 H	141	64.4	2.2
4	11340.00	46.0 PK	74.0	-28.0	2.31 H	218	33.0	13.0
5	11340.00	34.0 AV	54.0	-20.0	2.31 H	218	21.0	13.0
6	#17010.00	46.9 PK	68.2	-21.3	1.86 H	299	30.0	16.9

REMARKS:

1. Emission Level(dBuV/m) = Raw Value(dBuV) + Correction Factor(dB/m)
2. Correction Factor(dB/m) = Antenna Factor(dB/m) + Cable Factor(dB) – Pre-Amplifier Factor(dB)
3. Margin value = Emission Level – Limit value
4. The other emission levels were very low against the limit.
5. " * ": Fundamental frequency.
6. " # ": The radiated frequency is out of the restricted band.

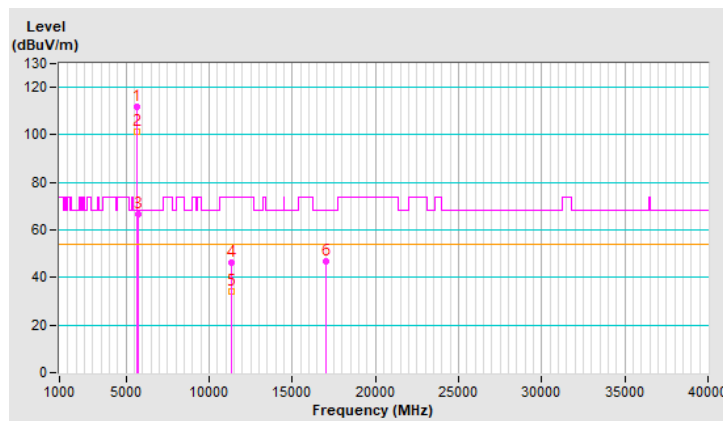

CHANNEL	TX Channel 134	DETECTOR FUNCTION	Peak (PK)
FREQUENCY RANGE	1GHz ~ 40GHz		Average (AV)

ANTENNA POLARITY & TEST DISTANCE: VERTICAL AT 3 M

NO.	FREQ. (MHz)	EMISSION LEVEL (dBuV/m)	LIMIT (dBuV/m)	MARGIN (dB)	ANTENNA HEIGHT (m)	TABLE ANGLE (Degree)	RAW VALUE (dBuV)	CORRECTION FACTOR (dB/m)
1	*5670.00	111.8 PK			1.60 V	67	109.7	2.1
2	*5670.00	101.6 AV			1.60 V	67	99.5	2.1
3	#5725.00	65.8 PK	68.2	-2.4	1.60 V	67	63.6	2.2
4	11340.00	45.7 PK	74.0	-28.3	2.09 V	156	32.7	13.0
5	11340.00	33.5 AV	54.0	-20.5	2.09 V	156	20.5	13.0
6	#17010.00	46.6 PK	68.2	-21.6	1.00 V	343	29.7	16.9

REMARKS:

1. Emission Level(dBuV/m) = Raw Value(dBuV) + Correction Factor(dB/m)
2. Correction Factor(dB/m) = Antenna Factor(dB/m) + Cable Factor(dB) – Pre-Amplifier Factor(dB)
3. Margin value = Emission Level – Limit value
4. The other emission levels were very low against the limit.
5. " * ": Fundamental frequency.
6. " # ": The radiated frequency is out of the restricted band.

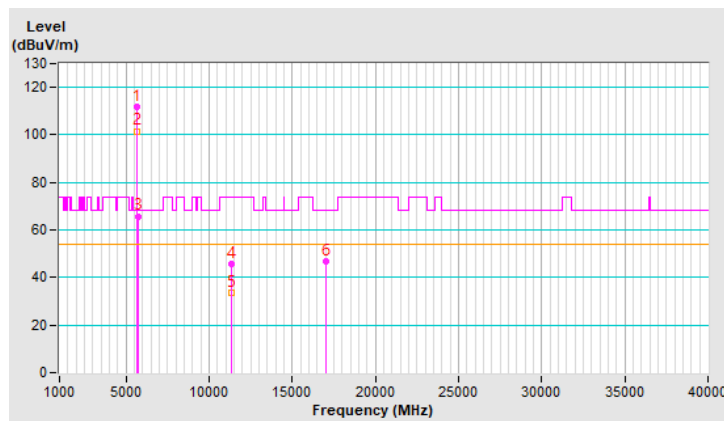

CHANNEL	TX Channel 142	DETECTOR FUNCTION	Peak (PK)
FREQUENCY RANGE	1GHz ~ 40GHz		Average (AV)

ANTENNA POLARITY & TEST DISTANCE: HORIZONTAL AT 3 M

NO.	FREQ. (MHz)	EMISSION LEVEL (dBuV/m)	LIMIT (dBuV/m)	MARGIN (dB)	ANTENNA HEIGHT (m)	TABLE ANGLE (Degree)	RAW VALUE (dBuV)	CORRECTION FACTOR (dB/m)
1	5460.00	49.5 PK	74.0	-24.5	3.59 H	141	47.6	1.9
2	5460.00	40.9 AV	54.0	-13.1	3.59 H	141	39.0	1.9
3	#5470.00	51.5 PK	68.2	-16.7	3.59 H	141	49.6	1.9
4	*5710.00	112.0 PK			3.59 H	141	109.8	2.2
5	*5710.00	101.7 AV			3.59 H	141	99.5	2.2
6	#5850.00	62.8 PK	68.2	-5.4	3.59 H	141	60.2	2.6
7	11420.00	46.0 PK	74.0	-28.0	2.51 H	233	32.4	13.6
8	11420.00	34.0 AV	54.0	-20.0	2.51 H	233	20.4	13.6
9	#17130.00	47.7 PK	68.2	-20.5	1.88 H	298	30.6	17.1

REMARKS:

1. Emission Level(dBuV/m) = Raw Value(dBuV) + Correction Factor(dB/m)
2. Correction Factor(dB/m) = Antenna Factor(dB/m) + Cable Factor(dB) – Pre-Amplifier Factor(dB)
3. Margin value = Emission Level – Limit value
4. The other emission levels were very low against the limit.
5. " * ": Fundamental frequency.
6. " # ": The radiated frequency is out of the restricted band.

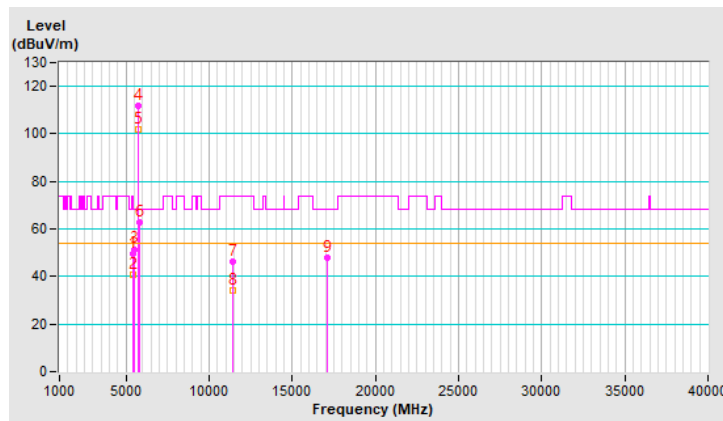

CHANNEL	TX Channel 142	DETECTOR FUNCTION	Peak (PK)
FREQUENCY RANGE	1GHz ~ 40GHz		Average (AV)

ANTENNA POLARITY & TEST DISTANCE: VERTICAL AT 3 M

NO.	FREQ. (MHz)	EMISSION LEVEL (dBuV/m)	LIMIT (dBuV/m)	MARGIN (dB)	ANTENNA HEIGHT (m)	TABLE ANGLE (Degree)	RAW VALUE (dBuV)	CORRECTION FACTOR (dB/m)
1	5460.00	49.7 PK	74.0	-24.3	1.69 V	68	47.8	1.9
2	5460.00	42.3 AV	54.0	-11.7	1.69 V	68	40.4	1.9
3	#5470.00	52.1 PK	68.2	-16.1	1.69 V	68	50.2	1.9
4	*5710.00	112.6 PK			1.69 V	68	110.4	2.2
5	*5710.00	102.5 AV			1.69 V	68	100.3	2.2
6	#5850.00	62.5 PK	68.2	-5.7	1.69 V	68	59.9	2.6
7	11420.00	46.9 PK	74.0	-27.1	2.18 V	168	33.3	13.6
8	11420.00	34.3 AV	54.0	-19.7	2.18 V	168	20.7	13.6
9	#17130.00	47.7 PK	68.2	-20.5	1.08 V	351	30.6	17.1

REMARKS:

1. Emission Level(dBuV/m) = Raw Value(dBuV) + Correction Factor(dB/m)
2. Correction Factor(dB/m) = Antenna Factor(dB/m) + Cable Factor(dB) – Pre-Amplifier Factor(dB)
3. Margin value = Emission Level – Limit value
4. The other emission levels were very low against the limit.
5. " * ": Fundamental frequency.
6. " # ": The radiated frequency is out of the restricted band.

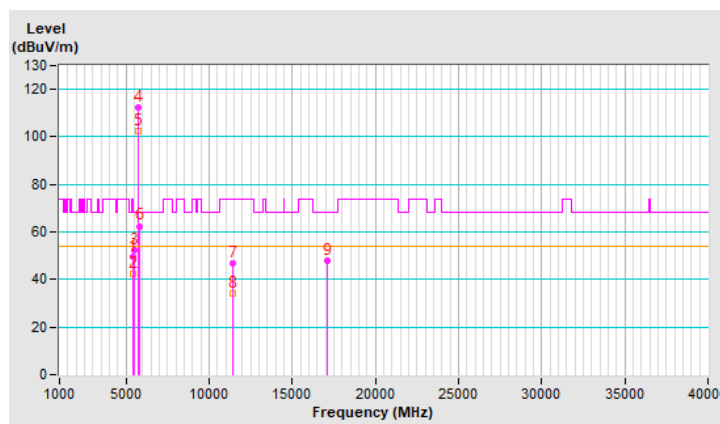

802.11ac (VHT80)

CHANNEL	TX Channel 58	DETECTOR FUNCTION	Peak (PK)
FREQUENCY RANGE	1GHz ~ 40GHz		Average (AV)

ANTENNA POLARITY & TEST DISTANCE: HORIZONTAL AT 3 M								
NO.	FREQ. (MHz)	EMISSION LEVEL (dBuV/m)	LIMIT (dBuV/m)	MARGIN (dB)	ANTENNA HEIGHT (m)	TABLE ANGLE (Degree)	RAW VALUE (dBuV)	CORRECTION FACTOR (dB/m)
1	5150.00	52.8 PK	74.0	-21.2	3.79 H	141	50.7	2.1
2	5150.00	41.9 AV	54.0	-12.1	3.79 H	141	39.8	2.1
3	*5290.00	103.6 PK			3.79 H	141	102.2	1.4
4	*5290.00	94.2 AV			3.79 H	141	92.8	1.4
5	5350.00	64.2 PK	74.0	-9.8	3.79 H	141	62.7	1.5
6	5350.00	51.7 AV	54.0	-2.3	3.79 H	141	50.2	1.5
7	#10580.00	45.5 PK	68.2	-22.7	2.58 H	241	32.6	12.9
8	15870.00	47.3 PK	74.0	-26.7	1.61 H	322	35.7	11.6
9	15870.00	35.3 AV	54.0	-18.7	1.61 H	322	23.7	11.6

REMARKS:

1. Emission Level(dBuV/m) = Raw Value(dBuV) + Correction Factor(dB/m)
2. Correction Factor(dB/m) = Antenna Factor(dB/m) + Cable Factor(dB) – Pre-Amplifier Factor(dB)
3. Margin value = Emission Level – Limit value
4. The other emission levels were very low against the limit.
5. " * ": Fundamental frequency.
6. " # ": The radiated frequency is out of the restricted band.

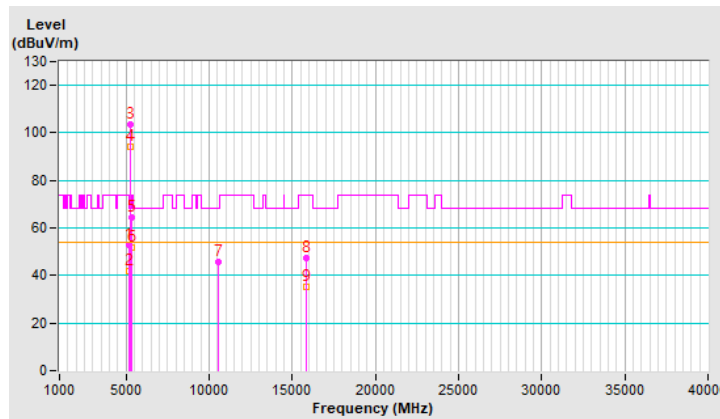

CHANNEL	TX Channel 58	DETECTOR FUNCTION	Peak (PK)
FREQUENCY RANGE	1GHz ~ 40GHz		Average (AV)

ANTENNA POLARITY & TEST DISTANCE: VERTICAL AT 3 M

NO.	FREQ. (MHz)	EMISSION LEVEL (dBuV/m)	LIMIT (dBuV/m)	MARGIN (dB)	ANTENNA HEIGHT (m)	TABLE ANGLE (Degree)	RAW VALUE (dBuV)	CORRECTION FACTOR (dB/m)
1	5150.00	53.7 PK	74.0	-20.3	1.57 V	48	51.6	2.1
2	5150.00	43.0 AV	54.0	-11.0	1.57 V	48	40.9	2.1
3	*5290.00	106.8 PK			1.57 V	48	105.4	1.4
4	*5290.00	96.8 AV			1.57 V	48	95.4	1.4
5	5350.00	68.6 PK	74.0	-5.4	1.57 V	48	67.1	1.5
6	5350.00	53.8 AV	54.0	-0.2	1.57 V	48	52.3	1.5
7	#10580.00	46.2 PK	68.2	-22.0	2.17 V	178	33.3	12.9
8	15870.00	47.7 PK	74.0	-26.3	1.10 V	338	36.1	11.6
9	15870.00	35.4 AV	54.0	-18.6	1.10 V	338	23.8	11.6

REMARKS:

1. Emission Level(dBuV/m) = Raw Value(dBuV) + Correction Factor(dB/m)
2. Correction Factor(dB/m) = Antenna Factor(dB/m) + Cable Factor(dB) – Pre-Amplifier Factor(dB)
3. Margin value = Emission Level – Limit value
4. The other emission levels were very low against the limit.
5. " * ": Fundamental frequency.
6. " # ": The radiated frequency is out of the restricted band.

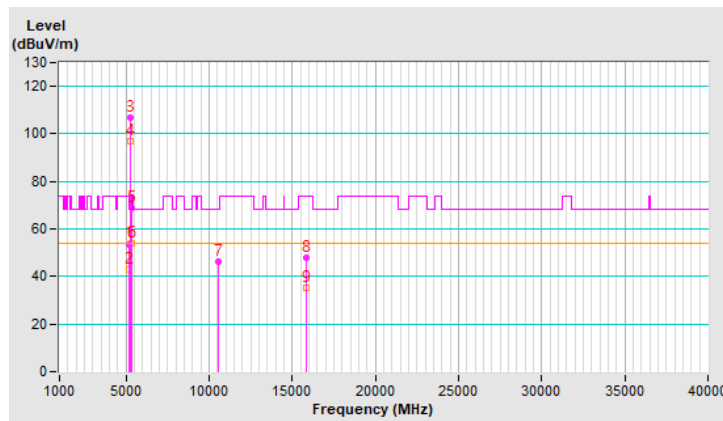

CHANNEL	TX Channel 106	DETECTOR FUNCTION	Peak (PK)
FREQUENCY RANGE	1GHz ~ 40GHz		Average (AV)

ANTENNA POLARITY & TEST DISTANCE: HORIZONTAL AT 3 M

NO.	FREQ. (MHz)	EMISSION LEVEL (dBuV/m)	LIMIT (dBuV/m)	MARGIN (dB)	ANTENNA HEIGHT (m)	TABLE ANGLE (Degree)	RAW VALUE (dBuV)	CORRECTION FACTOR (dB/m)
1	5460.00	66.7 PK	74.0	-7.3	3.87 H	146	64.8	1.9
2	5460.00	53.3 AV	54.0	-0.7	3.87 H	146	51.4	1.9
3	#5470.00	67.5 PK	68.2	-0.7	3.87 H	146	65.6	1.9
4	*5530.00	102.5 PK			3.87 H	146	100.5	2.0
5	*5530.00	93.3 AV			3.87 H	146	91.3	2.0
6	11060.00	45.7 PK	74.0	-28.3	2.57 H	241	32.5	13.2
7	11060.00	33.8 AV	54.0	-20.2	2.57 H	241	20.6	13.2
8	#16590.00	47.6 PK	68.2	-20.6	1.58 H	322	32.8	14.8

REMARKS:

1. Emission Level(dBuV/m) = Raw Value(dBuV) + Correction Factor(dB/m)
2. Correction Factor(dB/m) = Antenna Factor(dB/m) + Cable Factor(dB) – Pre-Amplifier Factor(dB)
3. Margin value = Emission Level – Limit value
4. The other emission levels were very low against the limit.
5. " * ": Fundamental frequency.
6. " # ": The radiated frequency is out of the restricted band.

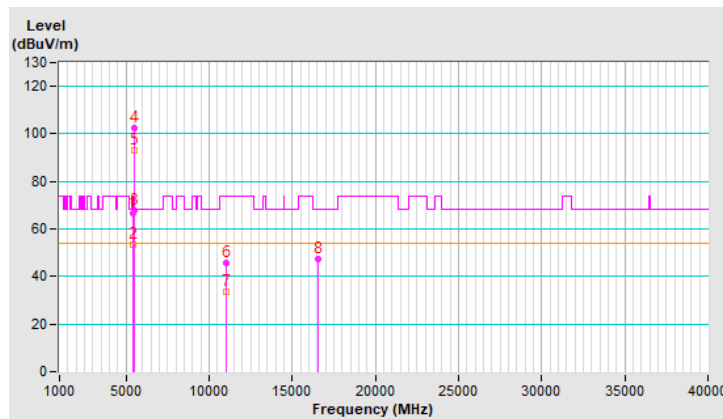

CHANNEL	TX Channel 106	DETECTOR FUNCTION	Peak (PK)
FREQUENCY RANGE	1GHz ~ 40GHz		Average (AV)

ANTENNA POLARITY & TEST DISTANCE: VERTICAL AT 3 M

NO.	FREQ. (MHz)	EMISSION LEVEL (dBuV/m)	LIMIT (dBuV/m)	MARGIN (dB)	ANTENNA HEIGHT (m)	TABLE ANGLE (Degree)	RAW VALUE (dBuV)	CORRECTION FACTOR (dB/m)
1	5460.00	66.3 PK	74.0	-7.7	1.55 V	4	64.4	1.9
2	5460.00	53.9 AV	54.0	-0.1	1.55 V	4	52.0	1.9
3	#5470.00	68.0 PK	68.2	-0.2	1.55 V	4	66.1	1.9
4	*5530.00	106.7 PK			1.55 V	4	104.7	2.0
5	*5530.00	97.4 AV			1.55 V	4	95.4	2.0
6	11060.00	46.6 PK	74.0	-27.4	2.09 V	171	33.4	13.2
7	11060.00	34.0 AV	54.0	-20.0	2.09 V	171	20.8	13.2
8	#16590.00	47.5 PK	68.2	-20.7	1.01 V	329	32.7	14.8

REMARKS:

1. Emission Level(dBuV/m) = Raw Value(dBuV) + Correction Factor(dB/m)
2. Correction Factor(dB/m) = Antenna Factor(dB/m) + Cable Factor(dB) – Pre-Amplifier Factor(dB)
3. Margin value = Emission Level – Limit value
4. The other emission levels were very low against the limit.
5. " * ": Fundamental frequency.
6. " # ": The radiated frequency is out of the restricted band.

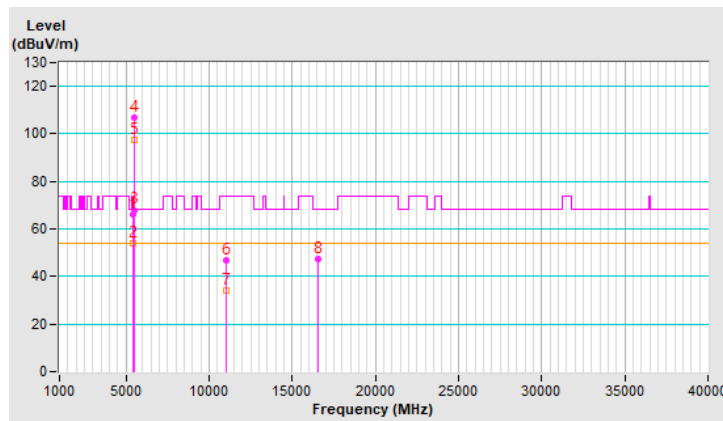

CHANNEL	TX Channel 122	DETECTOR FUNCTION	Peak (PK)
FREQUENCY RANGE	1GHz ~ 40GHz		Average (AV)

ANTENNA POLARITY & TEST DISTANCE: HORIZONTAL AT 3 M

NO.	FREQ. (MHz)	EMISSION LEVEL (dBuV/m)	LIMIT (dBuV/m)	MARGIN (dB)	ANTENNA HEIGHT (m)	TABLE ANGLE (Degree)	RAW VALUE (dBuV)	CORRECTION FACTOR (dB/m)
1	5460.00	60.3 PK	74.0	-13.7	3.55 H	139	58.4	1.9
2	5460.00	49.8 AV	54.0	-4.2	3.55 H	139	47.9	1.9
3	#5470.00	61.3 PK	68.2	-6.9	3.55 H	139	59.4	1.9
4	*5610.00	105.5 PK			3.55 H	139	103.4	2.1
5	*5610.00	97.5 AV			3.55 H	139	95.4	2.1
6	#5725.00	66.6 PK	68.2	-1.6	3.55 H	139	64.4	2.2
7	11220.00	46.0 PK	74.0	-28.0	2.49 H	223	33.4	12.6
8	11220.00	34.3 AV	54.0	-19.7	2.49 H	223	21.7	12.6
9	#16830.00	48.2 PK	68.2	-20.0	1.66 H	302	31.9	16.3

REMARKS:

1. Emission Level(dBuV/m) = Raw Value(dBuV) + Correction Factor(dB/m)
2. Correction Factor(dB/m) = Antenna Factor(dB/m) + Cable Factor(dB) – Pre-Amplifier Factor(dB)
3. Margin value = Emission Level – Limit value
4. The other emission levels were very low against the limit.
5. " * ": Fundamental frequency.
6. " # ": The radiated frequency is out of the restricted band.

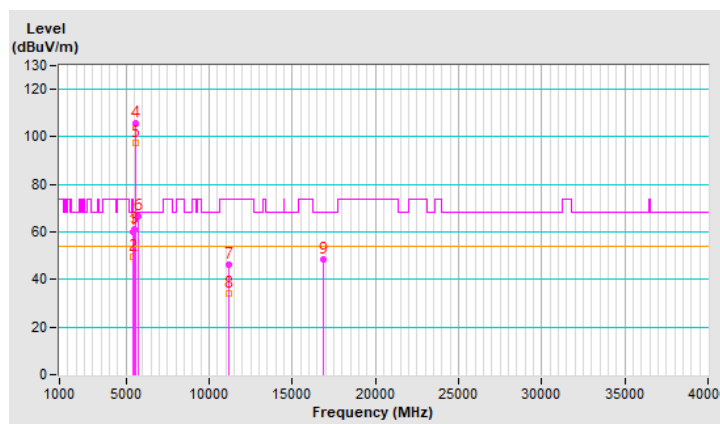

CHANNEL	TX Channel 122	DETECTOR FUNCTION	Peak (PK)
FREQUENCY RANGE	1GHz ~ 40GHz		Average (AV)

ANTENNA POLARITY & TEST DISTANCE: VERTICAL AT 3 M

NO.	FREQ. (MHz)	EMISSION LEVEL (dBuV/m)	LIMIT (dBuV/m)	MARGIN (dB)	ANTENNA HEIGHT (m)	TABLE ANGLE (Degree)	RAW VALUE (dBuV)	CORRECTION FACTOR (dB/m)
1	5460.00	60.7 PK	74.0	-13.3	1.69 V	63	58.8	1.9
2	5460.00	50.0 AV	54.0	-4.0	1.69 V	63	48.1	1.9
3	#5470.00	60.6 PK	68.2	-7.6	1.69 V	63	58.7	1.9
4	*5610.00	108.5 PK			1.69 V	63	106.4	2.1
5	*5610.00	98.6 AV			1.69 V	63	96.5	2.1
6	#5725.00	66.7 PK	68.2	-1.5	1.69 V	63	64.5	2.2
7	11220.00	46.7 PK	74.0	-27.3	2.15 V	183	34.1	12.6
8	11220.00	34.3 AV	54.0	-19.7	2.15 V	183	21.7	12.6
9	#16830.00	47.6 PK	68.2	-20.6	1.00 V	343	31.3	16.3

REMARKS:

1. Emission Level(dBuV/m) = Raw Value(dBuV) + Correction Factor(dB/m)
2. Correction Factor(dB/m) = Antenna Factor(dB/m) + Cable Factor(dB) – Pre-Amplifier Factor(dB)
3. Margin value = Emission Level – Limit value
4. The other emission levels were very low against the limit.
5. " * ": Fundamental frequency.
6. " # ": The radiated frequency is out of the restricted band.

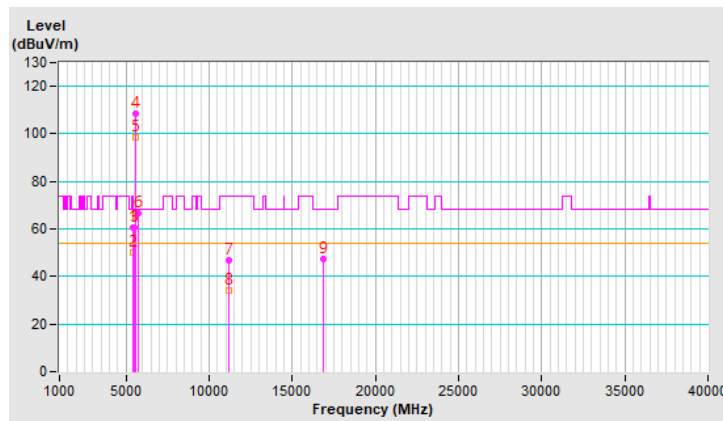

CHANNEL	TX Channel 138	DETECTOR FUNCTION	Peak (PK)
FREQUENCY RANGE	1GHz ~ 40GHz		Average (AV)

ANTENNA POLARITY & TEST DISTANCE: HORIZONTAL AT 3 M

NO.	FREQ. (MHz)	EMISSION LEVEL (dBuV/m)	LIMIT (dBuV/m)	MARGIN (dB)	ANTENNA HEIGHT (m)	TABLE ANGLE (Degree)	RAW VALUE (dBuV)	CORRECTION FACTOR (dB/m)
1	5460.00	52.8 PK	74.0	-21.2	3.59 H	144	50.9	1.9
2	5460.00	40.6 AV	54.0	-13.4	3.59 H	144	38.7	1.9
3	#5470.00	54.4 PK	68.2	-13.8	3.59 H	144	52.5	1.9
4	*5690.00	105.2 PK			3.59 H	144	103.1	2.1
5	*5690.00	97.5 AV			3.59 H	144	95.4	2.1
6	#5850.00	64.4 PK	68.2	-3.8	3.59 H	144	61.8	2.6
7	11380.00	46.5 PK	74.0	-27.5	2.55 H	230	33.2	13.3
8	11380.00	34.4 AV	54.0	-19.6	2.55 H	230	21.1	13.3
9	#17070.00	47.6 PK	68.2	-20.6	1.59 H	322	30.7	16.9

REMARKS:

1. Emission Level(dBuV/m) = Raw Value(dBuV) + Correction Factor(dB/m)
2. Correction Factor(dB/m) = Antenna Factor(dB/m) + Cable Factor(dB) – Pre-Amplifier Factor(dB)
3. Margin value = Emission Level – Limit value
4. The other emission levels were very low against the limit.
5. " * ": Fundamental frequency.
6. " # ": The radiated frequency is out of the restricted band.

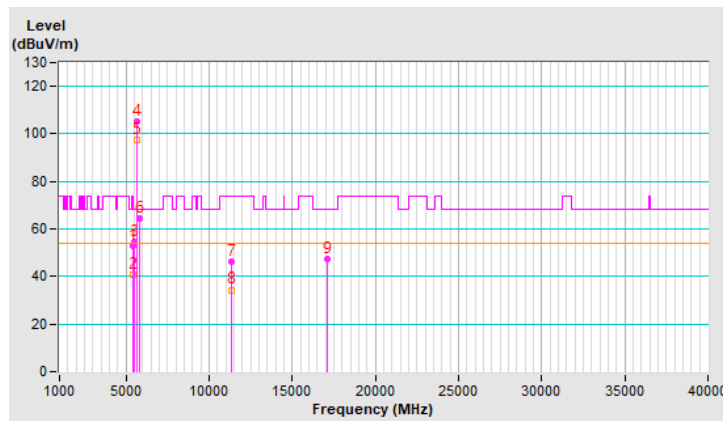

CHANNEL	TX Channel 138	DETECTOR FUNCTION	Peak (PK)
FREQUENCY RANGE	1GHz ~ 40GHz		Average (AV)

ANTENNA POLARITY & TEST DISTANCE: VERTICAL AT 3 M

NO.	FREQ. (MHz)	EMISSION LEVEL (dBuV/m)	LIMIT (dBuV/m)	MARGIN (dB)	ANTENNA HEIGHT (m)	TABLE ANGLE (Degree)	RAW VALUE (dBuV)	CORRECTION FACTOR (dB/m)
1	5460.00	53.0 PK	74.0	-21.0	1.68 V	65	51.1	1.9
2	5460.00	40.8 AV	54.0	-13.2	1.68 V	65	38.9	1.9
3	#5470.00	54.1 PK	68.2	-14.1	1.68 V	65	52.2	1.9
4	*5690.00	108.2 PK			1.68 V	65	106.1	2.1
5	*5690.00	98.5 AV			1.68 V	65	96.4	2.1
6	#5850.00	63.3 PK	68.2	-4.9	1.68 V	65	60.7	2.6
7	11380.00	46.5 PK	74.0	-27.5	2.16 V	157	33.2	13.3
8	11380.00	33.8 AV	54.0	-20.2	2.16 V	157	20.5	13.3
9	#17070.00	47.7 PK	68.2	-20.5	1.02 V	336	30.8	16.9

REMARKS:

1. Emission Level(dBuV/m) = Raw Value(dBuV) + Correction Factor(dB/m)
2. Correction Factor(dB/m) = Antenna Factor(dB/m) + Cable Factor(dB) – Pre-Amplifier Factor(dB)
3. Margin value = Emission Level – Limit value
4. The other emission levels were very low against the limit.
5. " * ": Fundamental frequency.
6. " # ": The radiated frequency is out of the restricted band.

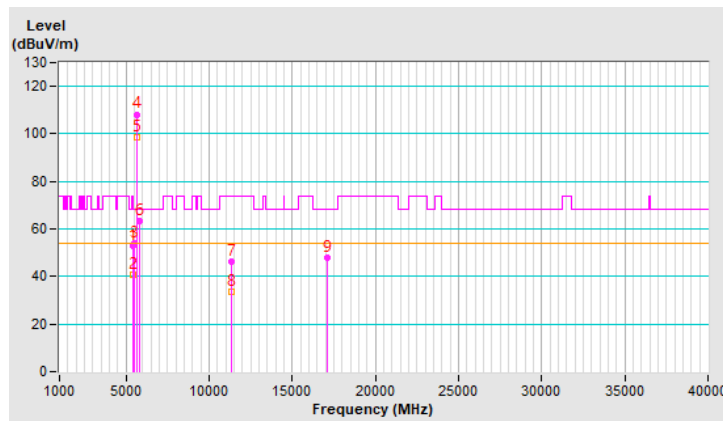

Below 1GHz Data:

802.11ac (VHT80)

CHANNEL	TX Channel 122	DETECTOR FUNCTION	Quasi-Peak (QP)
FREQUENCY RANGE	9kHz ~ 1GHz		

ANTENNA POLARITY & TEST DISTANCE: HORIZONTAL AT 3 M

NO.	FREQ. (MHz)	EMISSION LEVEL (dBuV/m)	LIMIT (dBuV/m)	MARGIN (dB)	ANTENNA HEIGHT (m)	TABLE ANGLE (Degree)	RAW VALUE (dBuV)	CORRECTION FACTOR (dB/m)
1	35.63	27.8 QP	40.0	-12.2	1.00 H	273	41.9	-14.1
2	88.45	26.1 QP	43.5	-17.4	2.50 H	281	44.5	-18.4
3	124.97	29.4 QP	43.5	-14.1	2.50 H	306	44.0	-14.6
4	153.39	28.9 QP	43.5	-14.6	2.00 H	269	41.7	-12.8
5	272.03	41.6 QP	46.0	-4.4	1.00 H	140	54.8	-13.2
6	625.03	32.4 QP	46.0	-13.6	1.00 H	302	37.4	-5.0

REMARKS:

1. Emission Level(dBuV/m) = Raw Value(dBuV) + Correction Factor(dB/m)
2. Correction Factor(dB/m) = Antenna Factor(dB/m) + Cable Factor(dB) – Pre-Amplifier Factor(dB)
3. Margin value = Emission Level – Limit value
4. The other emission levels were very low against the limit of frequency range 30MHz~1000MHz.
5. The emission levels were very low against the limit of frequency range 9kHz~30MHz: the amplitude of spurious emissions attenuated more than 20 dB below the permissible value to be report.

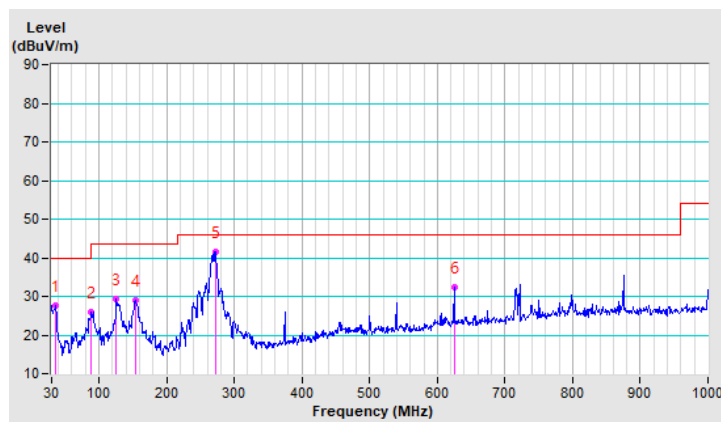

CHANNEL	TX Channel 122	DETECTOR FUNCTION	Quasi-Peak (QP)
FREQUENCY RANGE	9kHz ~ 1GHz		

ANTENNA POLARITY & TEST DISTANCE: VERTICAL AT 3 M

NO.	FREQ. (MHz)	EMISSION LEVEL (dBuV/m)	LIMIT (dBuV/m)	MARGIN (dB)	ANTENNA HEIGHT (m)	TABLE ANGLE (Degree)	RAW VALUE (dBuV)	CORRECTION FACTOR (dB/m)
1	34.95	34.5 QP	40.0	-5.5	1.00 V	270	48.7	-14.2
2	50.23	33.9 QP	40.0	-6.1	1.00 V	223	46.9	-13.0
3	89.61	31.0 QP	43.5	-12.5	1.00 V	360	49.4	-18.4
4	124.97	27.7 QP	43.5	-15.8	1.00 V	360	42.3	-14.6
5	270.77	38.0 QP	46.0	-8.0	1.50 V	202	51.2	-13.2
6	875.01	33.7 QP	46.0	-12.3	1.50 V	245	35.7	-2.0

REMARKS:

1. Emission Level(dBuV/m) = Raw Value(dBuV) + Correction Factor(dB/m)
2. Correction Factor(dB/m) = Antenna Factor(dB/m) + Cable Factor(dB) – Pre-Amplifier Factor(dB)
3. Margin value = Emission Level – Limit value
4. The other emission levels were very low against the limit of frequency range 30MHz~1000MHz.
5. The emission levels were very low against the limit of frequency range 9kHz~30MHz: the amplitude of spurious emissions attenuated more than 20 dB below the permissible value to be report.

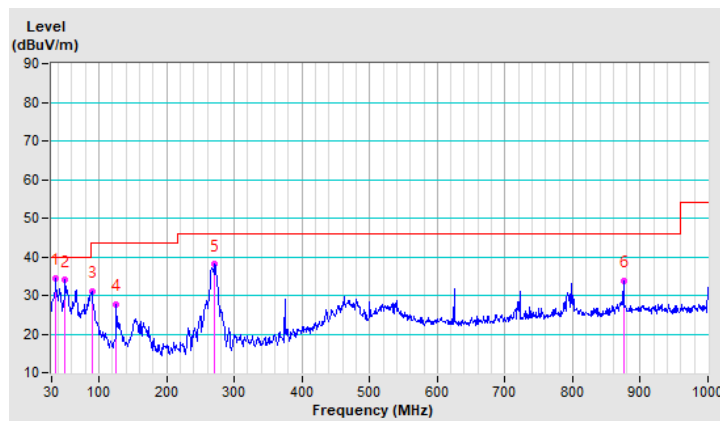

4.2 Conducted Emission Measurement

4.2.1 Limits of Conducted Emission Measurement

Frequency (MHz)	Conducted Limit (dBuV)	
	Quasi-peak	Average
0.15 - 0.5	66 - 56	56 - 46
0.50 - 5.0	56	46
5.0 - 30.0	60	50

Note: 1. The lower limit shall apply at the transition frequencies.

2. The limit decreases in line with the logarithm of the frequency in the range of 0.15 to 0.50MHz.

4.2.2 Test Instruments

DESCRIPTION & MANUFACTURER	MODEL NO.	SERIAL NO.	CALIBRATED DATE	CALIBRATED UNTIL
Test Receiver R&S	ESCS 30	847124/029	Oct. 24, 2018	Oct. 23, 2019
Line-Impedance Stabilization Network (for EUT) R&S	ESH3-Z5	848773/004	Oct. 22, 2018	Oct. 21, 2019
Line-Impedance Stabilization Network (for Peripheral) R&S	ESH3-Z5	835239/001	Mar. 17, 2019	Mar. 16, 2020
50 ohms Terminator	N/A	3	Oct. 22, 2018	Oct. 21, 2019
RF Cable	5D-FB	COCCAB-001	Sep. 28, 2018	Sep. 27, 2019
Fixed attenuator EMCI	STI02-2200-10	003	Mar. 14, 2019	Mar. 13, 2020
Software BVADT	BVADT_Cond_ V7.3.7.4	NA	NA	NA

Note:

1. The calibration interval of the above test instruments are 12 months and the calibrations are traceable to NML/ROC and NIST/USA.
2. The test was performed in Conduction 1.
3. Tested Date: Sep. 12, 2019

4.2.3 Test Procedure

- The EUT was placed 0.4 meters from the conducting wall of the shielded room with EUT being connected to the power mains through a line impedance stabilization network (LISN). Other support units were connected to the power mains through another LISN. The two LISNs provide 50 ohm/ 50uH of coupling impedance for the measuring instrument.
- Both lines of the power mains connected to the EUT were checked for maximum conducted interference.
- The frequency range from 150kHz to 30MHz was searched. Emission levels under (Limit - 20dB) was not recorded.

NOTE: All modes of operation were investigated and the worst-case emissions are reported.

4.2.4 Deviation from Test Standard

No deviation.

4.2.5 Test Setup

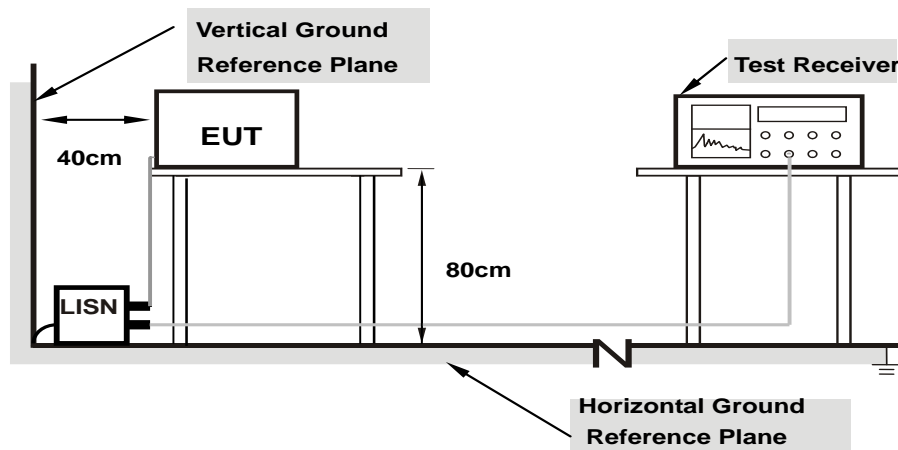

Note: 1.Support units were connected to second LISN.

For the actual test configuration, please refer to the attached file (Test Setup Photo).

4.2.6 EUT Operating Condition

Same as 4.1.6.

4.2.7 Test Results

Phase	Line (L)	Detector Function	Quasi-Peak (QP) / Average (AV)
-------	----------	-------------------	--------------------------------

No	Freq. [MHz]	Corr.	Reading Value		Emission Level		Limit		Margin	
		Factor	[dB (uV)]		[dB (uV)]		[dB (uV)]		(dB)	
	(dB)	Q.P.	AV.	Q.P.	AV.	Q.P.	AV.	Q.P.	AV.	
1	0.15000	9.97	39.78	25.37	49.75	35.34	66.00	56.00	-16.25	-20.66
2	0.16172	9.97	39.35	24.02	49.32	33.99	65.38	55.38	-16.06	-21.39
3	0.18906	9.98	34.45	20.99	44.43	30.97	64.08	54.08	-19.65	-23.11
4	0.27891	9.98	28.21	16.49	38.19	26.47	60.85	50.85	-22.66	-24.38
5	0.41563	9.99	23.09	14.78	33.08	24.77	57.54	47.54	-24.46	-22.77
6	16.52734	11.12	17.59	11.39	28.71	22.51	60.00	50.00	-31.29	-27.49

REMARKS:

1. Q.P. and AV. are abbreviations of quasi-peak and average individually.
2. The emission levels of other frequencies were very low against the limit.
3. Margin value = Emission level - Limit value
4. Correction factor = Insertion loss + Cable loss
5. Emission Level = Correction Factor + Reading Value.

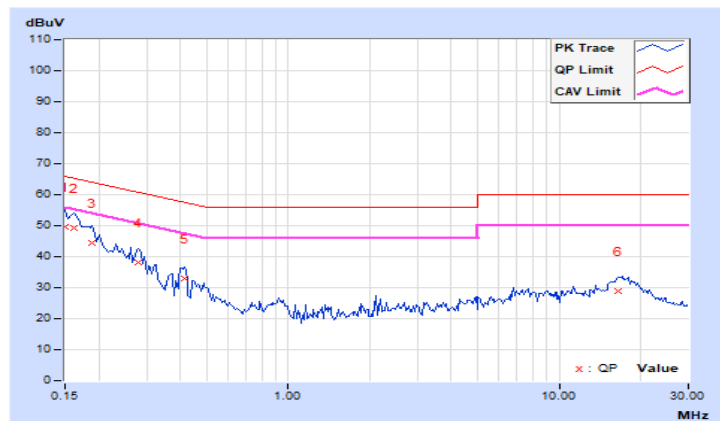

Phase	Neutral (N)	Detector Function	Quasi-Peak (QP) / Average (AV)
-------	-------------	-------------------	--------------------------------

No	Freq. [MHz]	Corr. Factor	Reading Value [dB (uV)]		Emission Level [dB (uV)]		Limit [dB (uV)]		Margin (dB)	
		(dB)	Q.P.	AV.	Q.P.	AV.	Q.P.	AV.	Q.P.	AV.
	1	0.15000	9.95	39.83	26.37	49.78	36.32	66.00	56.00	-16.22
2	0.18125	9.96	35.81	23.03	45.77	32.99	64.43	54.43	-18.66	-21.44
3	0.27500	9.97	27.19	19.70	37.16	29.67	60.97	50.97	-23.81	-21.30
4	0.45469	9.98	22.29	13.78	32.27	23.76	56.79	46.79	-24.52	-23.03
5	7.08984	10.39	18.22	11.86	28.61	22.25	60.00	50.00	-31.39	-27.75
6	17.59766	10.97	17.15	11.32	28.12	22.29	60.00	50.00	-31.88	-27.71

REMARKS:

1. Q.P. and AV. are abbreviations of quasi-peak and average individually.
2. The emission levels of other frequencies were very low against the limit.
3. Margin value = Emission level - Limit value
4. Correction factor = Insertion loss + Cable loss
5. Emission Level = Correction Factor + Reading Value.

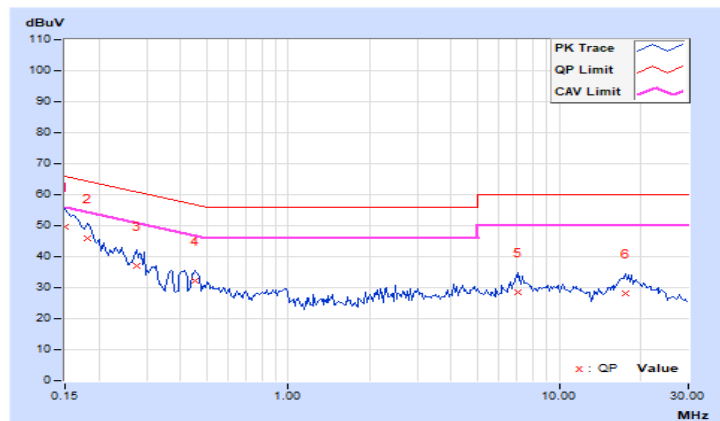

4.3 Transmit Power Measurement

4.3.1 Limits of Transmit Power Measurement

Operation Band	EUT Category		Limit
U-NII-1		Outdoor Access Point	1 Watt (30 dBm) (Max. e.i.r.p \leq 125mW(21 dBm) at any elevation angle above 30 degrees as measured from the horizon)
		Fixed point-to-point Access Point	1 Watt (30 dBm)
		Indoor Access Point	1 Watt (30 dBm)
		Client device	250mW (24 dBm)
U-NII-2A		√	250mW (24 dBm) or 11 dBm+10 log B*
U-NII-2C		√	250mW (24 dBm) or 11 dBm+10 log B*
U-NII-3		√	1 Watt (30 dBm)

*B is the 26 dB emission bandwidth in megahertz

Per KDB 662911 Method of conducted output power measurement on IEEE 802.11 devices,

Array Gain = 0 dB (i.e., no array gain) for $N_{ANT} \leq 4$;

Array Gain = 0 dB (i.e., no array gain) for channel widths ≥ 40 MHz for any N_{ANT} ;

Array Gain = $5 \log(N_{ANT}/N_{SS})$ dB or 3 dB, whichever is less for 20-MHz channel widths with $N_{ANT} \geq 5$.

For power measurements on all other devices: Array Gain = $10 \log(N_{ANT}/N_{SS})$ dB.

4.3.2 Test Setup

FOR POWER OUTPUT MEASUREMENT

For channel straddling 5725MHz:

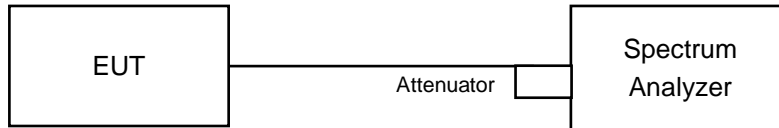

For other channels:

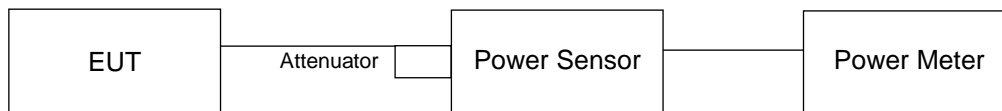

FOR 26dB OCCUPIED BANDWIDTH

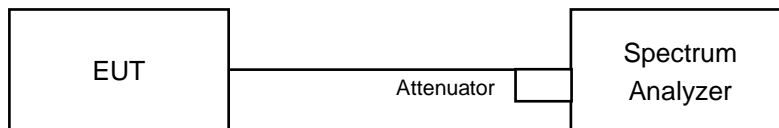

4.3.3 Test Instruments

Refer to section 4.1.2 to get information of above instrument.

4.3.4 Test Procedure

For Average Power Measurement

Method PM is used to perform output power measurement, trigger and gating function of wide band power meter is enabled to measure max output power of TX on burst. Duty factor is not added to measured value.

For 26dB Occupied Bandwidth

1. Set RBW = approximately 1% of the emission bandwidth.
2. Set the VBW > RBW.
3. Detector = Peak.
4. Trace mode = max hold.
5. Measure the maximum width of the emission that is 26 dB down from the peak of the emission. Compare this with the RBW setting of the analyzer. Readjust RBW and repeat measurement as needed until the RBW/EBW ratio is approximately 1%.

4.3.5 Deviation from Test Standard

No deviation.

4.3.6 EUT Operating Condition

The software provided by client to enable the EUT under transmission condition continuously at lowest, middle and highest channel frequencies individually.

4.3.7 Test Result

CDD Mode

802.11a

Power Output:

Chan.	Chan. Freq. (MHz)	Maximum Conducted Power (dBm)			Total Power (mW)	Total Power (dBm)	Limit (dBm)	Pass / Fail
		Chain 0	Chain 1	Chain 2				
52	5260	15.25	15.27	15.39	101.742	20.08	24.00	Pass
60	5300	15.15	15.07	15.48	100.189	20.01	24.00	Pass
64	5320	15.19	15.28	15.43	101.68	20.07	24.00	Pass
100	5500	15.48	15.08	15.42	102.363	20.10	24.00	Pass
116	5580	15.23	15.14	15.11	98.436	19.93	24.00	Pass
140	5700	15.37	15.21	15.36	101.98	20.09	24.00	Pass
*144 (UNII-2C Band)	5720	11.74	11.72	11.75	44.749	16.51	22.77	Pass
*144 (UNII-3 Band)	5720	5.78	5.80	5.58	11.2	10.49	30.00	Pass

Note: * Test was performed in accordance with Measurement follow FCC KDB 789033 UNII test procedure Method SA-1 and use spectrum analyzer test.

The Total Power for the straddle channel:

Chan.	Chan. Freq. (MHz)	Average Power (mW)	Average Power (dBm)
144	5720	55.949	17.48

Note: The total power was calculated through formula and record the value for reference only.

26dB OCCUPIED BANDWIDTH

Channel	Frequency (MHz)	26dBc Bandwidth (MHz)		
		Chain 0	Chain 1	Chain 2
52	5260	20.51	20.43	20.40
60	5300	20.60	20.38	20.51
64	5320	20.62	20.41	20.45
100	5500	20.69	20.33	20.55
116	5580	22.18	21.87	21.95
140	5700	20.68	20.47	20.43
144 (UNII-2C Band)	5720	15.28	15.04	15.05

Note: For U-NII-2A, U-NII-2C Band output power limitation is determined based on 26dBc bandwidth.

Power Limit = 11dBm + 10logB < U-NII-2A, U-NII-2C >

Channel Number	Freq.(MHz)	Min. B(MHz)	Determined Conducted Limit (dBm)
52	5260	20.40	24.09 > 24
60	5300	20.38	24.09 > 24
64	5320	20.41	24.09 > 24
100	5500	20.33	24.08 > 24
116	5580	21.87	24.39 > 24
140	5700	20.43	24.1 > 24
144 (UNII-2C Band)	5720	15.04	22.77 < 24

802.11ac (VHT20)

Power Output:

Chan.	Chan. Freq. (MHz)	Maximum Conducted Power (dBm)			Total Power (mW)	Total Power (dBm)	Limit (dBm)	Pass / Fail
		Chain 0	Chain 1	Chain 2				
52	5260	15.10	15.40	15.11	99.467	19.98	24.00	Pass
60	5300	15.02	15.31	15.33	99.851	19.99	24.00	Pass
64	5320	15.41	15.11	15.42	102.022	20.09	24.00	Pass
100	5500	15.16	14.99	15.09	96.645	19.85	24.00	Pass
116	5580	15.30	15.11	14.95	97.579	19.89	24.00	Pass
140	5700	15.38	15.20	15.39	102.221	20.10	24.00	Pass
*144 (UNII-2C Band)	5720	11.53	11.74	11.55	43.44	16.38	22.80	Pass
*144 (UNII-3 Band)	5720	5.98	6.16	5.90	11.983	10.79	30.00	Pass

Note: * Test was performed in accordance with Measurement follow FCC KDB 789033 UNII test procedure Method SA-1 and use spectrum analyzer test.

The Total Power for the straddle channel:

Chan.	Chan. Freq. (MHz)	Average Power (mW)	Average Power (dBm)
144	5720	55.423	17.44

Note: The total power was calculated through formula and record the value for reference only.

26dB OCCUPIED BANDWIDTH

Channel	Frequency (MHz)	26dBc Bandwidth (MHz)		
		Chain 0	Chain 1	Chain 2
52	5260	20.90	20.59	20.71
60	5300	20.88	20.56	20.70
64	5320	21.02	20.59	20.67
100	5500	20.93	20.58	20.68
116	5580	22.51	22.13	22.13
140	5700	21.07	20.48	20.56
144 (UNII-2C Band)	5720	15.29	15.28	15.14

Note: For U-NII-2A, U-NII-2C Band output power limitation is determined based on 26dBc bandwidth.

Power Limit = 11dBm + 10logB < U-NII-2A, U-NII-2C >			
Channel Number	Freq.(MHz)	Min. B(MHz)	Determined Conducted Limit (dBm)
52	5260	20.59	24.13 > 24
60	5300	20.56	24.13 > 24
64	5320	20.59	24.13 > 24
100	5500	20.58	24.13 > 24
116	5580	22.13	24.44 > 24
140	5700	20.48	24.11 > 24
144 (UNII-2C Band)	5720	15.14	22.8 < 24

802.11ac (VHT40)

Power Output:

Chan.	Chan. Freq. (MHz)	Maximum Conducted Power (dBm)			Total Power (mW)	Total Power (dBm)	Limit (dBm)	Pass / Fail
		Chain 0	Chain 1	Chain 2				
54	5270	18.27	18.32	18.38	203.928	23.09	24.00	Pass
62	5310	16.68	16.65	16.74	140.003	21.46	24.00	Pass
102	5510	16.14	16.13	16.24	124.208	20.94	24.00	Pass
110	5550	18.37	18.29	18.25	202.994	23.07	24.00	Pass
134	5670	18.35	18.37	18.06	201.071	23.03	24.00	Pass
*142 (UNII-2C Band)	5710	14.78	14.91	14.74	92.825	19.68	24.00	Pass
*142 (UNII-3 Band)	5710	4.67	4.79	4.61	9.03	9.56	30.00	Pass

Note: * Test was performed in accordance with Measurement follow FCC KDB 789033 UNII test procedure Method SA-2 and use spectrum analyzer test.

The Total Power for the straddle channel:

Chan.	Chan. Freq. (MHz)	Average Power (mW)	Average Power (dBm)
142	5710	101.855	20.08

Note: The total power was calculated through formula and record the value for reference only.

26dB OCCUPIED BANDWIDTH

Channel	Frequency (MHz)	26dBc Bandwidth (MHz)		
		Chain 0	Chain 1	Chain 2
54	5270	55.32	53.77	43.44
62	5310	41.78	41.53	41.28
102	5510	41.85	41.46	41.21
110	5550	59.27	45.90	53.25
134	5670	75.37	52.20	49.80
142 (UNII-2C Band)	5710	46.07	36.08	37.51

Note: For U-NII-2A, U-NII-2C Band output power limitation is determined based on 26dBc bandwidth.

Power Limit = 11dBm + 10logB < U-NII-2A, U-NII-2C >			
Channel Number	Freq.(MHz)	Min. B(MHz)	Determined Conducted Limit (dBm)
54	5270	43.44	27.37 > 24
62	5310	41.28	27.15 > 24
102	5510	41.21	27.15 > 24
110	5550	45.90	27.61 > 24
134	5670	49.80	27.97 > 24
142 (UNII-2C Band)	5710	36.08	26.57 > 24

802.11ac (VHT80)

Power Output:

Chan.	Chan. Freq. (MHz)	Maximum Conducted Power (dBm)			Total Power (mW)	Total Power (dBm)	Limit (dBm)	Pass / Fail
		Chain 0	Chain 1	Chain 2				
58	5290	15.16	15.27	15.34	100.659	20.03	24.00	Pass
106	5530	15.61	15.69	15.71	110.699	20.44	24.00	Pass
122	5610	19.12	19.05	19.31	247.321	23.93	24.00	Pass
*138 (UNII-2C Band)	5690	15.99	16.05	15.86	123.446	20.91	24.00	Pass
*138 (UNII-3 Band)	5690	2.40	2.35	2.28	5.359	7.29	30.00	Pass

Note: * Test was performed in accordance with Measurement follow FCC KDB 789033 UNII test procedure Method SA-2 and use spectrum analyzer test.

The Total Power for the straddle channel:

Chan.	Chan. Freq. (MHz)	Average Power (mW)	Average Power (dBm)
138	5690	128.805	21.1

Note: The total power was calculated through formula and record the value for reference only.

26dB OCCUPIED BANDWIDTH

Channel	Frequency (MHz)	26dBc Bandwidth (MHz)		
		Chain 0	Chain 1	Chain 2
58	5290	83.70	83.37	82.72
106	5530	83.72	83.28	82.88
122	5610	153.68	97.13	141.47
138 (UNII-2C Band)	5690	108.66	92.52	95.17

Note: For U-NII-2A, U-NII-2C Band output power limitation is determined based on 26dBc bandwidth.

Power Limit = 11dBm + 10logB < U-NII-2A, U-NII-2C >			
Channel Number	Freq.(MHz)	Min. B(MHz)	Determined Conducted Limit (dBm)
58	5290	82.72	30.17 > 24
106	5530	82.88	30.18 > 24
122	5610	97.13	30.87 > 24
138 (UNII-2C Band)	5690	92.52	30.66 > 24

Beamforming Mode

802.11ac (VHT20)

Power Output:

Chan.	Chan. Freq. (MHz)	Maximum Conducted Power (dBm)			Total Power (mW)	Total Power (dBm)	Limit (dBm)	Pass / Fail
		Chain 0	Chain 1	Chain 2				
52	5260	15.10	15.40	15.11	99.467	19.98	20.11	Pass
60	5300	15.02	15.31	15.33	99.851	19.99	20.11	Pass
64	5320	15.41	15.11	15.42	102.022	20.09	20.11	Pass
100	5500	15.16	14.99	15.09	96.645	19.85	20.11	Pass
116	5580	15.30	15.11	14.95	97.579	19.89	20.11	Pass
140	5700	15.38	15.20	15.39	102.221	20.10	20.11	Pass
*144 (UNII-2C Band)	5720	11.53	11.74	11.55	43.44	16.38	18.91	Pass
*144 (UNII-3 Band)	5720	5.98	6.16	5.90	11.983	10.79	26.11	Pass

- Note: 1. * Test was performed in accordance with Measurement follow FCC KDB 789033 UNII test procedure Method SA-1 and use spectrum analyzer test.
 2. Directional gain = $10 \log[(10^{G0/20} + 10^{G1/20} + 10^{G2/20})^2 / 3] = 9.89\text{dBi} > 6\text{dBi}$, so the power limit shall reduced to "Determined Conducted Limit-(9.89-6)".

The Total Power for the straddle channel:

Chan.	Chan. Freq. (MHz)	Average Power (mW)	Average Power (dBm)
144	5720	55.423	17.44

Note: The total power was calculated through formula and record the value for reference only.

26dB OCCUPIED BANDWIDTH

Channel	Frequency (MHz)	26dBc Bandwidth (MHz)		
		Chain 0	Chain 1	Chain 2
52	5260	20.90	20.59	20.71
60	5300	20.88	20.56	20.70
64	5320	21.02	20.59	20.67
100	5500	20.93	20.58	20.68
116	5580	22.51	22.13	22.13
140	5700	21.07	20.48	20.56
144 (UNII-2C Band)	5720	15.29	15.28	15.14

Note: For U-NII-2A, U-NII-2C Band output power limitation is determined based on 26dBc bandwidth.

Power Limit = $11\text{dBm} + 10\log B < \text{U-NII-2A, U-NII-2C} >$

Channel Number	Freq.(MHz)	Min. B(MHz)	Determined Conducted Limit (dBm)
52	5260	20.59	24.13 > 24
60	5300	20.56	24.13 > 24
64	5320	20.59	24.13 > 24
100	5500	20.58	24.13 > 24
116	5580	22.13	24.44 > 24
140	5700	20.48	24.11 > 24
144 (UNII-2C Band)	5720	15.14	22.8 < 24

802.11ac (VHT40)

Power Output:

Chan.	Chan. Freq. (MHz)	Maximum Conducted Power (dBm)			Total Power (mW)	Total Power (dBm)	Limit (dBm)	Pass / Fail
		Chain 0	Chain 1	Chain 2				
52	5270	15.27	15.33	15.37	102.205	20.09	20.11	Pass
60	5310	15.30	15.27	15.36	101.891	20.08	20.11	Pass
102	5510	15.24	15.23	15.34	100.961	20.04	20.11	Pass
110	5550	15.37	15.29	15.25	101.738	20.07	20.11	Pass
134	5670	15.35	15.37	15.06	100.775	20.03	20.11	Pass
*142 (UNII-2C Band)	5710	11.91	11.87	11.97	47.676	16.78	20.11	Pass
*142 (UNII-3 Band)	5710	1.95	1.65	1.64	4.587	6.62	26.11	Pass

- Note: 1. * Test was performed in accordance with Measurement follow FCC KDB 789033 UNII test procedure Method SA-1 and use spectrum analyzer test.
2. Directional gain = $10 \log[(10^{G0/20} + 10^{G1/20} + 10^{G2/20})^2 / 3] = 9.89\text{dBi} > 6\text{dBi}$, so the power limit shall reduced to "Determined Conducted Limit-(9.89-6)".

The Total Power for the straddle channel:

Chan.	Chan. Freq. (MHz)	Average Power (mW)	Average Power (dBm)
142	5710	52.563	17.18

Note: The total power was calculated through formula and record the value for reference only.

26dB OCCUPIED BANDWIDTH

Channel	Frequency (MHz)	26dBc Bandwidth (MHz)		
		Chain 0	Chain 1	Chain 2
52	5270	55.32	53.77	43.44
60	5310	41.78	41.53	41.28
102	5510	41.85	41.46	41.21
110	5550	59.27	45.90	53.25
134	5670	75.37	52.20	49.80
*142 (UNII-2C Band)	5710	46.07	36.08	37.51

Note: For U-NII-2A, U-NII-2C Band output power limitation is determined based on 26dBc bandwidth.

Power Limit = 11dBm + 10logB < U-NII-2A, U-NII-2C >

Channel Number	Freq.(MHz)	Min. B(MHz)	Determined Conducted Limit (dBm)
54	5270	43.44	27.37 > 24
62	5310	41.28	27.15 > 24
102	5510	41.21	27.15 > 24
110	5550	45.90	27.61 > 24
134	5670	49.80	27.97 > 24
142 (UNII-2C Band)	5710	36.08	26.57 > 24

802.11ac (VHT80)

Power Output:

Chan.	Chan. Freq. (MHz)	Maximum Conducted Power (dBm)			Total Power (mW)	Total Power (dBm)	Limit (dBm)	Pass / Fail
		Chain 0	Chain 1	Chain 2				
58	5290	15.16	15.27	15.34	100.659	20.03	20.11	Pass
106	5530	15.36	15.14	15.46	102.171	20.09	20.11	Pass
122	5610	15.22	15.15	15.41	100.754	20.03	20.11	Pass
*138 (UNII-2C Band)	5690	12.00	12.50	12.40	52.891	17.23	20.11	Pass
*138 (UNII-3 Band)	5690	-1.78	-1.40	-1.48	2.1767	3.38	26.11	Pass

- Note: 1. * Test was performed in accordance with Measurement follow FCC KDB 789033 UNII test procedure Method SA-1 and use spectrum analyzer test.
2. Directional gain = $10 \log[(10^{G0/20} + 10^{G1/20} + 10^{G2/20})^2 / 3] = 9.89\text{dBi} > 6\text{dBi}$, so the power limit shall be reduced to "Determined Conducted Limit-(9.89-6)".

The Total Power for the straddle channel:

Chan.	Chan. Freq. (MHz)	Average Power (mW)	Average Power (dBm)
138	5690	55.0677	17.41

Note: The total power was calculated through formula and record the value for reference only.

26dB OCCUPIED BANDWIDTH

Channel	Frequency (MHz)	26dBc Bandwidth (MHz)		
		Chain 0	Chain 1	Chain 2
58	5290	83.70	83.37	82.72
106	5530	83.72	83.28	82.88
122	5610	153.68	97.13	141.47
138 (UNII-2C Band)	5690	108.66	92.52	95.17

Note: For U-NII-2A, U-NII-2C Band output power limitation is determined based on 26dBc bandwidth.

Power Limit = 11dBm + 10logB < U-NII-2A, U-NII-2C >			
Channel Number	Freq.(MHz)	Min. B(MHz)	Determined Conducted Limit (dBm)
58	5290	82.72	30.17 > 24
106	5530	82.88	30.18 > 24
122	5610	97.13	30.87 > 24
138 (UNII-2C Band)	5690	92.52	30.66 > 24

Spectrum Plot of Worst Value

802.11a / Chain 1 : CH144 (U-NII-2C)

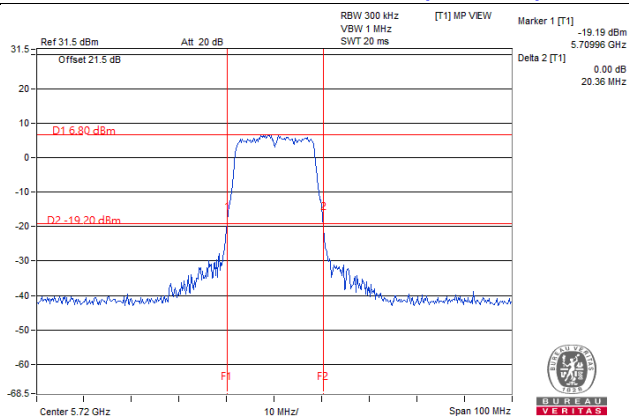

802.11ac (VHT20) / Chain 2 : CH144 (U-NII-2C)

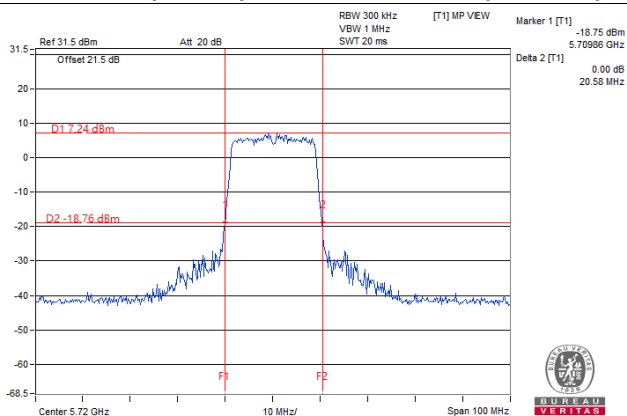

802.11ac (VHT40) / Chain 1: CH142 (U-NII-2C)

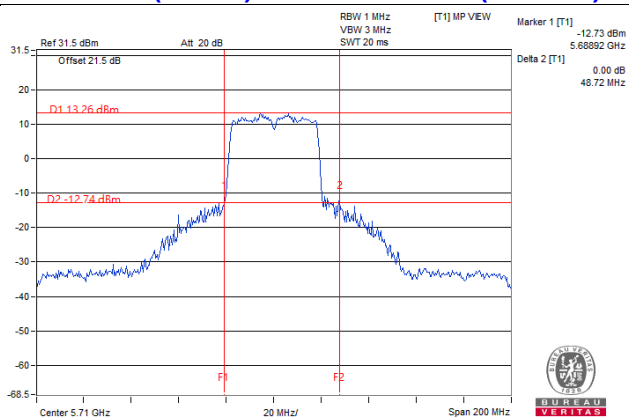

802.11ac (VHT80) / Chain 2 : CH58

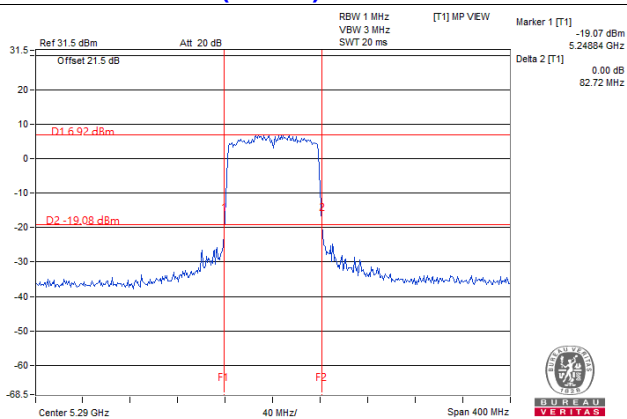

NOTE:

- For CH144 (U-NII-2C Band) = 5725MHz - Marker 1
- For CH144 (U-NII-2C Band) = 5725MHz - Marker 1
- For CH142 (U-NII-2C Band) = 5725MHz - Marker 1

4.4 Occupied Bandwidth Measurement

4.4.1 Test Setup

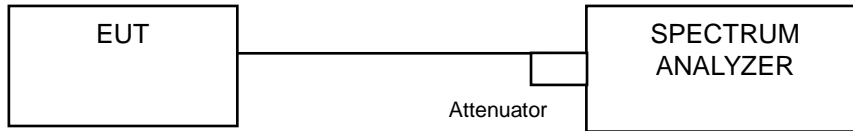

4.4.2 Test Instruments

Refer to section 4.1.2 to get information of above instrument.

4.4.3 Test Procedure

The transmitter output was connected to the spectrum analyzer through an attenuator. The bandwidth of the fundamental frequency was measured by spectrum analyzer with resolution bandwidth in the range of 1% to 5% of the anticipated emission bandwidth, and a video bandwidth at least 3x the resolution bandwidth and set the detector to SAMPLE. The width of a frequency band such that, below the lower and above the upper frequency limits, the mean powers emitted are each equal to a specified percentage 0.5 % of the total mean power of a given emission.

4.4.4 Test Results

802.11a

Channel	Channel Frequency (MHz)	Occupied Bandwidth (MHz)		
		Chain 0	Chain 1	Chain 2
52	5260	16.92	16.80	16.92
60	5300	16.80	16.80	16.80
64	5320	16.92	16.80	16.68
100	5500	16.80	16.68	16.80
116	5580	16.80	16.68	16.68
140	5700	16.80	16.80	16.80
144 (U-NII-2C Band)	5720	13.40	13.28	13.28
144 (U-NII-3 Band)	5720	3.52	3.40	3.40

802.11ac (VHT20)

Channel	Channel Frequency (MHz)	Occupied Bandwidth (MHz)		
		Chain 0	Chain 1	Chain 2
52	5260	17.88	17.88	17.88
60	5300	17.88	17.76	17.88
64	5320	17.88	17.76	17.76
100	5500	17.88	17.76	17.88
116	5580	17.88	17.76	17.76
140	5700	17.88	17.76	17.76
144 (U-NII-2C Band)	5720	14.00	13.88	13.88
144 (U-NII-3 Band)	5720	4.00	4.00	4.00

802.11ac (VHT40)

Channel	Channel Frequency (MHz)	Occupied Bandwidth (MHz)		
		Chain 0	Chain 1	Chain 2
54	5270	36.72	36.48	36.72
62	5310	36.72	36.48	36.48
102	5510	36.48	36.48	36.48
110	5550	36.48	36.72	36.96
134	5670	36.72	36.72	36.96
142 (U-NII-2C Band)	5710	33.48	33.24	33.48
142 (U-NII-3 Band)	5710	3.48	3.48	3.24

802.11ac (VHT80)

Channel	Channel Frequency (MHz)	Occupied Bandwidth (MHz)		
		Chain 0	Chain 1	Chain 2
58	5290	75.84	76.32	75.36
106	5530	75.84	75.36	75.84
122	5610	76.32	75.84	76.32
138 (U-NII-2C Band)	5690	73.40	72.92	72.92
138 (U-NII-3 Band)	5690	2.92	2.92	2.92

Spectrum Plot of Max. Value

802.11a_Chain 0 / CH52

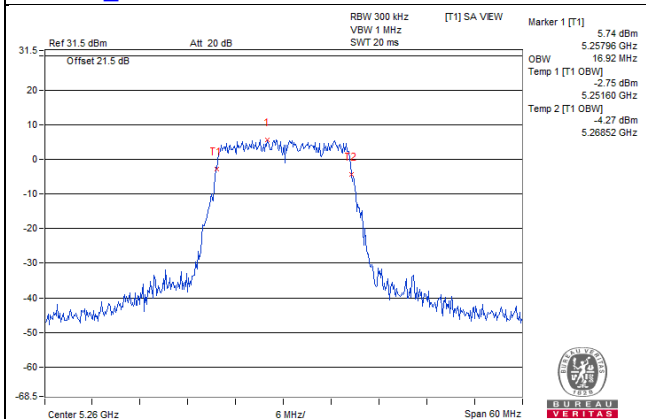

802.11ac (VHT20)_Chain 0 / CH52

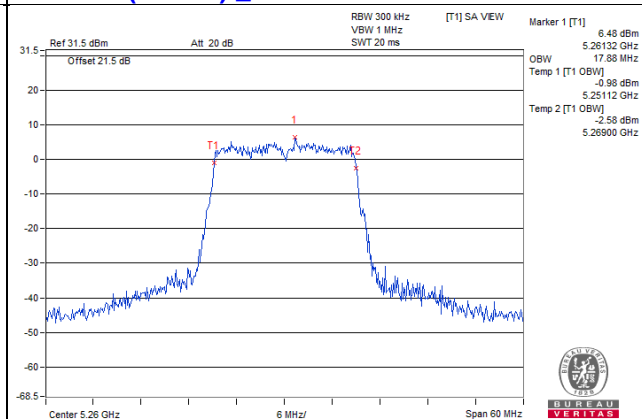

802.11ac (VHT40)_Chain 0 / CH54

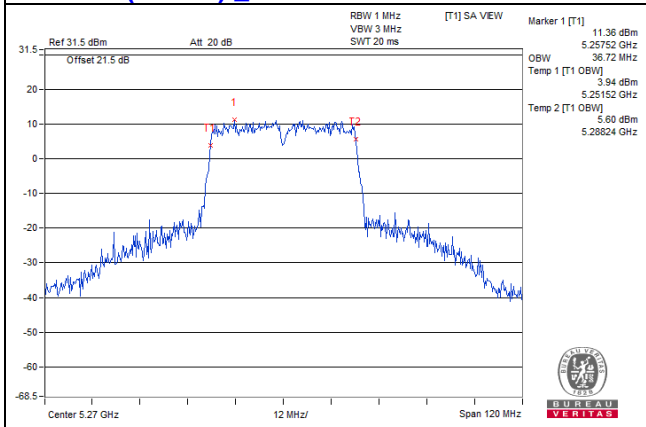

802.11ac (VHT80)_Chain 0 / CH122

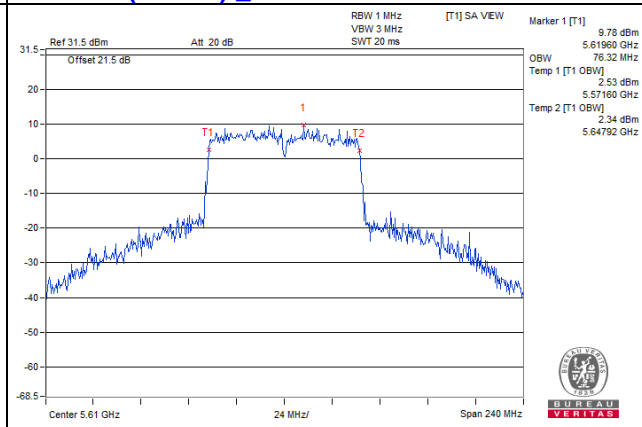

For channel straddling 5725MHz

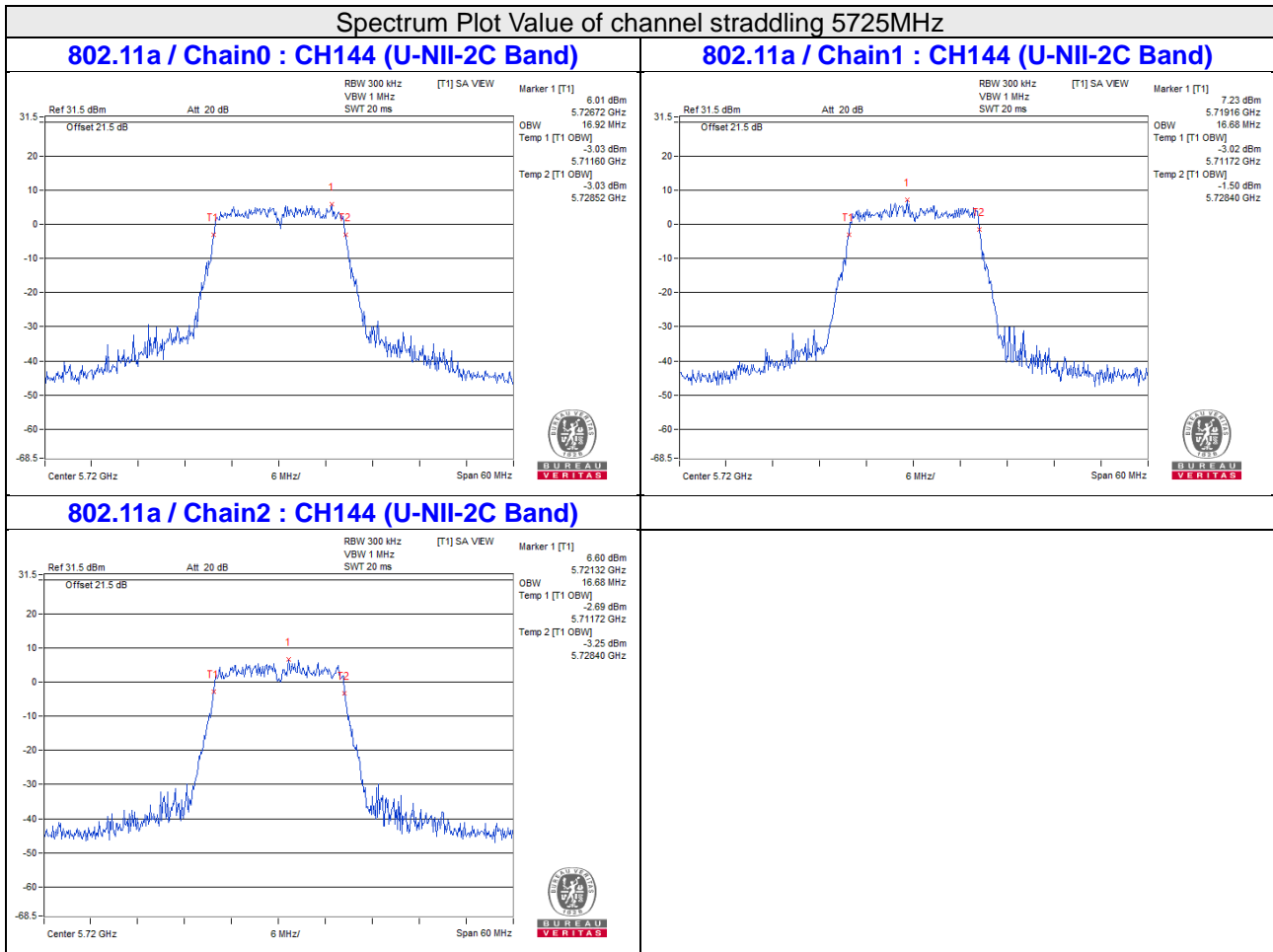

Spectrum Plot Value of channel straddling 5725MHz

802.11ac (VHT20) / Chain0 : CH144 (U-NII-2C Band) **802.11ac (VHT20) / Chain1 : CH144 (U-NII-2C Band)**

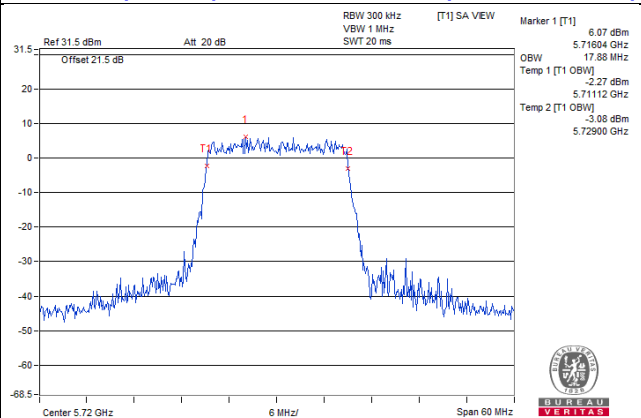
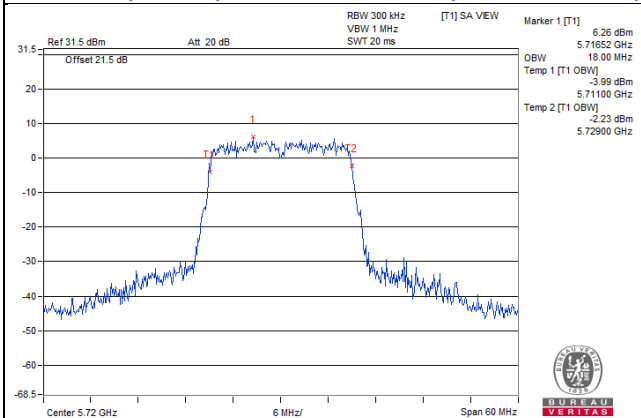

802.11ac (VHT20) / Chain2 : CH144 (U-NII-2C Band)

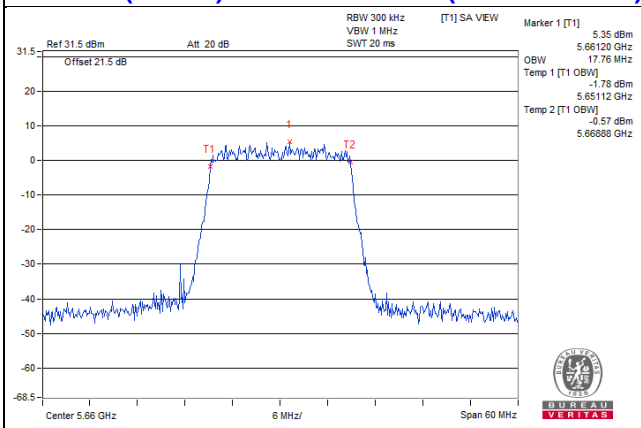

Spectrum Plot Value of channel straddling 5725MHz

802.11ac (VHT40) / Chain0 : CH142 (U-NII-2C Band) **802.11ac (VHT40) / Chain1 : CH142 (U-NII-2C Band)**

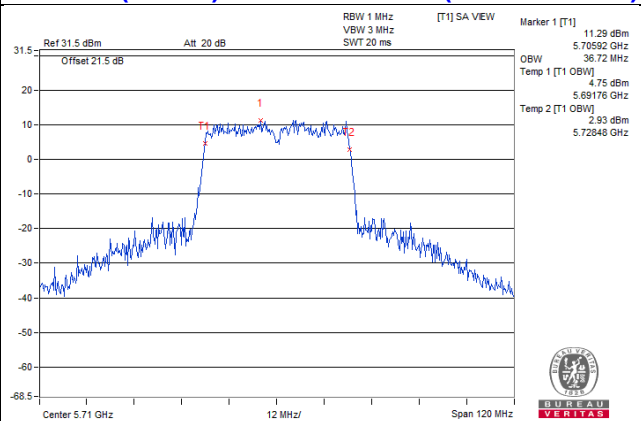
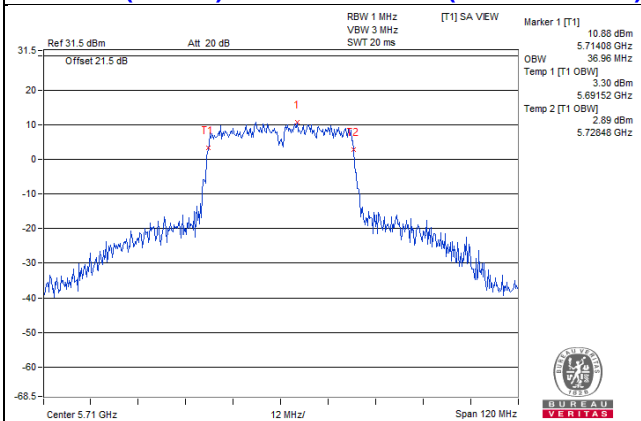

802.11ac (VHT40) / Chain2 : CH142 (U-NII-2C Band)

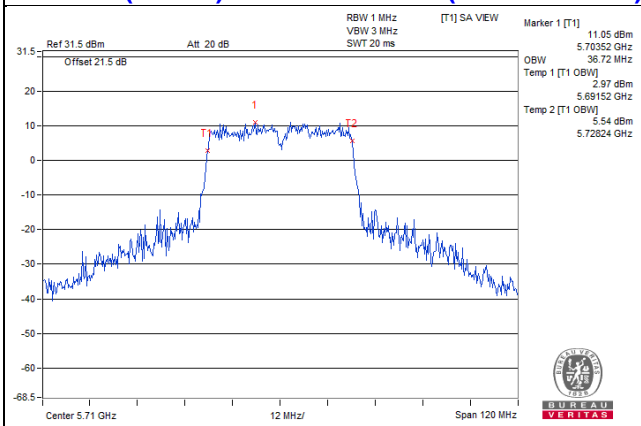

Spectrum Plot Value of channel straddling 5725MHz

802.11ac (VHT80) / Chain0 : CH138 (U-NII-2C Band) **802.11ac (VHT80) / Chain1 : CH138 (U-NII-2C Band)**

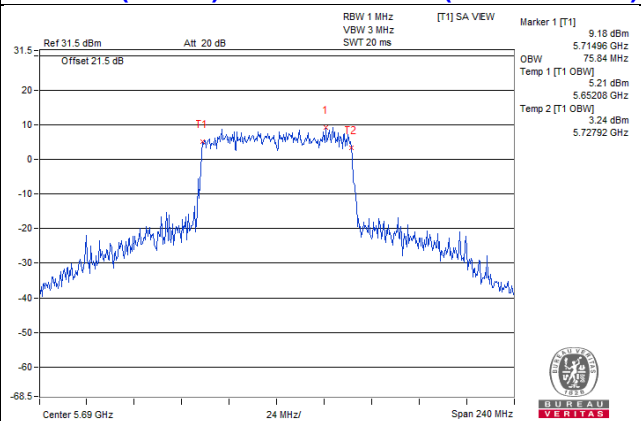
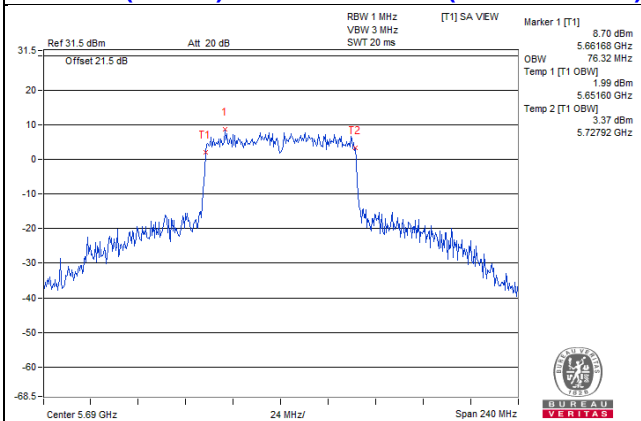

802.11ac (VHT80) / Chain2 : CH138 (U-NII-2C Band)

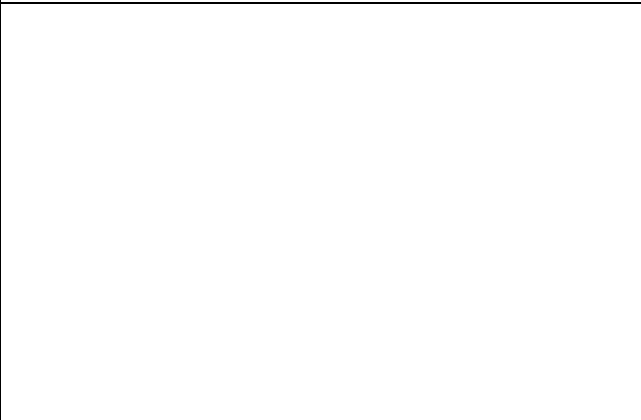
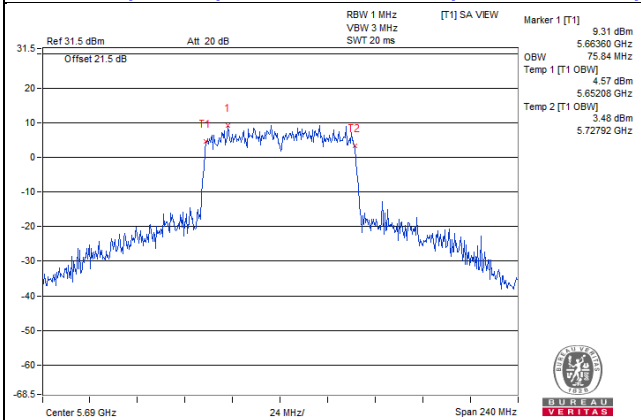

Note:

- For CH144 (U-NII-2C) = 5725MHz - Temp 1
- For CH142 (U-NII-2C) = 5725MHz - Temp 1
- For CH138 (U-NII-2C) = 5725MHz - Temp 1
- For CH144 (U-NII-3) = Temp 2 - 5725MHz
- For CH142 (U-NII-3) = Temp 2 - 5725MHz
- For CH138 (U-NII-3) = Temp 2 - 5725MHz

4.5 Peak Power Spectral Density Measurement

4.5.1 Limits of Peak Power Spectral Density Measurement

Operation Band	EUT Category		Limit
U-NII-1		Outdoor Access Point	17dBm/ MHz
		Fixed point-to-point Access Point	
		Indoor Access Point	
		Client device	11dBm/ MHz
U-NII-2A		√	11dBm/ MHz
U-NII-2C		√	11dBm/ MHz
U-NII-3		√	30dBm/ 500kHz

4.5.2 Test Setup

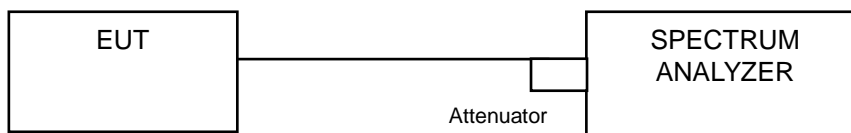

4.5.3 Test Instruments

Refer to section 4.1.2 to get information of above instrument.

4.5.4 Test Procedure

For 802.11a, 802.11ac (VHT20)

For U-NII-2A, U-NII-2C band:

Using method SA-1

1. Set span to encompass the entire emission bandwidth (EBW) of the signal.
2. Set RBW = 1 MHz, Set VBW \geq 3 MHz, Detector = RMS
3. Sweep time = auto, trigger set to "free run".
4. Trace average at least 100 traces in power averaging mode.
5. Record the max value

For U-NII-3

1. Set span to encompass the entire emission bandwidth (EBW) of the signal.
2. Set RBW = 300 kHz, Set VBW \geq 1 MHz, Detector = RMS
3. Use the peak marker function to determine the maximum power level in any 300 kHz band segment within the fundamental EBW.
4. Scale the observed power level to an equivalent value in 500 kHz by adjusting (reducing) the measured power by a bandwidth correction factor (BWCF) where $BWCF = 10\log(500\text{ kHz}/300\text{ kHz})$
5. Sweep time = auto, trigger set to "free run".
6. Trace average at least 100 traces in power averaging mode.
7. Record the max value

For 802.11ac (VHT40), 802.11ac (VHT80)

For U-NII-2A, U-NII-2C band:

Using method SA-2

1. Set span to encompass the entire emission bandwidth (EBW) of the signal.
2. Set RBW = 1 MHz, Set VBW \geq 3 MHz, Detector = RMS
3. Sweep time = auto, trigger set to "free run".
4. Trace average at least 100 traces in power averaging mode.
5. Record the max value and add $10 \log (1/\text{duty cycle})$

For U-NII-3:

1. Set span to encompass the entire emission bandwidth (EBW) of the signal.
2. Set RBW = 300 kHz, Set VBW \geq 1 MHz, Detector = RMS
3. Use the peak marker function to determine the maximum power level in any 300 kHz band segment within the fundamental EBW.
4. Scale the observed power level to an equivalent value in 500 kHz by adjusting (reducing) the measured power by a bandwidth correction factor (BWCF) where $\text{BWCF} = 10 \log(500 \text{ kHz}/300 \text{ kHz})$
5. Sweep time = auto, trigger set to "free run".
6. Trace average at least 100 traces in power averaging mode.
7. Record the max value and add $10 \log (1/\text{duty cycle})$

4.5.5 Deviation from Test Standard

No deviation.

4.5.6 EUT Operating Condition

Same as Item 4.3.6.

4.5.7 Test Results

CDD Mode

For U-NII-2A, U-NII-2C:

802.11a

Chan.	Chan. Freq. (MHz)	PSD W/O Duty Factor (dBm/MHz)			Total PSD With Duty Factor (dBm/MHz)	MAX. Limit (dBm/MHz)	Pass / Fail
		Chain 0	Chain 1	Chain 2			
52	5260	2.30	2.06	2.22	6.97	7.11	Pass
60	5300	2.08	2.17	2.59	7.06	7.11	Pass
64	5320	2.20	2.28	1.75	6.85	7.11	Pass
100	5500	2.57	1.94	2.14	7.00	7.11	Pass
116	5580	2.15	2.21	2.30	6.99	7.11	Pass
140	5700	1.79	2.11	2.29	6.84	7.11	Pass
144 (U-NII-2C Band)	5720	1.82	2.28	2.26	6.90	7.11	Pass

- Note:** 1. Method a) of power density measurement of KDB 662911 is using for calculating total power density. Total power density is summing entire spectra across corresponding frequency bins on the various outputs by computer.
 2. Directional gain = $10 \log[(10^{G0/20} + 10^{G1/20} + 10^{G2/20})^2 / 3]$ = 9.89dBi > 6dBi, so the power density limit shall be reduced to $11 - (9.89 - 6) = 7.11$ dBm.

802.11ac (VHT20)

Chan.	Chan. Freq. (MHz)	PSD W/O Duty Factor (dBm/MHz)			Total PSD With Duty Factor (dBm/MHz)	MAX. Limit (dBm/MHz)	Pass / Fail
		Chain 0	Chain 1	Chain 2			
52	5260	1.84	1.94	1.73	6.61	7.11	Pass
60	5300	1.80	1.97	1.73	6.61	7.11	Pass
64	5320	1.92	1.43	2.18	6.63	7.11	Pass
100	5500	1.58	1.15	1.55	6.20	7.11	Pass
116	5580	1.71	1.26	1.59	6.30	7.11	Pass
140	5700	1.90	1.64	1.80	6.55	7.11	Pass
144 (U-NII-2C Band)	5720	1.83	1.86	1.64	6.55	7.11	Pass

- Note:** 1. Method a) of power density measurement of KDB 662911 is using for calculating total power density. Total power density is summing entire spectra across corresponding frequency bins on the various outputs by computer.
 2. Directional gain = $10 \log[(10^{G0/20} + 10^{G1/20} + 10^{G2/20})^2 / 3]$ = 9.89dBi > 6dBi, so the power density limit shall be reduced to $11 - (9.89 - 6) = 7.11$ dBm.

802.11ac (VHT40)

Chan.	Chan. Freq. (MHz)	PSD W/O Duty Factor (dBm/MHz)			Duty Factor (dB)	Total PSD With Duty Factor (dBm/MHz)	MAX. Limit (dBm/MHz)	Pass / Fail
		Chain 0	Chain 1	Chain 2				
54	5270	1.84	2.01	1.86	0.09	6.77	7.11	Pass
62	5310	0.47	0.32	-0.22	0.09	5.06	7.11	Pass
102	5510	-0.05	0.09	0.04	0.09	4.89	7.11	Pass
110	5550	1.95	1.78	2.23	0.09	6.85	7.11	Pass
134	5670	1.23	1.56	1.28	0.09	6.22	7.11	Pass
142 (U-NII-2C Band)	5710	1.08	1.50	1.35	0.09	6.17	7.11	Pass

- Note:** 1. Method a) of power density measurement of KDB 662911 is using for calculating total power density. Total power density is summing entire spectra across corresponding frequency bins on the various outputs by computer.
2. Directional gain = $10 \log[(10^{G0/20} + 10^{G1/20} + 10^{G2/20})^2 / 3] = 9.89\text{dBi} > 6\text{dBi}$, so the power density limit shall be reduced to $11 - (9.89 - 6) = 7.11\text{dBm}$.
3. Refer to section 3.3 for duty cycle spectrum plot.

802.11ac (VHT80)

Chan.	Chan. Freq. (MHz)	PSD W/O Duty Factor (dBm/MHz)			Duty Factor (dB)	Total PSD With Duty Factor (dBm/MHz)	MAX. Limit (dBm/MHz)	Pass / Fail
		Chain 0	Chain 1	Chain 2				
58	5290	-4.43	-4.63	-4.66	0.18	0.38	7.11	Pass
106	5530	-3.78	-3.94	-3.58	0.18	1.19	7.11	Pass
122	5610	-0.31	-0.77	0.00	0.18	4.60	7.11	Pass
138 (U-NII-2C Band)	5690	-0.94	-0.74	-0.94	0.18	4.08	7.11	Pass

- Note:** 1. Method a) of power density measurement of KDB 662911 is using for calculating total power density. Total power density is summing entire spectra across corresponding frequency bins on the various outputs by computer.
2. Directional gain = $10 \log[(10^{G0/20} + 10^{G1/20} + 10^{G2/20})^2 / 3] = 9.89\text{dBi} > 6\text{dBi}$, so the power density limit shall be reduced to $11 - (9.89 - 6) = 7.11\text{dBm}$.
3. Refer to section 3.3 for duty cycle spectrum plot.

Spectrum Plot of Worst Value

802.11a_Chain 0 / CH144 (U-NII-2C)

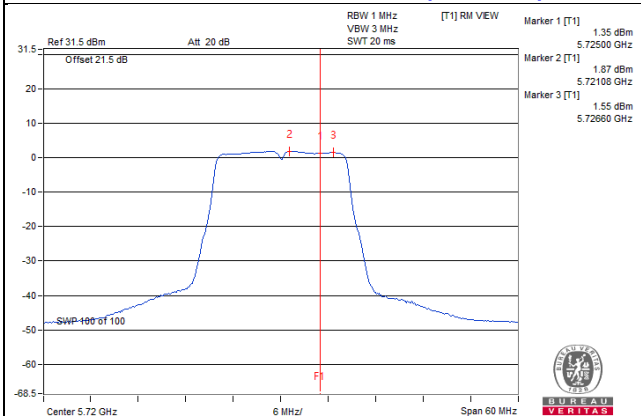

802.11ac (VHT20)_Chain 2 / CH64

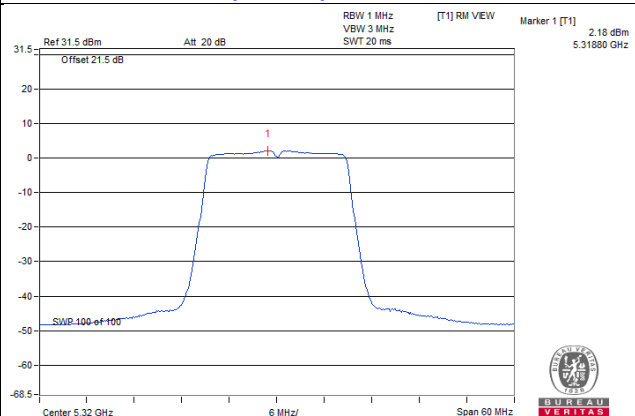

802.11ac (VHT40)_Chain 2 / CH110

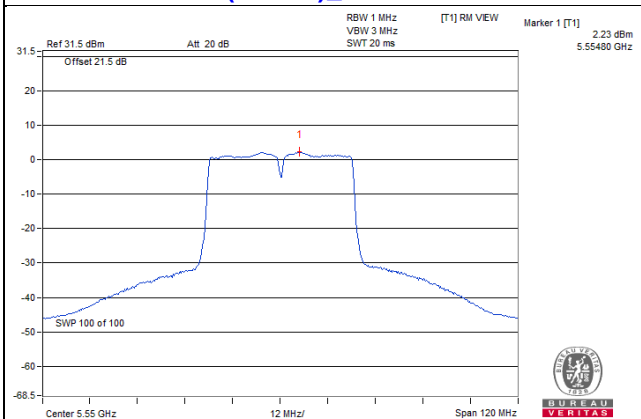

802.11ac (VHT80)_Chain 2 / CH122

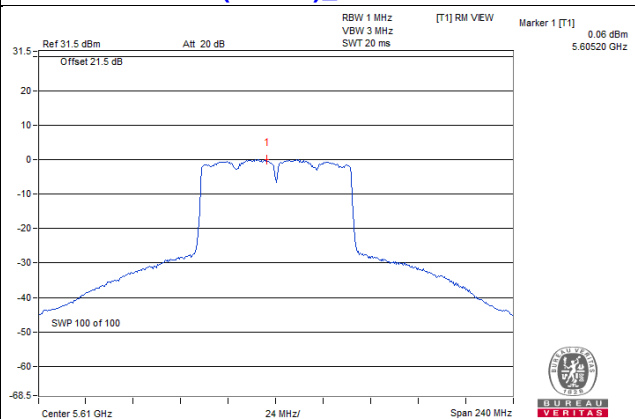

For U-NII-3:

802.11a

Chan.	Freq. (MHz)	PSD (dBm/300kHz)			Total PSD		Total PSD (dBm/500kHz)	Limit (dBm/500kHz)	Pass /Fail
		Chain 0	Chain 1	Chain 2	mW/300kHz	dBm/300kHz			
144 (U-NII-3 Band)	5720	-6.60	-6.37	-6.80	0.6584	-1.82	0.40	26.11	Pass

- Note: 1. Method b) Measure and sum spectral maxima across the outputs of KDB 662911 is using for calculating total power density.
 2. Directional gain = $10 \log[(10^{G0/20} + 10^{G1/20} + 10^{G2/20})^2 / 3] = 9.89\text{dBi} > 6\text{dBi}$, so the power density limit shall be reduced to $30 - (9.89 - 6) = 26.11\text{dBm}$.

802.11ac (VHT20)

Chan.	Freq. (MHz)	PSD (dBm/300kHz)			Total PSD		Total PSD (dBm/500kHz)	Limit (dBm/500kHz)	Pass /Fail
		Chain 0	Chain 1	Chain 2	mW/300kHz	dBm/300kHz			
144 (U-NII-3 Band)	5720	-7.18	-7.15	-7.32	0.5695	-2.45	-0.23	26.11	Pass

- Note: 1. Method b) Measure and sum spectral maxima across the outputs of KDB 662911 is using for calculating total power density.
 2. Directional gain = $10 \log[(10^{G0/20} + 10^{G1/20} + 10^{G2/20})^2 / 3] = 9.89\text{dBi} > 6\text{dBi}$, so the power density limit shall be reduced to $30 - (9.89 - 6) = 26.11\text{dBm}$.

802.11ac (VHT40)

Chan.	Freq. (MHz)	PSD (dBm/300kHz)			Duty Factor (dB)	Total PSD		Total PSD (dBm/500kHz)	Limit (dBm/500kHz)	Pass /Fail
		Chain 0	Chain 1	Chain 2		mW/300kHz	dBm/300kHz			
142 (U-NII-3 Band)	5710	-8.32	-7.94	-8.08	0.09	0.4738	-3.24	-1.02	26.11	Pass

- Note: 1. Method b) Measure and sum spectral maxima across the outputs of KDB 662911 is using for calculating total power density.
 2. Directional gain = $10 \log[(10^{G0/20} + 10^{G1/20} + 10^{G2/20})^2 / 3] = 9.89\text{dBi} > 6\text{dBi}$, so the power density limit shall be reduced to $30 - (9.89 - 6) = 26.11\text{dBm}$.
 3. Refer to section 3.3 for duty cycle spectrum plot.

802.11ac (VHT80)

Chan.	Freq. (MHz)	PSD (dBm/300kHz)			Duty Factor (dB)	Total PSD		Total PSD (dBm/500kHz)	Limit (dBm/500kHz)	Pass /Fail
		Chain 0	Chain 1	Chain 2		mW/300kHz	dBm/300kHz			
138 (U-NII-3 Band)	5690	-10.58	-10.74	-10.99	0.18	0.26186	-5.82	-3.60	26.11	Pass

- Note: 1. Method b) Measure and sum spectral maxima across the outputs of KDB 662911 is using for calculating total power density.
 2. Directional gain = $10 \log[(10^{G0/20} + 10^{G1/20} + 10^{G2/20})^2 / 3] = 9.89\text{dBi} > 6\text{dBi}$, so the power density limit shall be reduced to $30 - (9.89 - 6) = 26.11\text{dBm}$.
 3. Refer to section 3.3 for duty cycle spectrum plot.

Spectrum Plot of Worst Value

802.11a_Chain 1 / CH144 (U-NII-3-Band)

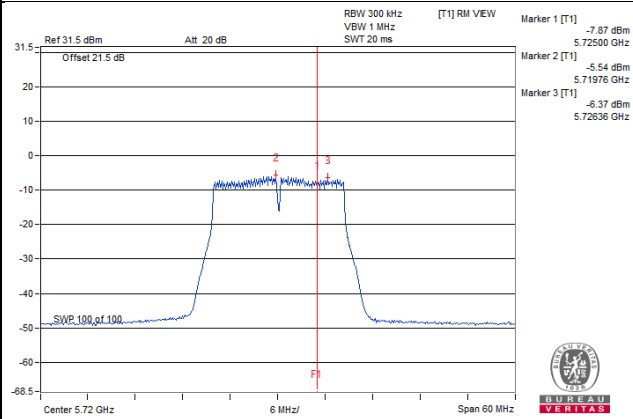

802.11ac (VHT20)_Chain 1 / CH144 (U-NII-3-Band)

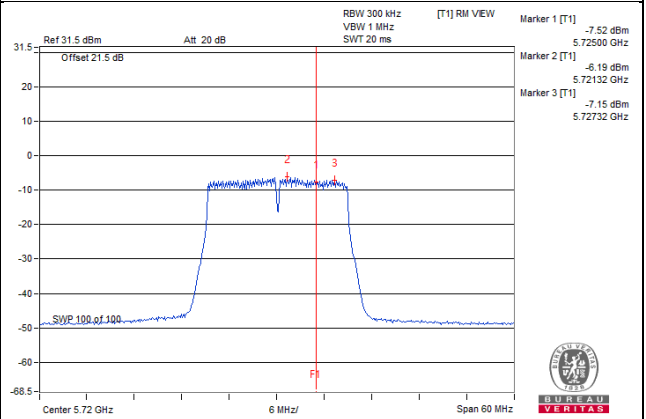

802.11ac (VHT40)_Chain 1 / CH142 (U-NII-3-Band)

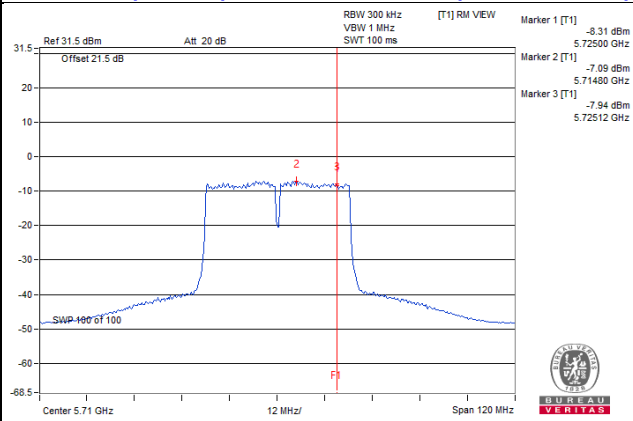

802.11ac (VHT80)_Chain 0 / CH138 (U-NII-3-Band)

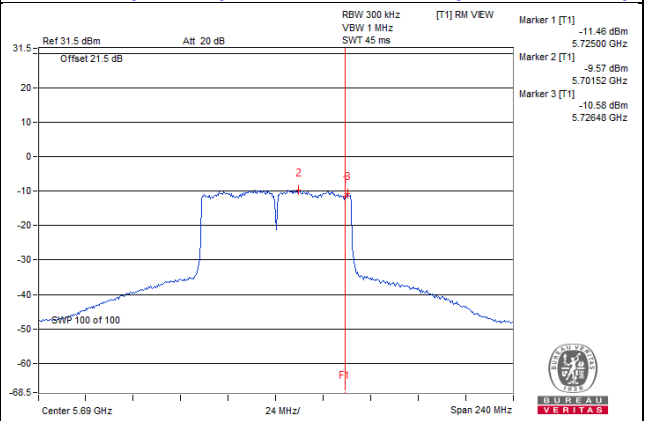

4.6 Frequency Stability Measurement

4.6.1 Limits of Frequency Stability Measurement

The frequency of the carrier signal shall be maintained within band of operation

4.6.2 Test Setup

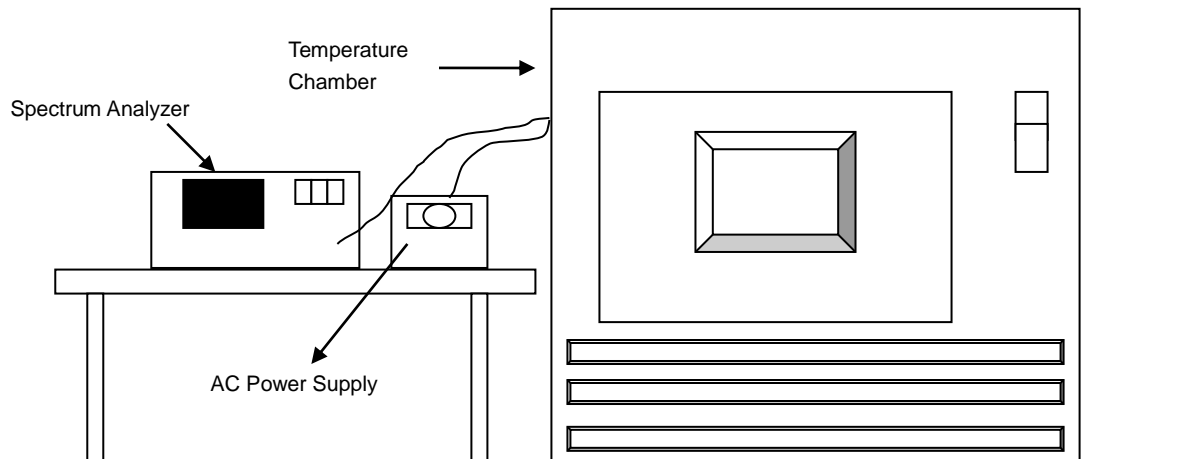

4.6.3 Test Instruments

Refer to section 4.1.2 to get information of above instrument.

4.6.4 Test Procedure

- The EUT was placed inside the environmental test chamber and powered by nominal AC voltage.
- Turn the EUT on and couple its output to a spectrum analyzer.
- Turn the EUT off and set the chamber to the highest temperature specified.
- Allow sufficient time (approximately 30 min) for the temperature of the chamber to stabilize, turn the EUT on and measure the operating frequency after 2, 5, and 10 Minutes.
- Repeat step (d) with the temperature chamber set to the next desired temperature until measurements down to the lowest specified temperature have been completed.
- The test chamber was allowed to stabilize at +20 degree C for a minimum of 30 Minutes. The supply voltage was then adjusted on the EUT from 85% to 115% and the frequency record.

4.6.5 Deviation from Test Standard

No deviation.

4.6.6 EUT Operating Condition

Set the EUT transmit at un-modulation mode to test frequency stability.

4.6.7 Test Results

Frequency Stability Versus Temp.									
Operating Frequency: 5260 MHz									
TEMP. (°C)	Power Supply (Vac)	0 Minute		2 Minutes		5 Minutes		10 Minutes	
		Measured Frequency (MHz)	Pass/Fail	Measured Frequency (MHz)	Pass/Fail	Measured Frequency (MHz)	Pass/Fail	Measured Frequency (MHz)	Pass/Fail
50	120	5259.9874	PASS	5259.9888	PASS	5259.9899	PASS	5259.9895	PASS
40	120	5259.9836	PASS	5259.9827	PASS	5259.9841	PASS	5259.9838	PASS
30	120	5260.0078	PASS	5260.0039	PASS	5260.0048	PASS	5260.0036	PASS
20	120	5259.9906	PASS	5259.988	PASS	5259.9874	PASS	5259.9905	PASS
10	120	5260.014	PASS	5260.0103	PASS	5260.0141	PASS	5260.0129	PASS
0	120	5260.0045	PASS	5260.0016	PASS	5260.0005	PASS	5260.0013	PASS
-10	120	5259.9899	PASS	5259.9861	PASS	5259.9889	PASS	5259.9861	PASS
-20	120	5259.9765	PASS	5259.9767	PASS	5259.9766	PASS	5259.9783	PASS
-30	120	5259.994	PASS	5259.9967	PASS	5259.9969	PASS	5259.9962	PASS

Frequency Stability Versus Voltage									
Operating Frequency: 5260 MHz									
TEMP. (°C)	Power Supply (Vac)	0 Minute		2 Minutes		5 Minutes		10 Minutes	
		Measured Frequency (MHz)	Pass/Fail	Measured Frequency (MHz)	Pass/Fail	Measured Frequency (MHz)	Pass/Fail	Measured Frequency (MHz)	Pass/Fail
20	138	5259.9911	PASS	5259.9878	PASS	5259.9878	PASS	5259.9907	PASS
	120	5259.9906	PASS	5259.988	PASS	5259.9874	PASS	5259.9905	PASS
	102	5259.9903	PASS	5259.9874	PASS	5259.988	PASS	5259.9909	PASS

4.7 6dB Bandwidth Measurement

4.7.1 Limits of 6dB Bandwidth Measurement

The minimum of 6dB Bandwidth Measurement is 0.5MHz.

4.7.2 Test Setup

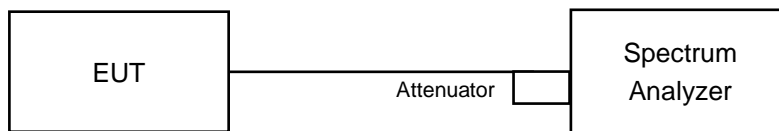

4.7.3 Test Instruments

Refer to section 4.1.2 to get information of above instrument.

4.7.4 Test Procedure

MEASUREMENT PROCEDURE REF

- Set resolution bandwidth (RBW) = 100kHz
- Set the video bandwidth (VBW) $\geq 3 \times$ RBW, Detector = Peak.
- Trace mode = max hold.
- Sweep = auto couple.
- Measure the maximum width of the emission that is constrained by the frequencies associated with the two amplitude points (upper and lower) that are attenuated by 6 dB relative to the maximum level measured in the fundamental emission

4.7.5 Deviation from Test Standard

No deviation.

4.7.6 EUT Operating Condition

The software provided by client to enable the EUT under transmission condition continuously at lowest, middle and highest channel frequencies individually.

4.7.7 Test Results

802.11a

Channel	Frequency (MHz)	6dB Bandwidth (MHz)			Minimum Limit (MHz)	Pass / Fail
		Chain 0	Chain 1	Chain 2		
144 (U-NII-3 Band)	5720	3.26	3.27	3.29	0.5	Pass

802.11ac (VHT20)

Channel	Frequency (MHz)	6dB Bandwidth (MHz)			Minimum Limit (MHz)	Pass / Fail
		Chain 0	Chain 1	Chain 2		
144 (U-NII-3 Band)	5720	3.88	3.89	3.90	0.5	Pass

802.11ac (VHT40)

Channel	Frequency (MHz)	6dB Bandwidth (MHz)			Minimum Limit (MHz)	Pass / Fail
		Chain 0	Chain 1	Chain 2		
142 (U-NII-3 Band)	5710	3.30	3.33	3.32	0.5	Pass

802.11ac (VHT80)

Channel	Frequency (MHz)	6dB Bandwidth (MHz)			Minimum Limit (MHz)	Pass / Fail
		Chain 0	Chain 1	Chain 2		
138 (U-NII-3 Band)	5690	2.90	3.41	3.04	0.5	Pass

Spectrum Plot of Worst Value

802.11a_Chain 0 / CH144 (U-NII-3Band)

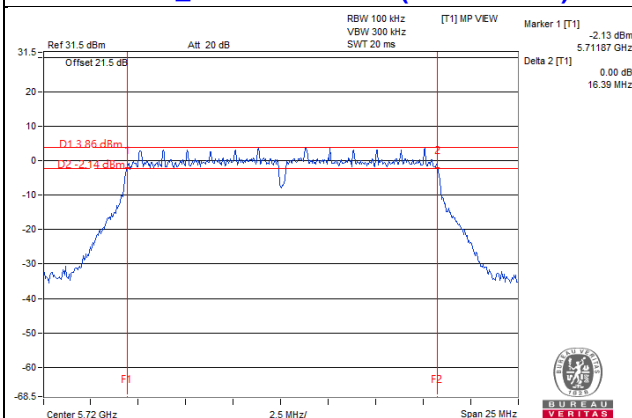

802.11ac (VHT20)_Chain 0 / CH144 (U-NII-3Band)

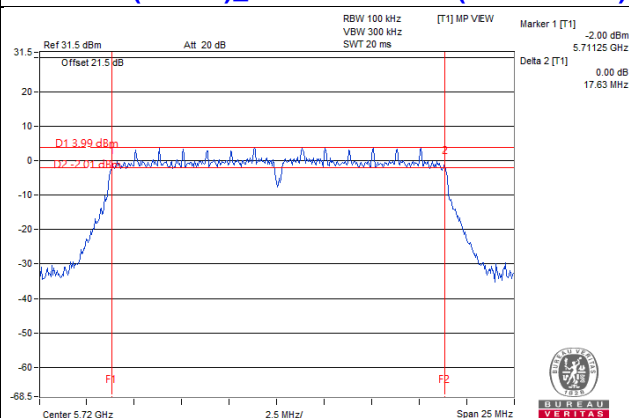

802.11ac (VHT40)_Chain 0 / CH142 (U-NII-3Band)

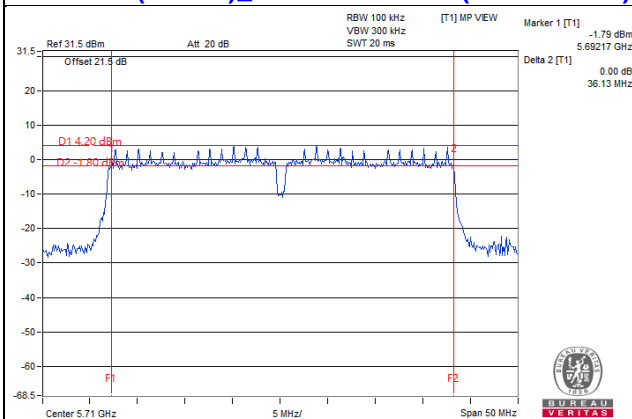

802.11ac (VHT80)_Chain 0 / CH138 (U-NII-3Band)

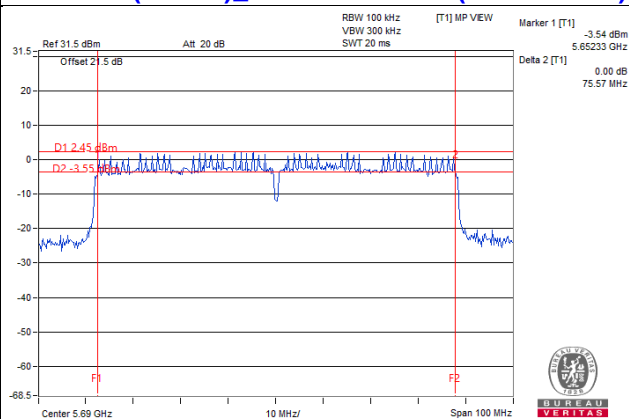

Note: The 6dB bandwidth above 5725MHz = Marker 1 + Delta 2 - 5725MHz

5 Pictures of Test Arrangements

Please refer to the attached file (Test Setup Photo).

Appendix – Information of the Testing Laboratories

We, Bureau Veritas Consumer Products Services (H.K.) Ltd., Taoyuan Branch, were founded in 1988 to provide our best service in EMC, Radio, Telecom and Safety consultation. Our laboratories are FCC recognized accredited test firms and accredited according to ISO/IEC 17025.

If you have any comments, please feel free to contact us at the following:

Lin Kou EMC/RF Lab

Tel: 886-2-26052180

Fax: 886-2-26051924

Hsin Chu EMC/RF/Telecom Lab

Tel: 886-3-6668565

Fax: 886-3-6668323

Hwa Ya EMC/RF/Safety Lab

Tel: 886-3-3183232

Fax: 886-3-3270892

Email: service.adt@tw.bureauveritas.com

Web Site: www.bureauveritas-adt.com

The address and road map of all our labs can be found in our web site also.

--- END ---