

## FCC Test Report (DFS Band)

**Report No.:** RF160614E05G-1

**FCC ID:** VW3FAST3686

**Test Model:** F@ST 3686 V2.2

**Received Date:** Oct. 20, 2017

**Test Date:** Nov. 14 to 28, 2017

**Issued Date:** Dec. 22, 2017

**Applicant:** SAGEMCOM Broadband SAS

**Address:** 250 Route de l'Empereur - 92848 RUEIL MALMAISON CEDEX- FRANCE

**Issued By:** Bureau Veritas Consumer Products Services (H.K.) Ltd., Taoyuan Branch  
Hsin Chu Laboratory

**Lab Address:** E-2, No.1, Li Hsin 1st Road, Hsinchu Science Park, Hsinchu City 300,  
Taiwan R.O.C.

**Test Location:** E-2, No.1, Li Hsin 1st Road, Hsinchu Science Park, Hsinchu City 300,  
Taiwan R.O.C.

**FCC Registration /  
Designation Number:** 723255 / TW2022



This report is for your exclusive use. Any copying or replication of this report to or for any other person or entity, or use of our name or trademark, is permitted only with our prior written permission. This report sets forth our findings solely with respect to the test samples identified herein. The results set forth in this report are not indicative or representative of the quality or characteristics of the lot from which a test sample was taken or any similar or identical product unless specifically and expressly noted. Our report includes all of the tests requested by you and the results thereof based upon the information that you provided to us. You have 60 days from date of issuance of this report to notify us of any material error or omission caused by our negligence, provided, however, that such notice shall be in writing and shall specifically address the issue you wish to raise. A failure to raise such issue within the prescribed time shall constitute your unqualified acceptance of the completeness of this report, the tests conducted and the correctness of the report contents. Unless specific mention, the uncertainty of measurement has been explicitly taken into account to declare the compliance or non-compliance to the specification. The report must not be used by the client to claim product certification, approval, or endorsement by TAF or any government agencies.

## Table of Contents

<b>Release Control Record</b> .....	<b>4</b>
<b>1 Certificate of Conformity</b> .....	<b>5</b>
<b>2 Summary of Test Results</b> .....	<b>6</b>
2.1 Measurement Uncertainty .....	6
2.2 Modification Record .....	6
<b>3 General Information</b> .....	<b>7</b>
3.1 General Description of EUT (DFS Band) .....	7
3.2 Description of Test Modes .....	9
3.2.1 Test Mode Applicability and Tested Channel Detail .....	10
3.3 Duty Cycle of Test Signal .....	12
3.4 Description of Support Units .....	13
3.4.1 Configuration of System under Test .....	14
3.5 General Description of Applied Standard .....	15
<b>4 Test Types and Results</b> .....	<b>16</b>
4.1 Radiated Emission and Bandedge Measurement .....	16
4.1.1 Limits of Radiated Emission and Bandedge Measurement .....	16
4.1.2 Test Instruments .....	17
4.1.3 Test Procedure .....	19
4.1.4 Deviation from Test Standard .....	19
4.1.5 Test Setup .....	20
4.1.6 EUT Operating Condition .....	21
4.1.7 Test Results .....	22
4.2 Conducted Emission Measurement .....	72
4.2.1 Limits of Conducted Emission Measurement .....	72
4.2.2 Test Instruments .....	72
4.2.3 Test Procedure .....	73
4.2.4 Deviation from Test Standard .....	73
4.2.5 Test Setup .....	73
4.2.6 EUT Operating Condition .....	73
4.2.7 Test Results .....	74
4.3 Transmit Power Measurement .....	76
4.3.1 Limits of Transmit Power Measurement .....	76
4.3.2 Test Setup .....	77
4.3.3 Test Instruments .....	77
4.3.4 Test Procedure .....	78
4.3.5 Deviation from Test Standard .....	78
4.3.6 EUT Operating Condition .....	78
4.3.7 Test Result .....	79
4.4 Occupied Bandwidth Measurement .....	95
4.4.1 Test Setup .....	95
4.4.2 Test Instruments .....	95
4.4.3 Test Procedure .....	95
4.4.4 Test Results .....	96
4.5 Peak Power Spectral Density Measurement .....	99
4.5.1 Limits of Peak Power Spectral Density Measurement .....	99
4.5.2 Test Setup .....	99
4.5.3 Test Instruments .....	99
4.5.4 Test Procedure .....	100
4.5.5 Deviation from Test Standard .....	100
4.5.6 EUT Operating Condition .....	100
4.5.7 Test Results .....	101
4.6 Frequency Stability Measurement .....	107
4.6.1 Limits of Frequency Stability Measurement .....	107

4.6.2	Test Setup.....	107
4.6.3	Test Instruments .....	107
4.6.4	Test Procedure .....	107
4.6.5	Deviation from Test Standard .....	107
4.6.6	EUT Operating Condition .....	107
4.6.7	Test Results .....	108
4.7	6dB Bandwidth Measurement .....	109
4.7.1	Limits of 6dB Bandwidth Measurement.....	109
4.7.2	Test Setup.....	109
4.7.3	Test Instruments .....	109
4.7.4	Test Procedure .....	109
4.7.5	Deviation from Test Standard .....	109
4.7.6	EUT Operating Condition .....	109
4.7.7	Test Results .....	110
<b>5</b>	<b>Pictures of Test Arrangements.....</b>	<b>112</b>
	<b>Appendix – Information on the Testing Laboratories .....</b>	<b>113</b>

### Release Control Record

Issue No.	Description	Date Issued
RF160614E05G-1	Original release.	Dec. 22, 2017

## 1 Certificate of Conformity

**Product:** Euro-DOCSIS3.0

**Brand:** Sagemcom

**Test Model:** F@ST 3686 V2.2

**Sample Status:** ENGINEERING SAMPLE

**Applicant:** SAGEMCOM Broadband SAS

**Test Date:** Nov. 14 to 28, 2017

**Standard:** 47 CFR FCC Part 15, Subpart E (Section 15.407)  
ANSI C63.10: 2013

The above equipment has been tested by **Bureau Veritas Consumer Products Services (H.K.) Ltd., Taoyuan Branch**, and found compliance with the requirement of the above standards. The test record, data evaluation & Equipment Under Test (EUT) configurations represented herein are true and accurate accounts of the measurements of the sample's EMC characteristics under the conditions specified in this report.

**Prepared by :**  , **Date:** Dec. 22, 2017  
Claire Kuan / Specialist

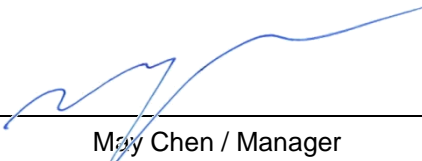
**Approved by :**  , **Date:** Dec. 22, 2017  
May Chen / Manager

## 2 Summary of Test Results

47 CFR FCC Part 15, Subpart E (Section 15.407)			
FCC Clause	Test Item	Result	Remarks
15.407(b)(6)	AC Power Conducted Emissions	Pass	Meet the requirement of limit. Minimum passing margin is -9.37dB at 0.15000MHz.
15.407(b) (1/2/3/4(i/ii)/6)	Radiated Emissions & Band Edge Measurement*	Pass	Meet the requirement of limit. Minimum passing margin is -0.1dB at 5351.00MHz, 5468.50MHz, 5468.8MHz
15.407(a)(1/2/3)	Max Average Transmit Power	Pass	Meet the requirement of limit.
---	Occupied Bandwidth Measurement	-	Reference only.
15.407(a)(1/2/3)	Peak Power Spectral Density	Pass	Meet the requirement of limit.
15.407(e)	6dB bandwidth	Pass	Meet the requirement of limit. (U-NII-3 Band only)
15.407(g)	Frequency Stability	Pass	Meet the requirement of limit.
15.203	Antenna Requirement	Pass	Antenna connector is i-pex(MHF) not a standard connector.

### 2.1 Measurement Uncertainty

Where relevant, the following measurement uncertainty levels have been estimated for tests performed on the EUT as specified in CISPR 16-4-2:

Measurement	Frequency	Expanded Uncertainty (k=2) (±)
Conducted Emissions at mains ports	150kHz ~ 30MHz	1.84 dB
Radiated Emissions up to 1 GHz	30MHz ~ 1GHz	5.30 dB
Radiated Emissions above 1 GHz	1GHz ~ 6GHz	5.16 dB
	6GHz ~ 18GHz	4.91 dB
	18GHz ~ 40GHz	5.30 dB

### 2.2 Modification Record

There were no modifications required for compliance.

### 3 General Information

#### 3.1 General Description of EUT (DFS Band)

Product	Euro-DOCSIS3.0
Brand	Sagemcom
Test Model	F@ST 3686 V2.2
Status of EUT	ENGINEERING SAMPLE
Power Supply Rating	12Vdc from adapter
Modulation Type	256QAM, 64QAM, 16QAM, QPSK, BPSK
Modulation Technology	OFDM
Transfer Rate	802.11a: up to 54Mbps 802.11n: up to 450Mbps 802.11ac: up to 1300Mbps
Operating Frequency	5260 ~ 5320MHz, 5500 ~ 5720MHz
Number of Channel	5260 ~ 5320MHz: 802.11a, 802.11n (HT20), 802.11ac (VHT20): 4 802.11n (HT40), 802.11ac (VHT40): 2 802.11ac (VHT80): 1 5500 ~ 5720MHz: 802.11a, 802.11n (HT20), 802.11ac (VHT20): 12 802.11n (HT40), 802.11ac (VHT40): 6 802.11ac (VHT80): 3
Output Power	<b>CDD Mode:</b> <b>5.26GHz ~ 5.32GHz:</b> 237.944mW <b>5.50GHz ~ 5.72GHz:</b> 249.215mW <b>Beamforming Mode:</b> <b>5.26GHz ~ 5.32GHz:</b> 135.436mW <b>5.50GHz ~ 5.72GHz:</b> 136.886mW
Antenna Type	Refer to Note
Antenna Connector	Refer to Note
Accessory Device	Adapter x 1
Data Cable Supplied	RJ-45 cable (Unshielded, 1.5m) coaxial cable (shielded, 2m)

Note:

- This report is prepared for FCC class II change. The difference compared with the Report No.: RF160614E05F-1 as the following information:
  - ◆ Add DFS band <5.26~ 5.32GHz, 5.50 ~ 5.72GHz>.
- According to above condition, all test items need to be performed. And all data were verified to meet the requirements.
- Simultaneously transmission condition.

Condition	Technology	
1	WLAN (2.4GHz)	WLAN (5GHz)

**Note:** The emission of the simultaneous operation has been evaluated and no non-compliance was found.

- The EUT power needs to be supplied from a power adapter, the information is as below table:

Brand	Model No.	Spec.
SAGEMCOM	NBS30E120250VU	Input: 100-240Vac, 0.9A, 50/60Hz Output: 12V, 2.5A DC output cable: Unshielded 2m

5. The antennas provided to the EUT, please refer to the following table:

Ant. No.	Chain No.	Antenna Gain (dBi)	Frequency range (GHz)	Antenna Type	Connector Type	Cable loss (dB)	Cable Length (mm)
1	Chain (0)	3.3	5.15~5.850	PIFA	NA	NA	NA
		2.5	2.4~2.4835				
2	Chain (1)	4.6	5.15~5.850	PCB	i-pex(MHF)	1.58	250
3	Chain (2)	3.6	5.15~5.850	PIFA	NA	NA	NA
	Chain (1)	2.8	2.4~2.4835				

6. The EUT incorporates a MIMO function:

2.4GHz Band			
MODULATION MODE	DATA RATE (MCS)	TX & RX CONFIGURATION	
802.11b	1 ~ 11Mbps	1TX diversity	1RX
802.11g	6 ~ 54Mbps	2TX	2RX
802.11n (HT20)	MCS 0~7	2TX	2RX
	MCS 8~15	2TX	2RX
802.11n (HT40)	MCS 0~7	2TX	2RX
	MCS 8~15	2TX	2RX
5GHz Band			
MODULATION MODE	DATA RATE (MCS)	TX & RX CONFIGURATION	
802.11a	6 ~ 54Mbps	3TX	3RX
802.11n (HT20)	MCS 0~7	3TX	3RX
	MCS 8~15	3TX	3RX
	MCS 16~23	3TX	3RX
802.11n (HT40)	MCS 0~7	3TX	3RX
	MCS 8~15	3TX	3RX
	MCS 16~23	3TX	3RX
802.11ac (VHT20)	MCS 0~8, NSS=1	3TX	3RX
	MCS 0~8, NSS=2	3TX	3RX
	MCS 0~9, NSS=3	3TX	3RX
802.11ac (VHT40)	MCS 0~9, NSS=1	3TX	3RX
	MCS 0~9, NSS=2	3TX	3RX
	MCS 0~9, NSS=3	3TX	3RX
802.11ac (VHT80)	MCS 0~9, NSS=1	3TX	3RX
	MCS 0~9, NSS=2	3TX	3RX
	MCS 0~9, NSS=3	3TX	3RX

Note:

- All of modulation mode support beamforming function except 2.4GHz and 802.11a modulation mode.
- The EUT support Beamforming and CDD mode, therefore both mode were investigated and the worst case scenario was identified. The worst case data were presented in test report.
- The modulation and bandwidth are similar for 802.11n mode for 20MHz (40MHz) and 802.11ac mode for 20MHz (40MHz), therefore investigated worst case to representative mode in test report. (Final test mode refer section 3.2.1)

7. The above EUT information is declared by manufacturer and for more detailed features description, please refer to the manufacturer's specifications or user's manual.



### 3.2 Description of Test Modes

#### FOR 5260 ~ 5320MHz

4 channels are provided for 802.11a, 802.11n (HT20), 802.11ac (VHT20):

Channel	Frequency	Channel	Frequency
52	5260 MHz	60	5300 MHz
56	5280 MHz	64	5320 MHz

2 channels are provided for 802.11n (HT40), 802.11ac (VHT40):

Channel	Frequency	Channel	Frequency
54	5270 MHz	62	5310 MHz

1 channel is provided for 802.11ac (VHT80):

Channel	Frequency
58	5290 MHz

#### FOR 5500 ~ 5720MHz

12 channels are provided for 802.11a, 802.11n (HT20), 802.11ac (VHT20):

Channel	Frequency	Channel	Frequency
100	5500 MHz	124	5620 MHz
104	5520 MHz	128	5640 MHz
108	5540 MHz	132	5660 MHz
112	5560 MHz	136	5680 MHz
116	5580 MHz	140	5700 MHz
120	5600 MHz	144	5720 MHz

6 channels are provided for 802.11n (HT40), 802.11ac (VHT40):

Channel	Frequency	Channel	Frequency
102	5510 MHz	126	5630 MHz
110	5550 MHz	134	5670 MHz
118	5590 MHz	142	5710 MHz

3 channels are provided for 802.11ac (VHT80):

Channel	Frequency	Channel	Frequency
106	5530 MHz	122	5610 MHz
138	5690 MHz		

### 3.2.1 Test Mode Applicability and Tested Channel Detail

EUT Configure Mode	Applicable To				Description
	RE $\geq$ 1G	RE<1G	PLC	APCM	
-	√	√	√	√	-

Where **RE $\geq$ 1G**: Radiated Emission above 1GHz      **RE<1G**: Radiated Emission below 1GHz  
**PLC**: Power Line Conducted Emission      **APCM**: Antenna Port Conducted Measurement

#### **Radiated Emission Test (Above 1GHz):**

- Pre-Scan has been conducted to determine the worst-case mode from all possible combinations between available modulations, data rates and antenna ports (if EUT with antenna diversity architecture).
- Following channel(s) was (were) selected for the final test as listed below.

CDD Mode						
Mode	FREQ. Band (MHz)	Available Channel	Tested Channel	Modulation Technology	Modulation Type	Data Rate (Mbps)
802.11a	5260-5320	52 to 64	52, 60, 64	OFDM	BPSK	6
802.11ac (VHT20)		52 to 64	52, 60, 64	OFDM	BPSK	6.5
802.11ac (VHT40)		54 to 62	54, 62	OFDM	BPSK	13.5
802.11ac (VHT80)		58	58	OFDM	BPSK	29.3
802.11a	5500-5720	100 to 144	100, 116, 140, 144	OFDM	BPSK	6
802.11ac (VHT20)		100 to 144	100, 116, 140, 144	OFDM	BPSK	6.5
802.11ac (VHT40)		102 to 142	102, 110, 134, 142	OFDM	BPSK	13.5
802.11ac (VHT80)		106 to 138	106, 122, 138	OFDM	BPSK	29.3

#### **Radiated Emission Test (Below 1GHz):**

- Pre-Scan has been conducted to determine the worst-case mode from all possible combinations between available modulations, data rates and antenna ports (if EUT with antenna diversity architecture).
- Following channel(s) was (were) selected for the final test as listed below.

CDD Mode						
Mode	FREQ. Band (MHz)	Available Channel	Tested Channel	Modulation Technology	Modulation Type	Data Rate (Mbps)
802.11ac (VHT80)	5260-5320 5500-5720	58 106 to 138	122	OFDM	BPSK	29.3

### Power Line Conducted Emission Test:

- Pre-Scan has been conducted to determine the worst-case mode from all possible combinations between available modulations, data rates and antenna ports (if EUT with antenna diversity architecture).
- Following channel(s) was (were) selected for the final test as listed below.

CDD Mode						
Mode	FREQ. Band (MHz)	Available Channel	Tested Channel	Modulation Technology	Modulation Type	Data Rate (Mbps)
802.11ac (VHT80)	5260-5320 5500-5720	58 106 to 138	122	OFDM	BPSK	29.3

### Antenna Port Conducted Measurement:

- This item includes all test value of each mode, but only includes spectrum plot of worst value of each mode.
- Pre-Scan has been conducted to determine the worst-case mode from all possible combinations between available modulations, data rates and antenna ports (if EUT with antenna diversity architecture).
- Following channel(s) was (were) selected for the final test as listed below.

CDD Mode						
Mode	FREQ. Band (MHz)	Available Channel	Tested Channel	Modulation Technology	Modulation Type	Data Rate (Mbps)
802.11a	5260-5320	52 to 64	52, 60, 64	OFDM	BPSK	6
802.11ac (VHT20)		52 to 64	52, 60, 64	OFDM	BPSK	6.5
802.11ac (VHT40)		54 to 62	54, 62	OFDM	BPSK	13.5
802.11ac (VHT80)		58	58	OFDM	BPSK	29.3
802.11a	5500-5720	100 to 144	100, 116, 140, 144	OFDM	BPSK	6
802.11ac (VHT20)		100 to 144	100, 116, 140, 144	OFDM	BPSK	6.5
802.11ac (VHT40)		102 to 142	102, 110, 134, 142	OFDM	BPSK	13.5
802.11ac (VHT80)		106 to 138	106, 122, 138	OFDM	BPSK	29.3
Beamforming Mode (Output power only)						
Mode	FREQ. Band (MHz)	Available Channel	Tested Channel	Modulation Technology	Modulation Type	Data Rate (Mbps)
802.11ac (VHT20)	5260-5320	52 to 64	52, 60, 64	OFDM	BPSK	6.5
802.11ac (VHT40)		54 to 62	54, 62	OFDM	BPSK	13.5
802.11ac (VHT80)		58	58	OFDM	BPSK	29.3
802.11ac (VHT20)	5500-5720	100 to 144	100, 116, 140, 144	OFDM	BPSK	6.5
802.11ac (VHT40)		102 to 142	102, 110, 134, 142	OFDM	BPSK	13.5
802.11ac (VHT80)		106 to 138	106, 122, 138	OFDM	BPSK	29.3

### Test Condition:

Applicable To	Environmental Conditions	Input Power (system)	Tested By
RE $\geq$ 1G	24deg. C, 71%RH	120Vac, 60Hz	Andy Ho
RE $<$ 1G	24deg. C, 69%RH	120Vac, 60Hz	Andy Ho
PLC	25deg. C, 75%RH	120Vac, 60Hz	Andy Ho
APCM	25deg. C, 60%RH	120Vac, 60Hz	Robert Cheng

### 3.3 Duty Cycle of Test Signal

If duty cycle of test signal is  $\geq 98\%$ , duty factor is not required.

If duty cycle of test signal is  $< 98\%$ , duty factor shall be considered.

**802.11a:** Duty cycle =  $2.063/2.093 = 0.986$

**802.11ac (VHT20):** Duty cycle =  $1.925/1.956 = 0.984$

**802.11ac (VHT40):** Duty cycle =  $0.961/0.992 = 0.969$ , Duty factor =  $10 * \log(1/0.969) = 0.14$

**802.11ac (VHT80):** Duty cycle =  $0.459/0.487 = 0.943$ , Duty factor =  $10 * \log(1/0.969) = 0.26$

#### 802.11a 802.11ac (VHT20)

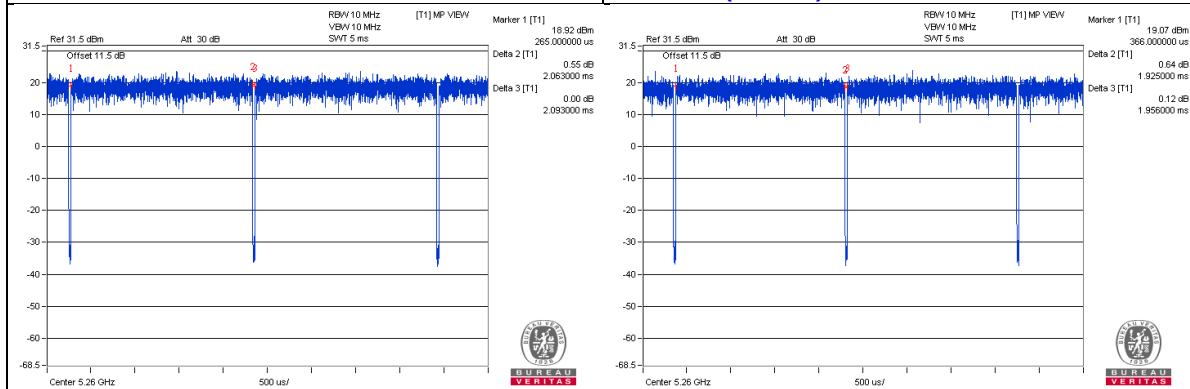

#### 802.11ac (VHT40) 802.11ac (VHT80)

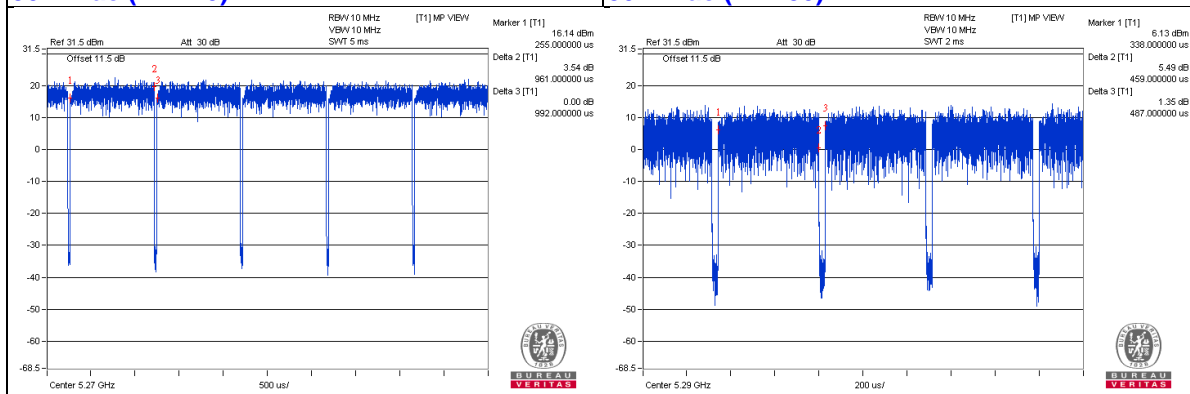

### 3.4 Description of Support Units

The EUT has been tested as an independent unit together with other necessary accessories or support units. The following support units or accessories were used to form a representative test configuration during the tests.

ID	Product	Brand	Model No.	Serial No.	FCC ID	Remarks
A.	Telephone	WONDER	WD-303	7C17KA04011	NA	Provided by Lab
B.	Laptop	DELL	E6420	B92T3R1	FCC DoC	Provided by Lab
C.	iPod	Apple	MD778TA/A	CC4JMFL0F4T1	NA	Provided by Lab

Note:

1. All power cords of the above support units are non-shielded (1.8m).

ID	Descriptions	Qty.	Length (m)	Shielding (Yes/No)	Cores (Qty.)	Remarks
1.	DC Cable	1	2	No	0	Supplied by client
2.	RJ-11 Cable	1	10	No	0	Provided by Lab
3.	RJ-45 Cable	1	10	No	0	Provided by Lab
4.	Coaxial Cable	1	10	Yes	0	Provided by Lab

### 3.4.1 Configuration of System under Test

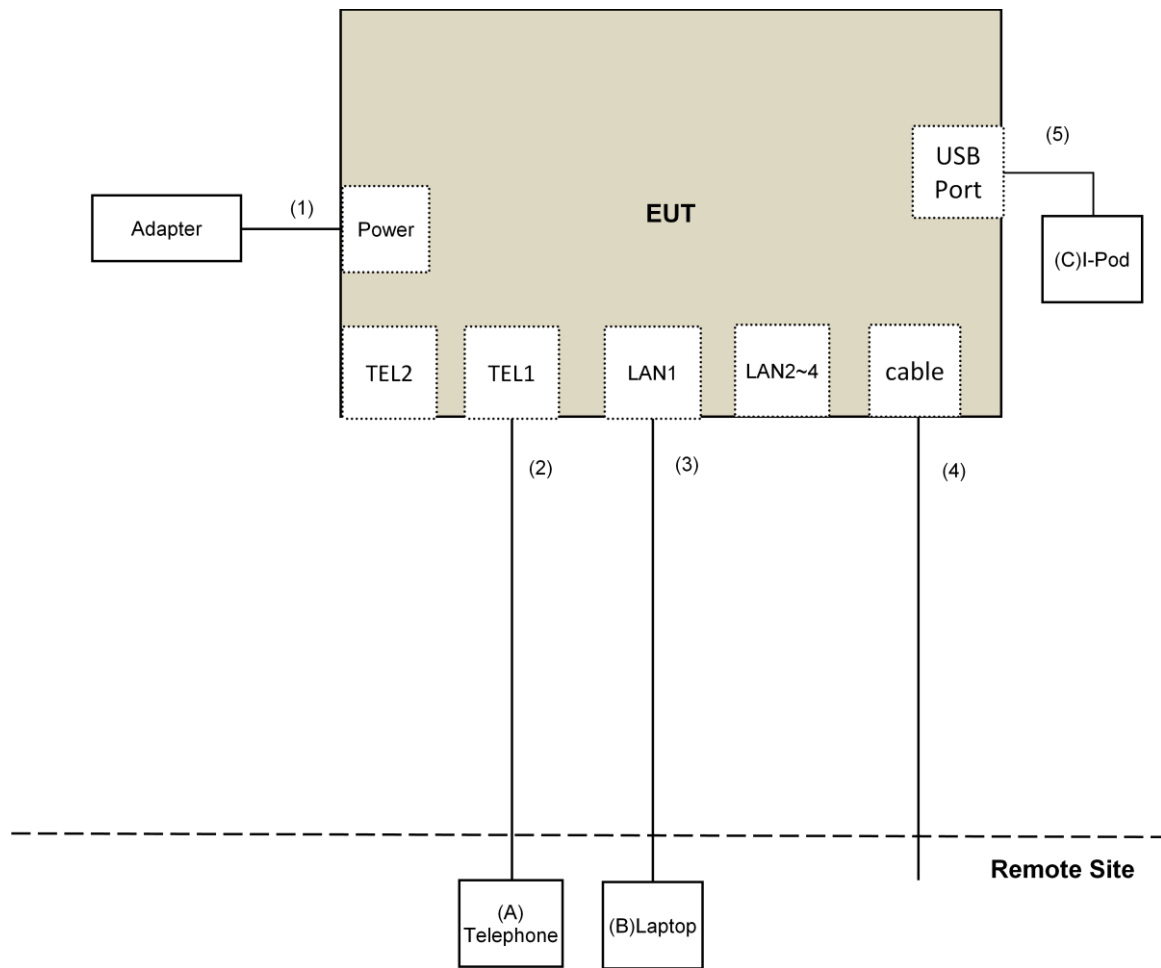

### 3.5 General Description of Applied Standard

The EUT is a RF Product. According to the specifications of the manufacturer, it must comply with the requirements of the following standards:

**FCC Part 15, Subpart E (15.407)**  
**KDB 789033 D02 General UNII Test Procedure New Rules v01r04**  
**KDB 662911 D01 Multiple Transmitter Output v02r01**  
**ANSI C63.10-2013**

All test items have been performed and recorded as per the above standards.

**NOTE:** The EUT has been verified to comply with the requirements of FCC Part 15, Subpart B, Class B (DoC). The test report has been issued separately.

## 4 Test Types and Results

### 4.1 Radiated Emission and Bandedge Measurement

#### 4.1.1 Limits of Radiated Emission and Bandedge Measurement

Radiated emissions which fall in the restricted bands must comply with the radiated emission limits specified as below table.

Frequencies (MHz)	Field Strength (microvolts/meter)	Measurement Distance (meters)
0.009 ~ 0.490	2400/F(kHz)	300
0.490 ~ 1.705	24000/F(kHz)	30
1.705 ~ 30.0	30	30
30 ~ 88	100	3
88 ~ 216	150	3
216 ~ 960	200	3
Above 960	500	3

#### NOTE:

1. The lower limit shall apply at the transition frequencies.
2. Emission level (dBuV/m) = 20 log Emission level (uV/m).
3. For frequencies above 1000MHz, the field strength limits are based on average detector, however, the peak field strength of any emission shall not exceed the maximum permitted average limits, specified above by more than 20dB under any condition of modulation.

Limits of unwanted emission out of the restricted bands

Applicable To		Limit	
789033 D02 General UNII Test Procedure New Rules v01r04		Field Strength at 3m	
		PK:74 (dBuV/m)	AV:54 (dBuV/m)
Frequency Band	Applicable To	EIRP Limit	Equivalent Field Strength at 3m
5150~5250 MHz	15.407(b)(1)	PK:-27 (dBm/MHz)	PK:68.2(dBuV/m)
5250~5350 MHz	15.407(b)(2)		
5470~5725 MHz	15.407(b)(3)		
5725~5850 MHz	<input checked="" type="checkbox"/> 15.407(b)(4)(i)	PK:-27 (dBm/MHz) <sup>*1</sup> PK:10 (dBm/MHz) <sup>*2</sup> PK:15.6 (dBm/MHz) <sup>*3</sup> PK:27 (dBm/MHz) <sup>*4</sup>	PK: 68.2(dBuV/m) <sup>*1</sup> PK:105.2 (dBuV/m) <sup>*2</sup> PK: 110.8(dBuV/m) <sup>*3</sup> PK:122.2 (dBuV/m) <sup>*4</sup>
	<input type="checkbox"/> 15.407(b)(4)(ii)	Emission limits in section 15.247(d)	
<sup>*1</sup> beyond 75 MHz or more above of the band edge.		<sup>*2</sup> below the band edge increasing linearly to 10 dBm/MHz at 25 MHz above.	
<sup>*3</sup> below the band edge increasing linearly to a level of 15.6 dBm/MHz at 5 MHz above.		<sup>*4</sup> from 5 MHz above or below the band edge increasing linearly to a level of 27 dBm/MHz at the band edge.	

#### Note:

The following formula is used to convert the equipment isotropic radiated power (eirp) to field strength:

$$E = \frac{1000000\sqrt{30P}}{3} \mu\text{V/m, where P is the eirp (Watts).}$$



## 4.1.2 Test Instruments

DESCRIPTION & MANUFACTURER	MODEL NO.	SERIAL NO.	CALIBRATED DATE	CALIBRATED UNTIL
Test Receiver Keysight	N9038A	MY54450088	July 08, 2017	July 07, 2018
Pre-Amplifier <sup>(*)</sup> EMCI	EMC001340	980142	Jan. 20, 2016	Jan. 19, 2018
Loop Antenna <sup>(*)</sup> Electro-Metrics	EM-6879	264	Dec. 16, 2016	Dec. 15, 2018
RF Cable	NA	LOOPCAB-001 LOOPCAB-002	Jan. 17, 2017	Jan. 16, 2018
Pre-Amplifier Mini-Circuits	ZFL-1000VH2B	AMP-ZFL-01	Nov. 09, 2017	Nov. 08, 2018
Trilog Broadband Antenna SCHWARZBECK	VULB 9168	9168-406	Dec. 13, 2016	Dec. 12, 2017
RF Cable	8D	966-4-1 966-4-2 966-4-3	Apr. 01, 2017	Mar. 31, 2018
Fixed attenuator Mini-Circuits	UNAT-5+	PAD-3m-4-01	Oct. 03, 2017	Oct. 02, 2018
Horn_Antenna SCHWARZBECK	BBHA 9120D	9120D-783	Dec. 27, 2016	Dec. 26, 2017
Pre-Amplifier EMCI	EMC12630SE	980385	Feb. 02, 2017	Feb. 01, 2018
RF Cable	EMC104-SM-SM-1200 EMC104-SM-SM-2000 EMC104-SM-SM-5000	160923 150318 150321	Feb. 02, 2017 Mar. 29, 2017 Mar. 29, 2017	Feb. 01, 2018 Mar. 28, 2018 Mar. 28, 2018
Pre-Amplifier EMCI	EMC184045SE	980387	Feb. 02, 2017	Feb. 01, 2018
Horn_Antenna SCHWARZBECK	BBHA 9170	BBHA9170608	Dec. 15, 2016	Dec. 14, 2017
RF Cable	SUCOFLEX 102	36432/2 36433/2	Jan. 15, 2017	Jan. 14, 2018
Software	ADT_Radiated_V8.7.08	NA	NA	NA
Antenna Tower & Turn Table Max-Full	MF-7802	MF780208410	NA	NA
Boresight Antenna Fixture	FBA-01	FBA-SIP02	NA	NA
Spectrum Analyzer Agilent	E4446A	MY48250253	Dec. 21, 2016	Dec. 20, 2017
Power meter Anritsu	ML2495A	1014008	May 11, 2017	May 10, 2018
Power sensor Anritsu	MA2411B	0917122	May 11, 2017	May 10, 2018
AC Power Source Extech Electronics	6205	1440452	NA	NA
Temperature & Humidity Chamber Giant Force	GTH-150-40-SP-AR	MAA0812-008	Jan. 11, 2017	Jan. 10, 2018
True RMS Clamp Meter FLUKE	325	31130711WS	May 29, 2017	May 28, 2018

**Note:**

1. The calibration interval of the above test instruments is 12 months and the calibrations are traceable to NML/ROC and NIST/USA.
2. \*The calibration interval of the above test instruments is 24 months and the calibrations are traceable to NML/ROC and NIST/USA.
3. The test was performed in 966 Chamber No. 4.
4. The CANADA Site Registration No. is 20331-2
5. Loop antenna was used for all emissions below 30 MHz.
6. Tested Date: Nov. 14 to 28, 2017

#### 4.1.3 Test Procedure

##### **For Radiated emission below 30MHz**

- a. The EUT was placed on the top of a rotating table 0.8 meters above the ground at a 3 meter chamber room. The table was rotated 360 degrees to determine the position of the highest radiation.
- b. The EUT was set 3 meters away from the interference-receiving antenna, which was mounted on the top of a variable-height antenna tower.
- c. Both X and Y axes of the antenna are set to make the measurement.
- d. For each suspected emission, the EUT was arranged to its worst case and the rotatable table was turned from 0 degrees to 360 degrees to find the maximum reading.
- e. The test-receiver system was set to Quasi-Peak Detect Function and Specified Bandwidth with Maximum Hold Mode.

##### **NOTE:**

1. The resolution bandwidth and video bandwidth of test receiver/spectrum analyzer is 9kHz at frequency below 30MHz.

##### **For Radiated emission above 30MHz**

- a. The EUT was placed on the top of a rotating table 0.8 meters (for 30MHz ~ 1GHz) / 1.5 meters (for above 1GHz) above the ground at 3 meter chamber room for test. The table was rotated 360 degrees to determine the position of the highest radiation.
- b. The EUT was set 3 meters away from the interference-receiving antenna, which was mounted on the top of a variable-height antenna tower.
- c. The height of antenna is varied from one meter to four meters above the ground to determine the maximum value of the field strength. Both horizontal and vertical polarizations of the antenna are set to make the measurement.
- d. For each suspected emission, the EUT was arranged to its worst case and then the antenna was tuned to heights from 1 meter to 4 meters and the rotatable table was turned from 0 degrees to 360 degrees to find the maximum reading.
- e. The test-receiver system was set to quasi-peak detect function and specified bandwidth with maximum hold mode when the test frequency is below 1 GHz.
- f. The test-receiver system was set to peak and average detect function and specified bandwidth with maximum hold mode when the test frequency is above 1 GHz. If the peak reading value also meets average limit, measurement with the average detector is unnecessary.

##### **Note:**

1. The resolution bandwidth and video bandwidth of test receiver/spectrum analyzer is 120kHz for Quasi-peak detection (QP) at frequency below 1GHz.
2. The resolution bandwidth of test receiver/spectrum analyzer is 1 MHz and the video bandwidth is 3 MHz for Peak detection (PK) at frequency above 1GHz.
3. The resolution bandwidth of test receiver/spectrum analyzer is 1MHz and the video bandwidth is  $\geq 1/T$  (Duty cycle < 98%) or 10Hz (Duty cycle  $\geq 98\%$ ) for Average detection (AV) at frequency above 1GHz.
4. All modes of operation were investigated and the worst-case emissions are reported.

#### 4.1.4 Deviation from Test Standard

No deviation.

#### 4.1.5 Test Setup

##### For Radiated emission below 30MHz

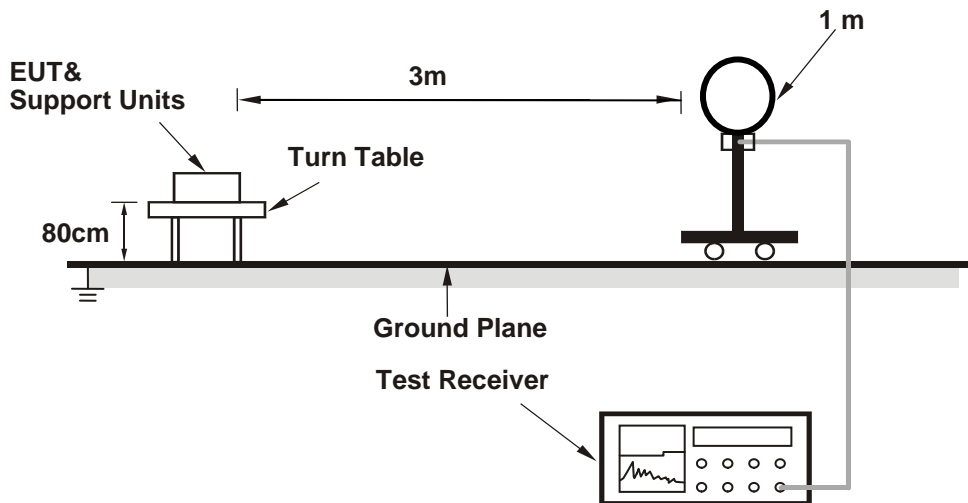

##### For Radiated emission 30MHz to 1GHz

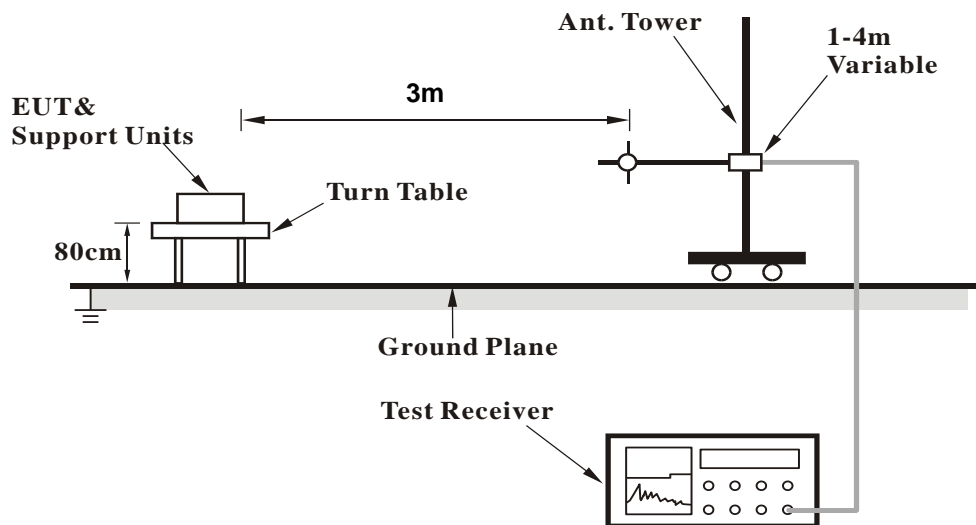

### For Radiated emission above 1GHz

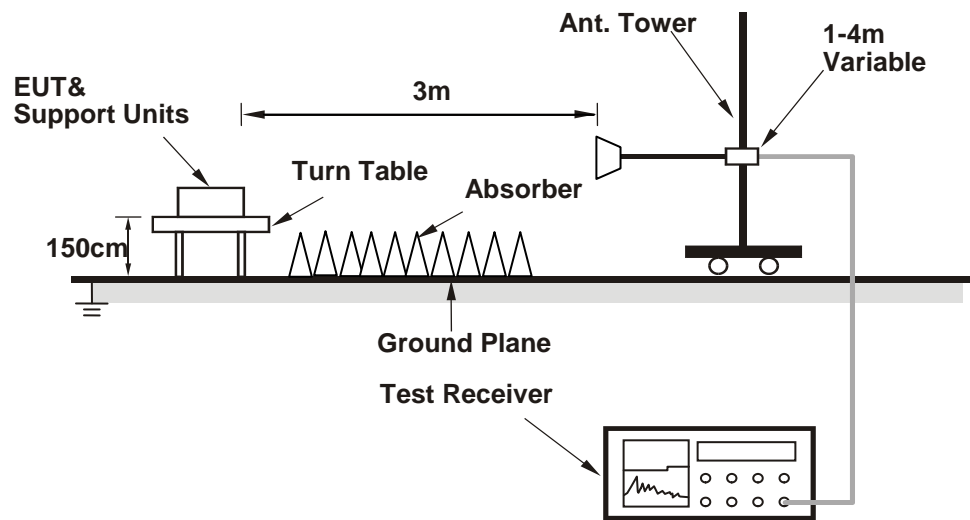

For the actual test configuration, please refer to the attached file (Test Setup Photo).

#### 4.1.6 EUT Operating Condition

- a. Connected the EUT with the Laptop which is placed on remote site.
- b. Controlling software (Mtool V2.0.1.0) has been activated to set the EUT on specific status.

#### 4.1.7 Test Results

#### Above 1GHz Data:

#### 802.11a

<b>CHANNEL</b>	TX Channel 52	<b>DETECTOR FUNCTION</b>	Peak (PK)
<b>FREQUENCY RANGE</b>	1GHz ~ 40GHz		Average (AV)

#### ANTENNA POLARITY & TEST DISTANCE: HORIZONTAL AT 3 M

NO.	FREQ. (MHz)	EMISSION LEVEL (dBuV/m)	LIMIT (dBuV/m)	MARGIN (dB)	ANTENNA HEIGHT (m)	TABLE ANGLE (Degree)	RAW VALUE (dBuV)	CORRECTION FACTOR (dB/m)
1	5098.70	53.6 PK	74.0	-20.4	2.88 H	333	49.7	3.9
2	5098.70	45.0 AV	54.0	-9.0	2.88 H	333	41.1	3.9
3	*5260.00	107.4 PK			2.88 H	333	103.2	4.2
4	*5260.00	97.9 AV			2.88 H	333	93.7	4.2
5	5417.20	57.7 PK	74.0	-16.3	2.88 H	333	53.2	4.5
6	5417.20	48.4 AV	54.0	-5.6	2.88 H	333	43.9	4.5
7	#10520.00	48.4 PK	74.0	-25.6	1.50 H	254	34.6	13.8
8	#10520.00	36.2 AV	54.0	-17.8	1.50 H	254	22.4	13.8
9	15780.00	46.8 PK	74.0	-27.2	1.50 H	239	32.7	14.1
10	15780.00	35.0 AV	54.0	-19.0	1.50 H	239	20.9	14.1

#### REMARKS:

1. Emission Level(dBuV/m) = Raw Value(dBuV) + Correction Factor(dB/m)
2. Correction Factor(dB/m) = Antenna Factor(dB/m) + Cable Factor(dB) – Pre-Amplifier Factor(dB)
3. The other emission levels were very low against the limit.
4. Margin value = Emission Level – Limit value
5. " \* ": Fundamental frequency.
6. " # ": The radiated frequency is out of the restricted band.

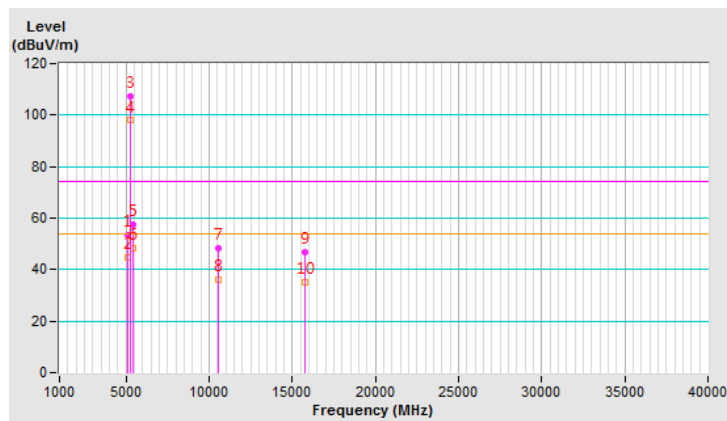

<b>CHANNEL</b>	TX Channel 52	<b>DETECTOR FUNCTION</b>	Peak (PK)
<b>FREQUENCY RANGE</b>	1GHz ~ 40GHz		Average (AV)

**ANTENNA POLARITY & TEST DISTANCE: VERTICAL AT 3 M**

NO.	FREQ. (MHz)	EMISSION LEVEL (dBuV/m)	LIMIT (dBuV/m)	MARGIN (dB)	ANTENNA HEIGHT (m)	TABLE ANGLE (Degree)	RAW VALUE (dBuV)	CORRECTION FACTOR (dB/m)
1	5098.70	55.5 PK	74.0	-18.5	2.61 V	118	51.6	3.9
2	5098.70	46.1 AV	54.0	-7.9	2.61 V	118	42.2	3.9
3	*5260.00	112.1 PK			2.61 V	92	107.9	4.2
4	*5260.00	101.6 AV			2.61 V	92	97.4	4.2
5	5417.20	59.6 PK	74.0	-14.4	2.61 V	152	55.1	4.5
6	5417.20	49.4 AV	54.0	-4.6	2.61 V	152	44.9	4.5
7	#10520.00	51.5 PK	74.0	-22.5	1.46 V	262	37.7	13.8
8	#10520.00	39.6 AV	54.0	-14.4	1.46 V	262	25.8	13.8
9	15780.00	47.6 PK	74.0	-26.4	1.51 V	124	33.5	14.1
10	15780.00	34.7 AV	54.0	-19.3	1.51 V	124	20.6	14.1

**REMARKS:**

1. Emission Level(dBuV/m) = Raw Value(dBuV) + Correction Factor(dB/m)
2. Correction Factor(dB/m) = Antenna Factor(dB/m) + Cable Factor(dB) – Pre-Amplifier Factor(dB)
3. The other emission levels were very low against the limit.
4. Margin value = Emission Level – Limit value
5. " \* ": Fundamental frequency.
6. " # ": The radiated frequency is out of the restricted band.

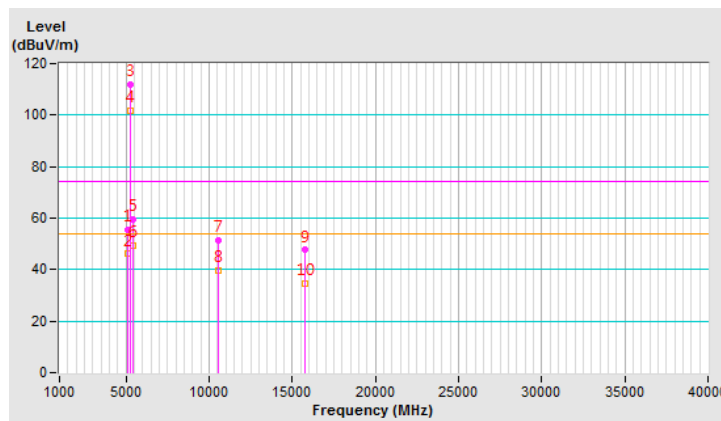

<b>CHANNEL</b>	TX Channel 60	<b>DETECTOR FUNCTION</b>	Peak (PK)
<b>FREQUENCY RANGE</b>	1GHz ~ 40GHz		Average (AV)

**ANTENNA POLARITY & TEST DISTANCE: HORIZONTAL AT 3 M**

NO.	FREQ. (MHz)	EMISSION LEVEL (dBuV/m)	LIMIT (dBuV/m)	MARGIN (dB)	ANTENNA HEIGHT (m)	TABLE ANGLE (Degree)	RAW VALUE (dBuV)	CORRECTION FACTOR (dB/m)
1	*5300.00	107.0 PK			2.86 H	324	102.7	4.3
2	*5300.00	97.9 AV			2.86 H	324	93.6	4.3
3	5458.40	58.4 PK	74.0	-15.6	2.86 H	324	53.9	4.5
4	5458.40	49.0 AV	54.0	-5.0	2.86 H	324	44.5	4.5
5	10600.00	48.6 PK	74.0	-25.4	1.52 H	259	34.8	13.8
6	10600.00	36.5 AV	54.0	-17.5	1.52 H	259	22.7	13.8
7	15900.00	46.5 PK	74.0	-27.5	1.48 H	224	33.3	13.2
8	15900.00	34.7 AV	54.0	-19.3	1.48 H	224	21.5	13.2

**REMARKS:**

1. Emission Level(dBuV/m) = Raw Value(dBuV) + Correction Factor(dB/m)
2. Correction Factor(dB/m) = Antenna Factor(dB/m) + Cable Factor(dB) – Pre-Amplifier Factor(dB)
3. The other emission levels were very low against the limit.
4. Margin value = Emission Level – Limit value
5. " \* ": Fundamental frequency.

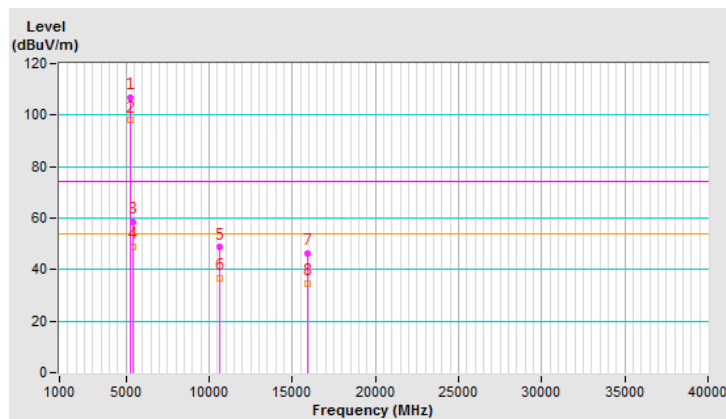



<b>CHANNEL</b>	TX Channel 60	<b>DETECTOR FUNCTION</b>	Peak (PK)
<b>FREQUENCY RANGE</b>	1GHz ~ 40GHz		Average (AV)

**ANTENNA POLARITY & TEST DISTANCE: VERTICAL AT 3 M**

NO.	FREQ. (MHz)	EMISSION LEVEL (dBuV/m)	LIMIT (dBuV/m)	MARGIN (dB)	ANTENNA HEIGHT (m)	TABLE ANGLE (Degree)	RAW VALUE (dBuV)	CORRECTION FACTOR (dB/m)
1	*5300.00	111.7 PK			2.74 V	89	107.4	4.3
2	*5300.00	101.6 AV			2.74 V	89	97.3	4.3
3	5458.40	60.3 PK	74.0	-13.7	2.29 V	126	55.8	4.5
4	5458.40	50.1 AV	54.0	-3.9	2.29 V	126	45.6	4.5
5	10600.00	51.8 PK	74.0	-22.2	1.51 V	257	38.0	13.8
6	10600.00	40.0 AV	54.0	-14.0	1.51 V	257	26.2	13.8
7	15900.00	47.2 PK	74.0	-26.8	1.55 V	125	34.0	13.2
8	15900.00	34.4 AV	54.0	-19.6	1.55 V	125	21.2	13.2

**REMARKS:**

1. Emission Level(dBuV/m) = Raw Value(dBuV) + Correction Factor(dB/m)
2. Correction Factor(dB/m) = Antenna Factor(dB/m) + Cable Factor(dB) – Pre-Amplifier Factor(dB)
3. The other emission levels were very low against the limit.
4. Margin value = Emission Level – Limit value
5. " \* ": Fundamental frequency.

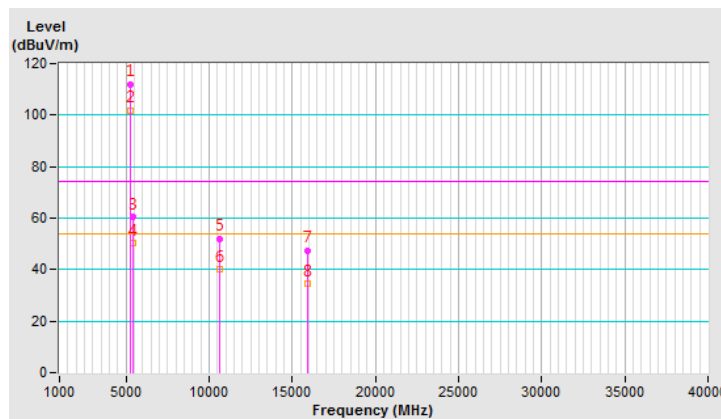

<b>CHANNEL</b>	TX Channel 64	<b>DETECTOR FUNCTION</b>	Peak (PK)
<b>FREQUENCY RANGE</b>	1GHz ~ 40GHz		Average (AV)

**ANTENNA POLARITY & TEST DISTANCE: HORIZONTAL AT 3 M**

NO.	FREQ. (MHz)	EMISSION LEVEL (dBuV/m)	LIMIT (dBuV/m)	MARGIN (dB)	ANTENNA HEIGHT (m)	TABLE ANGLE (Degree)	RAW VALUE (dBuV)	CORRECTION FACTOR (dB/m)
1	*5320.00	107.7 PK			2.84 H	322	103.4	4.3
2	*5320.00	98.3 AV			2.84 H	322	94.0	4.3
3	5350.00	65.1 PK	74.0	-8.9	2.84 H	322	60.7	4.4
4	5350.00	48.6 AV	54.0	-5.4	2.84 H	322	44.2	4.4
5	5394.40	53.7 PK	74.0	-20.3	2.84 H	322	49.3	4.4
6	5394.40	42.3 AV	54.0	-11.7	2.84 H	322	37.9	4.4
7	10640.00	48.5 PK	74.0	-25.5	1.55 H	260	34.5	14.0
8	10640.00	36.5 AV	54.0	-17.5	1.55 H	260	22.5	14.0
9	15960.00	47.0 PK	74.0	-27.0	1.52 H	239	33.5	13.5
10	15960.00	35.4 AV	54.0	-18.6	1.52 H	239	21.9	13.5

**REMARKS:**

1. Emission Level(dBuV/m) = Raw Value(dBuV) + Correction Factor(dB/m)
2. Correction Factor(dB/m) = Antenna Factor(dB/m) + Cable Factor(dB) – Pre-Amplifier Factor(dB)
3. The other emission levels were very low against the limit.
4. Margin value = Emission Level – Limit value
5. " \* ": Fundamental frequency.

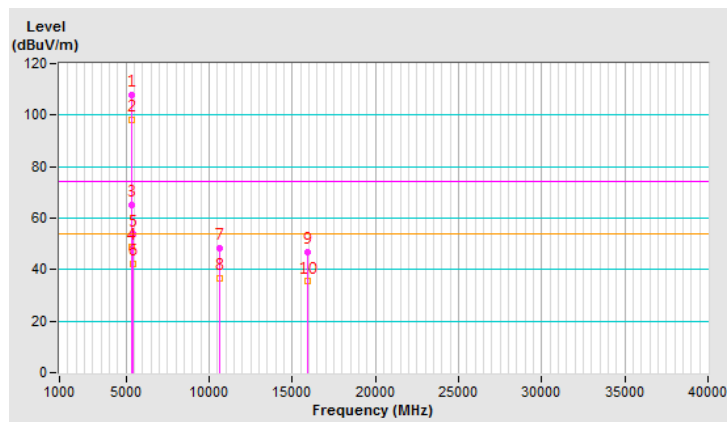

<b>CHANNEL</b>	TX Channel 64	<b>DETECTOR FUNCTION</b>	Peak (PK)
<b>FREQUENCY RANGE</b>	1GHz ~ 40GHz		Average (AV)

**ANTENNA POLARITY & TEST DISTANCE: VERTICAL AT 3 M**

NO.	FREQ. (MHz)	EMISSION LEVEL (dBuV/m)	LIMIT (dBuV/m)	MARGIN (dB)	ANTENNA HEIGHT (m)	TABLE ANGLE (Degree)	RAW VALUE (dBuV)	CORRECTION FACTOR (dB/m)
1	*5320.00	112.4 PK			2.73 V	92	108.1	4.3
2	*5320.00	102.0 AV			2.73 V	92	97.7	4.3
3	5350.00	67.0 PK	74.0	-7.0	2.73 V	92	62.6	4.4
4	5350.00	49.7 AV	54.0	-4.3	2.73 V	92	45.3	4.4
5	5394.40	55.6 PK	74.0	-18.4	2.73 V	116	51.2	4.4
6	5394.40	43.5 AV	54.0	-10.5	2.73 V	116	39.1	4.4
7	10640.00	51.5 PK	74.0	-22.5	1.43 V	271	37.5	14.0
8	10640.00	39.5 AV	54.0	-14.5	1.43 V	271	25.5	14.0
9	15960.00	48.0 PK	74.0	-26.0	1.49 V	119	34.5	13.5
10	15960.00	35.2 AV	54.0	-18.8	1.49 V	119	21.7	13.5

**REMARKS:**

1. Emission Level(dBuV/m) = Raw Value(dBuV) + Correction Factor(dB/m)
2. Correction Factor(dB/m) = Antenna Factor(dB/m) + Cable Factor(dB) – Pre-Amplifier Factor(dB)
3. The other emission levels were very low against the limit.
4. Margin value = Emission Level – Limit value
5. " \* ": Fundamental frequency.

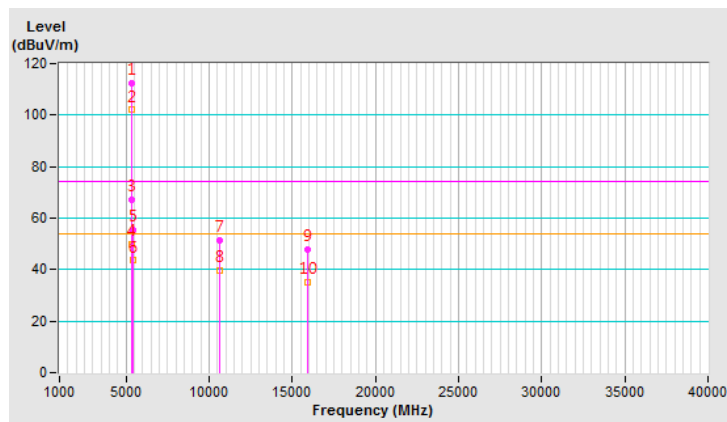

<b>CHANNEL</b>	TX Channel 100	<b>DETECTOR FUNCTION</b>	Peak (PK)
<b>FREQUENCY RANGE</b>	1GHz ~ 40GHz		Average (AV)

**ANTENNA POLARITY & TEST DISTANCE: HORIZONTAL AT 3 M**

NO.	FREQ. (MHz)	EMISSION LEVEL (dBuV/m)	LIMIT (dBuV/m)	MARGIN (dB)	ANTENNA HEIGHT (m)	TABLE ANGLE (Degree)	RAW VALUE (dBuV)	CORRECTION FACTOR (dB/m)
1	5427.00	54.0 PK	74.0	-20.0	2.83 H	329	49.5	4.5
2	5427.00	42.0 AV	54.0	-12.0	2.83 H	329	37.5	4.5
3	#5463.70	65.1 PK	74.0	-8.9	2.83 H	329	60.6	4.5
4	#5463.70	48.2 AV	54.0	-5.8	2.83 H	329	43.7	4.5
5	*5500.00	105.8 PK			2.83 H	329	101.3	4.5
6	*5500.00	97.6 AV			2.83 H	329	93.1	4.5
7	11000.00	51.9 PK	74.0	-22.1	1.48 H	325	37.1	14.8
8	11000.00	38.7 AV	54.0	-15.3	1.48 H	325	23.9	14.8
9	#16500.00	52.2 PK	74.0	-21.8	1.46 H	330	36.6	15.6
10	#16500.00	40.7 AV	54.0	-13.3	1.46 H	330	25.1	15.6

**REMARKS:**

1. Emission Level(dBuV/m) = Raw Value(dBuV) + Correction Factor(dB/m)
2. Correction Factor(dB/m) = Antenna Factor(dB/m) + Cable Factor(dB) – Pre-Amplifier Factor(dB)
3. The other emission levels were very low against the limit.
4. Margin value = Emission Level – Limit value
5. " \* ": Fundamental frequency.
6. " # ": The radiated frequency is out of the restricted band.

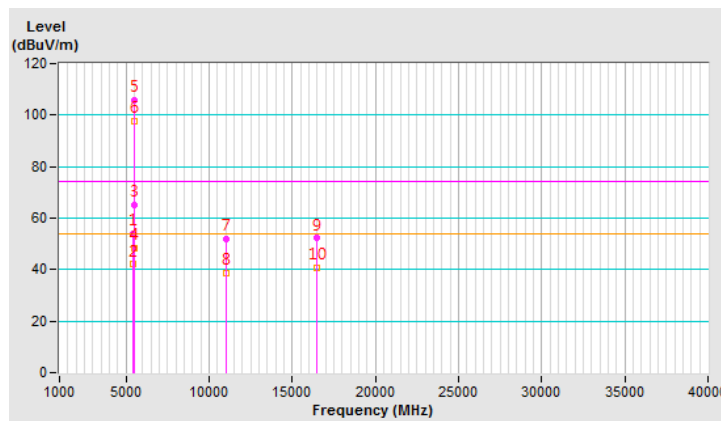

<b>CHANNEL</b>	TX Channel 100	<b>DETECTOR FUNCTION</b>	Peak (PK)
<b>FREQUENCY RANGE</b>	1GHz ~ 40GHz		Average (AV)

**ANTENNA POLARITY & TEST DISTANCE: VERTICAL AT 3 M**

NO.	FREQ. (MHz)	EMISSION LEVEL (dBuV/m)	LIMIT (dBuV/m)	MARGIN (dB)	ANTENNA HEIGHT (m)	TABLE ANGLE (Degree)	RAW VALUE (dBuV)	CORRECTION FACTOR (dB/m)
1	5427.00	55.8 PK	74.0	-18.2	1.50 V	132	51.3	4.5
2	5427.00	43.1 AV	54.0	-10.9	1.50 V	132	38.6	4.5
3	#5463.70	67.0 PK	74.0	-7.0	1.50 V	66	62.5	4.5
4	#5463.70	49.4 AV	54.0	-4.6	1.50 V	66	44.9	4.5
5	*5500.00	110.5 PK			1.50 V	66	106.0	4.5
6	*5500.00	101.3 AV			1.50 V	66	96.8	4.5
7	11000.00	53.8 PK	74.0	-20.2	1.66 V	266	39.0	14.8
8	11000.00	40.2 AV	54.0	-13.8	1.66 V	266	25.4	14.8
9	#16500.00	54.3 PK	74.0	-19.7	1.51 V	254	38.7	15.6
10	#16500.00	41.7 AV	54.0	-12.3	1.51 V	254	26.1	15.6

**REMARKS:**

1. Emission Level(dBuV/m) = Raw Value(dBuV) + Correction Factor(dB/m)
2. Correction Factor(dB/m) = Antenna Factor(dB/m) + Cable Factor(dB) – Pre-Amplifier Factor(dB)
3. The other emission levels were very low against the limit.
4. Margin value = Emission Level – Limit value
5. " \* ": Fundamental frequency.
6. " # ": The radiated frequency is out of the restricted band.

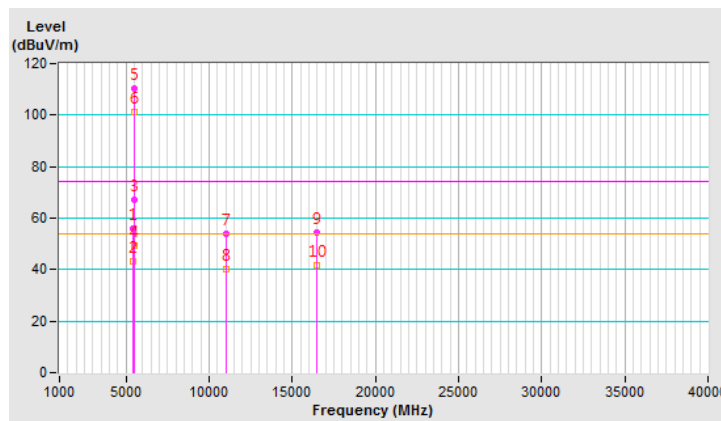

<b>CHANNEL</b>	TX Channel 116	<b>DETECTOR FUNCTION</b>	Peak (PK)
<b>FREQUENCY RANGE</b>	1GHz ~ 40GHz		Average (AV)

**ANTENNA POLARITY & TEST DISTANCE: HORIZONTAL AT 3 M**

NO.	FREQ. (MHz)	EMISSION LEVEL (dBuV/m)	LIMIT (dBuV/m)	MARGIN (dB)	ANTENNA HEIGHT (m)	TABLE ANGLE (Degree)	RAW VALUE (dBuV)	CORRECTION FACTOR (dB/m)
1	5423.50	56.5 PK	74.0	-17.5	2.88 H	334	52.0	4.5
2	5423.50	48.7 AV	54.0	-5.3	2.88 H	334	44.2	4.5
3	*5580.00	107.6 PK			2.88 H	334	103.0	4.6
4	*5580.00	98.9 AV			2.88 H	334	94.3	4.6
5	#5740.90	58.6 PK	74.0	-15.4	2.88 H	334	53.6	5.0
6	#5740.90	49.5 AV	54.0	-4.5	2.88 H	334	44.5	5.0
7	11160.00	51.8 PK	74.0	-22.2	1.48 H	314	37.4	14.4
8	11160.00	38.8 AV	54.0	-15.2	1.48 H	314	24.4	14.4
9	#16740.00	52.6 PK	74.0	-21.4	1.54 H	338	36.1	16.5
10	#16740.00	41.4 AV	54.0	-12.6	1.54 H	338	24.9	16.5

**REMARKS:**

1. Emission Level(dBuV/m) = Raw Value(dBuV) + Correction Factor(dB/m)
2. Correction Factor(dB/m) = Antenna Factor(dB/m) + Cable Factor(dB) – Pre-Amplifier Factor(dB)
3. The other emission levels were very low against the limit.
4. Margin value = Emission Level – Limit value
5. " \* ": Fundamental frequency.
6. " # ": The radiated frequency is out of the restricted band.

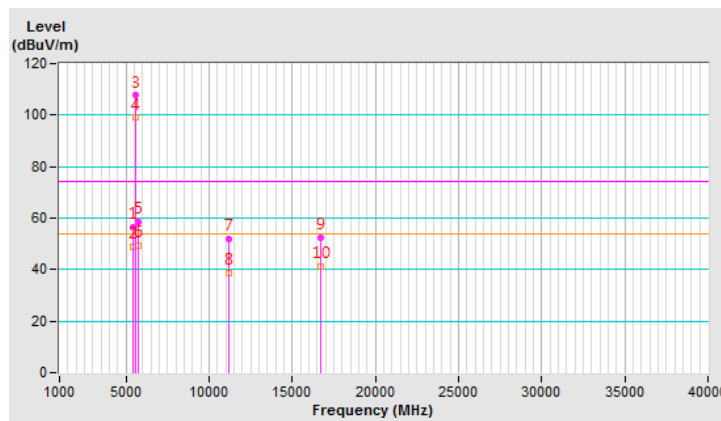

<b>CHANNEL</b>	TX Channel 116	<b>DETECTOR FUNCTION</b>	Peak (PK)
<b>FREQUENCY RANGE</b>	1GHz ~ 40GHz		Average (AV)

**ANTENNA POLARITY & TEST DISTANCE: VERTICAL AT 3 M**

NO.	FREQ. (MHz)	EMISSION LEVEL (dBuV/m)	LIMIT (dBuV/m)	MARGIN (dB)	ANTENNA HEIGHT (m)	TABLE ANGLE (Degree)	RAW VALUE (dBuV)	CORRECTION FACTOR (dB/m)
1	5423.50	58.4 PK	74.0	-15.6	2.81 V	123	53.9	4.5
2	5423.50	49.8 AV	54.0	-4.2	2.81 V	123	45.3	4.5
3	*5580.00	112.3 PK			2.65 V	80	107.7	4.6
4	*5580.00	102.6 AV			2.65 V	80	98.0	4.6
5	#5740.90	60.7 PK	74.0	-13.3	2.65 V	94	55.7	5.0
6	#5740.90	50.7 AV	54.0	-3.3	2.65 V	94	45.7	5.0
7	11160.00	53.3 PK	74.0	-20.7	1.65 V	294	38.9	14.4
8	11160.00	40.9 AV	54.0	-13.1	1.65 V	294	26.5	14.4
9	#16740.00	54.3 PK	74.0	-19.7	1.50 V	268	37.8	16.5
10	#16740.00	41.4 AV	54.0	-12.6	1.50 V	268	24.9	16.5

**REMARKS:**

1. Emission Level(dBuV/m) = Raw Value(dBuV) + Correction Factor(dB/m)
2. Correction Factor(dB/m) = Antenna Factor(dB/m) + Cable Factor(dB) – Pre-Amplifier Factor(dB)
3. The other emission levels were very low against the limit.
4. Margin value = Emission Level – Limit value
5. " \* ": Fundamental frequency.
6. " # ": The radiated frequency is out of the restricted band.

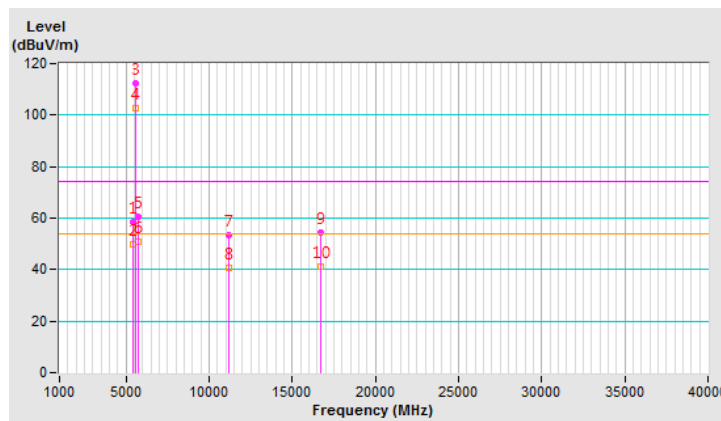

<b>CHANNEL</b>	TX Channel 140	<b>DETECTOR FUNCTION</b>	Peak (PK)
<b>FREQUENCY RANGE</b>	1GHz ~ 40GHz		Average (AV)

**ANTENNA POLARITY & TEST DISTANCE: HORIZONTAL AT 3 M**

NO.	FREQ. (MHz)	EMISSION LEVEL (dBuV/m)	LIMIT (dBuV/m)	MARGIN (dB)	ANTENNA HEIGHT (m)	TABLE ANGLE (Degree)	RAW VALUE (dBuV)	CORRECTION FACTOR (dB/m)
1	*5700.00	107.2 PK			2.91 H	344	102.4	4.8
2	*5700.00	98.1 AV			2.91 H	344	93.3	4.8
3	#5725.00	67.4 PK	74.0	-6.6	2.91 H	344	62.5	4.9
4	#5725.00	50.4 AV	54.0	-3.6	2.91 H	344	45.5	4.9
5	#5861.00	56.6 PK	74.0	-17.4	2.91 H	344	51.4	5.2
6	#5861.00	47.8 AV	54.0	-6.2	2.91 H	344	42.6	5.2
7	11400.00	51.7 PK	74.0	-22.3	1.47 H	335	37.3	14.4
8	11400.00	38.4 AV	54.0	-15.6	1.47 H	335	24.0	14.4
9	#17100.00	52.4 PK	74.0	-21.6	1.50 H	337	33.9	18.5
10	#17100.00	41.4 AV	54.0	-12.6	1.50 H	337	22.9	18.5

**REMARKS:**

1. Emission Level(dBuV/m) = Raw Value(dBuV) + Correction Factor(dB/m)
2. Correction Factor(dB/m) = Antenna Factor(dB/m) + Cable Factor(dB) – Pre-Amplifier Factor(dB)
3. The other emission levels were very low against the limit.
4. Margin value = Emission Level – Limit value
5. " \* ": Fundamental frequency.
6. " # ": The radiated frequency is out of the restricted band.

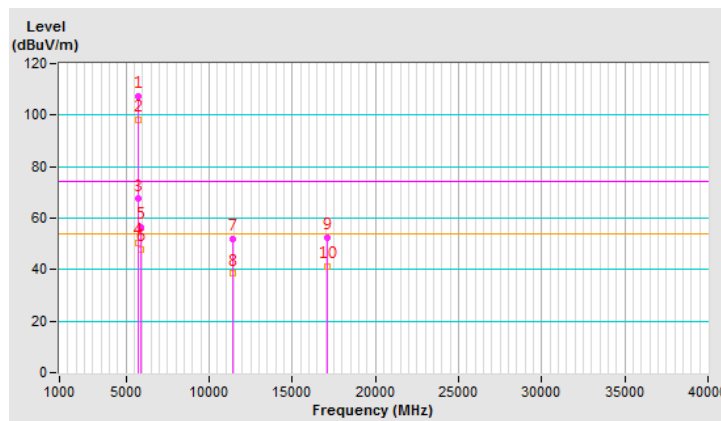



<b>CHANNEL</b>	TX Channel 140	<b>DETECTOR FUNCTION</b>	Peak (PK)
<b>FREQUENCY RANGE</b>	1GHz ~ 40GHz		Average (AV)

**ANTENNA POLARITY & TEST DISTANCE: VERTICAL AT 3 M**

NO.	FREQ. (MHz)	EMISSION LEVEL (dBuV/m)	LIMIT (dBuV/m)	MARGIN (dB)	ANTENNA HEIGHT (m)	TABLE ANGLE (Degree)	RAW VALUE (dBuV)	CORRECTION FACTOR (dB/m)
1	*5700.00	111.9 PK			2.50 V	123	107.1	4.8
2	*5700.00	101.8 AV			2.50 V	123	97.0	4.8
3	#5725.00	69.5 PK	74.0	-4.5	2.50 V	123	64.6	4.9
4	#5725.00	51.6 AV	54.0	-2.4	2.50 V	123	46.7	4.9
5	#5861.00	58.5 PK	74.0	-15.5	2.50 V	87	53.3	5.2
6	#5861.00	48.9 AV	54.0	-5.1	2.50 V	87	43.7	5.2
7	11400.00	52.8 PK	74.0	-21.2	1.63 V	288	38.4	14.4
8	11400.00	40.5 AV	54.0	-13.5	1.63 V	288	26.1	14.4
9	#17100.00	53.4 PK	74.0	-20.6	1.43 V	260	34.9	18.5
10	#17100.00	41.7 AV	54.0	-12.3	1.43 V	260	23.2	18.5

**REMARKS:**

1. Emission Level(dBuV/m) = Raw Value(dBuV) + Correction Factor(dB/m)
2. Correction Factor(dB/m) = Antenna Factor(dB/m) + Cable Factor(dB) – Pre-Amplifier Factor(dB)
3. The other emission levels were very low against the limit.
4. Margin value = Emission Level – Limit value
5. " \* ": Fundamental frequency.
6. " # ": The radiated frequency is out of the restricted band.

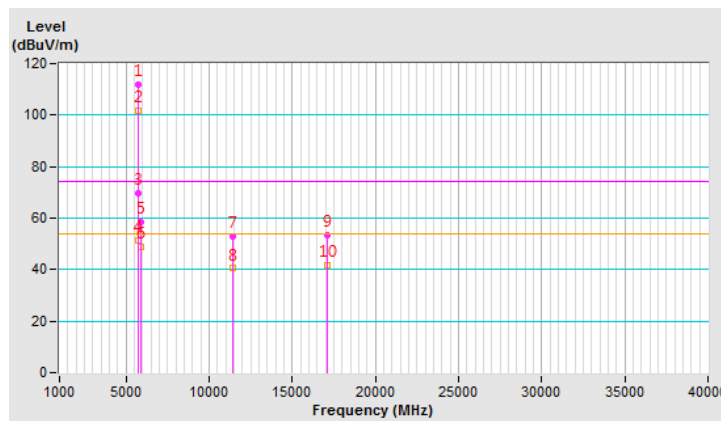

<b>CHANNEL</b>	TX Channel 144	<b>DETECTOR FUNCTION</b>	Peak (PK)
<b>FREQUENCY RANGE</b>	1GHz ~ 40GHz		Average (AV)

**ANTENNA POLARITY & TEST DISTANCE: HORIZONTAL AT 3 M**

NO.	FREQ. (MHz)	EMISSION LEVEL (dBuV/m)	LIMIT (dBuV/m)	MARGIN (dB)	ANTENNA HEIGHT (m)	TABLE ANGLE (Degree)	RAW VALUE (dBuV)	CORRECTION FACTOR (dB/m)
1	#5245.00	47.3 PK	74.0	-26.7	2.88 H	330	43.1	4.2
2	#5245.00	39.1 AV	54.0	-14.9	2.88 H	330	34.9	4.2
3	*5720.00	107.0 PK			2.88 H	330	102.1	4.9
4	*5720.00	97.9 AV			2.88 H	330	93.0	4.9
5	#5877.50	55.7 PK	74.0	-18.3	2.88 H	330	50.5	5.2
6	#5877.50	47.5 AV	54.0	-6.5	2.88 H	330	42.3	5.2
7	11440.00	51.6 PK	74.0	-22.4	1.53 H	327	37.4	14.2
8	11440.00	38.5 AV	54.0	-15.5	1.53 H	327	24.3	14.2
9	#17160.00	52.1 PK	74.0	-21.9	1.49 H	318	33.8	18.3
10	#17160.00	40.6 AV	54.0	-13.4	1.49 H	318	22.3	18.3

**REMARKS:**

1. Emission Level(dBuV/m) = Raw Value(dBuV) + Correction Factor(dB/m)
2. Correction Factor(dB/m) = Antenna Factor(dB/m) + Cable Factor(dB) – Pre-Amplifier Factor(dB)
3. The other emission levels were very low against the limit.
4. Margin value = Emission Level – Limit value
5. " \* ": Fundamental frequency.
6. " # ": The radiated frequency is out of the restricted band.

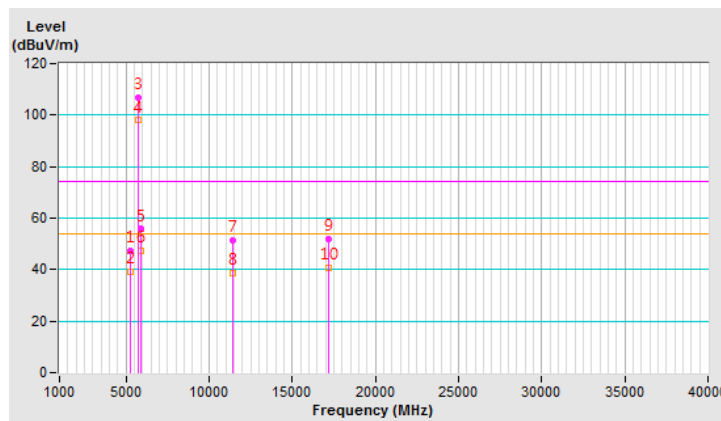

<b>CHANNEL</b>	TX Channel 144	<b>DETECTOR FUNCTION</b>	Peak (PK)
<b>FREQUENCY RANGE</b>	1GHz ~ 40GHz		Average (AV)

**ANTENNA POLARITY & TEST DISTANCE: VERTICAL AT 3 M**

NO.	FREQ. (MHz)	EMISSION LEVEL (dBuV/m)	LIMIT (dBuV/m)	MARGIN (dB)	ANTENNA HEIGHT (m)	TABLE ANGLE (Degree)	RAW VALUE (dBuV)	CORRECTION FACTOR (dB/m)
1	#5245.00	49.2 PK	74.0	-24.8	2.05 V	124	45.0	4.2
2	#5245.00	40.3 AV	54.0	-13.7	2.05 V	124	36.1	4.2
3	*5720.00	111.7 PK			2.05 V	124	106.8	4.9
4	*5720.00	101.6 AV			2.05 V	124	96.7	4.9
5	#5877.50	57.8 PK	74.0	-16.2	2.05 V	142	52.6	5.2
6	#5877.50	48.6 AV	54.0	-5.4	2.05 V	142	43.4	5.2
7	11440.00	53.3 PK	74.0	-20.7	1.60 V	263	39.1	14.2
8	11440.00	41.1 AV	54.0	-12.9	1.60 V	263	26.9	14.2
9	#17160.00	53.6 PK	74.0	-20.4	1.45 V	253	35.3	18.3
10	#17160.00	42.3 AV	54.0	-11.7	1.45 V	253	24.0	18.3

**REMARKS:**

1. Emission Level(dBuV/m) = Raw Value(dBuV) + Correction Factor(dB/m)
2. Correction Factor(dB/m) = Antenna Factor(dB/m) + Cable Factor(dB) – Pre-Amplifier Factor(dB)
3. The other emission levels were very low against the limit.
4. Margin value = Emission Level – Limit value
5. " \* ": Fundamental frequency.
6. " # ": The radiated frequency is out of the restricted band.

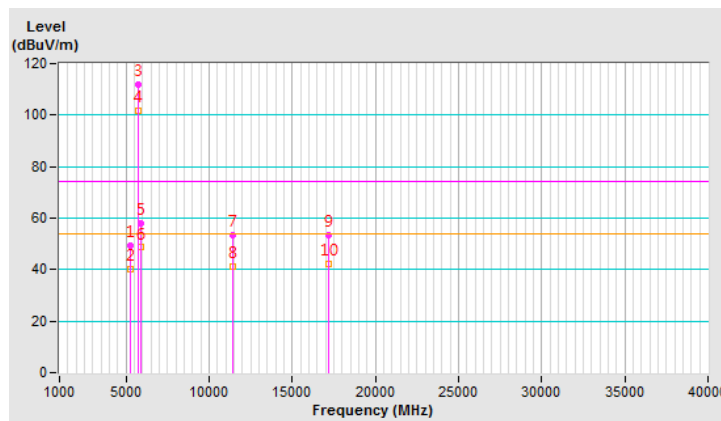

802.11ac (VHT20)

<b>CHANNEL</b>	TX Channel 52	<b>DETECTOR FUNCTION</b>	Peak (PK)
<b>FREQUENCY RANGE</b>	1GHz ~ 40GHz		Average (AV)

ANTENNA POLARITY & TEST DISTANCE: HORIZONTAL AT 3 M								
NO.	FREQ. (MHz)	EMISSION LEVEL (dBuV/m)	LIMIT (dBuV/m)	MARGIN (dB)	ANTENNA HEIGHT (m)	TABLE ANGLE (Degree)	RAW VALUE (dBuV)	CORRECTION FACTOR (dB/m)
1	5150.00	54.0 PK	74.0	-20.0	2.83 H	329	50.0	4.0
2	5150.00	45.1 AV	54.0	-8.9	2.83 H	329	41.1	4.0
3	*5260.00	105.0 PK			2.83 H	329	100.8	4.2
4	*5260.00	95.9 AV			2.83 H	329	91.7	4.2
5	5421.80	56.1 PK	74.0	-17.9	2.83 H	329	51.6	4.5
6	5421.80	46.5 AV	54.0	-7.5	2.83 H	329	42.0	4.5
7	#10520.00	47.7 PK	74.0	-26.3	1.45 H	250	33.9	13.8
8	#10520.00	35.7 AV	54.0	-18.3	1.45 H	250	21.9	13.8
9	15780.00	47.1 PK	74.0	-26.9	1.54 H	230	33.0	14.1
10	15780.00	35.5 AV	54.0	-18.5	1.54 H	230	21.4	14.1

**REMARKS:**

1. Emission Level(dBuV/m) = Raw Value(dBuV) + Correction Factor(dB/m)
2. Correction Factor(dB/m) = Antenna Factor(dB/m) + Cable Factor(dB) – Pre-Amplifier Factor(dB)
3. The other emission levels were very low against the limit.
4. Margin value = Emission Level – Limit value
5. " \* ": Fundamental frequency.
6. " # ": The radiated frequency is out of the restricted band.

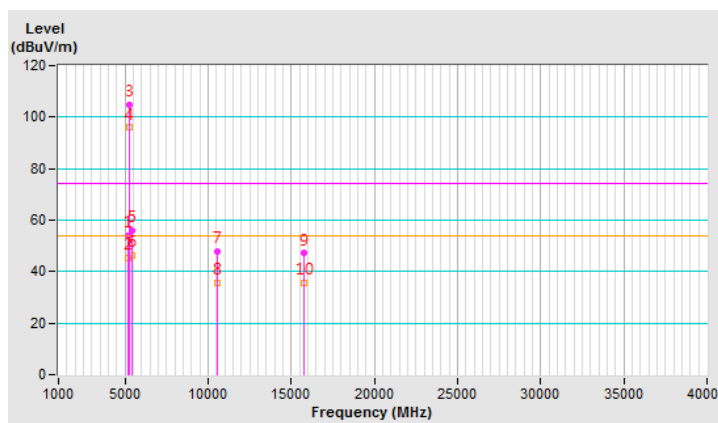

<b>CHANNEL</b>	TX Channel 52	<b>DETECTOR FUNCTION</b>	Peak (PK)
<b>FREQUENCY RANGE</b>	1GHz ~ 40GHz		Average (AV)

**ANTENNA POLARITY & TEST DISTANCE: VERTICAL AT 3 M**

NO.	FREQ. (MHz)	EMISSION LEVEL (dBuV/m)	LIMIT (dBuV/m)	MARGIN (dB)	ANTENNA HEIGHT (m)	TABLE ANGLE (Degree)	RAW VALUE (dBuV)	CORRECTION FACTOR (dB/m)
1	5150.00	55.9 PK	74.0	-18.1	3.76 V	135	51.9	4.0
2	5150.00	46.2 AV	54.0	-7.8	3.76 V	135	42.2	4.0
3	*5260.00	109.7 PK			3.95 V	82	105.5	4.2
4	*5260.00	99.6 AV			3.95 V	82	95.4	4.2
5	5421.80	58.2 PK	74.0	-15.8	3.95 V	89	53.7	4.5
6	5421.80	47.4 AV	54.0	-6.6	3.95 V	89	42.9	4.5
7	#10520.00	51.3 PK	74.0	-22.7	1.43 V	250	37.5	13.8
8	#10520.00	39.7 AV	54.0	-14.3	1.43 V	250	25.9	13.8
9	15780.00	46.9 PK	74.0	-27.1	1.52 V	137	32.8	14.1
10	15780.00	34.3 AV	54.0	-19.7	1.52 V	137	20.2	14.1

**REMARKS:**

1. Emission Level(dBuV/m) = Raw Value(dBuV) + Correction Factor(dB/m)
2. Correction Factor(dB/m) = Antenna Factor(dB/m) + Cable Factor(dB) – Pre-Amplifier Factor(dB)
3. The other emission levels were very low against the limit.
4. Margin value = Emission Level – Limit value
5. " \* ": Fundamental frequency.
6. " # ": The radiated frequency is out of the restricted band.

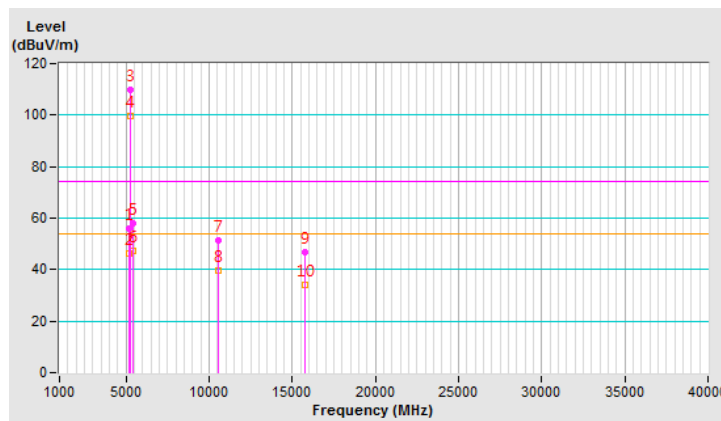

<b>CHANNEL</b>	TX Channel 60	<b>DETECTOR FUNCTION</b>	Peak (PK)
<b>FREQUENCY RANGE</b>	1GHz ~ 40GHz		Average (AV)

**ANTENNA POLARITY & TEST DISTANCE: HORIZONTAL AT 3 M**

NO.	FREQ. (MHz)	EMISSION LEVEL (dBuV/m)	LIMIT (dBuV/m)	MARGIN (dB)	ANTENNA HEIGHT (m)	TABLE ANGLE (Degree)	RAW VALUE (dBuV)	CORRECTION FACTOR (dB/m)
1	5141.40	51.3 PK	74.0	-22.7	2.82 H	332	47.3	4.0
2	5141.40	44.2 AV	54.0	-9.8	2.82 H	332	40.2	4.0
3	*5300.00	105.1 PK			2.82 H	332	100.8	4.3
4	*5300.00	96.4 AV			2.82 H	332	92.1	4.3
5	5457.50	56.3 PK	74.0	-17.7	2.82 H	332	51.8	4.5
6	5457.50	46.7 AV	54.0	-7.3	2.82 H	332	42.2	4.5
7	10600.00	48.0 PK	74.0	-26.0	1.53 H	244	34.2	13.8
8	10600.00	36.1 AV	54.0	-17.9	1.53 H	244	22.3	13.8
9	15900.00	46.8 PK	74.0	-27.2	1.50 H	227	33.6	13.2
10	15900.00	35.2 AV	54.0	-18.8	1.50 H	227	22.0	13.2

**REMARKS:**

1. Emission Level(dBuV/m) = Raw Value(dBuV) + Correction Factor(dB/m)
2. Correction Factor(dB/m) = Antenna Factor(dB/m) + Cable Factor(dB) – Pre-Amplifier Factor(dB)
3. The other emission levels were very low against the limit.
4. Margin value = Emission Level – Limit value
5. " \* ": Fundamental frequency.

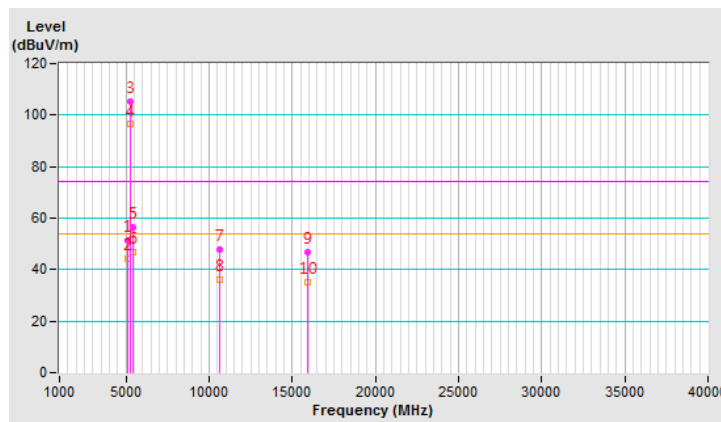

<b>CHANNEL</b>	TX Channel 60	<b>DETECTOR FUNCTION</b>	Peak (PK)
<b>FREQUENCY RANGE</b>	1GHz ~ 40GHz		Average (AV)

**ANTENNA POLARITY & TEST DISTANCE: VERTICAL AT 3 M**

NO.	FREQ. (MHz)	EMISSION LEVEL (dBuV/m)	LIMIT (dBuV/m)	MARGIN (dB)	ANTENNA HEIGHT (m)	TABLE ANGLE (Degree)	RAW VALUE (dBuV)	CORRECTION FACTOR (dB/m)
1	5141.40	53.4 PK	74.0	-20.6	2.62 V	103	49.4	4.0
2	5141.40	45.1 AV	54.0	-8.9	2.62 V	103	41.1	4.0
3	*5300.00	109.8 PK			2.62 V	158	105.5	4.3
4	*5300.00	100.1 AV			2.62 V	158	95.8	4.3
5	5457.50	58.1 PK	74.0	-15.9	2.62 V	86	53.6	4.5
6	5457.50	47.8 AV	54.0	-6.2	2.62 V	86	43.3	4.5
7	10600.00	51.2 PK	74.0	-22.8	1.46 V	268	37.4	13.8
8	10600.00	39.2 AV	54.0	-14.8	1.46 V	268	25.4	13.8
9	15900.00	47.1 PK	74.0	-26.9	1.46 V	119	33.9	13.2
10	15900.00	34.4 AV	54.0	-19.6	1.46 V	119	21.2	13.2

**REMARKS:**

1. Emission Level(dBuV/m) = Raw Value(dBuV) + Correction Factor(dB/m)
2. Correction Factor(dB/m) = Antenna Factor(dB/m) + Cable Factor(dB) – Pre-Amplifier Factor(dB)
3. The other emission levels were very low against the limit.
4. Margin value = Emission Level – Limit value
5. " \* ": Fundamental frequency.

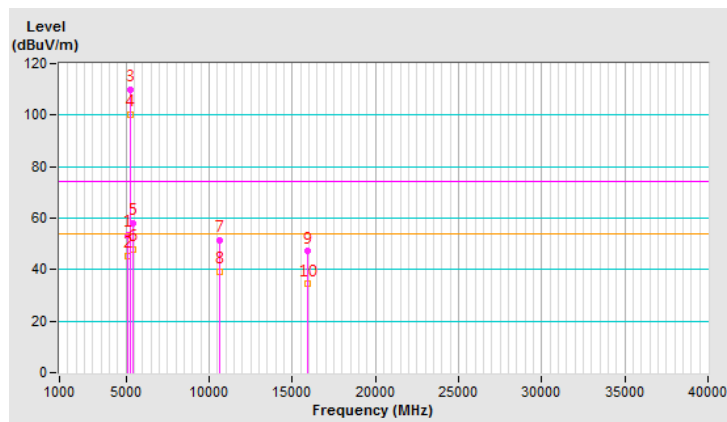

<b>CHANNEL</b>	TX Channel 64	<b>DETECTOR FUNCTION</b>	Peak (PK)
<b>FREQUENCY RANGE</b>	1GHz ~ 40GHz		Average (AV)

**ANTENNA POLARITY & TEST DISTANCE: HORIZONTAL AT 3 M**

NO.	FREQ. (MHz)	EMISSION LEVEL (dBuV/m)	LIMIT (dBuV/m)	MARGIN (dB)	ANTENNA HEIGHT (m)	TABLE ANGLE (Degree)	RAW VALUE (dBuV)	CORRECTION FACTOR (dB/m)
1	*5320.00	106.5 PK			2.87 H	324	102.2	4.3
2	*5320.00	96.7 AV			2.87 H	324	92.4	4.3
3	5350.00	64.4 PK	74.0	-9.6	2.87 H	324	60.0	4.4
4	5350.00	48.9 AV	54.0	-5.1	2.87 H	324	44.5	4.4
5	5401.60	53.0 PK	74.0	-21.0	2.87 H	324	48.6	4.4
6	5401.60	42.1 AV	54.0	-11.9	2.87 H	324	37.7	4.4
7	10640.00	47.9 PK	74.0	-26.1	1.50 H	255	33.9	14.0
8	10640.00	35.8 AV	54.0	-18.2	1.50 H	255	21.8	14.0
9	15960.00	46.4 PK	74.0	-27.6	1.46 H	231	32.9	13.5
10	15960.00	34.6 AV	54.0	-19.4	1.46 H	231	21.1	13.5

**REMARKS:**

1. Emission Level(dBuV/m) = Raw Value(dBuV) + Correction Factor(dB/m)
2. Correction Factor(dB/m) = Antenna Factor(dB/m) + Cable Factor(dB) – Pre-Amplifier Factor(dB)
3. The other emission levels were very low against the limit.
4. Margin value = Emission Level – Limit value
5. " \* ": Fundamental frequency.

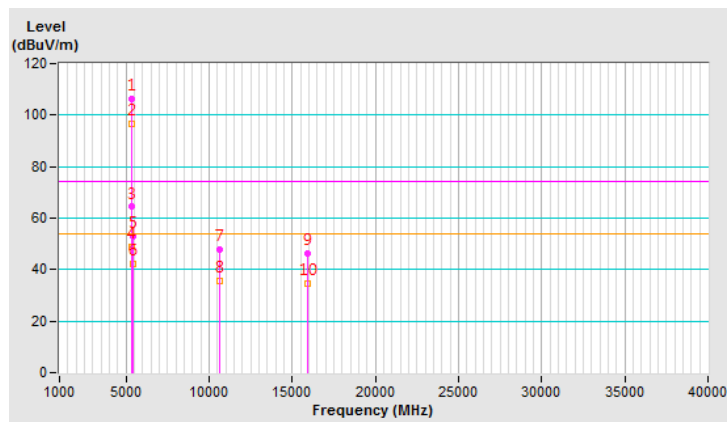



<b>CHANNEL</b>	TX Channel 64	<b>DETECTOR FUNCTION</b>	Peak (PK)
<b>FREQUENCY RANGE</b>	1GHz ~ 40GHz		Average (AV)

**ANTENNA POLARITY & TEST DISTANCE: VERTICAL AT 3 M**

NO.	FREQ. (MHz)	EMISSION LEVEL (dBuV/m)	LIMIT (dBuV/m)	MARGIN (dB)	ANTENNA HEIGHT (m)	TABLE ANGLE (Degree)	RAW VALUE (dBuV)	CORRECTION FACTOR (dB/m)
1	*5320.00	111.2 PK			2.62 V	150	106.9	4.3
2	*5320.00	100.4 AV			2.62 V	150	96.1	4.3
3	5350.00	66.3 PK	74.0	-7.7	2.62 V	150	61.9	4.4
4	5350.00	50.0 AV	54.0	-4.0	2.62 V	150	45.6	4.4
5	5401.60	55.1 PK	74.0	-18.9	2.62 V	153	50.7	4.4
6	5401.60	42.8 AV	54.0	-11.2	2.62 V	153	38.4	4.4
7	10640.00	51.6 PK	74.0	-22.4	1.46 V	260	37.6	14.0
8	10640.00	39.8 AV	54.0	-14.2	1.46 V	260	25.8	14.0
9	15960.00	47.0 PK	74.0	-27.0	1.52 V	124	33.5	13.5
10	15960.00	34.4 AV	54.0	-19.6	1.52 V	124	20.9	13.5

**REMARKS:**

1. Emission Level(dBuV/m) = Raw Value(dBuV) + Correction Factor(dB/m)
2. Correction Factor(dB/m) = Antenna Factor(dB/m) + Cable Factor(dB) – Pre-Amplifier Factor(dB)
3. The other emission levels were very low against the limit.
4. Margin value = Emission Level – Limit value
5. " \* ": Fundamental frequency.

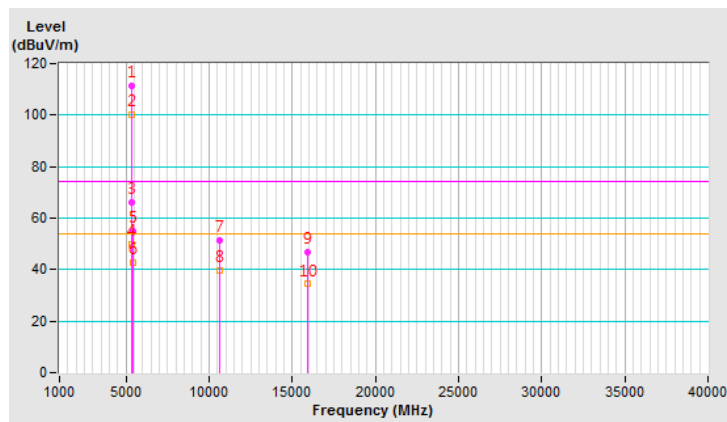

<b>CHANNEL</b>	TX Channel 100	<b>DETECTOR FUNCTION</b>	Peak (PK)
<b>FREQUENCY RANGE</b>	1GHz ~ 40GHz		Average (AV)

**ANTENNA POLARITY & TEST DISTANCE: HORIZONTAL AT 3 M**

NO.	FREQ. (MHz)	EMISSION LEVEL (dBuV/m)	LIMIT (dBuV/m)	MARGIN (dB)	ANTENNA HEIGHT (m)	TABLE ANGLE (Degree)	RAW VALUE (dBuV)	CORRECTION FACTOR (dB/m)
1	#541.60	55.3 PK	74.0	-18.7	2.88 H	328	55.3	0.0
2	#541.60	41.6 AV	54.0	-12.4	2.88 H	328	41.6	0.0
3	#5466.80	65.6 PK	74.0	-8.4	2.88 H	328	61.1	4.5
4	#5466.80	49.0 AV	54.0	-5.0	2.88 H	328	44.5	4.5
5	*5500.00	105.7 PK			2.88 H	328	101.2	4.5
6	*5500.00	96.6 AV			2.88 H	328	92.1	4.5
7	11000.00	51.1 PK	74.0	-22.9	1.46 H	341	36.3	14.8
8	11000.00	38.1 AV	54.0	-15.9	1.46 H	341	23.3	14.8
9	#16500.00	51.9 PK	74.0	-22.1	1.51 H	338	36.3	15.6
10	#16500.00	40.6 AV	54.0	-13.4	1.51 H	338	25.0	15.6

**REMARKS:**

1. Emission Level(dBuV/m) = Raw Value(dBuV) + Correction Factor(dB/m)
2. Correction Factor(dB/m) = Antenna Factor(dB/m) + Cable Factor(dB) – Pre-Amplifier Factor(dB)
3. The other emission levels were very low against the limit.
4. Margin value = Emission Level – Limit value
5. " \* ": Fundamental frequency.
6. " # ": The radiated frequency is out of the restricted band.

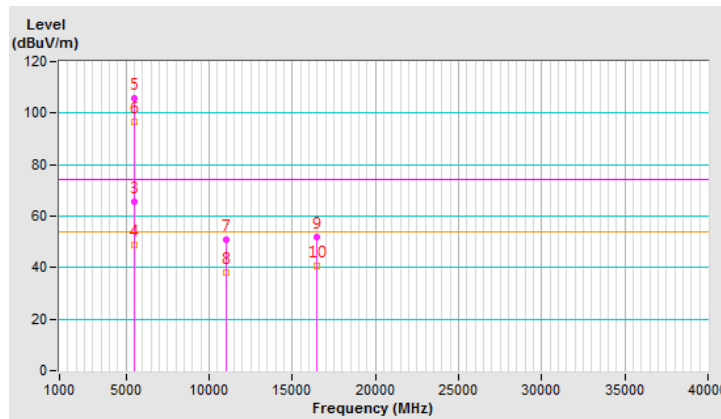

<b>CHANNEL</b>	TX Channel 100	<b>DETECTOR FUNCTION</b>	Peak (PK)
<b>FREQUENCY RANGE</b>	1GHz ~ 40GHz		Average (AV)

**ANTENNA POLARITY & TEST DISTANCE: VERTICAL AT 3 M**

NO.	FREQ. (MHz)	EMISSION LEVEL (dBuV/m)	LIMIT (dBuV/m)	MARGIN (dB)	ANTENNA HEIGHT (m)	TABLE ANGLE (Degree)	RAW VALUE (dBuV)	CORRECTION FACTOR (dB/m)
1	#541.60	57.2 PK	74.0	-16.8	2.51 V	150	57.2	0.0
2	#541.60	42.4 AV	54.0	-11.6	2.51 V	150	42.4	0.0
3	#5466.80	67.6 PK	74.0	-6.4	2.51 V	150	63.1	4.5
4	#5466.80	50.1 AV	54.0	-3.9	2.51 V	150	45.6	4.5
5	*5500.00	110.3 PK			2.51 V	150	105.8	4.5
6	*5500.00	100.3 AV			2.51 V	150	95.8	4.5
7	11000.00	52.8 PK	74.0	-21.2	1.57 V	285	38.0	14.8
8	11000.00	40.6 AV	54.0	-13.4	1.57 V	285	25.8	14.8
9	#16500.00	53.4 PK	74.0	-20.6	1.38 V	273	37.8	15.6
10	#16500.00	41.5 AV	54.0	-12.5	1.38 V	273	25.9	15.6

**REMARKS:**

1. Emission Level(dBuV/m) = Raw Value(dBuV) + Correction Factor(dB/m)
2. Correction Factor(dB/m) = Antenna Factor(dB/m) + Cable Factor(dB) – Pre-Amplifier Factor(dB)
3. The other emission levels were very low against the limit.
4. Margin value = Emission Level – Limit value
5. " \* ": Fundamental frequency.
6. " # ": The radiated frequency is out of the restricted band.

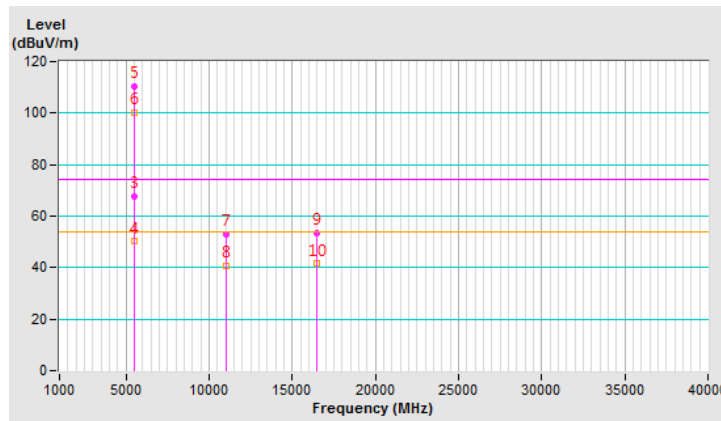

<b>CHANNEL</b>	TX Channel 116	<b>DETECTOR FUNCTION</b>	Peak (PK)
<b>FREQUENCY RANGE</b>	1GHz ~ 40GHz		Average (AV)

**ANTENNA POLARITY & TEST DISTANCE: HORIZONTAL AT 3 M**

NO.	FREQ. (MHz)	EMISSION LEVEL (dBuV/m)	LIMIT (dBuV/m)	MARGIN (dB)	ANTENNA HEIGHT (m)	TABLE ANGLE (Degree)	RAW VALUE (dBuV)	CORRECTION FACTOR (dB/m)
1	5426.70	55.1 PK	74.0	-18.9	2.85 H	320	50.6	4.5
2	5426.70	45.8 AV	54.0	-8.2	2.85 H	320	41.3	4.5
3	*5580.00	107.2 PK			2.85 H	320	102.6	4.6
4	*5580.00	97.0 AV			2.85 H	320	92.4	4.6
5	#5737.90	56.3 PK	74.0	-17.7	2.85 H	320	51.3	5.0
6	#5737.90	47.9 AV	54.0	-6.1	2.85 H	320	42.9	5.0
7	11160.00	51.5 PK	74.0	-22.5	1.56 H	328	37.1	14.4
8	11160.00	38.6 AV	54.0	-15.4	1.56 H	328	24.2	14.4
9	#16740.00	52.0 PK	74.0	-22.0	1.55 H	328	35.5	16.5
10	#16740.00	40.6 AV	54.0	-13.4	1.55 H	328	24.1	16.5

**REMARKS:**

1. Emission Level(dBuV/m) = Raw Value(dBuV) + Correction Factor(dB/m)
2. Correction Factor(dB/m) = Antenna Factor(dB/m) + Cable Factor(dB) – Pre-Amplifier Factor(dB)
3. The other emission levels were very low against the limit.
4. Margin value = Emission Level – Limit value
5. " \* ": Fundamental frequency.
6. " # ": The radiated frequency is out of the restricted band.

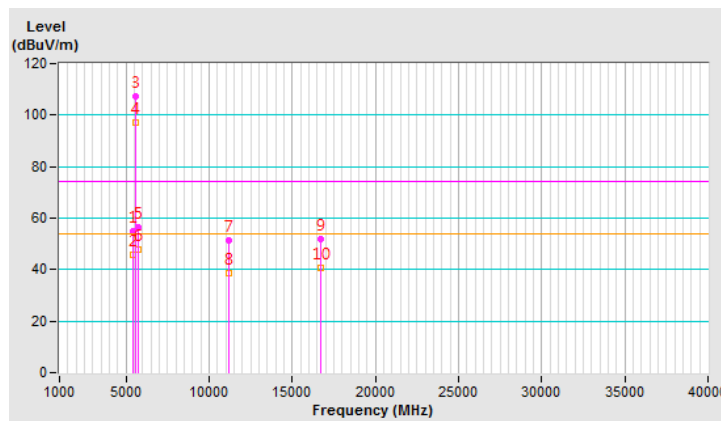

<b>CHANNEL</b>	TX Channel 116	<b>DETECTOR FUNCTION</b>	Peak (PK)
<b>FREQUENCY RANGE</b>	1GHz ~ 40GHz		Average (AV)

**ANTENNA POLARITY & TEST DISTANCE: VERTICAL AT 3 M**

NO.	FREQ. (MHz)	EMISSION LEVEL (dBuV/m)	LIMIT (dBuV/m)	MARGIN (dB)	ANTENNA HEIGHT (m)	TABLE ANGLE (Degree)	RAW VALUE (dBuV)	CORRECTION FACTOR (dB/m)
1	5426.70	57.2 PK	74.0	-16.8	2.49 V	147	52.7	4.5
2	5426.70	46.9 AV	54.0	-7.1	2.49 V	147	42.4	4.5
3	*5580.00	111.4 PK			2.58 V	120	106.8	4.6
4	*5580.00	100.6 AV			2.58 V	120	96.0	4.6
5	#5737.90	58.2 PK	74.0	-15.8	2.33 V	126	53.2	5.0
6	#5737.90	49.0 AV	54.0	-5.0	2.33 V	126	44.0	5.0
7	11160.00	52.8 PK	74.0	-21.2	1.67 V	301	38.4	14.4
8	11160.00	40.4 AV	54.0	-13.6	1.67 V	301	26.0	14.4
9	#16740.00	52.7 PK	74.0	-21.3	1.40 V	268	36.2	16.5
10	#16740.00	41.2 AV	54.0	-12.8	1.40 V	268	24.7	16.5

**REMARKS:**

1. Emission Level(dBuV/m) = Raw Value(dBuV) + Correction Factor(dB/m)
2. Correction Factor(dB/m) = Antenna Factor(dB/m) + Cable Factor(dB) – Pre-Amplifier Factor(dB)
3. The other emission levels were very low against the limit.
4. Margin value = Emission Level – Limit value
5. " \* ": Fundamental frequency.
6. " # ": The radiated frequency is out of the restricted band.

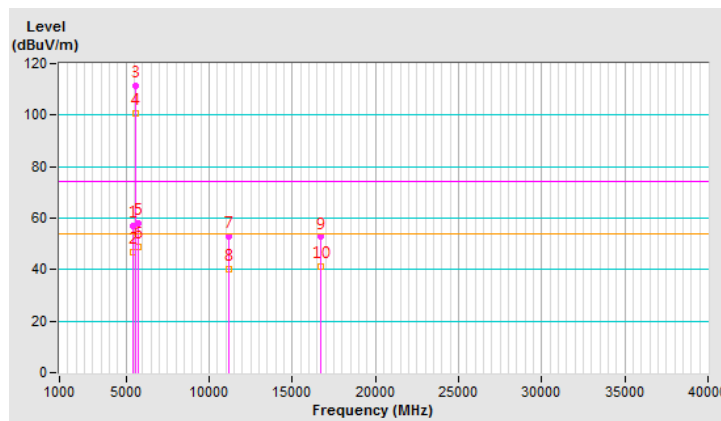

<b>CHANNEL</b>	TX Channel 140	<b>DETECTOR FUNCTION</b>	Peak (PK)
<b>FREQUENCY RANGE</b>	1GHz ~ 40GHz		Average (AV)

**ANTENNA POLARITY & TEST DISTANCE: HORIZONTAL AT 3 M**

NO.	FREQ. (MHz)	EMISSION LEVEL (dBuV/m)	LIMIT (dBuV/m)	MARGIN (dB)	ANTENNA HEIGHT (m)	TABLE ANGLE (Degree)	RAW VALUE (dBuV)	CORRECTION FACTOR (dB/m)
1	*5700.00	107.3 PK			2.83 H	319	102.5	4.8
2	*5700.00	98.0 AV			2.83 H	319	93.2	4.8
3	#5728.20	64.8 PK	74.0	-9.2	2.83 H	319	59.9	4.9
4	#5728.20	50.4 AV	54.0	-3.6	2.83 H	319	45.5	4.9
5	#5857.90	55.7 PK	74.0	-18.3	2.83 H	319	50.5	5.2
6	#5857.90	47.3 AV	54.0	-6.7	2.83 H	319	42.1	5.2
7	11400.00	51.9 PK	74.0	-22.1	1.52 H	321	37.5	14.4
8	11400.00	38.6 AV	54.0	-15.4	1.52 H	321	24.2	14.4
9	#17100.00	52.9 PK	74.0	-21.1	1.55 H	318	34.4	18.5
10	#17100.00	41.6 AV	54.0	-12.4	1.55 H	318	23.1	18.5

**REMARKS:**

1. Emission Level(dBuV/m) = Raw Value(dBuV) + Correction Factor(dB/m)
2. Correction Factor(dB/m) = Antenna Factor(dB/m) + Cable Factor(dB) – Pre-Amplifier Factor(dB)
3. The other emission levels were very low against the limit.
4. Margin value = Emission Level – Limit value
5. " \* ": Fundamental frequency.
6. " # ": The radiated frequency is out of the restricted band.

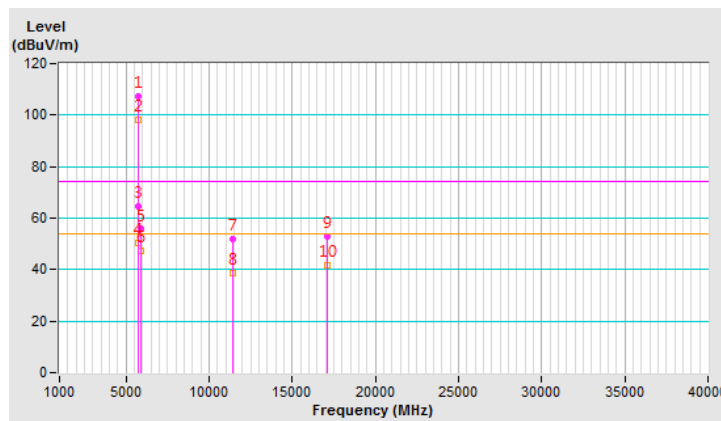

<b>CHANNEL</b>	TX Channel 140	<b>DETECTOR FUNCTION</b>	Peak (PK)
<b>FREQUENCY RANGE</b>	1GHz ~ 40GHz		Average (AV)

**ANTENNA POLARITY & TEST DISTANCE: VERTICAL AT 3 M**

NO.	FREQ. (MHz)	EMISSION LEVEL (dBuV/m)	LIMIT (dBuV/m)	MARGIN (dB)	ANTENNA HEIGHT (m)	TABLE ANGLE (Degree)	RAW VALUE (dBuV)	CORRECTION FACTOR (dB/m)
1	*5700.00	112.1 PK			2.48 V	123	107.3	4.8
2	*5700.00	101.4 AV			2.48 V	123	96.6	4.8
3	#5728.20	66.7 PK	74.0	-7.3	2.48 V	123	61.8	4.9
4	#5728.20	51.5 AV	54.0	-2.5	2.48 V	123	46.6	4.9
5	#5857.90	57.8 PK	74.0	-16.2	2.48 V	138	52.6	5.2
6	#5857.90	48.2 AV	54.0	-5.8	2.48 V	138	43.0	5.2
7	11400.00	52.8 PK	74.0	-21.2	1.59 V	279	38.4	14.4
8	11400.00	40.5 AV	54.0	-13.5	1.59 V	279	26.1	14.4
9	#17100.00	53.8 PK	74.0	-20.2	1.40 V	271	35.3	18.5
10	#17100.00	41.9 AV	54.0	-12.1	1.40 V	271	23.4	18.5

**REMARKS:**

1. Emission Level(dBuV/m) = Raw Value(dBuV) + Correction Factor(dB/m)
2. Correction Factor(dB/m) = Antenna Factor(dB/m) + Cable Factor(dB) – Pre-Amplifier Factor(dB)
3. The other emission levels were very low against the limit.
4. Margin value = Emission Level – Limit value
5. " \* ": Fundamental frequency.
6. " # ": The radiated frequency is out of the restricted band.

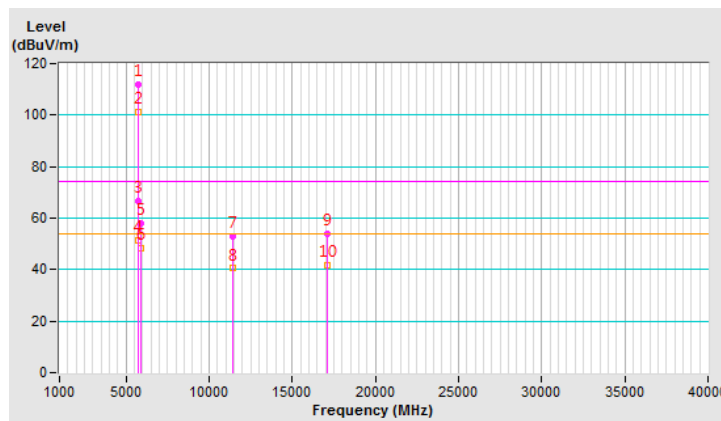

<b>CHANNEL</b>	TX Channel 144	<b>DETECTOR FUNCTION</b>	Peak (PK)
<b>FREQUENCY RANGE</b>	1GHz ~ 40GHz		Average (AV)

**ANTENNA POLARITY & TEST DISTANCE: HORIZONTAL AT 3 M**

NO.	FREQ. (MHz)	EMISSION LEVEL (dBuV/m)	LIMIT (dBuV/m)	MARGIN (dB)	ANTENNA HEIGHT (m)	TABLE ANGLE (Degree)	RAW VALUE (dBuV)	CORRECTION FACTOR (dB/m)
1	#5470.00	47.6 PK	74.0	-26.4	2.89 H	326	43.1	4.5
2	#5470.00	39.6 AV	54.0	-14.4	2.89 H	326	35.1	4.5
3	*5720.00	108.0 PK			2.89 H	326	103.1	4.9
4	*5720.00	96.2 AV			2.89 H	326	91.3	4.9
5	#5850.00	55.3 PK	74.0	-18.7	2.89 H	326	50.2	5.1
6	#5850.00	47.2 AV	54.0	-6.8	2.89 H	326	42.1	5.1
7	11440.00	51.5 PK	74.0	-22.5	1.53 H	335	37.3	14.2
8	11440.00	38.0 AV	54.0	-16.0	1.53 H	335	23.8	14.2
9	#17160.00	52.0 PK	74.0	-22.0	1.53 H	316	33.7	18.3
10	#17160.00	40.7 AV	54.0	-13.3	1.53 H	316	22.4	18.3

**REMARKS:**

1. Emission Level(dBuV/m) = Raw Value(dBuV) + Correction Factor(dB/m)
2. Correction Factor(dB/m) = Antenna Factor(dB/m) + Cable Factor(dB) – Pre-Amplifier Factor(dB)
3. The other emission levels were very low against the limit.
4. Margin value = Emission Level – Limit value
5. " \* ": Fundamental frequency.
6. " # ": The radiated frequency is out of the restricted band.

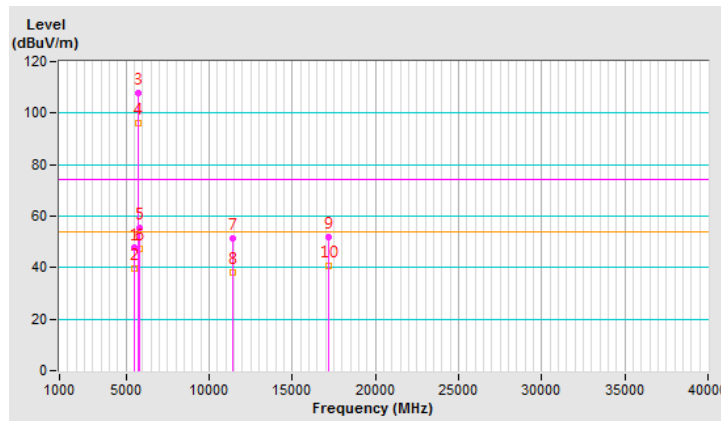



<b>CHANNEL</b>	TX Channel 144	<b>DETECTOR FUNCTION</b>	Peak (PK)
<b>FREQUENCY RANGE</b>	1GHz ~ 40GHz		Average (AV)

**ANTENNA POLARITY & TEST DISTANCE: VERTICAL AT 3 M**

NO.	FREQ. (MHz)	EMISSION LEVEL (dBuV/m)	LIMIT (dBuV/m)	MARGIN (dB)	ANTENNA HEIGHT (m)	TABLE ANGLE (Degree)	RAW VALUE (dBuV)	CORRECTION FACTOR (dB/m)
1	#5470.00	49.4 PK	74.0	-24.6	2.41 V	115	44.9	4.5
2	#5470.00	40.7 AV	54.0	-13.3	2.41 V	115	36.2	4.5
3	*5720.00	112.7 PK			2.41 V	115	107.8	4.9
4	*5720.00	99.9 AV			2.41 V	115	95.0	4.9
5	#5850.00	57.4 PK	74.0	-16.6	2.41 V	115	52.3	5.1
6	#5850.00	48.2 AV	54.0	-5.8	2.41 V	115	43.1	5.1
7	11440.00	52.3 PK	74.0	-21.7	1.67 V	279	38.1	14.2
8	11440.00	40.1 AV	54.0	-13.9	1.67 V	279	25.9	14.2
9	#17160.00	54.0 PK	74.0	-20.0	1.41 V	261	35.7	18.3
10	#17160.00	42.2 AV	54.0	-11.8	1.41 V	261	23.9	18.3

**REMARKS:**

1. Emission Level(dBuV/m) = Raw Value(dBuV) + Correction Factor(dB/m)
2. Correction Factor(dB/m) = Antenna Factor(dB/m) + Cable Factor(dB) – Pre-Amplifier Factor(dB)
3. The other emission levels were very low against the limit.
4. Margin value = Emission Level – Limit value
5. " \* ": Fundamental frequency.
6. " # ": The radiated frequency is out of the restricted band.

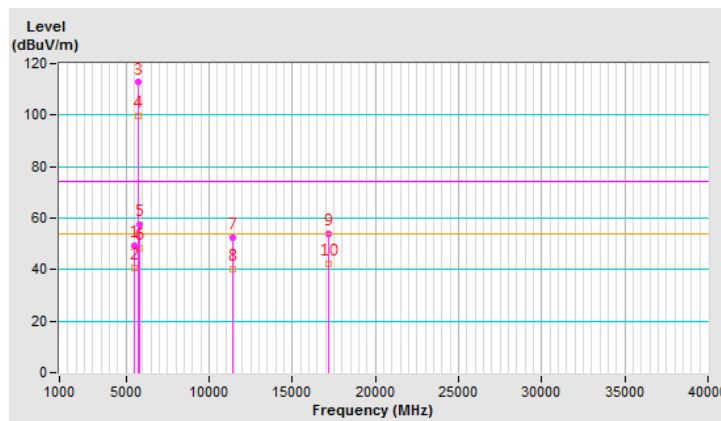

### 802.11ac (VHT40)

<b>CHANNEL</b>	TX Channel 54	<b>DETECTOR FUNCTION</b>	Peak (PK)
<b>FREQUENCY RANGE</b>	1GHz ~ 40GHz		Average (AV)

ANTENNA POLARITY & TEST DISTANCE: HORIZONTAL AT 3 M								
NO.	FREQ. (MHz)	EMISSION LEVEL (dBuV/m)	LIMIT (dBuV/m)	MARGIN (dB)	ANTENNA HEIGHT (m)	TABLE ANGLE (Degree)	RAW VALUE (dBuV)	CORRECTION FACTOR (dB/m)
1	5116.60	52.3 PK	74.0	-21.7	2.94 H	326	48.4	3.9
2	5116.60	44.8 AV	54.0	-9.2	2.94 H	326	40.9	3.9
3	*5270.00	103.9 PK			2.94 H	326	99.7	4.2
4	*5270.00	96.1 AV			2.94 H	326	91.9	4.2
5	5352.00	58.9 PK	74.0	-15.1	2.94 H	326	54.5	4.4
6	5352.00	44.4 AV	54.0	-9.6	2.94 H	326	40.0	4.4
7	5432.20	58.1 PK	74.0	-15.9	2.94 H	326	53.6	4.5
8	5432.20	47.9 AV	54.0	-6.1	2.94 H	326	43.4	4.5
9	#10540.00	48.8 PK	74.0	-25.2	1.47 H	256	35.1	13.7
10	#10540.00	36.3 AV	54.0	-17.7	1.47 H	256	22.6	13.7
11	15810.00	47.1 PK	74.0	-26.9	1.55 H	223	33.1	14.0
12	15810.00	35.1 AV	54.0	-18.9	1.55 H	223	21.1	14.0

#### REMARKS:

1. Emission Level(dBuV/m) = Raw Value(dBuV) + Correction Factor(dB/m)
2. Correction Factor(dB/m) = Antenna Factor(dB/m) + Cable Factor(dB) – Pre-Amplifier Factor(dB)
3. The other emission levels were very low against the limit.
4. Margin value = Emission Level – Limit value
5. " \* ": Fundamental frequency.
6. " # ": The radiated frequency is out of the restricted band.

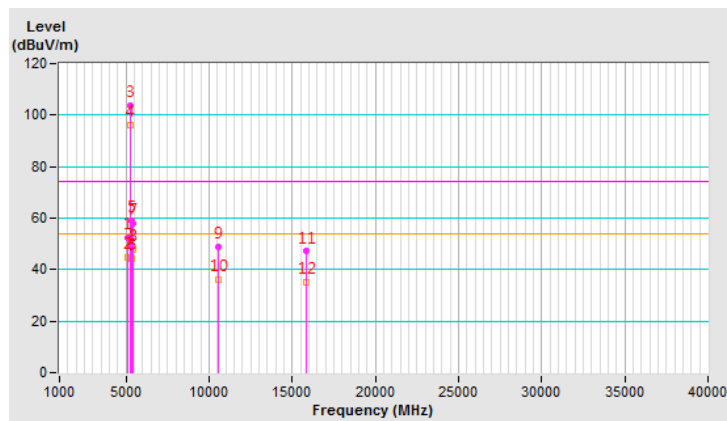

<b>CHANNEL</b>	TX Channel 54	<b>DETECTOR FUNCTION</b>	Peak (PK)
<b>FREQUENCY RANGE</b>	1GHz ~ 40GHz		Average (AV)

**ANTENNA POLARITY & TEST DISTANCE: VERTICAL AT 3 M**

NO.	FREQ. (MHz)	EMISSION LEVEL (dBuV/m)	LIMIT (dBuV/m)	MARGIN (dB)	ANTENNA HEIGHT (m)	TABLE ANGLE (Degree)	RAW VALUE (dBuV)	CORRECTION FACTOR (dB/m)
1	5116.60	54.4 PK	74.0	-19.6	1.49 V	82	50.5	3.9
2	5116.60	45.6 AV	54.0	-8.4	1.49 V	82	41.7	3.9
3	*5270.00	108.6 PK			1.49 V	82	104.4	4.2
4	*5270.00	99.8 AV			1.49 V	82	95.6	4.2
5	5352.00	61.0 PK	74.0	-13.0	1.49 V	82	56.6	4.4
6	5352.00	45.6 AV	54.0	-8.4	1.49 V	82	41.2	4.4
7	5432.20	59.9 PK	74.0	-14.1	2.66 V	149	55.4	4.5
8	5432.20	48.8 AV	54.0	-5.2	2.66 V	149	44.3	4.5
9	#10540.00	51.2 PK	74.0	-22.8	1.45 V	266	37.5	13.7
10	#10540.00	39.6 AV	54.0	-14.4	1.45 V	266	25.9	13.7
11	15810.00	48.1 PK	74.0	-25.9	1.45 V	115	34.1	14.0
12	15810.00	35.1 AV	54.0	-18.9	1.45 V	115	21.1	14.0

**REMARKS:**

1. Emission Level(dBuV/m) = Raw Value(dBuV) + Correction Factor(dB/m)
2. Correction Factor(dB/m) = Antenna Factor(dB/m) + Cable Factor(dB) – Pre-Amplifier Factor(dB)
3. The other emission levels were very low against the limit.
4. Margin value = Emission Level – Limit value
5. " \* ": Fundamental frequency.
6. " # ": The radiated frequency is out of the restricted band.

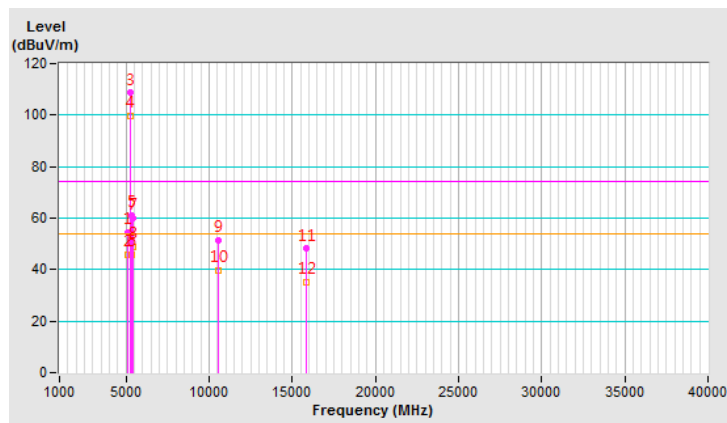

<b>CHANNEL</b>	TX Channel 62	<b>DETECTOR FUNCTION</b>	Peak (PK)
<b>FREQUENCY RANGE</b>	1GHz ~ 40GHz		Average (AV)

**ANTENNA POLARITY & TEST DISTANCE: HORIZONTAL AT 3 M**

NO.	FREQ. (MHz)	EMISSION LEVEL (dBuV/m)	LIMIT (dBuV/m)	MARGIN (dB)	ANTENNA HEIGHT (m)	TABLE ANGLE (Degree)	RAW VALUE (dBuV)	CORRECTION FACTOR (dB/m)
1	*5310.00	105.8 PK			2.93 H	337	101.5	4.3
2	*5310.00	96.2 AV			2.93 H	337	91.9	4.3
3	5351.00	70.9 PK	74.0	-3.1	2.93 H	337	66.5	4.4
4	5351.00	53.1 AV	54.0	-0.9	2.93 H	337	48.7	4.4
5	#5472.30	60.4 PK	74.0	-13.6	2.93 H	337	55.9	4.5
6	#5472.30	47.2 AV	54.0	-6.8	2.93 H	337	42.7	4.5
7	10620.00	48.4 PK	74.0	-25.6	1.45 H	262	34.5	13.9
8	10620.00	36.0 AV	54.0	-18.0	1.45 H	262	22.1	13.9
9	15930.00	47.1 PK	74.0	-26.9	1.51 H	246	33.8	13.3
10	15930.00	35.4 AV	54.0	-18.6	1.51 H	246	22.1	13.3

**REMARKS:**

1. Emission Level(dBuV/m) = Raw Value(dBuV) + Correction Factor(dB/m)
2. Correction Factor(dB/m) = Antenna Factor(dB/m) + Cable Factor(dB) – Pre-Amplifier Factor(dB)
3. The other emission levels were very low against the limit.
4. Margin value = Emission Level – Limit value
5. " \* ": Fundamental frequency.
6. " # ": The radiated frequency is out of the restricted band.

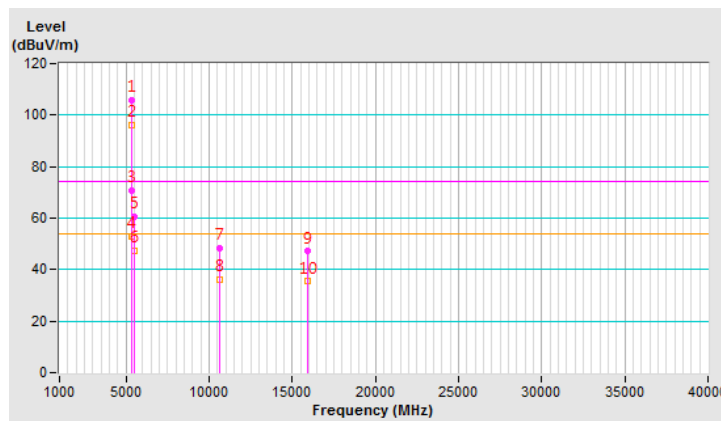

<b>CHANNEL</b>	TX Channel 62	<b>DETECTOR FUNCTION</b>	Peak (PK)
<b>FREQUENCY RANGE</b>	1GHz ~ 40GHz		Average (AV)

**ANTENNA POLARITY & TEST DISTANCE: VERTICAL AT 3 M**

NO.	FREQ. (MHz)	EMISSION LEVEL (dBuV/m)	LIMIT (dBuV/m)	MARGIN (dB)	ANTENNA HEIGHT (m)	TABLE ANGLE (Degree)	RAW VALUE (dBuV)	CORRECTION FACTOR (dB/m)
1	*5310.00	109.3 PK			2.55 V	81	105.0	4.3
2	*5310.00	99.9 AV			2.55 V	81	95.6	4.3
3	5351.00	72.8 PK	74.0	-1.2	2.55 V	81	68.4	4.4
<b>4</b>	<b>5351.00</b>	<b>53.9 AV</b>	<b>54.0</b>	<b>-0.1</b>	<b>2.55 V</b>	<b>81</b>	<b>49.5</b>	<b>4.4</b>
5	#5472.30	62.5 PK	74.0	-11.5	2.55 V	86	58.0	4.5
6	#5472.30	48.3 AV	54.0	-5.7	2.55 V	86	43.8	4.5
7	10620.00	51.1 PK	74.0	-22.9	1.50 V	255	37.2	13.9
8	10620.00	39.3 AV	54.0	-14.7	1.50 V	255	25.4	13.9
9	15930.00	47.9 PK	74.0	-26.1	1.46 V	122	34.6	13.3
10	15930.00	35.0 AV	54.0	-19.0	1.46 V	122	21.7	13.3

**REMARKS:**

1. Emission Level(dBuV/m) = Raw Value(dBuV) + Correction Factor(dB/m)
2. Correction Factor(dB/m) = Antenna Factor(dB/m) + Cable Factor(dB) – Pre-Amplifier Factor(dB)
3. The other emission levels were very low against the limit.
4. Margin value = Emission Level – Limit value
5. " \* ": Fundamental frequency.
6. " # ": The radiated frequency is out of the restricted band.

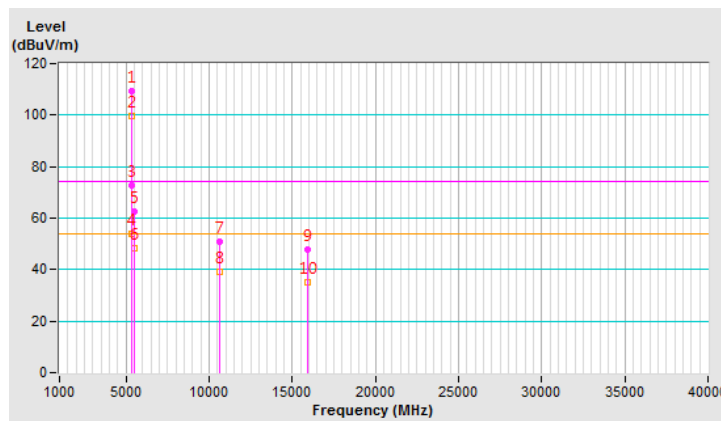

<b>CHANNEL</b>	TX Channel 102	<b>DETECTOR FUNCTION</b>	Peak (PK)
<b>FREQUENCY RANGE</b>	1GHz ~ 40GHz		Average (AV)

**ANTENNA POLARITY & TEST DISTANCE: HORIZONTAL AT 3 M**

NO.	FREQ. (MHz)	EMISSION LEVEL (dBuV/m)	LIMIT (dBuV/m)	MARGIN (dB)	ANTENNA HEIGHT (m)	TABLE ANGLE (Degree)	RAW VALUE (dBuV)	CORRECTION FACTOR (dB/m)
1	#5468.50	70.3 PK	74.0	-3.7	2.91 H	352	65.8	4.5
2	#5468.50	52.8 AV	54.0	-1.2	2.91 H	352	48.3	4.5
3	*5510.00	103.4 PK			2.91 H	352	98.8	4.6
4	*5510.00	94.5 AV			2.91 H	352	89.9	4.6
5	11020.00	51.9 PK	74.0	-22.1	1.53 H	335	37.2	14.7
6	11020.00	38.9 AV	54.0	-15.1	1.53 H	335	24.2	14.7
7	#16530.00	53.1 PK	74.0	-20.9	1.49 H	321	37.3	15.8
8	#16530.00	41.5 AV	54.0	-12.5	1.49 H	321	25.7	15.8

**REMARKS:**

1. Emission Level(dBuV/m) = Raw Value(dBuV) + Correction Factor(dB/m)
2. Correction Factor(dB/m) = Antenna Factor(dB/m) + Cable Factor(dB) – Pre-Amplifier Factor(dB)
3. The other emission levels were very low against the limit.
4. Margin value = Emission Level – Limit value
5. " \* ": Fundamental frequency.
6. " # ": The radiated frequency is out of the restricted band.

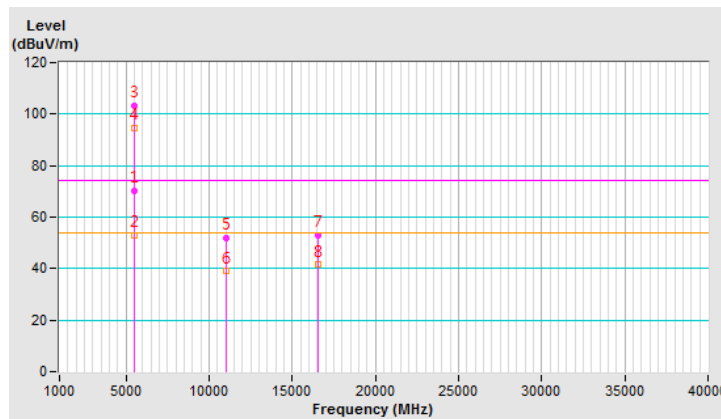

<b>CHANNEL</b>	TX Channel 102	<b>DETECTOR FUNCTION</b>	Peak (PK)
<b>FREQUENCY RANGE</b>	1GHz ~ 40GHz		Average (AV)

**ANTENNA POLARITY & TEST DISTANCE: VERTICAL AT 3 M**

NO.	FREQ. (MHz)	EMISSION LEVEL (dBuV/m)	LIMIT (dBuV/m)	MARGIN (dB)	ANTENNA HEIGHT (m)	TABLE ANGLE (Degree)	RAW VALUE (dBuV)	CORRECTION FACTOR (dB/m)
1	#5468.50	72.4 PK	74.0	-1.6	1.50 V	63	67.9	4.5
2	#5468.50	53.9 AV	54.0	-0.1	1.50 V	63	49.4	4.5
3	*5510.00	107.6 PK			1.50 V	63	103.0	4.6
4	*5510.00	98.2 AV			1.50 V	63	93.6	4.6
5	11020.00	52.8 PK	74.0	-21.2	1.62 V	276	38.1	14.7
6	11020.00	40.2 AV	54.0	-13.8	1.62 V	276	25.5	14.7
7	#16530.00	53.6 PK	74.0	-20.4	1.44 V	258	37.8	15.8
8	#16530.00	41.7 AV	54.0	-12.3	1.44 V	258	25.9	15.8

**REMARKS:**

1. Emission Level(dBuV/m) = Raw Value(dBuV) + Correction Factor(dB/m)
2. Correction Factor(dB/m) = Antenna Factor(dB/m) + Cable Factor(dB) – Pre-Amplifier Factor(dB)
3. The other emission levels were very low against the limit.
4. Margin value = Emission Level – Limit value
5. " \* ": Fundamental frequency.
6. " # ": The radiated frequency is out of the restricted band.

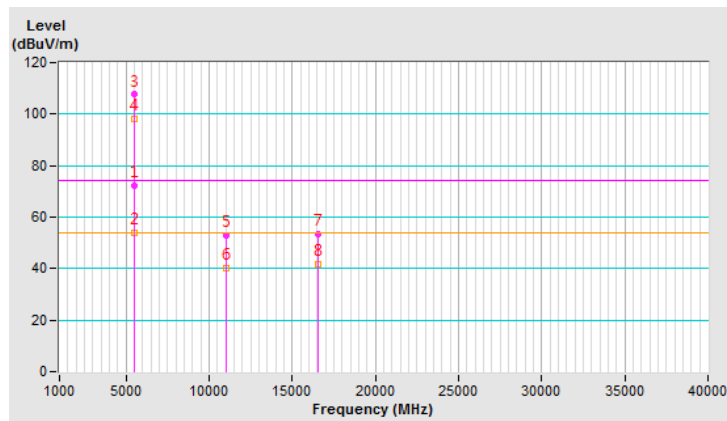

<b>CHANNEL</b>	TX Channel 110	<b>DETECTOR FUNCTION</b>	Peak (PK)
<b>FREQUENCY RANGE</b>	1GHz ~ 40GHz		Average (AV)

**ANTENNA POLARITY & TEST DISTANCE: HORIZONTAL AT 3 M**

NO.	FREQ. (MHz)	EMISSION LEVEL (dBuV/m)	LIMIT (dBuV/m)	MARGIN (dB)	ANTENNA HEIGHT (m)	TABLE ANGLE (Degree)	RAW VALUE (dBuV)	CORRECTION FACTOR (dB/m)
1	#5468.90	59.1 PK	74.0	-14.9	2.89 H	360	54.6	4.5
2	#5468.90	48.9 AV	54.0	-5.1	2.89 H	360	44.4	4.5
3	*5550.00	105.9 PK			2.89 H	360	101.4	4.5
4	*5550.00	96.3 AV			2.89 H	360	91.8	4.5
5	#5725.00	49.5 PK	74.0	-24.5	2.89 H	360	44.6	4.9
6	#5725.00	43.6 AV	54.0	-10.4	2.89 H	360	38.7	4.9
7	11100.00	51.4 PK	74.0	-22.6	1.57 H	344	37.0	14.4
8	11100.00	38.3 AV	54.0	-15.7	1.57 H	344	23.9	14.4
9	#16650.00	52.2 PK	74.0	-21.8	1.55 H	311	35.8	16.4
10	#16650.00	40.6 AV	54.0	-13.4	1.55 H	311	24.2	16.4

**REMARKS:**

1. Emission Level(dBuV/m) = Raw Value(dBuV) + Correction Factor(dB/m)
2. Correction Factor(dB/m) = Antenna Factor(dB/m) + Cable Factor(dB) – Pre-Amplifier Factor(dB)
3. The other emission levels were very low against the limit.
4. Margin value = Emission Level – Limit value
5. " \* ": Fundamental frequency.
6. " # ": The radiated frequency is out of the restricted band.

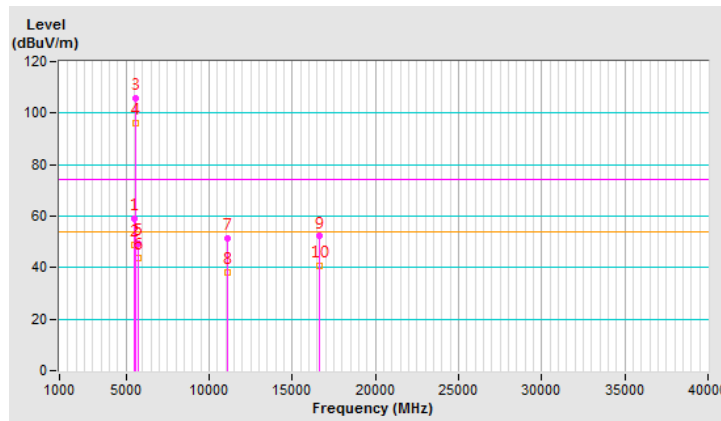



<b>CHANNEL</b>	TX Channel 110	<b>DETECTOR FUNCTION</b>	Peak (PK)
<b>FREQUENCY RANGE</b>	1GHz ~ 40GHz		Average (AV)

**ANTENNA POLARITY & TEST DISTANCE: VERTICAL AT 3 M**

NO.	FREQ. (MHz)	EMISSION LEVEL (dBuV/m)	LIMIT (dBuV/m)	MARGIN (dB)	ANTENNA HEIGHT (m)	TABLE ANGLE (Degree)	RAW VALUE (dBuV)	CORRECTION FACTOR (dB/m)
1	#5468.90	60.9 PK	74.0	-13.1	1.50 V	58	56.4	4.5
2	#5468.90	49.8 AV	54.0	-4.2	1.50 V	58	45.3	4.5
3	*5550.00	109.7 PK			1.50 V	58	105.2	4.5
4	*5550.00	99.9 AV			1.50 V	58	95.4	4.5
5	#5725.00	51.6 PK	74.0	-22.4	1.50 V	58	46.7	4.9
6	#5725.00	44.5 AV	54.0	-9.5	1.50 V	58	39.6	4.9
7	11100.00	52.9 PK	74.0	-21.1	1.68 V	282	38.5	14.4
8	11100.00	40.7 AV	54.0	-13.3	1.68 V	282	26.3	14.4
9	#16650.00	53.0 PK	74.0	-21.0	1.45 V	257	36.6	16.4
10	#16650.00	41.2 AV	54.0	-12.8	1.45 V	257	24.8	16.4

**REMARKS:**

1. Emission Level(dBuV/m) = Raw Value(dBuV) + Correction Factor(dB/m)
2. Correction Factor(dB/m) = Antenna Factor(dB/m) + Cable Factor(dB) – Pre-Amplifier Factor(dB)
3. The other emission levels were very low against the limit.
4. Margin value = Emission Level – Limit value
5. " \* ": Fundamental frequency.
6. " # ": The radiated frequency is out of the restricted band.

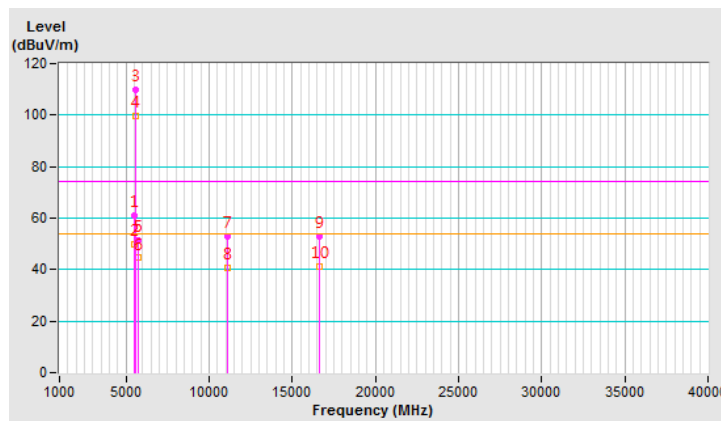

<b>CHANNEL</b>	TX Channel 134	<b>DETECTOR FUNCTION</b>	Peak (PK)
<b>FREQUENCY RANGE</b>	1GHz ~ 40GHz		Average (AV)

**ANTENNA POLARITY & TEST DISTANCE: HORIZONTAL AT 3 M**

NO.	FREQ. (MHz)	EMISSION LEVEL (dBuV/m)	LIMIT (dBuV/m)	MARGIN (dB)	ANTENNA HEIGHT (m)	TABLE ANGLE (Degree)	RAW VALUE (dBuV)	CORRECTION FACTOR (dB/m)
1	*5670.00	107.8 PK			2.87 H	353	103.0	4.8
2	*5670.00	98.6 AV			2.87 H	353	93.8	4.8
3	#5725.00	64.9 PK	74.0	-9.1	2.87 H	353	60.0	4.9
4	#5725.00	52.4 AV	54.0	-1.6	2.87 H	353	47.5	4.9
5	#5824.90	58.9 PK	74.0	-15.1	2.87 H	353	53.7	5.2
6	#5824.90	50.4 AV	54.0	-3.6	2.87 H	353	45.2	5.2
7	11340.00	51.9 PK	74.0	-22.1	1.55 H	336	37.5	14.4
8	11340.00	38.8 AV	54.0	-15.2	1.55 H	336	24.4	14.4
9	#17010.00	52.8 PK	74.0	-21.2	1.53 H	338	34.6	18.2
10	#17010.00	41.5 AV	54.0	-12.5	1.53 H	338	23.3	18.2

**REMARKS:**

1. Emission Level(dBuV/m) = Raw Value(dBuV) + Correction Factor(dB/m)
2. Correction Factor(dB/m) = Antenna Factor(dB/m) + Cable Factor(dB) – Pre-Amplifier Factor(dB)
3. The other emission levels were very low against the limit.
4. Margin value = Emission Level – Limit value
5. " \* ": Fundamental frequency.
6. " # ": The radiated frequency is out of the restricted band.

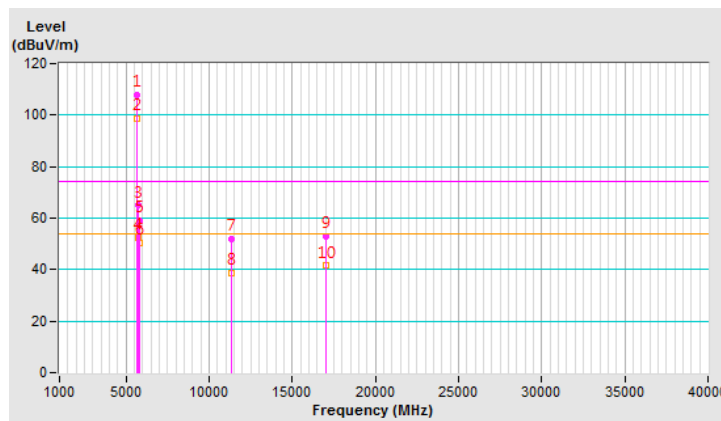

<b>CHANNEL</b>	TX Channel 134	<b>DETECTOR FUNCTION</b>	Peak (PK)
<b>FREQUENCY RANGE</b>	1GHz ~ 40GHz		Average (AV)

**ANTENNA POLARITY & TEST DISTANCE: VERTICAL AT 3 M**

NO.	FREQ. (MHz)	EMISSION LEVEL (dBuV/m)	LIMIT (dBuV/m)	MARGIN (dB)	ANTENNA HEIGHT (m)	TABLE ANGLE (Degree)	RAW VALUE (dBuV)	CORRECTION FACTOR (dB/m)
1	*5670.00	112.5 PK			2.55 V	100	107.7	4.8
2	*5670.00	102.3 AV			2.55 V	100	97.5	4.8
3	#5725.00	67.0 PK	74.0	-7.0	2.55 V	100	62.1	4.9
4	#5725.00	53.3 AV	54.0	-0.7	2.55 V	100	48.4	4.9
5	#5824.90	60.8 PK	74.0	-13.2	2.55 V	87	55.6	5.2
6	#5824.90	51.5 AV	54.0	-2.5	2.55 V	87	46.3	5.2
7	11340.00	53.3 PK	74.0	-20.7	1.60 V	295	38.9	14.4
8	11340.00	40.7 AV	54.0	-13.3	1.60 V	295	26.3	14.4
9	#17010.00	53.8 PK	74.0	-20.2	1.37 V	266	35.6	18.2
10	#17010.00	41.9 AV	54.0	-12.1	1.37 V	266	23.7	18.2

**REMARKS:**

1. Emission Level(dBuV/m) = Raw Value(dBuV) + Correction Factor(dB/m)
2. Correction Factor(dB/m) = Antenna Factor(dB/m) + Cable Factor(dB) – Pre-Amplifier Factor(dB)
3. The other emission levels were very low against the limit.
4. Margin value = Emission Level – Limit value
5. " \* ": Fundamental frequency.
6. " # ": The radiated frequency is out of the restricted band.

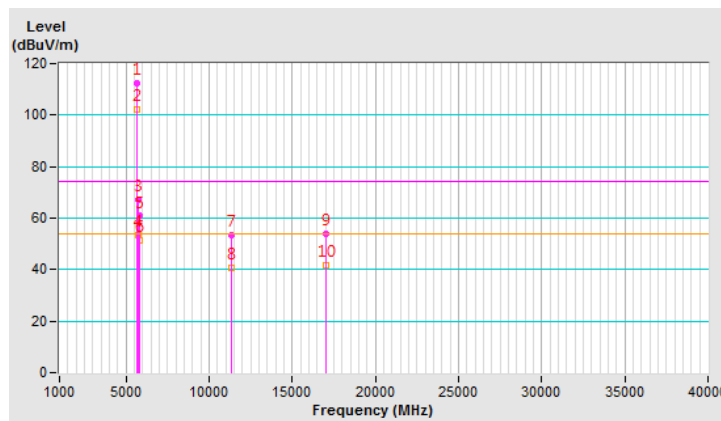

<b>CHANNEL</b>	TX Channel 142	<b>DETECTOR FUNCTION</b>	Peak (PK)
<b>FREQUENCY RANGE</b>	1GHz ~ 40GHz		Average (AV)

**ANTENNA POLARITY & TEST DISTANCE: HORIZONTAL AT 3 M**

NO.	FREQ. (MHz)	EMISSION LEVEL (dBuV/m)	LIMIT (dBuV/m)	MARGIN (dB)	ANTENNA HEIGHT (m)	TABLE ANGLE (Degree)	RAW VALUE (dBuV)	CORRECTION FACTOR (dB/m)
1	#5470.00	57.8 PK	74.0	-16.2	2.85 H	345	53.3	4.5
2	#5470.00	44.0 AV	54.0	-10.0	2.85 H	345	39.5	4.5
3	*5710.00	106.2 PK			2.85 H	345	101.3	4.9
4	*5710.00	97.6 AV			2.85 H	345	92.7	4.9
5	#5852.60	57.6 PK	74.0	-16.4	2.85 H	345	52.5	5.1
6	#5852.60	48.3 AV	54.0	-5.7	2.85 H	345	43.2	5.1
7	11420.00	51.3 PK	74.0	-22.7	1.56 H	327	37.0	14.3
8	11420.00	38.1 AV	54.0	-15.9	1.56 H	327	23.8	14.3
9	#17130.00	52.7 PK	74.0	-21.3	1.56 H	341	34.2	18.5
10	#17130.00	41.3 AV	54.0	-12.7	1.56 H	341	22.8	18.5

**REMARKS:**

1. Emission Level(dBuV/m) = Raw Value(dBuV) + Correction Factor(dB/m)
2. Correction Factor(dB/m) = Antenna Factor(dB/m) + Cable Factor(dB) – Pre-Amplifier Factor(dB)
3. The other emission levels were very low against the limit.
4. Margin value = Emission Level – Limit value
5. " \* ": Fundamental frequency.
6. " # ": The radiated frequency is out of the restricted band.

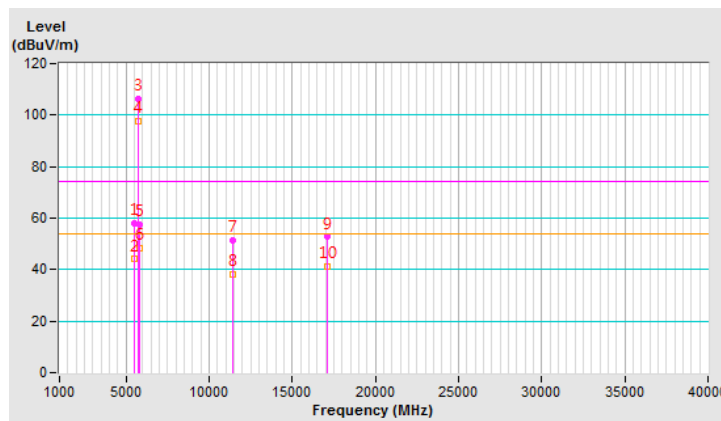

<b>CHANNEL</b>	TX Channel 142	<b>DETECTOR FUNCTION</b>	Peak (PK)
<b>FREQUENCY RANGE</b>	1GHz ~ 40GHz		Average (AV)

**ANTENNA POLARITY & TEST DISTANCE: VERTICAL AT 3 M**

NO.	FREQ. (MHz)	EMISSION LEVEL (dBuV/m)	LIMIT (dBuV/m)	MARGIN (dB)	ANTENNA HEIGHT (m)	TABLE ANGLE (Degree)	RAW VALUE (dBuV)	CORRECTION FACTOR (dB/m)
1	#5470.00	59.9 PK	74.0	-14.1	2.26 V	125	55.4	4.5
2	#5470.00	45.1 AV	54.0	-8.9	2.26 V	125	40.6	4.5
3	*5710.00	110.9 PK			2.26 V	125	106.0	4.9
4	*5710.00	101.3 AV			2.26 V	125	96.4	4.9
5	#5852.60	59.9 PK	74.0	-14.1	2.26 V	125	54.8	5.1
6	#5852.60	49.2 AV	54.0	-4.8	2.26 V	125	44.1	5.1
7	11420.00	52.7 PK	74.0	-21.3	1.67 V	279	38.4	14.3
8	11420.00	40.3 AV	54.0	-13.7	1.67 V	279	26.0	14.3
9	#17130.00	53.6 PK	74.0	-20.4	1.48 V	259	35.1	18.5
10	#17130.00	41.9 AV	54.0	-12.1	1.48 V	259	23.4	18.5

**REMARKS:**

1. Emission Level(dBuV/m) = Raw Value(dBuV) + Correction Factor(dB/m)
2. Correction Factor(dB/m) = Antenna Factor(dB/m) + Cable Factor(dB) – Pre-Amplifier Factor(dB)
3. The other emission levels were very low against the limit.
4. Margin value = Emission Level – Limit value
5. " \* ": Fundamental frequency.
6. " # ": The radiated frequency is out of the restricted band.

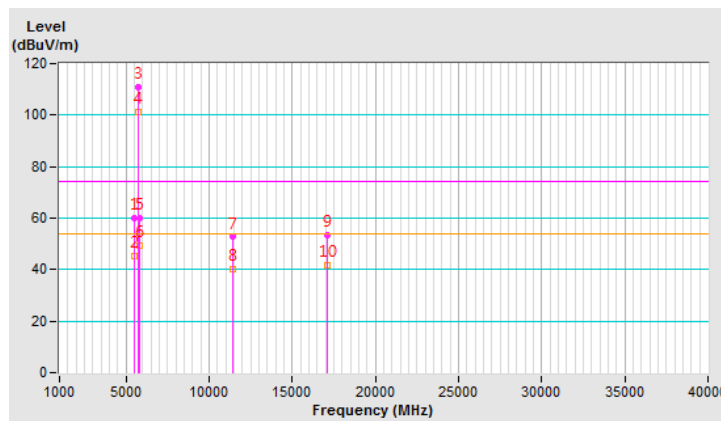

802.11ac (VHT80)

<b>CHANNEL</b>	TX Channel 58	<b>DETECTOR FUNCTION</b>	Peak (PK)
<b>FREQUENCY RANGE</b>	1GHz ~ 40GHz		Average (AV)

ANTENNA POLARITY & TEST DISTANCE: HORIZONTAL AT 3 M								
NO.	FREQ. (MHz)	EMISSION LEVEL (dBuV/m)	LIMIT (dBuV/m)	MARGIN (dB)	ANTENNA HEIGHT (m)	TABLE ANGLE (Degree)	RAW VALUE (dBuV)	CORRECTION FACTOR (dB/m)
1	5150.00	53.5 PK	74.0	-20.5	2.79 H	358	49.5	4.0
2	5150.00	42.8 AV	54.0	-11.2	2.79 H	358	38.8	4.0
3	*5290.00	100.5 PK			2.79 H	358	96.2	4.3
4	*5290.00	92.8 AV			2.79 H	358	88.5	4.3
5	5350.00	65.1 PK	74.0	-8.9	2.79 H	358	60.7	4.4
6	5350.00	52.6 AV	54.0	-1.4	2.79 H	358	48.2	4.4
7	#10580.00	48.2 PK	74.0	-25.8	1.54 H	251	34.3	13.9
8	#10580.00	36.2 AV	54.0	-17.8	1.54 H	251	22.3	13.9
9	15870.00	47.2 PK	74.0	-26.8	1.54 H	229	33.8	13.4
10	15870.00	35.4 AV	54.0	-18.6	1.54 H	229	22.0	13.4

REMARKS:

1. Emission Level(dBuV/m) = Raw Value(dBuV) + Correction Factor(dB/m)
2. Correction Factor(dB/m) = Antenna Factor(dB/m) + Cable Factor(dB) – Pre-Amplifier Factor(dB)
3. The other emission levels were very low against the limit.
4. Margin value = Emission Level – Limit value
5. " \* ": Fundamental frequency.
6. " # ": The radiated frequency is out of the restricted band.

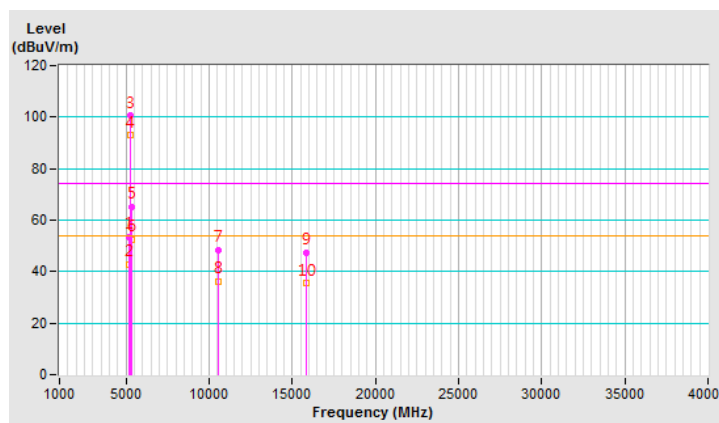

<b>CHANNEL</b>	TX Channel 58	<b>DETECTOR FUNCTION</b>	Peak (PK)
<b>FREQUENCY RANGE</b>	1GHz ~ 40GHz		Average (AV)

**ANTENNA POLARITY & TEST DISTANCE: VERTICAL AT 3 M**

NO.	FREQ. (MHz)	EMISSION LEVEL (dBuV/m)	LIMIT (dBuV/m)	MARGIN (dB)	ANTENNA HEIGHT (m)	TABLE ANGLE (Degree)	RAW VALUE (dBuV)	CORRECTION FACTOR (dB/m)
1	5150.00	55.4 PK	74.0	-18.6	3.63 V	88	51.4	4.0
2	5150.00	43.7 AV	54.0	-10.3	3.63 V	88	39.7	4.0
3	*5290.00	105.2 PK			3.63 V	88	100.9	4.3
4	*5290.00	96.5 AV			3.63 V	88	92.2	4.3
5	5350.00	67.3 PK	74.0	-6.7	3.63 V	88	62.9	4.4
6	5350.00	53.7 AV	54.0	-0.3	3.63 V	88	49.3	4.4
7	#10580.00	50.9 PK	74.0	-23.1	1.42 V	247	37.0	13.9
8	#10580.00	39.1 AV	54.0	-14.9	1.42 V	247	25.2	13.9
9	15870.00	47.6 PK	74.0	-26.4	1.54 V	116	34.2	13.4
10	15870.00	34.4 AV	54.0	-19.6	1.54 V	116	21.0	13.4

**REMARKS:**

1. Emission Level(dBuV/m) = Raw Value(dBuV) + Correction Factor(dB/m)
2. Correction Factor(dB/m) = Antenna Factor(dB/m) + Cable Factor(dB) – Pre-Amplifier Factor(dB)
3. The other emission levels were very low against the limit.
4. Margin value = Emission Level – Limit value
5. " \* ": Fundamental frequency.
6. " # ": The radiated frequency is out of the restricted band.

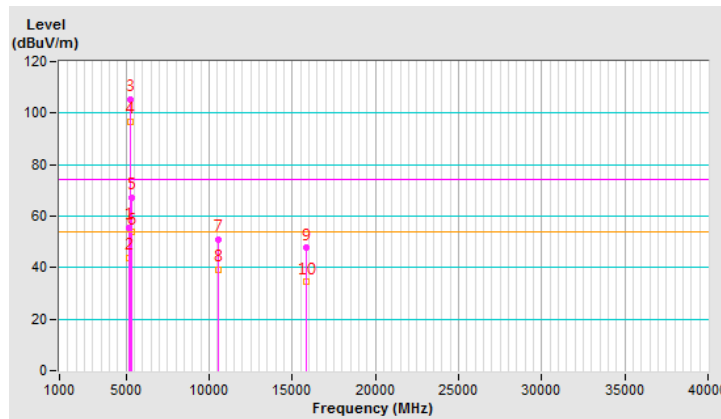

<b>CHANNEL</b>	TX Channel 106	<b>DETECTOR FUNCTION</b>	Peak (PK)
<b>FREQUENCY RANGE</b>	1GHz ~ 40GHz		Average (AV)

**ANTENNA POLARITY & TEST DISTANCE: HORIZONTAL AT 3 M**

NO.	FREQ. (MHz)	EMISSION LEVEL (dBuV/m)	LIMIT (dBuV/m)	MARGIN (dB)	ANTENNA HEIGHT (m)	TABLE ANGLE (Degree)	RAW VALUE (dBuV)	CORRECTION FACTOR (dB/m)
1	#5468.80	69.2 PK	74.0	-4.8	2.78 H	360	64.7	4.5
2	#5468.80	52.8 AV	54.0	-1.2	2.78 H	360	48.3	4.5
3	*5530.00	101.0 PK			2.78 H	360	96.5	4.5
4	*5530.00	93.0 AV			2.78 H	360	88.5	4.5
5	#5728.00	47.4 PK	74.0	-26.6	2.78 H	360	42.5	4.9
6	#5728.00	39.5 AV	54.0	-14.5	2.78 H	360	34.6	4.9
7	11060.00	51.7 PK	74.0	-22.3	1.46 H	336	37.2	14.5
8	11060.00	38.6 AV	54.0	-15.4	1.46 H	336	24.1	14.5
9	#16590.00	51.9 PK	74.0	-22.1	1.51 H	311	35.3	16.6
10	#16590.00	40.6 AV	54.0	-13.4	1.51 H	311	24.0	16.6

**REMARKS:**

1. Emission Level(dBuV/m) = Raw Value(dBuV) + Correction Factor(dB/m)
2. Correction Factor(dB/m) = Antenna Factor(dB/m) + Cable Factor(dB) – Pre-Amplifier Factor(dB)
3. The other emission levels were very low against the limit.
4. Margin value = Emission Level – Limit value
5. " \* ": Fundamental frequency.
6. " # ": The radiated frequency is out of the restricted band.

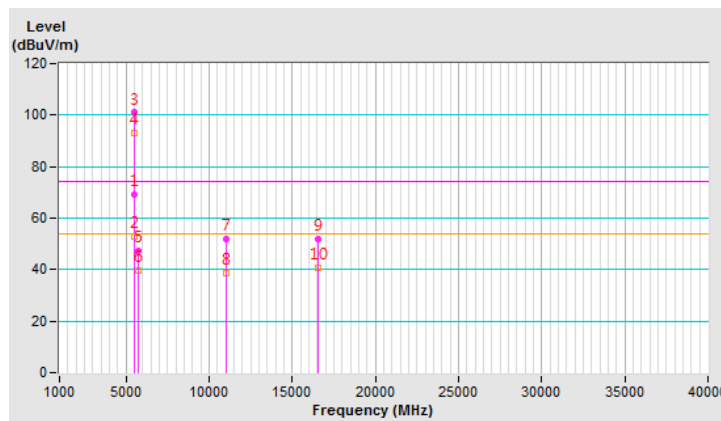



<b>CHANNEL</b>	TX Channel 106	<b>DETECTOR FUNCTION</b>	Peak (PK)
<b>FREQUENCY RANGE</b>	1GHz ~ 40GHz		Average (AV)

**ANTENNA POLARITY & TEST DISTANCE: VERTICAL AT 3 M**

NO.	FREQ. (MHz)	EMISSION LEVEL (dBuV/m)	LIMIT (dBuV/m)	MARGIN (dB)	ANTENNA HEIGHT (m)	TABLE ANGLE (Degree)	RAW VALUE (dBuV)	CORRECTION FACTOR (dB/m)
1	#5468.80	71.2 PK	74.0	-2.8	1.40 V	63	66.7	4.5
2	#5468.80	53.9 AV	54.0	-0.1	1.40 V	63	49.4	4.5
3	*5530.00	105.7 PK			1.40 V	63	101.2	4.5
4	*5530.00	96.7 AV			1.40 V	63	92.2	4.5
5	#5728.00	49.6 PK	74.0	-24.4	1.40 V	63	44.7	4.9
6	#5728.00	40.4 AV	54.0	-13.6	1.40 V	63	35.5	4.9
7	11060.00	52.7 PK	74.0	-21.3	1.58 V	273	38.2	14.5
8	11060.00	40.2 AV	54.0	-13.8	1.58 V	273	25.7	14.5
9	#16590.00	53.1 PK	74.0	-20.9	1.47 V	254	36.5	16.6
10	#16590.00	41.2 AV	54.0	-12.8	1.47 V	254	24.6	16.6

**REMARKS:**

1. Emission Level(dBuV/m) = Raw Value(dBuV) + Correction Factor(dB/m)
2. Correction Factor(dB/m) = Antenna Factor(dB/m) + Cable Factor(dB) – Pre-Amplifier Factor(dB)
3. The other emission levels were very low against the limit.
4. Margin value = Emission Level – Limit value
5. " \* ": Fundamental frequency.
6. " # ": The radiated frequency is out of the restricted band.

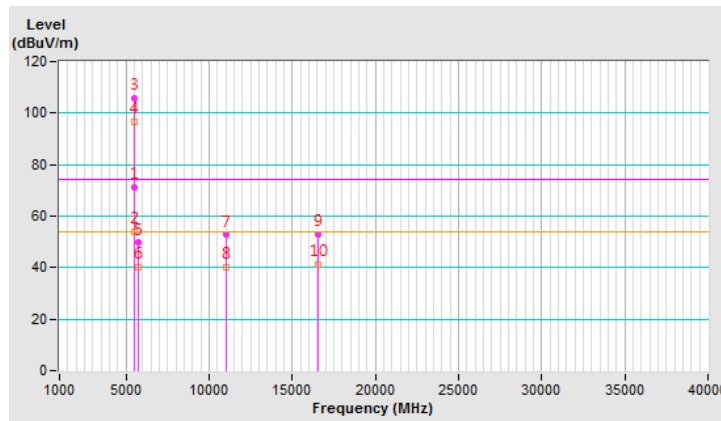

<b>CHANNEL</b>	TX Channel 122	<b>DETECTOR FUNCTION</b>	Peak (PK)
<b>FREQUENCY RANGE</b>	1GHz ~ 40GHz		Average (AV)

**ANTENNA POLARITY & TEST DISTANCE: HORIZONTAL AT 3 M**

NO.	FREQ. (MHz)	EMISSION LEVEL (dBuV/m)	LIMIT (dBuV/m)	MARGIN (dB)	ANTENNA HEIGHT (m)	TABLE ANGLE (Degree)	RAW VALUE (dBuV)	CORRECTION FACTOR (dB/m)
1	#5467.30	61.2 PK	74.0	-12.8	2.80 H	360	56.7	4.5
2	#5467.30	50.1 AV	54.0	-3.9	2.80 H	360	45.6	4.5
3	*5610.00	104.3 PK			2.80 H	360	99.6	4.7
4	*5610.00	95.7 AV			2.80 H	360	91.0	4.7
5	#5725.80	65.0 PK	74.0	-9.0	2.80 H	360	60.1	4.9
6	#5725.80	52.0 AV	54.0	-2.0	2.80 H	360	47.1	4.9
7	11220.00	51.5 PK	74.0	-22.5	1.46 H	328	37.1	14.4
8	11220.00	38.1 AV	54.0	-15.9	1.46 H	328	23.7	14.4
9	#16830.00	51.9 PK	74.0	-22.1	1.54 H	329	34.9	17.0
10	#16830.00	40.6 AV	54.0	-13.4	1.54 H	329	23.6	17.0

**REMARKS:**

1. Emission Level(dBuV/m) = Raw Value(dBuV) + Correction Factor(dB/m)
2. Correction Factor(dB/m) = Antenna Factor(dB/m) + Cable Factor(dB) – Pre-Amplifier Factor(dB)
3. The other emission levels were very low against the limit.
4. Margin value = Emission Level – Limit value
5. " \* ": Fundamental frequency.
6. " # ": The radiated frequency is out of the restricted band.

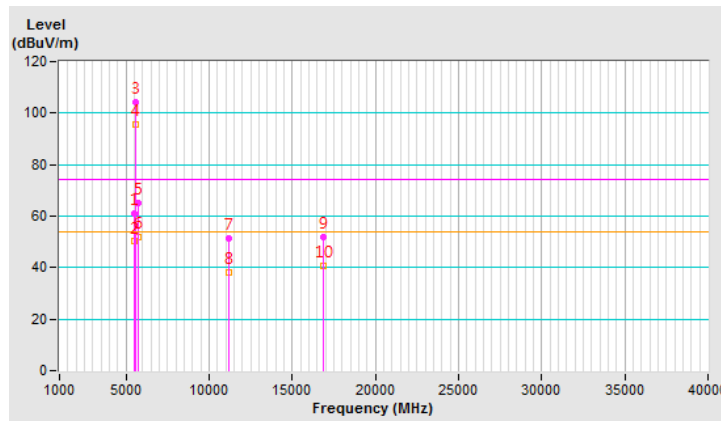

<b>CHANNEL</b>	TX Channel 122	<b>DETECTOR FUNCTION</b>	Peak (PK)
<b>FREQUENCY RANGE</b>	1GHz ~ 40GHz		Average (AV)

**ANTENNA POLARITY & TEST DISTANCE: VERTICAL AT 3 M**

NO.	FREQ. (MHz)	EMISSION LEVEL (dBuV/m)	LIMIT (dBuV/m)	MARGIN (dB)	ANTENNA HEIGHT (m)	TABLE ANGLE (Degree)	RAW VALUE (dBuV)	CORRECTION FACTOR (dB/m)
1	#5467.30	63.3 PK	74.0	-10.7	2.49 V	128	58.8	4.5
2	#5467.30	51.2 AV	54.0	-2.8	2.49 V	128	46.7	4.5
3	*5610.00	109.0 PK			2.49 V	128	104.3	4.7
4	*5610.00	99.4 AV			2.49 V	128	94.7	4.7
5	#5725.80	67.1 PK	74.0	-6.9	2.49 V	128	62.2	4.9
6	#5725.80	52.9 AV	54.0	-1.1	2.49 V	128	48.0	4.9
7	11220.00	52.8 PK	74.0	-21.2	1.67 V	294	38.4	14.4
8	11220.00	40.5 AV	54.0	-13.5	1.67 V	294	26.1	14.4
9	#16830.00	52.7 PK	74.0	-21.3	1.45 V	270	35.7	17.0
10	#16830.00	41.2 AV	54.0	-12.8	1.45 V	270	24.2	17.0

**REMARKS:**

1. Emission Level(dBuV/m) = Raw Value(dBuV) + Correction Factor(dB/m)
2. Correction Factor(dB/m) = Antenna Factor(dB/m) + Cable Factor(dB) – Pre-Amplifier Factor(dB)
3. The other emission levels were very low against the limit.
4. Margin value = Emission Level – Limit value
5. " \* ": Fundamental frequency.
6. " # ": The radiated frequency is out of the restricted band.

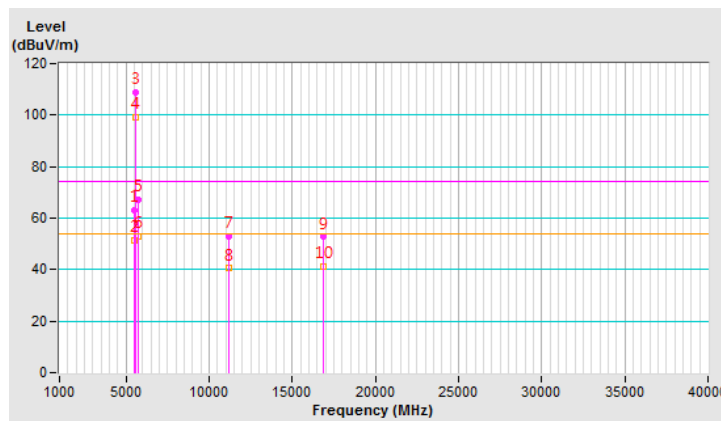

<b>CHANNEL</b>	TX Channel 138	<b>DETECTOR FUNCTION</b>	Peak (PK)
<b>FREQUENCY RANGE</b>	1GHz ~ 40GHz		Average (AV)

**ANTENNA POLARITY & TEST DISTANCE: HORIZONTAL AT 3 M**

NO.	FREQ. (MHz)	EMISSION LEVEL (dBuV/m)	LIMIT (dBuV/m)	MARGIN (dB)	ANTENNA HEIGHT (m)	TABLE ANGLE (Degree)	RAW VALUE (dBuV)	CORRECTION FACTOR (dB/m)
1	#5470.00	50.9 PK	74.0	-23.1	2.76 H	345	46.4	4.5
2	#5470.00	39.6 AV	54.0	-14.4	2.76 H	345	35.1	4.5
3	*5690.00	105.6 PK			2.76 H	345	100.8	4.8
4	*5690.00	95.9 AV			2.76 H	345	91.1	4.8
5	#5853.10	64.8 PK	74.0	-9.2	2.76 H	345	59.7	5.1
6	#5853.10	51.9 AV	54.0	-2.1	2.76 H	345	46.8	5.1
7	11380.00	51.1 PK	74.0	-22.9	1.50 H	340	36.7	14.4
8	11380.00	38.1 AV	54.0	-15.9	1.50 H	340	23.7	14.4
9	#17070.00	52.2 PK	74.0	-21.8	1.52 H	326	33.9	18.3
10	#17070.00	40.6 AV	54.0	-13.4	1.52 H	326	22.3	18.3

**REMARKS:**

1. Emission Level(dBuV/m) = Raw Value(dBuV) + Correction Factor(dB/m)
2. Correction Factor(dB/m) = Antenna Factor(dB/m) + Cable Factor(dB) – Pre-Amplifier Factor(dB)
3. The other emission levels were very low against the limit.
4. Margin value = Emission Level – Limit value
5. " \* ": Fundamental frequency.
6. " # ": The radiated frequency is out of the restricted band.

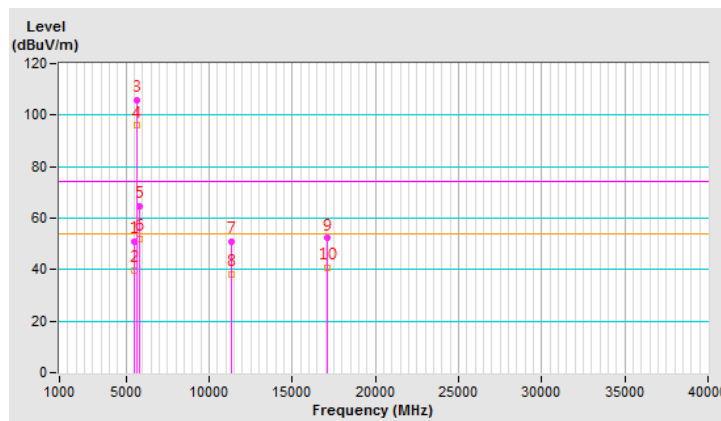

<b>CHANNEL</b>	TX Channel 138	<b>DETECTOR FUNCTION</b>	Peak (PK)
<b>FREQUENCY RANGE</b>	1GHz ~ 40GHz		Average (AV)

**ANTENNA POLARITY & TEST DISTANCE: VERTICAL AT 3 M**

NO.	FREQ. (MHz)	EMISSION LEVEL (dBuV/m)	LIMIT (dBuV/m)	MARGIN (dB)	ANTENNA HEIGHT (m)	TABLE ANGLE (Degree)	RAW VALUE (dBuV)	CORRECTION FACTOR (dB/m)
1	#5470.00	53.0 PK	74.0	-21.0	2.36 V	135	48.5	4.5
2	#5470.00	40.5 AV	54.0	-13.5	2.36 V	135	36.0	4.5
3	*5690.00	108.9 PK			2.36 V	135	104.1	4.8
4	*5690.00	99.6 AV			2.36 V	135	94.8	4.8
5	#5853.10	66.6 PK	74.0	-7.4	2.36 V	135	61.5	5.1
6	#5853.10	53.0 AV	54.0	-1.0	2.36 V	135	47.9	5.1
7	11380.00	52.2 PK	74.0	-21.8	1.62 V	275	37.8	14.4
8	11380.00	40.0 AV	54.0	-14.0	1.62 V	275	25.6	14.4
9	#17070.00	53.7 PK	74.0	-20.3	1.38 V	269	35.4	18.3
10	#17070.00	42.1 AV	54.0	-11.9	1.38 V	269	23.8	18.3

**REMARKS:**

1. Emission Level(dBuV/m) = Raw Value(dBuV) + Correction Factor(dB/m)
2. Correction Factor(dB/m) = Antenna Factor(dB/m) + Cable Factor(dB) – Pre-Amplifier Factor(dB)
3. The other emission levels were very low against the limit.
4. Margin value = Emission Level – Limit value
5. " \* ": Fundamental frequency.
6. " # ": The radiated frequency is out of the restricted band.

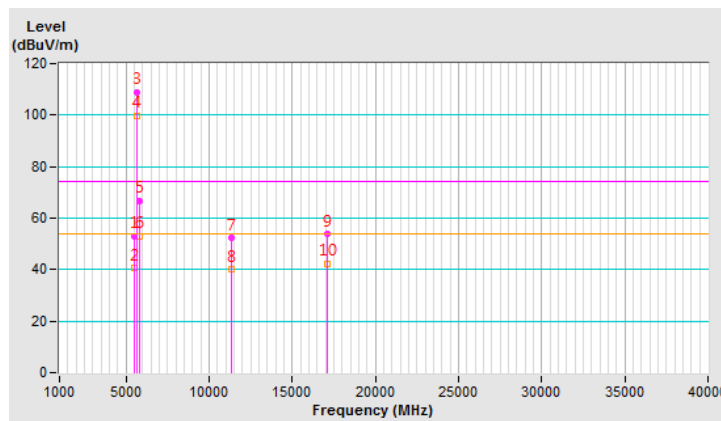

**Below 1GHz Data:**

**802.11ac (VHT80)**

<b>CHANNEL</b>	TX Channel 122	<b>DETECTOR FUNCTION</b>	Quasi-Peak (QP)
<b>FREQUENCY RANGE</b>	9kHz ~ 1GHz		

**ANTENNA POLARITY & TEST DISTANCE: HORIZONTAL AT 3 M**

NO.	FREQ. (MHz)	EMISSION LEVEL (dBuV/m)	LIMIT (dBuV/m)	MARGIN (dB)	ANTENNA HEIGHT (m)	TABLE ANGLE (Degree)	RAW VALUE (dBuV)	CORRECTION FACTOR (dB/m)
1	30.36	31.2 QP	40.0	-8.8	2.00 H	360	40.7	-9.5
2	125.01	35.3 QP	43.5	-8.2	1.50 H	85	44.9	-9.6
3	249.51	34.2 QP	46.0	-11.8	2.00 H	360	43.7	-9.5
4	375.00	36.9 QP	46.0	-9.1	1.00 H	63	42.7	-5.8
5	625.00	35.6 QP	46.0	-10.4	1.00 H	48	35.7	-0.1
6	874.99	33.3 QP	46.0	-12.7	2.00 H	360	29.7	3.6

**REMARKS:**

1. Emission Level(dBuV/m) = Raw Value(dBuV) + Correction Factor(dB/m)
2. Correction Factor(dB/m) = Antenna Factor(dB/m) + Cable Factor(dB) – Pre-Amplifier Factor(dB)
3. The other emission levels were very low against the limit.
4. Margin value = Emission Level – Limit value

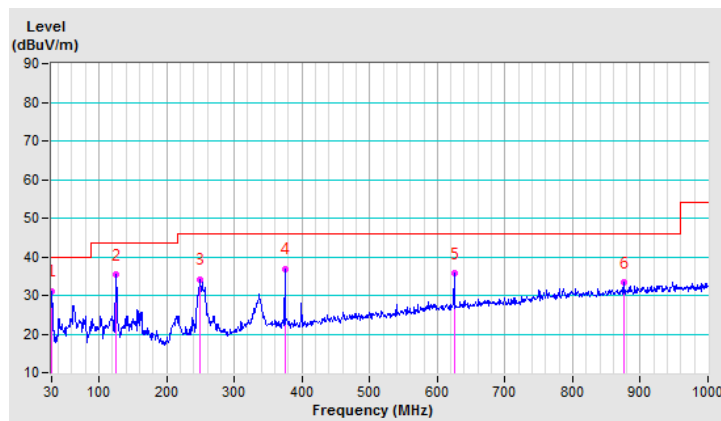

<b>CHANNEL</b>	TX Channel 122	<b>DETECTOR FUNCTION</b>	Quasi-Peak (QP)
<b>FREQUENCY RANGE</b>	9kHz ~ 1GHz		

**ANTENNA POLARITY & TEST DISTANCE: VERTICAL AT 3 M**

NO.	FREQ. (MHz)	EMISSION LEVEL (dBuV/m)	LIMIT (dBuV/m)	MARGIN (dB)	ANTENNA HEIGHT (m)	TABLE ANGLE (Degree)	RAW VALUE (dBuV)	CORRECTION FACTOR (dB/m)
1	44.26	28.9 QP	40.0	-11.1	1.00 V	10	36.6	-7.7
2	125.01	33.9 QP	43.5	-9.6	1.00 V	90	43.5	-9.6
3	251.26	36.4 QP	46.0	-9.6	1.00 V	0	45.8	-9.4
4	375.00	34.8 QP	46.0	-11.2	1.50 V	74	40.6	-5.8
5	625.00	33.2 QP	46.0	-12.8	1.50 V	48	33.3	-0.1
6	875.04	33.1 QP	46.0	-12.9	1.00 V	39	29.5	3.6

**REMARKS:**

1. Emission Level(dBuV/m) = Raw Value(dBuV) + Correction Factor(dB/m)
2. Correction Factor(dB/m) = Antenna Factor(dB/m) + Cable Factor(dB) – Pre-Amplifier Factor(dB)
3. The other emission levels were very low against the limit.
4. Margin value = Emission Level – Limit value

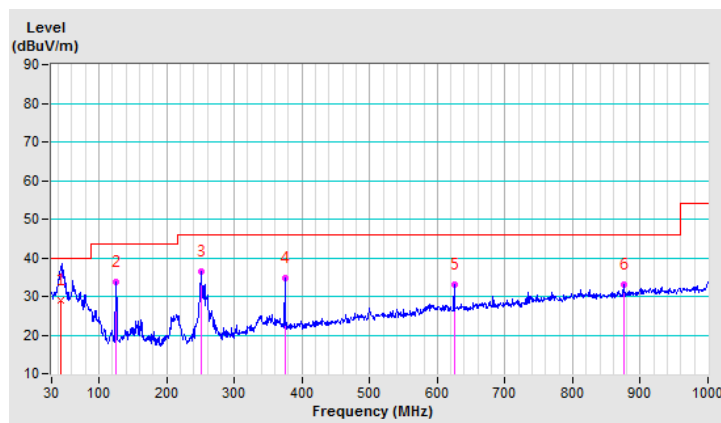

## 4.2 Conducted Emission Measurement

### 4.2.1 Limits of Conducted Emission Measurement

Frequency (MHz)	Conducted Limit (dBuV)	
	Quasi-peak	Average
0.15 - 0.5	66 - 56	56 - 46
0.50 - 5.0	56	46
5.0 - 30.0	60	50

Note: 1. The lower limit shall apply at the transition frequencies.

2. The limit decreases in line with the logarithm of the frequency in the range of 0.15 to 0.50MHz.

### 4.2.2 Test Instruments

DESCRIPTION & MANUFACTURER	MODEL NO.	SERIAL NO.	CALIBRATED DATE	CALIBRATED UNTIL
Test Receiver R&S	ESCS 30	847124/029	Nov. 01, 2017	Oct. 31, 2018
Line-Impedance Stabilization Network (for EUT) R&S	ESH3-Z5	848773/004	Nov. 15, 20167	Nov. 14, 2018
Line-Impedance Stabilization Network (for Peripheral) R&S	ENV216	100072	June 03, 2017	June 02, 2018
50 ohms Terminator	N/A	EMC-02	Sep. 22, 2017	Sep. 21, 2018
RF Cable	5D-FB	COCCAB-001	Sep. 29, 2017	Sep. 28, 2018
10 dB PAD Mini-Circuits	HAT-10+	CONATT-004	June 18, 2017	June 17, 2018
Software BVADT	BVADT_Cond_ V7.3.7.4	NA	NA	NA

**Note:**

1. The calibration interval of the above test instruments are 12 months and the calibrations are traceable to NML/ROC and NIST/USA.
2. The test was performed in Shielded Room No. 1.
3. Tested Date: Nov. 21, 2017



#### 4.2.3 Test Procedure

- The EUT was placed 0.4 meters from the conducting wall of the shielded room with EUT being connected to the power mains through a line impedance stabilization network (LISN). Other support units were connected to the power mains through another LISN. The two LISNs provide 50 ohm/ 50uH of coupling impedance for the measuring instrument.
- Both lines of the power mains connected to the EUT were checked for maximum conducted interference.
- The frequency range from 150kHz to 30MHz was searched. Emission levels under (Limit - 20dB) was not recorded.

**NOTE:** All modes of operation were investigated and the worst-case emissions are reported.

#### 4.2.4 Deviation from Test Standard

No deviation.

#### 4.2.5 Test Setup

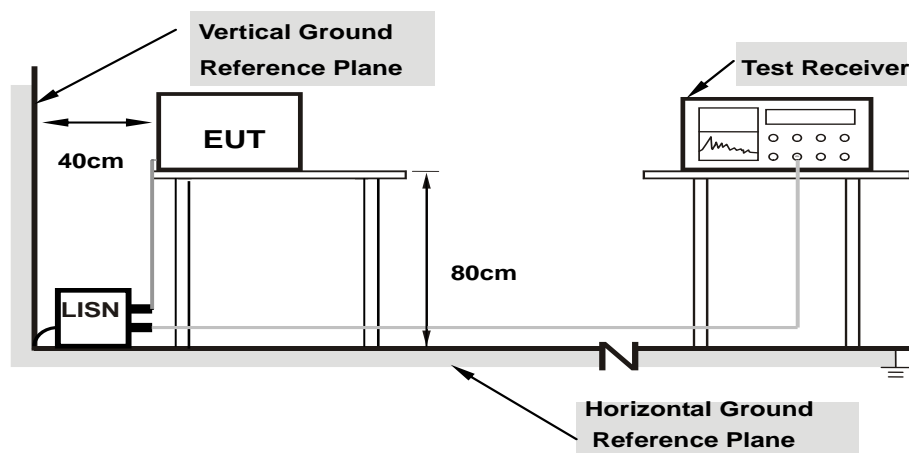

**Note: 1.Support units were connected to second LISN.**

For the actual test configuration, please refer to the attached file (Test Setup Photo).

#### 4.2.6 EUT Operating Condition

Same as 4.1.6.

#### 4.2.7 Test Results

Phase	Line (L)	Detector Function	Quasi-Peak (QP) / Average (AV)
-------	----------	-------------------	--------------------------------

No	Freq. [MHz]	Corr.	Reading Value		Emission Level		Limit		Margin	
		Factor	[dB (uV)]		[dB (uV)]		[dB (uV)]		(dB)	
	(dB)	Q.P.	AV.	Q.P.	AV.	Q.P.	AV.	Q.P.	AV.	
1	0.15391	10.08	43.58	28.23	53.66	38.31	65.79	55.79	-12.13	-17.48
2	0.18516	10.07	40.81	26.62	50.88	36.69	64.25	54.25	-13.37	-17.56
3	0.22812	10.08	33.47	20.69	43.55	30.77	62.52	52.52	-18.97	-21.75
4	0.27500	10.09	30.86	20.79	40.95	30.88	60.97	50.97	-20.02	-20.09
5	0.45078	10.12	23.84	16.46	33.96	26.58	56.86	46.86	-22.90	-20.28
6	16.00781	11.28	19.46	13.56	30.74	24.84	60.00	50.00	-29.26	-25.16

#### REMARKS:

1. Q.P. and AV. are abbreviations of quasi-peak and average individually.
2. The emission levels of other frequencies were very low against the limit.
3. Margin value = Emission level - Limit value
4. Correction factor = Insertion loss + Cable loss
5. Emission Level = Correction Factor + Reading Value.

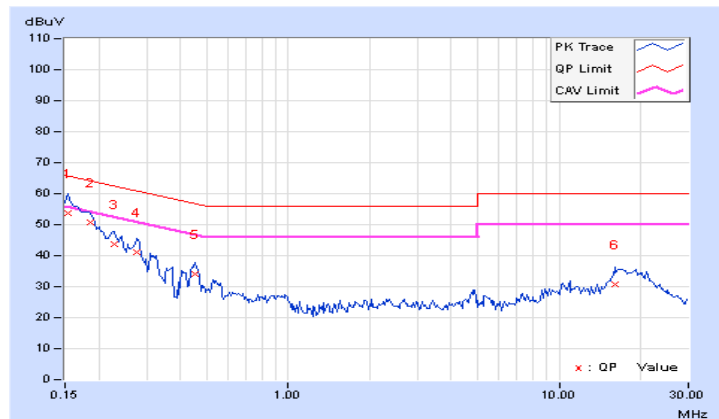

Phase	Neutral (N)	Detector Function	Quasi-Peak (QP) / Average (AV)
-------	-------------	-------------------	--------------------------------

No	Freq. [MHz]	Corr.	Reading Value		Emission Level		Limit		Margin	
		Factor (dB)	[dB (uV)]		[dB (uV)]		[dB (uV)]		(dB)	
			Q.P.	AV.	Q.P.	AV.	Q.P.	AV.	Q.P.	AV.
<b>1</b>	<b>0.15000</b>	<b>10.08</b>	<b>46.55</b>	<b>29.79</b>	<b>56.63</b>	<b>39.87</b>	<b>66.00</b>	<b>56.00</b>	<b>-9.37</b>	<b>-16.13</b>
2	0.16172	10.07	43.81	28.13	53.88	38.20	65.38	55.38	-11.50	-17.18
3	0.18516	10.05	40.42	26.34	50.47	36.39	64.25	54.25	-13.78	-17.86
4	0.22422	10.05	33.15	20.12	43.20	30.17	62.66	52.66	-19.46	-22.49
5	0.27891	10.07	30.29	17.73	40.36	27.80	60.85	50.85	-20.49	-23.05
6	15.76563	11.05	17.21	11.55	28.26	22.60	60.00	50.00	-31.74	-27.40

#### REMARKS:

1. Q.P. and AV. are abbreviations of quasi-peak and average individually.
2. The emission levels of other frequencies were very low against the limit.
3. Margin value = Emission level - Limit value
4. Correction factor = Insertion loss + Cable loss
5. Emission Level = Correction Factor + Reading Value.

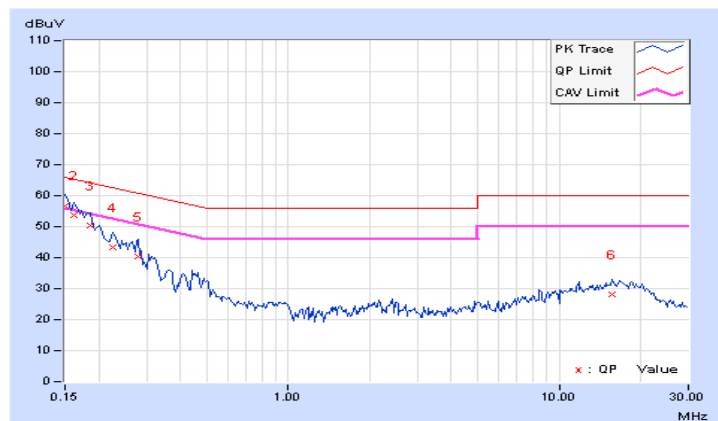

### 4.3 Transmit Power Measurement

#### 4.3.1 Limits of Transmit Power Measurement

Operation Band	EUT Category		Limit
U-NII-1		Outdoor Access Point	1 Watt (30 dBm) (Max. e.i.r.p $\leq$ 125mW(21 dBm) at any elevation angle above 30 degrees as measured from the horizon)
		Fixed point-to-point Access Point	1 Watt (30 dBm)
		Indoor Access Point	1 Watt (30 dBm)
		Mobile and Portable client device	250mW (24 dBm)
U-NII-2A		√	250mW (24 dBm) or 11 dBm+10 log B*
U-NII-2C		√	250mW (24 dBm) or 11 dBm+10 log B*
U-NII-3		√	1 Watt (30 dBm)

\*B is the 26 dB emission bandwidth in megahertz

Per KDB 662911 Method of conducted output power measurement on IEEE 802.11 devices,

Array Gain = 0 dB (i.e., no array gain) for  $N_{ANT} \leq 4$ ;

Array Gain = 0 dB (i.e., no array gain) for channel widths  $\geq 40$  MHz for any  $N_{ANT}$ ;

Array Gain =  $5 \log(N_{ANT}/N_{SS})$  dB or 3 dB, whichever is less for 20-MHz channel widths with  $N_{ANT} \geq 5$ .

For power measurements on all other devices: Array Gain =  $10 \log(N_{ANT}/N_{SS})$  dB.

#### 4.3.2 Test Setup

##### FOR POWER OUTPUT MEASUREMENT

For channel straddling 5725MHz:

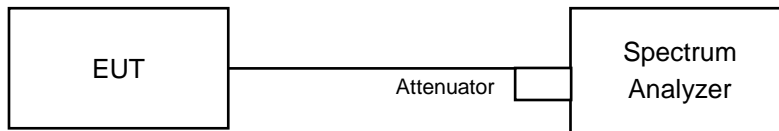

For other channels:

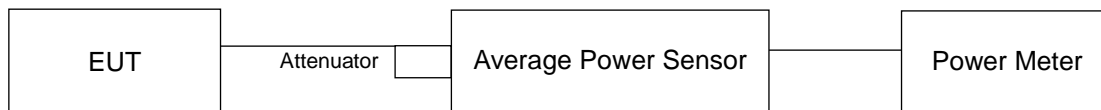

##### FOR 26dB OCCUPIED BANDWIDTH

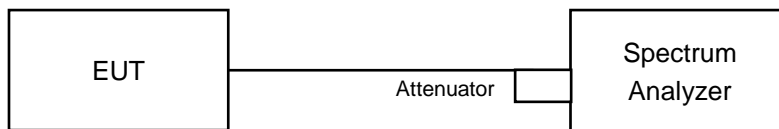

#### 4.3.3 Test Instruments

Refer to section 4.1.2 to get information of above instrument.

#### 4.3.4 Test Procedure

##### For Average Power Measurement

##### For channel straddling 5725MHz:

##### 802.11a, 802.11ac (VHT20)

###### Method SA-1

1. Set span to encompass the entire emission bandwidth (EBW) of the signal.
2. Set RBW =1MHz.
3. Set the VBW  $\geq 3 \times$  RBW.
4. Number of points in sweep  $\geq 2$  Span / RBW.
5. Sweep time = auto.
6. Set trigger to free run (duty cycle  $\geq 98$  percent)
7. Detector = RMS.
8. Trace average at least 100 traces in power averaging mode
9. Compute power by integrating the spectrum across the 26 dB EBW of the signal.

##### Other Modulation mode

###### Method SA-2

1. Set span to encompass the emission bandwidth (EBW) of the signal.
2. Set RBW =1MHz.
3. Set the VBW  $\geq 3 \times$  RBW.
4. Number of points in sweep  $\geq 2$  Span / RBW.
5. Sweep time = auto.
6. Detector = RMS.
7. Trace average at least 100 traces in power averaging mode
8. Compute power by integrating the spectrum across the 26 dB EBW of the signal.
9. Duty factor need added to measured value (duty cycle < 98 percent).

##### For other channels:

Method PM is used to perform output power measurement, trigger and gating function of wide band power meter is enabled to measure max output power of TX on burst. Duty factor is not added to measured value.

##### FOR 26dB OCCUPIED BANDWIDTH

1. Set RBW = approximately 1% of the emission bandwidth.
2. Set the VBW > RBW.
3. Detector = Peak.
4. Trace mode = max hold.
5. Measure the maximum width of the emission that is 26 dB down from the peak of the emission. Compare this with the RBW setting of the analyzer. Readjust RBW and repeat measurement as needed until the RBW/EBW ratio is approximately 1%.

#### 4.3.5 Deviation from Test Standard

No deviation.

#### 4.3.6 EUT Operating Condition

The software provided by client to enable the EUT under transmission condition continuously at lowest, middle and highest channel frequencies individually.

#### 4.3.7 Test Result

#### CDD Mode

#### 802.11a

#### Power Output:

Chan.	Chan. Freq. (MHz)	Maximum Conducted Power (dBm)			Total Power (mW)	Total Power (dBm)	Limit (dBm)	Pass / Fail
		Chain 0	Chain 1	Chain 2				
52	5260	17.21	15.84	16.11	131.805	21.20	24.00	Pass
60	5300	17.12	16.10	16.41	136.013	21.34	24.00	Pass
64	5320	17.11	16.14	16.42	136.372	21.35	24.00	Pass
100	5500	16.73	16.65	16.34	136.389	21.35	24.00	Pass
116	5580	16.72	16.60	16.02	132.692	21.23	24.00	Pass
140	5700	16.60	16.52	16.49	135.15	21.31	24.00	Pass
*144 (UNII-2C Band)	5720	13.79	13.17	13.29	66.012	18.20	22.82	Pass
*144 (UNII-3 Band)	5720	7.56	6.94	7.09	15.762	11.98	30.00	Pass

Note: \* Test was performed in accordance with Measurement follow FCC KDB 789033 UNII test procedure Method SA-1 and use spectrum analyzer test.

The Total Power for the straddle channel:

Chan.	Chan. Freq. (MHz)	Average Power (mW)	Average Power (dBm)
144	5720	81.774	19.13

Note: The total power was calculated through formula and record the value for reference only.

**26dB BANDWIDTH:**

Channel	Frequency (MHz)	26dBc Bandwidth (MHz)		
		Chain 0	Chain 1	Chain 2
52	5260	20.67	20.42	20.76
60	5300	20.65	20.52	20.85
64	5320	20.56	20.46	20.35
100	5500	20.64	20.27	20.87
116	5580	20.58	20.57	20.82
140	5700	20.73	20.71	20.76
144 (UNII-2C Band)	5720	15.39	15.41	15.22

**Note: For U\_NII-2A, U\_NII-2C Band output power limitation is determined based on 26dBc bandwidth**

Power Limit = 11dBm + 10logB < U_NII-2A, U_NII-2C >			
Channel Number	Freq.(MHz)	Min. B(MHz)	Determined Conducted Limit (dBm)
52	5260	20.42	24.1 > 24
60	5300	20.52	24.12 > 24
64	5320	20.35	24.08 > 24
100	5500	20.27	24.06 > 24
116	5580	20.57	24.13 > 24
140	5700	20.71	24.16 > 24
144 (UNII-2C Band)	5720	15.22	22.82 < 24



**802.11ac (VHT20)**
**POWER OUTPUT:**

Chan.	Chan. Freq. (MHz)	Maximum Conducted Power (dBm)			Total Power (mW)	Total Power (dBm)	Limit (dBm)	Pass / Fail
		Chain 0	Chain 1	Chain 2				
52	5260	17.13	15.99	16.31	134.117	21.27	24.00	Pass
60	5300	17.05	16.05	16.25	133.141	21.24	24.00	Pass
64	5320	17.07	15.98	16.52	135.436	21.32	24.00	Pass
100	5500	16.51	16.52	16.46	133.905	21.27	24.00	Pass
116	5580	16.60	16.49	16.50	134.943	21.30	24.00	Pass
140	5700	16.53	16.22	16.58	132.356	21.22	24.00	Pass
*144 (UNII-2C Band)	5720	13.38	13.21	13.26	63.902	18.06	22.84	Pass
*144 (UNII-3 Band)	5720	7.64	7.47	7.58	17.121	12.34	30.00	Pass

Note: \* Test was performed in accordance with Measurement follow FCC KDB 789033 UNII test procedure Method SA-1 and use spectrum analyzer test.

The Total Power for the straddle channel:

Chan.	Chan. Freq. (MHz)	Average Power (mW)	Average Power (dBm)
144	5720	81.023	19.09

Note: The total power was calculated through formula and record the value for reference only.

**26dB BANDWIDTH:**

Channel	Frequency (MHz)	26dBc Bandwidth (MHz)		
		Chain 0	Chain 1	Chain 2
52	5260	21.39	20.72	20.86
60	5300	23.57	20.82	20.84
64	5320	21.50	20.86	20.78
100	5500	20.81	20.82	21.76
116	5580	20.63	21.02	20.82
140	5700	20.82	25.89	20.76
144 (UNII-2C Band)	5720	15.30	16.54	15.42

**Note: For FCC output power limitation is determined based on 26dB bandwidth.**

Power Limit = 11dBm + 10logB < U_NII-2A, U_NII-2C >			
Channel Number	Freq.(MHz)	Min. B(MHz)	Determined Conducted Limit (dBm)
52	5260	20.72	24.16 > 24
60	5300	20.82	24.18 > 24
64	5320	20.78	24.17 > 24
100	5500	20.81	24.18 > 24
116	5580	20.63	24.14 > 24
140	5700	20.76	24.17 > 24
144 (UNII-2C Band)	5720	15.30	22.84 < 24

**802.11ac (VHT40)**
**POWER OUTPUT:**

Chan.	Chan. Freq. (MHz)	Maximum Conducted Power (dBm)			Total Power (mW)	Total Power (dBm)	Limit (dBm)	Pass / Fail
		Chain 0	Chain 1	Chain 2				
54	5270	19.51	18.66	18.76	237.944	23.76	24.00	Pass
62	5310	17.41	16.72	16.92	151.274	21.80	24.00	Pass
102	5510	16.93	16.71	17.21	148.8	21.73	24.00	Pass
110	5550	18.84	18.58	19.10	229.954	23.62	24.00	Pass
134	5670	18.85	18.89	19.14	236.217	23.73	24.00	Pass
*142 (UNII-2C Band)	5710	16.03	15.99	16.45	127.962	21.07	24.00	Pass
*142 (UNII-3 Band)	5710	5.73	5.88	6.26	12.223	10.87	30.00	Pass

Note: \* Test was performed in accordance with Measurement follow FCC KDB 789033 UNII test procedure Method SA-2 and use spectrum analyzer test.

The Total Power for the straddle channel:

Chan.	Chan. Freq. (MHz)	Average Power (mW)	Average Power (dBm)
142	5710	140.185	21.47

Note: The total power was calculated through formula and record the value for reference only.

**26dB BANDWIDTH:**

Channel	Frequency (MHz)	26dBc Bandwidth (MHz)		
		Chain 0	Chain 1	Chain 2
54	5270	72.96	73.05	51.52
62	5310	50.74	41.50	41.62
102	5510	41.56	46.24	41.51
110	5550	58.35	63.18	55.77
134	5670	69.17	82.84	65.85
142 (UNII-2C Band)	5710	49.66	55.95	48.21

**Note: For U\_NII-2A, U\_NII-2C Band output power limitation is determined based on 26dBc bandwidth**

Power Limit = 11dBm + 10logB < U_NII-2A, U_NII-2C >			
Channel Number	Freq.(MHz)	Min. B(MHz)	Determined Conducted Limit (dBm)
54	5270	51.52	28.11 > 24
62	5310	41.50	27.18 > 24
102	5510	41.51	27.18 > 24
110	5550	55.77	28.46 > 24
134	5670	65.85	29.18 > 24
142 (UNII-2C Band)	5710	48.21	27.83 > 24

## 802.11ac (VHT80)

### POWER OUTPUT:

Chan.	Chan. Freq. (MHz)	Maximum Conducted Power (dBm)			Total Power (mW)	Total Power (dBm)	Limit (dBm)	Pass / Fail
		Chain 0	Chain 1	Chain 2				
58	5290	15.90	15.07	15.51	106.605	20.28	24.00	Pass
106	5530	16.44	16.31	16.54	131.893	21.20	24.00	Pass
122	5610	18.94	18.99	19.62	249.215	23.97	24.00	Pass
*138 (UNII-2C Band)	5690	16.00	15.90	16.78	134.067	21.27	24.00	Pass
*138 (UNII-3 Band)	5690	2.15	2.05	3.07	5.594	7.48	30.00	Pass

Note: \* Test was performed in accordance with Measurement follow FCC KDB 789033 UNII test procedure Method SA-2 and use spectrum analyzer test.

The Total Power for the straddle channel:

Chan.	Chan. Freq. (MHz)	Average Power (mW)	Average Power (dBm)
138	5690	139.661	21.45

Note: The total power was calculated through formula and record the value for reference only.

**26dB BANDWIDTH:**

Channel	Frequency (MHz)	26dBc Bandwidth (MHz)		
		Chain 0	Chain 1	Chain 2
58	5290	83.47	82.93	83.36
106	5530	82.60	83.21	82.85
122	5610	118.03	125.15	111.14
138 (UNII-2C Band)	5690	97.01	101.49	94.32

**Note: For U\_NII-2A, U\_NII-2C Band output power limitation is determined based on 26dBc bandwidth**

Power Limit = 11dBm + 10logB < U_NII-2A, U_NII-2C >			
Channel Number	Freq.(MHz)	Min. B(MHz)	Determined Conducted Limit (dBm)
58	5290	82.93	30.18 > 24
106	5530	82.60	30.16 > 24
122	5610	111.14	31.45 > 24
138 (UNII-2C Band)	5690	94.32	30.74 > 24

### Spectrum Plot of Worst Value

**802.11a / Chain 2 - CH144 (UNII-2C Band)**

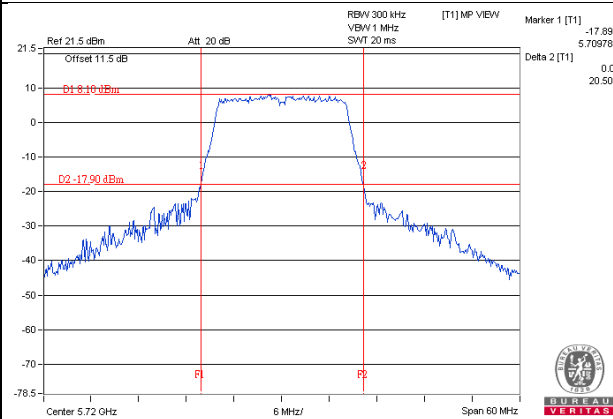

**802.11ac (VHT20) / Chain 0 - CH144 (UNII-2C Band)**

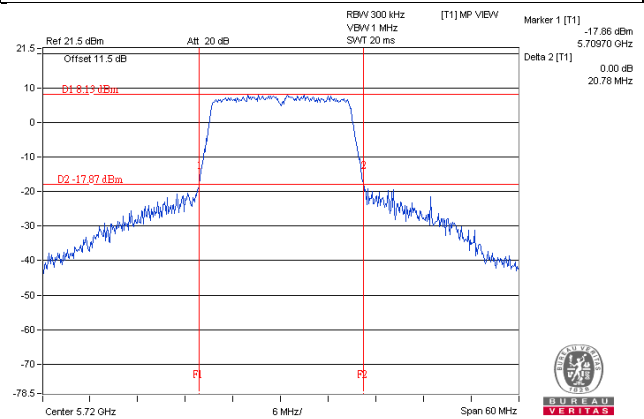

**802.11ac (VHT40) / Chain 1 - CH62**

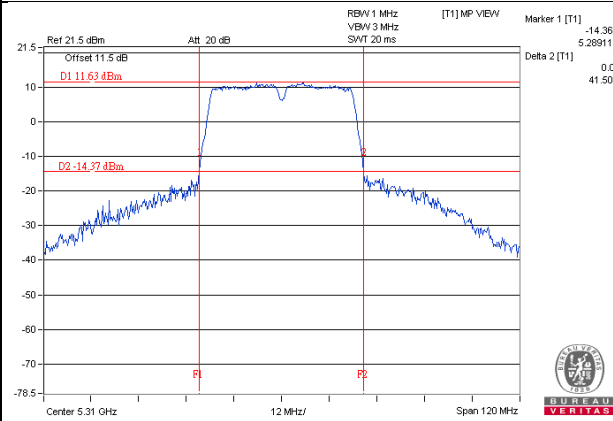

**802.11ac (VHT80) / Chain 0 - CH106**

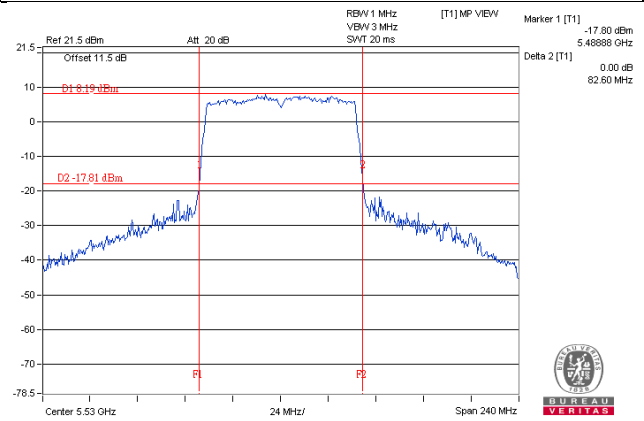

**NOTE:**

For CH144 (UNII-2C Band) = 5725MHz - Marker 1

## Beamforming Mode

### 802.11ac (VHT20)

#### POWER OUTPUT:

Chan.	Chan. Freq. (MHz)	Maximum Conducted Power (dBm)			Total Power (mW)	Total Power (dBm)	Limit (dBm)	Pass / Fail
		Chain 0	Chain 1	Chain 2				
52	5260	17.13	15.99	16.31	134.117	21.27	21.38	Pass
60	5300	17.05	16.05	16.25	133.141	21.24	21.38	Pass
64	5320	17.07	15.98	16.52	135.436	21.32	21.38	Pass
100	5500	16.51	16.52	16.46	133.905	21.27	21.38	Pass
116	5580	16.60	16.49	16.50	134.943	21.30	21.38	Pass
140	5700	16.53	16.22	16.58	132.356	21.22	21.38	Pass
*144 (UNII-2C Band)	5720	13.38	13.21	13.26	63.902	18.06	20.22	Pass
*144 (UNII-3 Band)	5720	7.64	7.47	7.58	17.121	12.34	27.38	Pass

Note: 1. \* Test was performed in accordance with Measurement follow FCC KDB 789033 UNII test procedure Method SA-1 and use spectrum analyzer test.

2. For UNII-2A & UNII-2C: Directional gain =  $10 \log[(10^{G1/20} + 10^{G2/20} + 10^{G3/20})^2 / 3] = 8.62\text{dBi} > 6\text{dBi}$ , so the power limit shall be reduced to "Determined Conducted Limit"-(8.62-6).

3. For UNII-3: Directional gain =  $10 \log[(10^{G1/20} + 10^{G2/20} + 10^{G3/20})^2 / 3] = 8.62\text{dBi} > 6\text{dBi}$ , so the power limit shall be reduced to  $30-(8.62-6) = 27.38\text{dBm}$

The Total Power for the straddle channel:

Chan.	Chan. Freq. (MHz)	Average Power (mW)	Average Power (dBm)
144	5720	81.023	19.09

Note: The total power was calculated through formula and record the value for reference only.



**26dB BANDWIDTH:**

Channel	Frequency (MHz)	26dBc Bandwidth (MHz)		
		Chain 0	Chain 1	Chain 2
52	5260	21.39	20.72	20.86
60	5300	23.57	20.82	20.84
64	5320	21.50	20.86	20.78
100	5500	20.81	20.82	21.76
116	5580	20.63	21.02	20.82
140	5700	20.82	25.89	20.76
144 (UNII-2C Band)	5720	15.30	16.54	15.42

**Note: For FCC output power limitation is determined based on 26dB bandwidth.**

Power Limit = 11dBm + 10logB < U_NII-2A, U_NII-2C >			
Channel Number	Freq.(MHz)	Min. B(MHz)	Determined Conducted Limit (dBm)
52	5260	20.72	24.16 > 24
60	5300	20.82	24.18 > 24
64	5320	20.78	24.17 > 24
100	5500	20.81	24.18 > 24
116	5580	20.63	24.14 > 24
140	5700	20.76	24.17 > 24
144 (UNII-2C Band)	5720	15.30	22.84 < 24

## 802.11ac (VHT40)

### POWER OUTPUT:

Chan.	Chan. Freq. (MHz)	Maximum Conducted Power (dBm)			Total Power (mW)	Total Power (dBm)	Limit (dBm)	Pass / Fail
		Chain 0	Chain 1	Chain 2				
54	5270	16.99	16.15	16.36	134.464	21.29	21.38	Pass
62	5310	16.91	16.22	16.42	134.823	21.30	21.38	Pass
102	5510	16.43	16.21	16.71	132.618	21.23	21.38	Pass
110	5550	16.41	16.04	16.68	130.49	21.16	21.38	Pass
134	5670	16.44	16.33	16.66	133.354	21.25	21.38	Pass
*142 (UNII-2C Band)	5710	13.03	10.41	10.83	44.58	16.49	21.38	Pass
*142 (UNII-3 Band)	5710	2.67	0.17	0.74	4.206	6.24	27.38	Pass

Note: 1. \* Test was performed in accordance with Measurement follow FCC KDB 789033 UNII test procedure Method SA-2 and use spectrum analyzer test.

2. For UNII-2A & UNII-2C: Directional gain =  $10 \log[(10^{G1/20} + 10^{G2/20} + 10^{G3/20})^2 / 3] = 8.62\text{dBi} > 6\text{dBi}$ , so the power limit shall be reduced to "Determined Conducted Limit"-(8.62-6).

3. For UNII-3: Directional gain =  $10 \log[(10^{G1/20} + 10^{G2/20} + 10^{G3/20})^2 / 3] = 8.62\text{dBi} > 6\text{dBi}$ , so the power limit shall be reduced to  $30-(8.62-6) = 27.38\text{dBm}$

The Total Power for the straddle channel:

Chan.	Chan. Freq. (MHz)	Average Power (mW)	Average Power (dBm)
142	5710	48.786	16.88

Note: The total power was calculated through formula and record the value for reference only.

**26dB BANDWIDTH:**

Channel	Frequency (MHz)	26dBc Bandwidth (MHz)		
		Chain 0	Chain 1	Chain 2
54	5270	72.96	73.05	51.52
62	5310	50.74	41.50	41.62
102	5510	41.56	46.24	41.51
110	5550	58.35	63.18	55.77
134	5670	69.17	82.84	65.85
142 (UNII-2C Band)	5710	49.66	55.95	48.21

**Note: For U\_NII-2A, U\_NII-2C Band output power limitation is determined based on 26dBc bandwidth**

Power Limit = 11dBm + 10logB < U_NII-2A, U_NII-2C >			
Channel Number	Freq.(MHz)	Min. B(MHz)	Determined Conducted Limit (dBm)
54	5270	51.52	28.11 > 24
62	5310	41.50	27.18 > 24
102	5510	41.51	27.18 > 24
110	5550	55.77	28.46 > 24
134	5670	65.85	29.18 > 24
142 (UNII-2C Band)	5710	48.21	27.83 > 24

**802.11ac (VHT80)**
**POWER OUTPUT:**

Chan.	Chan. Freq. (MHz)	Maximum Conducted Power (dBm)			Total Power (mW)	Total Power (dBm)	Limit (dBm)	Pass / Fail
		Chain 0	Chain 1	Chain 2				
58	5290	15.90	15.07	15.51	106.605	20.28	21.38	Pass
106	5530	16.44	16.31	16.54	131.893	21.20	21.38	Pass
122	5610	16.34	16.36	17.04	136.886	21.36	21.38	Pass
*138 (UNII-2C Band)	5690	12.55	12.55	13.52	62.036	17.93	21.38	Pass
*138 (UNII-3 Band)	5690	-1.46	-1.46	-0.44	2.4749	3.94	27.38	Pass

Note: 1. \* Test was performed in accordance with Measurement follow FCC KDB 789033 UNII test procedure Method SA-2 and use spectrum analyzer test.

2. For UNII-2A & UNII-2C: Directional gain =  $10 \log[(10^{G1/20} + 10^{G2/20} + 10^{G3/20})^2 / 3] = 8.62\text{dBi} > 6\text{dBi}$  , so the power limit shall be reduced to "Determined Conducted Limit"-(8.62-6).

3. For UNII-3: Directional gain =  $10 \log[(10^{G1/20} + 10^{G2/20} + 10^{G3/20})^2 / 3] = 8.62\text{dBi} > 6\text{dBi}$  , so the power limit shall be reduced to  $30-(8.62-6) = 27.38\text{dBm}$

The Total Power for the straddle channel:

Chan.	Chan. Freq. (MHz)	Average Power (mW)	Average Power (dBm)
138	5690	64.5109	18.1

Note: The total power was calculated through formula and record the value for reference only.

**26dB BANDWIDTH:**

Channel	Frequency (MHz)	26dBc Bandwidth (MHz)		
		Chain 0	Chain 1	Chain 2
58	5290	83.47	82.93	83.36
106	5530	82.60	83.21	82.85
122	5610	118.03	125.15	111.14
138 (UNII-2C Band)	5690	97.01	101.49	94.32

**Note: For U\_NII-2A, U\_NII-2C Band output power limitation is determined based on 26dBc bandwidth**

Power Limit = 11dBm + 10logB < U_NII-2A, U_NII-2C >			
Channel Number	Freq.(MHz)	Min. B(MHz)	Determined Conducted Limit (dBm)
58	5290	82.93	30.18 > 24
106	5530	82.60	30.16 > 24
122	5610	111.14	31.45 > 24
138 (UNII-2C Band)	5690	94.32	30.74 > 24

Spectrum Plot of Worst Value

802.11ac (VHT20) / Chain 0 - CH144 (UNII-2C Band)

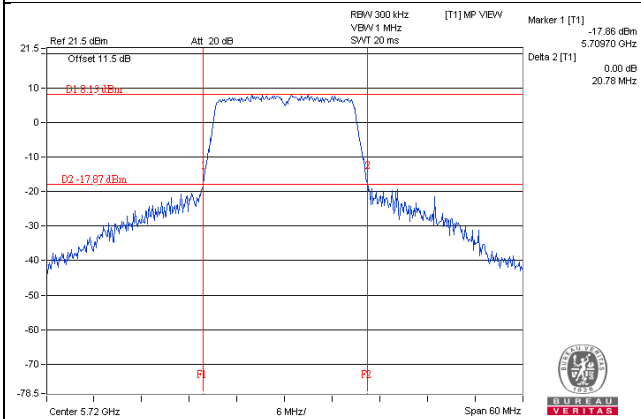

802.11ac (VHT40) / Chain 1 - CH62

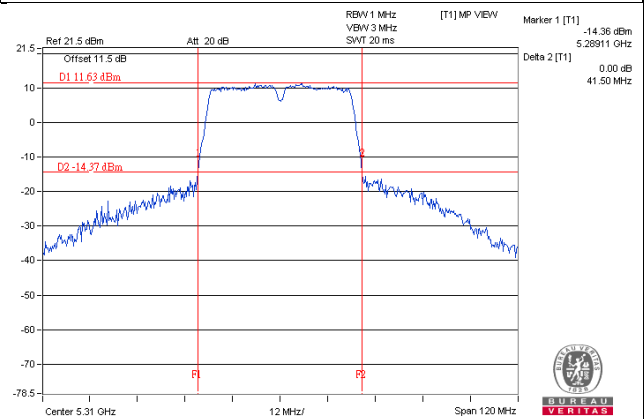

802.11ac (VHT80) / Chain 0 - CH106

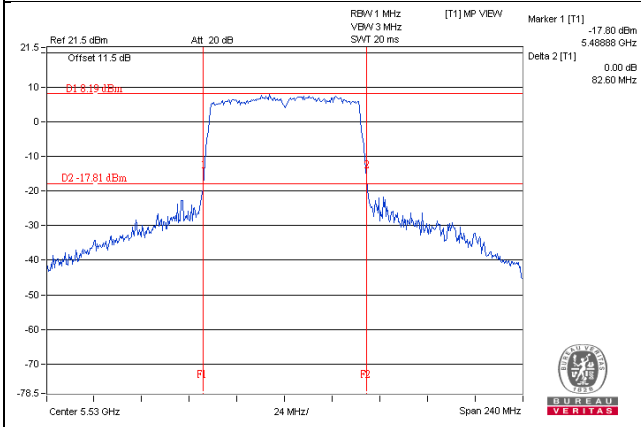

**NOTE:**

For CH144 (UNII-2C Band) = 5725MHz - Marker 1

## 4.4 Occupied Bandwidth Measurement

### 4.4.1 Test Setup

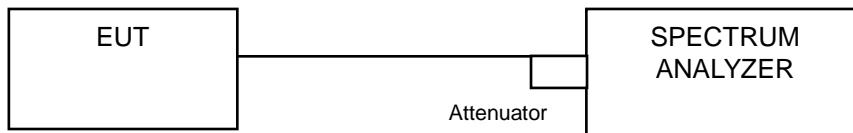

### 4.4.2 Test Instruments

Refer to section 4.1.2 to get information of above instrument.

### 4.4.3 Test Procedure

The transmitter output was connected to the spectrum analyzer through an attenuator. The bandwidth of the fundamental frequency was measured by spectrum analyzer with resolution bandwidth in the range of 1% to 5% of the anticipated emission bandwidth, and a video bandwidth at least 3x the resolution bandwidth and set the detector to SAMPLE. The width of a frequency band such that, below the lower and above the upper frequency limits, the mean powers emitted are each equal to a specified percentage 0.5 %of the total mean power of a given emission.

#### 4.4.4 Test Results

##### 802.11a

Channel	Channel Frequency (MHz)	Occupied Bandwidth (MHz)		
		Chain 0	Chain 1	Chain 2
52	5260	16.80	16.68	17.88
60	5300	16.92	16.80	17.88
64	5320	16.80	16.68	17.88
100	5500	16.80	16.80	17.88
116	5580	16.92	16.92	17.88
140	5700	16.80	16.80	17.76
144 (UNII-2C Band)	5720	13.52	13.52	13.40
144 (UNII-3 Band)	5720	3.40	3.28	3.40

##### 802.11ac (VHT20)

Channel	Channel Frequency (MHz)	Occupied Bandwidth (MHz)		
		Chain 0	Chain 1	Chain 2
52	5260	17.88	17.88	17.88
60	5300	18.00	17.76	17.76
64	5320	18.00	17.88	17.88
100	5500	18.00	18.00	17.88
116	5580	17.88	17.88	17.88
140	5700	17.88	17.88	17.88
144 (UNII-2C Band)	5720	14.00	14.00	14.00
144 (UNII-3 Band)	5720	3.88	3.88	3.88

##### 802.11ac (VHT40)

Channel	Channel Frequency (MHz)	Occupied Bandwidth (MHz)		
		Chain 0	Chain 1	Chain 2
54	5270	37.20	36.72	36.96
62	5310	36.72	36.72	36.72
102	5510	36.72	36.72	36.48
110	5550	36.72	36.72	36.72
134	5670	36.72	36.72	36.72
142 (UNII-2C Band)	5710	33.60	33.60	33.40
142 (UNII-3 Band)	5710	3.40	3.60	3.40



**802.11ac (VHT80)**

Channel	Channel Frequency (MHz)	Occupied Bandwidth (MHz)		
		Chain 0	Chain 1	Chain 2
58	5290	75.84	75.84	76.32
106	5530	75.84	75.84	75.84
122	5610	76.32	76.32	76.32
138 (UNII-2C Band)	5690	73.40	73.40	73.40
138 (UNII-3 Band)	5690	2.92	2.92	2.92

### Spectrum Plot of Worst Value

**802.11a\_Chain2 / CH52**

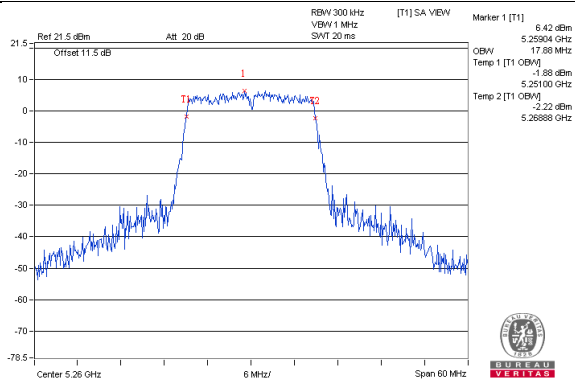

**802.11ac (VHT20)\_Chain0 / CH60**

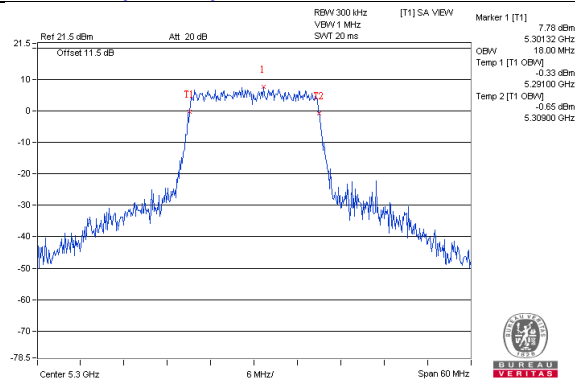

**802.11ac (VHT40)\_Chain0 / CH54**

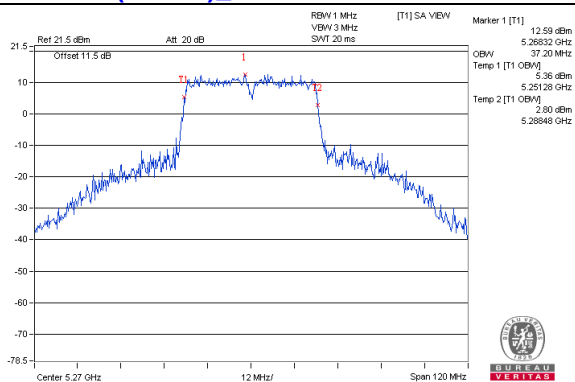

**802.11ac (VHT80)\_Chain2 / CH58**

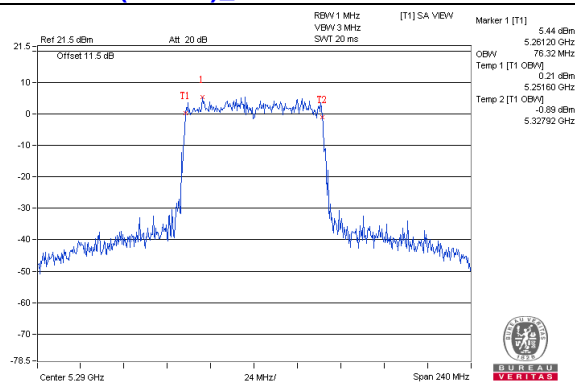

## 4.5 Peak Power Spectral Density Measurement

### 4.5.1 Limits of Peak Power Spectral Density Measurement

Operation Band	EUT Category		Limit
U-NII-1		Outdoor Access Point	17dBm/ MHz
		Fixed point-to-point Access Point	
		Indoor Access Point	
		Mobile and Portable client device	11dBm/ MHz
U-NII-2A	√		11dBm/ MHz
U-NII-2C	√		11dBm/ MHz
U-NII-3	√		30dBm/ 500kHz

### 4.5.2 Test Setup



### 4.5.3 Test Instruments

Refer to section 4.1.2 to get information of above instrument.

#### 4.5.4 Test Procedure

##### For U\_NII-2A, U\_NII-2C band:

##### **802.11ac (VHT40), 802.11ac (VHT80)**

Using method SA-2

1. Set span to encompass the entire emission bandwidth (EBW) of the signal.
2. Set RBW = 1 MHz, Set VBW  $\geq$  3 MHz, Detector = RMS
3. Sweep time = auto, trigger set to "free run".
4. Trace average at least 100 traces in power averaging mode.
5. Record the max value and add 10 log (1/duty cycle)

##### **802.11a, 802.11ac (VHT20)**

Using method SA-1

1. Set span to encompass the entire emission bandwidth (EBW) of the signal.
2. Set RBW = 1 MHz, Set VBW  $\geq$  3 MHz, Detector = RMS
3. Sweep time = auto, trigger set to "free run".
4. Trace average at least 100 traces in power averaging mode.
5. Record the max value

##### For U\_NII-3:

##### **802.11ac (VHT40), 802.11ac (VHT80)**

1. Set span to encompass the entire emission bandwidth (EBW) of the signal.
2. Set RBW = 300 kHz, Set VBW  $\geq$  1 MHz, Detector = RMS
3. Use the peak marker function to determine the maximum power level in any 300 kHz band segment within the fundamental EBW.
4. Scale the observed power level to an equivalent value in 500 kHz by adjusting (reducing) the measured power by a bandwidth correction factor (BWCF) where  $BWCF = 10\log(500 \text{ kHz}/300\text{kHz})$
5. Sweep time = auto, trigger set to "free run".
6. Trace average at least 100 traces in power averaging mode.
7. Record the max value and add 10 log (1/duty cycle)

##### **802.11a, 802.11ac (VHT20)**

1. Set span to encompass the entire emission bandwidth (EBW) of the signal.
2. Set RBW = 300 kHz, Set VBW  $\geq$  1 MHz, Detector = RMS
3. Use the peak marker function to determine the maximum power level in any 300 kHz band segment within the fundamental EBW.
4. Scale the observed power level to an equivalent value in 500 kHz by adjusting (reducing) the measured power by a bandwidth correction factor (BWCF) where  $BWCF = 10\log(500 \text{ kHz}/300\text{kHz})$
5. Sweep time = auto, trigger set to "free run".
6. Trace average at least 100 traces in power averaging mode.
7. Record the max value

#### 4.5.5 Deviation from Test Standard

No deviation.

#### 4.5.6 EUT Operating Condition

Same as Item 4.3.6.

#### 4.5.7 Test Results

#### For UNII-2A, UNII-2C:

#### 802.11a

Chan.	Chan. Freq. (MHz)	PSD (dBm/MHz)			Total Power Density (dBm/MHz)	MAX. Limit (dBm/MHz)	Pass / Fail
		Chain 0	Chain 1	Chain 2			
52	5260	4.29	3.44	2.90	8.35	8.38	Pass
60	5300	4.16	3.15	2.93	8.22	8.38	Pass
64	5320	4.33	3.34	2.89	8.33	8.38	Pass
100	5500	3.51	3.35	2.87	8.02	8.38	Pass
116	5580	3.04	3.32	2.88	7.86	8.38	Pass
140	5700	3.09	2.96	2.93	7.77	8.38	Pass
144 (UNII-2C Band)	5720	2.75	3.31	3.43	7.94	8.38	Pass

- Note:** 1. Method a) of power density measurement of KDB 662911 is using for calculating total power density. Total power density is summing entire spectra across corresponding frequency bins on the various outputs by computer.
2. Directional gain =  $10 \log[(10^{G1/20} + 10^{G2/20} + 10^{G3/20})^2 / 3]$  = 8.62dBi > 6dBi , so the power density limit shall be reduced to 11-(8.62-6) = 8.38dBm.

#### 802.11ac (VHT20)

Chan.	Chan. Freq. (MHz)	PSD (dBm/MHz)			Total Power Density (dBm/MHz)	MAX. Limit (dBm/MHz)	Pass / Fail
		Chain 0	Chain 1	Chain 2			
52	5260	3.83	3.17	2.82	8.06	8.38	Pass
60	5300	3.71	2.87	2.93	7.96	8.38	Pass
64	5320	3.84	2.92	3.20	8.11	8.38	Pass
100	5500	3.56	3.58	3.09	8.19	8.38	Pass
116	5580	3.74	3.77	3.10	8.32	8.38	Pass
140	5700	3.13	3.59	3.03	8.03	8.38	Pass
144 (UNII-2C Band)	5720	3.38	3.20	3.13	8.01	8.38	Pass

- Note:** 1. Method a) of power density measurement of KDB 662911 is using for calculating total power density. Total power density is summing entire spectra across corresponding frequency bins on the various outputs by computer.
2. Directional gain =  $10 \log[(10^{G1/20} + 10^{G2/20} + 10^{G3/20})^2 / 3]$  = 8.62dBi > 6dBi , so the power density limit shall be reduced to 11-(8.62-6) = 8.38dBm.

### 802.11ac (VHT40)

Chan.	Chan. Freq. (MHz)	PSD W/O Duty Factor (dBm/MHz)			Duty Factor (dB)	Total PSD With Duty Factor (dBm/MHz)	MAX. Limit (dBm/MHz)	Pass / Fail
		Chain 0	Chain 1	Chain 2				
54	5270	3.10	2.24	1.94	0.14	7.36	8.38	Pass
62	5310	1.09	0.23	0.48	0.14	5.52	8.38	Pass
102	5510	0.51	0.24	0.97	0.14	5.49	8.38	Pass
110	5550	2.47	2.38	2.95	0.14	7.52	8.38	Pass
134	5670	2.33	2.14	2.76	0.14	7.33	8.38	Pass
142 (UNII-2C Band)	5710	2.45	2.37	2.80	0.14	7.45	8.38	Pass

- Note:**
- Method a) of power density measurement of KDB 662911 is using for calculating total power density. Total power density is summing entire spectra across corresponding frequency bins on the various outputs by computer.
  - Directional gain =  $10 \log[(10^{G1/20} + 10^{G2/20} + 10^{G3/20})^2 / 3] = 8.62\text{dBi} > 6\text{dBi}$ , so the power density limit shall be reduced to  $11 - (8.62 - 6) = 8.38\text{dBm}$ .
  - Refer to section 3.3 for duty cycle spectrum plot.

### 802.11ac (VHT80)

Chan.	Chan. Freq. (MHz)	PSD W/O Duty Factor (dBm/MHz)			Duty Factor (dB)	Total PSD With Duty Factor (dBm/MHz)	MAX. Limit (dBm/MHz)	Pass / Fail
		Chain 0	Chain 1	Chain 2				
58	5290	-3.60	-4.58	-4.38	0.26	0.86	8.38	Pass
106	5530	-3.46	-3.39	-3.18	0.26	1.69	8.38	Pass
122	5610	-1.04	-0.68	-0.03	0.26	4.47	8.38	Pass
138 (UNII-2C Band)	5690	-0.94	-0.99	-0.20	0.26	4.33	8.38	Pass

- Note:**
- Method a) of power density measurement of KDB 662911 is using for calculating total power density. Total power density is summing entire spectra across corresponding frequency bins on the various outputs by computer.
  - Directional gain =  $10 \log[(10^{G1/20} + 10^{G2/20} + 10^{G3/20})^2 / 3] = 8.62\text{dBi} > 6\text{dBi}$ , so the power density limit shall be reduced to  $11 - (8.62 - 6) = 8.38\text{dBm}$ .
  - Refer to section 3.3 for duty cycle spectrum plot.

For UNII-2A, UNII-2C

Spectrum Plot of Worst Value

802.11a\_Chain 0 / CH64

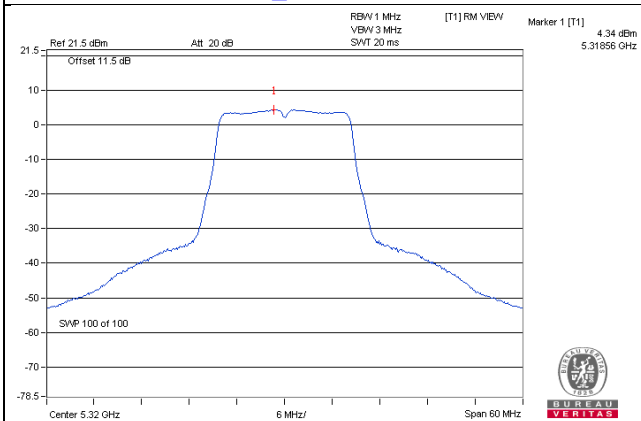

802.11ac (VHT20)\_Chain 0 / CH64

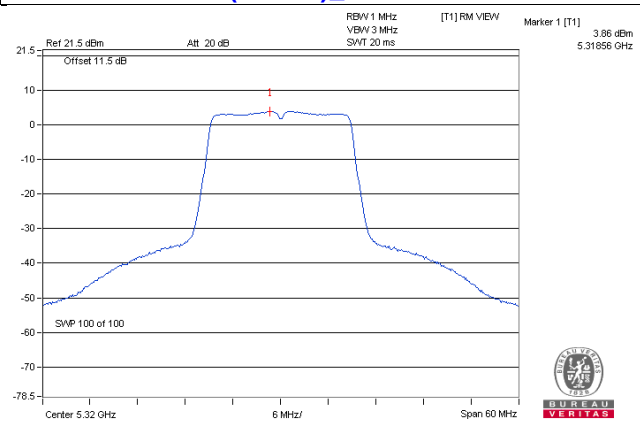

802.11ac (VHT40)\_Chain 0 / CH54

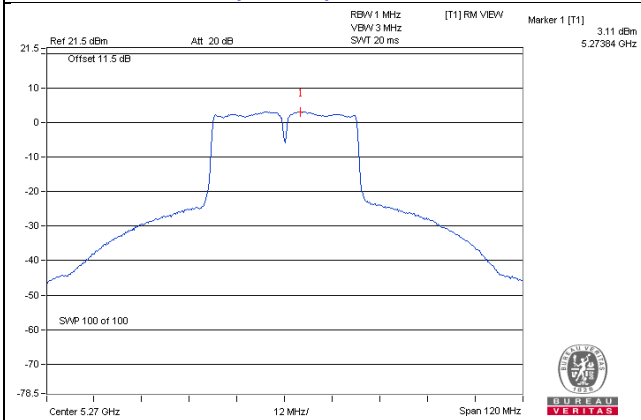

802.11ac (VHT80)\_Chain 2 / CH122

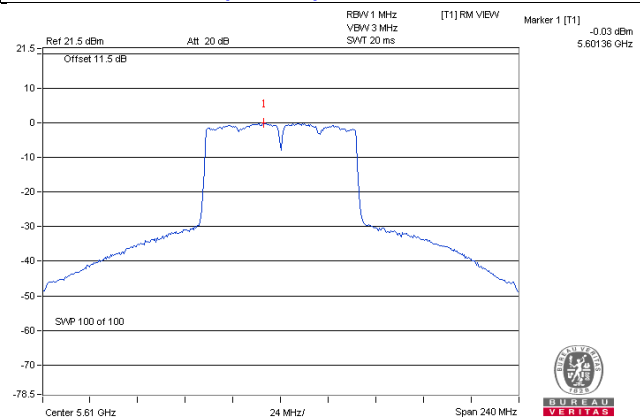

**For U\_NII-3**  
**802.11a**

TX chain	Chan.	Chan. Freq. (MHz)	PSD		10 log (N=3) dB	Total PSD (dBm/500kHz)	Limit (dBm/500kHz)	Pass /Fail
			(dBm/300kHz)	(dBm/500kHz)				
0	144 (UNII-3 Band)	5720	-5.56	-3.34	4.77	1.43	27.38	Pass
1	144 (UNII-3 Band)	5720	-5.57	-3.35	4.77	1.42	27.38	Pass
2	144 (UNII-3 Band)	5720	-5.60	-3.38	4.77	1.39	27.38	Pass

**Note:** 1. Directional gain =  $10 \log[(10^{G1/20} + 10^{G2/20} + 10^{G3/20})^2 / 3] = 8.62\text{dBi} > 6\text{dBi}$  , so the power density limit shall be reduced to  $30 - (8.62 - 6) = 27.38\text{dBm}$ .

**802.11ac (VHT20)**

TX chain	Chan.	Chan. Freq. (MHz)	PSD		10 log (N=3) dB	Total PSD (dBm/500kHz)	Limit (dBm/500kHz)	Pass /Fail
			(dBm/300kHz)	(dBm/500kHz)				
0	144 (UNII-3 Band)	5720	-5.53	-3.31	4.77	1.46	27.38	Pass
1	144 (UNII-3 Band)	5720	-5.68	-3.46	4.77	1.31	27.38	Pass
2	144 (UNII-3 Band)	5720	-5.58	-3.36	4.77	1.41	27.38	Pass

**Note:** 1. Directional gain =  $10 \log[(10^{G1/20} + 10^{G2/20} + 10^{G3/20})^2 / 3] = 8.62\text{dBi} > 6\text{dBi}$  , so the power density limit shall be reduced to  $30 - (8.62 - 6) = 27.38\text{dBm}$ .



### 802.11ac (VHT40)

TX chain	Chan.	Chan. Freq. (MHz)	PSD W/O Duty Factor		10 log (N=3) dB	Duty Factor (dB)	Total PSD With Duty Factor (dBm/500kHz)	Limit (dBm/500kHz)	Pass /Fail
			(dBm/300kHz)	(dBm/500kHz)					
0	142 (UNII-3 Band)	5710	-6.83	-4.61	4.77	0.14	0.30	27.38	Pass
1	142 (UNII-3 Band)	5710	-6.72	-4.50	4.77	0.14	0.41	27.38	Pass
2	142 (UNII-3 Band)	5710	-6.23	-4.01	4.77	0.14	0.90	27.38	Pass

- Note:** 1. Directional gain =  $10 \log[(10^{G1/20} + 10^{G2/20} + 10^{G3/20})^2 / 3] = 8.62\text{dBi} > 6\text{dBi}$  , so the power density limit shall be reduced to  $30-(8.62-6) = 27.38\text{dBm}$ .
2. Refer to section 3.3 for duty cycle spectrum plot.

### 802.11ac (VHT80)

TX chain	Chan.	Chan. Freq. (MHz)	PSD W/O Duty Factor		10 log (N=3) dB	Duty Factor (dB)	Total PSD With Duty Factor (dBm/500kHz)	Limit (dBm/500kHz)	Pass /Fail
			(dBm/300kHz)	(dBm/500kHz)					
0	138 (UNII-3 Band)	5690	-10.89	-8.67	4.77	0.26	-3.64	27.38	Pass
1	138 (UNII-3 Band)	5690	-10.80	-8.58	4.77	0.26	-3.55	27.38	Pass
2	138 (UNII-3 Band)	5690	-10.05	-7.83	4.77	0.26	-2.80	27.38	Pass

- Note:** 1. Directional gain =  $10 \log[(10^{G1/20} + 10^{G2/20} + 10^{G3/20})^2 / 3] = 8.62\text{dBi} > 6\text{dBi}$  , so the power density limit shall be reduced to  $30-(8.62-6) = 27.38\text{dBm}$ .
2. Refer to section 3.3 for duty cycle spectrum plot.

For UNII-3:

Spectrum Plot of Worst Value

802.11a / Chain 0 – CH144(UNII-3 Band)

802.11ac (VHT20) / Chain 0 – CH144 (UNII-3 Band)

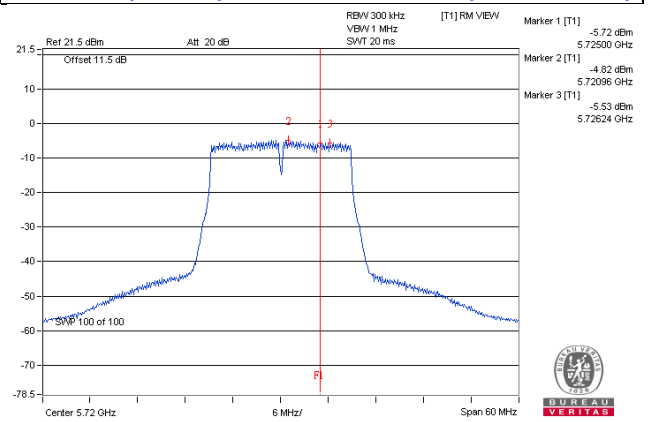
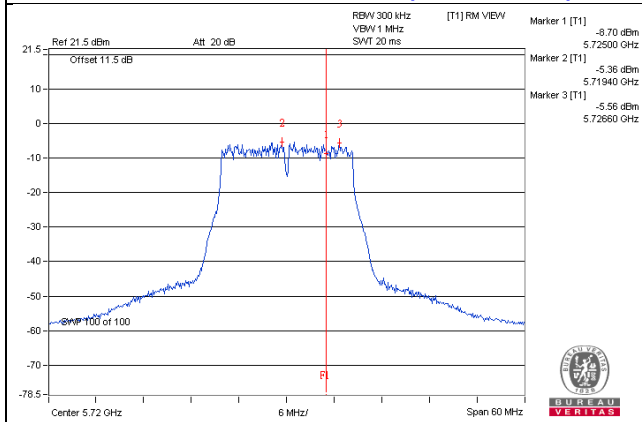

802.11ac (VHT40) / Chain 2– CH142(UNII-3 Band)

802.11ac (VHT80) / Chain 2 – CH138(UNII-3 Band)

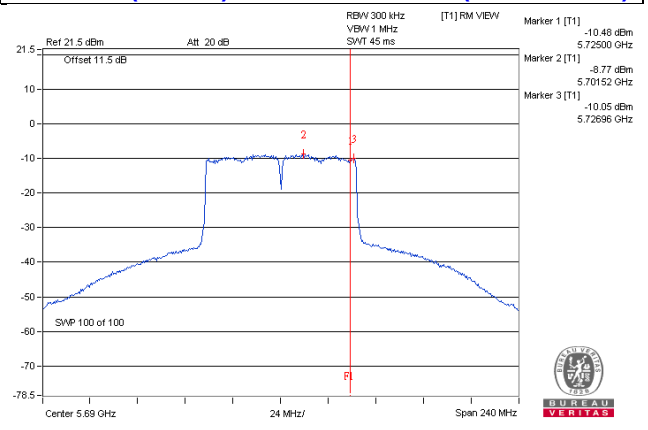
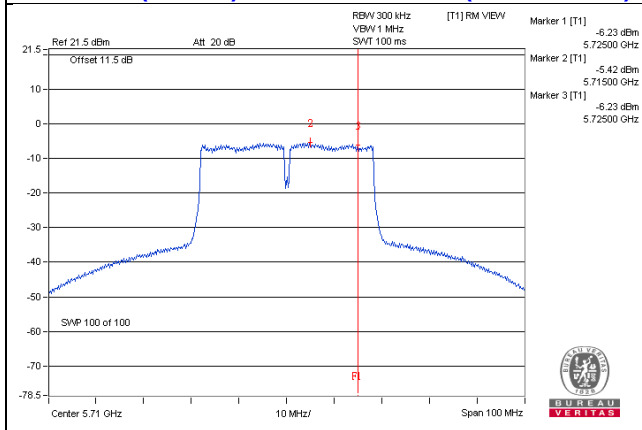

## 4.6 Frequency Stability Measurement

### 4.6.1 Limits of Frequency Stability Measurement

The frequency of the carrier signal shall be maintained within band of operation

### 4.6.2 Test Setup

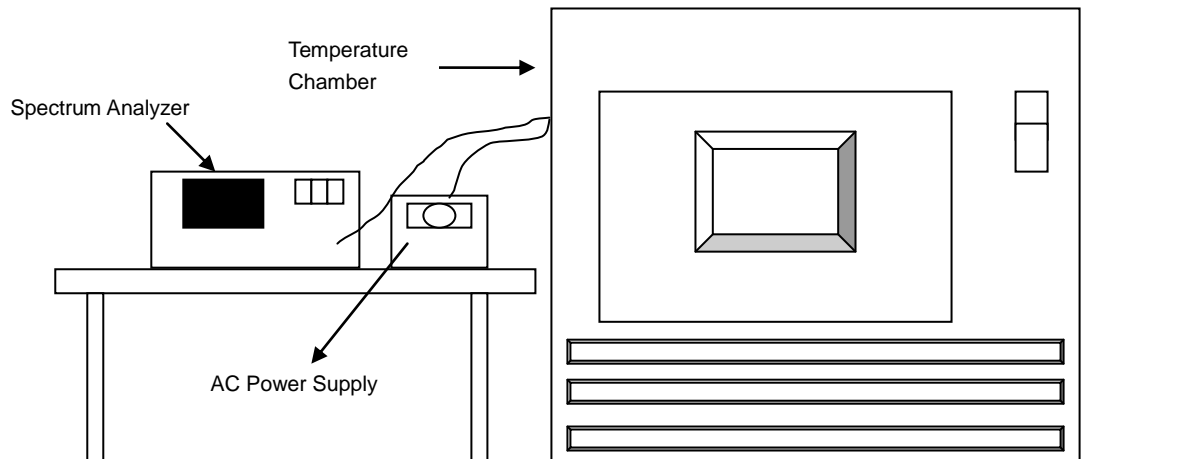

### 4.6.3 Test Instruments

Refer to section 4.1.2 to get information of above instrument.

### 4.6.4 Test Procedure

- The EUT was placed inside the environmental test chamber and powered by nominal AC voltage.
- Turn the EUT on and couple its output to a spectrum analyzer.
- Turn the EUT off and set the chamber to the highest temperature specified.
- Allow sufficient time (approximately 30 min) for the temperature of the chamber to stabilize, turn the EUT on and measure the operating frequency after 2, 5, and 10 Minutes.
- Repeat step 2 and 3 with the temperature chamber set to the lowest temperature.
- The test chamber was allowed to stabilize at +20 degree C for a minimum of 30 Minutes. The supply voltage was then adjusted on the EUT from 85% to 115% and the frequency record.

### 4.6.5 Deviation from Test Standard

No deviation.

### 4.6.6 EUT Operating Condition

Set the EUT transmit at un-modulation mode to test frequency stability.

## 4.6.7 Test Results

Frequency Stability Versus Temp.									
Operating Frequency: 5260 MHz									
TEMP. (°C)	Power Supply (Vac)	0 Minute		2 Minutes		5 Minutes		10 Minutes	
		Measured Frequency (MHz)	Pass/Fail	Measured Frequency (MHz)	Pass/Fail	Measured Frequency (MHz)	Pass/Fail	Measured Frequency (MHz)	Pass/Fail
50	120	5260.0128	PASS	5260.0158	PASS	5260.0148	PASS	5260.0132	PASS
40	120	5260.0196	PASS	5260.0207	PASS	5260.0185	PASS	5260.0211	PASS
30	120	5260.0002	PASS	5260.0015	PASS	5260.0001	PASS	5259.9981	PASS
20	120	5259.9909	PASS	5259.9891	PASS	5259.9884	PASS	5259.9894	PASS
10	120	5260.0246	PASS	5260.0219	PASS	5260.0253	PASS	5260.0226	PASS
0	120	5259.9924	PASS	5259.9941	PASS	5259.9924	PASS	5259.9923	PASS
-10	120	5259.986	PASS	5259.9884	PASS	5259.9857	PASS	5259.9861	PASS
-20	120	5260.0219	PASS	5260.0206	PASS	5260.0223	PASS	5260.0211	PASS
-30	120	5259.9986	PASS	5260.0023	PASS	5260.0021	PASS	5260.0003	PASS

Frequency Stability Versus Voltage									
Operating Frequency: 5260 MHz									
TEMP. (°C)	Power Supply (Vac)	0 Minute		2 Minutes		5 Minutes		10 Minutes	
		Measured Frequency (MHz)	Pass/Fail	Measured Frequency (MHz)	Pass/Fail	Measured Frequency (MHz)	Pass/Fail	Measured Frequency (MHz)	Pass/Fail
20	138	5259.9918	PASS	5259.9896	PASS	5259.9881	PASS	5259.9888	PASS
	120	5259.9909	PASS	5259.9891	PASS	5259.9884	PASS	5259.9894	PASS
	102	5259.9913	PASS	5259.9884	PASS	5259.9888	PASS	5259.99	PASS

## 4.7 6dB Bandwidth Measurement

### 4.7.1 Limits of 6dB Bandwidth Measurement

The minimum of 6dB Bandwidth Measurement is 0.5MHz.

### 4.7.2 Test Setup

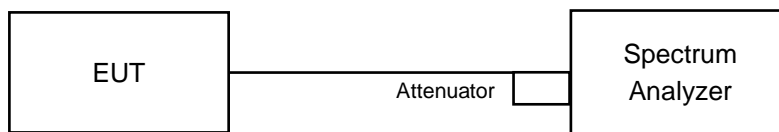

### 4.7.3 Test Instruments

Refer to section 4.1.2 to get information of above instrument.

### 4.7.4 Test Procedure

#### MEASUREMENT PROCEDURE REF

- Set resolution bandwidth (RBW) = 100kHz
- Set the video bandwidth (VBW)  $\geq 3 \times$  RBW, Detector = Peak.
- Trace mode = max hold.
- Sweep = auto couple.
- Measure the maximum width of the emission that is constrained by the frequencies associated with the two amplitude points (upper and lower) that are attenuated by 6 dB relative to the maximum level measured in the fundamental emission

### 4.7.5 Deviation from Test Standard

No deviation.

### 4.7.6 EUT Operating Condition

The software provided by client to enable the EUT under transmission condition continuously at lowest, middle and highest channel frequencies individually.

#### 4.7.7 Test Results

##### 802.11a

Channel	Frequency (MHz)	6dB Bandwidth (MHz)			Minimum Limit (MHz)	Pass / Fail
		Chain 0	Chain 1	Chain 2		
144 (UNII-3 Band)	5720	3.18	3.18	3.19	0.5	Pass

##### 802.11ac (VHT20)

Channel	Frequency (MHz)	6dB Bandwidth (MHz)			Minimum Limit (MHz)	Pass / Fail
		Chain 0	Chain 1	Chain 2		
144 (UNII-3 Band)	5720	3.81	3.80	3.80	0.5	Pass

##### 802.11ac (VHT40)

Channel	Frequency (MHz)	6dB Bandwidth (MHz)			Minimum Limit (MHz)	Pass / Fail
		Chain 0	Chain 1	Chain 2		
142 (UNII-3 Band)	5710	3.20	3.20	3.21	0.5	Pass

##### 802.11ac (VHT80)

Channel	Frequency (MHz)	6dB Bandwidth (MHz)			Minimum Limit (MHz)	Pass / Fail
		Chain 0	Chain 1	Chain 2		
138 (UNII-3 Band)	5690	2.90	2.87	2.78	0.5	Pass

Spectrum Plot of Worst Value

802.11a\_Chain 0 / CH144 (UNII-3 Band)

802.11ac (VHT20)\_Chain 1 / CH144 (UNII-3 Band)

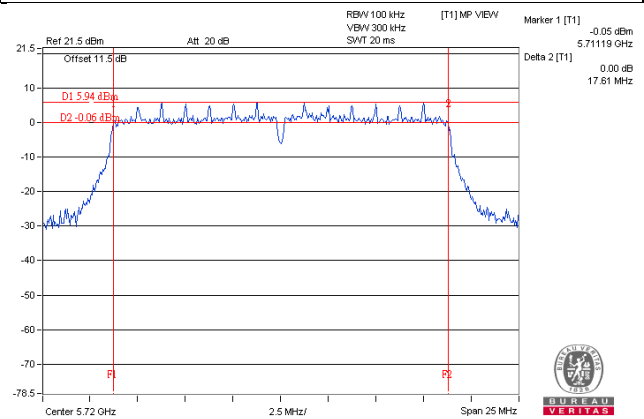
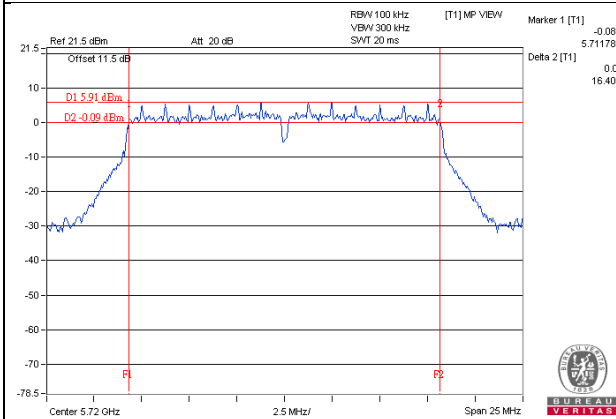

802.11ac (VHT40)\_Chain 0 / CH142 (UNII-3 Band)

802.11ac (VHT80)\_Chain 2 / CH138 (UNII-3 Band)

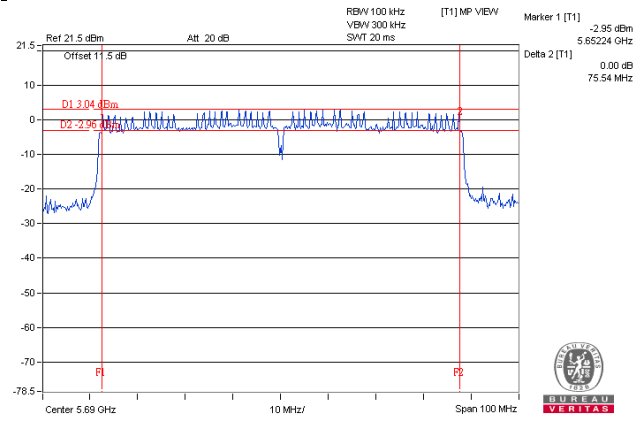
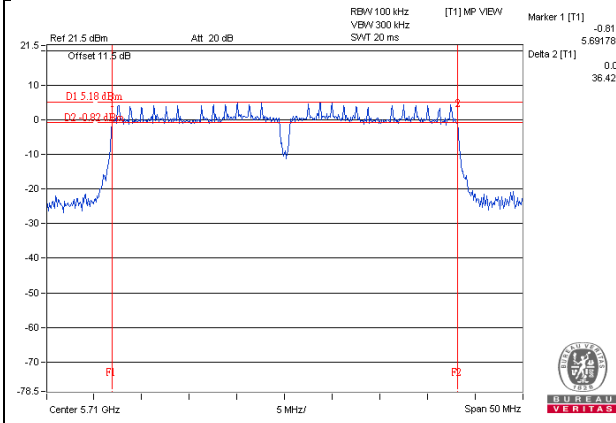

Note: The 6dB bandwidth above 5725MHz = Marker 1 + Delta 2 - 5725MHz

## 5 Pictures of Test Arrangements

Please refer to the attached file (Test Setup Photo).



## Appendix – Information on the Testing Laboratories

We, Bureau Veritas Consumer Products Services (H.K.) Ltd., Taoyuan Branch, were founded in 1988 to provide our best service in EMC, Radio, Telecom and Safety consultation. Our laboratories are accredited and approved according to ISO/IEC 17025.

If you have any comments, please feel free to contact us at the following:

**Linko EMC/RF Lab**

Tel: 886-2-26052180

Fax: 886-2-26051924

**Hsin Chu EMC/RF/Telecom Lab**

Tel: 886-3-6668565

Fax: 886-3-6668323

**Hwa Ya EMC/RF/Safety Lab**

Tel: 886-3-3183232

Fax: 886-3-3270892

**Email:** [service.adt@tw.bureauveritas.com](mailto:service.adt@tw.bureauveritas.com)

**Web Site:** [www.bureauveritas-adt.com](http://www.bureauveritas-adt.com)

The address and road map of all our labs can be found in our web site also.

--- END ---