

FCC Test Report

Report No.: RF160614E05F-1

FCC ID: VW3FAST3686

Test Model: F@ST 3686 V2.2

Received Date: Oct. 20, 2017

Test Date: Oct. 28 to Nov. 21, 2017

Issued Date: Dec. 22, 2017

Applicant: SAGEMCOM Broadband SAS

Address: 250 Route de l'Empereur - 92848 RUEIL MALMAISON CEDEX- FRANCE

Issued By: Bureau Veritas Consumer Products Services (H.K.) Ltd., Taoyuan Branch
Hsin Chu Laboratory

Lab Address: E-2, No.1, Li Hsin 1st Road, Hsinchu Science Park, Hsinchu City 300,
Taiwan R.O.C.

Test Location: E-2, No.1, Li Hsin 1st Road, Hsinchu Science Park, Hsinchu City 300,
Taiwan R.O.C.

**FCC Registration /
Designation Number:** 723255 / TW2022



This report is for your exclusive use. Any copying or replication of this report to or for any other person or entity, or use of our name or trademark, is permitted only with our prior written permission. This report sets forth our findings solely with respect to the test samples identified herein. The results set forth in this report are not indicative or representative of the quality or characteristics of the lot from which a test sample was taken or any similar or identical product unless specifically and expressly noted. Our report includes all of the tests requested by you and the results thereof based upon the information that you provided to us. You have 60 days from date of issuance of this report to notify us of any material error or omission caused by our negligence, provided, however, that such notice shall be in writing and shall specifically address the issue you wish to raise. A failure to raise such issue within the prescribed time shall constitute your unqualified acceptance of the completeness of this report, the tests conducted and the correctness of the report contents. Unless specific mention, the uncertainty of measurement has been explicitly taken into account to declare the compliance or non-compliance to the specification. The report must not be used by the client to claim product certification, approval, or endorsement by TAF or any government agencies.

Table of Contents

Release Control Record	4
1 Certificate of Conformity	5
2 Summary of Test Results	6
2.1 Measurement Uncertainty	6
2.2 Modification Record	6
3 General Information	7
3.1 General Description of EUT	7
3.2 Description of Test Modes	9
3.2.1 Test Mode Applicability and Tested Channel Detail	10
3.3 Duty Cycle of Test Signal	12
3.4 Description of Support Units	13
3.4.1 Configuration of System under Test	14
3.5 General Description of Applied Standard	15
4 Test Types and Results	16
4.1 Radiated Emission and Bandedge Measurement	16
4.1.1 Limits of Radiated Emission and Bandedge Measurement	16
4.1.2 Test Instruments	17
4.1.3 Test Procedure	19
4.1.4 Deviation from Test Standard	19
4.1.5 Test Setup	20
4.1.6 EUT Operating Condition	21
4.1.7 Test Results	22
4.2 Conducted Emission Measurement	60
4.2.1 Limits of Conducted Emission Measurement	60
4.2.2 Test Instruments	60
4.2.3 Test Procedure	61
4.2.4 Deviation from Test Standard	61
4.2.5 Test Setup	61
4.2.6 EUT Operating Condition	61
4.2.7 Test Results	62
4.3 Transmit Power Measurement	64
4.3.1 Limits of Transmit Power Measurement	64
4.3.2 Test Setup	64
4.3.3 Test Instruments	64
4.3.4 Test Procedure	64
4.3.5 Deviation from Test Standard	64
4.3.6 EUT Operating Condition	64
4.3.7 Test Result	65
4.4 Occupied Bandwidth Measurement	68
4.4.1 Test Setup	68
4.4.2 Test Instruments	68
4.4.3 Test Procedure	68
4.4.4 Test Results	69
4.5 Peak Power Spectral Density Measurement	75
4.5.1 Limits of Peak Power Spectral Density Measurement	75
4.5.2 Test Setup	75
4.5.3 Test Instruments	75
4.5.4 Test Procedure	76
4.5.5 Deviation from Test Standard	76
4.5.6 EUT Operating Condition	76
4.5.7 Test Results (Mode 1)	77
4.6 Frequency Stability Measurement	83
4.6.1 Limits of Frequency Stability Measurement	83

4.6.2	Test Setup.....	83
4.6.3	Test Instruments	83
4.6.4	Test Procedure	83
4.6.5	Deviation from Test Standard	83
4.6.6	EUT Operating Condition	83
4.6.7	Test Results	84
4.7	6dB Bandwidth Measurement	85
4.7.1	Limits of 6dB Bandwidth Measurement.....	85
4.7.2	Test Setup.....	85
4.7.3	Test Instruments	85
4.7.4	Test Procedure	85
4.7.5	Deviation from Test Standard	85
4.7.6	EUT Operating Condition	85
4.7.7	Test Results (Mode 1).....	86
5	Pictures of Test Arrangements.....	88
	Annex A- Radiated Out of Band Emission (OOBE) Measurement (For U-NII-3 band)	89
	Appendix – Information on the Testing Laboratories	92

Release Control Record

Issue No.	Description	Date Issued
RF160614E05F-1	Original release.	Dec. 22, 2017

1 Certificate of Conformity

Product: Euro-DOCSIS3.0

Brand: Sagemcom

Test Model: F@ST 3686 V2.2

Sample Status: ENGINEERING SAMPLE

Applicant: SAGEMCOM Broadband SAS

Test Date: Oct. 28 to Nov. 21, 2017

Standard: 47 CFR FCC Part 15, Subpart E (Section 15.407)
ANSI C63.10: 2013

The above equipment has been tested by **Bureau Veritas Consumer Products Services (H.K.) Ltd., Taoyuan Branch**, and found compliance with the requirement of the above standards. The test record, data evaluation & Equipment Under Test (EUT) configurations represented herein are true and accurate accounts of the measurements of the sample's EMC characteristics under the conditions specified in this report.

Prepared by :  _____, **Date:** _____ Dec. 22, 2017
Claire Kuan / Specialist

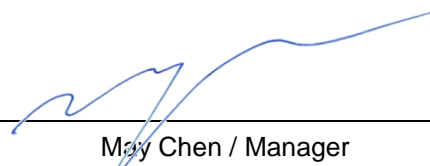
Approved by :  _____, **Date:** _____ Dec. 22, 2017
May Chen / Manager

2 Summary of Test Results

47 CFR FCC Part 15, Subpart E (Section 15.407)			
FCC Clause	Test Item	Result	Remarks
15.407(b)(6)	AC Power Conducted Emissions	Pass	Meet the requirement of limit. Minimum passing margin is -10.34dB at 0.15000MHz.
15.407(b) (1/2/3/4(i/ii)/6)	Radiated Emissions & Band Edge Measurement*	Pass	Meet the requirement of limit. Minimum passing margin is -0.1dB at 5146.20MHz and 5147.10MHz
15.407(a)(1/2/3)	Max Average Transmit Power	Pass	Meet the requirement of limit.
---	Occupied Bandwidth Measurement	-	Reference only.
15.407(a)(1/2/3)	Peak Power Spectral Density	Pass	Meet the requirement of limit.
15.407(e)	6dB bandwidth	Pass	Meet the requirement of limit. (U-NII-3 Band only)
15.407(g)	Frequency Stability	Pass	Meet the requirement of limit.
15.203	Antenna Requirement	Pass	Antenna connector is i-pex(MHF) not a standard connector.

*For U-NII-3 band compliance with rule part 15.407(b)(4)(i), the OOB test plots were recorded in Annex A.

2.1 Measurement Uncertainty

Where relevant, the following measurement uncertainty levels have been estimated for tests performed on the EUT as specified in CISPR 16-4-2:

Measurement	Frequency	Expanded Uncertainty (k=2) (±)
Conducted Emissions at mains ports	150kHz ~ 30MHz	1.84 dB
Radiated Emissions up to 1 GHz	30MHz ~ 1GHz	5.30 dB
Radiated Emissions above 1 GHz	1GHz ~ 6GHz	5.16 dB
	6GHz ~ 18GHz	4.91 dB
	18GHz ~ 40GHz	5.30 dB

2.2 Modification Record

There were no modifications required for compliance.

3 General Information

3.1 General Description of EUT

Product	Euro-DOCSIS3.0
Brand	Sagemcom
Test Model	F@ST 3686 V2.2
Status of EUT	ENGINEERING SAMPLE
Power Supply Rating	12Vdc from adapter
Modulation Type	CCK, DQPSK, DBPSK for DSSS 64QAM, 16QAM, QPSK, BPSK for OFDM 256QAM for OFDM in 11ac mode only
Modulation Technology	DSSS, OFDM
Transfer Rate	802.11b: up to 11Mbps 802.11a/g: up to 54Mbps 802.11n: up to 450Mbps 802.11ac: up to 1300Mbps
Operating Frequency	2.4GHz: 2.412 ~ 2.462GHz 5GHz: 5.18~ 5.24GHz, 5.745 ~ 5.825GHz
Number of Channel	2.4GHz: 802.11b, 802.11g, 802.11n (HT20): 11 802.11n (HT40): 7 5GHz: 802.11a, 802.11n (HT20), 802.11ac (VHT20): 9 802.11n (HT40), 802.11ac (VHT40): 4 802.11ac (VHT80): 2
Output Power	2.4GHz: 573.092mW 5GHz: CDD Mode: 5.18 ~ 5.24GHz: 544.597mW 5.745 ~ 5.825GHz: 524.872mW Beamforming Mode: 5.18 ~ 5.24GHz: 544.597mW 5.745 ~ 5.825GHz: 524.872mW
Antenna Type	Refer to Note
Antenna Connector	Refer to Note
Accessory Device	Adapter x 1
Data Cable Supplied	RJ-45 cable (Unshielded, 1.5m) coaxial cable (shielded, 2m)

Note:

1. Simultaneously transmission condition.

Condition	Technology	
1	WLAN (2.4GHz)	WLAN (5GHz)

Note: The emission of the simultaneous operation has been evaluated and no non-compliance was found.

2. The EUT power needs to be supplied from a power adapter, the information is as below table:

Brand	Model No.	Spec.
SAGEMCOM	NBS30E120250VU	Input: 100-240Vac, 0.9A, 50/60Hz Output: 12V, 2.5A DC output cable: Unshielded 2m

3. The antennas provided to the EUT, please refer to the following table:

Ant. No.	Chain No.	Antenna Gain (dBi)	Frequency range (GHz)	Antenna Type	Connector Type	Cable loss (dB)	Cable Length (mm)
1	Chain (0)	3.3	5.15~5.725	PIFA	NA	NA	NA
		2.5	2.4~2.4835				
2	Chain (1)	4.6	5.15~5.725	PCB	i-pex(MHF)	1.58	250
3	Chain (2)	3.6	5.15~5.725	PIFA	NA	NA	NA
	Chain (1)	2.8	2.4~2.4835				

4. The EUT incorporates a MIMO function:

2.4GHz Band			
MODULATION MODE	DATA RATE (MCS)	TX & RX CONFIGURATION	
802.11b	1 ~ 11Mbps	1TX diversity	1RX
802.11g	6 ~ 54Mbps	2TX	2RX
802.11n (HT20)	MCS 0~7	2TX	2RX
	MCS 8~15	2TX	2RX
802.11n (HT40)	MCS 0~7	2TX	2RX
	MCS 8~15	2TX	2RX
5GHz Band			
MODULATION MODE	DATA RATE (MCS)	TX & RX CONFIGURATION	
802.11a	6 ~ 54Mbps	3TX	3RX
802.11n (HT20)	MCS 0~7	3TX	3RX
	MCS 8~15	3TX	3RX
	MCS 16~23	3TX	3RX
802.11n (HT40)	MCS 0~7	3TX	3RX
	MCS 8~15	3TX	3RX
	MCS 16~23	3TX	3RX
802.11ac (VHT20)	MCS 0~8, NSS=1	3TX	3RX
	MCS 0~8, NSS=2	3TX	3RX
	MCS 0~9, NSS=3	3TX	3RX
802.11ac (VHT40)	MCS 0~9, NSS=1	3TX	3RX
	MCS 0~9, NSS=2	3TX	3RX
	MCS 0~9, NSS=3	3TX	3RX
802.11ac (VHT80)	MCS 0~9, NSS=1	3TX	3RX
	MCS 0~9, NSS=2	3TX	3RX
	MCS 0~9, NSS=3	3TX	3RX

Note:

- All of modulation mode support beamforming function except 2.4GHz and 802.11a modulation mode.
- The EUT support Beamforming and CDD mode, therefore both mode were investigated and the worst case scenario was identified. The worst case data were presented in test report.
- The modulation and bandwidth are similar for 802.11n mode for 20MHz (40MHz) and 802.11ac mode for 20MHz (40MHz), therefore investigated worst case to representative mode in test report. (Final test mode refer section 3.2.1)

5. The above EUT information is declared by manufacturer and for more detailed features description, please refer to the manufacturer's specifications or user's manual.

3.2 Description of Test Modes

FOR 5180 ~ 5240MHz

4 channels are provided for 802.11a, 802.11n (HT20), 802.11ac (VHT20):

Channel	Frequency	Channel	Frequency
36	5180MHz	44	5220MHz
40	5200MHz	48	5240MHz

2 channels are provided for 802.11n (HT40), 802.11ac (VHT40):

Channel	Frequency	Channel	Frequency
38	5190MHz	46	5230MHz

1 channel is provided for 802.11ac (VHT80):

Channel	Frequency
42	5210MHz

FOR 5745 ~ 5825MHz:

5 channels are provided for 802.11a, 802.11n (HT20), 802.11ac (VHT20):

Channel	Frequency	Channel	Frequency
149	5745MHz	161	5805MHz
153	5765MHz	165	5825MHz
157	5785MHz		

2 channels are provided for 802.11n (HT40), 802.11ac (VHT40):

Channel	Frequency	Channel	Frequency
151	5755MHz	159	5795MHz

1 channel is provided for 802.11ac (VHT80):

Channel	Frequency
155	5775MHz

3.2.1 Test Mode Applicability and Tested Channel Detail

EUT Configure Mode	Applicable To				Description
	RE \geq 1G	RE<1G	PLC	APCM	
-	√	√	√	√	-

Where **RE \geq 1G**: Radiated Emission above 1GHz **RE<1G**: Radiated Emission below 1GHz
PLC: Power Line Conducted Emission **APCM**: Antenna Port Conducted Measurement

Radiated Emission Test (Above 1GHz):

- Pre-Scan has been conducted to determine the worst-case mode from all possible combinations between available modulations, data rates and antenna ports (if EUT with antenna diversity architecture).
- Following channel(s) was (were) selected for the final test as listed below.

CDD Mode						
Mode	FREQ. Band (MHz)	Available Channel	Tested Channel	Modulation Technology	Modulation Type	Data Rate (Mbps)
802.11a	5180-5240	36 to 48	36, 40, 48	OFDM	BPSK	6
802.11ac (VHT20)		36 to 48	36, 40, 48	OFDM	BPSK	6.5
802.11ac (VHT40)		38 to 46	38, 46	OFDM	BPSK	13.5
802.11ac (VHT80)		42	42	OFDM	BPSK	29.3
802.11a	5745-5825	149 to 165	149, 157, 165	OFDM	BPSK	6
802.11ac (VHT20)		149 to 165	149, 157, 165	OFDM	BPSK	6.5
802.11ac (VHT40)		151 to 159	151, 159	OFDM	BPSK	13.5
802.11ac (VHT80)		155	155	OFDM	BPSK	29.3

Radiated Emission Test (Below 1GHz):

- Pre-Scan has been conducted to determine the worst-case mode from all possible combinations between available modulations, data rates and antenna ports (if EUT with antenna diversity architecture).
- Following channel(s) was (were) selected for the final test as listed below.

CDD Mode						
Mode	FREQ. Band (MHz)	Available Channel	Tested Channel	Modulation Technology	Modulation Type	Data Rate (Mbps)
802.11ac (VHT20)	5180-5240 5745-5825	36 to 48 149 to 165	36	OFDM	BPSK	6.5

Power Line Conducted Emission Test:

- Pre-Scan has been conducted to determine the worst-case mode from all possible combinations between available modulations, data rates and antenna ports (if EUT with antenna diversity architecture).
- Following channel(s) was (were) selected for the final test as listed below.

CDD Mode						
Mode	FREQ. Band (MHz)	Available Channel	Tested Channel	Modulation Technology	Modulation Type	Data Rate (Mbps)
802.11ac (VHT20)	5180-5240 5745-5825	36 to 48 149 to 165	36	OFDM	BPSK	6.5

Antenna Port Conducted Measurement:

- This item includes all test value of each mode, but only includes spectrum plot of worst value of each mode.
- Pre-Scan has been conducted to determine the worst-case mode from all possible combinations between available modulations, data rates and antenna ports (if EUT with antenna diversity architecture).
- Following channel(s) was (were) selected for the final test as listed below.

CDD Mode						
Mode	FREQ. Band (MHz)	Available Channel	Tested Channel	Modulation Technology	Modulation Type	Data Rate (Mbps)
802.11a	5180-5240	36 to 48	36, 40, 48	OFDM	BPSK	6
802.11ac (VHT20)		36 to 48	36, 40, 48	OFDM	BPSK	6.5
802.11ac (VHT40)		38 to 46	38, 46	OFDM	BPSK	13.5
802.11ac (VHT80)		42	42	OFDM	BPSK	29.3
802.11a	5745-5825	149 to 165	149, 157, 165	OFDM	BPSK	6
802.11ac (VHT20)		149 to 165	149, 157, 165	OFDM	BPSK	6.5
802.11ac (VHT40)		151 to 159	151, 159	OFDM	BPSK	13.5
802.11ac (VHT80)		155	155	OFDM	BPSK	29.3
Beamforming Mode (output power only)						
Mode	FREQ. Band (MHz)	Available Channel	Tested Channel	Modulation Technology	Modulation Type	Data Rate (Mbps)
802.11ac (VHT20)	5180-5240	36 to 48	36, 40, 48	OFDM	BPSK	6.5
802.11ac (VHT40)		38 to 46	38, 46	OFDM	BPSK	13.5
802.11ac (VHT80)		42	42	OFDM	BPSK	29.3
802.11ac (VHT20)	5745-5825	149 to 165	149, 157, 165	OFDM	BPSK	6.5
802.11ac (VHT40)		151 to 159	151, 159	OFDM	BPSK	13.5
802.11ac (VHT80)		155	155	OFDM	BPSK	29.3

Test Condition:

Applicable To	ENVIRONMENTAL CONDITIONS	INPUT POWER	TESTED BY
RE \geq 1G	24deg. C, 71%RH	120Vac, 60Hz	Andy Ho
RE $<$ 1G	24deg. C, 69%RH	120Vac, 60Hz	Andy Ho
PLC	25deg. C, 75%RH	120Vac, 60Hz	Andy Ho
APCM	25deg. C, 60%RH	120Vac, 60Hz	Robert Cheng

3.3 Duty Cycle of Test Signal

If duty cycle of test signal is $\geq 98\%$, duty factor is not required.

If duty cycle of test signal is $< 98\%$, duty factor shall be considered.

802.11a: Duty cycle = $2.062/2.092 = 0.986$

802.11ac (VHT20): Duty cycle = $1.926/1.958 = 0.984$

802.11ac (VHT40): Duty cycle = $0.951/0.981 = 0.969$, Duty factor = $10 * \log(1/0.969) = 0.13$

802.11ac (VHT80): Duty cycle = $0.46/0.488 = 0.943$

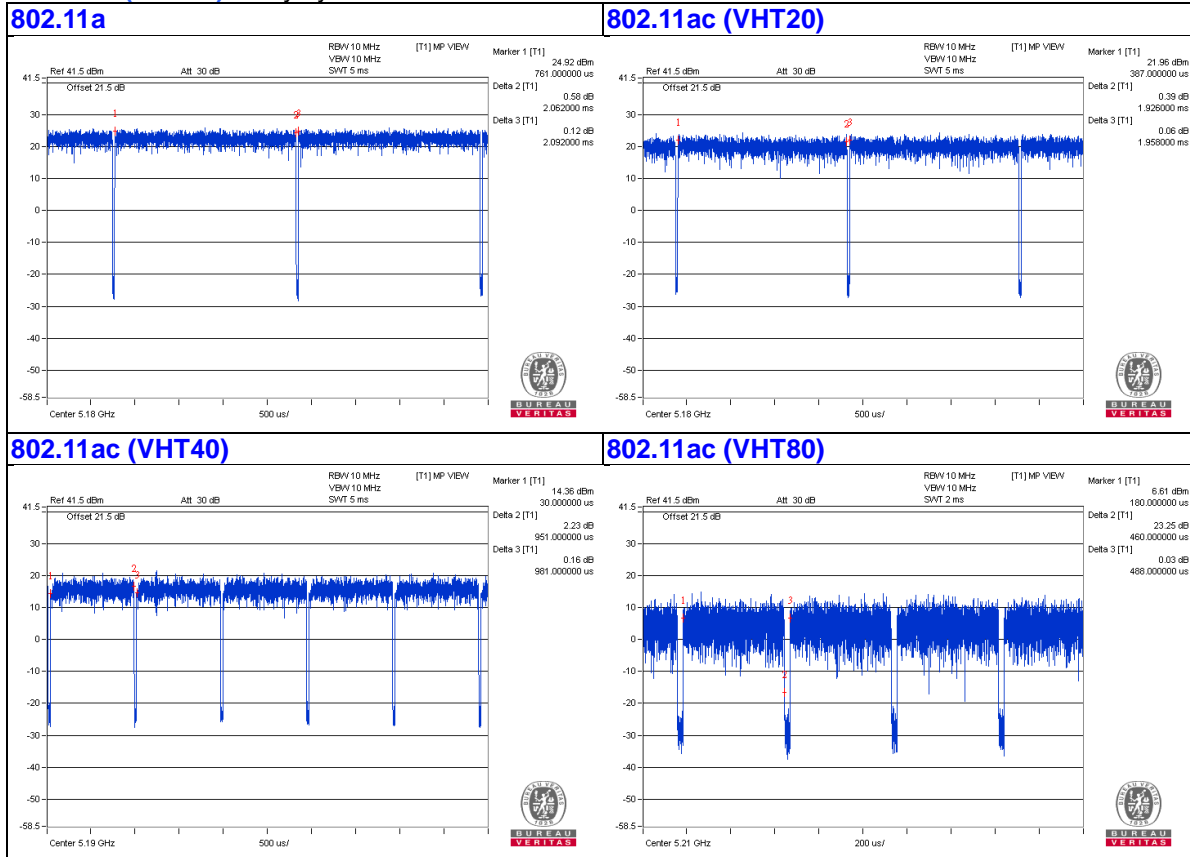

3.4 Description of Support Units

The EUT has been tested as an independent unit together with other necessary accessories or support units. The following support units or accessories were used to form a representative test configuration during the tests.

ID	Product	Brand	Model No.	Serial No.	FCC ID	Remarks
A.	Telephone	WONDER	WD-303	7C17KA04011	NA	Provided by Lab
B.	Laptop	DELL	E6420	B92T3R1	FCC DoC	Provided by Lab
C.	iPod	Apple	MD778TA/A	CC4JMFL0F4T1	NA	Provided by Lab

Note:

1. All power cords of the above support units are non-shielded (1.8m).

ID	Descriptions	Qty.	Length (m)	Shielding (Yes/No)	Cores (Qty.)	Remarks
1.	DC Cable	1	2	No	0	Supplied by client
2.	RJ-11 Cable	1	10	No	0	Provided by Lab
3.	RJ-45 Cable	1	10	No	0	Provided by Lab
4.	Coaxial Cable	1	10	Yes	0	Provided by Lab

3.4.1 Configuration of System under Test

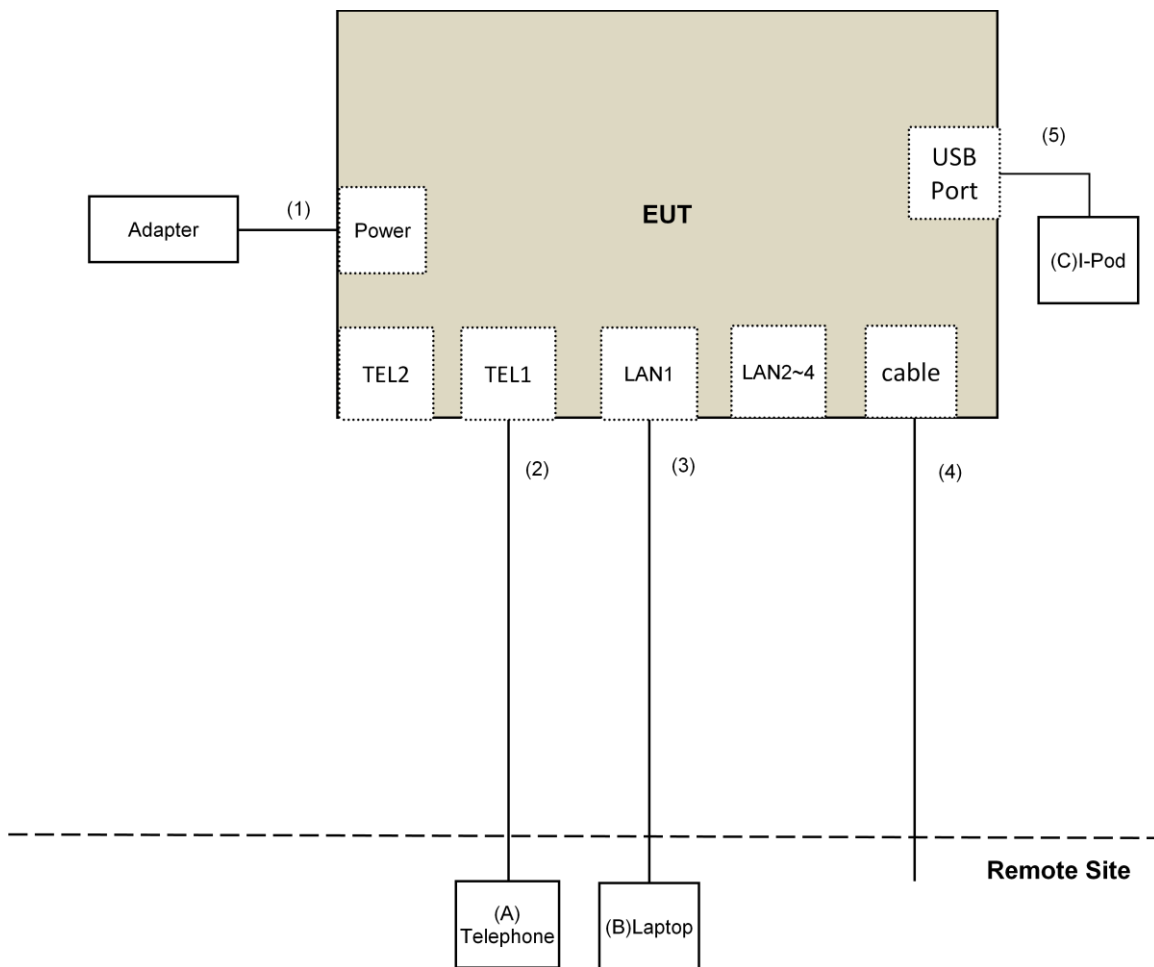

3.5 General Description of Applied Standard

The EUT is a RF Product. According to the specifications of the manufacturer, it must comply with the requirements of the following standards:

FCC Part 15, Subpart E (15.407)
KDB 789033 D02 General UNII Test Procedure New Rules v01r04
KDB 662911 D01 Multiple Transmitter Output v02r01
ANSI C63.10-2013

All test items have been performed and recorded as per the above standards.

NOTE: The EUT has been verified to comply with the requirements of FCC Part 15, Subpart B, Class B (DoC). The test report has been issued separately.

4 Test Types and Results

4.1 Radiated Emission and Bandedge Measurement

4.1.1 Limits of Radiated Emission and Bandedge Measurement

Radiated emissions which fall in the restricted bands must comply with the radiated emission limits specified as below table.

Frequencies (MHz)	Field Strength (microvolts/meter)	Measurement Distance (meters)
0.009 ~ 0.490	2400/F(kHz)	300
0.490 ~ 1.705	24000/F(kHz)	30
1.705 ~ 30.0	30	30
30 ~ 88	100	3
88 ~ 216	150	3
216 ~ 960	200	3
Above 960	500	3

NOTE:

1. The lower limit shall apply at the transition frequencies.
2. Emission level (dBuV/m) = 20 log Emission level (uV/m).
3. For frequencies above 1000MHz, the field strength limits are based on average detector, however, the peak field strength of any emission shall not exceed the maximum permitted average limits, specified above by more than 20dB under any condition of modulation.

Limits of unwanted emission out of the restricted bands

Applicable To		Limit	
789033 D02 General UNII Test Procedure New Rules v01r04		Field Strength at 3m	
		PK:74 (dBuV/m)	AV:54 (dBuV/m)
Frequency Band	Applicable To	EIRP Limit	Equivalent Field Strength at 3m
5150~5250 MHz	15.407(b)(1)	PK:-27 (dBm/MHz)	PK:68.2(dBuV/m)
5250~5350 MHz	15.407(b)(2)		
5470~5725 MHz	15.407(b)(3)		
5725~5850 MHz	<input checked="" type="checkbox"/> 15.407(b)(4)(i)	PK:-27 (dBm/MHz) ^{*1} PK:10 (dBm/MHz) ^{*2} PK:15.6 (dBm/MHz) ^{*3} PK:27 (dBm/MHz) ^{*4}	PK: 68.2(dBuV/m) ^{*1} PK:105.2 (dBuV/m) ^{*2} PK: 110.8(dBuV/m) ^{*3} PK:122.2 (dBuV/m) ^{*4}
	<input type="checkbox"/> 15.407(b)(4)(ii)	Emission limits in section 15.247(d)	
^{*1} beyond 75 MHz or more above of the band edge.		^{*2} below the band edge increasing linearly to 10 dBm/MHz at 25 MHz above.	
^{*3} below the band edge increasing linearly to a level of 15.6 dBm/MHz at 5 MHz above.		^{*4} from 5 MHz above or below the band edge increasing linearly to a level of 27 dBm/MHz at the band edge.	

Note:

The following formula is used to convert the equipment isotropic radiated power (eirp) to field strength:

$$E = \frac{1000000\sqrt{30P}}{3} \mu\text{V/m, where P is the eirp (Watts).}$$

4.1.2 Test Instruments

DESCRIPTION & MANUFACTURER	MODEL NO.	SERIAL NO.	CALIBRATED DATE	CALIBRATED UNTIL
Test Receiver Keysight	N9038A	MY54450088	July 08, 2017	July 07, 2018
Pre-Amplifier ^(*) EMCI	EMC001340	980142	Jan. 20, 2016	Jan. 19, 2018
Loop Antenna ^(*) Electro-Metrics	EM-6879	264	Dec. 16, 2016	Dec. 15, 2018
RF Cable	NA	LOOPCAB-001 LOOPCAB-002	Jan. 17, 2017	Jan. 16, 2018
Pre-Amplifier Mini-Circuits	ZFL-1000VH2B	AMP-ZFL-01	Nov. 09, 2017	Nov. 08, 2018
Trilog Broadband Antenna SCHWARZBECK	VULB 9168	9168-406	Dec. 13, 2016	Dec. 12, 2017
RF Cable	8D	966-4-1 966-4-2 966-4-3	Apr. 01, 2017	Mar. 31, 2018
Fixed attenuator Mini-Circuits	UNAT-5+	PAD-3m-4-01	Oct. 03, 2017	Oct. 02, 2018
Horn_Antenna SCHWARZBECK	BBHA 9120D	9120D-783	Dec. 27, 2016	Dec. 26, 2017
Pre-Amplifier EMCI	EMC12630SE	980385	Feb. 02, 2017	Feb. 01, 2018
RF Cable	EMC104-SM-SM-1200 EMC104-SM-SM-2000 EMC104-SM-SM-5000	160923 150318 150321	Feb. 02, 2017 Mar. 29, 2017 Mar. 29, 2017	Feb. 01, 2018 Mar. 28, 2018 Mar. 28, 2018
Pre-Amplifier EMCI	EMC184045SE	980387	Feb. 02, 2017	Feb. 01, 2018
Horn_Antenna SCHWARZBECK	BBHA 9170	BBHA9170608	Dec. 15, 2016	Dec. 14, 2017
RF Cable	SUCOFLEX 102	36432/2 36433/2	Jan. 15, 2017	Jan. 14, 2018
Software	ADT_Radiated_V8.7.08	NA	NA	NA
Antenna Tower & Turn Table Max-Full	MF-7802	MF780208410	NA	NA
Boresight Antenna Fixture	FBA-01	FBA-SIP02	NA	NA
Spectrum Analyzer Agilent	E4446A	MY48250253	Dec. 21, 2016	Dec. 20, 2017
Power meter Anritsu	ML2495A	1014008	May 11, 2017	May 10, 2018
Power sensor Anritsu	MA2411B	0917122	May 11, 2017	May 10, 2018
AC Power Source Extech Electronics	6205	1440452	NA	NA
Temperature & Humidity Chamber Giant Force	GTH-150-40-SP-AR	MAA0812-008	Jan. 11, 2017	Jan. 10, 2018
True RMS Clamp Meter FLUKE	325	31130711WS	May 29, 2017	May 28, 2018

Note:

1. The calibration interval of the above test instruments is 12 months and the calibrations are traceable to NML/ROC and NIST/USA.
2. *The calibration interval of the above test instruments is 24 months and the calibrations are traceable to NML/ROC and NIST/USA.
3. The test was performed in 966 Chamber No. 4.
4. The CANADA Site Registration No. is 20331-2
5. Loop antenna was used for all emissions below 30 MHz.
6. Tested Date: Oct. 28 to Nov. 14, 2017

4.1.3 Test Procedure

For Radiated emission below 30MHz

- a. The EUT was placed on the top of a rotating table 0.8 meters above the ground at a 3 meter chamber room. The table was rotated 360 degrees to determine the position of the highest radiation.
- b. The EUT was set 3 meters away from the interference-receiving antenna, which was mounted on the top of a variable-height antenna tower.
- c. Both X and Y axes of the antenna are set to make the measurement.
- d. For each suspected emission, the EUT was arranged to its worst case and the rotatable table was turned from 0 degrees to 360 degrees to find the maximum reading.
- e. The test-receiver system was set to Quasi-Peak Detect Function and Specified Bandwidth with Maximum Hold Mode.

NOTE:

1. The resolution bandwidth and video bandwidth of test receiver/spectrum analyzer is 9kHz at frequency below 30MHz.

For Radiated emission above 30MHz

- a. The EUT was placed on the top of a rotating table 0.8 meters (for 30MHz ~ 1GHz) / 1.5 meters (for above 1GHz) above the ground at 3 meter chamber room for test. The table was rotated 360 degrees to determine the position of the highest radiation.
- b. The EUT was set 3 meters away from the interference-receiving antenna, which was mounted on the top of a variable-height antenna tower.
- c. The height of antenna is varied from one meter to four meters above the ground to determine the maximum value of the field strength. Both horizontal and vertical polarizations of the antenna are set to make the measurement.
- d. For each suspected emission, the EUT was arranged to its worst case and then the antenna was tuned to heights from 1 meter to 4 meters and the rotatable table was turned from 0 degrees to 360 degrees to find the maximum reading.
- e. The test-receiver system was set to quasi-peak detect function and specified bandwidth with maximum hold mode when the test frequency is below 1 GHz.
- f. The test-receiver system was set to peak and average detect function and specified bandwidth with maximum hold mode when the test frequency is above 1 GHz. If the peak reading value also meets average limit, measurement with the average detector is unnecessary.

Note:

1. The resolution bandwidth and video bandwidth of test receiver/spectrum analyzer is 120kHz for Quasi-peak detection (QP) at frequency below 1GHz.
2. The resolution bandwidth of test receiver/spectrum analyzer is 1 MHz and the video bandwidth is 3 MHz for Peak detection (PK) at frequency above 1GHz.
3. The resolution bandwidth of test receiver/spectrum analyzer is 1MHz and the video bandwidth is $\geq 1/T$ (Duty cycle < 98%) or 10Hz (Duty cycle $\geq 98\%$) for Average detection (AV) at frequency above 1GHz.
4. All modes of operation were investigated and the worst-case emissions are reported.

4.1.4 Deviation from Test Standard

No deviation.

4.1.5 Test Setup

For Radiated emission below 30MHz

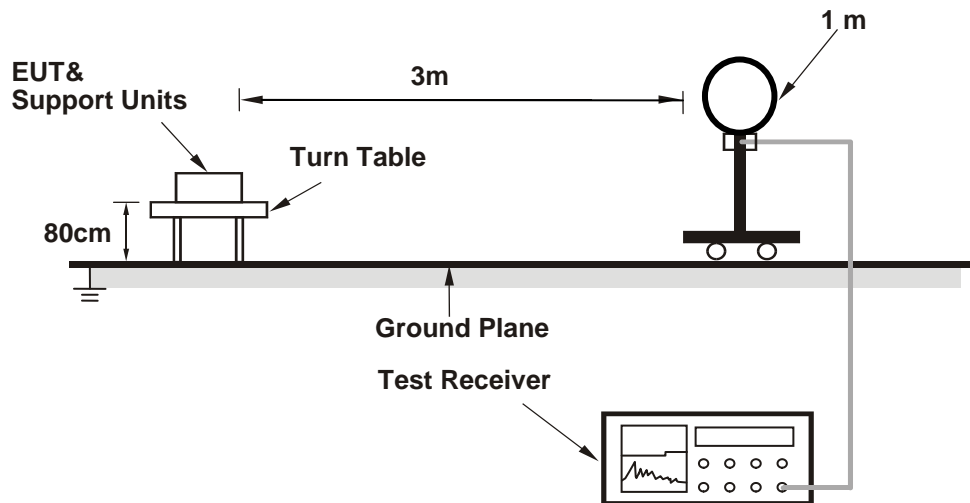

For Radiated emission 30MHz to 1GHz

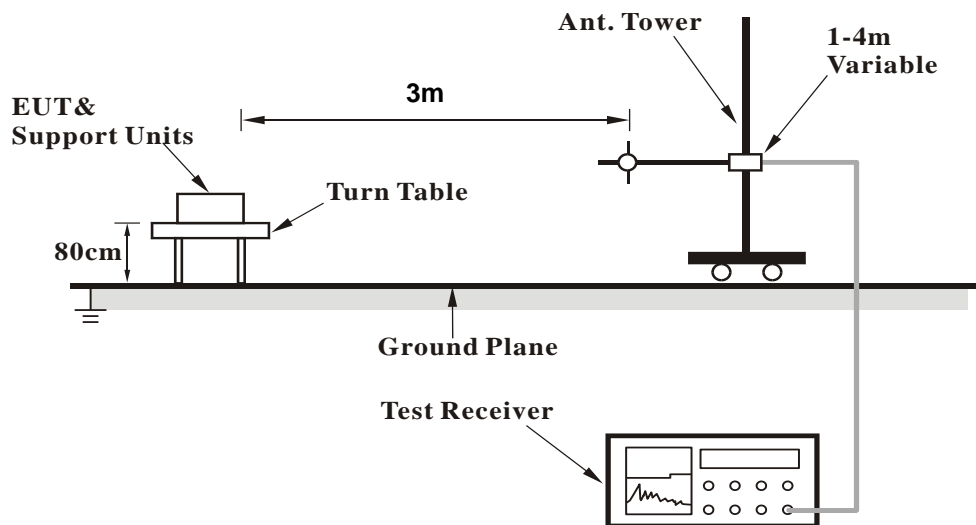

For Radiated emission above 1GHz

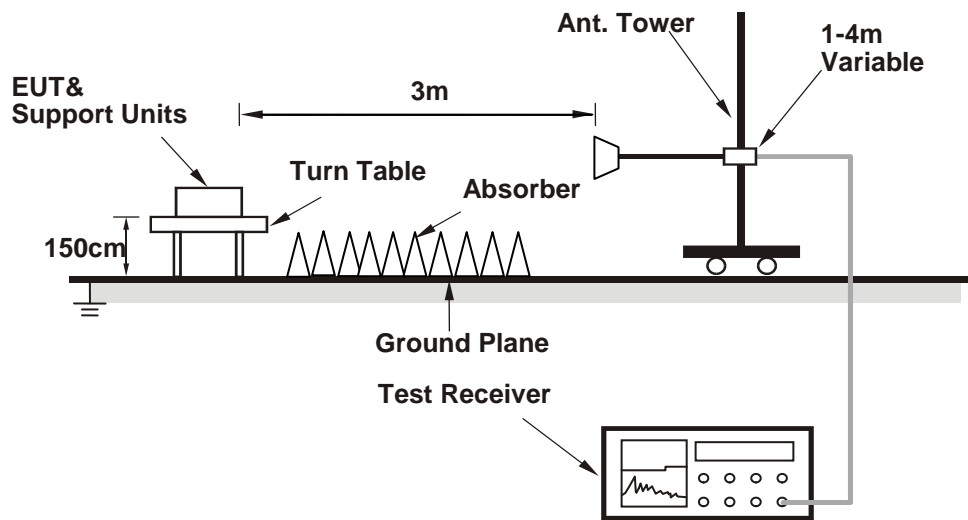

For the actual test configuration, please refer to the attached file (Test Setup Photo).

4.1.6 EUT Operating Condition

- a. Connected the EUT with the Laptop which is placed on remote site.
- b. Controlling software (Mtool V2.0.1.0) has been activated to set the EUT on specific status.

4.1.7 Test Results

Above 1GHz Data:

802.11a

CHANNEL	TX Channel 36	DETECTOR FUNCTION	Peak (PK)
FREQUENCY RANGE	1GHz ~ 40GHz		Average (AV)

ANTENNA POLARITY & TEST DISTANCE: HORIZONTAL AT 3 M

NO.	FREQ. (MHz)	EMISSION LEVEL (dBuV/m)	LIMIT (dBuV/m)	MARGIN (dB)	ANTENNA HEIGHT (m)	TABLE ANGLE (Degree)	RAW VALUE (dBuV)	CORRECTION FACTOR (dB/m)
1	5000.00	52.7 PK	74.0	-21.3	2.78 H	155	48.9	3.8
2	5000.00	46.5 AV	54.0	-7.5	2.78 H	155	42.7	3.8
3	5146.70	66.2 PK	74.0	-7.8	2.78 H	314	62.2	4.0
4	5146.70	51.3 AV	54.0	-2.7	2.78 H	314	47.3	4.0
5	*5180.00	111.3 PK			2.78 H	314	107.3	4.0
6	*5180.00	102.3 AV			2.78 H	314	98.3	4.0
7	#10360.00	48.8 PK	74.0	-25.2	1.49 H	270	35.2	13.6
8	#10360.00	36.4 AV	54.0	-17.6	1.49 H	270	22.8	13.6
9	15540.00	46.3 PK	74.0	-27.7	1.51 H	223	33.1	13.2
10	15540.00	34.7 AV	54.0	-19.3	1.51 H	223	21.5	13.2

REMARKS:

1. Emission Level(dBuV/m) = Raw Value(dBuV) + Correction Factor(dB/m)
2. Correction Factor(dB/m) = Antenna Factor(dB/m) + Cable Factor(dB) – Pre-Amplifier Factor(dB)
3. The other emission levels were very low against the limit.
4. Margin value = Emission Level – Limit value
5. " * ": Fundamental frequency.
6. " # ": The radiated frequency is out of the restricted band.

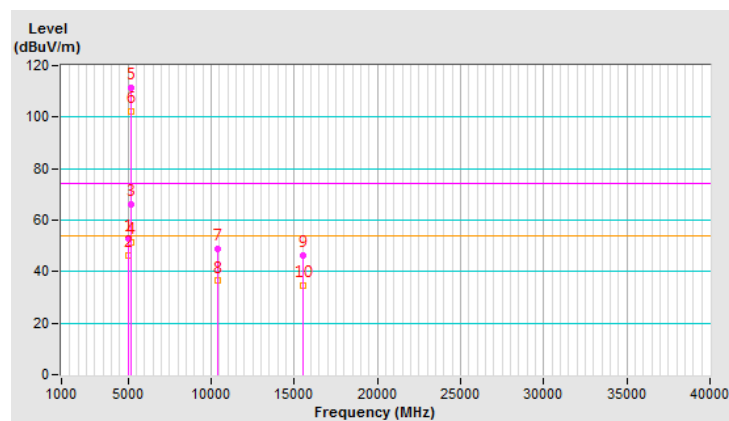

CHANNEL	TX Channel 36	DETECTOR FUNCTION	Peak (PK)
FREQUENCY RANGE	1GHz ~ 40GHz		Average (AV)

ANTENNA POLARITY & TEST DISTANCE: VERTICAL AT 3 M

NO.	FREQ. (MHz)	EMISSION LEVEL (dBuV/m)	LIMIT (dBuV/m)	MARGIN (dB)	ANTENNA HEIGHT (m)	TABLE ANGLE (Degree)	RAW VALUE (dBuV)	CORRECTION FACTOR (dB/m)
1	5019.00	59.6 PK	74.0	-14.4	2.73 V	119	55.8	3.8
2	5019.00	48.9 AV	54.0	-5.1	2.73 V	119	45.1	3.8
3	5146.70	68.1 PK	74.0	-5.9	1.50 V	82	64.1	4.0
4	5146.70	52.1 AV	54.0	-1.9	1.50 V	82	48.1	4.0
5	*5180.00	116.0 PK			1.50 V	83	112.0	4.0
6	*5180.00	106.0 AV			1.50 V	83	102.0	4.0
7	#10360.00	52.0 PK	74.0	-22.0	1.50 V	265	38.4	13.6
8	#10360.00	39.9 AV	54.0	-14.1	1.50 V	265	26.3	13.6
9	15540.00	47.0 PK	74.0	-27.0	1.49 V	115	33.8	13.2
10	15540.00	34.3 AV	54.0	-19.7	1.49 V	115	21.1	13.2

REMARKS:

1. Emission Level(dBuV/m) = Raw Value(dBuV) + Correction Factor(dB/m)
2. Correction Factor(dB/m) = Antenna Factor(dB/m) + Cable Factor(dB) – Pre-Amplifier Factor(dB)
3. The other emission levels were very low against the limit.
4. Margin value = Emission Level – Limit value
5. " * ": Fundamental frequency.
6. " # ": The radiated frequency is out of the restricted band.

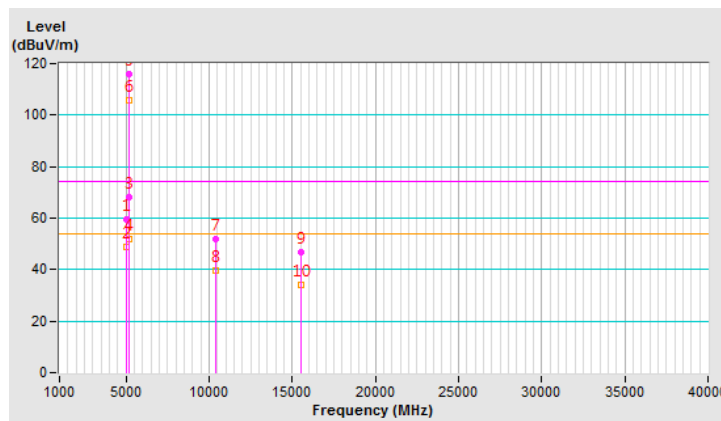

CHANNEL	TX Channel 40	DETECTOR FUNCTION	Peak (PK)
FREQUENCY RANGE	1GHz ~ 40GHz		Average (AV)

ANTENNA POLARITY & TEST DISTANCE: HORIZONTAL AT 3 M

NO.	FREQ. (MHz)	EMISSION LEVEL (dBuV/m)	LIMIT (dBuV/m)	MARGIN (dB)	ANTENNA HEIGHT (m)	TABLE ANGLE (Degree)	RAW VALUE (dBuV)	CORRECTION FACTOR (dB/m)
1	5039.10	58.6 PK	74.0	-15.4	2.84 H	324	54.7	3.9
2	5039.10	50.3 AV	54.0	-3.7	2.84 H	324	46.4	3.9
3	*5200.00	110.4 PK			2.84 H	324	106.4	4.0
4	*5200.00	101.9 AV			2.84 H	324	97.9	4.0
5	5365.80	62.1 PK	74.0	-11.9	2.84 H	324	57.7	4.4
6	5365.80	52.8 AV	54.0	-1.2	2.84 H	324	48.4	4.4
7	#10400.00	49.4 PK	74.0	-24.6	1.48 H	264	35.8	13.6
8	#10400.00	36.8 AV	54.0	-17.2	1.48 H	264	23.2	13.6
9	15600.00	46.8 PK	74.0	-27.2	1.56 H	225	33.4	13.4
10	15600.00	34.9 AV	54.0	-19.1	1.56 H	225	21.5	13.4

REMARKS:

1. Emission Level(dBuV/m) = Raw Value(dBuV) + Correction Factor(dB/m)
2. Correction Factor(dB/m) = Antenna Factor(dB/m) + Cable Factor(dB) – Pre-Amplifier Factor(dB)
3. The other emission levels were very low against the limit.
4. Margin value = Emission Level – Limit value
5. " * ": Fundamental frequency.
6. " # ": The radiated frequency is out of the restricted band.

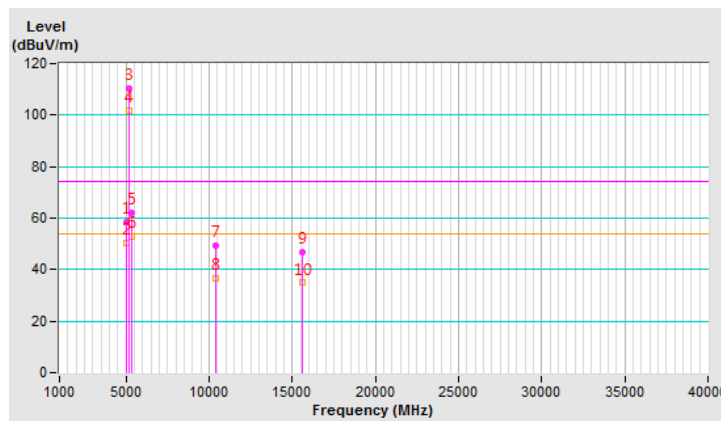

CHANNEL	TX Channel 40	DETECTOR FUNCTION	Peak (PK)
FREQUENCY RANGE	1GHz ~ 40GHz		Average (AV)

ANTENNA POLARITY & TEST DISTANCE: VERTICAL AT 3 M

NO.	FREQ. (MHz)	EMISSION LEVEL (dBuV/m)	LIMIT (dBuV/m)	MARGIN (dB)	ANTENNA HEIGHT (m)	TABLE ANGLE (Degree)	RAW VALUE (dBuV)	CORRECTION FACTOR (dB/m)
1	5039.10	60.5 PK	74.0	-13.5	2.62 V	107	56.6	3.9
2	5039.10	51.1 AV	54.0	-2.9	2.62 V	107	47.2	3.9
3	*5200.00	115.1 PK			2.54 V	78	111.1	4.0
4	*5200.00	105.6 AV			2.54 V	78	101.6	4.0
5	5365.80	64.0 PK	74.0	-10.0	2.62 V	94	59.6	4.4
6	5365.80	53.6 AV	54.0	-0.4	2.62 V	94	49.2	4.4
7	#10400.00	52.6 PK	74.0	-21.4	1.45 V	275	39.0	13.6
8	#10400.00	40.4 AV	54.0	-13.6	1.45 V	275	26.8	13.6
9	15600.00	46.5 PK	74.0	-27.5	1.50 V	117	33.1	13.4
10	15600.00	33.9 AV	54.0	-20.1	1.50 V	117	20.5	13.4

REMARKS:

1. Emission Level(dBuV/m) = Raw Value(dBuV) + Correction Factor(dB/m)
2. Correction Factor(dB/m) = Antenna Factor(dB/m) + Cable Factor(dB) – Pre-Amplifier Factor(dB)
3. The other emission levels were very low against the limit.
4. Margin value = Emission Level – Limit value
5. " * ": Fundamental frequency.
6. " # ": The radiated frequency is out of the restricted band.

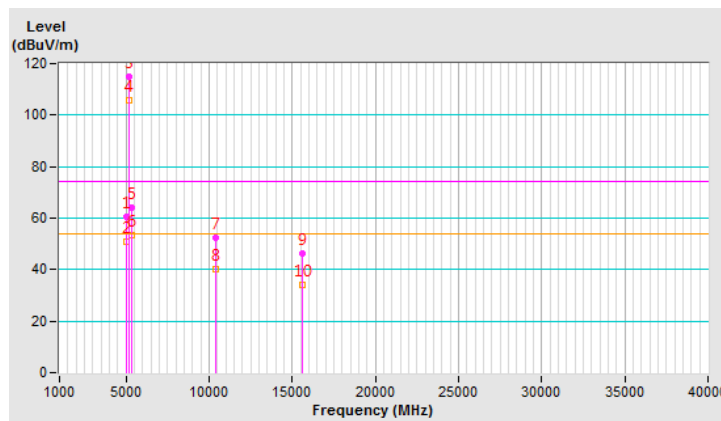

CHANNEL	TX Channel 48	DETECTOR FUNCTION	Peak (PK)
FREQUENCY RANGE	1GHz ~ 40GHz		Average (AV)

ANTENNA POLARITY & TEST DISTANCE: HORIZONTAL AT 3 M

NO.	FREQ. (MHz)	EMISSION LEVEL (dBuV/m)	LIMIT (dBuV/m)	MARGIN (dB)	ANTENNA HEIGHT (m)	TABLE ANGLE (Degree)	RAW VALUE (dBuV)	CORRECTION FACTOR (dB/m)
1	5079.20	58.8 PK	74.0	-15.2	2.80 H	332	54.9	3.9
2	5079.20	50.3 AV	54.0	-3.7	2.80 H	332	46.4	3.9
3	*5240.00	111.5 PK			2.80 H	332	107.3	4.2
4	*5240.00	101.8 AV			2.80 H	332	97.6	4.2
5	5396.60	62.3 PK	74.0	-11.7	2.80 H	332	57.9	4.4
6	5396.60	52.9 AV	54.0	-1.1	2.80 H	332	48.5	4.4
7	#10480.00	49.4 PK	74.0	-24.6	1.50 H	257	35.7	13.7
8	#10480.00	36.7 AV	54.0	-17.3	1.50 H	257	23.0	13.7
9	15720.00	46.7 PK	74.0	-27.3	1.52 H	224	32.7	14.0
10	15720.00	35.1 AV	54.0	-18.9	1.52 H	224	21.1	14.0

REMARKS:

1. Emission Level(dBuV/m) = Raw Value(dBuV) + Correction Factor(dB/m)
2. Correction Factor(dB/m) = Antenna Factor(dB/m) + Cable Factor(dB) – Pre-Amplifier Factor(dB)
3. The other emission levels were very low against the limit.
4. Margin value = Emission Level – Limit value
5. " * ": Fundamental frequency.
6. " # ": The radiated frequency is out of the restricted band.

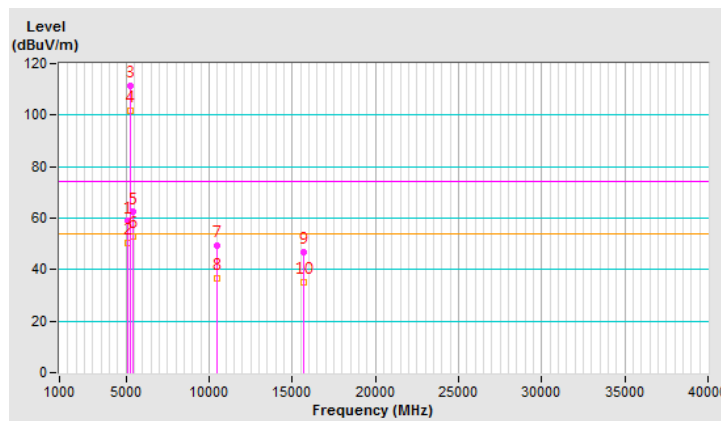

CHANNEL	TX Channel 48	DETECTOR FUNCTION	Peak (PK)
FREQUENCY RANGE	1GHz ~ 40GHz		Average (AV)

ANTENNA POLARITY & TEST DISTANCE: VERTICAL AT 3 M

NO.	FREQ. (MHz)	EMISSION LEVEL (dBuV/m)	LIMIT (dBuV/m)	MARGIN (dB)	ANTENNA HEIGHT (m)	TABLE ANGLE (Degree)	RAW VALUE (dBuV)	CORRECTION FACTOR (dB/m)
1	5079.20	60.7 PK	74.0	-13.3	2.68 V	112	56.8	3.9
2	5079.20	51.1 AV	54.0	-2.9	2.68 V	112	47.2	3.9
3	*5240.00	116.2 PK			2.68 V	98	112.0	4.2
4	*5240.00	105.5 AV			2.68 V	98	101.3	4.2
5	5396.60	64.2 PK	74.0	-9.8	2.68 V	88	59.8	4.4
6	5396.60	53.7 AV	54.0	-0.3	2.68 V	88	49.3	4.4
7	#10480.00	52.5 PK	74.0	-21.5	1.51 V	265	38.8	13.7
8	#10480.00	40.2 AV	54.0	-13.8	1.51 V	265	26.5	13.7
9	15720.00	47.0 PK	74.0	-27.0	1.49 V	119	33.0	14.0
10	15720.00	34.4 AV	54.0	-19.6	1.49 V	119	20.4	14.0

REMARKS:

1. Emission Level(dBuV/m) = Raw Value(dBuV) + Correction Factor(dB/m)
2. Correction Factor(dB/m) = Antenna Factor(dB/m) + Cable Factor(dB) – Pre-Amplifier Factor(dB)
3. The other emission levels were very low against the limit.
4. Margin value = Emission Level – Limit value
5. " * ": Fundamental frequency.
6. " # ": The radiated frequency is out of the restricted band.

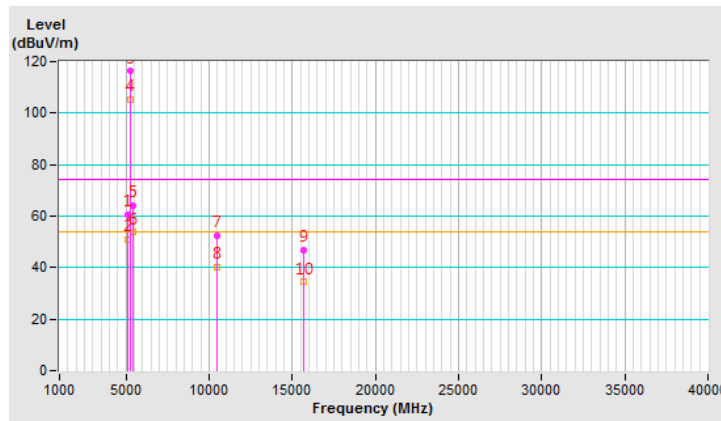

CHANNEL	TX Channel 149	DETECTOR FUNCTION	Peak (PK)
FREQUENCY RANGE	1GHz ~ 40GHz		Average (AV)

ANTENNA POLARITY & TEST DISTANCE: HORIZONTAL AT 3 M

NO.	FREQ. (MHz)	EMISSION LEVEL (dBuV/m)	LIMIT (dBuV/m)	MARGIN (dB)	ANTENNA HEIGHT (m)	TABLE ANGLE (Degree)	RAW VALUE (dBuV)	CORRECTION FACTOR (dB/m)
1	*5745.00	113.6 PK			1.50 H	190	108.6	5.0
2	*5745.00	103.5 AV			1.50 H	190	98.5	5.0
3	11490.00	51.6 PK	74.0	-22.4	1.51 H	328	37.5	14.1
4	11490.00	38.4 AV	54.0	-15.6	1.51 H	328	24.3	14.1
5	#17235.00	52.4 PK	74.0	-21.6	1.50 H	326	34.1	18.3
6	#17235.00	41.1 AV	54.0	-12.9	1.50 H	326	22.8	18.3

REMARKS:

1. Emission Level(dBuV/m) = Raw Value(dBuV) + Correction Factor(dB/m)
2. Correction Factor(dB/m) = Antenna Factor(dB/m) + Cable Factor(dB) – Pre-Amplifier Factor(dB)
3. The other emission levels were very low against the limit.
4. Margin value = Emission Level – Limit value
5. " * ": Fundamental frequency.
6. " # ": The radiated frequency is out of the restricted band.

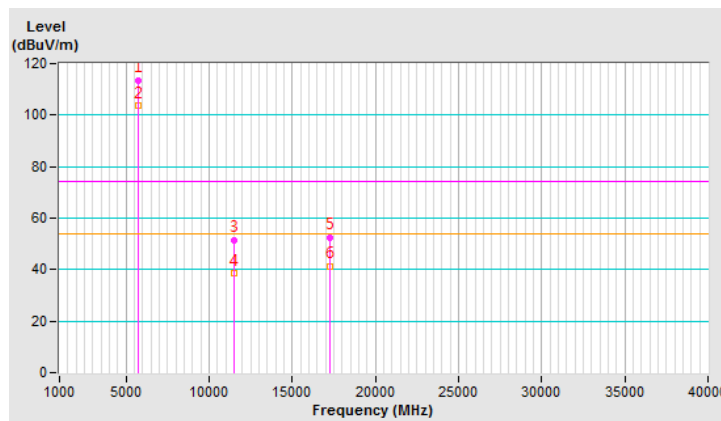

CHANNEL	TX Channel 149	DETECTOR FUNCTION	Peak (PK)
FREQUENCY RANGE	1GHz ~ 40GHz		Average (AV)

ANTENNA POLARITY & TEST DISTANCE: VERTICAL AT 3 M

NO.	FREQ. (MHz)	EMISSION LEVEL (dBuV/m)	LIMIT (dBuV/m)	MARGIN (dB)	ANTENNA HEIGHT (m)	TABLE ANGLE (Degree)	RAW VALUE (dBuV)	CORRECTION FACTOR (dB/m)
1	*5745.00	116.8 PK			2.50 V	120	111.8	5.0
2	*5745.00	106.6 AV			2.50 V	120	101.6	5.0
3	11490.00	53.0 PK	74.0	-21.0	1.65 V	279	38.9	14.1
4	11490.00	40.7 AV	54.0	-13.3	1.65 V	279	26.6	14.1
5	#17235.00	52.8 PK	74.0	-21.2	1.49 V	254	34.5	18.3
6	#17235.00	41.2 AV	54.0	-12.8	1.49 V	254	22.9	18.3

REMARKS:

1. Emission Level(dBuV/m) = Raw Value(dBuV) + Correction Factor(dB/m)
2. Correction Factor(dB/m) = Antenna Factor(dB/m) + Cable Factor(dB) – Pre-Amplifier Factor(dB)
3. The other emission levels were very low against the limit.
4. Margin value = Emission Level – Limit value
5. " * ": Fundamental frequency.
6. " # ": The radiated frequency is out of the restricted band.

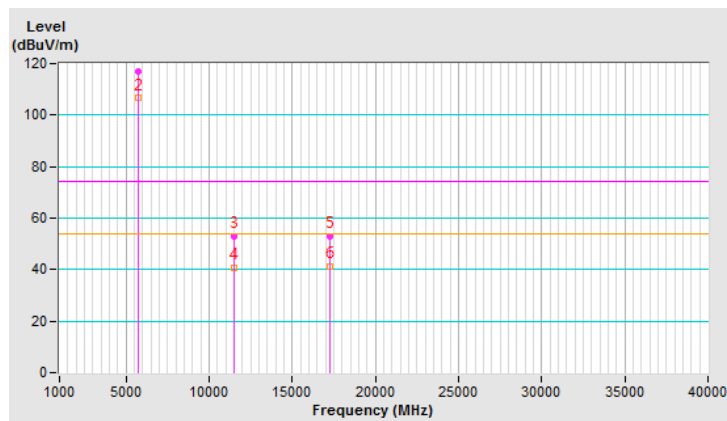

CHANNEL	TX Channel 157	DETECTOR FUNCTION	Peak (PK)
FREQUENCY RANGE	1GHz ~ 40GHz		Average (AV)

ANTENNA POLARITY & TEST DISTANCE: HORIZONTAL AT 3 M

NO.	FREQ. (MHz)	EMISSION LEVEL (dBuV/m)	LIMIT (dBuV/m)	MARGIN (dB)	ANTENNA HEIGHT (m)	TABLE ANGLE (Degree)	RAW VALUE (dBuV)	CORRECTION FACTOR (dB/m)
1	*5785.00	114.2 PK			1.27 H	204	109.2	5.0
2	*5785.00	104.1 AV			1.27 H	204	99.1	5.0
3	11570.00	51.8 PK	74.0	-22.2	1.49 H	334	37.8	14.0
4	11570.00	38.5 AV	54.0	-15.5	1.49 H	334	24.5	14.0
5	#17355.00	52.2 PK	74.0	-21.8	1.45 H	340	33.3	18.9
6	#17355.00	41.0 AV	54.0	-13.0	1.45 H	340	22.1	18.9

REMARKS:

1. Emission Level(dBuV/m) = Raw Value(dBuV) + Correction Factor(dB/m)
2. Correction Factor(dB/m) = Antenna Factor(dB/m) + Cable Factor(dB) – Pre-Amplifier Factor(dB)
3. The other emission levels were very low against the limit.
4. Margin value = Emission Level – Limit value
5. " * ": Fundamental frequency.
6. " # ": The radiated frequency is out of the restricted band.

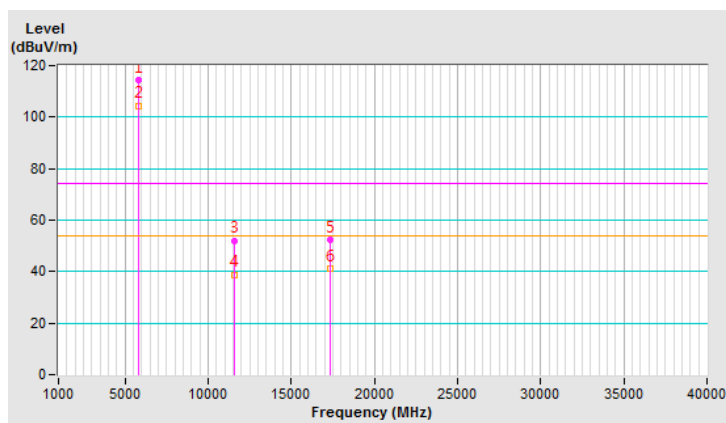

CHANNEL	TX Channel 157	DETECTOR FUNCTION	Peak (PK)
FREQUENCY RANGE	1GHz ~ 40GHz		Average (AV)

ANTENNA POLARITY & TEST DISTANCE: VERTICAL AT 3 M

NO.	FREQ. (MHz)	EMISSION LEVEL (dBuV/m)	LIMIT (dBuV/m)	MARGIN (dB)	ANTENNA HEIGHT (m)	TABLE ANGLE (Degree)	RAW VALUE (dBuV)	CORRECTION FACTOR (dB/m)
1	*5785.00	117.7 PK			2.43 V	121	112.7	5.0
2	*5785.00	107.5 AV			2.43 V	121	102.5	5.0
3	11570.00	53.4 PK	74.0	-20.6	1.70 V	291	39.4	14.0
4	11570.00	40.9 AV	54.0	-13.1	1.70 V	291	26.9	14.0
5	#17355.00	52.8 PK	74.0	-21.2	1.44 V	243	33.9	18.9
6	#17355.00	41.1 AV	54.0	-12.9	1.44 V	243	22.2	18.9

REMARKS:

1. Emission Level(dBuV/m) = Raw Value(dBuV) + Correction Factor(dB/m)
2. Correction Factor(dB/m) = Antenna Factor(dB/m) + Cable Factor(dB) – Pre-Amplifier Factor(dB)
3. The other emission levels were very low against the limit.
4. Margin value = Emission Level – Limit value
5. " * ": Fundamental frequency.
6. " # ": The radiated frequency is out of the restricted band.

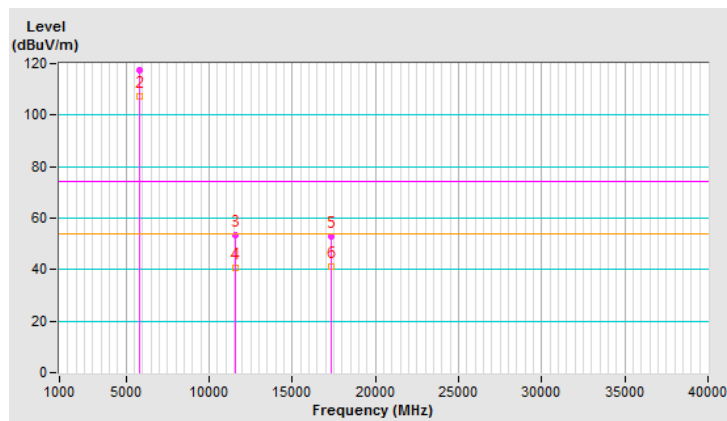

CHANNEL	TX Channel 165	DETECTOR FUNCTION	Peak (PK)
FREQUENCY RANGE	1GHz ~ 40GHz		Average (AV)

ANTENNA POLARITY & TEST DISTANCE: HORIZONTAL AT 3 M

NO.	FREQ. (MHz)	EMISSION LEVEL (dBuV/m)	LIMIT (dBuV/m)	MARGIN (dB)	ANTENNA HEIGHT (m)	TABLE ANGLE (Degree)	RAW VALUE (dBuV)	CORRECTION FACTOR (dB/m)
1	*5825.00	113.4 PK			1.30 H	193	108.2	5.2
2	*5825.00	103.3 AV			1.30 H	193	98.1	5.2
3	11650.00	51.9 PK	74.0	-22.1	1.50 H	320	37.8	14.1
4	11650.00	38.5 AV	54.0	-15.5	1.50 H	320	24.4	14.1
5	#17475.00	52.5 PK	74.0	-21.5	1.48 H	338	32.8	19.7
6	#17475.00	41.0 AV	54.0	-13.0	1.48 H	338	21.3	19.7

REMARKS:

1. Emission Level(dBuV/m) = Raw Value(dBuV) + Correction Factor(dB/m)
2. Correction Factor(dB/m) = Antenna Factor(dB/m) + Cable Factor(dB) – Pre-Amplifier Factor(dB)
3. The other emission levels were very low against the limit.
4. Margin value = Emission Level – Limit value
5. " * ": Fundamental frequency.
6. " # ": The radiated frequency is out of the restricted band.

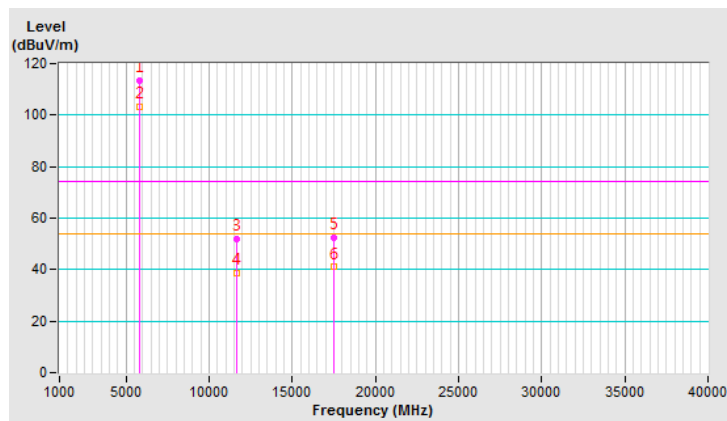

CHANNEL	TX Channel 165	DETECTOR FUNCTION	Peak (PK)
FREQUENCY RANGE	1GHz ~ 40GHz		Average (AV)

ANTENNA POLARITY & TEST DISTANCE: VERTICAL AT 3 M

NO.	FREQ. (MHz)	EMISSION LEVEL (dBuV/m)	LIMIT (dBuV/m)	MARGIN (dB)	ANTENNA HEIGHT (m)	TABLE ANGLE (Degree)	RAW VALUE (dBuV)	CORRECTION FACTOR (dB/m)
1	*5825.00	116.4 PK			2.01 V	133	111.2	5.2
2	*5825.00	106.7 AV			2.01 V	133	101.5	5.2
3	11650.00	52.7 PK	74.0	-21.3	1.61 V	268	38.6	14.1
4	11650.00	40.4 AV	54.0	-13.6	1.61 V	268	26.3	14.1
5	#17475.00	52.9 PK	74.0	-21.1	1.54 V	260	33.2	19.7
6	#17475.00	41.4 AV	54.0	-12.6	1.54 V	260	21.7	19.7

REMARKS:

1. Emission Level(dBuV/m) = Raw Value(dBuV) + Correction Factor(dB/m)
2. Correction Factor(dB/m) = Antenna Factor(dB/m) + Cable Factor(dB) – Pre-Amplifier Factor(dB)
3. The other emission levels were very low against the limit.
4. Margin value = Emission Level – Limit value
5. " * ": Fundamental frequency.
6. " # ": The radiated frequency is out of the restricted band.

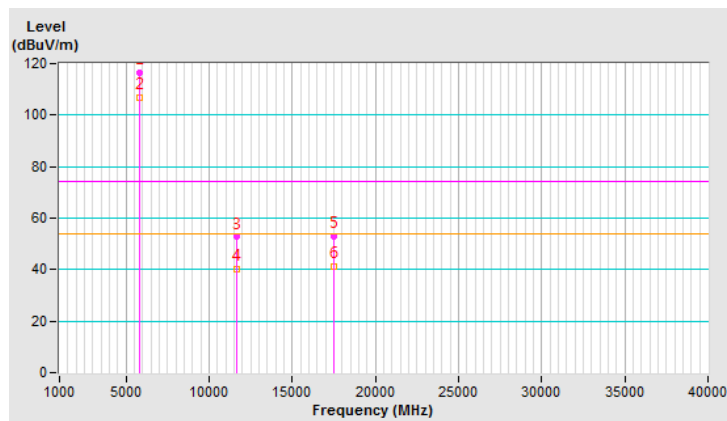

802.11ac (VHT20)

CHANNEL	TX Channel 36	DETECTOR FUNCTION	Peak (PK)
FREQUENCY RANGE	1GHz ~ 40GHz		Average (AV)

ANTENNA POLARITY & TEST DISTANCE: HORIZONTAL AT 3 M								
NO.	FREQ. (MHz)	EMISSION LEVEL (dBuV/m)	LIMIT (dBuV/m)	MARGIN (dB)	ANTENNA HEIGHT (m)	TABLE ANGLE (Degree)	RAW VALUE (dBuV)	CORRECTION FACTOR (dB/m)
1	5020.60	58.7 PK	74.0	-15.3	2.83 H	328	54.9	3.8
2	5020.60	50.3 AV	54.0	-3.7	2.83 H	328	46.5	3.8
3	5146.90	66.8 PK	74.0	-7.2	2.83 H	328	62.8	4.0
4	5146.90	52.7 AV	54.0	-1.3	2.83 H	328	48.7	4.0
5	*5180.00	108.9 PK			2.83 H	328	104.9	4.0
6	*5180.00	99.5 AV			2.83 H	328	95.5	4.0
7	#10360.00	50.2 PK	74.0	-23.8	1.49 H	253	36.6	13.6
8	#10360.00	37.2 AV	54.0	-16.8	1.49 H	253	23.6	13.6
9	15540.00	46.1 PK	74.0	-27.9	1.54 H	213	32.9	13.2
10	15540.00	34.6 AV	54.0	-19.4	1.54 H	213	21.4	13.2

REMARKS:

1. Emission Level(dBuV/m) = Raw Value(dBuV) + Correction Factor(dB/m)
2. Correction Factor(dB/m) = Antenna Factor(dB/m) + Cable Factor(dB) – Pre-Amplifier Factor(dB)
3. The other emission levels were very low against the limit.
4. Margin value = Emission Level – Limit value
5. " * ": Fundamental frequency.
6. " # ": The radiated frequency is out of the restricted band.

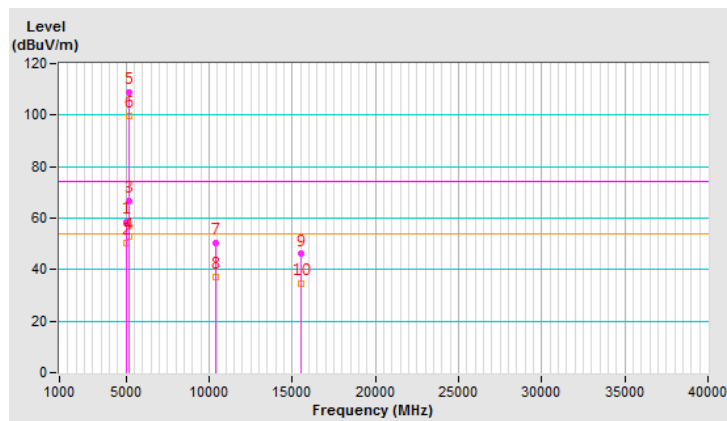

CHANNEL	TX Channel 36	DETECTOR FUNCTION	Peak (PK)
FREQUENCY RANGE	1GHz ~ 40GHz		Average (AV)

ANTENNA POLARITY & TEST DISTANCE: VERTICAL AT 3 M

NO.	FREQ. (MHz)	EMISSION LEVEL (dBuV/m)	LIMIT (dBuV/m)	MARGIN (dB)	ANTENNA HEIGHT (m)	TABLE ANGLE (Degree)	RAW VALUE (dBuV)	CORRECTION FACTOR (dB/m)
1	5020.60	60.6 PK	74.0	-13.4	2.46 V	96	56.8	3.8
2	5020.60	51.1 AV	54.0	-2.9	2.46 V	96	47.3	3.8
3	5146.90	68.7 PK	74.0	-5.3	1.50 V	82	64.7	4.0
4	5146.90	53.5 AV	54.0	-0.5	1.50 V	82	49.5	4.0
5	*5180.00	113.6 PK			1.50 V	82	109.6	4.0
6	*5180.00	103.2 AV			1.50 V	82	99.2	4.0
7	#10360.00	52.7 PK	74.0	-21.3	1.40 V	273	39.1	13.6
8	#10360.00	40.2 AV	54.0	-13.8	1.40 V	273	26.6	13.6
9	15540.00	46.5 PK	74.0	-27.5	1.53 V	132	33.3	13.2
10	15540.00	34.0 AV	54.0	-20.0	1.53 V	132	20.8	13.2

REMARKS:

1. Emission Level(dBuV/m) = Raw Value(dBuV) + Correction Factor(dB/m)
2. Correction Factor(dB/m) = Antenna Factor(dB/m) + Cable Factor(dB) – Pre-Amplifier Factor(dB)
3. The other emission levels were very low against the limit.
4. Margin value = Emission Level – Limit value
5. " * ": Fundamental frequency.
6. " # ": The radiated frequency is out of the restricted band.

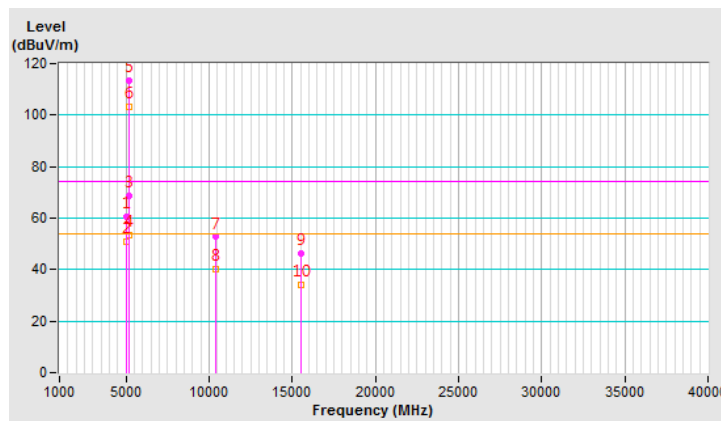

CHANNEL	TX Channel 40	DETECTOR FUNCTION	Peak (PK)
FREQUENCY RANGE	1GHz ~ 40GHz		Average (AV)

ANTENNA POLARITY & TEST DISTANCE: HORIZONTAL AT 3 M

NO.	FREQ. (MHz)	EMISSION LEVEL (dBuV/m)	LIMIT (dBuV/m)	MARGIN (dB)	ANTENNA HEIGHT (m)	TABLE ANGLE (Degree)	RAW VALUE (dBuV)	CORRECTION FACTOR (dB/m)
1	5040.70	57.9 PK	74.0	-16.1	2.83 H	339	54.0	3.9
2	5040.70	49.7 AV	54.0	-4.3	2.83 H	339	45.8	3.9
3	*5200.00	109.4 PK			2.83 H	339	105.4	4.0
4	*5200.00	100.7 AV			2.83 H	339	96.7	4.0
5	5361.20	59.8 PK	74.0	-14.2	2.83 H	339	55.4	4.4
6	5361.20	51.1 AV	54.0	-2.9	2.83 H	339	46.7	4.4
7	#10400.00	49.5 PK	74.0	-24.5	1.47 H	272	35.9	13.6
8	#10400.00	36.9 AV	54.0	-17.1	1.47 H	272	23.3	13.6
9	15600.00	46.3 PK	74.0	-27.7	1.49 H	216	32.9	13.4
10	15600.00	35.0 AV	54.0	-19.0	1.49 H	216	21.6	13.4

REMARKS:

1. Emission Level(dBuV/m) = Raw Value(dBuV) + Correction Factor(dB/m)
2. Correction Factor(dB/m) = Antenna Factor(dB/m) + Cable Factor(dB) – Pre-Amplifier Factor(dB)
3. The other emission levels were very low against the limit.
4. Margin value = Emission Level – Limit value
5. " * ": Fundamental frequency.
6. " # ": The radiated frequency is out of the restricted band.

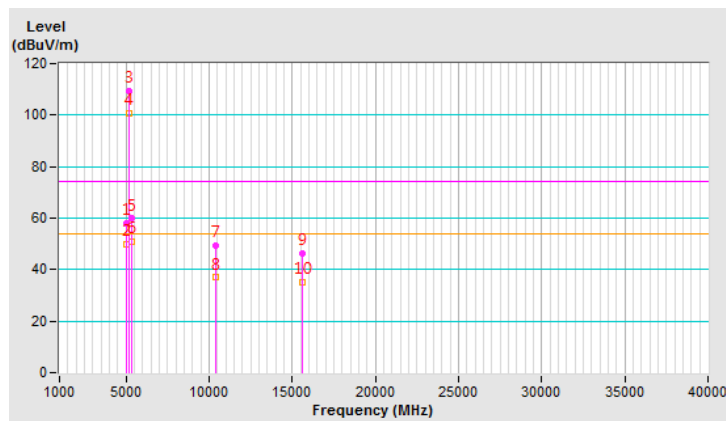

CHANNEL	TX Channel 40	DETECTOR FUNCTION	Peak (PK)
FREQUENCY RANGE	1GHz ~ 40GHz		Average (AV)

ANTENNA POLARITY & TEST DISTANCE: VERTICAL AT 3 M

NO.	FREQ. (MHz)	EMISSION LEVEL (dBuV/m)	LIMIT (dBuV/m)	MARGIN (dB)	ANTENNA HEIGHT (m)	TABLE ANGLE (Degree)	RAW VALUE (dBuV)	CORRECTION FACTOR (dB/m)
1	5040.70	59.7 PK	74.0	-14.3	2.57 V	97	55.8	3.9
2	5040.70	50.5 AV	54.0	-3.5	2.57 V	97	46.6	3.9
3	*5200.00	114.1 PK			2.57 V	162	110.1	4.0
4	*5200.00	104.4 AV			2.57 V	162	100.4	4.0
5	5361.20	61.7 PK	74.0	-12.3	2.57 V	162	57.3	4.4
6	5361.20	51.9 AV	54.0	-2.1	2.57 V	162	47.5	4.4
7	#10400.00	52.4 PK	74.0	-21.6	1.43 V	291	38.8	13.6
8	#10400.00	40.2 AV	54.0	-13.8	1.43 V	291	26.6	13.6
9	15600.00	46.3 PK	74.0	-27.7	1.48 V	103	32.9	13.4
10	15600.00	33.7 AV	54.0	-20.3	1.48 V	103	20.3	13.4

REMARKS:

1. Emission Level(dBuV/m) = Raw Value(dBuV) + Correction Factor(dB/m)
2. Correction Factor(dB/m) = Antenna Factor(dB/m) + Cable Factor(dB) – Pre-Amplifier Factor(dB)
3. The other emission levels were very low against the limit.
4. Margin value = Emission Level – Limit value
5. " * ": Fundamental frequency.
6. " # ": The radiated frequency is out of the restricted band.

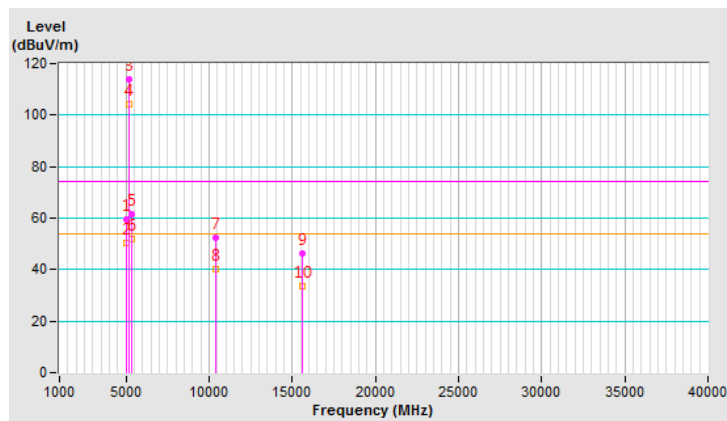

CHANNEL	TX Channel 48	DETECTOR FUNCTION	Peak (PK)
FREQUENCY RANGE	1GHz ~ 40GHz		Average (AV)

ANTENNA POLARITY & TEST DISTANCE: HORIZONTAL AT 3 M

NO.	FREQ. (MHz)	EMISSION LEVEL (dBuV/m)	LIMIT (dBuV/m)	MARGIN (dB)	ANTENNA HEIGHT (m)	TABLE ANGLE (Degree)	RAW VALUE (dBuV)	CORRECTION FACTOR (dB/m)
1	5080.80	54.9 PK	74.0	-19.1	2.84 H	333	51.0	3.9
2	5080.80	47.0 AV	54.0	-7.0	2.84 H	333	43.1	3.9
3	*5240.00	110.0 PK			2.84 H	333	105.8	4.2
4	*5240.00	100.2 AV			2.84 H	333	96.0	4.2
5	5401.40	59.5 PK	74.0	-14.5	2.84 H	333	55.1	4.4
6	5401.40	50.3 AV	54.0	-3.7	2.84 H	333	45.9	4.4
7	#10480.00	49.3 PK	74.0	-24.7	1.55 H	251	35.6	13.7
8	#10480.00	36.3 AV	54.0	-17.7	1.55 H	251	22.6	13.7
9	15720.00	46.9 PK	74.0	-27.1	1.47 H	221	32.9	14.0
10	15720.00	35.1 AV	54.0	-18.9	1.47 H	221	21.1	14.0

REMARKS:

1. Emission Level(dBuV/m) = Raw Value(dBuV) + Correction Factor(dB/m)
2. Correction Factor(dB/m) = Antenna Factor(dB/m) + Cable Factor(dB) – Pre-Amplifier Factor(dB)
3. The other emission levels were very low against the limit.
4. Margin value = Emission Level – Limit value
5. " * ": Fundamental frequency.
6. " # ": The radiated frequency is out of the restricted band.

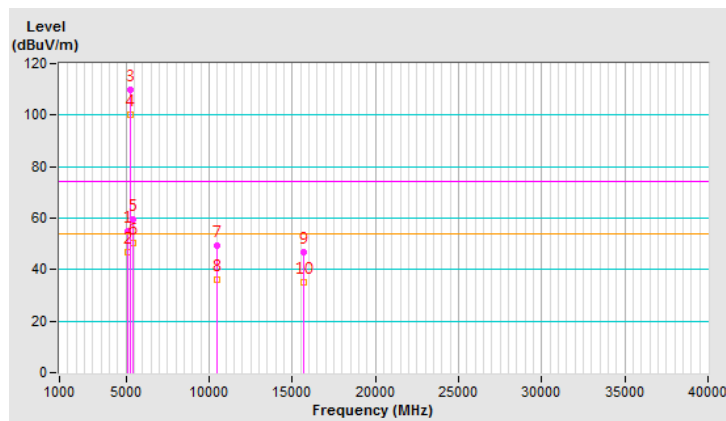

CHANNEL	TX Channel 48	DETECTOR FUNCTION	Peak (PK)
FREQUENCY RANGE	1GHz ~ 40GHz		Average (AV)

ANTENNA POLARITY & TEST DISTANCE: VERTICAL AT 3 M

NO.	FREQ. (MHz)	EMISSION LEVEL (dBuV/m)	LIMIT (dBuV/m)	MARGIN (dB)	ANTENNA HEIGHT (m)	TABLE ANGLE (Degree)	RAW VALUE (dBuV)	CORRECTION FACTOR (dB/m)
1	5080.80	56.8 PK	74.0	-17.2	2.57 V	160	52.9	3.9
2	5080.80	47.8 AV	54.0	-6.2	2.57 V	160	43.9	3.9
3	*5240.00	114.7 PK			2.57 V	160	110.5	4.2
4	*5240.00	103.9 AV			2.57 V	160	99.7	4.2
5	5401.40	61.4 PK	74.0	-12.6	2.57 V	160	57.0	4.4
6	5401.40	52.1 AV	54.0	-1.9	2.57 V	160	47.7	4.4
7	#10480.00	52.5 PK	74.0	-21.5	1.40 V	288	38.8	13.7
8	#10480.00	40.4 AV	54.0	-13.6	1.40 V	288	26.7	13.7
9	15720.00	47.1 PK	74.0	-26.9	1.54 V	105	33.1	14.0
10	15720.00	34.3 AV	54.0	-19.7	1.54 V	105	20.3	14.0

REMARKS:

1. Emission Level(dBuV/m) = Raw Value(dBuV) + Correction Factor(dB/m)
2. Correction Factor(dB/m) = Antenna Factor(dB/m) + Cable Factor(dB) – Pre-Amplifier Factor(dB)
3. The other emission levels were very low against the limit.
4. Margin value = Emission Level – Limit value
5. " * ": Fundamental frequency.
6. " # ": The radiated frequency is out of the restricted band.

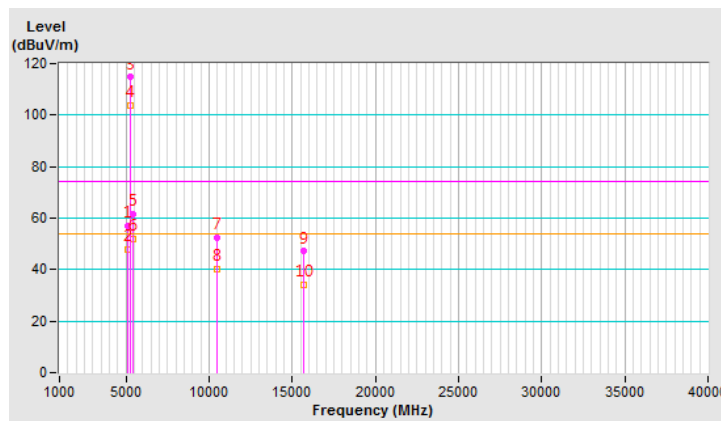

CHANNEL	TX Channel 149	DETECTOR FUNCTION	Peak (PK)
FREQUENCY RANGE	1GHz ~ 40GHz		Average (AV)

ANTENNA POLARITY & TEST DISTANCE: HORIZONTAL AT 3 M

NO.	FREQ. (MHz)	EMISSION LEVEL (dBuV/m)	LIMIT (dBuV/m)	MARGIN (dB)	ANTENNA HEIGHT (m)	TABLE ANGLE (Degree)	RAW VALUE (dBuV)	CORRECTION FACTOR (dB/m)
1	*5745.00	113.4 PK			1.39 H	187	108.4	5.0
2	*5745.00	102.9 AV			1.39 H	187	97.9	5.0
3	11490.00	51.7 PK	74.0	-22.3	1.52 H	328	37.6	14.1
4	11490.00	38.5 AV	54.0	-15.5	1.52 H	328	24.4	14.1
5	#17235.00	51.8 PK	74.0	-22.2	1.54 H	324	33.5	18.3
6	#17235.00	40.7 AV	54.0	-13.3	1.54 H	324	22.4	18.3

REMARKS:

1. Emission Level(dBuV/m) = Raw Value(dBuV) + Correction Factor(dB/m)
2. Correction Factor(dB/m) = Antenna Factor(dB/m) + Cable Factor(dB) – Pre-Amplifier Factor(dB)
3. The other emission levels were very low against the limit.
4. Margin value = Emission Level – Limit value
5. " * ": Fundamental frequency.
6. " # ": The radiated frequency is out of the restricted band.

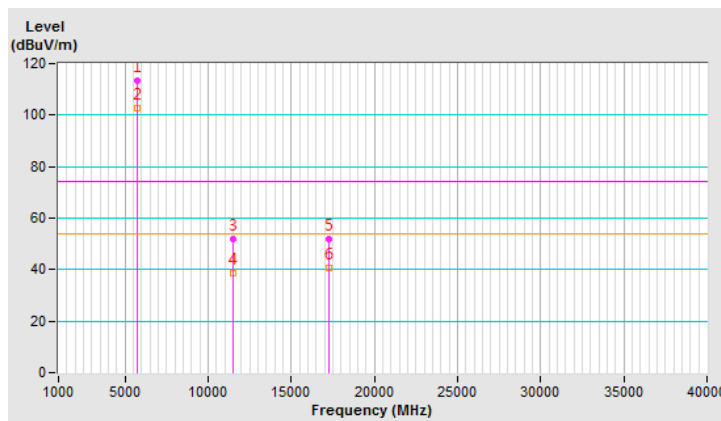

CHANNEL	TX Channel 149	DETECTOR FUNCTION	Peak (PK)
FREQUENCY RANGE	1GHz ~ 40GHz		Average (AV)

ANTENNA POLARITY & TEST DISTANCE: VERTICAL AT 3 M

NO.	FREQ. (MHz)	EMISSION LEVEL (dBuV/m)	LIMIT (dBuV/m)	MARGIN (dB)	ANTENNA HEIGHT (m)	TABLE ANGLE (Degree)	RAW VALUE (dBuV)	CORRECTION FACTOR (dB/m)
1	*5745.00	116.4 PK			2.24 V	128	111.4	5.0
2	*5745.00	106.2 AV			2.24 V	128	101.2	5.0
3	11490.00	53.4 PK	74.0	-20.6	1.60 V	280	39.3	14.1
4	11490.00	41.1 AV	54.0	-12.9	1.60 V	280	27.0	14.1
5	#17235.00	52.5 PK	74.0	-21.5	1.45 V	251	34.2	18.3
6	#17235.00	40.8 AV	54.0	-13.2	1.45 V	251	22.5	18.3

REMARKS:

1. Emission Level(dBuV/m) = Raw Value(dBuV) + Correction Factor(dB/m)
2. Correction Factor(dB/m) = Antenna Factor(dB/m) + Cable Factor(dB) – Pre-Amplifier Factor(dB)
3. The other emission levels were very low against the limit.
4. Margin value = Emission Level – Limit value
5. " * ": Fundamental frequency.
6. " # ": The radiated frequency is out of the restricted band.

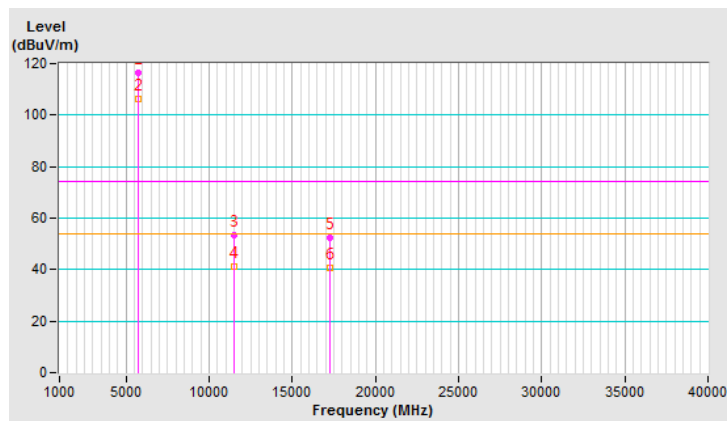

CHANNEL	TX Channel 157	DETECTOR FUNCTION	Peak (PK)
FREQUENCY RANGE	1GHz ~ 40GHz		Average (AV)

ANTENNA POLARITY & TEST DISTANCE: HORIZONTAL AT 3 M

NO.	FREQ. (MHz)	EMISSION LEVEL (dBuV/m)	LIMIT (dBuV/m)	MARGIN (dB)	ANTENNA HEIGHT (m)	TABLE ANGLE (Degree)	RAW VALUE (dBuV)	CORRECTION FACTOR (dB/m)
1	*5785.00	112.9 PK			1.42 H	189	107.9	5.0
2	*5785.00	102.5 AV			1.42 H	189	97.5	5.0
3	11570.00	50.9 PK	74.0	-23.1	1.57 H	342	36.9	14.0
4	11570.00	38.0 AV	54.0	-16.0	1.57 H	342	24.0	14.0
5	#17355.00	52.6 PK	74.0	-21.4	1.47 H	326	33.7	18.9
6	#17355.00	41.3 AV	54.0	-12.7	1.47 H	326	22.4	18.9

REMARKS:

1. Emission Level(dBuV/m) = Raw Value(dBuV) + Correction Factor(dB/m)
2. Correction Factor(dB/m) = Antenna Factor(dB/m) + Cable Factor(dB) – Pre-Amplifier Factor(dB)
3. The other emission levels were very low against the limit.
4. Margin value = Emission Level – Limit value
5. " * ": Fundamental frequency.
6. " # ": The radiated frequency is out of the restricted band.

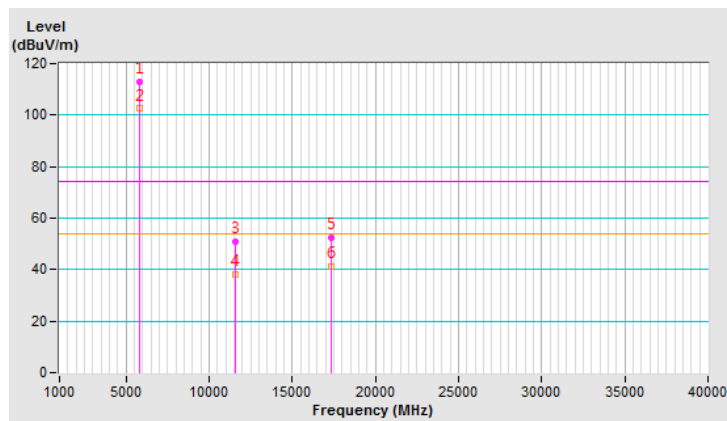

CHANNEL	TX Channel 157	DETECTOR FUNCTION	Peak (PK)
FREQUENCY RANGE	1GHz ~ 40GHz		Average (AV)

ANTENNA POLARITY & TEST DISTANCE: VERTICAL AT 3 M

NO.	FREQ. (MHz)	EMISSION LEVEL (dBuV/m)	LIMIT (dBuV/m)	MARGIN (dB)	ANTENNA HEIGHT (m)	TABLE ANGLE (Degree)	RAW VALUE (dBuV)	CORRECTION FACTOR (dB/m)
1	*5785.00	115.7 PK			2.46 V	92	110.7	5.0
2	*5785.00	105.9 AV			2.46 V	92	100.9	5.0
3	11570.00	53.2 PK	74.0	-20.8	1.63 V	263	39.2	14.0
4	11570.00	40.7 AV	54.0	-13.3	1.63 V	263	26.7	14.0
5	#17355.00	52.1 PK	74.0	-21.9	1.44 V	261	33.2	18.9
6	#17355.00	40.8 AV	54.0	-13.2	1.44 V	261	21.9	18.9

REMARKS:

1. Emission Level(dBuV/m) = Raw Value(dBuV) + Correction Factor(dB/m)
2. Correction Factor(dB/m) = Antenna Factor(dB/m) + Cable Factor(dB) – Pre-Amplifier Factor(dB)
3. The other emission levels were very low against the limit.
4. Margin value = Emission Level – Limit value
5. " * ": Fundamental frequency.
6. " # ": The radiated frequency is out of the restricted band.

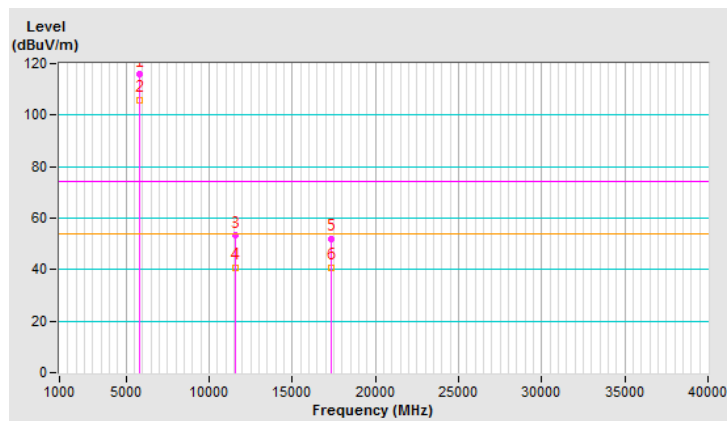

CHANNEL	TX Channel 165	DETECTOR FUNCTION	Peak (PK)
FREQUENCY RANGE	1GHz ~ 40GHz		Average (AV)

ANTENNA POLARITY & TEST DISTANCE: HORIZONTAL AT 3 M

NO.	FREQ. (MHz)	EMISSION LEVEL (dBuV/m)	LIMIT (dBuV/m)	MARGIN (dB)	ANTENNA HEIGHT (m)	TABLE ANGLE (Degree)	RAW VALUE (dBuV)	CORRECTION FACTOR (dB/m)
1	*5825.00	112.8 PK			1.42 H	189	107.6	5.2
2	*5825.00	102.4 AV			1.42 H	189	97.2	5.2
3	11650.00	51.2 PK	74.0	-22.8	1.51 H	324	37.1	14.1
4	11650.00	38.3 AV	54.0	-15.7	1.51 H	324	24.2	14.1
5	#17475.00	52.3 PK	74.0	-21.7	1.52 H	335	32.6	19.7
6	#17475.00	41.0 AV	54.0	-13.0	1.52 H	335	21.3	19.7

REMARKS:

1. Emission Level(dBuV/m) = Raw Value(dBuV) + Correction Factor(dB/m)
2. Correction Factor(dB/m) = Antenna Factor(dB/m) + Cable Factor(dB) – Pre-Amplifier Factor(dB)
3. The other emission levels were very low against the limit.
4. Margin value = Emission Level – Limit value
5. " * ": Fundamental frequency.
6. " # ": The radiated frequency is out of the restricted band.

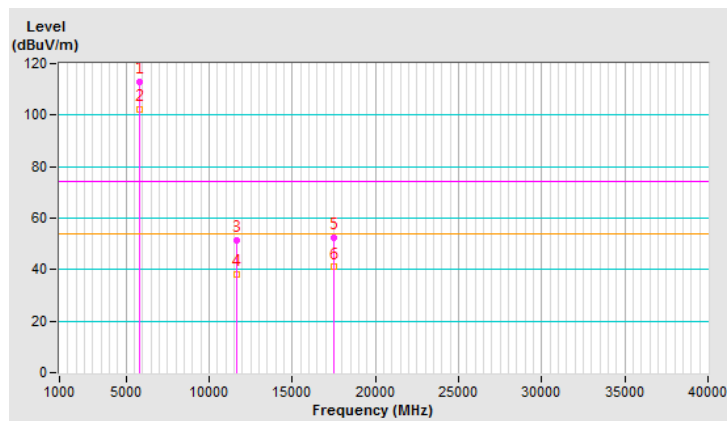

CHANNEL	TX Channel 165	DETECTOR FUNCTION	Peak (PK)
FREQUENCY RANGE	1GHz ~ 40GHz		Average (AV)

ANTENNA POLARITY & TEST DISTANCE: VERTICAL AT 3 M

NO.	FREQ. (MHz)	EMISSION LEVEL (dBuV/m)	LIMIT (dBuV/m)	MARGIN (dB)	ANTENNA HEIGHT (m)	TABLE ANGLE (Degree)	RAW VALUE (dBuV)	CORRECTION FACTOR (dB/m)
1	*5825.00	115.8 PK			2.70 V	80	110.6	5.2
2	*5825.00	105.6 AV			2.70 V	80	100.4	5.2
3	11650.00	53.5 PK	74.0	-20.5	1.65 V	289	39.4	14.1
4	11650.00	41.1 AV	54.0	-12.9	1.65 V	289	27.0	14.1
5	#17475.00	53.1 PK	74.0	-20.9	1.55 V	244	33.4	19.7
6	#17475.00	41.2 AV	54.0	-12.8	1.55 V	244	21.5	19.7

REMARKS:

1. Emission Level(dBuV/m) = Raw Value(dBuV) + Correction Factor(dB/m)
2. Correction Factor(dB/m) = Antenna Factor(dB/m) + Cable Factor(dB) – Pre-Amplifier Factor(dB)
3. The other emission levels were very low against the limit.
4. Margin value = Emission Level – Limit value
5. " * ": Fundamental frequency.
6. " # ": The radiated frequency is out of the restricted band.

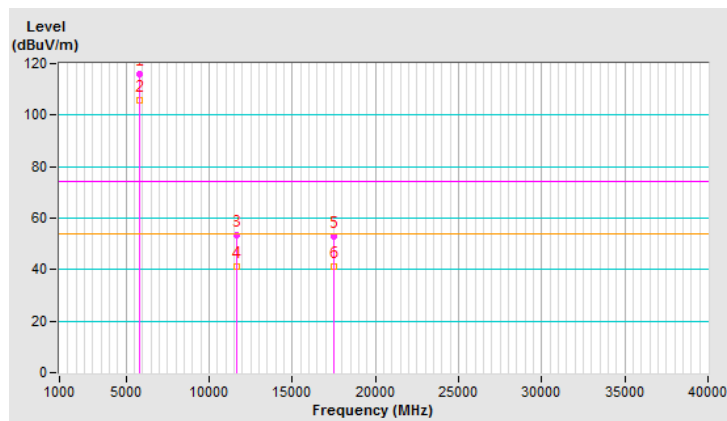

802.11ac (VHT40)

CHANNEL	TX Channel 38	DETECTOR FUNCTION	Peak (PK)
FREQUENCY RANGE	1GHz ~ 40GHz		Average (AV)

ANTENNA POLARITY & TEST DISTANCE: HORIZONTAL AT 3 M								
NO.	FREQ. (MHz)	EMISSION LEVEL (dBuV/m)	LIMIT (dBuV/m)	MARGIN (dB)	ANTENNA HEIGHT (m)	TABLE ANGLE (Degree)	RAW VALUE (dBuV)	CORRECTION FACTOR (dB/m)
1	5146.20	65.8 PK	74.0	-8.2	2.85 H	328	61.8	4.0
2	5146.20	52.9 AV	54.0	-1.1	2.85 H	328	48.9	4.0
3	*5190.00	103.3 PK			2.85 H	328	99.3	4.0
4	*5190.00	94.5 AV			2.85 H	328	90.5	4.0
5	5357.10	54.3 PK	74.0	-19.7	2.85 H	328	49.9	4.4
6	5357.10	45.2 AV	54.0	-8.8	2.85 H	328	40.8	4.4
7	#10380.00	48.8 PK	74.0	-25.2	1.52 H	241	35.2	13.6
8	#10380.00	36.2 AV	54.0	-17.8	1.52 H	241	22.6	13.6
9	15570.00	47.2 PK	74.0	-26.8	1.48 H	220	33.9	13.3
10	15570.00	35.6 AV	54.0	-18.4	1.48 H	220	22.3	13.3

REMARKS:

1. Emission Level(dBuV/m) = Raw Value(dBuV) + Correction Factor(dB/m)
2. Correction Factor(dB/m) = Antenna Factor(dB/m) + Cable Factor(dB) – Pre-Amplifier Factor(dB)
3. The other emission levels were very low against the limit.
4. Margin value = Emission Level – Limit value
5. " * ": Fundamental frequency.
6. " # ": The radiated frequency is out of the restricted band.

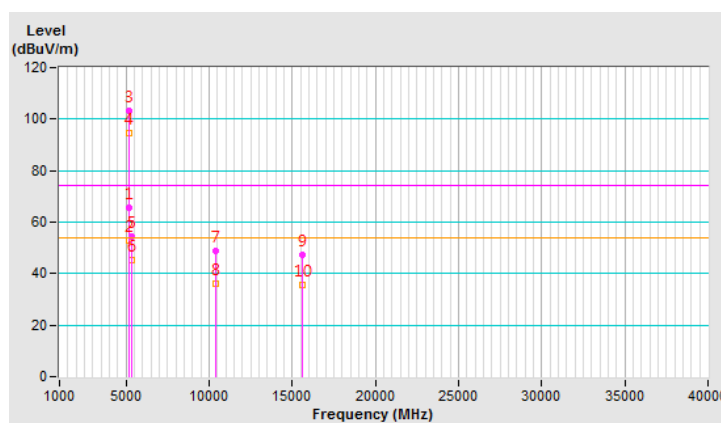

CHANNEL	TX Channel 38	DETECTOR FUNCTION	Peak (PK)
FREQUENCY RANGE	1GHz ~ 40GHz		Average (AV)

ANTENNA POLARITY & TEST DISTANCE: VERTICAL AT 3 M

NO.	FREQ. (MHz)	EMISSION LEVEL (dBuV/m)	LIMIT (dBuV/m)	MARGIN (dB)	ANTENNA HEIGHT (m)	TABLE ANGLE (Degree)	RAW VALUE (dBuV)	CORRECTION FACTOR (dB/m)
1	5146.20	67.7 PK	74.0	-6.3	2.65 V	92	63.7	4.0
2	5146.20	53.9 AV	54.0	-0.1	2.65 V	92	49.9	4.0
3	*5190.00	108.0 PK			2.65 V	92	104.0	4.0
4	*5190.00	98.2 AV			2.65 V	92	94.2	4.0
5	5357.10	56.2 PK	74.0	-17.8	2.65 V	147	51.8	4.4
6	5357.10	46.0 AV	54.0	-8.0	2.65 V	147	41.6	4.4
7	#10380.00	52.6 PK	74.0	-21.4	1.51 V	284	39.0	13.6
8	#10380.00	40.4 AV	54.0	-13.6	1.51 V	284	26.8	13.6
9	15570.00	46.2 PK	74.0	-27.8	1.55 V	119	32.9	13.3
10	15570.00	33.5 AV	54.0	-20.5	1.55 V	119	20.2	13.3

REMARKS:

1. Emission Level(dBuV/m) = Raw Value(dBuV) + Correction Factor(dB/m)
2. Correction Factor(dB/m) = Antenna Factor(dB/m) + Cable Factor(dB) – Pre-Amplifier Factor(dB)
3. The other emission levels were very low against the limit.
4. Margin value = Emission Level – Limit value
5. " * ": Fundamental frequency.
6. " # ": The radiated frequency is out of the restricted band.

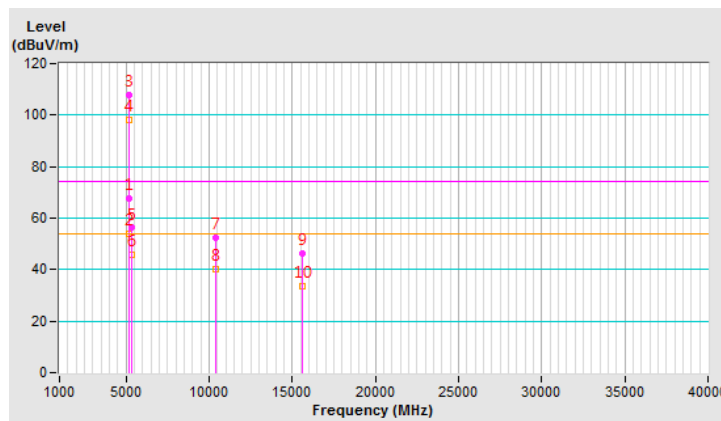

CHANNEL	TX Channel 46	DETECTOR FUNCTION	Peak (PK)
FREQUENCY RANGE	1GHz ~ 40GHz		Average (AV)

ANTENNA POLARITY & TEST DISTANCE: HORIZONTAL AT 3 M

NO.	FREQ. (MHz)	EMISSION LEVEL (dBuV/m)	LIMIT (dBuV/m)	MARGIN (dB)	ANTENNA HEIGHT (m)	TABLE ANGLE (Degree)	RAW VALUE (dBuV)	CORRECTION FACTOR (dB/m)
1	5065.50	56.2 PK	74.0	-17.8	2.86 H	314	52.3	3.9
2	5065.50	48.8 AV	54.0	-5.2	2.86 H	314	44.9	3.9
3	5145.90	59.6 PK	74.0	-14.4	2.86 H	314	55.6	4.0
4	5145.90	48.0 AV	54.0	-6.0	2.86 H	314	44.0	4.0
5	*5230.00	107.6 PK			2.86 H	314	103.4	4.2
6	*5230.00	98.9 AV			2.86 H	314	94.7	4.2
7	5387.10	57.6 PK	74.0	-16.4	2.86 H	314	53.2	4.4
8	5387.10	50.3 AV	54.0	-3.7	2.86 H	314	45.9	4.4
9	#10460.00	49.2 PK	74.0	-24.8	1.51 H	266	35.5	13.7
10	#10460.00	36.4 AV	54.0	-17.6	1.51 H	266	22.7	13.7
11	15690.00	46.4 PK	74.0	-27.6	1.52 H	238	32.4	14.0
12	15690.00	34.8 AV	54.0	-19.2	1.52 H	238	20.8	14.0

REMARKS:

1. Emission Level(dBuV/m) = Raw Value(dBuV) + Correction Factor(dB/m)
2. Correction Factor(dB/m) = Antenna Factor(dB/m) + Cable Factor(dB) – Pre-Amplifier Factor(dB)
3. The other emission levels were very low against the limit.
4. Margin value = Emission Level – Limit value
5. " * ": Fundamental frequency.
6. " # ": The radiated frequency is out of the restricted band.

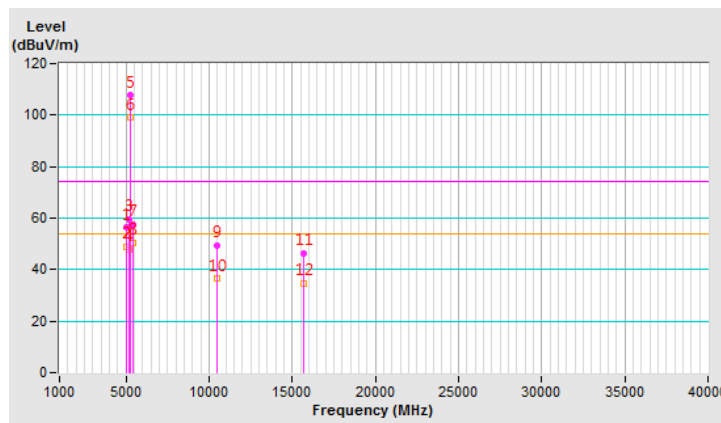

CHANNEL	TX Channel 46	DETECTOR FUNCTION	Peak (PK)
FREQUENCY RANGE	1GHz ~ 40GHz		Average (AV)

ANTENNA POLARITY & TEST DISTANCE: VERTICAL AT 3 M

NO.	FREQ. (MHz)	EMISSION LEVEL (dBuV/m)	LIMIT (dBuV/m)	MARGIN (dB)	ANTENNA HEIGHT (m)	TABLE ANGLE (Degree)	RAW VALUE (dBuV)	CORRECTION FACTOR (dB/m)
1	5065.50	58.1 PK	74.0	-15.9	2.55 V	99	54.2	3.9
2	5065.50	49.6 AV	54.0	-4.4	2.55 V	99	45.7	3.9
3	5145.90	61.5 PK	74.0	-12.5	2.55 V	90	57.5	4.0
4	5145.90	48.8 AV	54.0	-5.2	2.55 V	90	44.8	4.0
5	*5230.00	112.3 PK			2.55 V	90	108.1	4.2
6	*5230.00	102.6 AV			2.55 V	90	98.4	4.2
7	5387.10	59.5 PK	74.0	-14.5	2.55 V	90	55.1	4.4
8	5387.10	51.1 AV	54.0	-2.9	2.55 V	90	46.7	4.4
9	#10460.00	52.3 PK	74.0	-21.7	1.46 V	277	38.6	13.7
10	#10460.00	40.3 AV	54.0	-13.7	1.46 V	277	26.6	13.7
11	15690.00	46.1 PK	74.0	-27.9	1.47 V	125	32.1	14.0
12	15690.00	33.7 AV	54.0	-20.3	1.47 V	125	19.7	14.0

REMARKS:

1. Emission Level(dBuV/m) = Raw Value(dBuV) + Correction Factor(dB/m)
2. Correction Factor(dB/m) = Antenna Factor(dB/m) + Cable Factor(dB) – Pre-Amplifier Factor(dB)
3. The other emission levels were very low against the limit.
4. Margin value = Emission Level – Limit value
5. " * ": Fundamental frequency.
6. " # ": The radiated frequency is out of the restricted band.

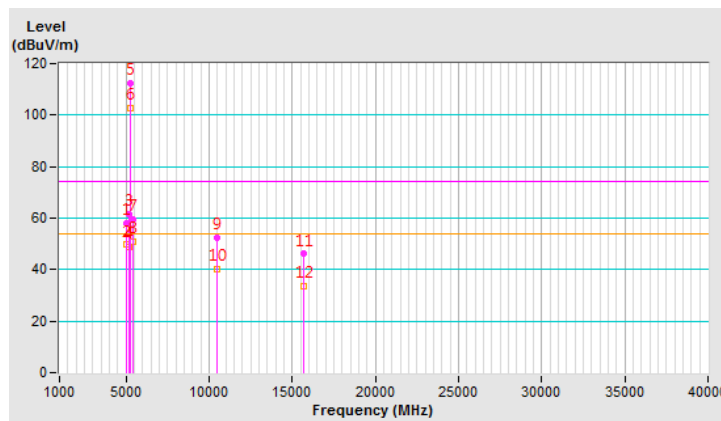

CHANNEL	TX Channel 151	DETECTOR FUNCTION	Peak (PK)
FREQUENCY RANGE	1GHz ~ 40GHz		Average (AV)

ANTENNA POLARITY & TEST DISTANCE: HORIZONTAL AT 3 M

NO.	FREQ. (MHz)	EMISSION LEVEL (dBuV/m)	LIMIT (dBuV/m)	MARGIN (dB)	ANTENNA HEIGHT (m)	TABLE ANGLE (Degree)	RAW VALUE (dBuV)	CORRECTION FACTOR (dB/m)
1	*5755.00	110.2 PK			1.36 H	192	105.2	5.0
2	*5755.00	100.3 AV			1.36 H	192	95.3	5.0
3	11510.00	49.2 PK	74.0	-24.8	1.48 H	243	35.2	14.0
4	11510.00	36.7 AV	54.0	-17.3	1.48 H	243	22.7	14.0
5	#17265.00	46.7 PK	74.0	-27.3	1.54 H	223	28.2	18.5
6	#17265.00	35.1 AV	54.0	-18.9	1.54 H	223	16.6	18.5

REMARKS:

1. Emission Level(dBuV/m) = Raw Value(dBuV) + Correction Factor(dB/m)
2. Correction Factor(dB/m) = Antenna Factor(dB/m) + Cable Factor(dB) – Pre-Amplifier Factor(dB)
3. The other emission levels were very low against the limit.
4. Margin value = Emission Level – Limit value
5. " * ": Fundamental frequency.
6. " # ": The radiated frequency is out of the restricted band.

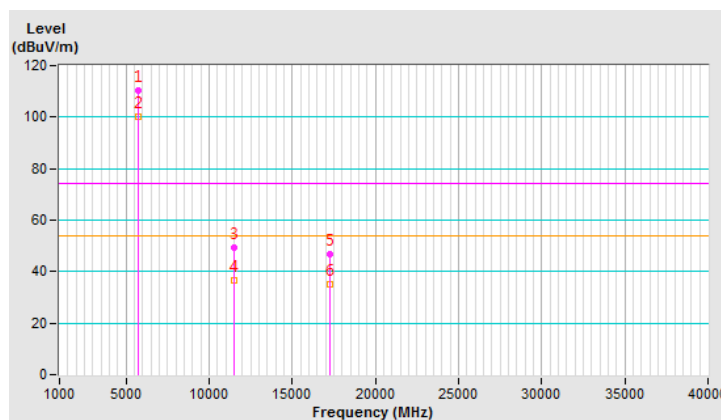

CHANNEL	TX Channel 151	DETECTOR FUNCTION	Peak (PK)
FREQUENCY RANGE	1GHz ~ 40GHz		Average (AV)

ANTENNA POLARITY & TEST DISTANCE: VERTICAL AT 3 M

NO.	FREQ. (MHz)	EMISSION LEVEL (dBuV/m)	LIMIT (dBuV/m)	MARGIN (dB)	ANTENNA HEIGHT (m)	TABLE ANGLE (Degree)	RAW VALUE (dBuV)	CORRECTION FACTOR (dB/m)
1	*5755.00	113.4 PK			2.67 V	100	108.4	5.0
2	*5755.00	104.2 AV			2.67 V	100	99.2	5.0
3	11510.00	52.4 PK	74.0	-21.6	1.62 V	267	38.4	14.0
4	11510.00	40.3 AV	54.0	-13.7	1.62 V	267	26.3	14.0
5	#17265.00	53.2 PK	74.0	-20.8	1.47 V	270	34.7	18.5
6	#17265.00	41.6 AV	54.0	-12.4	1.47 V	270	23.1	18.5

REMARKS:

1. Emission Level(dBuV/m) = Raw Value(dBuV) + Correction Factor(dB/m)
2. Correction Factor(dB/m) = Antenna Factor(dB/m) + Cable Factor(dB) – Pre-Amplifier Factor(dB)
3. The other emission levels were very low against the limit.
4. Margin value = Emission Level – Limit value
5. " * ": Fundamental frequency.
6. " # ": The radiated frequency is out of the restricted band.

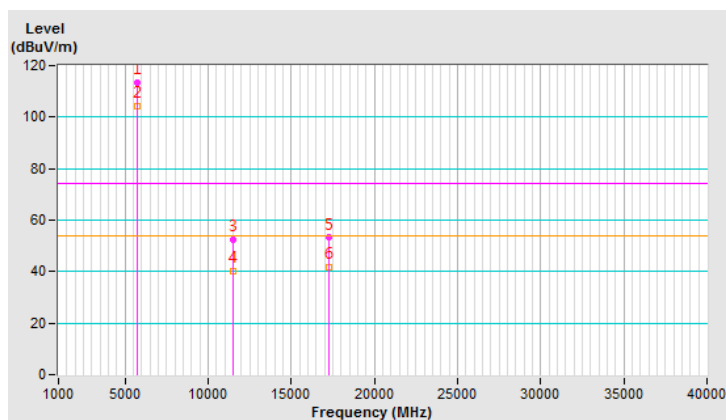

CHANNEL	TX Channel 159	DETECTOR FUNCTION	Peak (PK)
FREQUENCY RANGE	1GHz ~ 40GHz		Average (AV)

ANTENNA POLARITY & TEST DISTANCE: HORIZONTAL AT 3 M

NO.	FREQ. (MHz)	EMISSION LEVEL (dBuV/m)	LIMIT (dBuV/m)	MARGIN (dB)	ANTENNA HEIGHT (m)	TABLE ANGLE (Degree)	RAW VALUE (dBuV)	CORRECTION FACTOR (dB/m)
1	*5795.00	109.1 PK			1.50 H	181	104.0	5.1
2	*5795.00	99.5 AV			1.50 H	181	94.4	5.1
3	11590.00	49.8 PK	74.0	-24.2	1.45 H	258	35.8	14.0
4	11590.00	37.0 AV	54.0	-17.0	1.45 H	258	23.0	14.0
5	#17385.00	46.7 PK	74.0	-27.3	1.56 H	211	27.6	19.1
6	#17385.00	35.1 AV	54.0	-18.9	1.56 H	211	16.0	19.1

REMARKS:

1. Emission Level(dBuV/m) = Raw Value(dBuV) + Correction Factor(dB/m)
2. Correction Factor(dB/m) = Antenna Factor(dB/m) + Cable Factor(dB) – Pre-Amplifier Factor(dB)
3. The other emission levels were very low against the limit.
4. Margin value = Emission Level – Limit value
5. " * ": Fundamental frequency.
6. " # ": The radiated frequency is out of the restricted band.

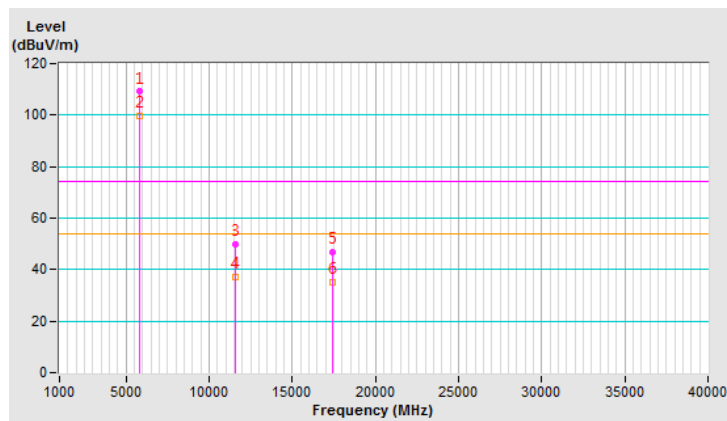

CHANNEL	TX Channel 159	DETECTOR FUNCTION	Peak (PK)
FREQUENCY RANGE	1GHz ~ 40GHz		Average (AV)

ANTENNA POLARITY & TEST DISTANCE: VERTICAL AT 3 M

NO.	FREQ. (MHz)	EMISSION LEVEL (dBuV/m)	LIMIT (dBuV/m)	MARGIN (dB)	ANTENNA HEIGHT (m)	TABLE ANGLE (Degree)	RAW VALUE (dBuV)	CORRECTION FACTOR (dB/m)
1	*5795.00	112.6 PK			1.50 V	65	107.5	5.1
2	*5795.00	103.4 AV			1.50 V	65	98.3	5.1
3	11590.00	52.9 PK	74.0	-21.1	1.67 V	277	38.9	14.0
4	11590.00	40.6 AV	54.0	-13.4	1.67 V	277	26.6	14.0
5	#17385.00	52.8 PK	74.0	-21.2	1.52 V	262	33.7	19.1
6	#17385.00	41.0 AV	54.0	-13.0	1.52 V	262	21.9	19.1

REMARKS:

1. Emission Level(dBuV/m) = Raw Value(dBuV) + Correction Factor(dB/m)
2. Correction Factor(dB/m) = Antenna Factor(dB/m) + Cable Factor(dB) – Pre-Amplifier Factor(dB)
3. The other emission levels were very low against the limit.
4. Margin value = Emission Level – Limit value
5. " * ": Fundamental frequency.
6. " # ": The radiated frequency is out of the restricted band.

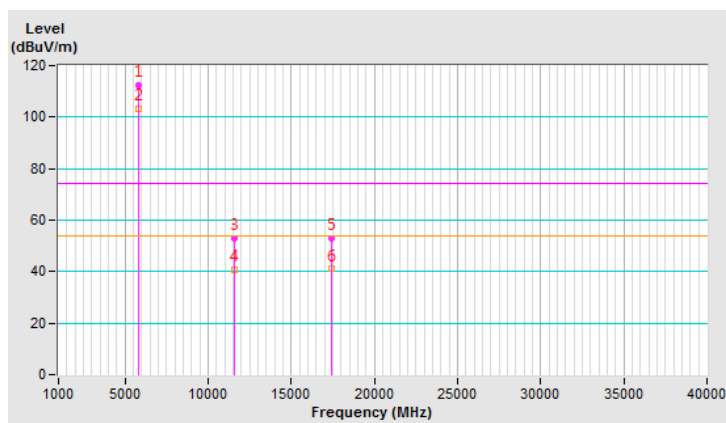

802.11ac (VHT80)

CHANNEL	TX Channel 42	DETECTOR FUNCTION	Peak (PK)
FREQUENCY RANGE	1GHz ~ 40GHz		Average (AV)

ANTENNA POLARITY & TEST DISTANCE: HORIZONTAL AT 3 M								
NO.	FREQ. (MHz)	EMISSION LEVEL (dBuV/m)	LIMIT (dBuV/m)	MARGIN (dB)	ANTENNA HEIGHT (m)	TABLE ANGLE (Degree)	RAW VALUE (dBuV)	CORRECTION FACTOR (dB/m)
1	5147.10	64.5 PK	74.0	-9.5	2.87 H	317	60.5	4.0
2	5147.10	53.0 AV	54.0	-1.0	2.87 H	317	49.0	4.0
3	*5210.00	101.1 PK			2.87 H	317	97.0	4.1
4	*5210.00	93.0 AV			2.87 H	317	88.9	4.1
5	5357.00	51.6 PK	74.0	-22.4	2.87 H	317	47.2	4.4
6	5357.00	43.5 AV	54.0	-10.5	2.87 H	317	39.1	4.4
7	#10420.00	50.0 PK	74.0	-24.0	1.52 H	250	36.4	13.6
8	#10420.00	37.1 AV	54.0	-16.9	1.52 H	250	23.5	13.6
9	15630.00	46.8 PK	74.0	-27.2	1.54 H	212	33.2	13.6
10	15630.00	35.2 AV	54.0	-18.8	1.54 H	212	21.6	13.6

REMARKS:

1. Emission Level(dBuV/m) = Raw Value(dBuV) + Correction Factor(dB/m)
2. Correction Factor(dB/m) = Antenna Factor(dB/m) + Cable Factor(dB) – Pre-Amplifier Factor(dB)
3. The other emission levels were very low against the limit.
4. Margin value = Emission Level – Limit value
5. " * ": Fundamental frequency.
6. " # ": The radiated frequency is out of the restricted band.

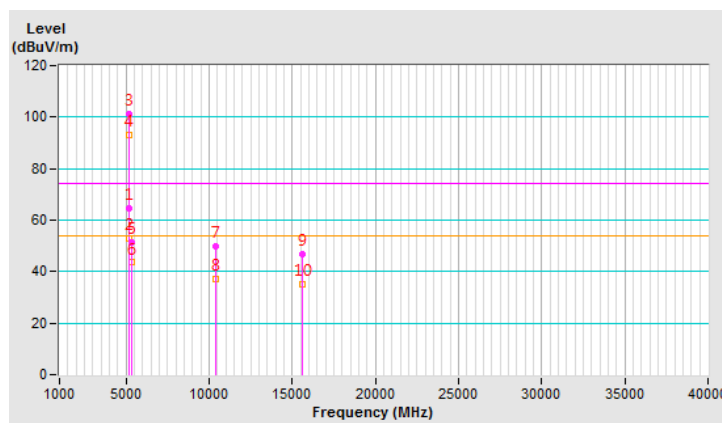

CHANNEL	TX Channel 42	DETECTOR FUNCTION	Peak (PK)
FREQUENCY RANGE	1GHz ~ 40GHz		Average (AV)

ANTENNA POLARITY & TEST DISTANCE: VERTICAL AT 3 M

NO.	FREQ. (MHz)	EMISSION LEVEL (dBuV/m)	LIMIT (dBuV/m)	MARGIN (dB)	ANTENNA HEIGHT (m)	TABLE ANGLE (Degree)	RAW VALUE (dBuV)	CORRECTION FACTOR (dB/m)
1	5147.10	66.4 PK	74.0	-7.6	1.50 V	85	62.4	4.0
2	5147.10	53.9 AV	54.0	-0.1	1.50 V	85	49.9	4.0
3	*5210.00	105.8 PK			1.50 V	85	101.7	4.1
4	*5210.00	96.7 AV			1.50 V	85	92.6	4.1
5	5357.00	53.5 PK	74.0	-20.5	1.50 V	85	49.1	4.4
6	5357.00	44.3 AV	54.0	-9.7	1.50 V	85	39.9	4.4
7	#10420.00	52.2 PK	74.0	-21.8	1.46 V	283	38.6	13.6
8	#10420.00	39.9 AV	54.0	-14.1	1.46 V	283	26.3	13.6
9	15630.00	46.0 PK	74.0	-28.0	1.47 V	132	32.4	13.6
10	15630.00	33.7 AV	54.0	-20.3	1.47 V	132	20.1	13.6

REMARKS:

1. Emission Level(dBuV/m) = Raw Value(dBuV) + Correction Factor(dB/m)
2. Correction Factor(dB/m) = Antenna Factor(dB/m) + Cable Factor(dB) – Pre-Amplifier Factor(dB)
3. The other emission levels were very low against the limit.
4. Margin value = Emission Level – Limit value
5. " * ": Fundamental frequency.
6. " # ": The radiated frequency is out of the restricted band.

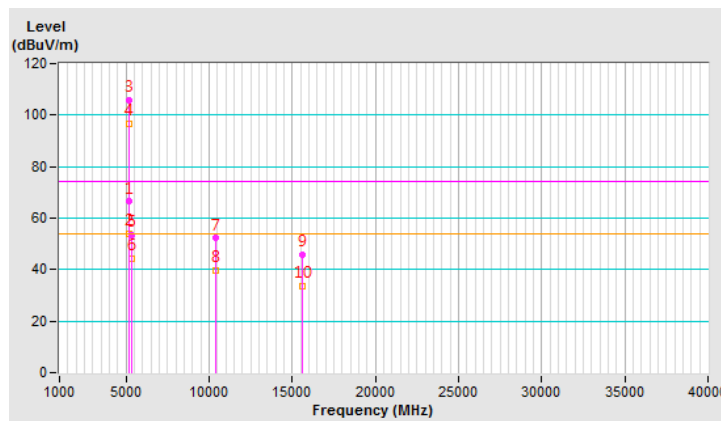

CHANNEL	TX Channel 155	DETECTOR FUNCTION	Peak (PK)
FREQUENCY RANGE	1GHz ~ 40GHz		Average (AV)

ANTENNA POLARITY & TEST DISTANCE: HORIZONTAL AT 3 M

NO.	FREQ. (MHz)	EMISSION LEVEL (dBuV/m)	LIMIT (dBuV/m)	MARGIN (dB)	ANTENNA HEIGHT (m)	TABLE ANGLE (Degree)	RAW VALUE (dBuV)	CORRECTION FACTOR (dB/m)
1	*5775.00	104.6 PK			1.50 H	177	99.6	5.0
2	*5775.00	96.4 AV			1.50 H	177	91.4	5.0
3	11550.00	48.8 PK	74.0	-25.2	1.49 H	263	34.8	14.0
4	11550.00	36.3 AV	54.0	-17.7	1.49 H	263	22.3	14.0
5	#17325.00	47.0 PK	74.0	-27.0	1.47 H	230	28.4	18.6
6	#17325.00	35.5 AV	54.0	-18.5	1.47 H	230	16.9	18.6

REMARKS:

1. Emission Level(dBuV/m) = Raw Value(dBuV) + Correction Factor(dB/m)
2. Correction Factor(dB/m) = Antenna Factor(dB/m) + Cable Factor(dB) – Pre-Amplifier Factor(dB)
3. The other emission levels were very low against the limit.
4. Margin value = Emission Level – Limit value
5. " * ": Fundamental frequency.
6. " # ": The radiated frequency is out of the restricted band.

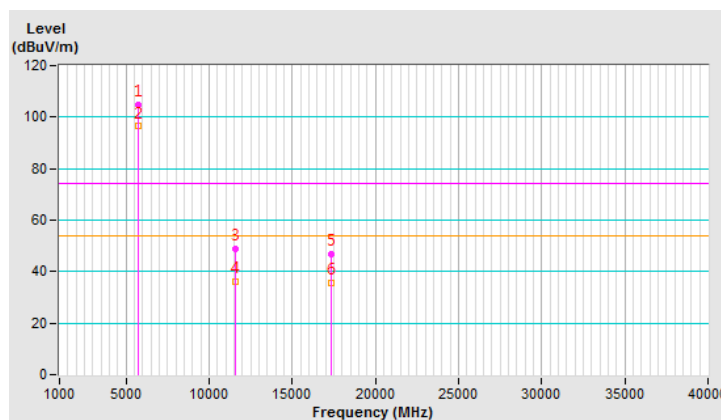

CHANNEL	TX Channel 155	DETECTOR FUNCTION	Peak (PK)
FREQUENCY RANGE	1GHz ~ 40GHz		Average (AV)

ANTENNA POLARITY & TEST DISTANCE: VERTICAL AT 3 M

NO.	FREQ. (MHz)	EMISSION LEVEL (dBuV/m)	LIMIT (dBuV/m)	MARGIN (dB)	ANTENNA HEIGHT (m)	TABLE ANGLE (Degree)	RAW VALUE (dBuV)	CORRECTION FACTOR (dB/m)
1	5133.40	51.6 PK	74.0	-22.4	2.31 V	128	47.6	4.0
2	5133.40	47.8 AV	54.0	-6.2	2.31 V	128	43.8	4.0
3	*5775.00	109.3 PK			2.31 V	128	104.3	5.0
4	*5775.00	100.1 AV			2.31 V	128	95.1	5.0
5	11550.00	53.2 PK	74.0	-20.8	1.67 V	264	39.2	14.0
6	11550.00	40.6 AV	54.0	-13.4	1.67 V	264	26.6	14.0
7	#17325.00	52.5 PK	74.0	-21.5	1.54 V	266	33.9	18.6
8	#17325.00	40.8 AV	54.0	-13.2	1.54 V	266	22.2	18.6

REMARKS:

1. Emission Level(dBuV/m) = Raw Value(dBuV) + Correction Factor(dB/m)
2. Correction Factor(dB/m) = Antenna Factor(dB/m) + Cable Factor(dB) – Pre-Amplifier Factor(dB)
3. The other emission levels were very low against the limit.
4. Margin value = Emission Level – Limit value
5. " * ": Fundamental frequency.
6. " # ": The radiated frequency is out of the restricted band.

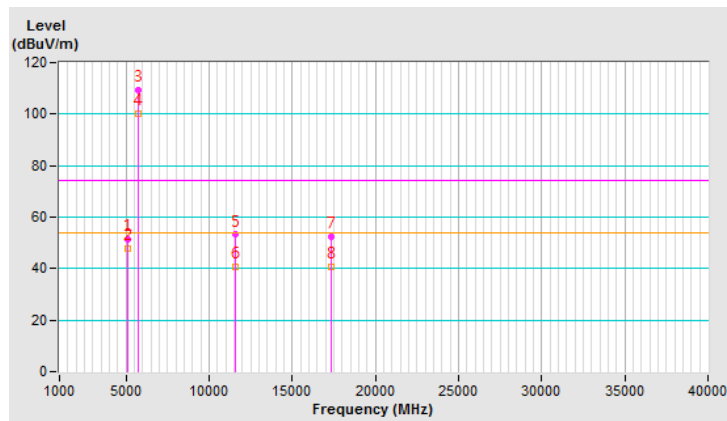

Below 1GHz Data:

802.11ac (VHT20)

CHANNEL	TX Channel 36	DETECTOR FUNCTION	Quasi-Peak (QP)
FREQUENCY RANGE	9kHz ~ 1GHz		

ANTENNA POLARITY & TEST DISTANCE: HORIZONTAL AT 3 M

NO.	FREQ. (MHz)	EMISSION LEVEL (dBuV/m)	LIMIT (dBuV/m)	MARGIN (dB)	ANTENNA HEIGHT (m)	TABLE ANGLE (Degree)	RAW VALUE (dBuV)	CORRECTION FACTOR (dB/m)
1	63.32	25.0 QP	40.0	-15.0	2.50 H	134	33.8	-8.8
2	125.01	35.9 QP	43.5	-7.6	1.00 H	61	45.5	-9.6
3	252.01	38.6 QP	46.0	-7.4	1.00 H	59	48.0	-9.4
4	375.00	35.6 QP	46.0	-10.4	1.00 H	71	41.4	-5.8
5	625.00	35.9 QP	46.0	-10.1	1.00 H	33	36.0	-0.1
6	799.89	36.2 QP	46.0	-9.8	1.50 H	291	33.7	2.5

REMARKS:

1. Emission Level(dBuV/m) = Raw Value(dBuV) + Correction Factor(dB/m)
2. Correction Factor(dB/m) = Antenna Factor(dB/m) + Cable Factor(dB) – Pre-Amplifier Factor(dB)
3. The other emission levels were very low against the limit.
4. Margin value = Emission Level – Limit value

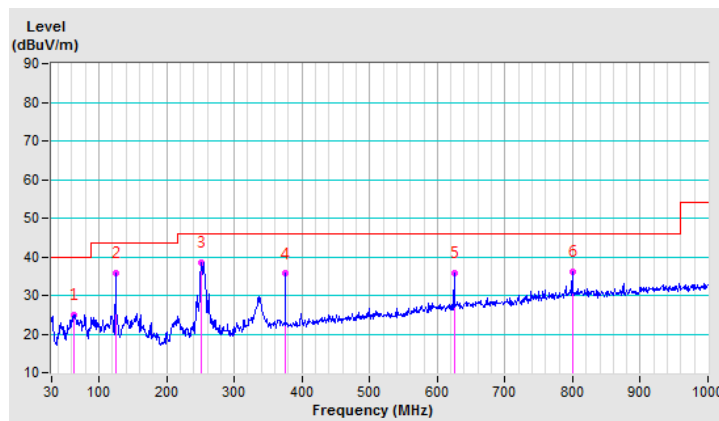

CHANNEL	TX Channel 36	DETECTOR FUNCTION	Quasi-Peak (QP)
FREQUENCY RANGE	9kHz ~ 1GHz		

ANTENNA POLARITY & TEST DISTANCE: VERTICAL AT 3 M

NO.	FREQ. (MHz)	EMISSION LEVEL (dBuV/m)	LIMIT (dBuV/m)	MARGIN (dB)	ANTENNA HEIGHT (m)	TABLE ANGLE (Degree)	RAW VALUE (dBuV)	CORRECTION FACTOR (dB/m)
1	44.14	29.3 QP	40.0	-10.7	1.00 V	179	37.0	-7.7
2	125.01	33.7 QP	43.5	-9.8	1.00 V	282	43.3	-9.6
3	259.57	33.7 QP	46.0	-12.3	2.00 V	330	42.9	-9.2
4	375.00	35.3 QP	46.0	-10.7	1.50 V	72	41.1	-5.8
5	624.97	32.6 QP	46.0	-13.4	1.50 V	57	32.7	-0.1
6	874.97	32.6 QP	46.0	-13.4	1.00 V	42	29.0	3.6

REMARKS:

1. Emission Level(dBuV/m) = Raw Value(dBuV) + Correction Factor(dB/m)
2. Correction Factor(dB/m) = Antenna Factor(dB/m) + Cable Factor(dB) – Pre-Amplifier Factor(dB)
3. The other emission levels were very low against the limit.
4. Margin value = Emission Level – Limit value

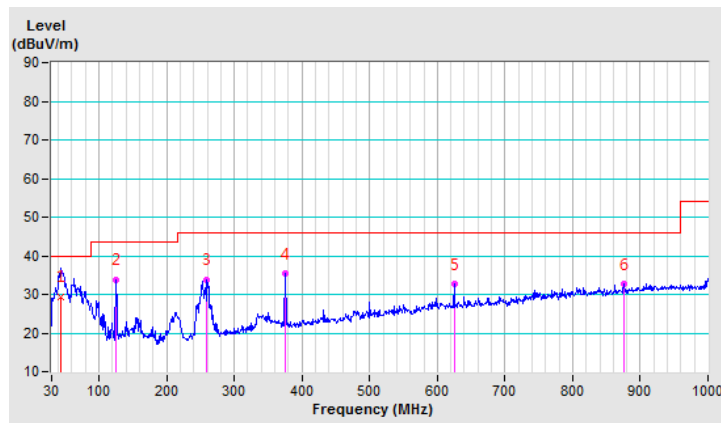

4.2 Conducted Emission Measurement

4.2.1 Limits of Conducted Emission Measurement

Frequency (MHz)	Conducted Limit (dBuV)	
	Quasi-peak	Average
0.15 - 0.5	66 - 56	56 - 46
0.50 - 5.0	56	46
5.0 - 30.0	60	50

Note: 1. The lower limit shall apply at the transition frequencies.

2. The limit decreases in line with the logarithm of the frequency in the range of 0.15 to 0.50MHz.

4.2.2 Test Instruments

DESCRIPTION & MANUFACTURER	MODEL NO.	SERIAL NO.	CALIBRATED DATE	CALIBRATED UNTIL
Test Receiver R&S	ESCS 30	847124/029	Nov. 01, 2017	Oct. 31, 2018
Line-Impedance Stabilization Network (for EUT) R&S	ESH3-Z5	848773/004	Nov. 15, 20167	Nov. 14, 2018
Line-Impedance Stabilization Network (for Peripheral) R&S	ENV216	100072	June 03, 2017	June 02, 2018
50 ohms Terminator	N/A	EMC-02	Sep. 22, 2017	Sep. 21, 2018
RF Cable	5D-FB	COCCAB-001	Sep. 29, 2017	Sep. 28, 2018
10 dB PAD Mini-Circuits	HAT-10+	CONATT-004	June 18, 2017	June 17, 2018
Software BVADT	BVADT_Cond_ V7.3.7.4	NA	NA	NA

Note:

1. The calibration interval of the above test instruments are 12 months and the calibrations are traceable to NML/ROC and NIST/USA.
2. The test was performed in Shielded Room No. 1.
3. Tested Date: Nov. 21, 2017

4.2.3 Test Procedure

- The EUT was placed 0.4 meters from the conducting wall of the shielded room with EUT being connected to the power mains through a line impedance stabilization network (LISN). Other support units were connected to the power mains through another LISN. The two LISNs provide 50 ohm/ 50uH of coupling impedance for the measuring instrument.
- Both lines of the power mains connected to the EUT were checked for maximum conducted interference.
- The frequency range from 150kHz to 30MHz was searched. Emission levels under (Limit - 20dB) was not recorded.

NOTE: All modes of operation were investigated and the worst-case emissions are reported.

4.2.4 Deviation from Test Standard

No deviation.

4.2.5 Test Setup

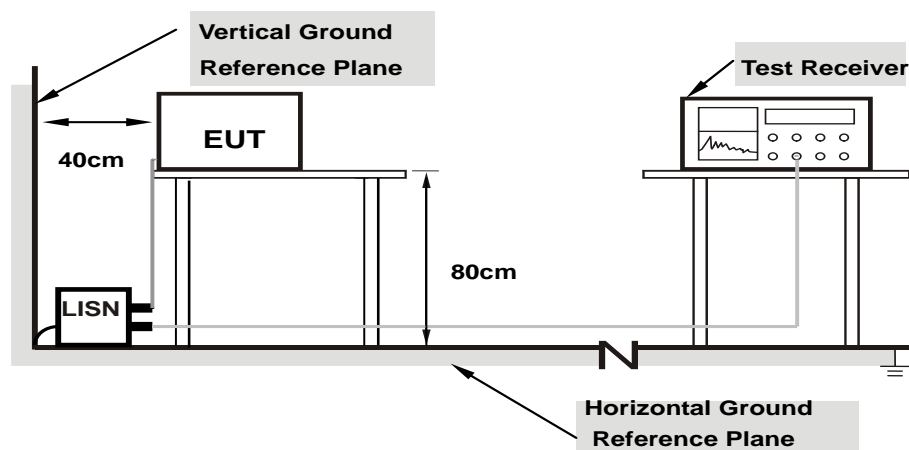

Note: 1.Support units were connected to second LISN.

For the actual test configuration, please refer to the attached file (Test Setup Photo).

4.2.6 EUT Operating Condition

Same as 4.1.6.

4.2.7 Test Results

Phase	Line (L)	Detector Function	Quasi-Peak (QP) / Average (AV)
-------	----------	-------------------	--------------------------------

No	Freq. [MHz]	Corr.	Reading Value		Emission Level		Limit		Margin	
		Factor (dB)	[dB (uV)]		[dB (uV)]		[dB (uV)]		(dB)	
			Q.P.	AV.	Q.P.	AV.	Q.P.	AV.	Q.P.	AV.
1	0.15000	10.09	45.57	29.42	55.66	39.51	66.00	56.00	-10.34	-16.49
2	0.17344	10.08	42.41	27.86	52.49	37.94	64.79	54.79	-12.30	-16.85
3	0.18516	10.07	42.31	27.53	52.38	37.60	64.25	54.25	-11.87	-16.65
4	0.27500	10.09	31.59	21.01	41.68	31.10	60.97	50.97	-19.29	-19.87
5	0.44688	10.12	24.34	16.26	34.46	26.38	56.93	46.93	-22.47	-20.55
6	17.70313	11.41	20.65	14.89	32.06	26.30	60.00	50.00	-27.94	-23.70

REMARKS:

1. Q.P. and AV. are abbreviations of quasi-peak and average individually.
2. The emission levels of other frequencies were very low against the limit.
3. Margin value = Emission level - Limit value
4. Correction factor = Insertion loss + Cable loss
5. Emission Level = Correction Factor + Reading Value.

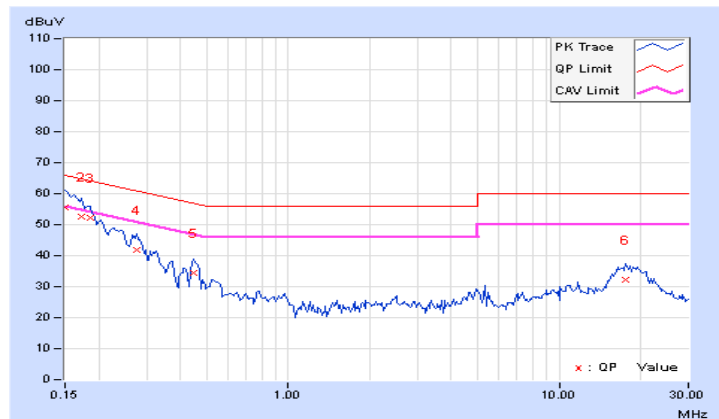

Phase	Neutral (N)	Detector Function	Quasi-Peak (QP) / Average (AV)
-------	-------------	-------------------	--------------------------------

No	Freq. [MHz]	Corr.	Reading Value		Emission Level		Limit		Margin	
		Factor (dB)	[dB (uV)]		[dB (uV)]		[dB (uV)]		(dB)	
			Q.P.	AV.	Q.P.	AV.	Q.P.	AV.	Q.P.	AV.
1	0.15000	10.08	45.45	29.20	55.53	39.28	66.00	56.00	-10.47	-16.72
2	0.16562	10.06	44.66	29.44	54.72	39.50	65.18	55.18	-10.46	-15.68
3	0.18516	10.05	41.93	27.33	51.98	37.38	64.25	54.25	-12.27	-16.87
4	0.23984	10.06	32.41	19.55	42.47	29.61	62.10	52.10	-19.63	-22.49
5	0.31016	10.08	24.77	12.36	34.85	22.44	59.97	49.97	-25.12	-27.53
6	17.51953	11.15	15.99	10.69	27.14	21.84	60.00	50.00	-32.86	-28.16

REMARKS:

1. Q.P. and AV. are abbreviations of quasi-peak and average individually.
2. The emission levels of other frequencies were very low against the limit.
3. Margin value = Emission level - Limit value
4. Correction factor = Insertion loss + Cable loss
5. Emission Level = Correction Factor + Reading Value.

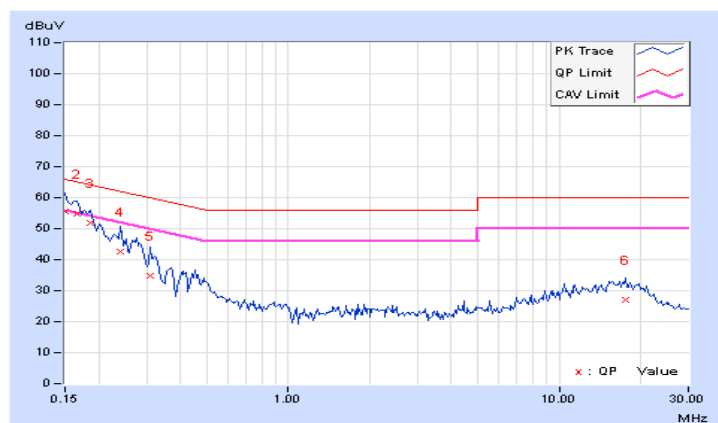

4.3 Transmit Power Measurement

4.3.1 Limits of Transmit Power Measurement

Operation Band	EUT Category		Limit
U-NII-1		Outdoor Access Point	1 Watt (30 dBm) (Max. e.i.r.p \leq 125mW(21 dBm) at any elevation angle above 30 degrees as measured from the horizon)
		Fixed point-to-point Access Point	1 Watt (30 dBm)
	√	Indoor Access Point	1 Watt (30 dBm)
		Client device	250mW (24 dBm)
U-NII-2A			250mW (24 dBm) or 11 dBm+10 log B*
U-NII-2C			250mW (24 dBm) or 11 dBm+10 log B*
U-NII-3	√		1 Watt (30 dBm)

*B is the 26 dB emission bandwidth in megahertz

Per KDB 662911 Method of conducted output power measurement on IEEE 802.11 devices,

Array Gain = 0 dB (i.e., no array gain) for $N_{ANT} \leq 4$;

Array Gain = 0 dB (i.e., no array gain) for channel widths ≥ 40 MHz for any N_{ANT} ;

Array Gain = $5 \log(N_{ANT}/N_{SS})$ dB or 3 dB, whichever is less for 20-MHz channel widths with $N_{ANT} \geq 5$.

For power measurements on all other devices: Array Gain = $10 \log(N_{ANT}/N_{SS})$ dB.

4.3.2 Test Setup

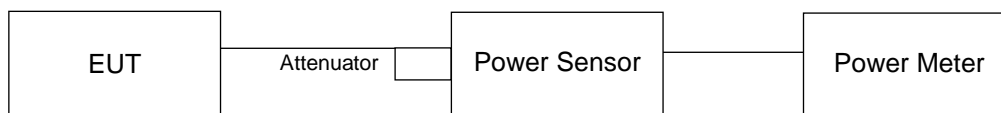

4.3.3 Test Instruments

Refer to section 4.1.2 to get information of above instrument.

4.3.4 Test Procedure

Method PM is used to perform output power measurement, trigger and gating function of wide band power meter is enabled to measure max output power of TX on burst. Duty factor is not added to measured value.

4.3.5 Deviation from Test Standard

No deviation.

4.3.6 EUT Operating Condition

The software provided by client to enable the EUT under transmission condition continuously at lowest, middle and highest channel frequencies individually.

4.3.7 Test Result

CDD Mode

802.11a

Chan.	Chan. Freq. (MHz)	Maximum Conducted Power (dBm)			Total Power (mW)	Total Power (dBm)	Limit (dBm)	Pass / Fail
		Chain 0	Chain 1	Chain 2				
36	5180	22.44	21.67	23.02	522.728	27.18	30.00	Pass
40	5200	22.31	21.58	22.88	508.185	27.06	30.00	Pass
48	5240	21.93	21.27	22.72	476.991	26.79	30.00	Pass
149	5745	22.37	21.48	22.97	511.342	27.09	30.00	Pass
157	5785	22.42	21.62	23.02	520.24	27.16	30.00	Pass
165	5825	22.35	21.67	22.88	512.773	27.10	30.00	Pass

802.11ac (VHT20)

Chan.	Chan. Freq. (MHz)	Maximum Conducted Power (dBm)			Total Power (mW)	Total Power (dBm)	Limit (dBm)	Pass / Fail
		Chain 0	Chain 1	Chain 2				
36	5180	22.55	21.73	23.34	544.597	27.36	30.00	Pass
40	5200	22.51	21.62	23.30	537.245	27.30	30.00	Pass
48	5240	20.75	20.04	20.95	344.226	25.37	30.00	Pass
149	5745	22.52	21.51	23.11	524.872	27.20	30.00	Pass
157	5785	22.45	21.52	22.99	516.765	27.13	30.00	Pass
165	5825	22.22	21.83	22.81	510.115	27.08	30.00	Pass

802.11ac (VHT40)

Chan.	Chan. Freq. (MHz)	Maximum Conducted Power (dBm)			Total Power (mW)	Total Power (dBm)	Limit (dBm)	Pass / Fail
		Chain 0	Chain 1	Chain 2				
38	5190	18.44	17.84	17.66	188.982	22.76	30.00	Pass
46	5230	21.61	20.89	22.64	451.275	26.54	30.00	Pass
151	5755	21.59	20.39	21.98	411.369	26.14	30.00	Pass
159	5795	21.60	20.66	21.95	417.632	26.21	30.00	Pass

802.11ac (VHT80)

Chan.	Chan. Freq. (MHz)	Maximum Conducted Power (dBm)			Total Power (mW)	Total Power (dBm)	Limit (dBm)	Pass / Fail
		Chain 0	Chain 1	Chain 2				
42	5210	17.29	16.67	16.09	140.676	21.48	30.00	Pass
155	5775	20.36	20.13	20.44	322.344	25.08	30.00	Pass

Beamforming Mode

802.11ac (VHT20)

Chan.	Chan. Freq. (MHz)	Maximum Conducted Power (dBm)			Total Power (mW)	Total Power (dBm)	Limit (dBm)	Pass / Fail
		Chain 0	Chain 1	Chain 2				
36	5180	22.55	21.73	23.34	544.597	27.36	27.38	Pass
40	5200	22.51	21.62	23.30	537.245	27.30	27.38	Pass
48	5240	20.75	20.04	20.95	344.226	25.37	27.38	Pass
149	5745	22.52	21.51	23.11	524.872	27.20	27.38	Pass
157	5785	22.45	21.52	22.99	516.765	27.13	27.38	Pass
165	5825	22.22	21.83	22.81	510.115	27.08	27.38	Pass

Note: 1. Directional gain = $10 \log[(10^{G1/20} + 10^{G2/20} + 10^{G3/20})^2 / 3] = 8.62\text{dBi} > 6\text{dBi}$, so the power limit shall be reduced to $30 - (8.62 - 6) = 27.38\text{dBm}$.

802.11ac (VHT40)

Chan.	Chan. Freq. (MHz)	Maximum Conducted Power (dBm)			Total Power (mW)	Total Power (dBm)	Limit (dBm)	Pass / Fail
		Chain 0	Chain 1	Chain 2				
38	5190	18.44	17.84	17.66	188.982	22.76	27.38	Pass
46	5230	21.61	20.89	22.64	451.275	26.54	27.38	Pass
151	5755	21.59	20.39	21.98	411.369	26.14	27.38	Pass
159	5795	21.60	20.66	21.95	417.632	26.21	27.38	Pass

Note: 1. Directional gain = $10 \log[(10^{G1/20} + 10^{G2/20} + 10^{G3/20})^2 / 3] = 8.62\text{dBi} > 6\text{dBi}$, so the power limit shall be reduced to $30 - (8.62 - 6) = 27.38\text{dBm}$.

802.11ac (VHT80)

Chan.	Chan. Freq. (MHz)	Maximum Conducted Power (dBm)			Total Power (mW)	Total Power (dBm)	Limit (dBm)	Pass / Fail
		Chain 0	Chain 1	Chain 2				
42	5210	17.29	16.67	16.09	140.676	21.48	27.38	Pass
155	5775	20.36	20.13	20.44	322.344	25.08	27.38	Pass

Note: 1. Directional gain = $10 \log[(10^{G1/20} + 10^{G2/20} + 10^{G3/20})^2 / 3] = 8.62\text{dBi} > 6\text{dBi}$, so the power limit shall be reduced to $30 - (8.62 - 6) = 27.38\text{dBm}$.

4.4 Occupied Bandwidth Measurement

4.4.1 Test Setup

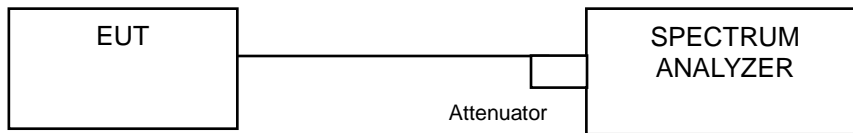

4.4.2 Test Instruments

Refer to section 4.1.2 to get information of above instrument.

4.4.3 Test Procedure

The transmitter output was connected to the spectrum analyzer through an attenuator. The bandwidth of the fundamental frequency was measured by spectrum analyzer with resolution bandwidth in the range of 1% to 5% of the anticipated emission bandwidth, and a video bandwidth at least 3x the resolution bandwidth and set the detector to SAMPLE. The width of a frequency band such that, below the lower and above the upper frequency limits, the mean powers emitted are each equal to a specified percentage 0.5 %of the total mean power of a given emission.

4.4.4 Test Results

802.11a

Channel	Channel Frequency (MHz)	Occupied Bandwidth (MHz)		
		Chain 0	Chain 1	Chain 2
36	5180	23.04	19.44	24.60
40	5200	22.56	19.68	24.84
48	5240	18.12	18.60	18.12
149	5745	32.64	21.60	33.00
157	5785	33.36	21.72	32.64
165	5825	33.12	23.40	33.24

802.11ac (VHT20)

Channel	Channel Frequency (MHz)	Occupied Bandwidth (MHz)		
		Chain 0	Chain 1	Chain 2
36	5180	24.36	19.32	25.68
40	5200	24.36	19.44	26.52
48	5240	18.00	18.00	18.12
149	5745	36.12	22.68	35.76
157	5785	35.28	21.96	36.00
165	5825	36.72	24.00	36.24

802.11ac (VHT40)

Channel	Channel Frequency (MHz)	Occupied Bandwidth (MHz)		
		Chain 0	Chain 1	Chain 2
38	5190	36.72	36.72	36.72
46	5230	37.92	36.96	38.16
151	5755	46.80	37.44	44.88
159	5795	48.00	37.68	46.56

802.11ac (VHT80)

Channel	Channel Frequency (MHz)	Occupied Bandwidth (MHz)		
		Chain 0	Chain 1	Chain 2
42	5210	75.84	75.84	75.84
155	5775	76.32	76.80	76.32

Spectrum Plot of Worst Value

802.11a_Chain0 / CH157

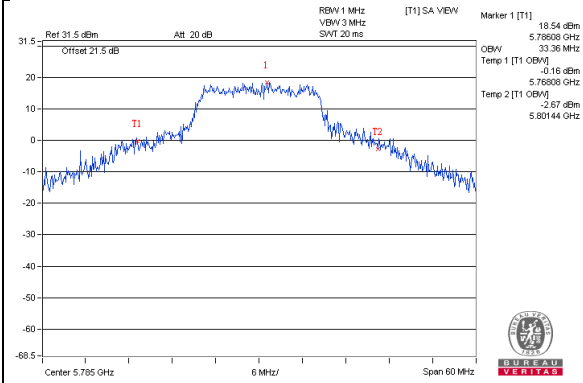

802.11ac (VHT20)_Chain0 / CH165

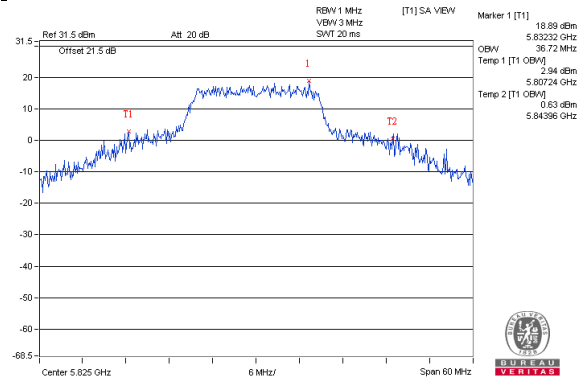

802.11ac (VHT40)_Chain0 / CH159

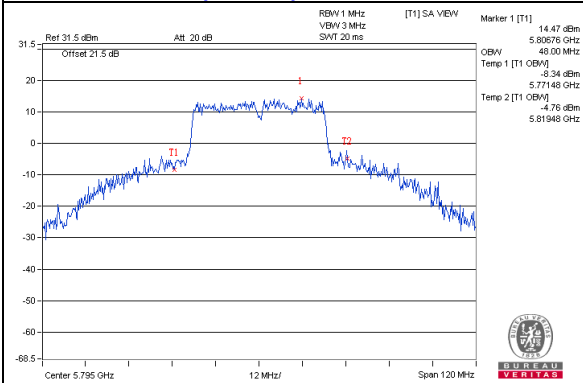

802.11ac (VHT80)_Chain1 / CH155

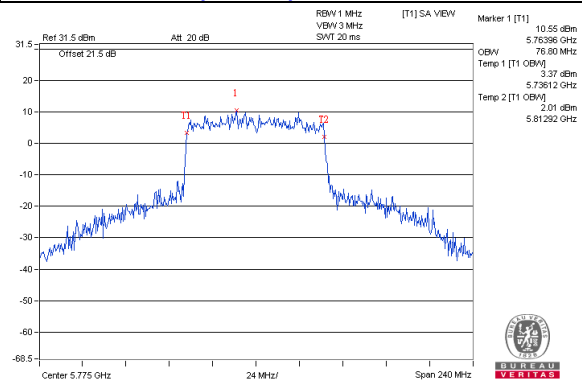

Spectrum Plot for near by DFS band (DFS is required, if 99% OCP straddle into U-NII-2A band)

802.11a_Chain0 / CH48

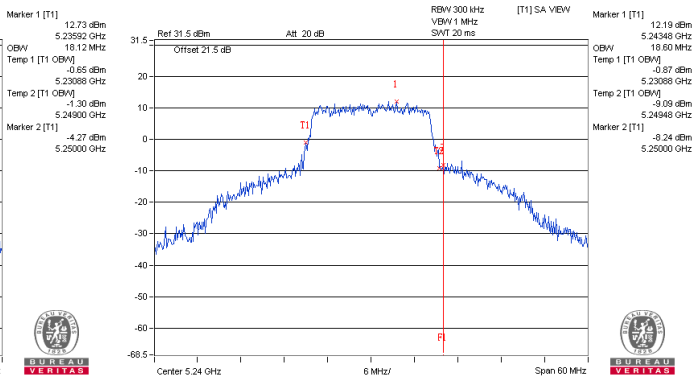
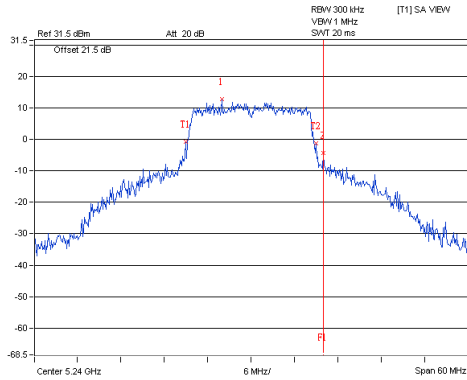

802.11a_Chain2 / CH48

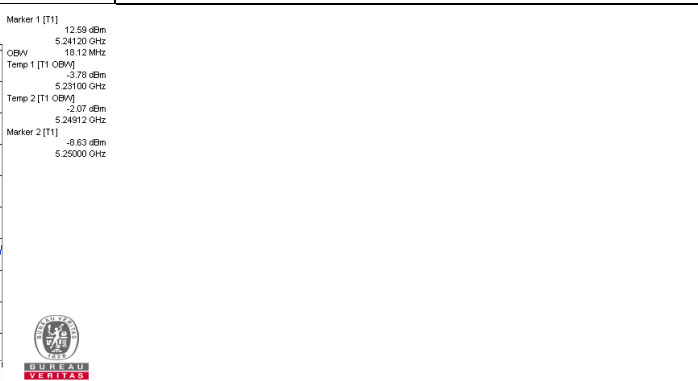
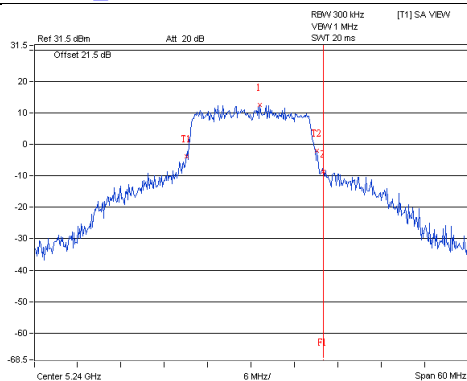

802.11ac(VHT20)_Chain0 / CH48

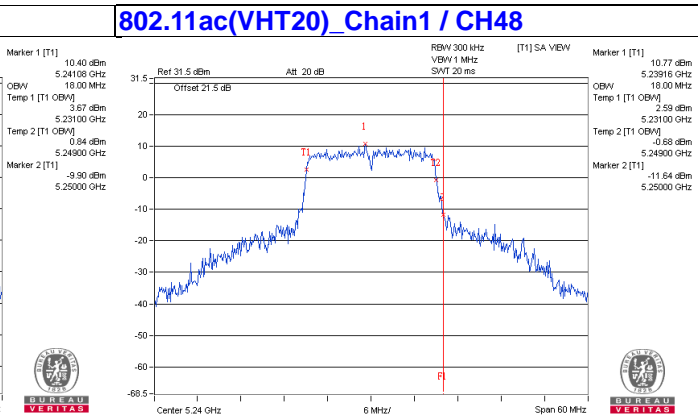
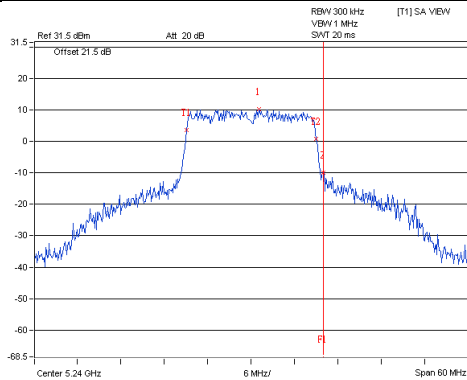

802.11ac(VHT20)_Chain2 / CH48

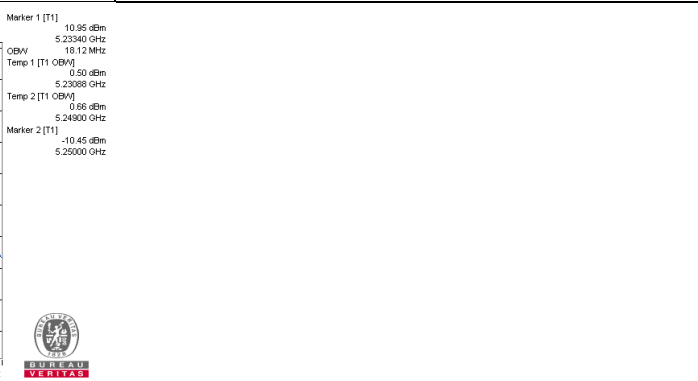
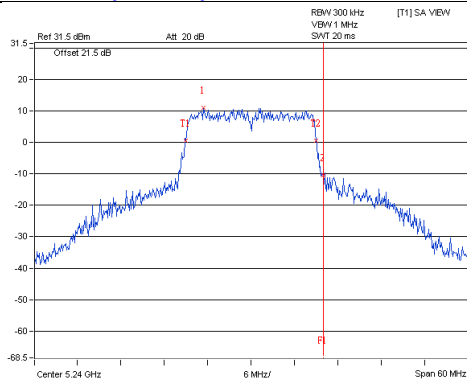

Spectrum Plot for near by DFS band (DFS is required, if 99% OCP straddle into U-NII-2A band)

802.11ac(VHT40)_Chain0 / CH46

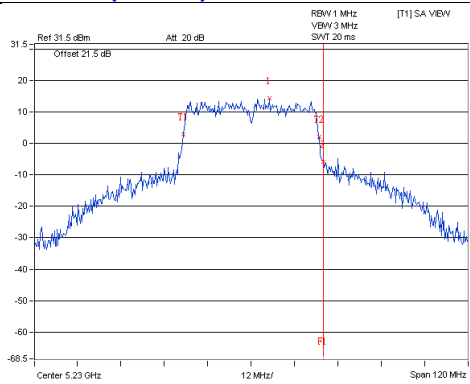

802.11ac(VHT40)_Chain1 / CH46

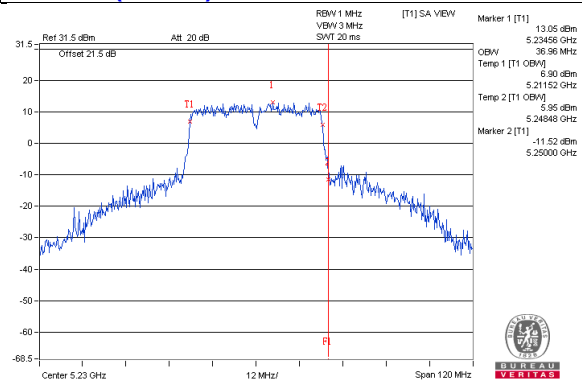

802.11ac(VHT40)_Chain2 / CH46

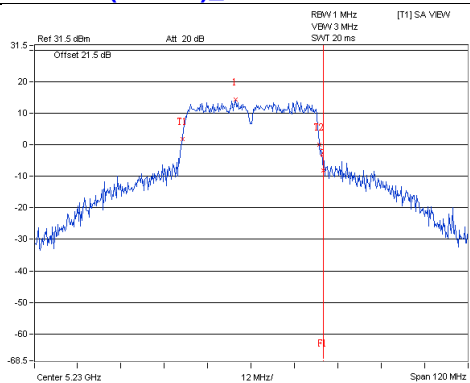

802.11ac(VHT80)_Chain0 / CH42

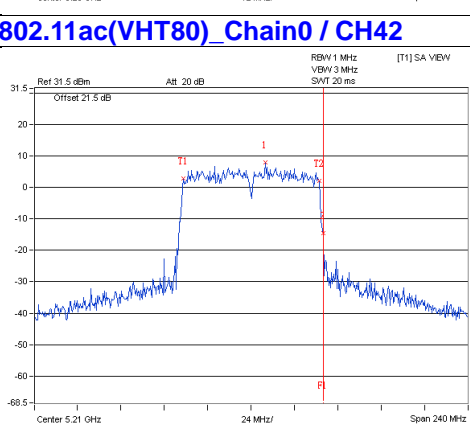

802.11ac(VHT80)_Chain1 / CH42

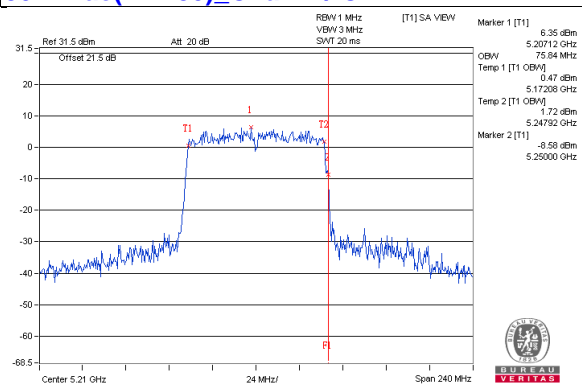

802.11ac(VHT80)_Chain2 / CH42

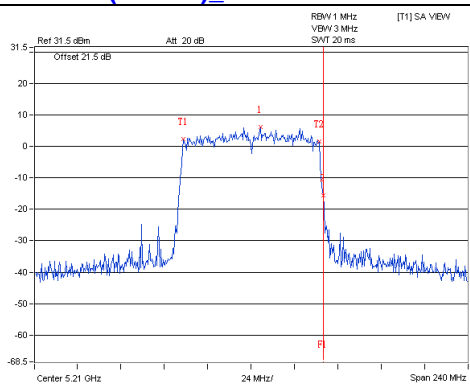

Spectrum Plot for near by DFS band (DFS is required, if 99% OCP straddle into U-NII-2C band)

802.11a_Chain0 / CH149

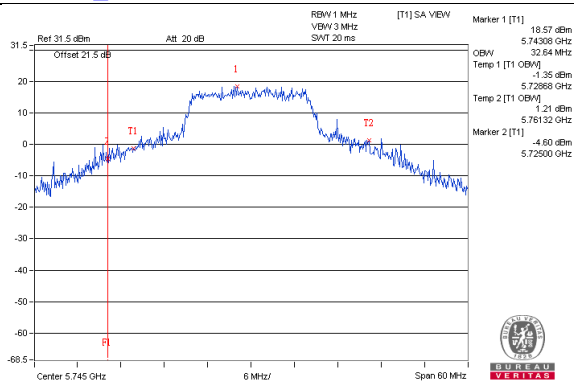

802.11a_Chain1 / CH149

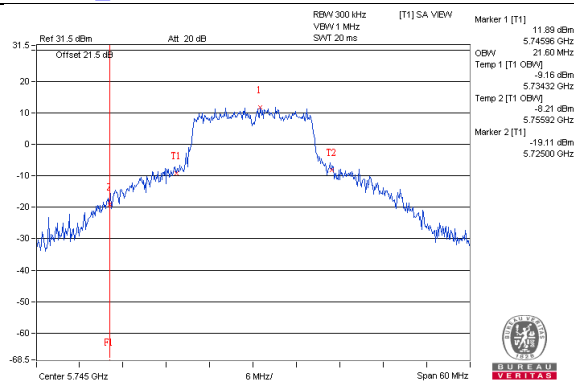

802.11a_Chain2 / CH149

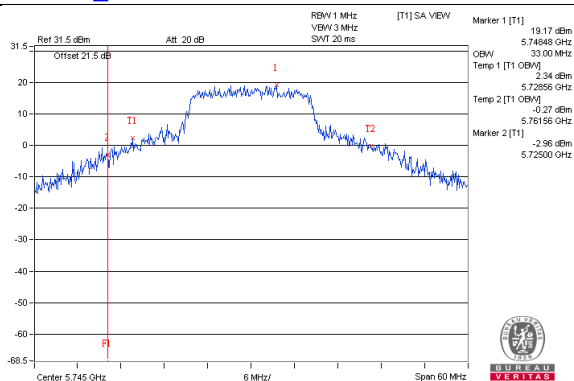

802.11ac(VHT20)_Chain0 / CH149

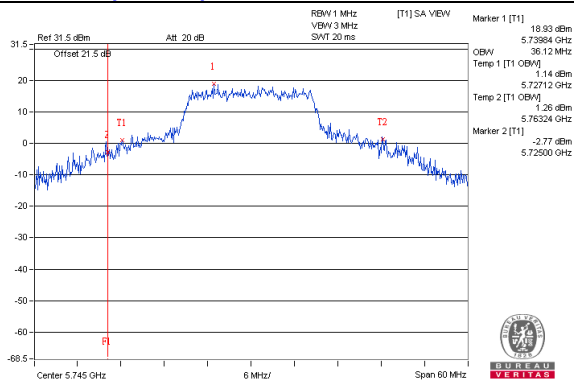

802.11ac(VHT20)_Chain1 / CH149

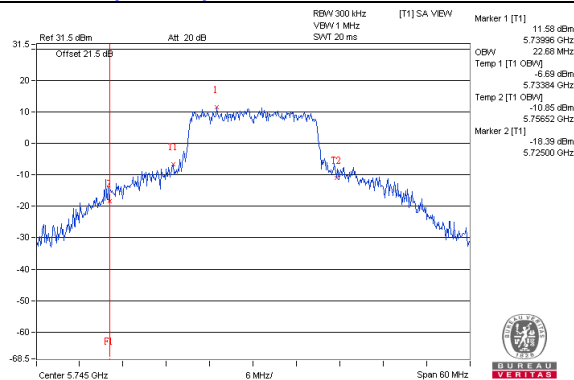

802.11ac(VHT20)_Chain2 / CH149

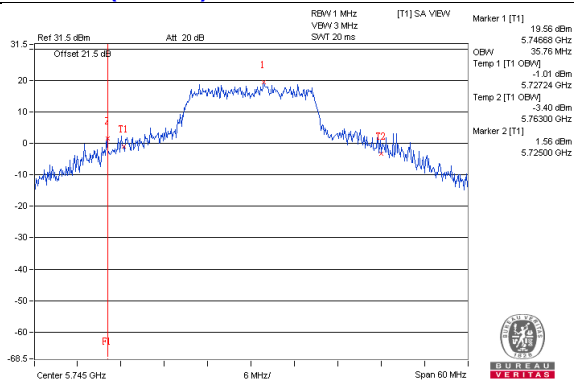

Spectrum Plot for near by DFS band (DFS is required, if 99% OCP straddle into U-NII-2C band)

802.11ac(VHT40)_Chain0 / CH151

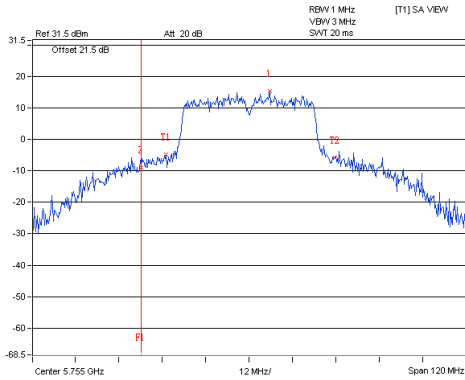

[T1] SA VIEW
 Marker 1 [T1]
 15.36 dBm
 5.76076 GHz
 OBW 46.80 MHz
 Temp 1 [T1] OBW 4.69 dBm
 5.73186 GHz
 Temp 2 [T1] OBW -5.75 dBm
 5.77876 GHz
 Marker 2 [T1]
 -8.95 dBm
 5.72500 GHz



802.11ac(VHT40)_Chain1 / CH151

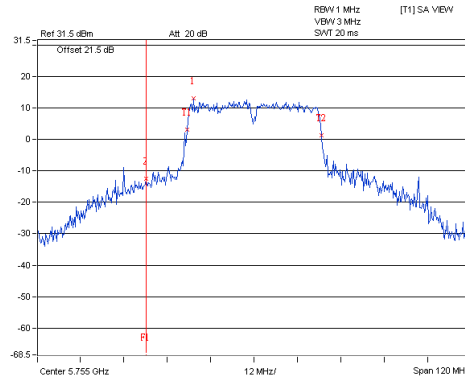

[T1] SA VIEW
 Marker 1 [T1]
 13.06 dBm
 5.73820 GHz
 OBW 37.44 MHz
 Temp 1 [T1] OBW 2.99 dBm
 5.73828 GHz
 Temp 2 [T1] OBW 1.40 dBm
 5.77372 GHz
 Marker 2 [T1]
 -12.54 dBm
 5.72500 GHz



802.11ac(VHT40)_Chain2 / CH151

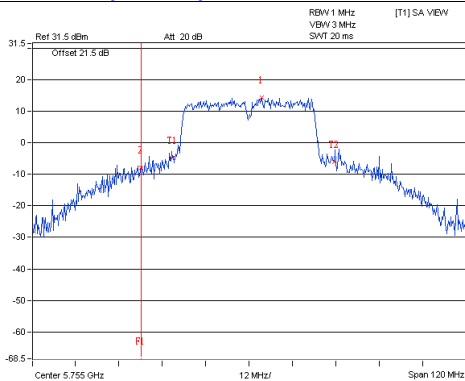

[T1] SA VIEW
 Marker 1 [T1]
 14.33 dBm
 5.75938 GHz
 OBW 44.88 MHz
 Temp 1 [T1] OBW 4.88 dBm
 5.73364 GHz
 Temp 2 [T1] OBW -6.06 dBm
 5.77652 GHz
 Marker 2 [T1]
 -7.89 dBm
 5.72500 GHz



802.11ac(VHT80)_Chain0 / CH155

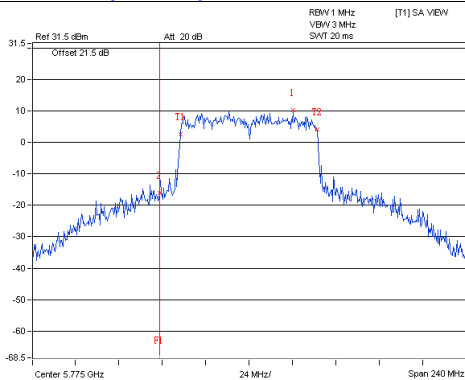

[T1] SA VIEW
 Marker 1 [T1]
 10.39 dBm
 5.79949 GHz
 OBW 36.32 MHz
 Temp 1 [T1] OBW 2.62 dBm
 5.73980 GHz
 Temp 2 [T1] OBW 4.24 dBm
 5.81292 GHz
 Marker 2 [T1]
 -16.10 dBm
 5.72500 GHz



802.11ac(VHT80)_Chain1 / CH155

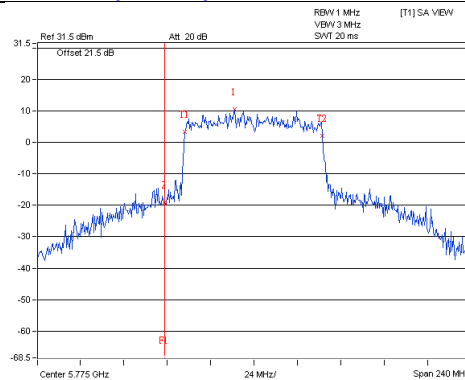

[T1] SA VIEW
 Marker 1 [T1]
 10.55 dBm
 5.76396 GHz
 OBW 76.00 MHz
 Temp 1 [T1] OBW 3.37 dBm
 5.73612 GHz
 Temp 2 [T1] OBW 2.01 dBm
 5.81292 GHz
 Marker 2 [T1]
 -19.06 dBm
 5.72500 GHz



802.11ac(VHT80)_Chain2 / CH155

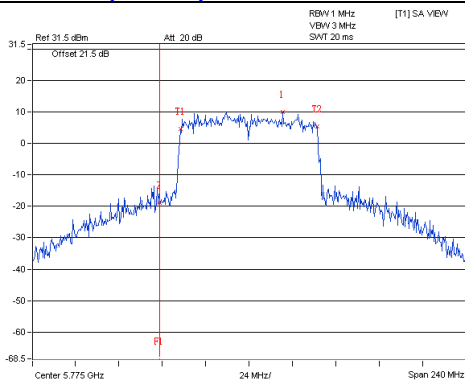

[T1] SA VIEW
 Marker 1 [T1]
 9.06 dBm
 5.79372 GHz
 OBW 76.32 MHz
 Temp 1 [T1] OBW 4.54 dBm
 5.73860 GHz
 Temp 2 [T1] OBW 5.29 dBm
 5.81292 GHz
 Marker 2 [T1]
 -18.69 dBm
 5.72500 GHz



4.5 Peak Power Spectral Density Measurement

4.5.1 Limits of Peak Power Spectral Density Measurement

Operation Band	EUT Category		Limit
U-NII-1		Outdoor Access Point	17dBm/ MHz
		Fixed point-to-point Access Point	
	√	Indoor Access Point	
		Client device	11dBm/ MHz
U-NII-2A			11dBm/ MHz
U-NII-2C			11dBm/ MHz
U-NII-3	√		30dBm/ 500kHz

4.5.2 Test Setup

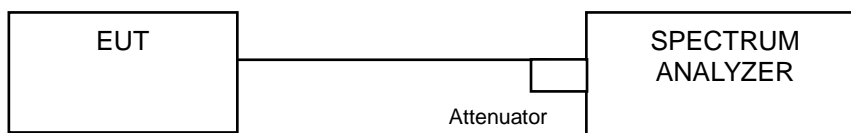

4.5.3 Test Instruments

Refer to section 4.1.2 to get information of above instrument.

4.5.4 Test Procedure

802.11a, 802.11ac (VHT20)

For U-NII-1:

Using method SA-1

1. Set span to encompass the entire emission bandwidth (EBW) of the signal.
2. Set RBW = 1 MHz, Set VBW \geq 3 MHz, Detector = RMS
3. Sweep time = auto, trigger set to "free run".
4. Trace average at least 100 traces in power averaging mode.
5. Record the max value

For U-NII-3:

1. Set span to encompass the entire emission bandwidth (EBW) of the signal.
2. Set RBW = 300 kHz, Set VBW \geq 1 MHz, Detector = RMS
3. Use the peak marker function to determine the maximum power level in any 300 kHz band segment within the fundamental EBW.
4. Scale the observed power level to an equivalent value in 500 kHz by adjusting (reducing) the measured power by a bandwidth correction factor (BWCF) where $BWCF = 10\log(500 \text{ kHz}/300\text{kHz})$
5. Sweep time = auto, trigger set to "free run".
6. Trace average at least 100 traces in power averaging mode.
7. Record the max value

802.11ac (VHT40), 802.11ac (VHT80)

For U-NII-1:

Using method SA-2

1. Set span to encompass the entire emission bandwidth (EBW) of the signal.
2. Set RBW = 1 MHz, Set VBW \geq 3 MHz, Detector = RMS
3. Sweep time = auto, trigger set to "free run".
4. Trace average at least 100 traces in power averaging mode.
5. Record the max value and add $10 \log (1/\text{duty cycle})$

For U-NII-3:

1. Set span to encompass the entire emission bandwidth (EBW) of the signal.
2. Set RBW = 300 kHz, Set VBW \geq 1 MHz, Detector = RMS
3. Use the peak marker function to determine the maximum power level in any 300 kHz band segment within the fundamental EBW.
4. Scale the observed power level to an equivalent value in 500 kHz by adjusting (reducing) the measured power by a bandwidth correction factor (BWCF) where $BWCF = 10\log(500 \text{ kHz}/300\text{kHz})$
5. Sweep time = auto, trigger set to "free run".
6. Trace average at least 100 traces in power averaging mode.
7. Record the max value and add $10 \log (1/\text{duty cycle})$

4.5.5 Deviation from Test Standard

No deviation.

4.5.6 EUT Operating Condition

Same as Item 4.3.6.

4.5.7 Test Results (Mode 1)

For U-NII-1:

802.11a

Chan.	Chan. Freq. (MHz)	PSD (dBm/MHz)			Total Power Density (dBm/MHz)	MAX. Limit (dBm/MHz)	Pass / Fail
		Chain 0	Chain 1	Chain 2			
36	5180	8.54	7.43	8.24	12.87	14.38	Pass
40	5200	8.53	7.36	8.52	12.94	14.38	Pass
48	5240	8.09	7.79	7.48	12.57	14.38	Pass

- Note:** 1. Method a) of power density measurement of KDB 662911 is using for calculating total power density. Total power density is summing entire spectra across corresponding frequency bins on the various outputs by computer.
2. Directional gain = $10 \log[(10^{G1/20} + 10^{G2/20} + 10^{G3/20})^2 / 3] = 8.62\text{dBi} > 6\text{dBi}$, so the power density limit shall be reduced to $17 - (8.62 - 6) = 14.38\text{dBm}$.

802.11ac (VHT20)

Chan.	Chan. Freq. (MHz)	PSD (dBm/MHz)			Total Power Density (dBm/MHz)	MAX. Limit (dBm/MHz)	Pass / Fail
		Chain 0	Chain 1	Chain 2			
36	5180	8.04	7.14	8.77	12.81	14.38	Pass
40	5200	8.17	7.28	8.79	12.89	14.38	Pass
48	5240	6.69	5.97	7.04	11.36	14.38	Pass

- Note:** 1. Method a) of power density measurement of KDB 662911 is using for calculating total power density. Total power density is summing entire spectra across corresponding frequency bins on the various outputs by computer.
2. Directional gain = $10 \log[(10^{G1/20} + 10^{G2/20} + 10^{G3/20})^2 / 3] = 8.62\text{dBi} > 6\text{dBi}$, so the power density limit shall be reduced to $17 - (8.62 - 6) = 14.38\text{dBm}$.

802.11ac (VHT40)

Chan.	Chan. Freq. (MHz)	PSD W/O Duty Factor (dBm/MHz)			Duty Factor (dB)	Total PSD With Duty Factor (dBm/MHz)	MAX. Limit (dBm/MHz)	Pass / Fail
		Chain 0	Chain 1	Chain 2				
38	5190	1.43	0.64	0.74	0.13	5.86	14.38	Pass
46	5230	4.36	3.60	4.74	0.13	9.16	14.38	Pass

- Note:**
- Method a) of power density measurement of KDB 662911 is using for calculating total power density. Total power density is summing entire spectra across corresponding frequency bins on the various outputs by computer.
 - Directional gain = $10 \log[(10^{G1/20} + 10^{G2/20} + 10^{G3/20})^2 / 3] = 8.62\text{dBi} > 6\text{dBi}$, so the power density limit shall be reduced to $17 - (8.62 - 6) = 14.38\text{dBm}$.
 - Refer to section 3.3 for duty cycle spectrum plot.

802.11ac (VHT80)

Chan.	Chan. Freq. (MHz)	PSD W/O Duty Factor (dBm/MHz)			Duty Factor (dB)	Total PSD With Duty Factor (dBm/MHz)	MAX. Limit (dBm/MHz)	Pass / Fail
		Chain 0	Chain 1	Chain 2				
42	5210	-2.89	-3.26	-3.81	0.26	1.72	14.38	Pass

- Note:**
- Method a) of power density measurement of KDB 662911 is using for calculating total power density. Total power density is summing entire spectra across corresponding frequency bins on the various outputs by computer.
 - Directional gain = $10 \log[(10^{G1/20} + 10^{G2/20} + 10^{G3/20})^2 / 3] = 8.62\text{dBi} > 6\text{dBi}$, so the power density limit shall be reduced to $17 - (8.62 - 6) = 14.38\text{dBm}$.
 - Refer to section 3.3 for duty cycle spectrum plot.

Spectrum Plot of Worst Value

802.11a_Chain 0 / CH36

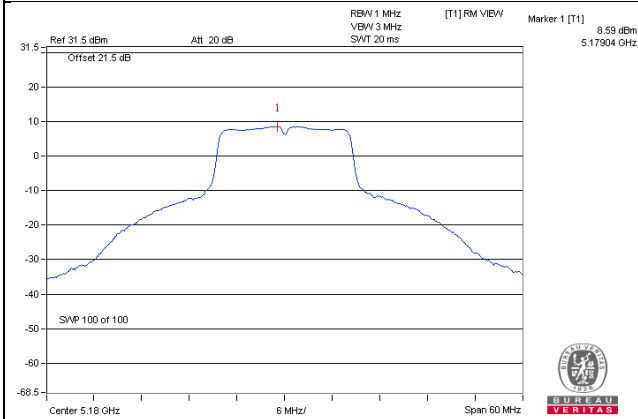

802.11ac (VHT20)_Chain 2 / CH40

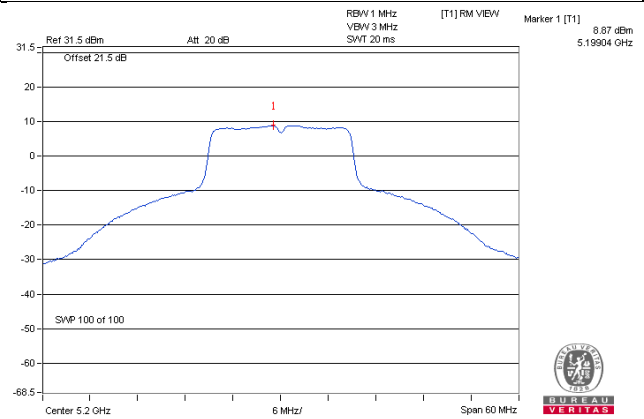

802.11ac (VHT40)_Chain 2 / CH46

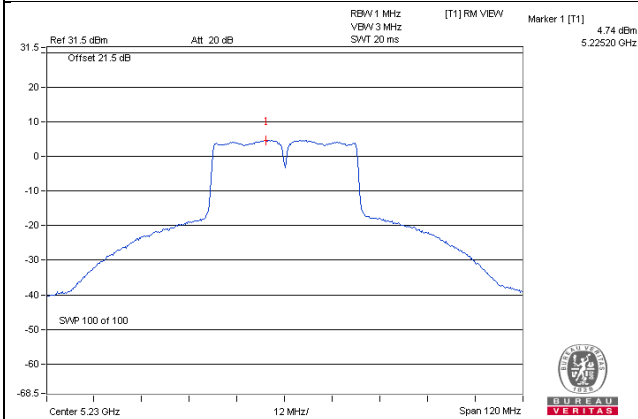

802.11ac (VHT80)_Chain 0 / CH42

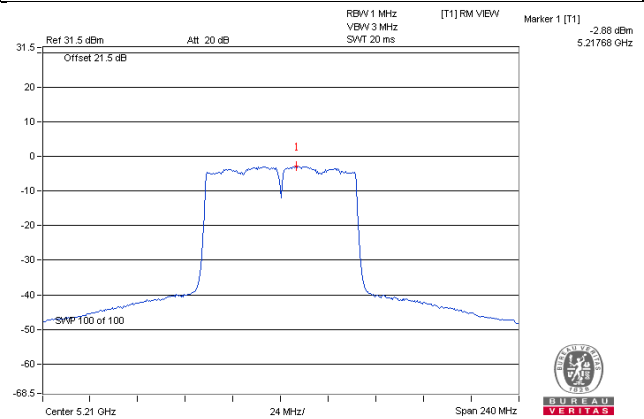

For U-NII-3:
802.11a

TX chain	Channel	Freq. (MHz)	PSD (dBm/300kHz)	PSD (dBm/500kHz)	10 log (N=3) dB	Total PSD (dBm/500kHz)	Limit (dBm/500kHz)	Pass /Fail
0	149	5745	0.83	3.05	4.77	7.82	27.38	Pass
	157	5785	0.48	2.70	4.77	7.47	27.38	Pass
	165	5825	0.37	2.59	4.77	7.36	27.38	Pass
1	149	5745	-0.56	1.66	4.77	6.43	27.38	Pass
	157	5785	-0.47	1.75	4.77	6.52	27.38	Pass
	165	5825	-0.29	1.93	4.77	6.70	27.38	Pass
2	149	5745	1.26	3.48	4.77	8.25	27.38	Pass
	157	5785	0.93	3.15	4.77	7.92	27.38	Pass
	165	5825	0.88	3.10	4.77	7.87	27.38	Pass

Note: 1. Directional gain = $10 \log[(10^{G1/20} + 10^{G2/20} + 10^{G3/20})^2 / 3] = 8.62\text{dBi} > 6\text{dBi}$, so the power density limit shall be reduced to $30-(8.62-6) = 27.38\text{dBm}$.

802.11ac (VHT20)

TX chain	Channel	Freq. (MHz)	PSD (dBm/300kHz)	PSD (dBm/500kHz)	10 log (N=3) dB	Total PSD (dBm/500kHz)	Limit (dBm/500kHz)	Pass /Fail
0	149	5745	0.63	2.85	4.77	7.62	27.38	Pass
	157	5785	0.33	2.55	4.77	7.32	27.38	Pass
	165	5825	0.30	2.52	4.77	7.29	27.38	Pass
1	149	5745	-0.68	1.54	4.77	6.31	27.38	Pass
	157	5785	-0.63	1.59	4.77	6.36	27.38	Pass
	165	5825	-0.64	1.58	4.77	6.35	27.38	Pass
2	149	5745	0.93	3.15	4.77	7.92	27.38	Pass
	157	5785	0.81	3.03	4.77	7.80	27.38	Pass
	165	5825	0.51	2.73	4.77	7.50	27.38	Pass

Note: 1. Directional gain = $10 \log[(10^{G1/20} + 10^{G2/20} + 10^{G3/20})^2 / 3] = 8.62\text{dBi} > 6\text{dBi}$, so the power density limit shall be reduced to $30-(8.62-6) = 27.38\text{dBm}$.

802.11ac (VHT40)

TX chain	Chan.	Chan. Freq. (MHz)	PSD W/O Duty Factor		10 log (N=3) dB	Duty Factor (dB)	Total PSD With Duty Factor (dBm/500kHz)	Limit (dBm/500kHz)	Pass /Fail
			(dBm/300kHz)	(dBm/500kHz)					
0	151	5755	-3.43	-1.21	4.77	0.13	3.69	27.38	Pass
	159	5795	-3.59	-1.37	4.77	0.13	3.53	27.38	Pass
1	151	5755	-4.40	-2.18	4.77	0.13	2.72	27.38	Pass
	159	5795	-4.69	-2.47	4.77	0.13	2.43	27.38	Pass
2	151	5755	-3.06	-0.84	4.77	0.13	4.06	27.38	Pass
	159	5795	-3.38	-1.16	4.77	0.13	3.74	27.38	Pass

Note: 1. Directional gain = $10 \log[(10^{G1/20} + 10^{G2/20} + 10^{G3/20})^2 / 3] = 8.62\text{dBi} > 6\text{dBi}$, so the power density limit shall be reduced to $30-(8.62-6) = 27.38\text{dBm}$.

2. Refer to section 3.3 for duty cycle spectrum plot.

802.11ac (VHT80)

TX chain	Chan.	Chan. Freq. (MHz)	PSD W/O Duty Factor		10 log (N=3) dB	Duty Factor (dB)	Total PSD With Duty Factor (dBm/500kHz)	Limit (dBm/500kHz)	Pass /Fail
			(dBm/300kHz)	(dBm/500kHz)					
0	151	5755	-8.41	-6.19	4.77	0.26	-1.16	27.38	Pass
1	151	5755	-8.85	-6.63	4.77	0.26	-1.60	27.38	Pass
2	151	5755	-8.44	-6.22	4.77	0.26	-1.19	27.38	Pass

Note: 1. Directional gain = $10 \log[(10^{G1/20} + 10^{G2/20} + 10^{G3/20})^2 / 3] = 8.62\text{dBi} > 6\text{dBi}$, so the power density limit shall be reduced to $30-(8.62-6) = 27.38\text{dBm}$.

2. Refer to section 3.3 for duty cycle spectrum plot.

Spectrum Plot of Worst Value

802.11a – Chain 2: CH 149

802.11ac (VHT20) – Chain 2: CH 149

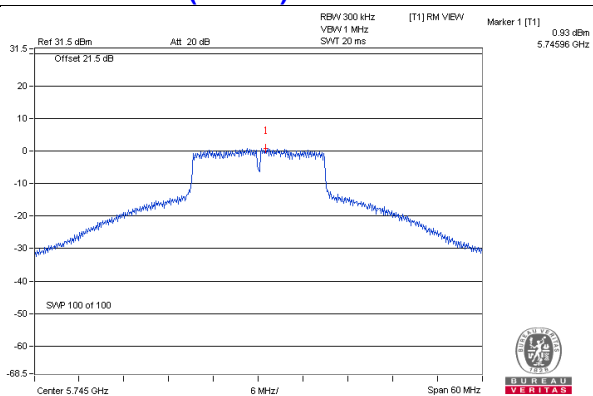
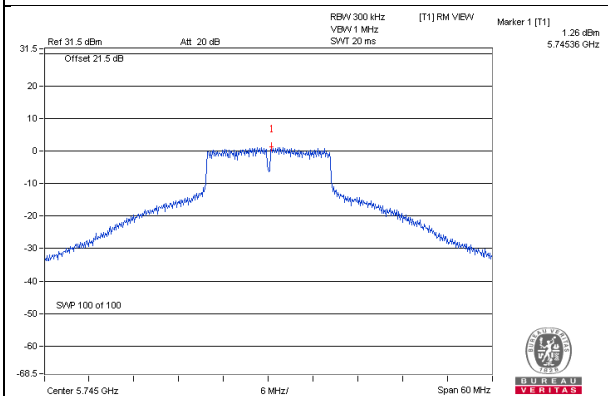

802.11ac (VHT40) – Chain 2: CH 151

802.11ac (VHT80) – Chain 0: CH 155

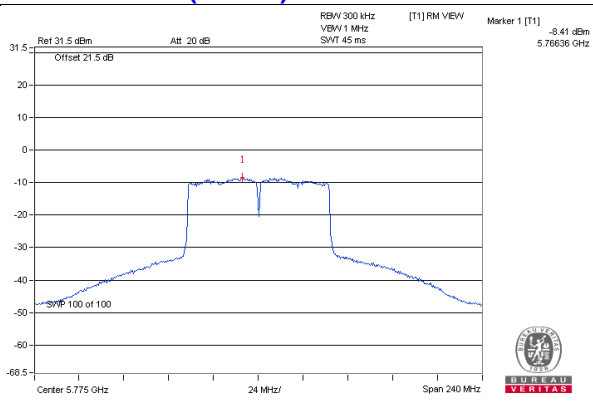
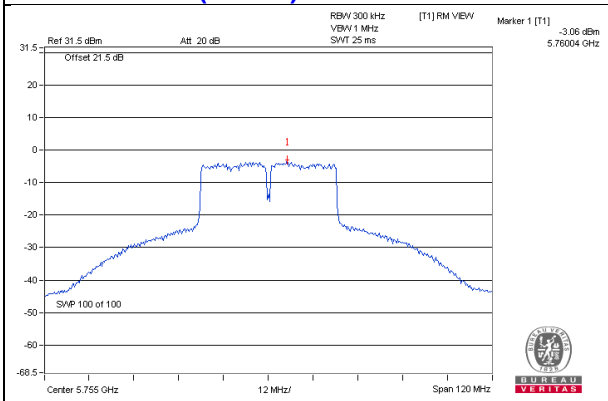

4.6 Frequency Stability Measurement

4.6.1 Limits of Frequency Stability Measurement

The frequency of the carrier signal shall be maintained within band of operation

4.6.2 Test Setup

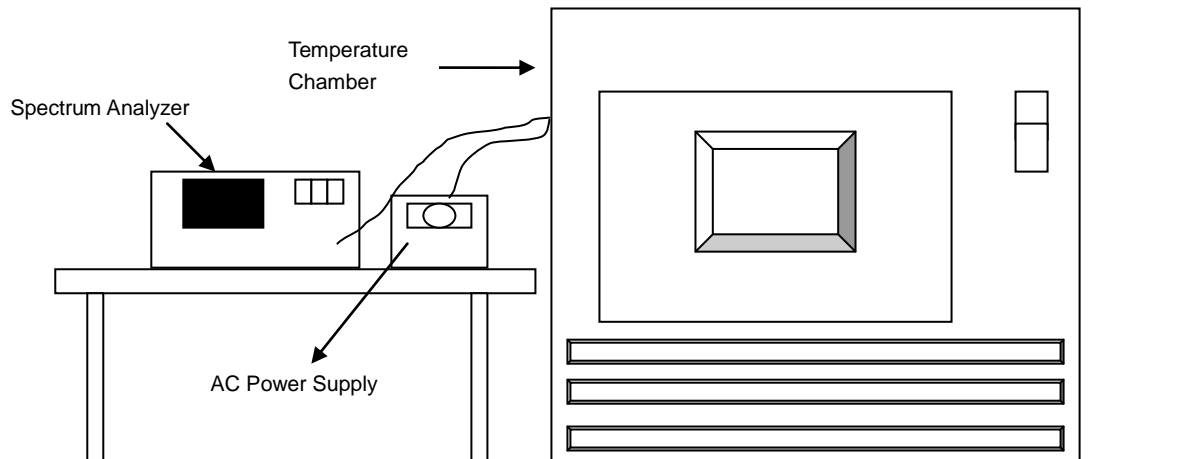

4.6.3 Test Instruments

Refer to section 4.1.2 to get information of above instrument.

4.6.4 Test Procedure

- The EUT was placed inside the environmental test chamber and powered by nominal AC voltage.
- Turn the EUT on and couple its output to a spectrum analyzer.
- Turn the EUT off and set the chamber to the highest temperature specified.
- Allow sufficient time (approximately 30 min) for the temperature of the chamber to stabilize, turn the EUT on and measure the operating frequency after 2, 5, and 10 Minutes.
- Repeat step 2 and 3 with the temperature chamber set to the lowest temperature.
- The test chamber was allowed to stabilize at +20 degree C for a minimum of 30 Minutes. The supply voltage was then adjusted on the EUT from 85% to 115% and the frequency record.

4.6.5 Deviation from Test Standard

No deviation.

4.6.6 EUT Operating Condition

Set the EUT transmit at un-modulation mode to test frequency stability.

4.6.7 Test Results

Frequency Stability Versus Temp.									
Operating Frequency: 5180 MHz									
TEMP. (°C)	Power Supply (Vac)	0 Minute		2 Minute		5 Minute		10 Minute	
		Measured Frequency (MHz)	Pass/Fail	Measured Frequency (MHz)	Pass/Fail	Measured Frequency (MHz)	Pass/Fail	Measured Frequency (MHz)	Pass/Fail
50	120	5180.002	PASS	5180.0035	PASS	5180.0026	PASS	5180.0029	PASS
40	120	5180.0131	PASS	5180.0117	PASS	5180.0141	PASS	5180.0119	PASS
30	120	5180.0089	PASS	5180.0136	PASS	5180.0108	PASS	5180.0126	PASS
20	120	5180.0217	PASS	5180.0212	PASS	5180.0218	PASS	5180.0199	PASS
10	120	5179.9751	PASS	5179.9773	PASS	5179.9774	PASS	5179.9763	PASS
0	120	5179.987	PASS	5179.9863	PASS	5179.9887	PASS	5179.9854	PASS
-10	120	5179.9853	PASS	5179.984	PASS	5179.9804	PASS	5179.9835	PASS
-20	120	5180.0119	PASS	5180.015	PASS	5180.0136	PASS	5180.0123	PASS
-30	120	5180.0108	PASS	5180.0103	PASS	5180.008	PASS	5180.0095	PASS

Frequency Stability Versus Voltage									
Operating Frequency: 5180 MHz									
TEMP. (°C)	Power Supply (Vac)	0 Minute		2 Minute		5 Minute		10 Minute	
		Measured Frequency (MHz)	Pass/Fail	Measured Frequency (MHz)	Pass/Fail	Measured Frequency (MHz)	Pass/Fail	Measured Frequency (MHz)	Pass/Fail
20	138	5180.0218	PASS	5180.0207	PASS	5180.0225	PASS	5180.0204	PASS
	120	5180.0217	PASS	5180.0212	PASS	5180.0218	PASS	5180.0199	PASS
	102	5180.0207	PASS	5180.0212	PASS	5180.0223	PASS	5180.0193	PASS

4.7 6dB Bandwidth Measurement

4.7.1 Limits of 6dB Bandwidth Measurement

The minimum of 6dB Bandwidth Measurement is 0.5MHz.

4.7.2 Test Setup

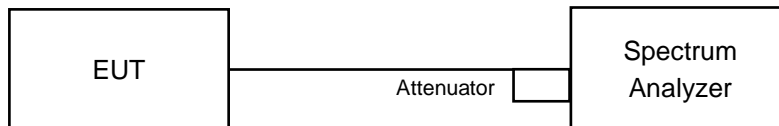

4.7.3 Test Instruments

Refer to section 4.1.2 to get information of above instrument.

4.7.4 Test Procedure

MEASUREMENT PROCEDURE REF

- Set resolution bandwidth (RBW) = 100kHz
- Set the video bandwidth (VBW) $\geq 3 \times$ RBW, Detector = Peak.
- Trace mode = max hold.
- Sweep = auto couple.
- Measure the maximum width of the emission that is constrained by the frequencies associated with the two amplitude points (upper and lower) that are attenuated by 6 dB relative to the maximum level measured in the fundamental emission

4.7.5 Deviation from Test Standard

No deviation.

4.7.6 EUT Operating Condition

The software provided by client to enable the EUT under transmission condition continuously at lowest, middle and highest channel frequencies individually.

4.7.7 Test Results (Mode 1)

802.11a

Channel	Frequency (MHz)	6dB Bandwidth (MHz)			Minimum Limit (MHz)	Pass / Fail
		Chain 0	Chain 1	Chain 2		
149	5745	15.79	16.34	15.54	0.5	PASS
157	5785	15.75	16.32	15.75	0.5	PASS
165	5825	15.45	16.31	15.78	0.5	PASS

802.11ac (VHT20)

Channel	Frequency (MHz)	6dB Bandwidth (MHz)			Minimum Limit (MHz)	Pass / Fail
		Chain 0	Chain 1	Chain 2		
149	5745	16.42	17.06	16.37	0.5	PASS
157	5785	16.33	16.94	15.53	0.5	PASS
165	5825	16.33	16.61	16.98	0.5	PASS

802.11ac (VHT40)

Channel	Frequency (MHz)	6dB Bandwidth (MHz)			Minimum Limit (MHz)	Pass / Fail
		Chain 0	Chain 1	Chain 2		
151	5755	35.92	36.16	36.06	0.5	PASS
159	5795	35.61	36.27	35.92	0.5	PASS

802.11ac (VHT80)

Channel	Frequency (MHz)	6dB Bandwidth (MHz)			Minimum Limit (MHz)	Pass / Fail
		Chain 0	Chain 1	Chain 2		
155	5775	75.72	75.76	75.70	0.5	PASS

Spectrum Plot of Worst Value

802.11a_Chain 0 / CH165

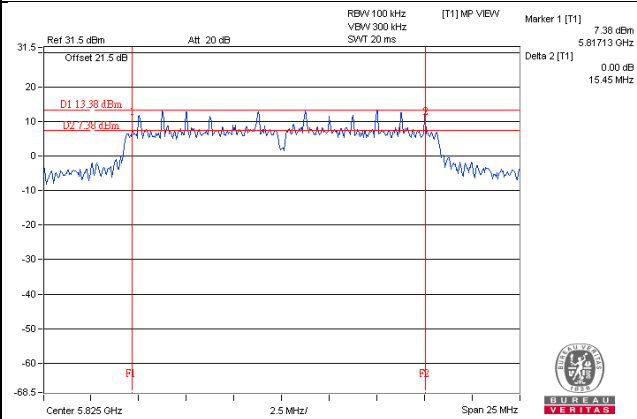

802.11ac (VHT20)_Chain 2 / CH157

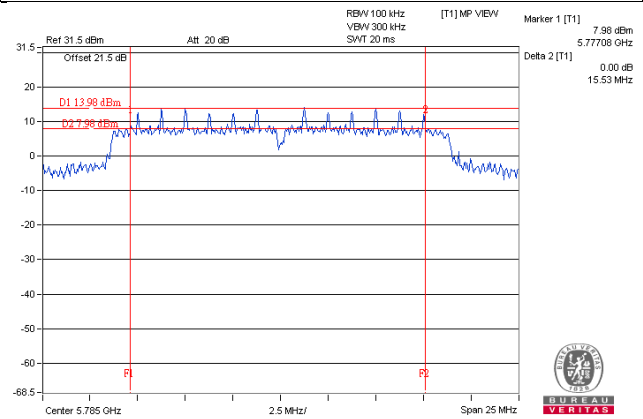

802.11ac (VHT40)_Chain 0 / CH159

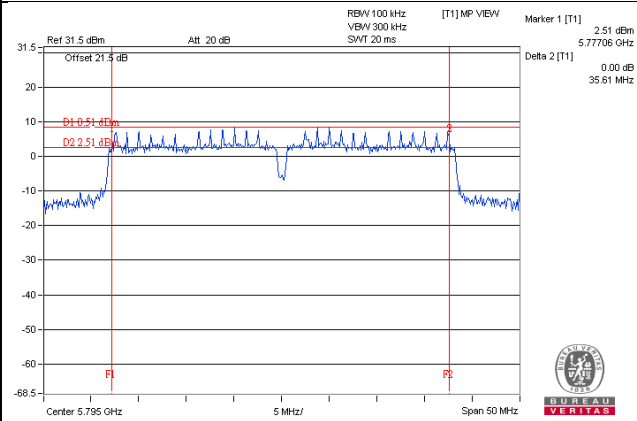

802.11ac (VHT80)_Chain 2 / CH155

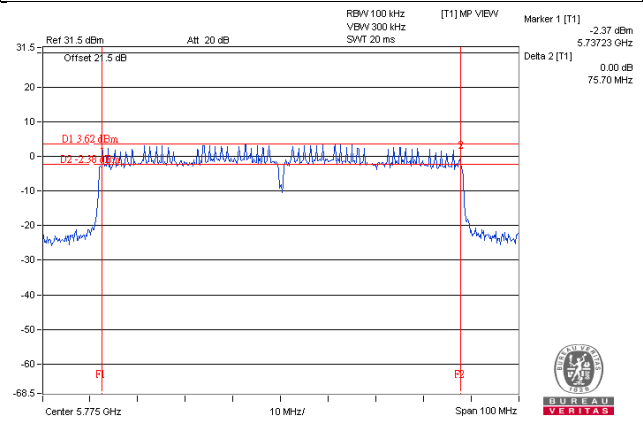

5 Pictures of Test Arrangements

Please refer to the attached file (Test Setup Photo).

Annex A- Radiated Out of Band Emission (OOBE) Measurement (For U-NII-3 band)

802.11a

CH 149 5745 MHz

Horizontal

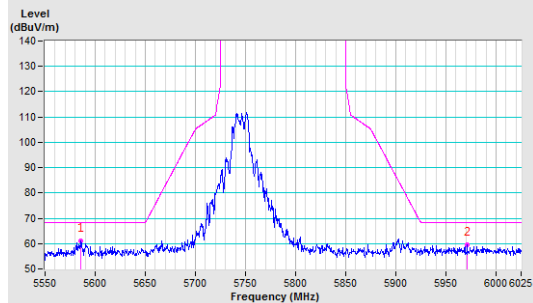

Vertical



CH 157 5785 MHz

Horizontal

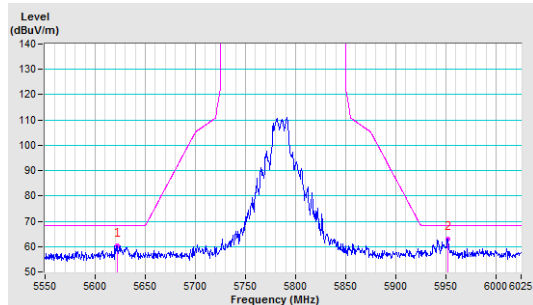

Vertical

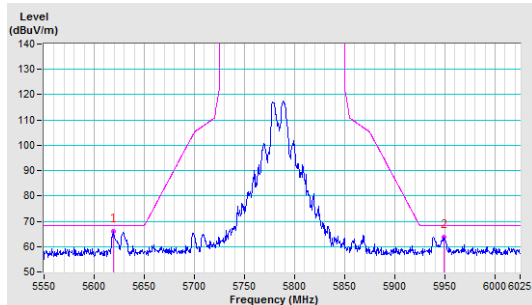

CH 165 5825 MHz

Horizontal

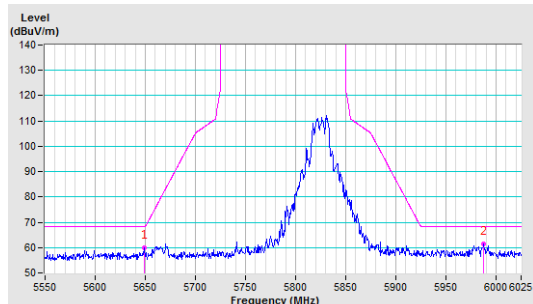

Vertical

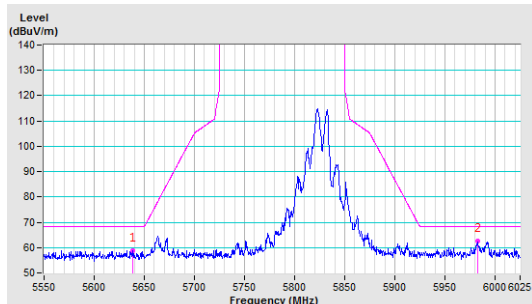

802.11ac (VHT20)

CH 149 5745 MHz

Horizontal

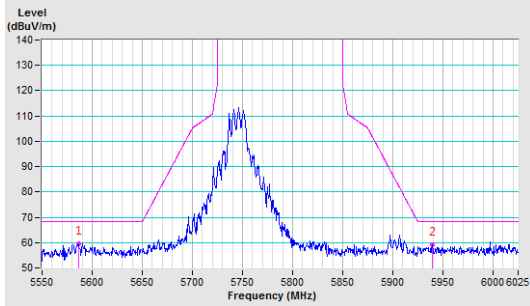

Vertical

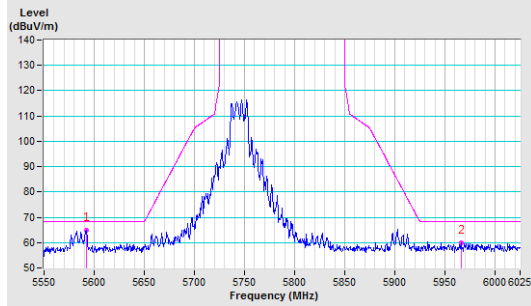

CH 157 5785 MHz

Horizontal

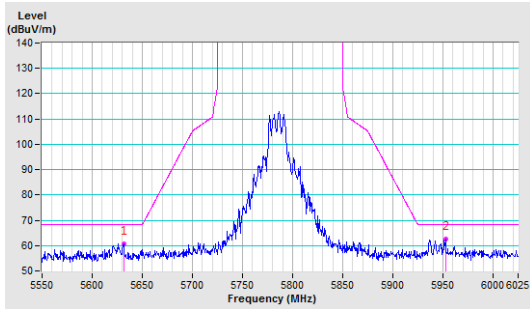

Vertical

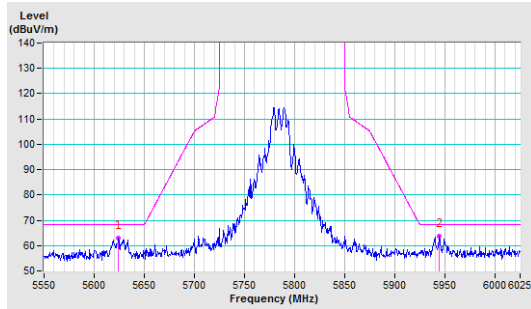

CH 165 5825 MHz

Horizontal

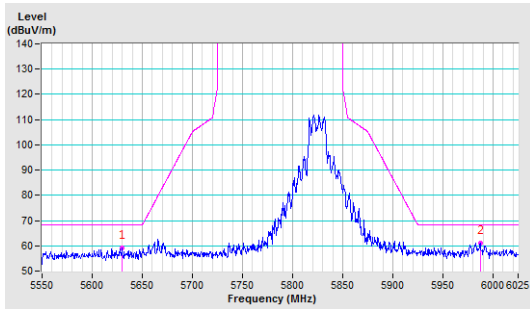

Vertical

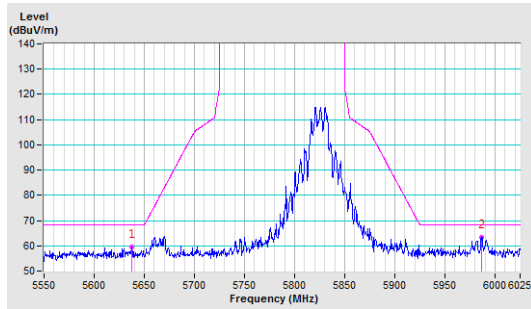

802.11ac (VHT40)

CH 151 5755 MHz

Horizontal

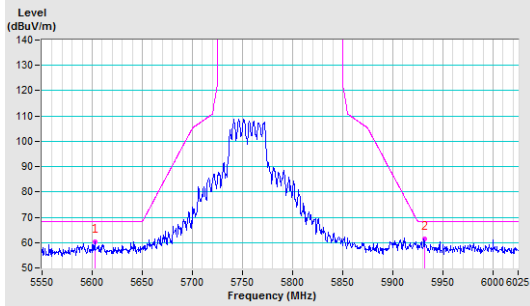

Vertical

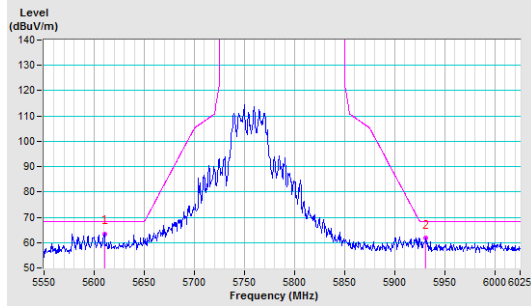

CH 159 5795 MHz

Horizontal

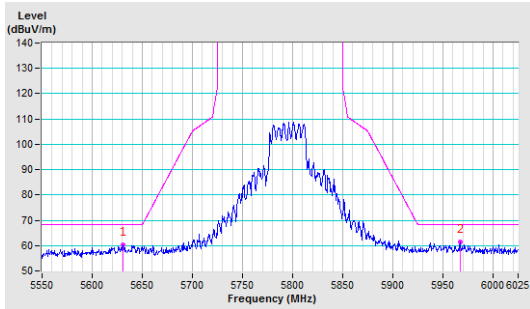

Vertical

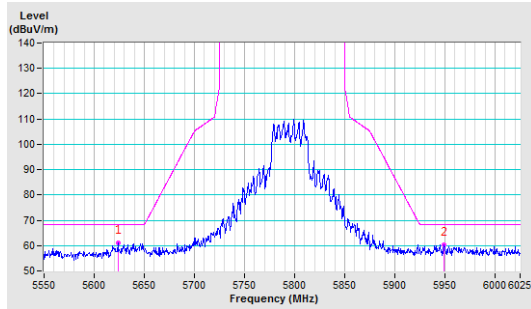

802.11ac (VHT80)

CH 155 5775 MHz

Horizontal

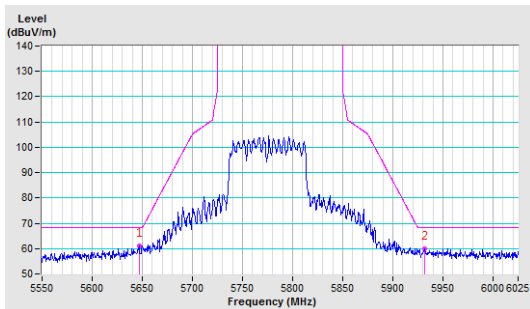

Vertical

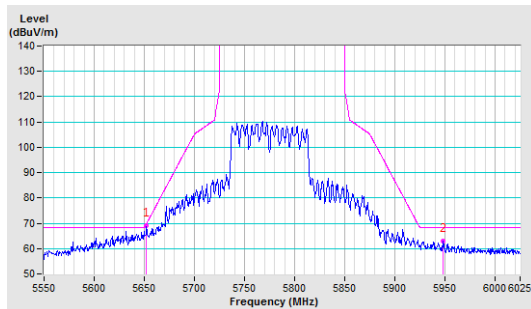

Appendix – Information on the Testing Laboratories

We, Bureau Veritas Consumer Products Services (H.K.) Ltd., Taoyuan Branch, were founded in 1988 to provide our best service in EMC, Radio, Telecom and Safety consultation. Our laboratories are FCC recognized accredited test firms and accredited according to ISO/IEC 17025.

If you have any comments, please feel free to contact us at the following:

Linko EMC/RF Lab

Tel: 886-2-26052180

Fax: 886-2-26051924

Hsin Chu EMC/RF/Telecom Lab

Tel: 886-3-6668565

Fax: 886-3-6668323

Hwa Ya EMC/RF/Safety Lab

Tel: 886-3-3183232

Fax: 886-3-3270892

Email: service.adt@tw.bureauveritas.com

Web Site: www.bureauveritas-adt.com

The address and road map of all our labs can be found in our web site also.

--- END ---