

## 1. Introduction

This F@ST 3284u Cable Gateway is an Embedded Media Terminal Adapter (EMTA) which is CableLabs DOCSIS 3.0 and PacketCable 1.5 compliant. It provides high-speed Internet access as well as cost-effective, toll-quality telephone voice and fax/modem services over residential, commercial, and education subscribers on public and private networks via an existing CATV infrastructure. F@ST 3284u offers high-speed LAN connectivity with 4 Gigabit Ethernet ports and one integrated Wireless LAN access point compatible with IEEE 802.11a/b/g/n. The Wireless access point is operating on 2.4GHz band.

### Package Contents

F@S T3284u Gateway	x1
Ethernet Cable (RJ45)	x1
Phone Cable (RJ11)	x1
Quick Start Guide	x1
Power Supply Unit	x1

## 2. Hardware Connection

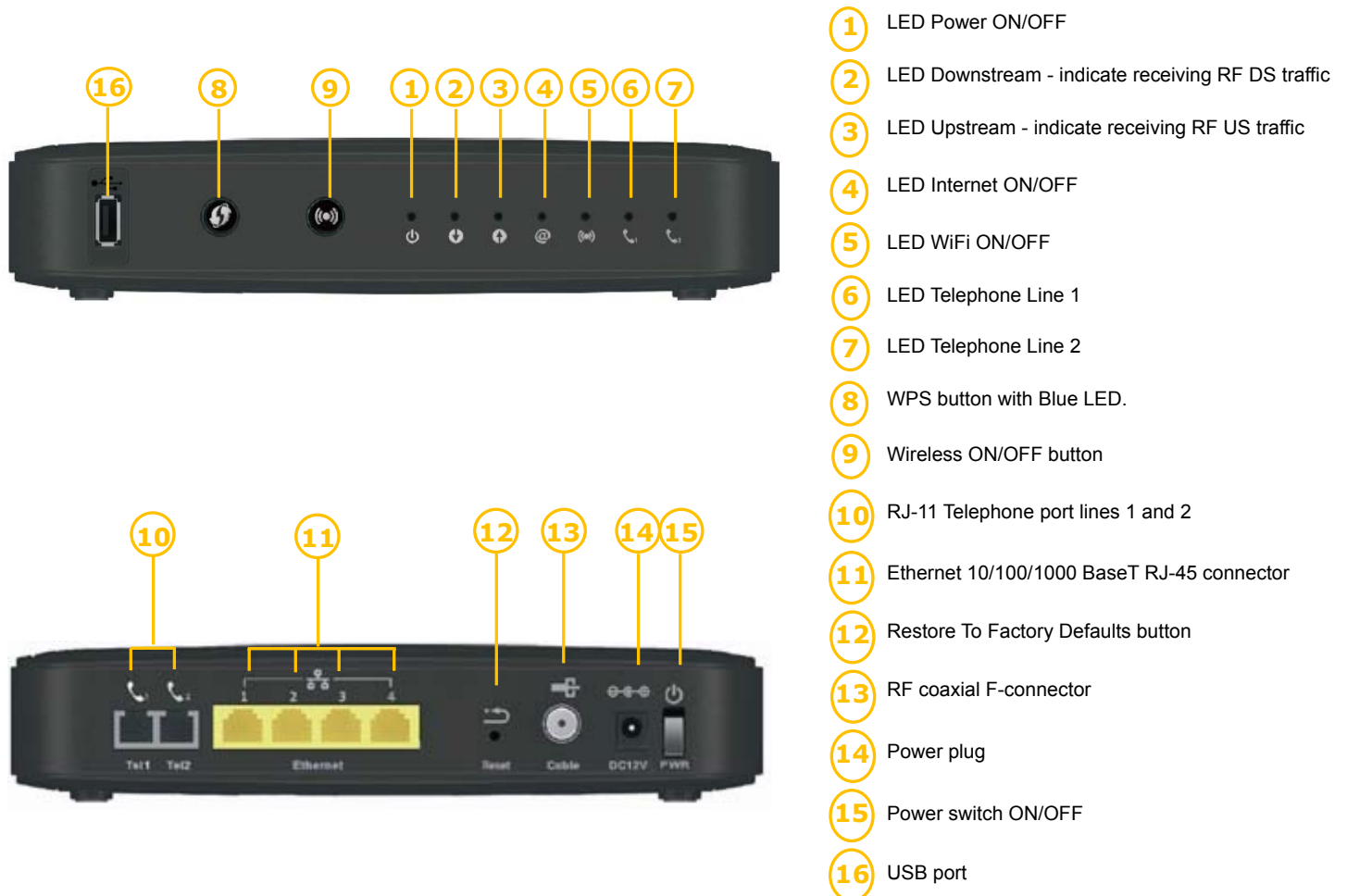

## Wall Mounting

The number of the screw: 2 pcs

Direction for wall mounting: LED panel upward.

Dimension for the screw: 5~7.5 mm

There are 2 slots on the underside of the modem that can be used for wall mounting.

You will need 2 suitable screws which screw diameter would be 5~7.5 mm to wall mount the Cable Gateway.

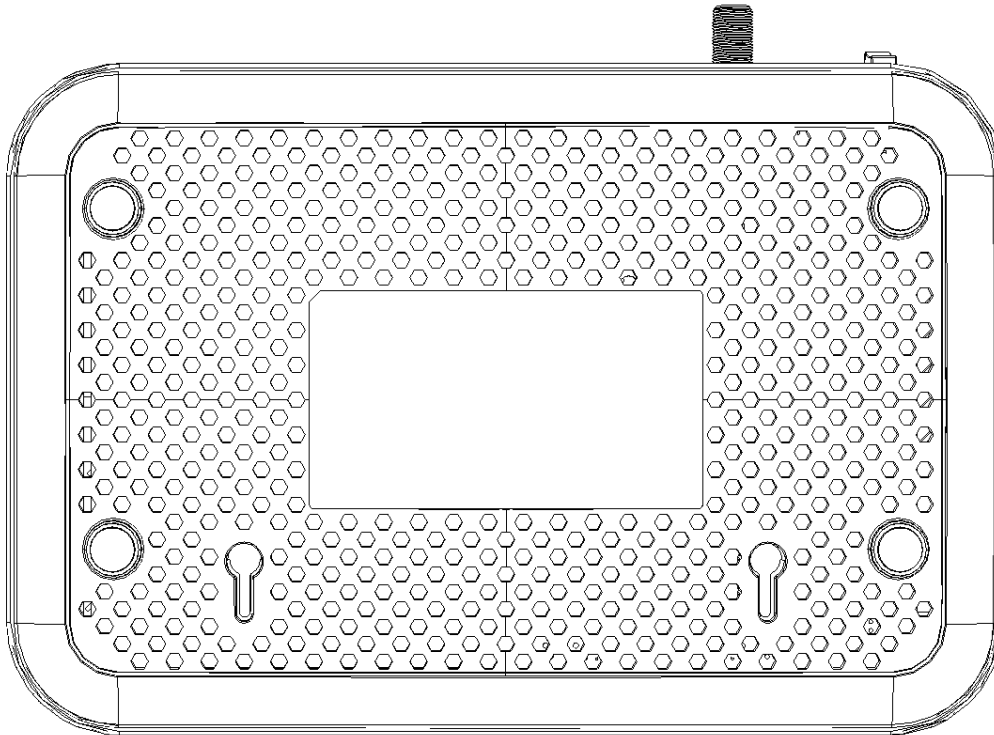

**Note:** When wall mounting the unit, ensure that it is within reach of the power outlet.

To wall mount the unit:

1. Ensure that the wall you use is smooth, flat, dry and sturdy and use the 2 screw holes which are 120 mm apart from each other.
2. Fix the screws into wall, leaving their heads 3 mm (0.12 inch) clear of the wall surface.
3. Remove any connections to the unit and locate it over the screw heads. When in line, gently push the unit on to the wall and move it downwards to secure.

### 3. Connecting the F@ST3284 Gateway to Your Computer

#### Installation Procedure for Ethernet Interface

Follow the steps below for proper installation:

1. Make sure your computer meets the system requirements.
2. Connect a coaxial cable to the wall plug
3. Connect a coaxial cable to the CABLE connector on the F@ST3284u and screw it at the bottom manually (do not force).

---

**Note:** To speed up the registration process of F@ST3284u the coaxial cable should be connected to the gateway prior to the power connector.

---

4. Connect the RJ45 Ethernet cable to the **ETHERNET** connector on the gateway, connect the other end with the 10/100/1000BaseT Ethernet port on your computer.
5. Plug the RJ11 telephone cord(s) to the TEL 1 or TEL2 connector (s) of the cable modem. (Plug the RJ11 telephone cord(s) to the PSTN connector on the modem, connect to the PSTN service provider. This step is for EMTA with PSTN model only.)
6. Plug the power supply unit into the **POWER** connector of the modem.
7. Plug the other end of the power supply unit into a power outlet.
8. Power ON the F@ST3284u by pressing the ON/OFF button on the rear panel of the F@ST3284u.
9. The cable gateway will look for the proper cable modem signal in the Cable Television network and process the initial registration. The cable gateway is ready for data transfer after the LED "INTERNET" is in solid white. The gateway is ready to make a phone call after the LED "Tel1" or "Tel2" is in solid white.

---

**Note:** The **RESET** button at the rear panel is for maintenance purpose only.

---

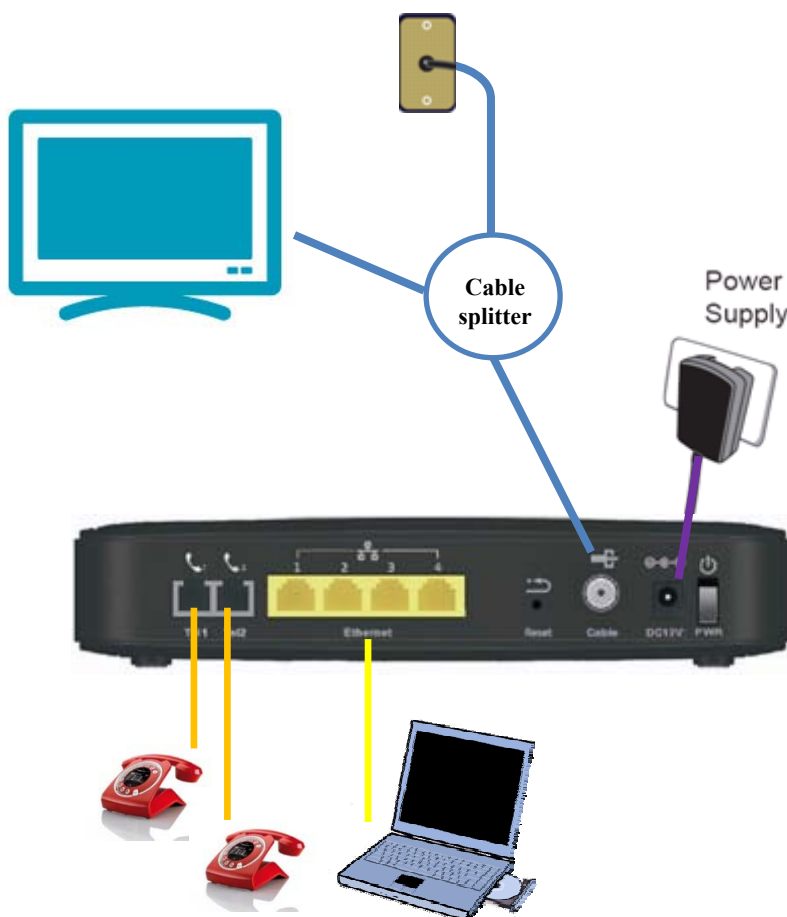

*The screen of the coaxial cable is intended to be connected to earth in the building installation*

# 4. Wireless Connection

## Step 1



- Under the gateway, on the label, note the reference of SSID and WPA wireless password.

## Step 3



- In this new Window, search for the SSID value and select it by double clicking on it.

## Step 2

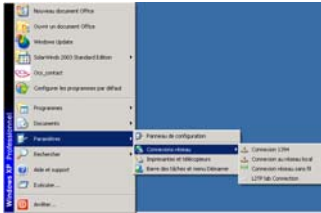

- Click on "Start" then on:
  - Network Connection
  - Wireless network connection

## Step 4

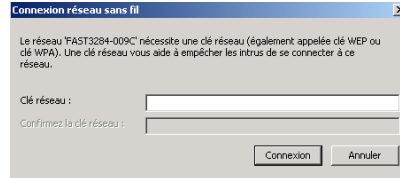

- The computer asks for a password. It is the WPA wireless password.
- Once the password entered twice, press "Connection" button. WiFi Configuration is finished.

# 5. F@ST3284u Personalization

## Step 1

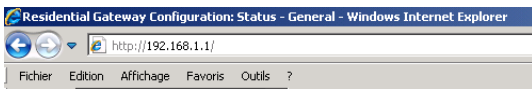

- Open an Internet session and type the following address: <http://192.168.1.1>

## Step 2

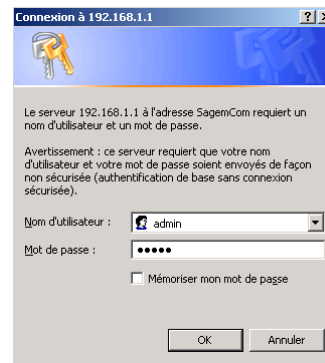

- Connect by typing:
  - Username: **admin**
  - Password: **admin**
- Click on "OK" button

## Step 3

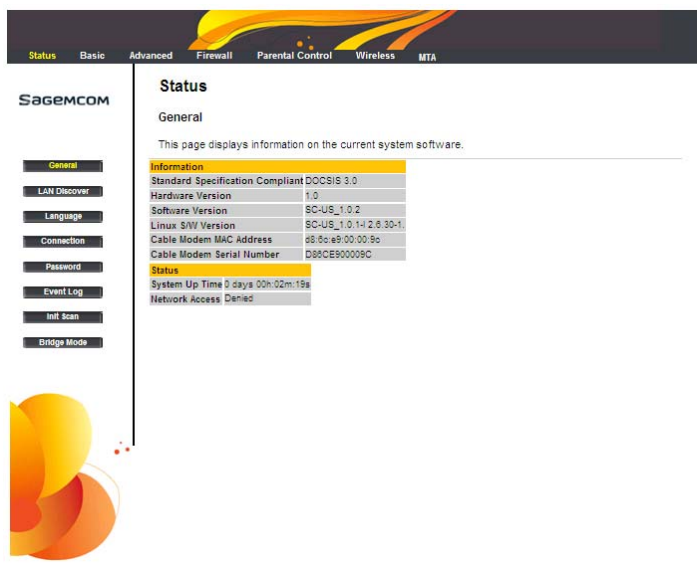

## Status

To know the state of your connection of your F@ST3284u

## Basic

To perform the basic configuration of your F@ST3284u

## Advanced

To perform advanced routing configuration of your F@ST3284u

## Firewall

To protect your LAN equipment from malicious attacks

## Parental Control

To safely restrict and control the Internet usage to your family

## Wireless

To configure the WiFi network of your F@ST3284u

## MTA

To check the telephony status of your F@ST3284u

## 6. Precautions and Warnings

- Before connecting and disconnecting cables, stop using the F@ST3284u, and then disconnect it from the power supply. Ensure that your hands are dry during operation.
- Keep the F@ST3284u far from sources of heat and fire, such as a heater or a candle.
- Do not block the openings on the F@ST3284u with any object. Reserve a minimum space of 10 cm around the F@ST3284u for heat dissipation.
- Place the F@ST3284u on a stable surface in a cool and well-ventilated indoor area. Do not expose the F@ST3284u to direct sunlight. Use the F@ST3284u in an area with a temperature ranging from 0°C to 40°C.
- Keep the F@ST3284u far from electronic appliances that generate strong magnetic or electric fields, such as a microwave oven or a refrigerator.
- Do not place any object (such as a candle or a water container) on the F@ST3284u. If any foreign object or liquid enters the device, stop using the device immediately, power it off, remove all the cables connected to it, and then contact an authorized service center.
- During thunderstorms, power off the F@ST3284u, and then remove all the cables connected to it to prevent it from getting damaged due to lightning strikes.
- Do not use the F@ST3284u or Power Supply Unit (PSU) after a fall or strong impact.
- Do not use in high dust, or with dampness exceeding 80%.
- Do not open or service the F@ST3284u or PSU. In any event of failure, contact the support center.
- Disconnect the PSU before cleaning.
- This F@ST3284u produces radio frequency energy in the 2.4 GHz spectrum. It must be positioned to minimum distance of 20 cm from any nearby person.
- The F@ST3284u must operate at an altitude between 0 and 2000m.

### Electrical warnings

- The connection of the product to electrical sector is of type A.
- The power supply is designed to be connected to a network feed TT or TN
- It can not be connected to an electrical installation type scheme IT (supply independent neutral).
- The F@ST3284u must exclusively be used with the Power Supply Unit (PSU) delivered within the same package.
- The PSU must be plugged to an electrical network delivering a 110V nominal voltage in 60Hz.
- Protection against short circuits and leakage between phases, neutral and earth must be assured by the building's electrical installation. The power circuit of this equipment must be fitted with a 16A protection against overcurrent and differential protection.
- Insure the cable and AC input are not damaged. Do not cut, break, or bend the DC cable
- The TEL1 and TEL2 inputs allow you to connect a phone device. The wire connections between the inputs TEL1/TEL2 and the phone must not leave the building.

## 7. Others



This symbol on the device (and any included batteries) indicates that the device (and any included batteries) should not be disposed of as normal household garbage. Do not dispose of your device or batteries as unsorted municipal waste. The device (and any batteries) should be handed over to a certified collection point for recycling or proper disposal at the end of its life.

For more detailed information about the recycling of the device or batteries, contact your local city office, the household waste disposal service, or the retail store where you purchased this device.

The disposal of this device is subject to the Waste from Electrical and Electronic Equipment (WEEE) Directive of the European Union. The purpose for separating WEEE and batteries from other waste is to minimize any environmental impact and health hazard due to the presence of hazardous substances.



The CE marking certifies that the product complies with the essential requirements of the R&TTE directive of the European Parliament and Council on radio equipment and telecommunication terminal equipment, and the mutual acknowledgement of their compliance, together with the essential requirements of directive ErP 2009/125/CE on ecodesign requirements. This marking certifies that the equipment is compliant in respect of the health and safety of users, the electromagnetic compatibility of the equipment and the correct use of the radio frequency spectrum and reduction of the impacts of the product on the environment.

## Important Information about the Sagemcom F@ST3284u:

### Installation and Safe Usage Instructions:

1. Place the router in a horizontal orientation on a flat surface.
2. Connect the manufacturer supplied AC to DC power adapter. The F@ST3284u requires the use of a 12 VDC, 2000 mA power adapter. Only use a manufacturer supplied and approved power adapter and Ethernet cable.
3. Connect the F@ST3284u to the AC Mains in accordance with the installation instructions in this booklet, and the markings on the identification label (voltage, current, and frequency of electricity network).
4. Connect the Ethernet cable (provided) to one of the RJ45 ports on the product labeled "1", "2", "3", or "4". Then connect the other end of the Ethernet Cable to the Ethernet port of a computer. Repeat as necessary for the other available Ethernet ports.

When using this device, basic safety precautions should always be followed to reduce the risk of fire, electric shock, and injury to persons including the following:

1. Do not use this product near water and avoid contact with moisture. For example, do not use near a bathtub, wash bowl, kitchen sink, laundry tub, in a wet basement, or near a swimming pool. Care should be taken so that liquids are not spilled on this equipment.
2. This equipment is for indoor use only, do not place or install in an outdoor location.
3. Place your product on a firm, solid surface, no obstacle at a minimum distance of 20cm (0.65ft). If you put it on something unsteady, it may fall and be damaged. If you place it on a soft surface, such as rug, sofa or cushion, the vents may be blocked, causing the product to overheat.
4. Never insert objects into the vents of this equipment as this can result in the risk of electrical shock or fire.
5. As the power adapter is the only way to connect to the electrical network, the product must be installed near an easily accessed power outlet.
6. This equipment should only be operated from the type of power supply (Voltage and Current) indicated on the marking label.
7. Do not overload wall outlets or extension cords. Doing so can result in the risk of fire or electrical shock.
8. Avoid blocking any vent openings or exhaust exits on this equipment. Do not place equipment in a built-in installation such as a cabinet that may impede the flow of air through the ventilation openings.
9. The equipment should be situated away from heat sources such as radiators, heat registers, stoves, or other heat producing appliances and equipment.
10. Care should be taken to ensure that the power cord is routed, so it is not likely to be walked on or pinched by items placed upon or next to it.
11. Unplug this equipment before cleaning. Do not use liquid cleaners or aerosol cleaners. Use a damp cloth for cleaning only.
12. This equipment is not user serviceable and is to be serviced by qualified personnel only. Do not disassemble this equipment. If service is required, disconnect all power from the equipment and consult qualified service personnel.
13. To disconnect this equipment from AC power, unplug the power supply from the AC wall socket.
14. Connect only to in house equipment (SELV interface). It is not allowed to connect to public cable distribution or cable television network.
15. Use the product in the environment specified as below:
  - Air temperature between 0°C and +40°C.
  - Relative humidity between 20% and 90%.
  - Altitude: 5000 meters (16404ft) maximum.

**North American Cable Installer:** This reminder is provided to call your attention to Article 820.93 of the National Electrical Code (Section 54 of the Canadian Electrical Code, Part 1) which provides guidelines for proper grounding and, in particular, specifies that the cable ground shall be connected to the grounding system of the building as close to the point of cable entry as practical.

### Save these Instructions!

## Federal Communications Commission (FCC) Statements

This device complies with Part 15 of the FCC Rules. Operation is subject to the following two conditions:  
(1) This device may not cause harmful interference, and  
(2) This device must accept any interference received, including interference that may cause undesired operation.

## Label



## Modifications:

You are cautioned that changes or modifications not expressly approved by the party responsible for compliance could void your authority to operate the equipment.

FCC Responsible Party: Sagemcom USA  
14651 N. Dallas Parkway  
Suite 900  
Dallas, TX 75254  
Phone: 972-674-4100

## Radio Frequency Interference Statement

Note: This equipment has been tested and found to comply with the limits for a Class B digital device, pursuant to Part 15 of the FCC Rules. These limits are designed to provide reasonable protection against harmful interference in a residential installation. This equipment generates, uses and can radiate radio frequency energy and, if not installed and used in accordance with the instructions, may cause harmful interference to radio communications. However, there is no guarantee that interference will not occur in a particular installation. If this equipment does cause harmful interference to radio or television reception, which can be determined by turning the equipment off and on, the user is encouraged to try to correct the interference by one or more of the following measures:

1. Reorient or relocate the receiving antenna.
2. Increase the separation between the equipment and receiver.

3. Connect the equipment into an outlet on a circuit different from that to which the receiver is connected.
4. Consult the dealer or an experienced radio/TV technician for help.

## **FCC Radiation Exposure Statement**

This equipment complies with FCC radiation exposure limits set forth for an uncontrolled environment. This transmitter must not be co-located or operating in conjunction with any other antenna or transmitter.

This device produces radio frequency energy in the 2.4GHz spectrum. The antenna must be positioned to keep a minimum distance of 20cm (0.65ft) from the radiating element to any nearby person.

Issued by Sagemcom Broadband SAS  
Sagemcom  
250, route de l'Empereur - 92500 RUEIL MALMAISON  
FRANCE

© Sagemcom Broadband SAS 2012  
All rights reserved. Subject to availability.  
Rights of modifications reserved.  
[www.sagemcom.com](http://www.sagemcom.com)



## Wall Mounting (Optional)

While many users place their F@ST3284u product on their desk, it can be optionally wall mounted.

The number of the screw: 2 pcs.

Direction for wall mounting: LED panel upward.

Dimension for the screw: 5~7.5 mm.

There are 2 slots on the underside of the modem that can be used for wall mounting.

You will need 2 suitable screws which screw diameter would be 5~7.5 mm to wall mount the F@ST3284u.

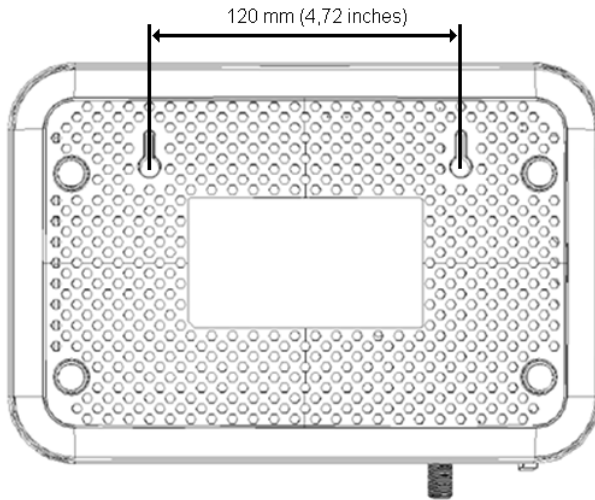

Note: When wall mounting the unit, ensure that it is within reach of the power outlet.

To wall mount the unit:

1. Ensure that the wall you use is smooth, flat, dry and sturdy and use the 2 screw holes which are 120mm (4.72 inch) apart from each other.
2. Fix the screws into wall, leaving their heads 3 mm (0.12 inch) clear of the wall surface.
3. Remove any connections to the unit and locate it over the screw heads. When in line, gently push the unit on to the wall and move it downwards to secure.

## **Federal Communication Commission Interference Statement**

This device complies with Part 15 of the FCC Rules. Operation is subject to the following two conditions: (1) This device may not cause harmful interference, and (2) this device must accept any interference received, including interference that may cause undesired operation.

This equipment has been tested and found to comply with the limits for a Class B digital device, pursuant to Part 15 of the FCC Rules. These limits are designed to provide reasonable protection against harmful interference in a residential installation. This equipment generates, uses and can radiate radio frequency energy and, if not installed and used in accordance with the instructions, may cause harmful interference to radio communications. However, there is no guarantee that interference will not occur in a particular installation. If this equipment does cause harmful interference to radio or television reception, which can be determined by turning the equipment off and on, the user is encouraged to try to correct the interference by one of the following measures:

- Reorient or relocate the receiving antenna.
- Increase the separation between the equipment and receiver.
- Connect the equipment into an outlet on a circuit different from that to which the receiver is connected.
- Consult the dealer or an experienced radio/TV technician for help.

FCC Caution: Any changes or modifications not expressly approved by the party responsible for compliance could void the user's authority to operate this equipment.

This transmitter must not be co-located or operating in conjunction with any other antenna or transmitter.

**Radiation Exposure Statement:**

This equipment complies with FCC radiation exposure limits set forth for an uncontrolled environment. This equipment should be installed and operated with minimum distance 20cm between the radiator & your body.

Note: The country code selection is for non-US model only and is not available to all US model. Per FCC regulation, all WiFi product marketed in US must fixed to US operation channels only.