

RF MEASUREMENT REPORT

FCC ID: VW3FAST266

Applicant: SAGEMCOM BROADBAND SAS

Product: Smart Wi-Fi Extender

Model No.: F@st 266 XXXXXXXXXXXX (XXXXXXXXXXXX, X can be A~Z, space and other presentation, XXXXXXXXXXXX can be replaced by LLA and other presentation, it is various by marketing purpose in different countries)

Brand Name: SAGEMCOM

FCC Classification: Digital Transmission System (DTS)

FCC Rule Part(s): Part 15 Subpart C (Section 15.247)

Result: Complies

Received Date: 2024-02-18

Test Date: 2024-03-15 ~ 2024-03-25

Reviewed By:

Sunny Sun

Approved By:

Robin Wu



The test results relate only to the samples tested.

This equipment has been shown to be capable of compliance with the applicable technical standards as indicated in the measurement report and was tested in accordance with the measurement procedures specified in ANSI C63.10-2013. Test results reported herein relate only to the item(s) tested.

The test report shall not be reproduced except in full without the written approval of MRT Technology (Suzhou) Co., Ltd.

Revision History

| Report No. | Version | Description | Issue Date | Note |
|---------------|---------|----------------|------------|-------|
| 2402RSU012-U2 | V01 | Initial Report | 2024-03-29 | Valid |
| | | | | |

CONTENTS

| Description | Page |
|--|-----------|
| 1. General Information | 5 |
| 1.1. Applicant | 5 |
| 1.2. Manufacturer | 5 |
| 1.3. Testing Facility | 5 |
| 1.4. Product Information..... | 6 |
| 1.5. Radio Specification under Test | 6 |
| 1.6. Working Frequencies | 7 |
| 1.7. Antenna Details..... | 7 |
| 2. Test Configuration | 8 |
| 2.1. Test Mode..... | 8 |
| 2.2. Test System Connection Diagram..... | 9 |
| 2.3. Test Software | 9 |
| 2.4. Applied Standards..... | 10 |
| 2.5. Test Environment Condition | 10 |
| 3. Antenna Requirements | 11 |
| 4. Measuring Instrument | 12 |
| 5. Decision Rules and Measurement Uncertainty | 14 |
| 5.1. Decision Rules | 14 |
| 5.2. Measurement Uncertainty | 14 |
| 6. Test Result..... | 15 |
| 6.1. Summary..... | 15 |
| 6.2. 6dB Bandwidth Measurement..... | 16 |
| 6.2.1. Test Limit | 16 |
| 6.2.2. Test Procedure..... | 16 |
| 6.2.3. Test Setting | 16 |
| 6.2.4. Test Setup | 16 |
| 6.2.5. Test Result | 16 |
| 6.3. Output Power Measurement | 17 |
| 6.3.1. Test Limit | 17 |
| 6.3.2. Test Procedure..... | 17 |
| 6.3.3. Test Setting | 17 |
| 6.3.4. Test Setup | 17 |
| 6.3.5. Test Result | 17 |
| 6.4. Power Spectral Density Measurement | 18 |
| 6.4.1. Test Limit | 18 |

| | | |
|---|---|------------|
| 6.4.2. | Test Procedure | 18 |
| 6.4.3. | Test Setting | 18 |
| 6.4.4. | Test Setup | 18 |
| 6.4.5. | Test Result | 19 |
| 6.5. | Conducted Band Edge and Out-of-Band Emissions Measurement | 20 |
| 6.5.1. | Test Limit | 20 |
| 6.5.2. | Test Procedure | 20 |
| 6.5.3. | Test Setting | 20 |
| 6.5.4. | Test Setup | 21 |
| 6.5.5. | Test Result | 21 |
| 6.6. | Radiated Spurious Emission Measurement..... | 22 |
| 6.6.1. | Test Limit | 22 |
| 6.6.2. | Test Procedure | 22 |
| 6.6.3. | Test Setting | 22 |
| 6.6.4. | Test Setup | 24 |
| 6.6.5. | Test Result | 25 |
| 6.7. | Radiated Restricted Band Edge Measurement | 26 |
| 6.7.1. | Test Limit | 26 |
| 6.7.2. | Test Procedure | 27 |
| 6.7.3. | Test Setting | 27 |
| 6.7.4. | Test Setup | 28 |
| 6.7.5. | Test Result | 28 |
| 6.8. | AC Conducted Emissions Measurement | 29 |
| 6.8.1. | Test Limit | 29 |
| 6.8.2. | Test Setup | 29 |
| 6.8.3. | Test Result | 29 |
| Appendix A – Test Result | | 30 |
| A.1 | Duty Cycle Test Result | 30 |
| A.2 | 6dB Bandwidth Test Result | 32 |
| A.3 | Output Power Test Result | 36 |
| A.4 | Power Spectral Density Test Result..... | 37 |
| A.5 | Conducted Band Edge and Out-of-Band Emissions Test Result..... | 44 |
| A.6 | Radiated Spurious Emission Test Result..... | 69 |
| A.7 | Radiated Restricted Band Edge Test Result..... | 77 |
| A.8 | AC Conducted Emissions Test Result | 163 |
| Appendix B – Test Setup Photograph | | 165 |
| Appendix C – EUT Photograph | | 166 |

1.4. Product Information

| | |
|---|---|
| Product | Smart Wi-Fi Extender |
| Model No. | F@st 266 XXXXXXXXXXXX (XXXXXXXXXXXX, X can be A~Z, space and other presentation, XXXXXXXXXXXX can be replaced by LLA and other presentation, it is various by marketing purpose in different countries) |
| EUT Serial No. | JY24022A4000008 |
| Wi-Fi Specification | 802.11a/b/g/n/ac/ax |
| Antenna Information | Refer to selection 1.7 |
| Working Voltage | Power by adapter |
| Operating Environment | Indoor Use |
| Accessory | |
| Adapter 1# | Model: MSG-V1500NR120-01810-US Input: 100-127V ~ 50/60Hz 0.7A Output: 12.0V=1.5A 18.0W |
| Adapter 2# | Model: ADS-18FQA-12 12018EPCU-L Input: 100-127V ~ 50/60Hz Max 0.7A Output: 12.0V = 1.5A |
| Remark: The information of EUT was provided by the manufacturer, and the accuracy of the information shall be the responsibility of the manufacturer. | |

1.5. Radio Specification under Test

| | | |
|-----------------------------|---|---|
| Frequency Range | 802.11b/g/n-HT20/ax-HE20: 2412 ~ 2462MHz 802.11n-HT40/ax-HE40: 2422 ~ 2452MHz | |
| Channel Number | 802.11b/g/n-HT20/ax-HE20: 11 802.11n-HT40/ax-HE40: 7 | |
| Type of Modulation | 802.11b: DSSS 802.11g/n: OFDM 802.11ax: OFDMA | |
| Data Rate | 802.11b: 1/2/5.5/11Mbps 802.11g: 6/9/12/18/24/36/48/54Mbps 802.11n: up to 600Mbps 802.11ax: up to 1147.2Mbps | |
| Channel Puncturing Function | <input type="checkbox"/> Supported | <input checked="" type="checkbox"/> Unsupported |
| Support RU | <input checked="" type="checkbox"/> Full RU | <input type="checkbox"/> Partial RU |

1.6. Working Frequencies

802.11b/g/n-HT20/ax-HE20

| Channel | Frequency | Channel | Frequency | Channel | Frequency |
|---------|-----------|---------|-----------|---------|-----------|
| 01 | 2412 MHz | 02 | 2417 MHz | 03 | 2422 MHz |
| 04 | 2427 MHz | 05 | 2432 MHz | 06 | 2437 MHz |
| 07 | 2442 MHz | 08 | 2447 MHz | 09 | 2452 MHz |
| 10 | 2457 MHz | 11 | 2462 MHz | -- | -- |

802.11n-HT40/ax-HE40

| Channel | Frequency | Channel | Frequency | Channel | Frequency |
|---------|-----------|---------|-----------|---------|-----------|
| 03 | 2422 MHz | 04 | 2427 MHz | 05 | 2432 MHz |
| 06 | 2437 MHz | 07 | 2442 MHz | 08 | 2447 MHz |
| 09 | 2452 MHz | -- | -- | -- | -- |

1.7. Antenna Details

| Antenna Type | Frequency Band (MHz) | Antenna Gain (dBi) | | | | Directional Gain (dBi) | |
|---|----------------------|--------------------|-------|-------|-------|------------------------|---------|
| | | Ant 0 | Ant 1 | Ant 2 | Ant 3 | For Power | For PSD |
| WiFi Internal Antenna (2.4GHz 2*2 MIMO & 5GHz 4*4 MIMO) | | | | | | | |
| PIFA Antenna | 2400 ~ 2483.5 | 2.75 | 2.85 | -- | -- | 2.85 | 3.35 |
| | 5150 ~ 5250 | 4.27 | 4.06 | 4.32 | 3.92 | 4.32 | 5.51 |
| | 5250 ~ 5350 | 4.31 | 4.37 | 4.46 | 4.07 | 4.46 | 5.43 |
| | 5470 ~ 5725 | 4.40 | 4.27 | 4.23 | 4.35 | 4.40 | 6.25 |
| | 5725 ~ 5850 | 4.40 | 4.27 | 4.23 | 4.35 | 4.40 | 6.28 |

Note 1: The antenna gain and directional gain refer to manufacturer's antenna specification.

Note 2: The EUT supports Cyclic Delay Diversity (CDD) mode for 802.11a/b/g/n/ac/ax and Beamforming mode for 802.11n/ac/ax.

2. Test Configuration

2.1. Test Mode

| |
|---|
| Mode 1: Transmit by 802.11b (1Mbps) |
| Mode 2: Transmit by 802.11g (6Mbps) |
| Mode 3: Transmit by 802.11n-HT20 (MCS0) |
| Mode 4: Transmit by 802.11n-HT40 (MCS0) |
| Mode 5: Transmit by 802.11ax-HE20 (MCS0) |
| Mode 6: Transmit by 802.11ax-HE40 (MCS0) |
| Note: <ol style="list-style-type: none">1. All the tests were done with worst case modulation, and the worst data rate and traffic stream were designated by manufacturer.2. After preliminary scan designated by the manufacturer, CDD mode is determined to be the worst case compared to Beamforming mode, hence, all the radiated test is performed in CDD mode.3. For beamforming operation, manufacturer automatically backs power down based on CDD power. Therefore, only the CDD mode was evaluated in this report. |

2.2. Test System Connection Diagram

The device was tested per the guidance ANSI C63.10: 2013 was used to reference the appropriate EUT setup for radiated emissions testing and AC line conducted testing.

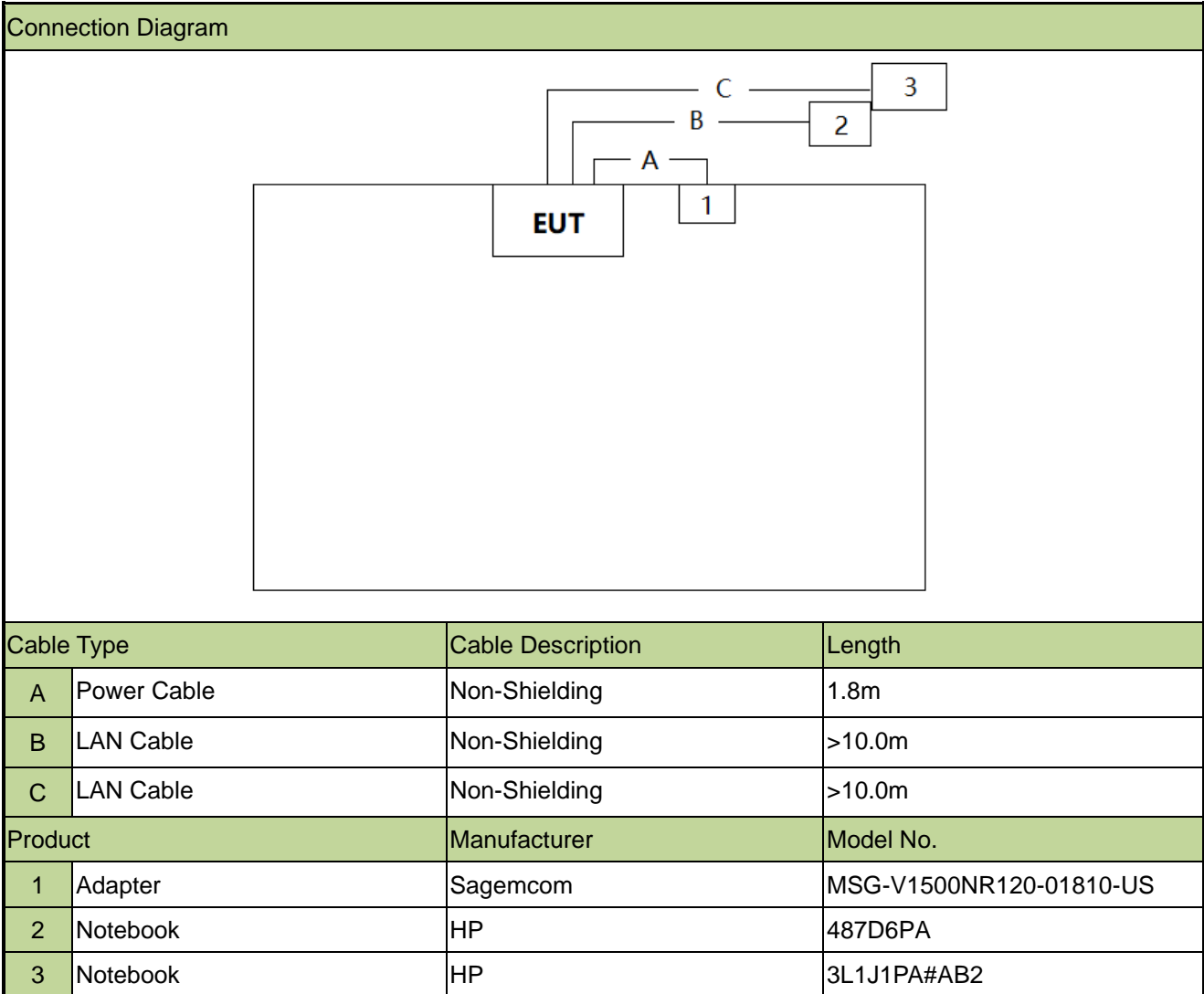

2.3. Test Software

The test utility software used during testing was "accessMTTool", and the version was 3.2.1.2. Final power setting please refer to operational description.

2.4. Applied Standards

According to the specifications of the manufacturer, the EUT must comply with the requirements of the following standards:

- FCC Part 15.247
- KDB 558074 D01v05r02
- KDB 662911 D01v02r01
- ANSI C63.10-2013

2.5. Test Environment Condition

| | |
|---------------------|------------|
| Ambient Temperature | 15 ~ 35°C |
| Relative Humidity | 20 ~ 75%RH |

3. Antenna Requirements

Excerpt from §15.203 of the FCC Rules/Regulations:

“An intentional radiator antenna shall be designed to ensure that no antenna other than that furnished by the responsible party can be used with the device. The use of a permanently attached antenna or of an antenna that uses a unique coupling to the intentional radiator shall be considered sufficient to comply with the provisions of this section.”

- The antenna of the device is **permanently attached**.
- There are no provisions for connection to an external antenna.

Conclusion:

The unit complies with the requirement of §15.203.

4. Measuring Instrument

| Instrument | Manufacturer | Model No. | Asset No. | Cali. Interval | Cali. Due Date | Test Site |
|------------------------|--------------|----------------|-------------|----------------|----------------|---------------|
| Anechoic Chamber | TDK | WZ-AC1 | MRTSUE06212 | 1 year | 2024-04-20 | WZ-AC1 |
| EMI Test Receiver | R&S | ESR7 | MRTSUE06001 | 1 year | 2024-12-17 | WZ-AC1 |
| Horn Antenna | Schwarzbeck | BBHA 9120D | MRTSUE06023 | 1 year | 2024-08-09 | WZ-AC1 |
| Preamplifier | Agilent | 83017A | MRTSUE06076 | 1 year | 2024-05-07 | WZ-AC1 |
| Signal Analyzer | Keysight | N9010B | MRTSUE06607 | 1 year | 2024-10-23 | WZ-AC1 |
| Thermohygrometer | testo | 608-H1 | MRTSUE11039 | 1 year | 2024-10-25 | WZ-AC1 |
| TRILOG Antenna | Schwarzbeck | VULB 9168 | MRTSUE06172 | 1 year | 2024-06-09 | WZ-AC1 |
| Active Loop Antenna | Schwarzbeck | FMZB 1519-60 D | MRTSUE07076 | 1 year | 2024-12-04 | WZ-AC1 |
| TRILOG Antenna | Schwarzbeck | VULB 9162 | MRTSUE06022 | 1 year | 2024-05-15 | WZ-AC2 |
| EMI Test Receiver | Agilent | N9038A | MRTSUE06125 | 1 year | 2024-05-23 | WZ-AC2 |
| Horn Antenna | Schwarzbeck | BBHA 9120D | MRTSUE06171 | 1 year | 2024-10-11 | WZ-AC2 |
| Preamplifier | Schwarzbeck | BBV 9718 | MRTSUE06176 | 1 year | 2024-05-07 | WZ-AC2 |
| Anechoic Chamber | RIKEN | WZ-AC2 | MRTSUE06213 | 1 year | 2024-04-20 | WZ-AC2 |
| Thermohygrometer | testo | 608-H1 | MRTSUE11263 | 1 year | 2024-11-07 | WZ-AC2 |
| Horn Antenna | Schwarzbeck | BBHA 9170 | MRTSUE06597 | 1 year | 2024-11-04 | WZ-AC1/WZ-AC2 |
| Preamplifier | EMCI | EMC184045SE | MRTSUE06640 | 1 year | 2025-01-11 | WZ-AC1/WZ-AC2 |
| EMI Test Receiver | R&S | ESR3 | MRTSUE06909 | 1 year | 2024-09-27 | WZ-SR2 |
| Four-Line V-Network | R&S | ENV432 | MRTSUE06615 | 1 year | 2024-09-27 | WZ-SR2 |
| Shielding Room | MIX-BEP | WZ-SR2 | MRTSUE06215 | 5 years | 2026-12-20 | WZ-SR2 |
| Symmetrical Attenuator | Schwarzbeck | SYMAT 40 | MRTSUE06117 | 1 year | 2024-04-09 | WZ-SR2 |
| Thermohygrometer | testo | 608-H1 | MRTSUE06404 | 1 year | 2024-05-31 | WZ-SR2 |
| Two-Line V-Network | R&S | ENV216 | MRTSUE06002 | 1 year | 2024-05-23 | WZ-SR2 |
| USB Power Sensor | Keysight | U2021XA | MRTSUE06446 | 1 year | 2024-05-23 | WZ-SR5 |
| Shielding Room | HUAMING | WZ-SR5 | MRTSUE06442 | N/A | N/A | WZ-SR5 |
| Signal Analyzer | Agilent | N9020A | MRTSUE06106 | 1 year | 2025-02-03 | WZ-SR5 |
| Signal Analyzer | Keysight | N9010B | MRTSUE06457 | 1 year | 2024-05-23 | WZ-SR5/WZ-TR3 |
| Thermohygrometer | testo | 608-H1 | MRTSUE06402 | 1 year | 2024-05-31 | WZ-SR5 |
| Attenuator | MVE | MVE2213 | MRTSUE11091 | 1 year | 2024-06-08 | WZ |
| Temperature Chamber | BAOYT | BYH-150CL | MRTSUE06051 | 1 year | 2024-09-27 | WZ-TR3 |
| Thermohygrometer | testo | 608-H1 | MRTSUE11268 | 1 year | 2024-12-14 | WZ-TR3 |

| Software | Version | Function |
|----------------------|---------|------------------------|
| EMI V3 | V 3.0.0 | EMI Test Software |
| Controller_MF 7802 | 2.03C | RE Antenna & Turntable |
| Controller_MF 7802 | 1.02 | RE Antenna & Turntable |
| BenchVue Power Meter | 2018.1 | Power |

5. Decision Rules and Measurement Uncertainty

5.1. Decision Rules

The Decision Rule is based on Simple Acceptance in accordance with ISO Guide 98-4: 2012 Clause 8.2. (Measurement uncertainty is not taken into account when stating conformity with a specified requirement.)

5.2. Measurement Uncertainty

Where relevant, the following test uncertainty levels have been estimated for tests performed on the EUT as specified in CISPR 16-4-2. This uncertainty represents an expanded uncertainty expressed at approximately the 95% confidence level using a coverage factor of $k = 2$.

| |
|---|
| AC Conducted Emission Measurement |
| The maximum measurement uncertainty is evaluated as: 9kHz~150kHz: 3.58dB 150kHz~30MHz: 3.20dB |
| Radiated Emission Measurement |
| The maximum measurement uncertainty is evaluated as: Coaxial: 9kHz~30MHz: 2.61dB Coplanar: 9kHz~30MHz: 2.62dB Horizontal: 30MHz~200MHz: 3.79dB 200MHz~1GHz: 3.91dB 1GHz~40GHz: 4.99dB Vertical: 30MHz~200MHz: 4.06dB 200MHz~1GHz: 5.21dB 1GHz~40GHz: 4.90dB |
| Spurious Emissions, Conducted |
| Measuring Uncertainty for a Level of Confidence of 95% ($U=2Uc(y)$): 2.2dB |
| Output Power |
| Measuring Uncertainty for a Level of Confidence of 95% ($U=2Uc(y)$): 1.4dB |
| Power Spectrum Density |
| Measuring Uncertainty for a Level of Confidence of 95% ($U=2Uc(y)$): 2.2dB |
| Occupied Bandwidth |
| Measuring Uncertainty for a Level of Confidence of 95% ($U=2Uc(y)$): 2.7% |

6. Test Result

6.1. Summary

| FCC Section(s) | Test Description | Test Condition | Verdict |
|------------------|---|----------------|---------|
| 15.247(a)(2) | 6dB Bandwidth | Conducted | Pass |
| 15.247(b)(3) | Output Power | | Pass |
| 15.247(e) | Power Spectral Density | | Pass |
| 15.247(d) | Band Edge / Out-of-Band Emissions | | Pass |
| 15.205 15.209 | General Field Strength (Restricted Bands and Radiated Emission) | Radiated | Pass |
| 15.207 | AC Conducted Emissions 150kHz - 30MHz | Line Conducted | Pass |

Notes:

1. The analyzer plots shown in this section were all taken with a correction table loaded into the analyzer. The correction table was used to account for the losses of the cables and attenuators used as part of the system to connect the EUT to the analyzer at all frequencies of interest.
2. For the radiated restricted bandedge test, only the data of worst-case polarity was shown in this report except the channel of lowest / middle / highest.

6.2. 6dB Bandwidth Measurement

6.2.1. Test Limit

The minimum 6dB bandwidth shall be at least 500 kHz.

6.2.2. Test Procedure

ANSI C63.10 - 2013 - Section 11.8

6.2.3. Test Setting

1. The Spectrum's automatic bandwidth measurement capability was used to perform the 6dB bandwidth measurement. The "X" dB bandwidth parameter was set to $X = 6$. The bandwidth measurement was not influenced by any intermediate power nulls in the fundamental emission.
2. Set RBW = 100 kHz
3. VBW $\geq 3 \times$ RBW
4. Detector = Peak
5. Trace mode = Max hold
6. Sweep = Auto couple
7. Allow the trace to stabilize.

6.2.4. Test Setup

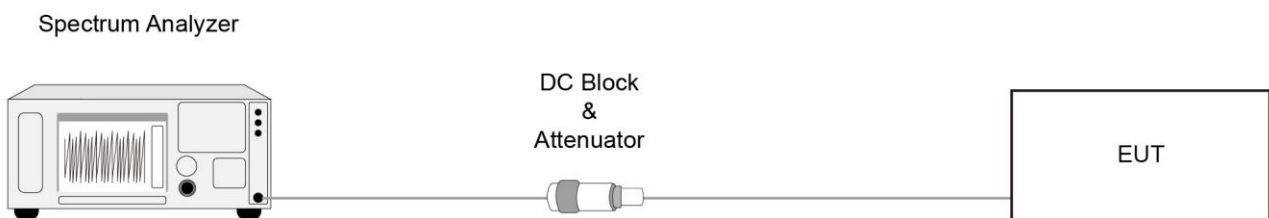

6.2.5. Test Result

Refer to Appendix A.2.

6.3. Output Power Measurement

6.3.1. Test Limit

The maximum output power shall be less 1 Watt (30dBm).

The conducted output power limit specified in paragraph FCC Part 15.247(b) of this section is based on the use of antennas with directional gains that do not exceed 6 dBi. If transmitting antennas of directional gain greater than 6 dBi are used, the conducted output power from the intentional radiator shall be reduced below the stated values in paragraphs FCC Part 15.247(b)(3) of this section, as appropriate, by the amount in dB that the directional gain of the antenna exceeds 6 dBi.

6.3.2. Test Procedure

ANSI C63.10 - 2013 - Section 11.9.2.3.2

6.3.3. Test Setting

Average Power Measurement

Average power measurements were performed only when the EUT was transmitting at its maximum power control level using a broadband power meter with a pulse sensor. The power meter implemented triggering and gating capabilities which were set up such that power measurements were recorded only during the ON time of the transmitter.

6.3.4. Test Setup

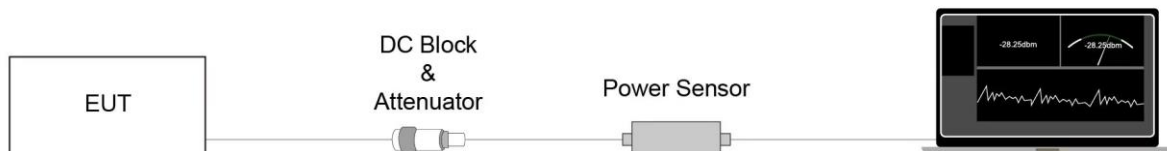

6.3.5. Test Result

Refer to Appendix A.3.

6.4. Power Spectral Density Measurement

6.4.1. Test Limit

The maximum permissible power spectral density is 8dBm in any 3 kHz band.

The same method of determining the conducted output power shall be used to determine the power spectral density.

6.4.2. Test Procedure

ANSI C63.10 - 2013 - Section 11.10.5

6.4.3. Test Setting

1. Measure the duty cycle (x) of the transmitter output signal.
2. Set instrument center frequency to DTS channel center frequency.
3. Set span to at least 1.5 times the OBW.
4. RBW = 10 kHz.
5. VBW = 30 kHz.
6. Detector = RMS.
7. Ensure that the number of measurement points in the sweep $\geq 2 \times \text{span}/\text{RBW}$.
8. Sweep time = auto couple.
9. Don't use sweep triggering. Allow sweep to "free run".
10. Employ trace averaging (RMS) mode over a minimum of 100 traces.
11. Use the peak marker function to determine the maximum amplitude level.
12. Add $10 \log (1/x)$, where x is the duty cycle measured in step (a), to the measured PSD to compute the average PSD during the actual transmission time. If measured value exceeds requirement specified by regulatory agency, then reduce RBW (but no less than 3 kHz) and repeat (note that this may require zooming in on the emission of interest and reducing the span to meet the minimum measurement point requirement as the RBW is reduced).

6.4.4. Test Setup

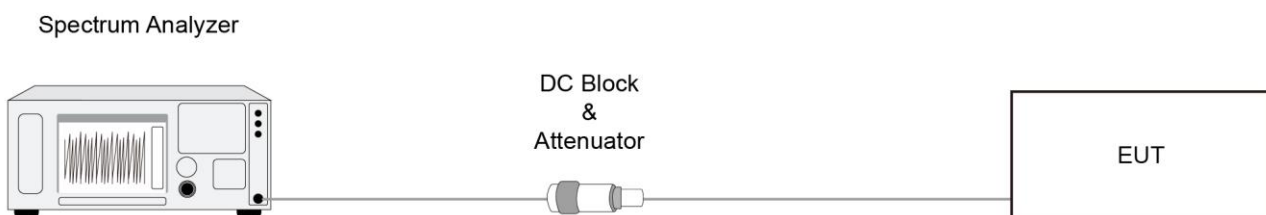

6.4.5. Test Result

Refer to Appendix A.4.

6.5. Conducted Band Edge and Out-of-Band Emissions Measurement

6.5.1. Test Limit

The limit for out-of-band spurious emissions at the band edge is 30dB below the fundamental emission level, as determined from the in-band power measurement of the DTS channel performed in a 100 kHz bandwidth per the PSD procedure.

6.5.2. Test Procedure

ANSI C63.10-2013 - Section 11.11

6.5.3. Test Setting

Reference level measurement

1. Set instrument center frequency to DTS channel center frequency
2. Set the span to ≥ 1.5 times the DTS bandwidth
3. Set the RBW = 100 kHz
4. Set the VBW $\geq 3 \times$ RBW
5. Detector = peak
6. Sweep time = auto couple
7. Trace mode = max hold
8. Allow trace to fully stabilize

Emission level measurement

1. Set the center frequency and span to encompass frequency range to be measured
2. RBW = 100kHz
3. VBW = 300kHz
4. Detector = Peak
5. Trace mode = max hold
6. Sweep time = auto couple
7. The trace was allowed to stabilize

6.5.4. Test Setup

Spectrum Analyzer

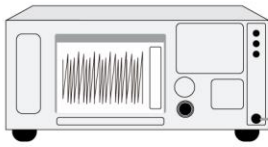

DC Block
&
Attenuator



6.5.5. Test Result

Refer to Appendix A.5.

6.6. Radiated Spurious Emission Measurement

6.6.1. Test Limit

All out of band emissions appearing in a restricted band as specified in Section 15.205 of the Title 47 CFR must not exceed the limits shown in Table per Section 15.209.

| FCC Part 15 Subpart C Paragraph 15.209 | | |
|--|---------------------------------------|-------------------------------|
| Frequency [MHz] | Field Strength [$\mu\text{V/m}$] | Measured Distance [Meters] |
| 0.009 - 0.490 | 2400/F (kHz) | 300 |
| 0.490 - 1.705 | 24000/F (kHz) | 30 |
| 1.705 - 30 | 30 | 30 |
| 30 - 88 | 100 | 3 |
| 88 - 216 | 150 | 3 |
| 216 - 960 | 200 | 3 |
| Above 960 | 500 | 3 |

6.6.2. Test Procedure

ANSI C63.10 - 2013 - Section 11.11 & 11.12

ANSI C63.10 - 2013 - Section 6.3 (General Requirements)

ANSI C63.10 - 2013 - Section 6.4 (Standard test method below 30MHz)

ANSI C63.10 - 2013 - Section 6.5 (Standard test method above 30MHz to 1GHz)

ANSI C63.10 - 2013 - Section 6.6 (Standard test method above 1GHz)

6.6.3. Test Setting

Table 1 - RBW as a function of frequency

| Frequency | RBW |
|---------------|---------------|
| 9 ~ 150 kHz | 200 ~ 300 Hz |
| 0.15 ~ 30 MHz | 9 ~ 10 kHz |
| 30 ~ 1000 MHz | 100 ~ 120 kHz |
| > 1000MHz | 1MHz |

Quasi-Peak Measurements below 1GHz

1. Analyzer center frequency was set to the frequency of the radiated spurious emission of interest
2. Span was set greater than 1MHz
3. RBW = as specified in Table 1
4. Detector = CISPR quasi-peak
5. Sweep time = auto couple
6. Trace was allowed to stabilize

Peak Measurements above 1GHz

1. Analyzer center frequency was set to the frequency of the radiated spurious emission of interest
2. RBW = 1MHz
3. VBW = 3MHz
4. Detector = Peak
5. Sweep time = Auto couple
6. Trace mode = Max hold
7. Trace was allowed to stabilize

Average Measurements above 1GHz (Method VB)

1. Analyzer center frequency was set to the frequency of the radiated spurious emission of interest
2. RBW = 1MHz
3. VBW; if the EUT is configured to transmit with duty cycle $\geq 98\%$, set VBW = 10Hz
If the EUT duty cycle is $< 98\%$, set VBW $\geq 1/T$. T is the minimum transmission duration.
4. As an alternative, the instrument may be set to linear detector mode. Ensure that video filtering is applied in linear voltage domain (rather than in a log or dB domain). Some instruments require linear display mode in order to accomplish this. Others have a setting for Average-VBW Type, which can be set to "Voltage" regardless of the display mode
5. Detector = Peak
6. Sweep time = Auto
7. Trace mode = Max hold
8. Trace was allowed to stabilize

6.6.4. Test Setup

Below 30MHz Test Setup:

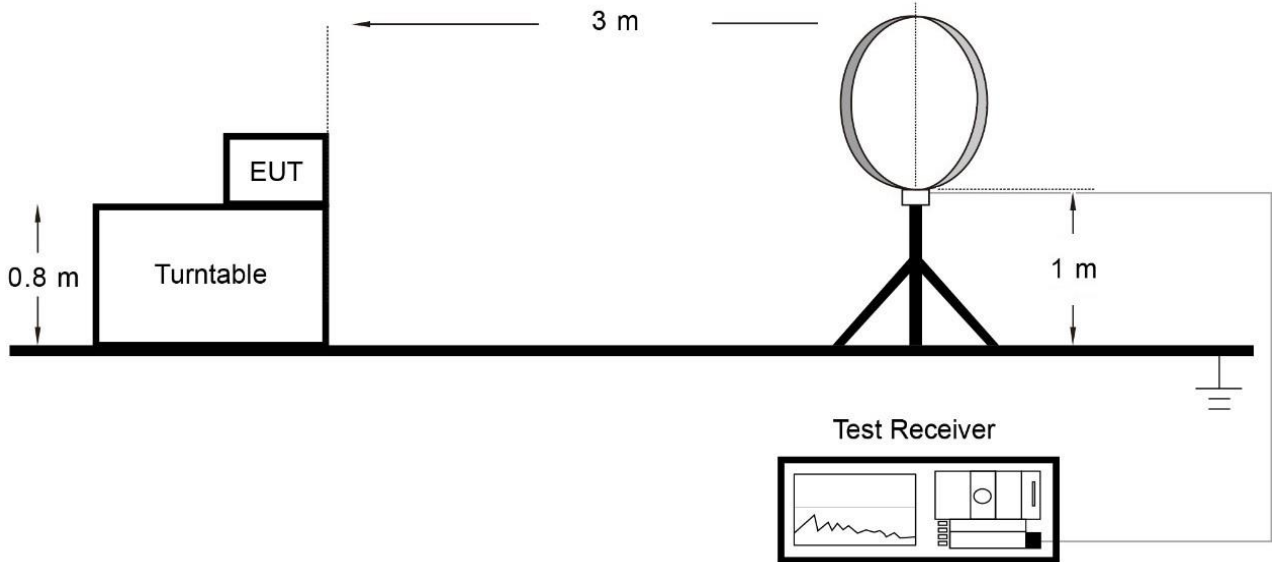

Below 1GHz Test Setup:

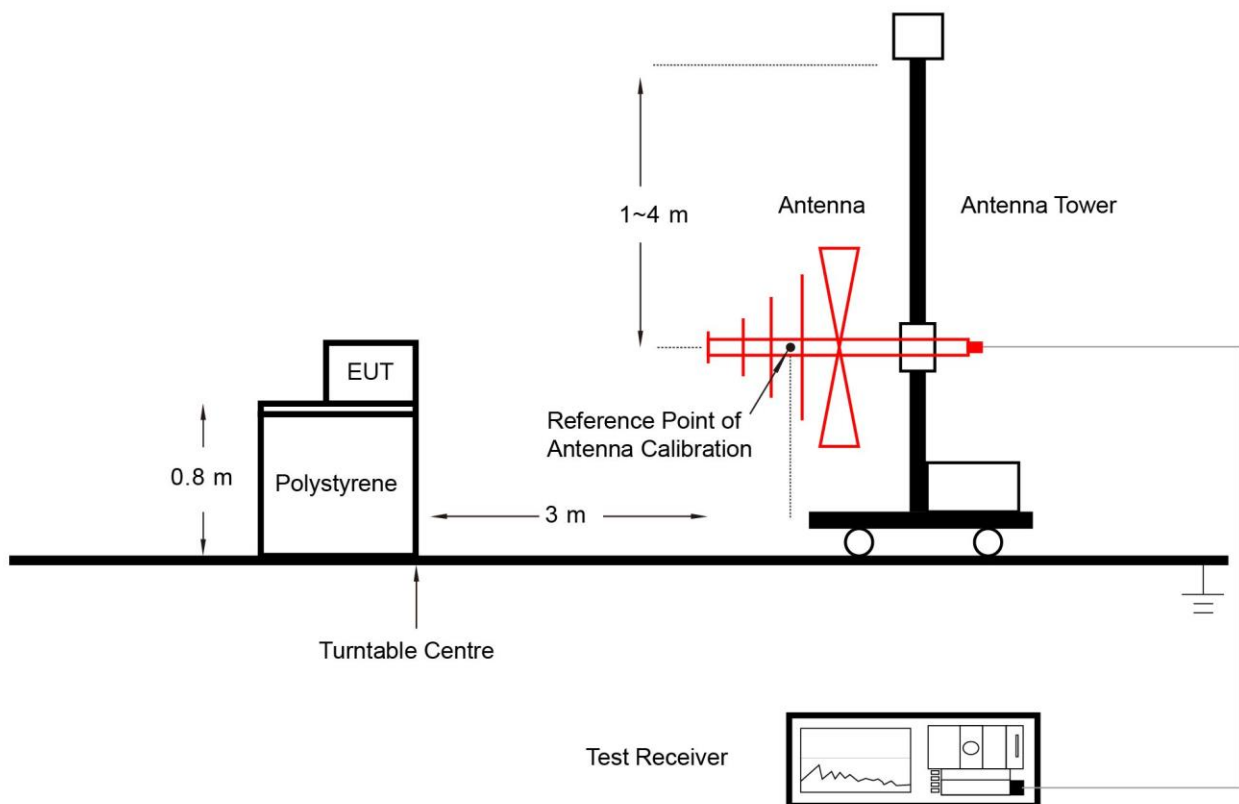

Above 1GHz Test Setup:

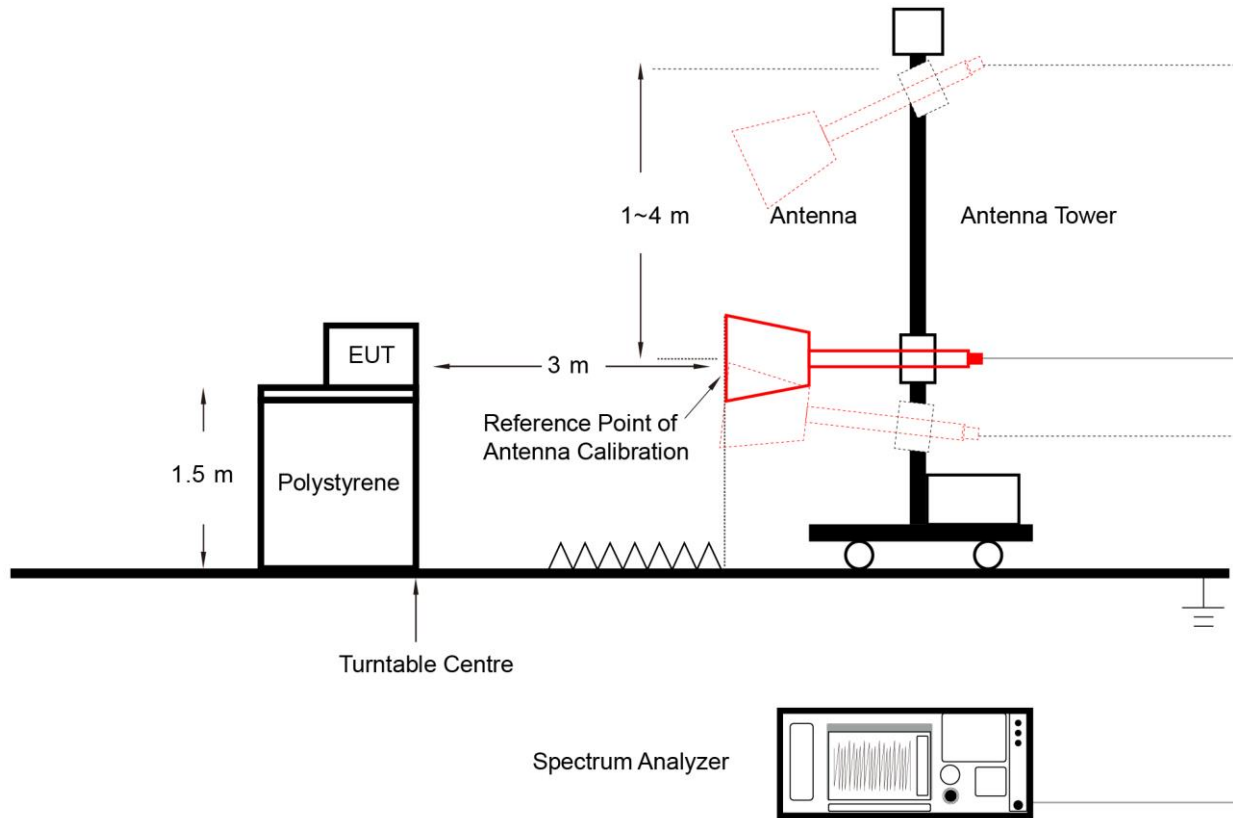

6.6.5. Test Result

Refer to Appendix A.6.

6.7. Radiated Restricted Band Edge Measurement

6.7.1. Test Limit

For 15.205 requirement:

Radiated emissions which fall in the restricted bands, as defined in Section 15.205(a) of FCC part 15, must also comply with the radiated emission limits specified in Section 15.209(a).

| Frequency (MHz) | Frequency (MHz) | Frequency (MHz) | Frequency (GHz) |
|----------------------------|-----------------------|--------------------|--------------------|
| 0.090 - 0.110 | 16.42 - 16.423 | 399.9 - 410 | 4.5 - 5.15 |
| ¹ 0.495 - 0.505 | 16.69475 - 16.69525 | 608 - 614 | 5.35 - 5.46 |
| 2.1735 - 2.1905 | 16.80425 - 16.80475 | 960 - 1240 | 7.25 - 7.75 |
| 4.125 - 4.128 | 25.5 - 25.67 | 1300 - 1427 | 8.025 - 8.5 |
| 4.17725 - 4.17775 | 37.5 - 38.25 | 1435 - 1626.5 | 9.0 - 9.2 |
| 4.20725 - 4.20775 | 73 - 74.6 | 1645.5 - 1646.5 | 9.3 - 9.5 |
| 6.215 - 6.218 | 74.8 - 75.2 | 1660 - 1710 | 10.6 - 12.7 |
| 6.26775 - 6.26825 | 108 - 121.94 | 1718.8 - 1722.2 | 13.25 - 13.4 |
| 6.31175 - 6.31225 | 123 - 138 | 2200 - 2300 | 14.47 - 14.5 |
| 8.291 - 8.294 | 149.9 - 150.05 | 2310 - 2390 | 15.35 - 16.2 |
| 8.362 - 8.366 | 156.52475 - 156.52525 | 2483.5 - 2500 | 17.7 - 21.4 |
| 8.37625 - 8.38675 | 156.7 - 156.9 | 2690 - 2900 | 22.01 - 23.12 |
| 8.41425 - 8.41475 | 162.0125 - 167.17 | 3260 - 3267 | 23.6 - 24.0 |
| 12.29 - 12.293 | 167.72 - 173.2 | 3332 - 3339 | 31.2 - 31.8 |
| 12.51975 - 12.52025 | 240 - 285 | 3345.8 - 3358 | 36.43 - 36.5 |
| 12.57675 - 12.57725 | 322 - 335.4 | 3600 - 4400 | (²) |
| 13.36 - 13.41 | -- | -- | -- |

All out of band emissions appearing in a restricted band as specified in Section 15.205 of the Title 47CFR must not exceed the limits shown in Table per Section 15.209.

| FCC Part 15 Subpart C Paragraph 15.209 | | |
|--|---------------------------------------|-------------------------------|
| Frequency [MHz] | Field Strength [$\mu\text{V/m}$] | Measured Distance [Meters] |
| 0.009 - 0.490 | 2400/F (kHz) | 300 |
| 0.490 - 1.705 | 24000/F (kHz) | 30 |
| 1.705 - 30 | 30 | 30 |
| 30 - 88 | 100 | 3 |
| 88 - 216 | 150 | 3 |
| 216 - 960 | 200 | 3 |
| Above 960 | 500 | 3 |

6.7.2. Test Procedure

ANSI C63.10-2013 Section 6.3 & 6.6 & 11.13

6.7.3. Test Setting

Peak Field Strength Measurements

1. Analyzer center frequency was set to the frequency of the radiated spurious emission of interest
2. RBW = 1MHz
3. VBW = 3MHz
4. Detector = peak
5. Sweep time = auto couple
6. Trace mode = max hold
7. Trace was allowed to stabilize

Average Field Strength Measurements

1. Analyzer center frequency was set to the frequency of the radiated spurious emission of interest
2. RBW = 1MHz
3. VBW; If the EUT is configured to transmit with duty cycle $\geq 98\%$, set VBW = 10 Hz.

If the EUT duty cycle is $< 98\%$, set VBW $\geq 1/T$. T is the minimum transmission duration.

4. As an alternative, the instrument may be set to linear detector mode. Ensure that video filtering is applied in linear voltage domain (rather than in a log or dB domain). Some instruments require linear display mode in order to accomplish this. Others have a setting for Average-VBW Type, which can be set to "Voltage" regardless of the display mode
5. Detector = Peak
6. Sweep time = auto
7. Trace mode = max hold
8. Allow max hold to run for at least 50 times (1/duty cycle) traces

6.7.4. Test Setup

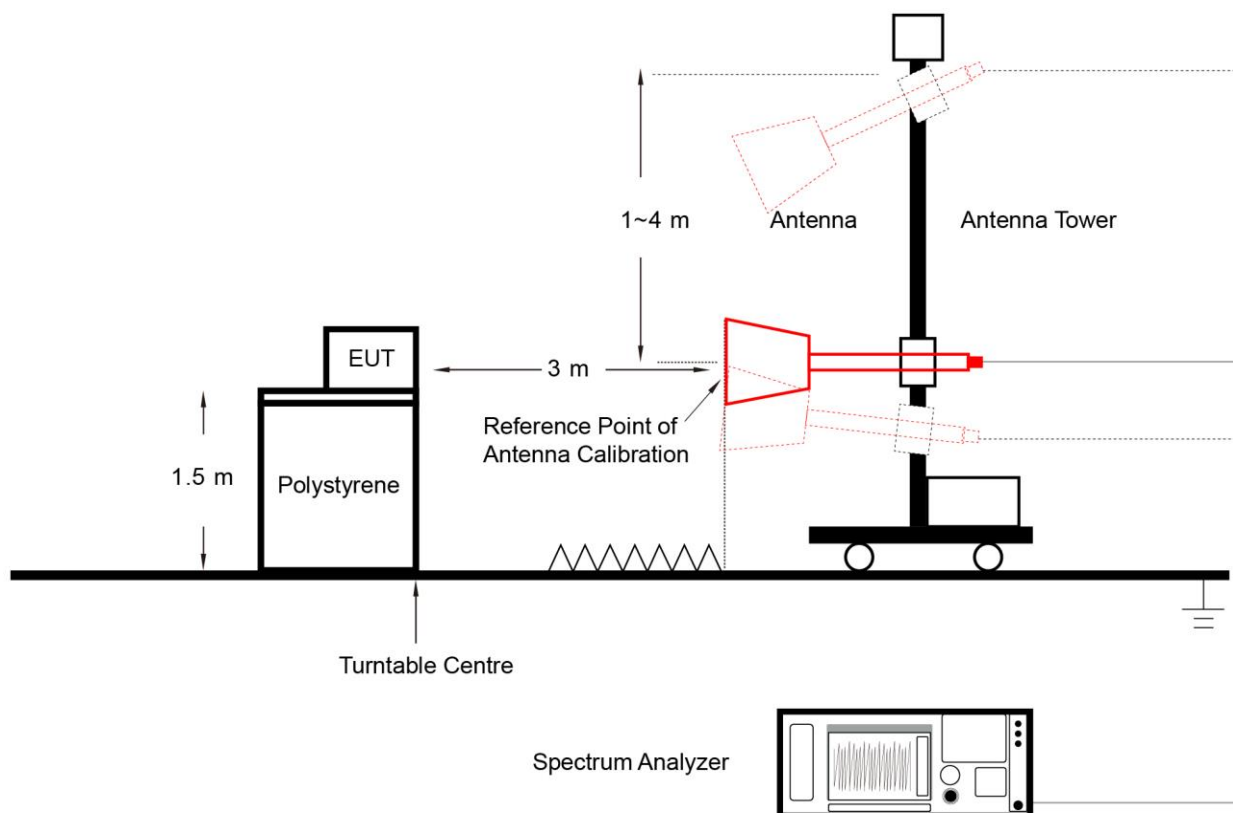

6.7.5. Test Result

Refer to Appendix A.7.

6.8. AC Conducted Emissions Measurement

6.8.1. Test Limit

| FCC Part 15 Subpart C Paragraph 15.207 Limits | | |
|---|-----------------|-----------------|
| Frequency (MHz) | QP (dB μ V) | AV (dB μ V) |
| 0.15 - 0.50 | 66 - 56 | 56 - 46 |
| 0.50 - 5.0 | 56 | 46 |
| 5.0 - 30 | 60 | 50 |

Note 1: The lower limit shall apply at the transition frequencies.

Note 2: The limit decreases linearly with the logarithm of the frequency in the range 0.15MHz to 0.5MHz.

6.8.2. Test Setup

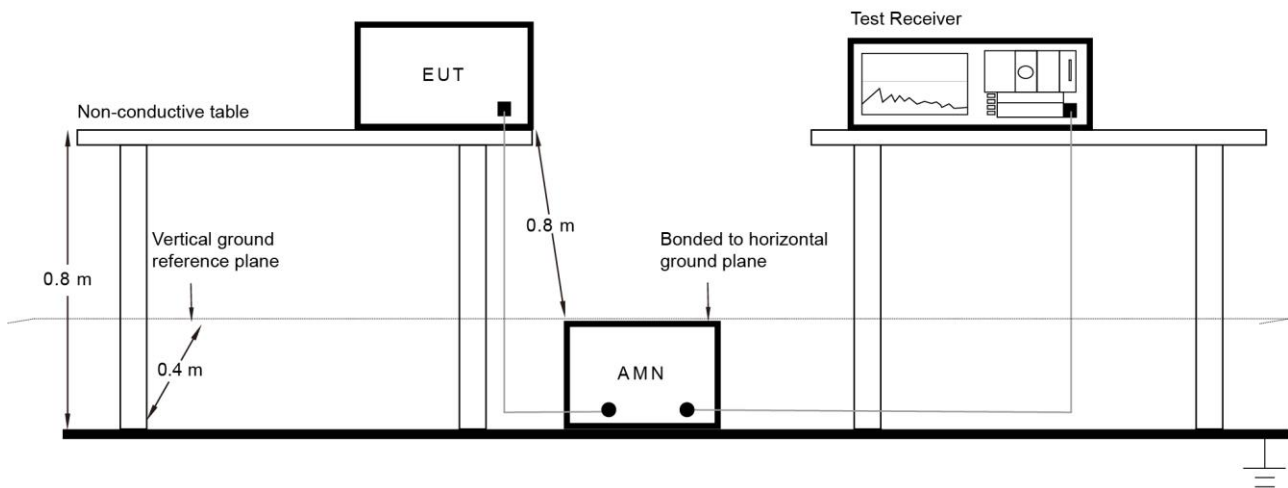

6.8.3. Test Result

Refer to Appendix A.8.

Appendix A – Test Result

A.1 Duty Cycle Test Result

| | | | |
|-----------|------------|---------------|----------|
| Test Site | WZ-SR5 | Test Engineer | Liz Yuan |
| Test Date | 2024-03-19 | | |

| Test Mode | Duty Cycle |
|---------------|------------|
| 802.11b | 95.25% |
| 802.11g | 95.07% |
| 802.11n-HT20 | 95.09% |
| 802.11n-HT40 | 90.32% |
| 802.11ax-HE20 | 97.96% |
| 802.11ax-HE40 | 96.23% |

Duty Cycle (T = Transmission Duration)

802.11b (T = 12.43ms)

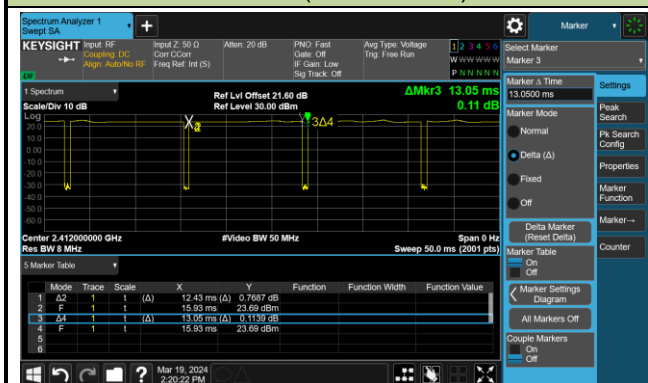

802.11g (T = 2.063ms)

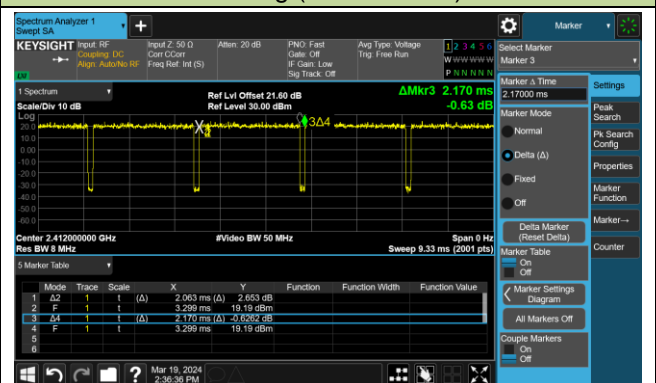

802.11n-HT20 (T = 1.918ms)

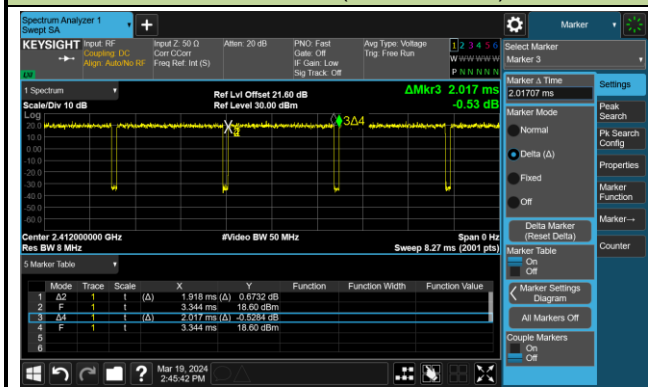

802.11n-HT40 (T = 943.8µs)

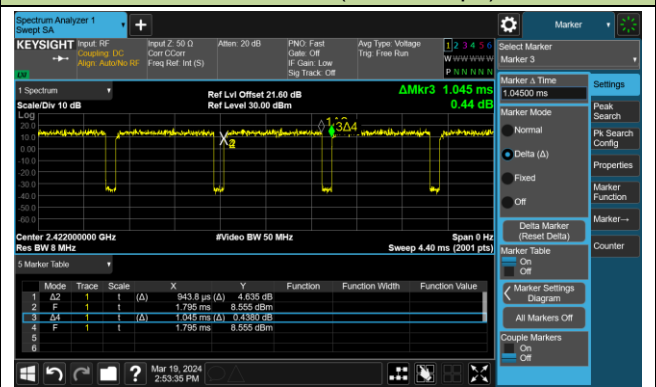

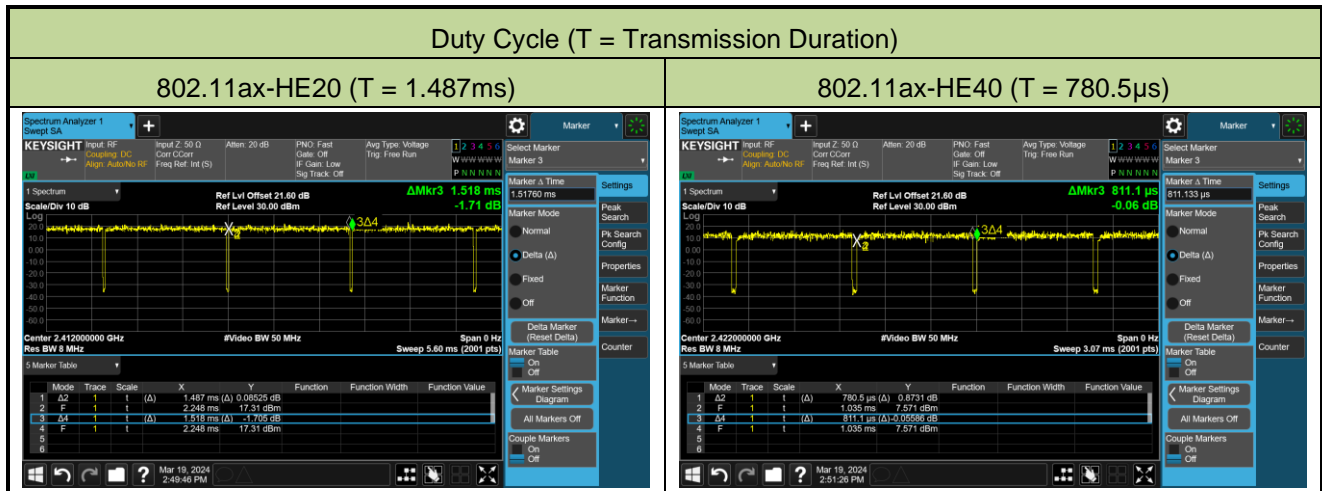

A.2 6dB Bandwidth Test Result

| | | | |
|-----------|------------|---------------|----------|
| Test Site | WZ-SR5 | Test Engineer | Liz Yuan |
| Test Date | 2024-03-19 | | |

| Test Mode | Data Rate / MCS | Channel No. | Frequency (MHz) | 6dB Bandwidth (MHz) | Limit (MHz) |
|-----------|-----------------|-------------|-----------------|---------------------|-------------|
| 11b | 1Mbps | 01 | 2412 | 7.058 | ≥ 0.5 |
| 11b | 1Mbps | 06 | 2437 | 7.066 | ≥ 0.5 |
| 11b | 1Mbps | 11 | 2462 | 7.071 | ≥ 0.5 |
| 11g | 6Mbps | 01 | 2412 | 16.39 | ≥ 0.5 |
| 11g | 6Mbps | 06 | 2437 | 16.37 | ≥ 0.5 |
| 11g | 6Mbps | 11 | 2462 | 16.37 | ≥ 0.5 |
| 11n-HT20 | MCS0 | 01 | 2412 | 17.60 | ≥ 0.5 |
| 11n-HT20 | MCS0 | 06 | 2437 | 17.63 | ≥ 0.5 |
| 11n-HT20 | MCS0 | 11 | 2462 | 17.64 | ≥ 0.5 |
| 11n-HT40 | MCS0 | 03 | 2422 | 36.37 | ≥ 0.5 |
| 11n-HT40 | MCS0 | 06 | 2437 | 36.36 | ≥ 0.5 |
| 11n-HT40 | MCS0 | 09 | 2452 | 36.36 | ≥ 0.5 |
| 11ax-HE20 | MCS0 | 01 | 2412 | 18.99 | ≥ 0.5 |
| 11ax-HE20 | MCS0 | 06 | 2437 | 18.90 | ≥ 0.5 |
| 11ax-HE20 | MCS0 | 11 | 2462 | 18.98 | ≥ 0.5 |
| 11ax-HE40 | MCS0 | 03 | 2422 | 36.37 | ≥ 0.5 |
| 11ax-HE40 | MCS0 | 06 | 2437 | 36.35 | ≥ 0.5 |
| 11ax-HE40 | MCS0 | 09 | 2452 | 37.55 | ≥ 0.5 |

802.11b 6dB Bandwidth

Channel 01 (2412MHz)

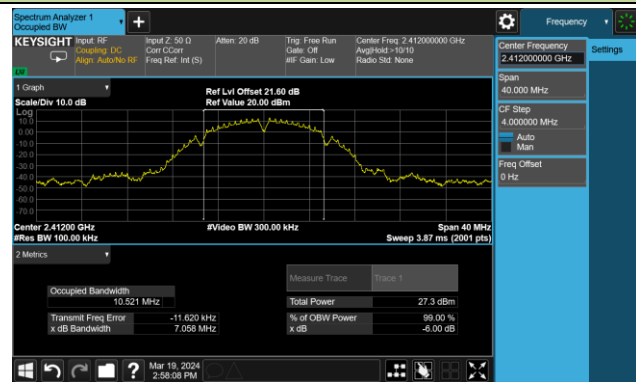

Channel 06 (2437MHz)

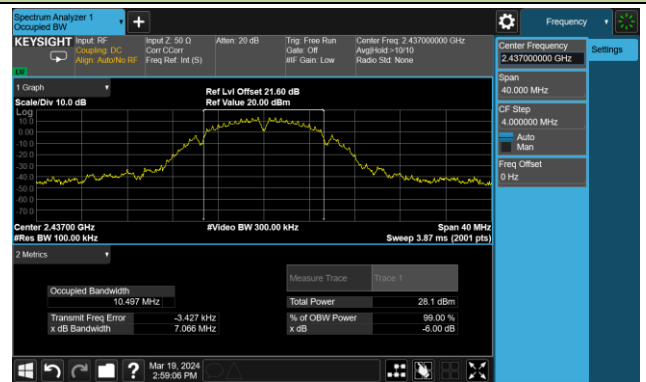

Channel 11 (2462MHz)

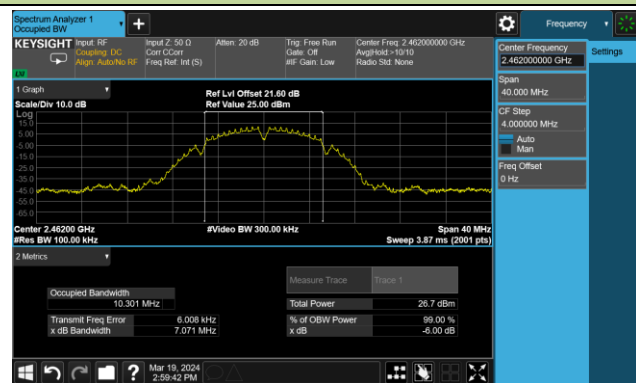

802.11g 6dB Bandwidth

Channel 01 (2412MHz)

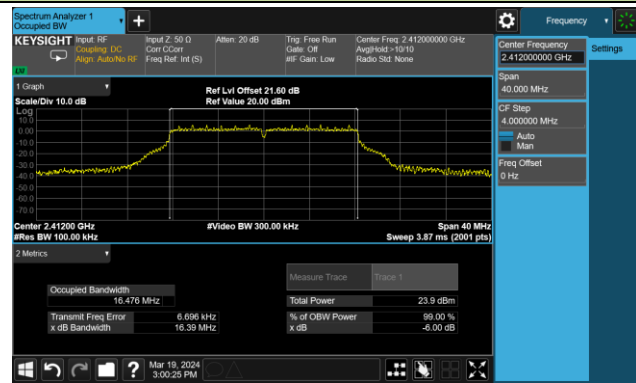

Channel 06 (2437MHz)

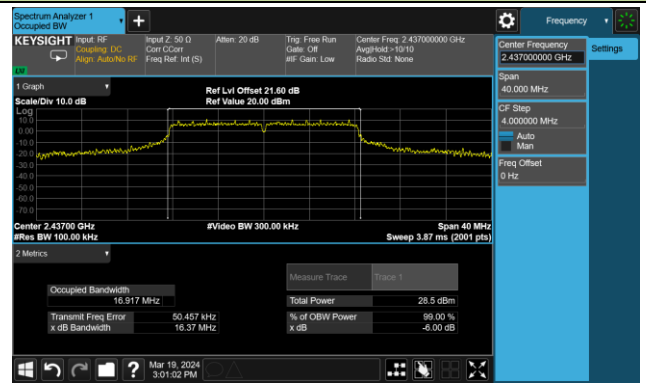

Channel 11 (2462MHz)

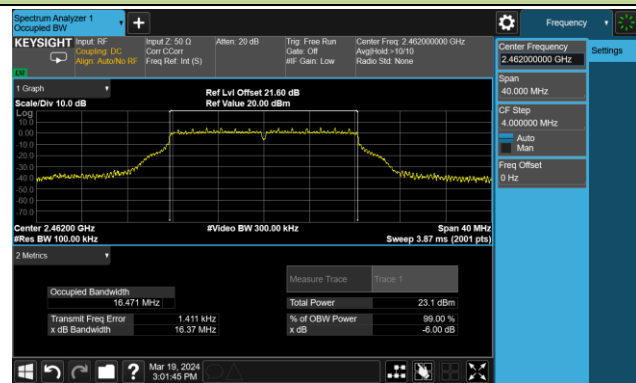

802.11n-HT20 6dB Bandwidth

Channel 01 (2412MHz)

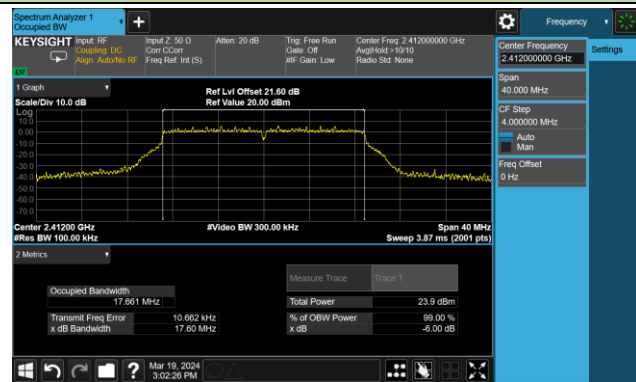

Channel 06 (2437MHz)



Channel 11 (2462MHz)

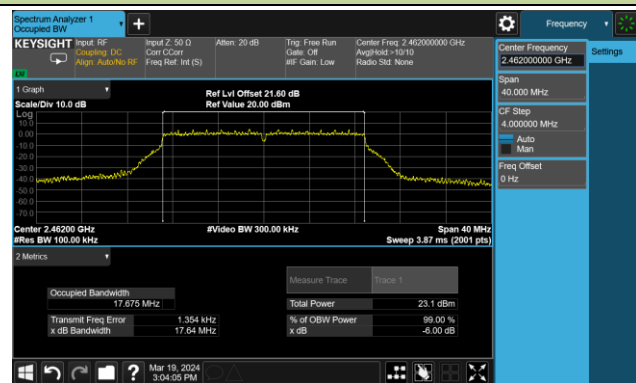

802.11n-HT40 6dB Bandwidth

Channel 03 (2422MHz)

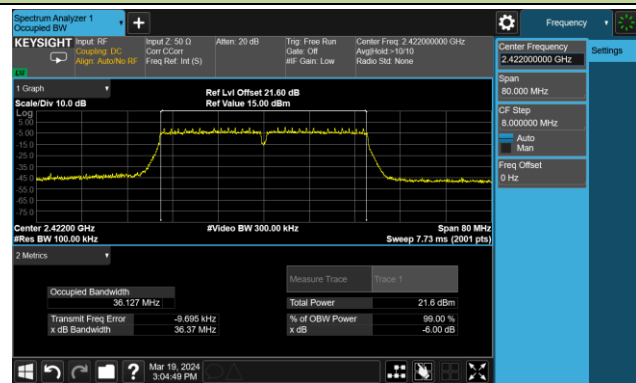

Channel 06 (2437MHz)

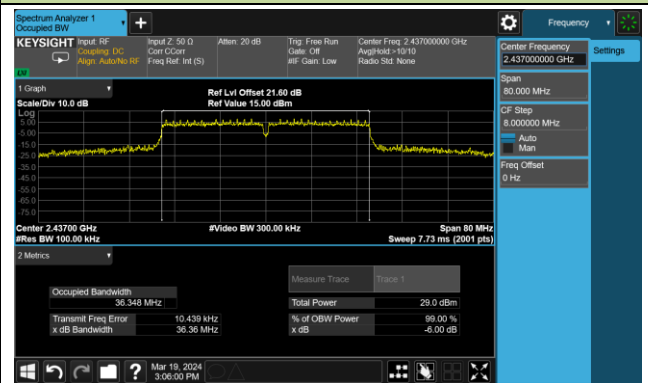

Channel 09 (2452MHz)

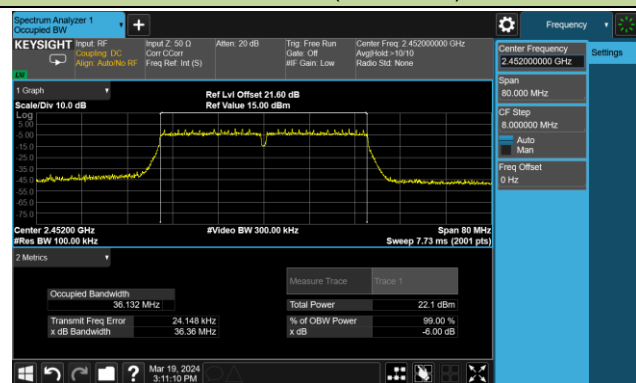

802.11ax-HE20 6dB Bandwidth

Channel 01 (2412MHz)

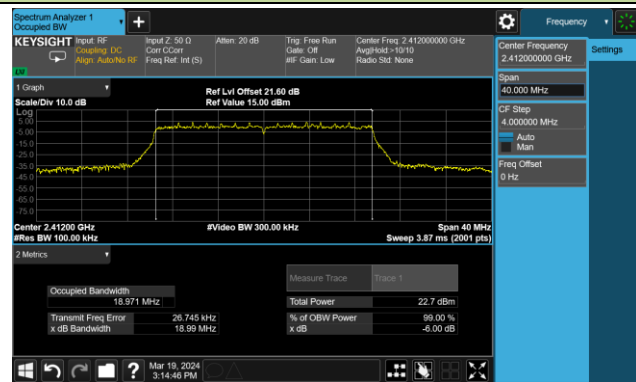

Channel 06 (2437MHz)

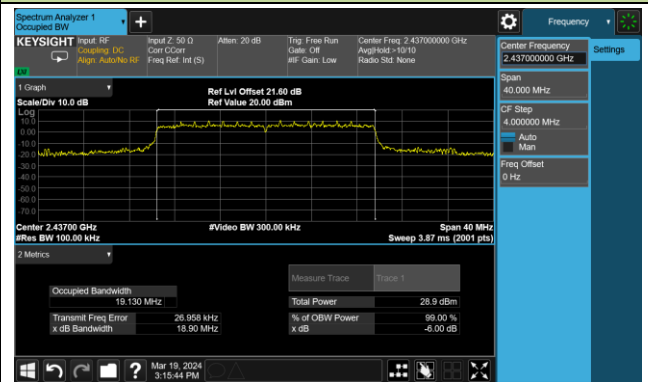

Channel 11 (2462MHz)

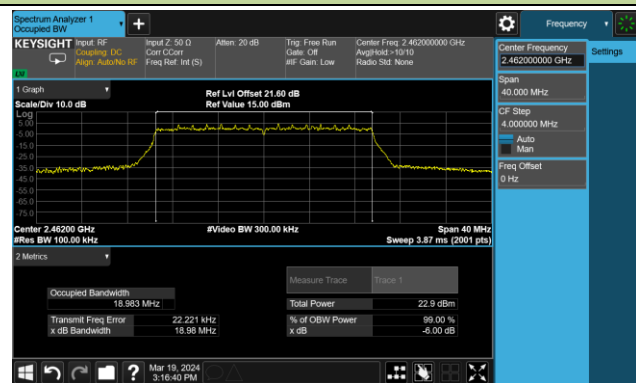

802.11ax-HE40 6dB Bandwidth

Channel 03 (2422MHz)

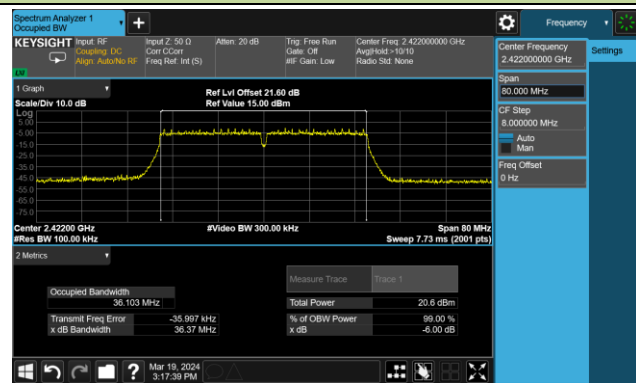

Channel 06 (2437MHz)

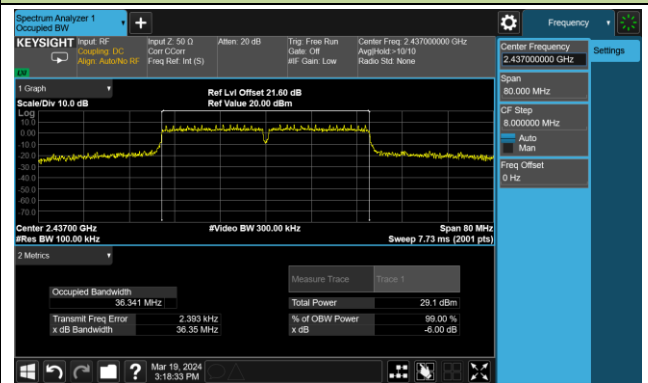

Channel 09 (2452MHz)

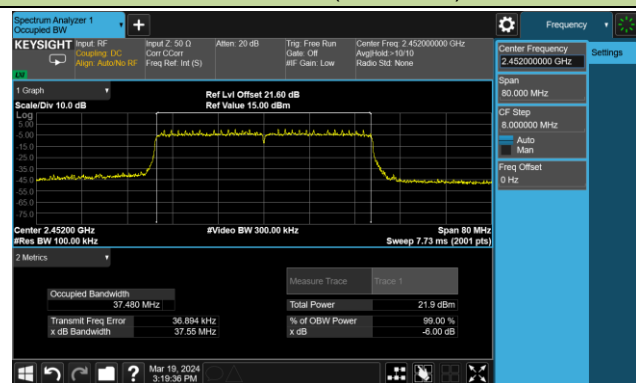

A.3 Output Power Test Result

| | | | |
|-----------|-----------------------|---------------|----------|
| Test Site | WZ-SR5 | Test Engineer | Liz Yuan |
| Test Date | 2024-03-19~2024-03-22 | | |

| Test Mode | Data Rate / MCS | Channel No. | Freq. (MHz) | Average Power (dBm) | | Total Average Power (dBm) | Limit (dBm) |
|-----------|-----------------|-------------|-------------|---------------------|-------|---------------------------|-------------|
| | | | | Ant 0 | Ant 1 | | |
| 11b | 1Mbps | 1 | 2412 | 20.87 | 20.93 | 23.91 | ≤ 30.00 |
| 11b | 1Mbps | 6 | 2437 | 21.93 | 21.38 | 24.67 | ≤ 30.00 |
| 11b | 1Mbps | 11 | 2462 | 20.99 | 19.73 | 23.42 | ≤ 30.00 |
| 11g | 6Mbps | 1 | 2412 | 16.95 | 17.84 | 20.43 | ≤ 30.00 |
| 11g | 6Mbps | 2 | 2417 | 18.56 | 18.82 | 21.70 | ≤ 30.00 |
| 11g | 6Mbps | 6 | 2437 | 21.29 | 21.13 | 24.22 | ≤ 30.00 |
| 11g | 6Mbps | 10 | 2457 | 18.98 | 18.41 | 21.71 | ≤ 30.00 |
| 11g | 6Mbps | 11 | 2462 | 16.41 | 16.51 | 19.47 | ≤ 30.00 |
| 11n-HT20 | MCS0 | 1 | 2412 | 16.54 | 16.75 | 19.66 | ≤ 30.00 |
| 11n-HT20 | MCS0 | 2 | 2417 | 18.23 | 18.15 | 21.20 | ≤ 30.00 |
| 11n-HT20 | MCS0 | 6 | 2437 | 20.72 | 20.50 | 23.62 | ≤ 30.00 |
| 11n-HT20 | MCS0 | 10 | 2457 | 18.96 | 18.53 | 21.76 | ≤ 30.00 |
| 11n-HT20 | MCS0 | 11 | 2462 | 15.93 | 16.12 | 19.04 | ≤ 30.00 |
| 11n-HT40 | MCS0 | 3 | 2422 | 14.51 | 14.50 | 17.52 | ≤ 30.00 |
| 11n-HT40 | MCS0 | 6 | 2437 | 16.79 | 16.75 | 19.78 | ≤ 30.00 |
| 11n-HT40 | MCS0 | 9 | 2452 | 15.06 | 15.10 | 18.09 | ≤ 30.00 |
| 11ax-HE20 | MCS0 | 1 | 2412 | 15.53 | 15.70 | 18.63 | ≤ 30.00 |
| 11ax-HE20 | MCS0 | 2 | 2417 | 17.10 | 17.03 | 20.08 | ≤ 30.00 |
| 11ax-HE20 | MCS0 | 3 | 2422 | 18.42 | 18.98 | 21.72 | ≤ 30.00 |
| 11ax-HE20 | MCS0 | 6 | 2437 | 20.24 | 20.52 | 23.39 | ≤ 30.00 |
| 11ax-HE20 | MCS0 | 10 | 2457 | 18.17 | 17.55 | 20.88 | ≤ 30.00 |
| 11ax-HE20 | MCS0 | 11 | 2462 | 15.62 | 15.75 | 18.70 | ≤ 30.00 |
| 11ax-HE40 | MCS0 | 3 | 2422 | 13.76 | 13.42 | 16.60 | ≤ 30.00 |
| 11ax-HE40 | MCS0 | 6 | 2437 | 16.43 | 16.04 | 19.25 | ≤ 30.00 |
| 11ax-HE40 | MCS0 | 9 | 2452 | 14.81 | 14.92 | 17.88 | ≤ 30.00 |

Note: Total Average Power (dBm) = $10 \cdot \log \{10^{(\text{Ant 0 Average Power} / 10)} + 10^{(\text{Ant 1 Average Power} / 10)}\}$ (dBm).

A.4 Power Spectral Density Test Result

| | | | |
|-----------|-----------------------|---------------|----------|
| Test Site | WZ-SR5 | Test Engineer | Liz Yuan |
| Test Date | 2024-03-19~2024-03-22 | | |

| Test Mode | Data Rate/ MCS | Channel No. | Freq. (MHz) | PSD (dBm/ 10kHz) | | Duty Cycle (%) | 10*log (1/x) | Total PSD (dBm/10kHz) | Limit (dBm/3kHz) |
|-----------|-------------------|----------------|----------------|---------------------|---------|----------------------|-----------------|--------------------------|---------------------|
| | | | | Ant 0 | Ant 1 | | | | |
| 11b | 1Mbps | 01 | 2412 | -5.058 | -5.330 | 95.25 | 0.21 | -1.97 | ≤ 8.00 |
| 11b | 1Mbps | 06 | 2437 | -4.193 | -4.433 | 95.25 | 0.21 | -1.09 | ≤ 8.00 |
| 11b | 1Mbps | 11 | 2462 | -4.584 | -5.819 | 95.25 | 0.21 | -1.94 | ≤ 8.00 |
| 11g | 6Mbps | 01 | 2412 | -11.859 | -10.887 | 95.07 | 0.22 | -8.12 | ≤ 8.00 |
| 11g | 6Mbps | 06 | 2437 | -7.696 | -7.191 | 95.07 | 0.22 | -4.21 | ≤ 8.00 |
| 11g | 6Mbps | 11 | 2462 | -11.363 | -11.340 | 95.07 | 0.22 | -8.12 | ≤ 8.00 |
| 11n-HT20 | MCS0 | 01 | 2412 | -11.986 | -11.551 | 95.09 | 0.22 | -8.53 | ≤ 8.00 |
| 11n-HT20 | MCS0 | 06 | 2437 | -7.985 | -8.382 | 95.09 | 0.22 | -4.95 | ≤ 8.00 |
| 11n-HT20 | MCS0 | 11 | 2462 | -12.856 | -12.724 | 95.09 | 0.22 | -9.56 | ≤ 8.00 |
| 11n-HT40 | MCS0 | 03 | 2422 | -16.129 | -16.078 | 90.32 | 0.44 | -12.65 | ≤ 8.00 |
| 11n-HT40 | MCS0 | 06 | 2437 | -14.024 | -14.062 | 90.32 | 0.44 | -10.59 | ≤ 8.00 |
| 11n-HT40 | MCS0 | 09 | 2452 | -15.317 | -15.746 | 90.32 | 0.44 | -12.07 | ≤ 8.00 |
| 11ax-HE20 | MCS0 | 01 | 2412 | -13.668 | -12.907 | 97.96 | 0.09 | -10.17 | ≤ 8.00 |
| 11ax-HE20 | MCS0 | 06 | 2437 | -8.804 | -8.648 | 97.96 | 0.09 | -5.63 | ≤ 8.00 |
| 11ax-HE20 | MCS0 | 11 | 2462 | -13.797 | -13.565 | 97.96 | 0.09 | -10.58 | ≤ 8.00 |
| 11ax-HE40 | MCS0 | 03 | 2422 | -17.914 | -18.208 | 96.23 | 0.17 | -14.88 | ≤ 8.00 |
| 11ax-HE40 | MCS0 | 06 | 2437 | -16.207 | -16.196 | 96.23 | 0.17 | -13.02 | ≤ 8.00 |
| 11ax-HE40 | MCS0 | 09 | 2452 | -16.746 | -17.141 | 96.23 | 0.17 | -13.76 | ≤ 8.00 |

Note:

 When EUT duty cycle ≥ 98%, Total PSD (dBm / 10kHz) = $10 \cdot \log \{10^{(\text{Ant } 0 \text{ PSD}/10)} + 10^{(\text{Ant } 1 \text{ PSD}/10)}\}$ (dBm / 10kHz).

 When EUT duty cycle < 98%, Total PSD (dBm / 10kHz) = $10 \cdot \log \{10^{(\text{Ant } 0 \text{ PSD}/10)} + 10^{(\text{Ant } 1 \text{ PSD}/10)}\}$ (dBm / 10kHz)
 + $10 \cdot \log (1/\text{Duty Cycle})$.

802.11b - AVGPSD - Ant 0

Channel 01 (2412MHz)



Channel 06 (2437MHz)



Channel 11 (2462MHz)

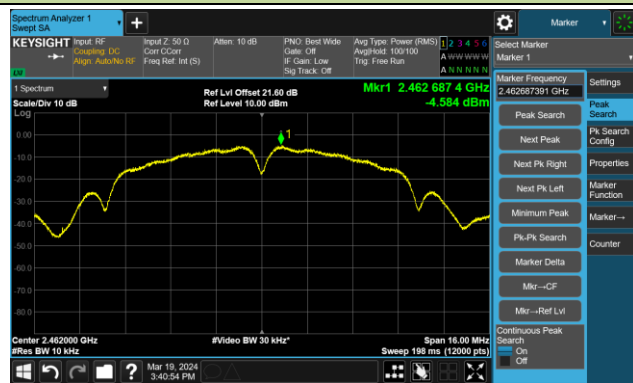

802.11g - AVGPSD - Ant 0

Channel 01 (2412MHz)

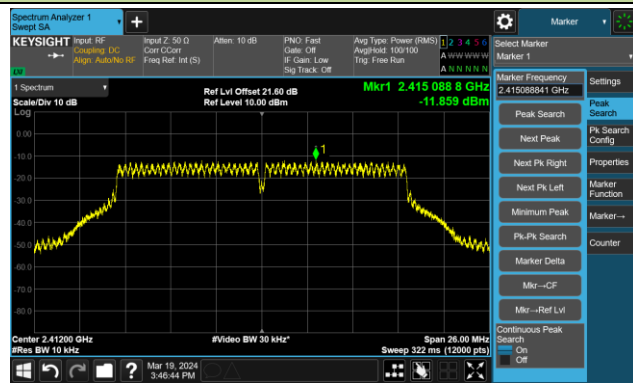

Channel 06 (2437MHz)

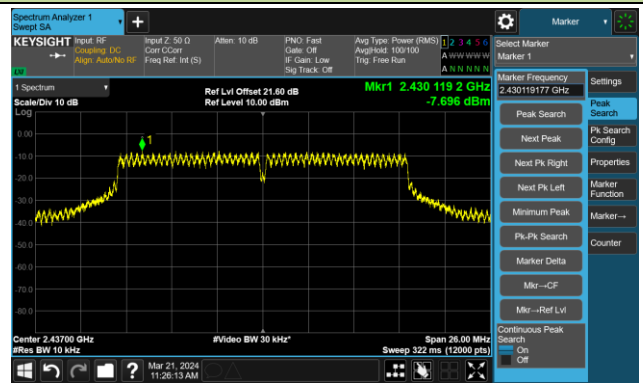

Channel 11 (2462MHz)

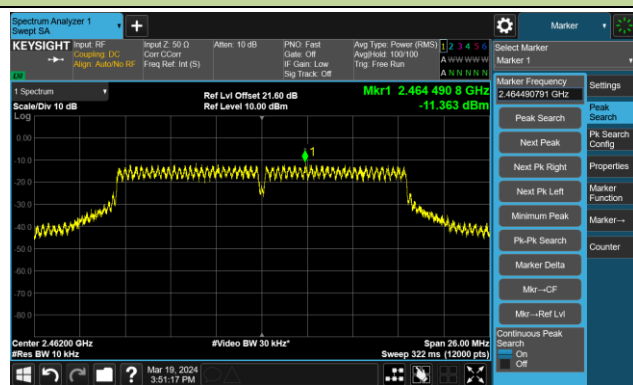

802.11n-HT20 - AVGPSD - Ant 0

Channel 01 (2412MHz)

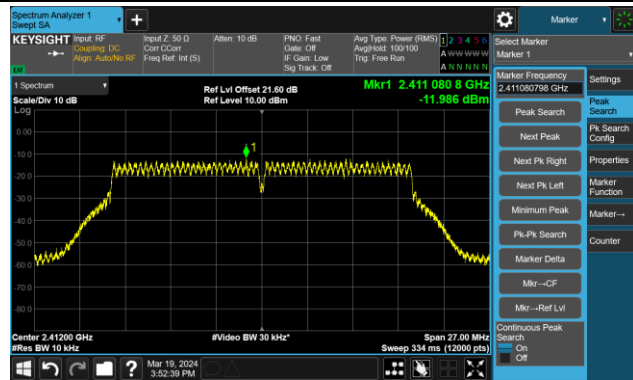

Channel 06 (2437MHz)

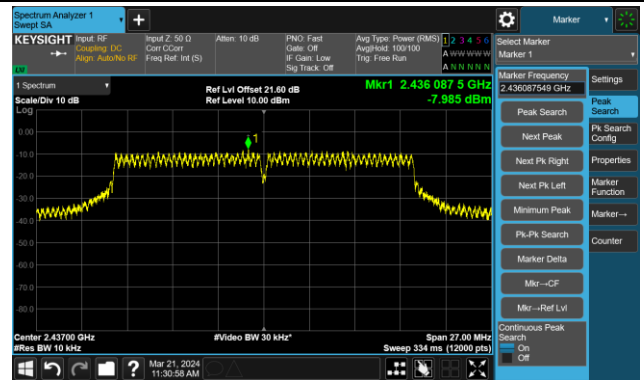

Channel 11 (2462MHz)

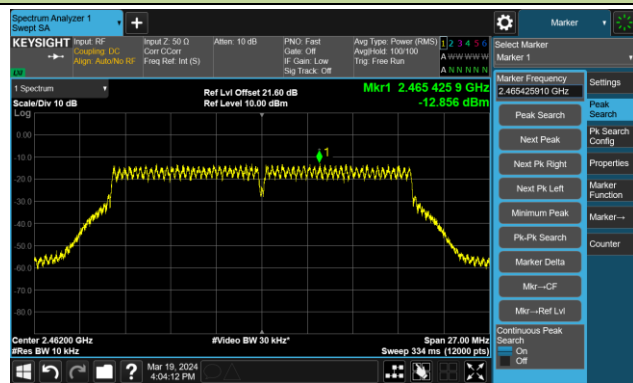

802.11n-HT40 - AVGPSD - Ant 0

Channel 03 (2422MHz)

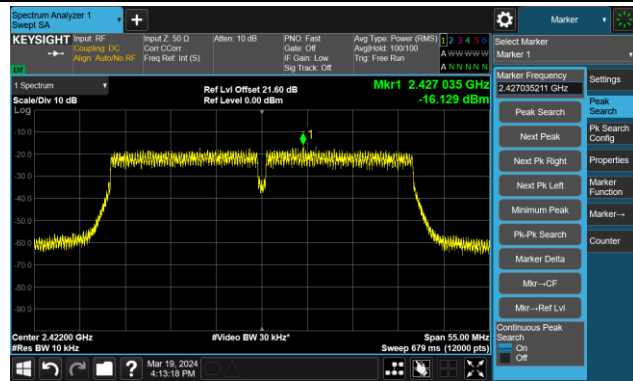

Channel 06 (2437MHz)

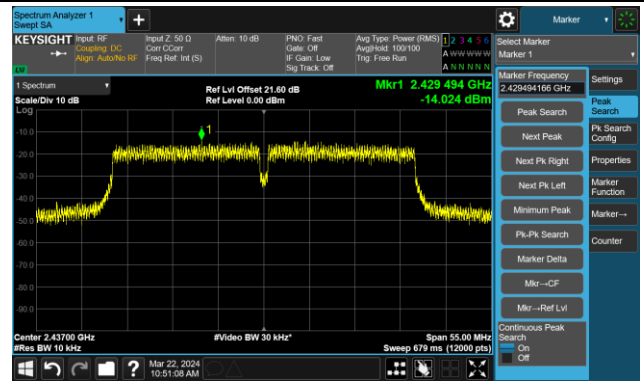

Channel 09 (2452MHz)

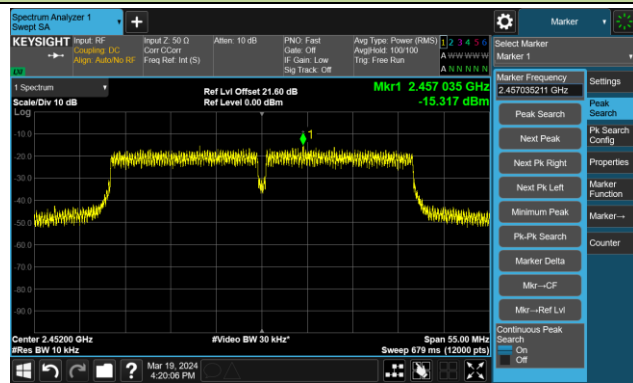

802.11ax-HE20 - AVGPSD - Ant 0

Channel 01 (2412MHz)

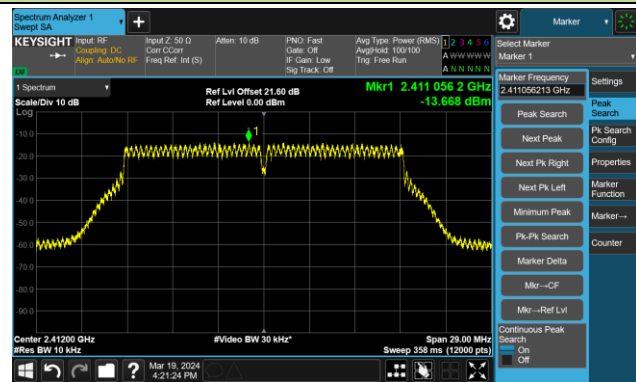

Channel 06 (2437MHz)

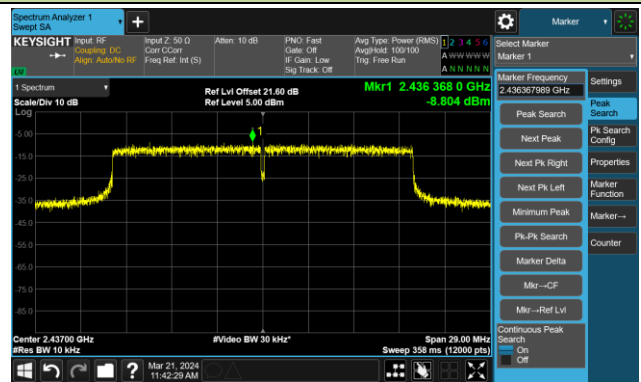

Channel 11 (2462MHz)



802.11ax-HE40 - AVGPSD - Ant 0

Channel 03 (2422MHz)

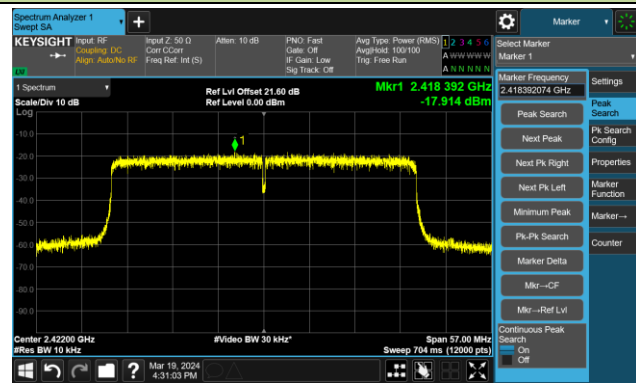

Channel 06 (2437MHz)

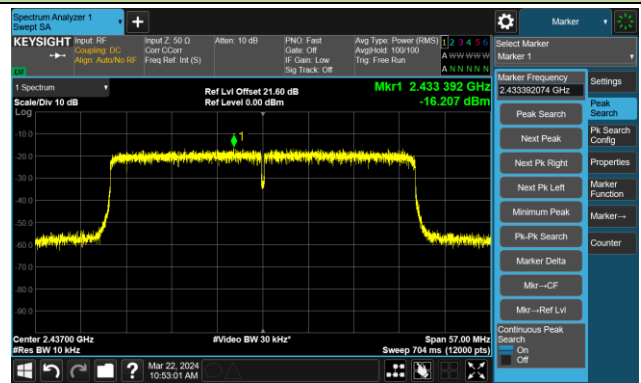

Channel 09 (2452MHz)

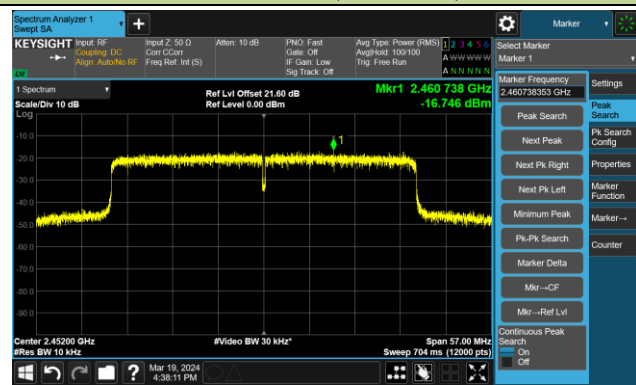

802.11b - AVGPSD - Ant 1

Channel 01 (2412MHz)



Channel 06 (2437MHz)



Channel 11 (2462MHz)

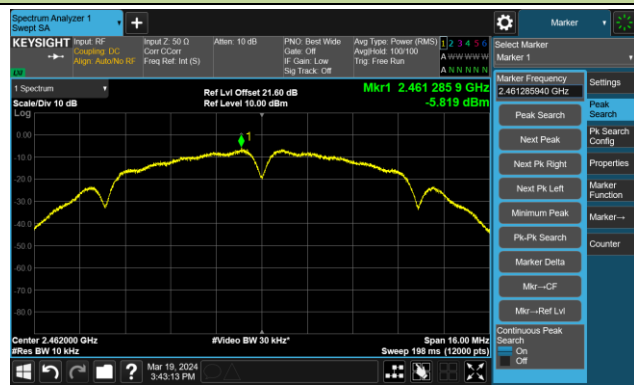

802.11g - AVGPSD - Ant 1

Channel 01 (2412MHz)

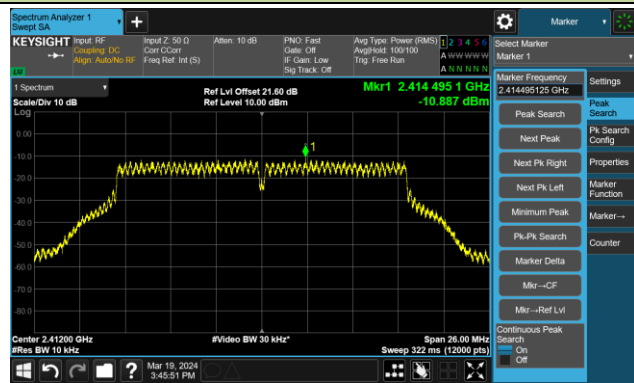

Channel 06 (2437MHz)

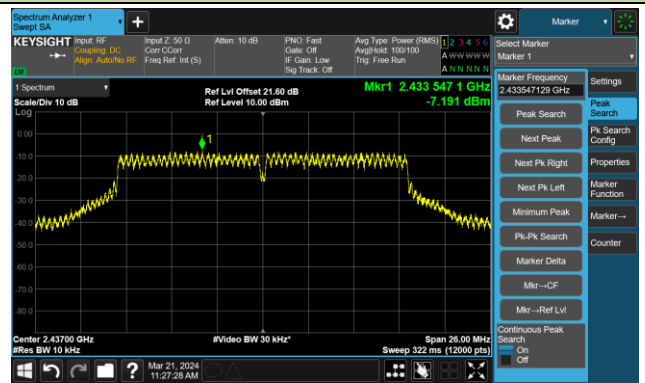

Channel 11 (2462MHz)

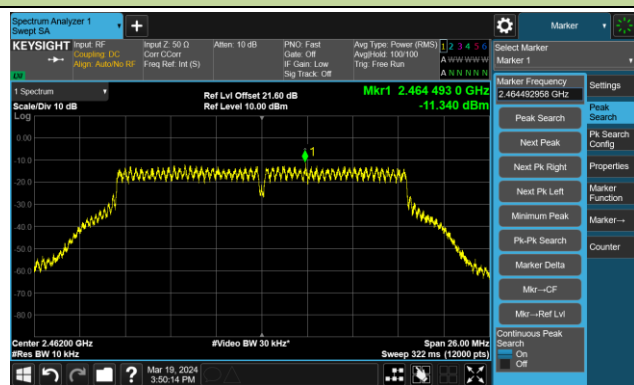

802.11n-HT20 - AVGPSD - Ant 1

Channel 01 (2412MHz)

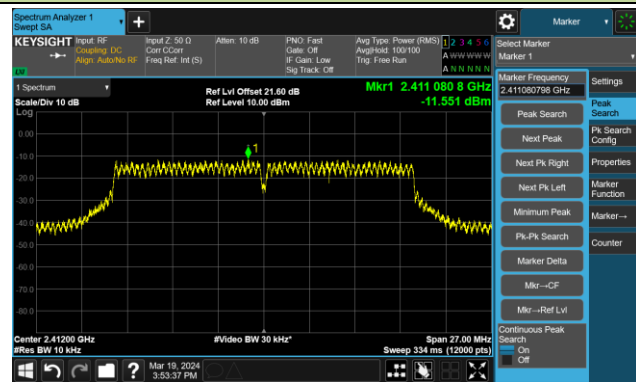

Channel 06 (2437MHz)

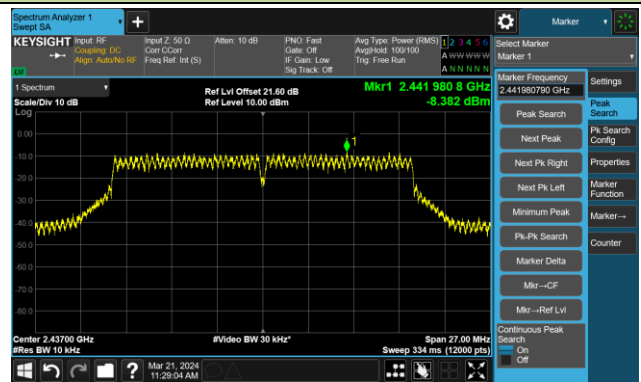

Channel 11 (2462MHz)

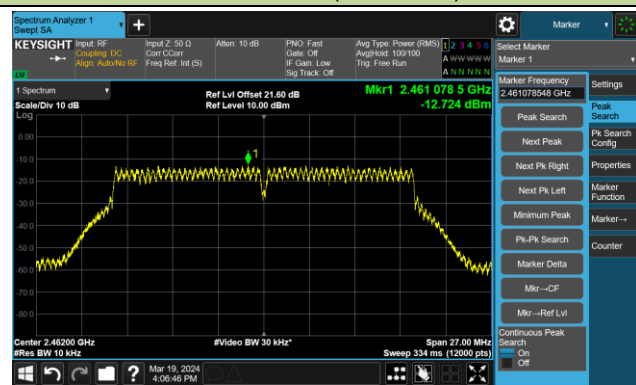

802.11n-HT40 - AVGPSD - Ant 1

Channel 03 (2422MHz)

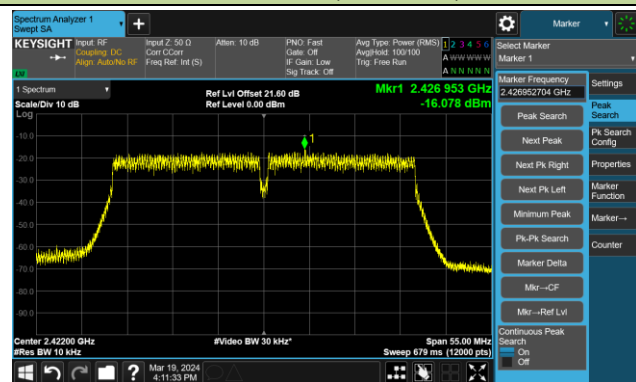

Channel 06 (2437MHz)

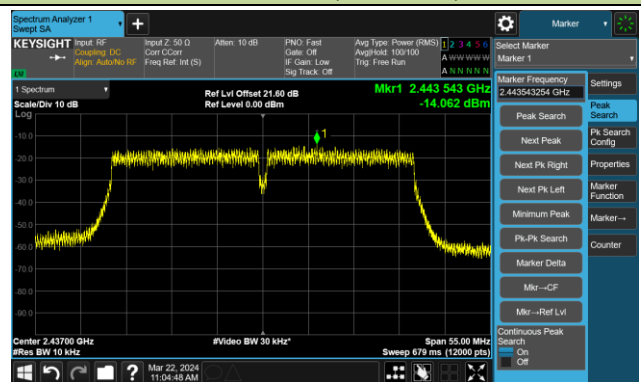

Channel 09 (2452MHz)

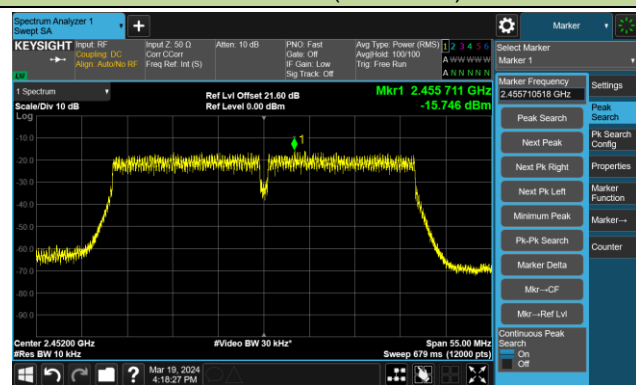

802.11ax-HE20 - AVGPSD - Ant 1

Channel 01 (2412MHz)

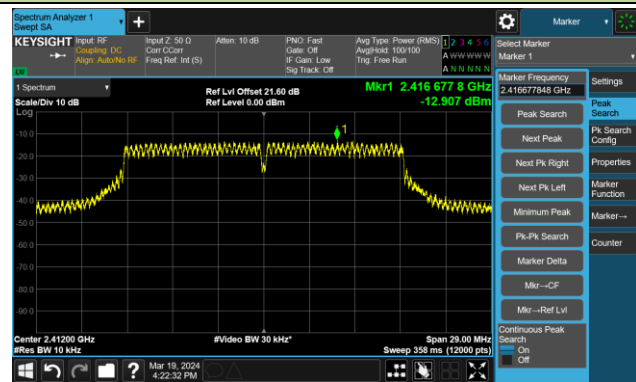

Channel 06 (2437MHz)

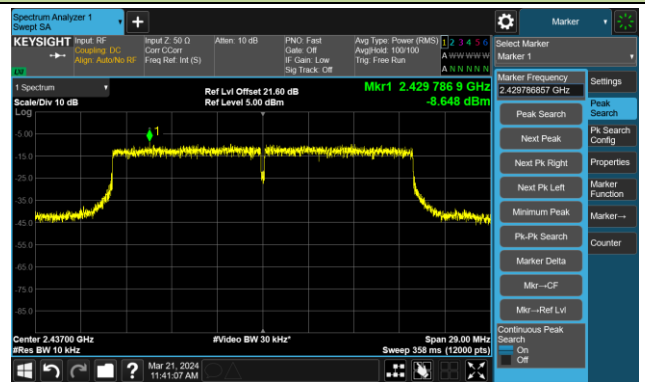

Channel 11 (2462MHz)

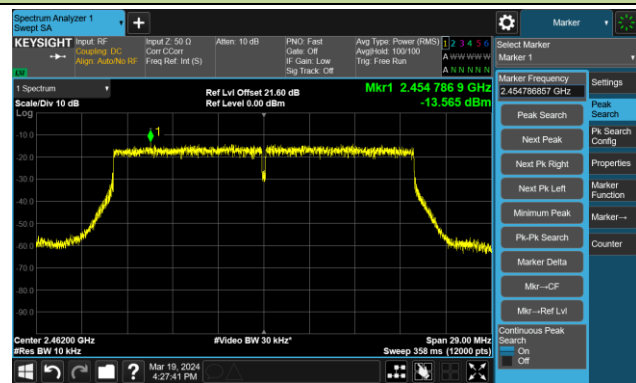

802.11ax-HE40 - AVGPSD - Ant 1

Channel 03 (2422MHz)

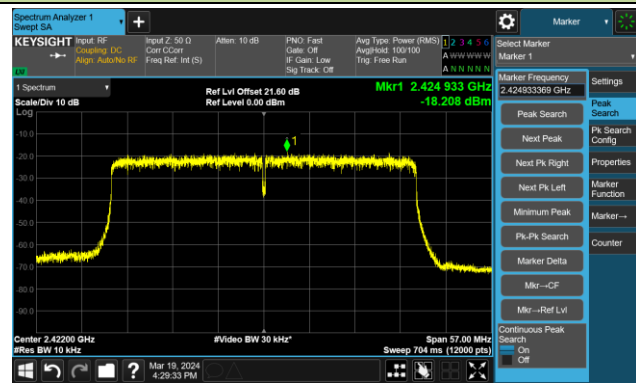

Channel 06 (2437MHz)

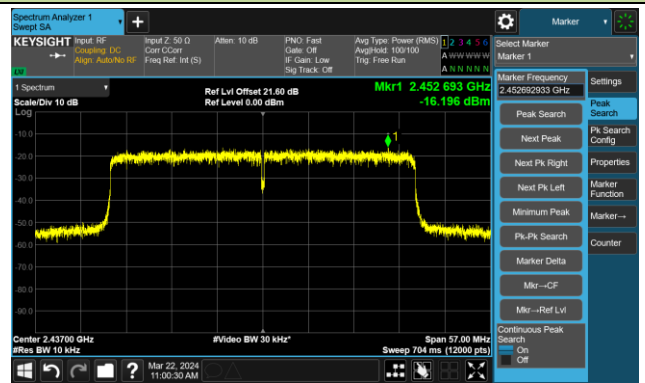

Channel 09 (2452MHz)

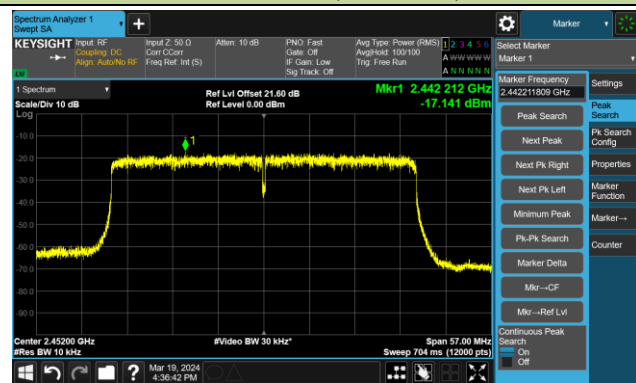

A.5 Conducted Band Edge and Out-of-Band Emissions Test Result

| | | | |
|-----------|-----------------------|---------------|----------|
| Test Site | WZ-SR5 | Test Engineer | Liz Yuan |
| Test Date | 2024-03-19~2024-03-25 | | |

| Test Mode | Data Rate / MCS | Channel No. | Frequency (MHz) | Limit |
|-----------|-----------------|-------------|-----------------|-------|
| 11b | 1Mbps | 01 | 2412 | 30dBc |
| 11b | 1Mbps | 06 | 2437 | 30dBc |
| 11b | 1Mbps | 11 | 2462 | 30dBc |
| 11g | 6Mbps | 01 | 2412 | 30dBc |
| 11g | 6Mbps | 06 | 2437 | 30dBc |
| 11g | 6Mbps | 11 | 2462 | 30dBc |
| 11n-HT20 | MCS0 | 01 | 2412 | 30dBc |
| 11n-HT20 | MCS0 | 06 | 2437 | 30dBc |
| 11n-HT20 | MCS0 | 11 | 2462 | 30dBc |
| 11n-HT40 | MCS0 | 03 | 2422 | 30dBc |
| 11n-HT40 | MCS0 | 06 | 2437 | 30dBc |
| 11n-HT40 | MCS0 | 09 | 2452 | 30dBc |
| 11ax-HE20 | MCS0 | 01 | 2412 | 30dBc |
| 11ax-HE20 | MCS0 | 06 | 2437 | 30dBc |
| 11ax-HE20 | MCS0 | 11 | 2462 | 30dBc |
| 11ax-HE40 | MCS0 | 03 | 2422 | 30dBc |
| 11ax-HE40 | MCS0 | 06 | 2437 | 30dBc |
| 11ax-HE40 | MCS0 | 09 | 2452 | 30dBc |

802.11b Out-of-Band Emissions – Ant 0

Channel 01 (2412MHz)

Reference Level

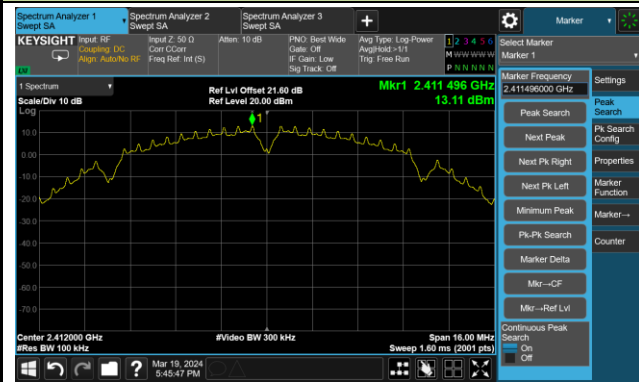

Low Band Edge



Spurious Emission

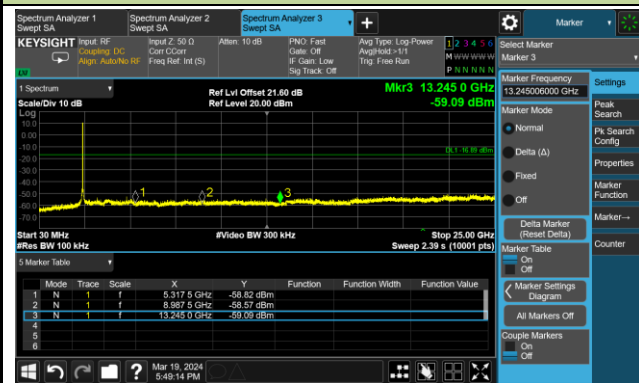

Channel 06 (2437MHz)

Reference Level



Spurious Emission

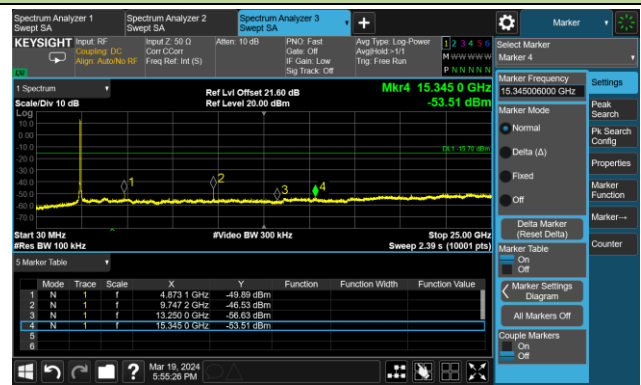

802.11b Out-of-Band Emissions – Ant 0

Channel 11 (2462MHz)

Reference Level

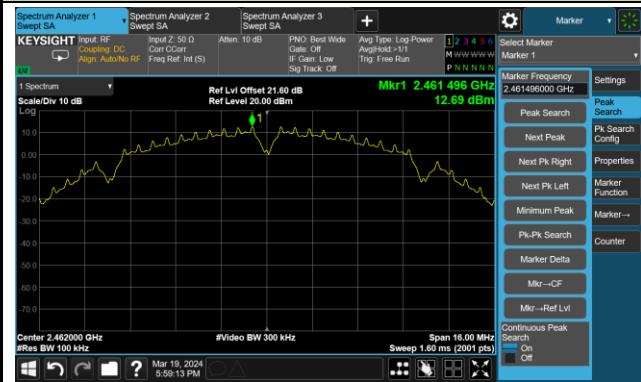

High Band Edge

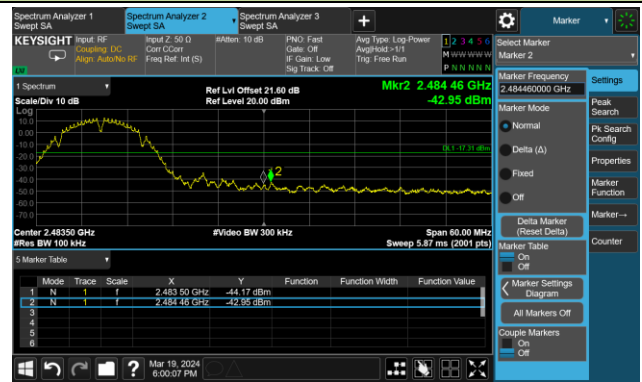

Spurious Emission

