

FCC Radio Test Report

FCC ID: VW3DIW387

This report concerns (check one): Original Grant Class I Change Class II Change

Project No. : 1802C015A
Equipment : Android TV DIW387 UHD
Test Model : DIW387 UHD
Series Model : N/A
P/N : 253775312
S/N : 618220036736
Applicant : SAGEMCOM BROADBAND SAS
Address : 250 Route de l' Empereur - 92848 RUEIL
MALMAISON CEDEX- FRANCE

Date of Receipt : Jul. 10, 2018
Date of Test : Jul. 11, 2018 ~ Jul. 28, 2018
Issued Date : Sep. 14, 2018
Tested by : BTL Inc.

Testing Engineer : Kai Xu
(Kai Xu)

Technical Manager : Shawn Xiao
(Shawn Xiao)

Authorized Signatory : Steven Lu
(Steven Lu)

B T L I N C .

No.3, Jinshagang 1st Road, Shixia, Dalang Town, Dongguan,
Guangdong, China.

TEL: +86-769-8318-3000 FAX: +86-769-8319-6000



Declaration

BTL represents to the client that testing is done in accordance with standard procedures as applicable and that test instruments used has been calibrated with standards traceable to international standard(s) and/or national standard(s).

BTL's reports apply only to the specific samples tested under conditions. It is manufacture's responsibility to ensure that additional production units of this model are manufactured with the identical electrical and mechanical components. **BTL** shall have no liability for any declarations, inferences or generalizations drawn by the client or others from **BTL** issued reports.

The report must not be used by the client to claim product certification, approval, or endorsement by NVLAP, NIST, or any agency of the U.S. Government.

This report is the confidential property of the client. As a mutual protection to the clients, the public and ourselves, the test report shall not be reproduced, except in full, without our written approval.

BTL's laboratory quality assurance procedures are in compliance with the **ISO Guide 17025** requirements, and accredited by the conformity assessment authorities listed in this test report.

BTL is not responsible for the sampling stage, so the results only apply to the sample as received.

The information, data and test plan are provided by manufacturer, so it is manufacturer's responsibility to ensure that the apparatus meets the essential requirements in all the possible configurations as representative of its intended use.

Limitation

For the use of the authority's logo is limited unless the Test Standard(s)/Scope(s)/Item(s) mentioned in this test report is (are) included in the conformity assessment authorities acceptance respective.

Table of Contents	Page
1 . CERTIFICATION	6
2 . SUMMARY OF TEST RESULTS	7
2.1 TEST FACILITY	8
2.2 MEASUREMENT UNCERTAINTY	8
3 . GENERAL INFORMATION	9
3.1 GENERAL DESCRIPTION OF EUT	9
3.2 DESCRIPTION OF TEST MODES	13
3.3 TABLE OF PARAMETERS OF TEST SOFTWARE SETTING	15
3.4 BLOCK DIAGRAM SHOWING THE CONFIGURATION OF SYSTEM TESTED	17
3.5 DESCRIPTION OF SUPPORT UNITS	17
4 . EMC EMISSION TEST	18
4.1 CONDUCTED EMISSION MEASUREMENT	18
4.1.1 POWER LINE CONDUCTED EMISSION	18
4.1.2 TEST PROCEDURE	18
4.1.3 DEVIATION FROM TEST STANDARD	18
4.1.4 TEST SETUP	19
4.1.5 EUT OPERATING CONDITIONS	19
4.1.6 EUT TEST CONDITIONS	19
4.1.7 TEST RESULTS	19
4.2 RADIATED EMISSION MEASUREMENT	20
4.2.1 RADIATED EMISSION LIMITS	20
4.2.2 TEST PROCEDURE	21
4.2.3 DEVIATION FROM TEST STANDARD	21
4.2.4 TEST SETUP	21
4.2.5 EUT OPERATING CONDITIONS	22
4.2.6 EUT TEST CONDITIONS	22
4.2.7 TEST RESULTS (9K TO 30MHz)	23
4.2.8 TEST RESULTS (BETWEEN 30 TO 1000 MHz)	23
4.2.9 TEST RESULTS (ABOVE 1000 MHz)	23
5 . 26dB SPECTRUM BANDWIDTH	24
5.1 APPLIED PROCEDURES / LIMIT	24
5.1.1 TEST PROCEDURE	24
5.1.2 DEVIATION FROM STANDARD	24
5.1.3 TEST SETUP	24
5.1.4 EUT OPERATION CONDITIONS	24
5.1.5 EUT TEST CONDITIONS	25
5.1.6 TEST RESULTS	25
6 . MAXIMUM OUTPUT POWER	26

Table of Contents	Page
6.1 APPLIED PROCEDURES / LIMIT	26
6.1.1 TEST PROCEDURE	26
6.1.2 DEVIATION FROM STANDARD	27
6.1.3 TEST SETUP	27
6.1.4 EUT OPERATION CONDITIONS	27
6.1.5 EUT TEST CONDITIONS	27
6.1.6 TEST RESULTS	27
7 . POWER SPECTRAL DENSITY TEST	28
7.1 APPLIED PROCEDURES / LIMIT	28
8.1.1 TEST PROCEDURE	28
7.1.1 DEVIATION FROM STANDARD	29
7.1.2 TEST SETUP	29
7.1.3 EUT OPERATION CONDITIONS	29
7.1.4 EUT TEST CONDITIONS	29
7.1.5 TEST RESULTS	29
8 . FREQUENCY STABILITY MEASUREMENT	30
8.1 APPLIED PROCEDURES / LIMIT	30
8.1.1 TEST PROCEDURE	30
8.1.2 DEVIATION FROM STANDARD	30
8.1.3 TEST SETUP	31
8.1.4 EUT OPERATION CONDITIONS	31
8.1.5 EUT TEST CONDITIONS	31
8.1.6 TEST RESULTS	31
9 . MEASUREMENT INSTRUMENTS LIST	32
10 . EUT TEST PHOTOS	34
APPENDIX A - CONDUCTED EMISSION	38
APPENDIX B - RADIATED EMISSION (9KHZ TO 30MHZ)	41
APPENDIX C - RADIATED EMISSION (30MHZ TO 1000MHZ)	46
APPENDIX D - RADIATED EMISSION (ABOVE 1000MHZ)	71
APPENDIX E - BANDWIDTH	314
APPENDIX F - MAXIMUM OUTPUT POWER	360
APPENDIX G - POWER SPECTRAL DENSITY	402
APPENDIX H - FREQUENCY STABILITY	579

REPORT ISSUED HISTORY

Issued No.	Description	Issued Date
BTL-FCCP-3-1802C015A	Original Issue.	Sep. 14, 2018

1. CERTIFICATION

Equipment : Android TV DIW387 UHD
Brand Name : SAGEMCOM
Test Model : DIW387 UHD
Series Model : N/A
P/N : 253775312
S/N : 618220036736
Applicant : SAGEMCOM BROADBAND SAS
Manufacturer : SAGEMCOM BROADBAND SAS
Address : 250 Route de l' Empereur - 92848 RUEIL MALMAISON CEDEX- FRANCE
Date of Test : Jul. 11, 2018 ~ Jul. 28, 2018
Test Sample : Engineering Sample No.: D180705661
Standard(s) : FCC Part15, Subpart E(15.407) / ANSI C63.10-2013

The above equipment has been tested and found compliance with the requirement of the relative standards by BTL Inc.

The test data, data evaluation, and equipment configuration contained in our test report (Ref No. BTL-FCCP-3-1802C015A) were obtained utilizing the test procedures, test instruments, test sites that has been accredited by the Authority of NVLAP according to the ISO-17025 quality assessment standard and technical standard(s).

Test results included in this report is only for RLAN 5G UNII-1, UNII-2A, UNII-2C, UNII-3 part.

2. SUMMARY OF TEST RESULTS

Test procedures according to the technical standard(s):

FCC Part15, Subpart E(15.407)			
Standard(s) Section	Test Item	Judgment	Remark
15.207	AC Power Line Conducted Emissions	PASS	
15.407(a)	26dB Spectrum Bandwidth	PASS	
15.407(a)	Maximum Output Power	PASS	
15.407(a)	Power Spectral Density	PASS	
15.407(a)	Radiated Emissions	PASS	
15.407(b)	Band Edge Emissions	PASS	
15.407(g)	Frequency Stability	PASS	
15.203	Antenna Requirements	PASS	

NOTE:

(1) "N/A" denotes test is not applicable in this test report.

2.1 TEST FACILITY

The test facilities used to collect the test data in this report is at the location of No.3,Jinshagang 1st Road, Shixia, Dalang Town, Dongguan, Guangdong, China.

BTL's test firm number for FCC: 854385

BTL's designation number for FCC: CN5020

2.2 MEASUREMENT UNCERTAINTY

The measurement uncertainty figures shall be calculated according the methods described in the ETSI TR 100 028 and shall correspond to an expansion factor (coverage factor) $k=1.96$ or $k=2$ (which provide confidence levels of respectively 90% and 95.45% in the case where the distributions characterizing the actual measurement uncertainties are normal (Gaussian)). Measurement Uncertainty for a Level of Confidence of 95 %, $U=2xUc(y)$.

The BTL measurement uncertainty as below table:

A. Conducted Measurement:

Test Site	Method	Measurement Frequency Range	U, (dB)
DG-C02	CISPR	150 KHz ~ 30MHz	2.32

B. Radiated Measurement:

Test Site	Method	Measurement Frequency Range	Ant. H / V	U, (dB)
DG-CB03	CISPR	9kHz~30MHz	V	3.79
		9kHz~30MHz	H	3.57
		30MHz ~ 200MHz	V	3.82
		30MHz ~ 200MHz	H	3.60
		200MHz ~ 1,000MHz	V	3.86
		200MHz ~ 1,000MHz	H	3.94
		1GHz~18GHz	V	3.12
		1GHz~18GHz	H	3.68
		18GHz~40GHz	V	4.15
		18GHz~40GHz	H	4.14

Note: Unless specifically mentioned, the uncertainty of measurement has not been taken into account to declare the compliance or non-compliance to the specification.

3. GENERAL INFORMATION

3.1 GENERAL DESCRIPTION OF EUT

Equipment	Android TV DIW387 UHD	
Brand Name	SAGEMCOM	
Test Model	DIW387 UHD	
Series Model	N/A	
Model Difference	N/A	
P/N	253775312	
S/N	618220036736	
Hardware Version	PCBA 253775268	
Software Version	BCM SDK:17.1 BOMODE:6	
Product Description	Operation Frequency	UNII-1: 5150 ~ 5250 MHz UNII-2A: 5250 ~ 5350 MHz UNII-2C: 5470 ~ 5725 MHz UNII-3: 5725 ~ 5850 MHz
	Modulation Type	OFDM
	Bit Rate of Transmitter	1733Mbps
	Output Power (Max.)for UNII-1	802.11a: 19.60dBm 802.11n (20M): 19.22dBm 802.11n (40M): 22.25dBm 802.11ac (20M): 19.19dBm 802.11ac (40M): 21.86dBm 802.11ac (80M): 22.16dBm
	Output Power (Max.)for UNII-2A	802.11a: 19.68dBm 802.11n (20M): 18.28dBm 802.11n (40M): 22.22dBm 802.11ac (20M): 18.38dBm 802.11ac (40M): 22.14dBm 802.11ac (80M): 22.30dBm
	Output Power (Max.)for UNII-2C	802.11a: 19.68dBm 802.11n (20M): 18.18dBm 802.11n (40M): 22.13dBm 802.11ac (20M): 18.28dBm 802.11ac (40M): 22.11dBm 802.11ac (80M): 21.87dBm
	Output Power (Max.)for UNII-3	802.11a: 23.77dBm 802.11n (20M): 28.27dBm 802.11n (40M): 27.99dBm 802.11ac (20M): 28.29dBm 802.11ac (40M): 28.12dBm 802.11ac (80M): 28.27dBm
Power Source	DC voltage supplied from AC/DC adapter. Brand / Model: SAGEMCOM / NBS24K120200VU	
Power Rating	I/P: 100-120V~50/60Hz 0.6A O/P: 12V---2.0A	

Note:

1. For a more detailed features description, please refer to the manufacturer's specifications or the User's Manual.
2. Channel List:

802.11a 802.11n 20MHz 802.11ac 20MHz		802.11n 40MHz 802.11ac 40MHz		802.11ac 80MHz	
UNII-1		UNII-1		UNII-1	
Channel	Frequency (MHz)	Channel	Frequency (MHz)	Channel	Frequency (MHz)
36	5180	38	5190	42	5210
40	5200	46	5230		
44	5220				
48	5240				

802.11a 802.11n 20MHz 802.11ac 20MHz		802.11n 40MHz 802.11ac 40MHz		802.11ac 80MHz	
UNII-2A		UNII-2A		UNII-2A	
Channel	Frequency (MHz)	Channel	Frequency (MHz)	Channel	Frequency (MHz)
52	5260	54	5270	58	5290
56	5280	62	5310		
60	5300				
64	5320				

802.11a 802.11n 20MHz 802.11ac 20MHz		802.11n 40MHz 802.11ac 40MHz		802.11ac 80MHz	
UNII-2C		UNII-2C		UNII-2C	
Channel	Frequency (MHz)	Channel	Frequency (MHz)	Channel	Frequency (MHz)
100	5500	102	5510	106	5530
104	5520	110	5550	122	5610
108	5540	118	5590		
112	5560	126	5630		
116	5580	134	5670		
120	5600				
124	5620				
128	5640				
132	5660				
136	5680				
140	5700				

802.11a 802.11n 20MHz 802.11ac 20MHz		802.11n 40MHz 802.11ac 40MHz		802.11ac 80MHz	
UNII-3		UNII-3		UNII-3	
Channel	Frequency (MHz)	Channel	Frequency (MHz)	Channel	Frequency (MHz)
149	5745	151	5755	155	5775
153	5765	159	5795		
157	5785				
161	5805				
165	5825				

3. Antenna Specification:

Ant.	Manufacturer	Model Name	Antenna Type	Connector	Gain(dBi)
1	N/A	N/A	PIFA	N/A	6.54
2	N/A	N/A	PIFA	N/A	3.54
3	N/A	N/A	PIFA	N/A	5.31
4	N/A	N/A	PIFA	N/A	3.37

Note:

For 802.11n 20MHz, 802.11n 40MHz, 802.11ac 20MHz, 802.11ac 40MHz, 802.11ac 80MHz:

- This EUT supports MIMO 4X4, any transmit signals are correlated with each other, Directional gain =7.64, so,
 The UNII-1 Output Power limit is $24-7.64+6= 22.36$ dBm
 The UNII-2A Output Power limit is $24-7.64+6= 22.36$ dBm
 The UNII-2C Output Power limit is $24-7.64+6= 22.36$ dBm
 The UNII-3 Output Power limit is $30-7.64+6= 28.36$ dBm

The UNII-1 PSD limit is $11-7.64+6= 9.36$ dBm/MHz
 The UNII-2A PSD limit is $11-7.64+6= 9.36$ dBm/MHz
 The UNII-2C PSD limit is $11-7.64+6= 9.36$ dBm/MHz
 The UNII-3 PSD limit is $30-7.64+6= 28.36$ dBm/500kHz

For 802.11a:

- Directional gain =Antenna Gain=6.54,then,
 The UNII-1, UNII-2A, UNII-2C Output Power limit is $24-6.54+6= 23.46$ dBm, the UNII-3 Output Power limit is $30-6.54+6= 29.46$ dBm; the UNII-1, UNII-2A, UNII-2C PSD limit is $11-6.54+6= 10.46$ dBm/MHz, The UNII-3 PSD limit is $30-6.54+6= 29.46$ dBm/500kHz

4. The worst case for 1TX/ 4TX as follow:

Operating Mode	TX Mode	1TX	4TX
802.11a		V (ANT 1)	-
802.11n (20MHz)		-	V (ANT+1 ANT 2+ANT 3+ ANT 4)
802.11n (40MHz)		-	V (ANT+1 ANT 2+ANT 3+ ANT 4)
802.11ac (20MHz)		-	V (ANT+1 ANT 2+ANT 3+ ANT 4)
802.11ac (40MHz)		-	V (ANT+1 ANT 2+ANT 3+ ANT 4)
802.11ac (80MHz)		-	V (ANT+1 ANT 2+ANT 3+ ANT 4)

3.2 DESCRIPTION OF TEST MODES

To investigate the maximum EMI emission characteristics generates from EUT, the test system was pre-scanning tested base on the consideration of following EUT operation mode or test configuration mode which possible have effect on EMI emission level. Each of these EUT operation mode(s) or test configuration mode(s) mentioned above was evaluated respectively.

Pretest Mode	Description
Mode 1	TX A Mode / CH36, CH40, CH48 (UNII-1)
Mode 2	TX N20 Mode / CH36, CH40, CH48 (UNII-1)
Mode 3	TX N40 Mode / CH38, CH46 (UNII-1)
Mode 4	TX AC20 Mode / CH36, CH40, CH48 (UNII-1)
Mode 5	TX AC40 Mode / CH38, CH46 (UNII-1)
Mode 6	TX AC80 Mode / CH42 (UNII-1)
Mode 7	TX A Mode / CH52, CH60, CH64 (UNII-2A)
Mode 8	TX N20 Mode / CH52, CH60, CH64 (UNII-2A)
Mode 9	TX N40 Mode / CH54, CH62 (UNII-2A)
Mode 10	TX AC20 Mode / CH52, CH60, CH64 (UNII-2A)
Mode 11	TX AC40 Mode / CH54, CH62 (UNII-2A)
Mode 12	TX AC80 Mode / CH58 (UNII-2A)
Mode 13	TX A Mode / CH100, CH116, CH140 (UNII-2C)
Mode 14	TX N20 Mode / CH100, CH116, CH140 (UNII-2C)
Mode 15	TX N40 Mode / CH102, CH110, CH134 (UNII-2C)
Mode 16	TX AC20 Mode / CH100, CH116, CH140 (UNII-2C)
Mode 17	TX AC40 Mode / CH102, CH110, CH134 (UNII-2C)
Mode 18	TX AC80 Mode / CH106, CH122 (UNII-2C)
Mode 19	TX A Mode / CH149,CH157,CH165 (UNII-3)
Mode 20	TX N20 Mode / CH149,CH157,CH165 (UNII-3)
Mode 21	TX N40 Mode / CH151,CH159 (UNII-3)
Mode 22	TX AC20 Mode / CH149,CH157,CH165 (UNII-3)
Mode 23	TX AC40 Mode / CH151,CH159 (UNII-3)
Mode 24	TX AC80 Mode / CH155 (UNII-3)
Mode 25	TX Mode

The EUT system operated these modes were found to be the worst case during the pre-scanning test as following:

For Conducted Test	
Final Test Mode	Description
Mode 25	TX Mode

For Radiated Test	
Final Test Mode	Description
Mode 1	TX A Mode / CH36, CH40, CH48 (UNII-1)
Mode 2	TX N20 Mode / CH36, CH40, CH48 (UNII-1)
Mode 3	TX N40 Mode / CH38, CH46 (UNII-1)
Mode 4	TX AC20 Mode / CH36, CH40, CH48 (UNII-1)
Mode 5	TX AC40 Mode / CH38, CH46 (UNII-1)
Mode 6	TX AC80 Mode / CH42 (UNII-1)
Mode 7	TX A Mode / CH52, CH60, CH64 (UNII-2A)
Mode 8	TX N20 Mode / CH52, CH60, CH64 (UNII-2A)
Mode 9	TX N40 Mode / CH54, CH62 (UNII-2A)
Mode 10	TX AC20 Mode / CH52, CH60, CH64 (UNII-2A)
Mode 11	TX AC40 Mode / CH54, CH62 (UNII-2A)
Mode 12	TX AC80 Mode / CH58 (UNII-2A)
Mode 13	TX A Mode / CH100, CH116, CH140 (UNII-2C)
Mode 14	TX N20 Mode / CH100, CH116, CH140 (UNII-2C)
Mode 15	TX N40 Mode / CH102, CH110, CH134 (UNII-2C)
Mode 16	TX AC20 Mode / CH100, CH116, CH140 (UNII-2C)
Mode 17	TX AC40 Mode / CH102, CH110, CH134 (UNII-2C)
Mode 18	TX AC80 Mode / CH106, CH122 (UNII-2C)
Mode 19	TX A Mode / CH149,CH157,CH165 (UNII-3)
Mode 20	TX N20 Mode / CH149,CH157,CH165 (UNII-3)
Mode 21	TX N40 Mode / CH151,CH159 (UNII-3)
Mode 22	TX AC20 Mode / CH149,CH157,CH165 (UNII-3)
Mode 23	TX AC40 Mode / CH151,CH159 (UNII-3)
Mode 24	TX AC80 Mode / CH155 (UNII-3)

Note:

(1) For radiated below 1GHz test, the 802.11a mode is found to be the worst case and recorded.

3.3 TABLE OF PARAMETERS OF TEST SOFTWARE SETTING

During testing channel & power controlling software provided by the customer was used to control the operating channel as well as the output power level. The RF output power selection is for the setting of RF output power expected by the customer and is going to be fixed on the firmware of the final end product

UNII-1			
Test Software Version	STB_MTool_2.1.1		
Frequency (MHz)	5180	5200	5240
A Mode	76	76	76
N20 Mode	48	48	48
AC20 Mode	48	48	48
Frequency (MHz)	5190	5230	
N40 Mode	60	60	
AC40 Mode	55	59	
Frequency (MHz)	5210		
AC80 Mode	59		

UNII-2A			
Test Software Version	STB_MTool_2.1.1		
Frequency (MHz)	5260	5300	5320
A Mode	76	76	76
N20 Mode	45	45	45
AC20 Mode	45	45	45
Frequency (MHz)	5270	5310	
N40 Mode	59	53	
AC40 Mode	59	55	
Frequency (MHz)	5290		
AC80 Mode	60		

UNII-2C			
Test Software Version	STB_MTool_2.1.1		
Frequency (MHz)	5500	5580	5700
A Mode	78	78	78
N20 Mode	47	47	47
AC20 Mode	47	47	47
Frequency (MHz)	5510	5550	5670
N40 Mode	60	60	60
AC40 Mode	55	60	60
Frequency (MHz)	5530	5610	
AC80 Mode	60	60	

UNII-3			
Test Software Version	STB_MTool_2.1.1		
Frequency (MHz)	5745	5785	5825
A Mode	96	96	96
N20 Mode	88	88	88
AC20 Mode	88	88	88
Frequency (MHz)	5755	5795	
N40 Mode	87	87	
AC40 Mode	86	87	
Frequency (MHz)	5775		
AC80 Mode	86		

3.4 BLOCK DIAGRAM SHOWING THE CONFIGURATION OF SYSTEM TESTED

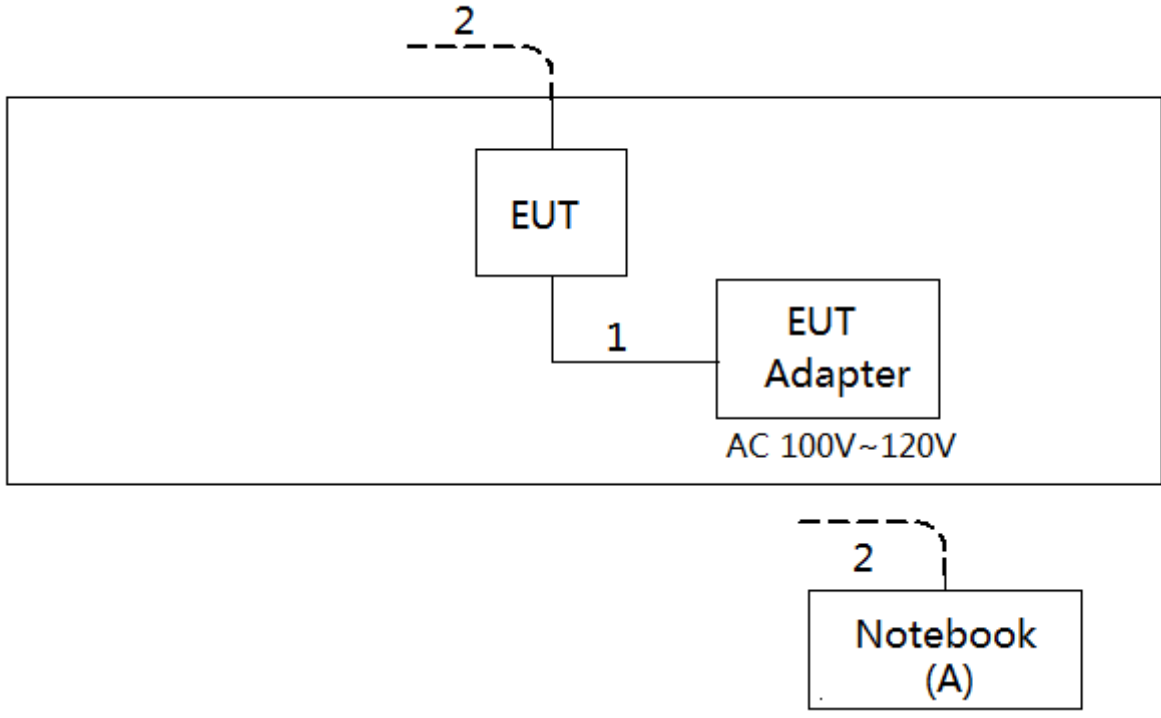

3.5 DESCRIPTION OF SUPPORT UNITS

The EUT has been tested as an independent unit together with other necessary accessories or support units. The following support units or accessories were used to form a representative test configuration during the tests.

Item	Equipment	Mfr/Brand	Model/Type No.	FCC ID	Series No.
A	Notebook	Dell	DCSM	DOC	G7K832X

Item	Shielded Type	Ferrite Core	Length	Note
1	NO	NO	2m	DC Cable
2	NO	NO	10m	RJ45 Cable

4. EMC EMISSION TEST

4.1 CONDUCTED EMISSION MEASUREMENT

4.1.1 POWER LINE CONDUCTED EMISSION (Frequency Range 150kHz-30MHz)

FREQUENCY (MHz)	Class A (dBuV)		Class B (dBuV)	
	Quasi-peak	Average	Quasi-peak	Average
0.15 -0.5	79.00	66.00	66 - 56 *	56 - 46 *
0.50 -5.0	73.00	60.00	56.00	46.00
5.0 -30.0	73.00	60.00	60.00	50.00

Note:

- (1) The tighter limit applies at the band edges.
- (2) The limit of " * " marked band means the limitation decreases linearly with the logarithm of the frequency in the range.

4.1.2 TEST PROCEDURE

- a. The EUT was placed 0.8 meters from the horizontal ground plane with EUT being connected to the power mains through a line impedance stabilization network (LISN). All other support equipments powered from additional LISN(s). The LISN provide 50 Ohm/ 50uH of coupling impedance for the measuring instrument.
- b. Interconnecting cables that hang closer than 40 cm to the ground plane shall be folded back and forth in the center forming a bundle 30 to 40 cm long.
- c. I/O cables that are not connected to a peripheral shall be bundled in the center. The end of the cable may be terminated, if required, using the correct terminating impedance. The overall length shall not exceed 1 m.
- d. LISN at least 80 cm from nearest part of EUT chassis.
- e. For the actual test configuration, please refer to the related Item –EUT Test Photos.

4.1.3 DEVIATION FROM TEST STANDARD

No deviation

4.1.4 TEST SETUP

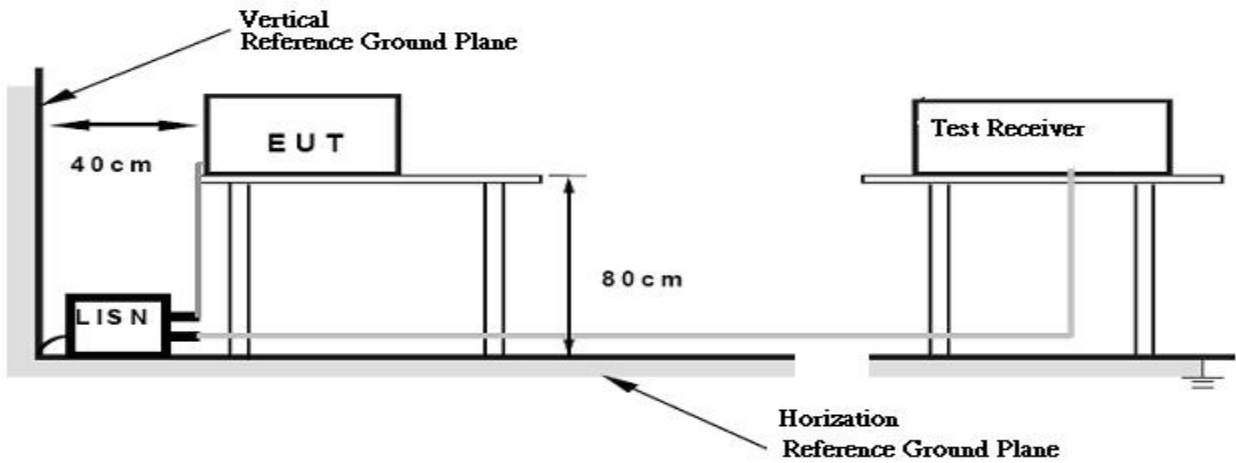

4.1.5 EUT OPERATING CONDITIONS

The EUT was configured for testing in a typical fashion (as a customer would normally use it). The EUT has been programmed to continuously transmit during test. This operating condition was tested and used to collect the included data.
 The EUT was programmed to be in continuously transmitting/TX Mode mode.

4.1.6 EUT TEST CONDITIONS

Temperature: 25°C Relative Humidity: 53% Test Voltage: AC 120V/60Hz

4.1.7 TEST RESULTS

Please refer to the Appendix A.

Remark:

- (1) All readings are QP Mode value unless otherwise stated AVG in column of『Note』. If the QP Mode Measured value compliance with the QP Limits and lower than AVG Limits, the EUT shall be deemed to meet both QP & AVG Limits and then only QP Mode was measured, but AVG Mode didn't perform. In this case, a “ * ” marked in AVG Mode column of Interference Voltage Measured.
- (2) Measuring frequency range from 150kHz to 30MHz.

4.2 RADIATED EMISSION MEASUREMENT

4.2.1 RADIATED EMISSION LIMITS

In case the emission fall within the restricted band specified on 15.205(a), then the 15.209(a) limit in the table below has to be followed.

Frequencies (MHz)	Field Strength (microrvolts/meter)	Measurement Distance (meters)
0.009~0.490	2400/F(kHz)	300
0.490~1.705	24000/F(kHz)	30
1.705~30.0	30	30
30~88	100	3
88~216	150	3
216~960	200	3
Above 960	500	3

Frequencies (MHz)	EIRP Limit (dBm)	Equivalent Field Strength at 3m (dBμV/m)
5150-5250	-27	68.3
5250-5350	-27	68.3
5470-5725	-27	68.3
5725-5850	-27(Note 2)	68.3
	10(Note 2)	105.3
	15.6(Note 2)	110.9
	27(Note 2)	122.3

Note:

1. The following formula is used to convert the equipment isotropic radiated power (eirp) to

field strength: $E = \frac{1000000\sqrt{30P}}{3} \mu\text{V/m}$, where P is the eirp (Watts)

2. According to FCC 16-24, All emissions shall be limited to a level of -27 dBm/MHz at 75 MHz or more above or below the band edge increasing linearly to 10 dBm/MHz at 25 MHz above or below the band edge, and from 25MHz above or below the band edge increasing linearly to a level of 15.6 dBm/MHz at 5 MHz above or below the band edge, and from 5 MHz above or below the band edge increasing linearly to a level of 27dBm/MHz at the band edge.

4.2.2 TEST PROCEDURE

- a. The measuring distance of 3 m shall be used for measurements. The EUT was placed on the top of a rotating table 0.8 meter above the ground at a 3 meter semi-anechoic chamber. The table was rotated 360 degrees to determine the position of the highest radiation.(below 1GHz)
- b. The measuring distance of 3 m shall be used for measurements. The EUT was placed on the top of a rotating table 1.5 meter above the ground at a 3 meter semi-anechoic chamber. The table was rotated 360 degrees to determine the position of the highest radiation.(above 1GHz)
- c. The height of the equipment or of the substitution antenna shall be 0.8m or 1.5m; the height of the test antenna shall vary between 1 m to 4 m. Both horizontal and vertical polarizations of the antenna are set to make the measurement.
- d. For each suspected emission, the EUT was arranged to its worst case and then the antenna was tuned to heights find the maximum reading (used Bore sight function).
- e. The receiver system was set to peak and average detect function and specified bandwidth with maximum hold mode when the test frequency is above 1GHz.
- f. The initial step in collecting radiated emission data is a receiver peak detector mode pre-scanning the measurement frequency range. Significant peaks are then marked and then Quasi Peak detector mode re-measured.
- g. All readings are Peak unless otherwise stated QP in column of Note. Peak denotes that the Peak reading compliance with the QP Limits and then QP Mode measurement didn't perform. (below 1GHz)
- h. All readings are Peak Mode value unless otherwise stated AVG in column of Note. If the Peak Mode Measured value compliance with the Peak Limits and lower than AVG Limits, the EUT shall be deemed to meet both Peak & AVG Limits and then only Peak Mode was measured, but AVG Mode didn't perform. (above 1GHz)
- i. For the actual test configuration, please refer to the related Item –EUT Test Photos.

4.2.3 DEVIATION FROM TEST STANDARD

No deviation

4.2.4 TEST SETUP

(A) Radiated Emission Test Set-Up Frequency Below 1GHz

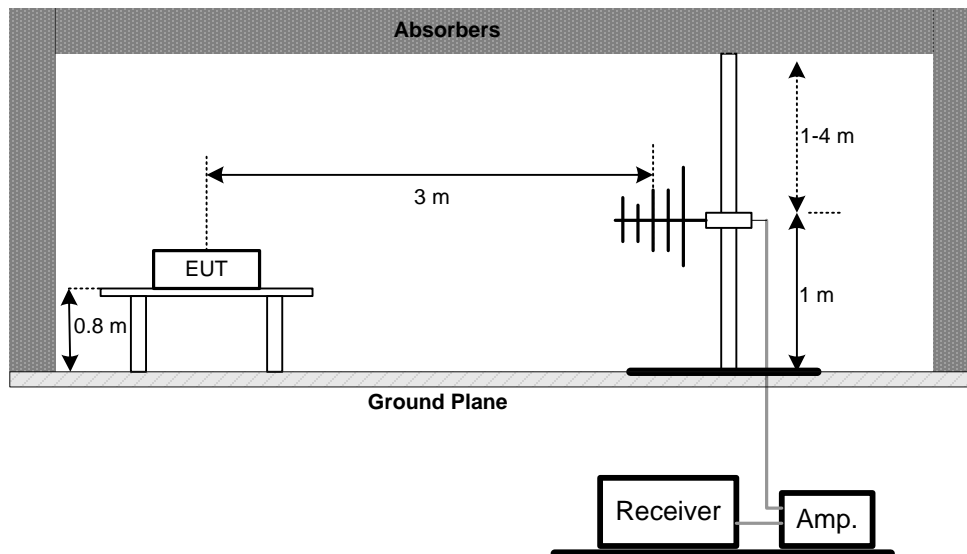

(B) Radiated Emission Test Set-Up Frequency Above 1 GHz

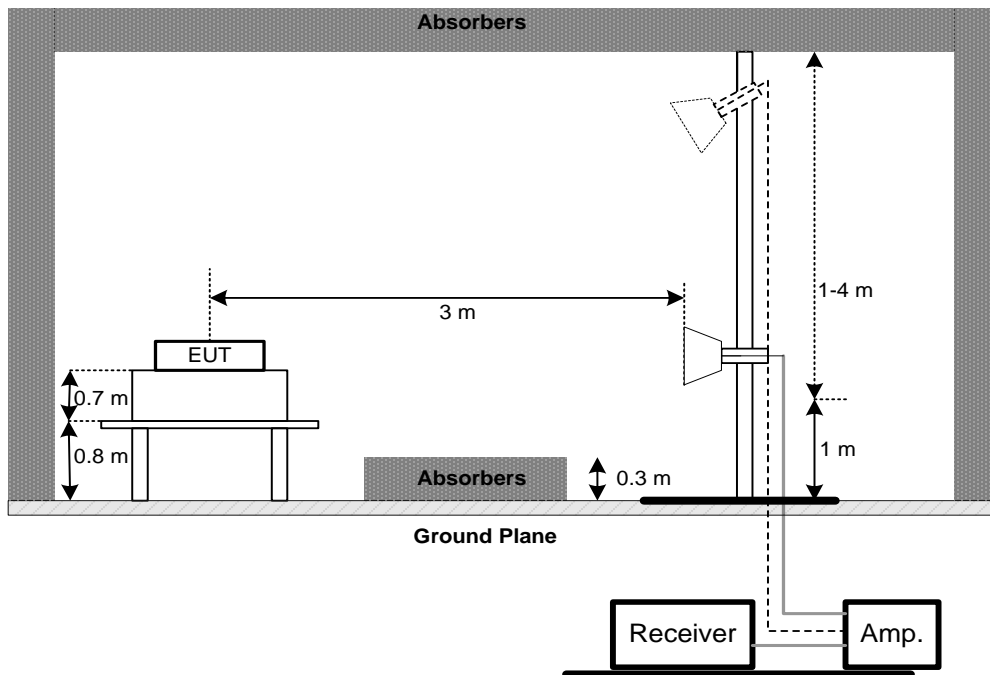

(C) Radiated emissions below 30MHz

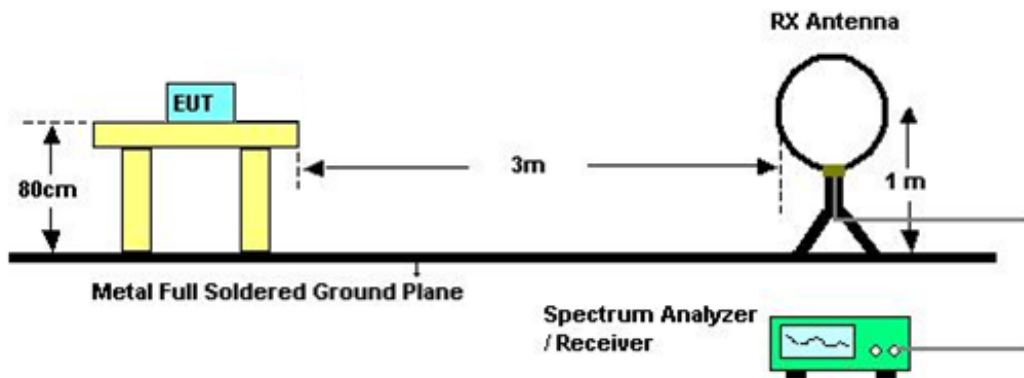

4.2.5 EUT OPERATING CONDITIONS

The EUT tested system was configured as the statements of 4.1.5 unless otherwise a special operating condition is specified in the follows during the testing.

4.2.6 EUT TEST CONDITIONS

Temperature: 25°C Relative Humidity: 60% Test Voltage: AC 120V/60Hz

4.2.7 TEST RESULTS (9K TO 30MHz)

Please refer to the Appendix B

Remark:

- (1) The amplitude of spurious emissions which are attenuated by more than 20 dB below the permissible value has no need to be reported.
- (2) Distance extrapolation factor = $40 \log$ (specific distance / test distance) (dB);
- (3) Limit line = specific limits (dBuV) + distance extrapolation factor.

4.2.8 TEST RESULTS (BETWEEN 30 TO 1000 MHz)

Please refer to the Appendix C.

4.2.9 TEST RESULTS (ABOVE 1000 MHz)

Please refer to the Appendix D.

Remark:

- (1) No limit: This is fundamental signal, the judgment is not applicable.
For fundamental signal judgment was referred to Peak output test.

5. 26dB SPECTRUM BANDWIDTH

5.1 APPLIED PROCEDURES / LIMIT

FCC Part15, Subpart E			
Test Item	Limit	Frequency Range (MHz)	Result
Bandwidth	26 dB Bandwidth	5150-5250	PASS
	26 dB Bandwidth	5250-5350	PASS
	26 dB Bandwidth	5470-5725	PASS
	Minimum 500kHz 6dB Bandwidth	5725-5850	PASS

5.1.1 TEST PROCEDURE

a. The EUT was directly connected to the spectrum analyzer and antenna output port as show in the block diagram below,

b.

Spectrum Parameters	Setting
Attenuation	Auto
Span Frequency	> 26dB Bandwidth
RBW	300 kHz(Bandwidth 20MHz) 1MHz(Bandwidth 40MHz and 80MHz)
VBW	1MHz(Bandwidth 20MHz) 3MHz(Bandwidth 40MHz and 80MHz)
Detector	Peak
Trace	Max Hold
Sweep Time	Auto

c. Measured the spectrum width with power higher than 26dB below carrier

5.1.2 DEVIATION FROM STANDARD

No deviation.

5.1.3 TEST SETUP



5.1.4 EUT OPERATION CONDITIONS

The EUT tested system was configured as the statements of 4.1.5 unless otherwise a special operating condition is specified in the follows during the testing.

5.1.5 EUT TEST CONDITIONS

Temperature: 25°C Relative Humidity: 60% Test Voltage: AC 120V/60Hz

5.1.6 TEST RESULTS

Please refer to the Appendix E.

6. MAXIMUM OUTPUT POWER

6.1 APPLIED PROCEDURES / LIMIT

FCC Part15, Subpart E			
Test Item	Limit	Frequency Range (MHz)	Result
Maximum Output Power	Fixed:1 Watt (30dBm) Mobile and portable: 250mW (24dBm)	5150-5250	PASS
	250mW (24dBm)	5250-5350	PASS
	250mW (24dBm)	5470-5725	PASS
	1 Watt (30dBm)	5725-5850	PASS

Note: The maximum e.i.r.p at any elevation angle above 30 degrees as measured from the horizon must not exceed 125mW(21dBm)

6.1.1 TEST PROCEDURE

- a. The EUT was directly connected to the spectrum analyzer and antenna output port as show in the block diagram below,
- b. Used spectrum analyzer band power measurement function.
- c.

Spectrum Parameter	Setting
Attenuation	Auto
Span Frequency	Encompass the entire emissions bandwidth (EBW) of the signal
RBW	= 1MHz.
VBW	\geq □MHz.
Sweep points	$\geq 2 \times \text{span} / \text{RBW}$
Detector	RMS
Trace	Trace average at least 100 traces in power averaging(rms) mode.
Sweep Time	auto

- c. Test was performed in accordance with method of KDB 789033 D02.

6.1.2 DEVIATION FROM STANDARD

No deviation.

6.1.3 TEST SETUP



6.1.4 EUT OPERATION CONDITIONS

The EUT tested system was configured as the statements of 4.1.5 unless otherwise a special operating condition is specified in the follows during the testing.

6.1.5 EUT TEST CONDITIONS

Temperature: 25°C Relative Humidity: 60% Test Voltage: AC 120V/60Hz

6.1.6 TEST RESULTS

Please refer to the Appendix F.

7. POWER SPECTRAL DENSITY TEST

7.1 APPLIED PROCEDURES / LIMIT

FCC Part15, Subpart E			
Test Item	Limit	Frequency Range (MHz)	Result
Power Spectral Density	Other then Mobile and portable:17dBm/MHz Mobile and portable:11dBm/MHz	5150-5250	PASS
	11dBm/MHz	5250-5350	PASS
	11dBm/MHz	5470-5725	PASS
	30dBm/500kHz	5725-5850	PASS

8.1.1 TEST PROCEDURE

a. The EUT was directly connected to the spectrum analyzer and antenna output port as show in the block diagram below,

b.

Spectrum Parameter	Setting
Attenuation	Auto
Span Frequency	Encompass the entire emissions bandwidth (EBW) of the signal
RBW	= 1MHz.
VBW	≥ 3MHz.
Detector	RMS
Trace average	100 trace
Sweep Time	Auto

Note:

- For UNII-3, according to KDB publication 789033 D02 General UNII Test Procedures New Rules v01r02, section II.F.5., it is acceptable to set RBW at 1MHz and VBW at 3MHz if the spectrum analyzer does not have 500kHz RBW.
- The value measured with RBW=1MHz is to be added with $10\log(500\text{kHz}/1\text{MHz})$ which is -3dB. For example, if the measured value is +10dBm using RBW=1MHz (that is +10dBm/MHz), then the converted value will be +7dBm/500kHz.

7.1.1 DEVIATION FROM STANDARD

No deviation.

7.1.2 TEST SETUP



7.1.3 EUT OPERATION CONDITIONS

The EUT tested system was configured as the statements of 4.1.5 unless otherwise a special operating condition is specified in the follows during the testing.

7.1.4 EUT TEST CONDITIONS

Temperature: 25°C Relative Humidity: 60% Test Voltage: AC 120V/60Hz

7.1.5 TEST RESULTS

Please refer to the Appendix H.

8. FREQUENCY STABILITY MEASUREMENT

8.1 APPLIED PROCEDURES / LIMIT

FCC Part15, Subpart E			
Test Item	Limit	Frequency Range (MHz)	Result
Frequency Stability	Specified in the user's manual	5150-5250	PASS
		5250-5350	PASS
		5470-5725	PASS
		5725-5850	PASS

8.1.1 TEST PROCEDURE

a. The EUT was directly connected to the spectrum analyzer and antenna output port as show in the block diagram below,

b.

Spectrum Parameter	Setting
Attenuation	Auto
Span Frequency	Entire absence of modulation emissions bandwidth
RBW	10 kHz
VBW	10 kHz
Sweep Time	Auto

c. The test extreme voltage is to change the primary supply voltage from 85 to 115 percent of the nominal value.

d. User manual temperature is 0°C~40°C.

8.1.2 DEVIATION FROM STANDARD

No deviation.

8.1.3 TEST SETUP

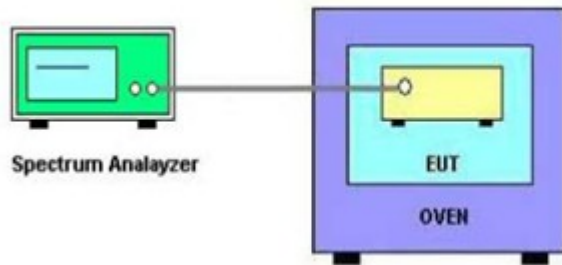

8.1.4 EUT OPERATION CONDITIONS

The EUT tested system was configured as the statements of 4.1.5 unless otherwise a special operating condition is specified in the follows during the testing.

8.1.5 EUT TEST CONDITIONS

Temperature: 25°C Relative Humidity: 55% Test Voltage: AC 120V/60Hz

8.1.6 TEST RESULTS

Please refer to the Appendix I.

9. MEASUREMENT INSTRUMENTS LIST

Conducted Emission Measurement					
Item	Kind of Equipment	Manufacturer	Type No.	Serial No.	Calibrated until
1	EMI Test Receiver	R&S	ESCI	100382	Mar. 11, 2019
2	LISN	EMCO	3816/2	52765	Mar. 11, 2019
3	50Ω Terminator	SHX	TF2-3G-A	8122901	Mar. 11, 2019
4	TWO-LINE V-NETWORK	R&S	ENV216	101447	Mar. 11, 2019
5	Measurement Software	Farad	EZ-EMC Ver.NB-03A1-01	N/A	N/A
6	Cable	N/A	RG223	12m	Oct. 19, 2018

Radiated Emission Measurement - 9KHZ TO 30MHZ					
Item	Kind of Equipment	Manufacturer	Type No.	Serial No.	Calibrated until
1	Loop Antenna	EM	EM-6876-1	230	Feb. 07, 2019
2	Cable	N/A	RG 213/U	C-102	Jun. 01, 2019
3	EMI Test Receiver	R&S	ESCI	100382	Mar. 11, 2019

Radiated Emission Measurement - Below 1GHz					
Item	Kind of Equipment	Manufacturer	Type No.	Serial No.	Calibrated until
1	Antenna	Schwarbeck	VULB9160	9160-3232	Mar. 11, 2019
2	Amplifier	HP	8447D	2944A09673	Oct. 19, 2018
3	Receiver	Agilent	N9038A	MY52130039	Aug. 20, 2018
4	Cable	emci	LMR-400(30MHz-1 GHz)(8m+5m)	N/A	May. 25, 2019
5	Controller	CT	SC100	N/A	N/A
6	Controller	MF	MF-7802	MF780208416	N/A
7	Measurement Software	Farad	EZ-EMC Ver.NB-03A1-01	N/A	N/A
8	Antenna	EM	EM-6876-1	230	Feb. 07, 2019

Radiated Emission Measurement - Above 1GHz					
Item	Kind of Equipment	Manufacturer	Type No.	Serial No.	Calibrated until
1	Double Ridged Guide Antenna	ETS	3115	75789	Mar. 11, 2019
2	Broad-Band Horn Antenna	Schwarzbeck	BBHA 9170	9170319	Jun. 30, 2019
3	Amplifier	Agilent	8449B	3008A02274	Mar. 11, 2019
4	Microwave Preamplifier With Adaptor	EMC INSTRUMENT	EMC2654045	980039 & HA01	Mar. 11, 2019
5	Receiver	Agilent	N9038A	MY52130039	Aug. 20, 2018
6	Controller	CT	SC100	N/A	N/A
7	Controller	MF	MF-7802	MF780208416	N/A
8	Cable	N/A	CA500-SMSM-12M (1-26.5GHz)	N/A	Sep. 29, 2018
9	Measurement Software	Farad	EZ-EMC Ver.NB-03A1-01	N/A	N/A

Spectrum Bandwidth Measurement					
Item	Kind of Equipment	Manufacturer	Type No.	Serial No.	Calibrated until
1	Spectrum Analyzer	R&S	FSP40	100185	Aug. 20, 2018

Maximum Conducted Output Power Measurement					
Item	Kind of Equipment	Manufacturer	Type No.	Serial No.	Calibrated until
1	Spectrum Analyzer	R&S	FSP40	100185	Aug. 20, 2018

Power Spectral Density Measurement					
Item	Kind of Equipment	Manufacturer	Type No.	Serial No.	Calibrated until
1	Spectrum Analyzer	R&S	FSP40	100185	Aug. 20, 2018

Frequency Stability Measurement					
Item	Kind of Equipment	Manufacturer	Type No.	Serial No.	Calibrated until
1	Spectrum Analyzer	R&S	FSP40	100185	Aug. 20, 2018
2	Precision Oven Tester	Bell	BTH-50C	20170306001	Mar. 11, 2019

Remark: "N/A" denotes no model name, serial no. or calibration specified.
 All calibration period of equipment list is one year.

APPENDIX A - CONDUCTED EMISSION

Test Mode: TX MODE

Line

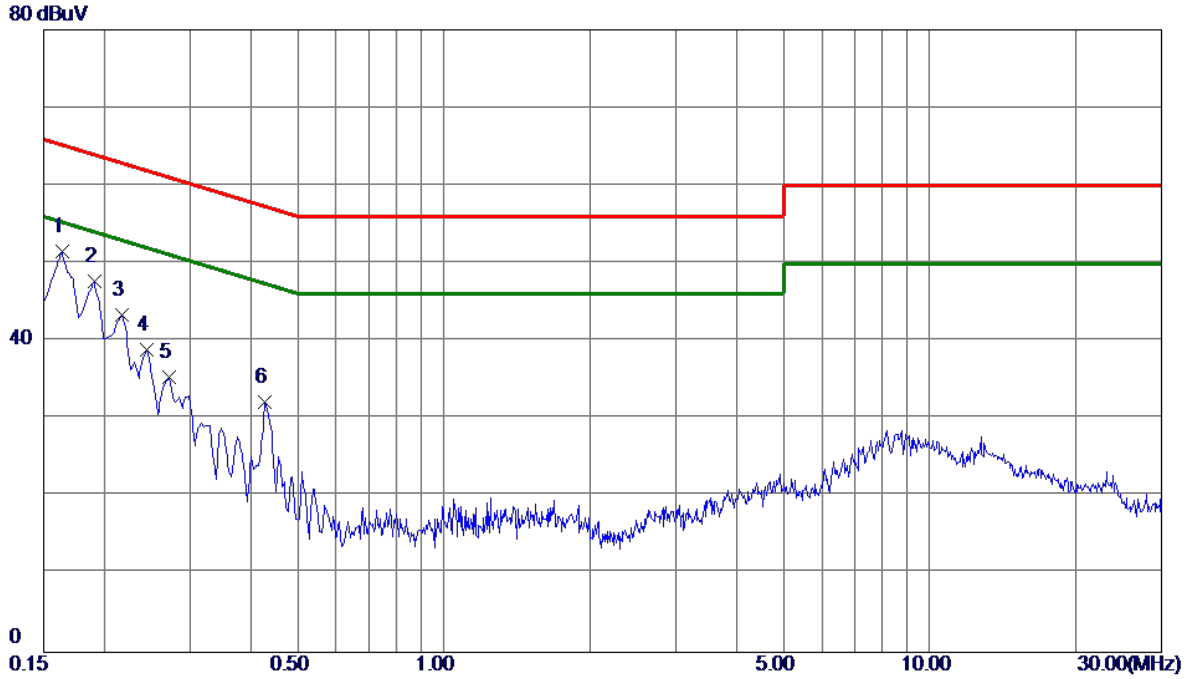

No.	Freq. MHz	Reading Level dBuV	Correct Factor dB	Measure ment dBuV	Limit dBuV	Margin dB	Detector	Comment
1 *	0.1635	41.67	9.82	51.49	65.28	-13.79	Peak	
2	0.1905	37.83	9.82	47.65	64.01	-16.36	Peak	
3	0.2175	33.60	9.82	43.42	62.91	-19.49	Peak	
4	0.2445	29.12	9.82	38.94	61.94	-23.00	Peak	
5	0.2714	25.49	9.82	35.31	61.07	-25.76	Peak	
6	0.4290	22.38	9.80	32.18	57.27	-25.09	Peak	

Note : The test result has included the cable loss.

Test Mode: TX MODE

Neutral

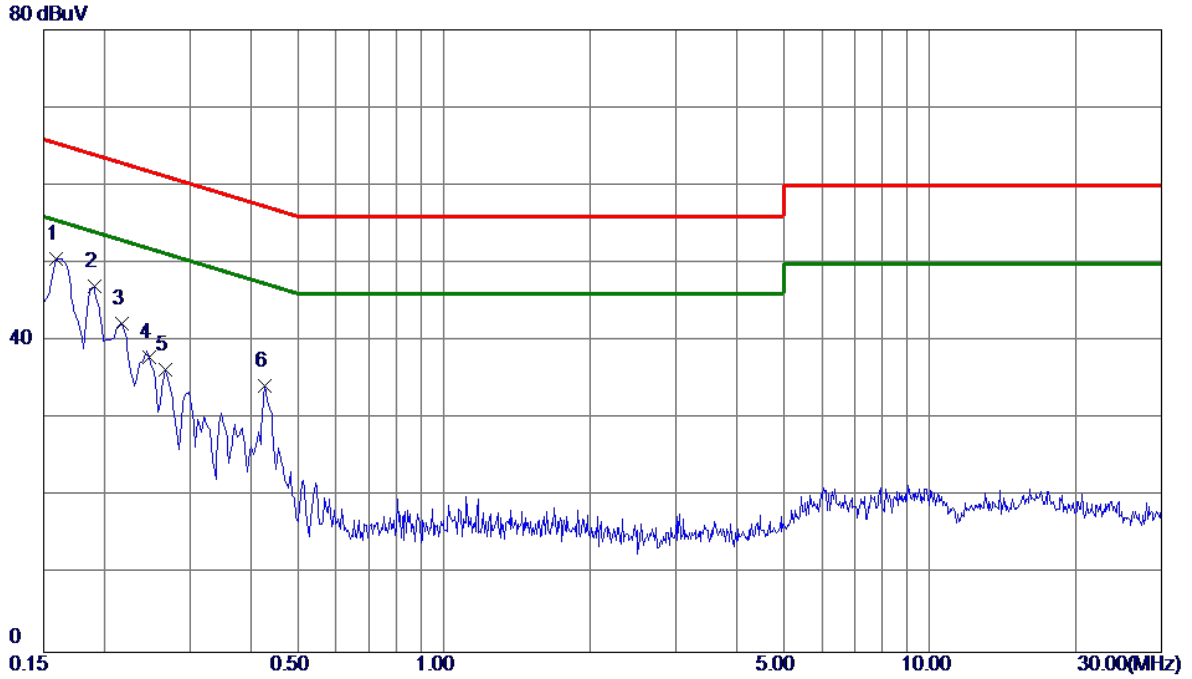

No.	Freq. MHz	Reading Level dBuV	Correct Factor dB	Measure ment dBuV	Limit dBuV	Margin dB	Detector	Comment
1 *	0.1590	40.71	9.91	50.62	65.52	-14.90	Peak	
2	0.1905	37.14	9.91	47.05	64.01	-16.96	Peak	
3	0.2175	32.37	9.91	42.28	62.91	-20.63	Peak	
4	0.2468	27.99	9.92	37.91	61.86	-23.95	Peak	
5	0.2670	26.39	9.92	36.31	61.21	-24.90	Peak	
6	0.4290	24.32	9.95	34.27	57.27	-23.00	Peak	

Note : The test result has included the cable loss.

APPENDIX B - RADIATED EMISSION (9KHZ TO 30MHZ)

Test Mode: TX MODE

Ant 0°

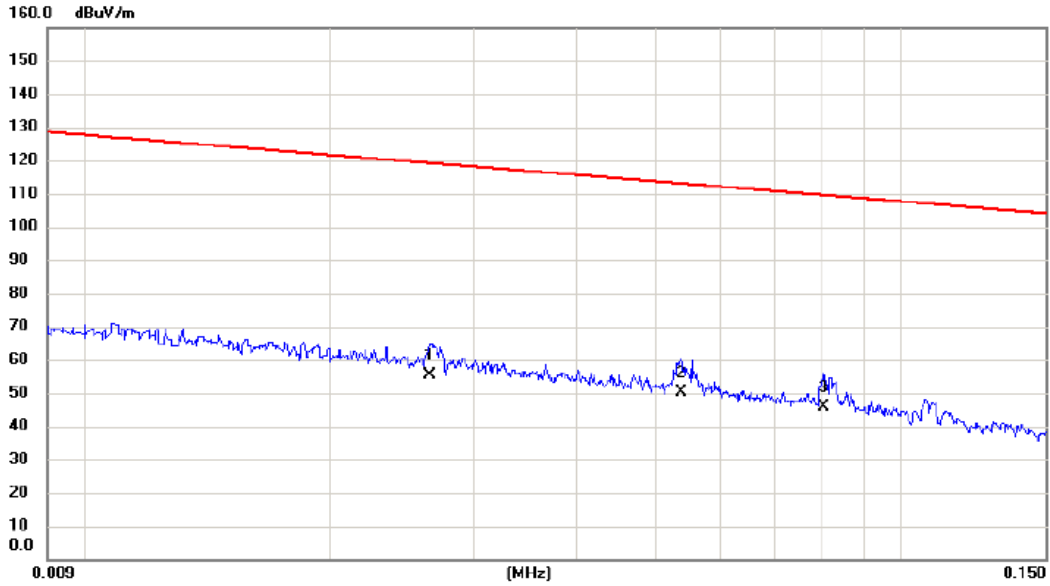

No.	Mk.	Freq. MHz	Reading Level dBuV	Correct Factor dB	Measure- ment dBuV/m	Limit dBuV/m	Margin dB	Detector	Comment
1		0.0265	35.30	19.91	55.21	119.14	-63.93	AVG	
2	*	0.0537	30.60	19.45	50.05	113.01	-62.96	AVG	
3		0.0803	26.80	18.90	45.70	109.51	-63.81	AVG	

Test Mode: TX MODE

Ant 0°

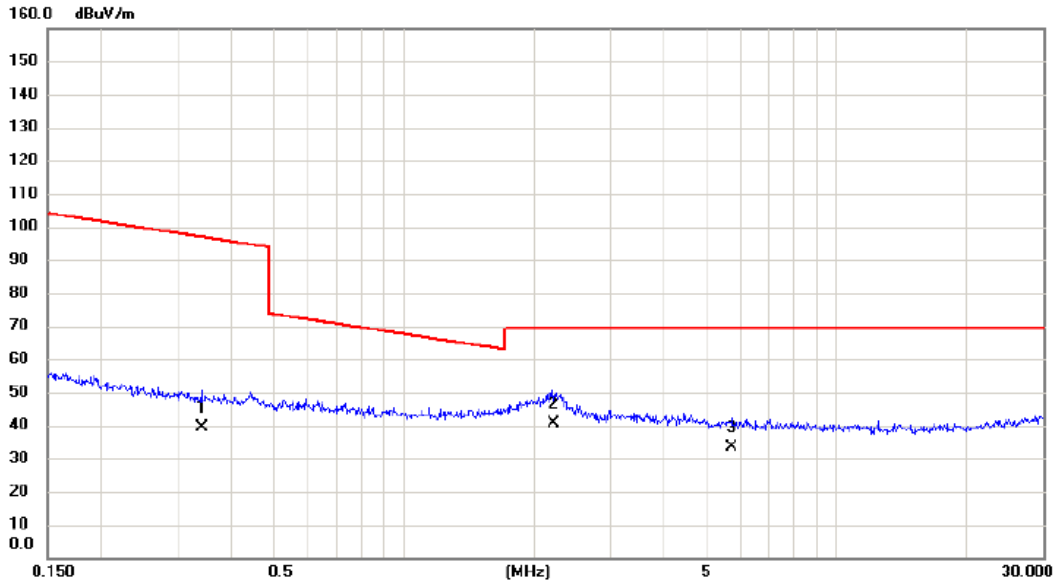

No. Mk.	Freq. MHz	Reading Level dBuV	Correct Factor dB	Measurement dBuV/m	Limit dBuV/m	Margin dB	Detector	Comment
1	0.3410	22.30	17.02	39.32	96.95	-57.63	AVG	
2 *	2.2132	23.70	16.98	40.68	69.54	-28.86	QP	
3	5.7135	18.20	15.05	33.25	69.54	-36.29	QP	

Test Mode: TX MODE

Ant 90°

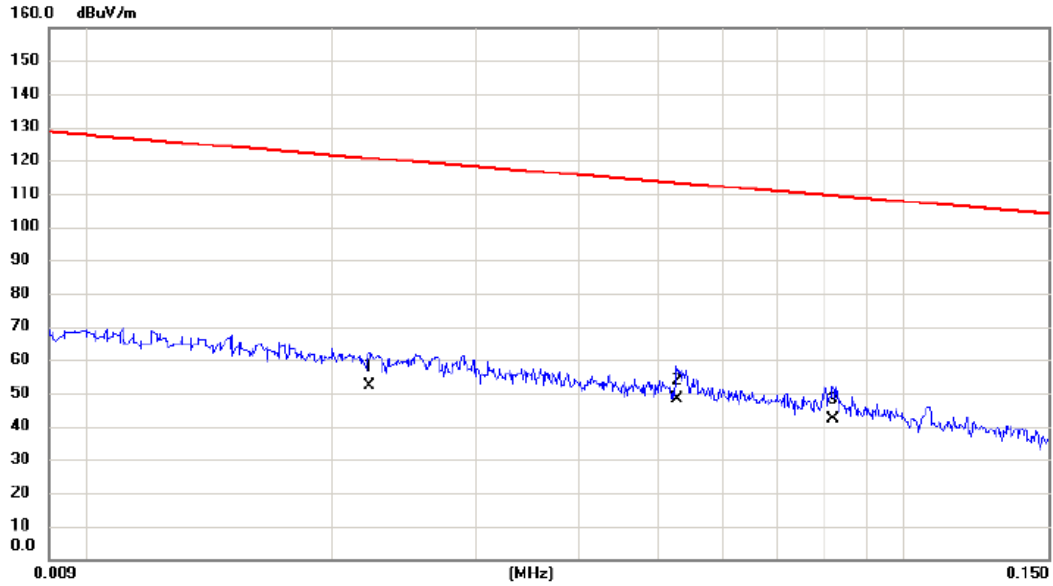

No.	Mk.	Freq. MHz	Reading Level dBuV	Correct Factor dB	Measure- ment dBuV/m	Limit dBuV/m	Margin dB	Detector	Comment
1		0.0222	32.30	19.98	52.28	120.68	-68.40	AVG	
2	*	0.0527	28.80	19.47	48.27	113.17	-64.90	AVG	
3		0.0817	23.20	18.87	42.07	109.36	-67.29	AVG	

Test Mode: TX MODE

Ant 90°

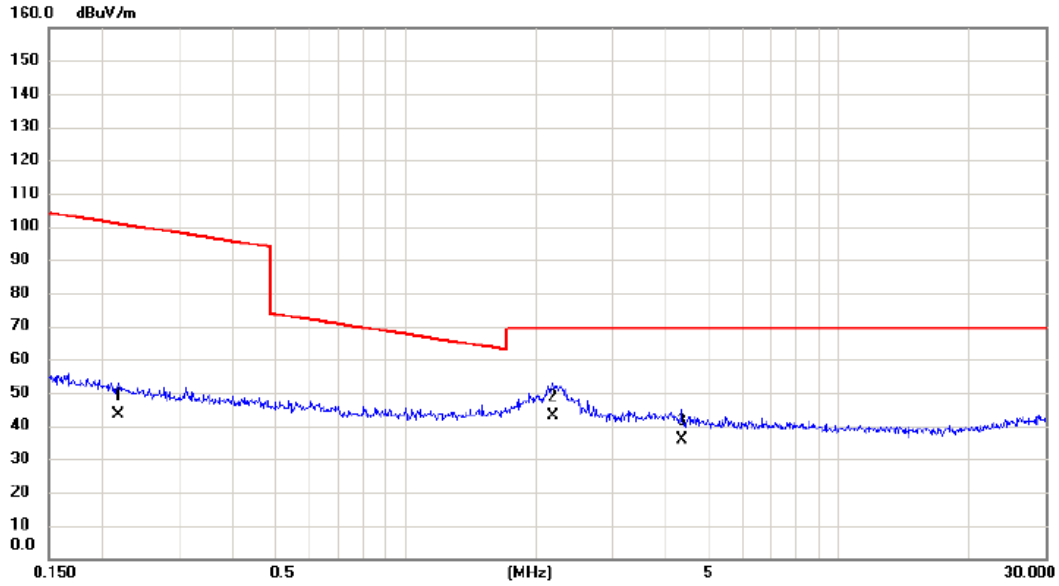

No.	Mk.	Freq. MHz	Reading Level dBuV	Correct Factor dB	Measure- ment dBuV/m	Limit dBuV/m	Margin dB	Detector	Comment
1		0.2174	26.10	17.12	43.22	100.86	-57.64	AVG	
2	*	2.1898	25.90	17.00	42.90	69.54	-26.64	QP	
3		4.3376	20.20	15.56	35.76	69.54	-33.78	QP	

APPENDIX C - RADIATED EMISSION (30MHZ TO 1000MHZ)

Test Mode: UNII-1/TX A Mode 5180MHz

Vertical

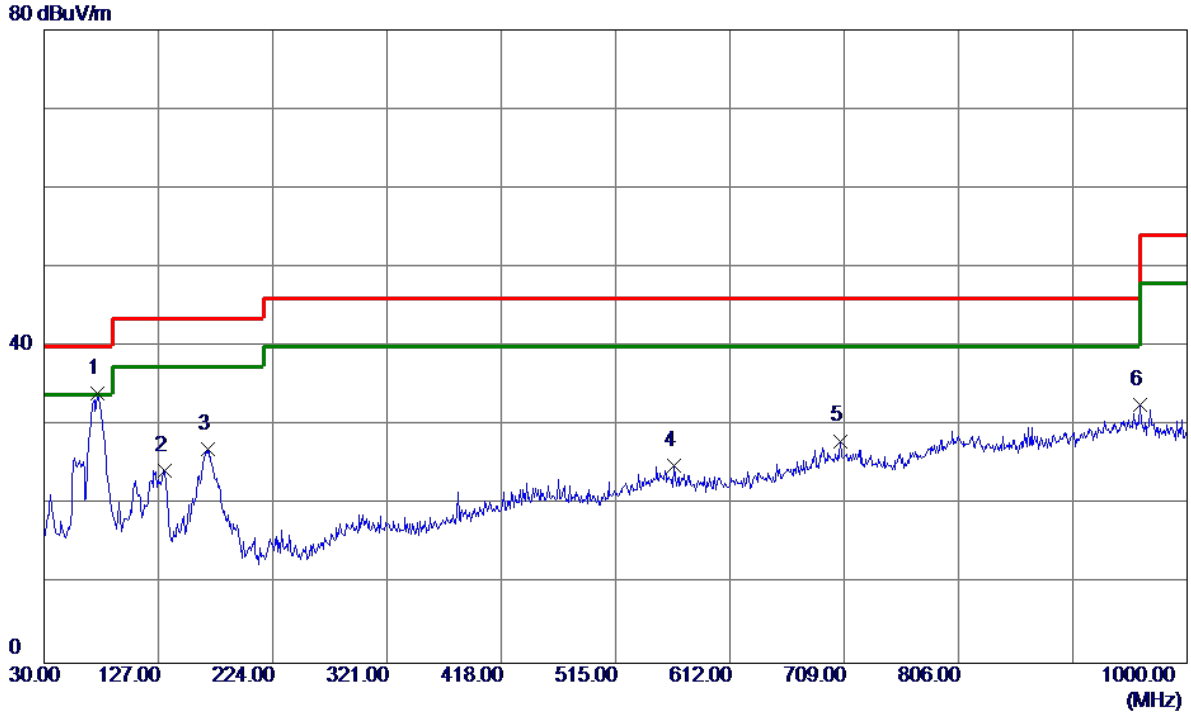

No.	Freq. MHz	Reading Level dBuV/m	Correct Factor dB	Measure ment dBuV/m	Limit dBuV/m	Margin dB	Detector	Comment
1 *	75.5899	52.53	-18.44	34.09	40.00	-5.91	Peak	
2	132.8200	37.41	-13.02	24.39	43.50	-19.11	Peak	
3	168.7100	38.10	-11.12	26.98	43.50	-16.52	Peak	
4	564.4699	30.63	-5.71	24.92	46.00	-21.08	Peak	
5	706.0900	30.98	-2.90	28.08	46.00	-17.92	Peak	
6	960.2300	31.54	1.17	32.71	54.00	-21.29	Peak	

Test Mode: UNII-1/TX A Mode 5180MHz

Horizontal

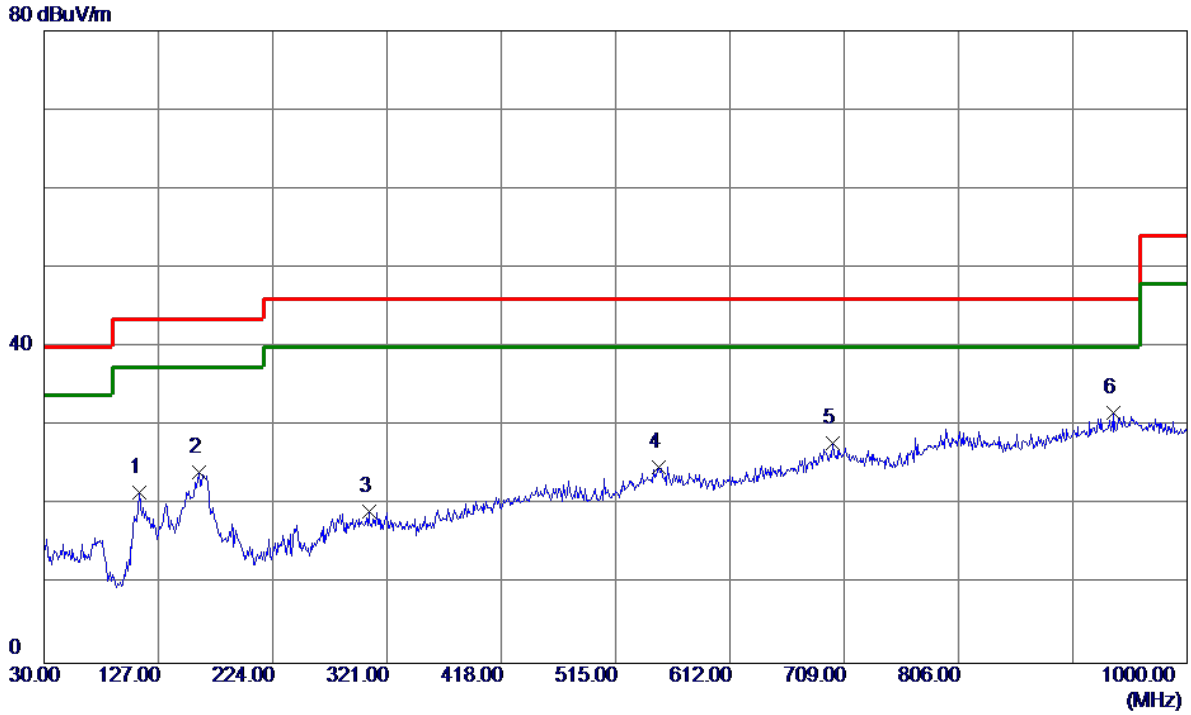

No.	Freq. MHz	Reading Level dBuV/m	Correct Factor dB	Measure ment dBuV/m	Limit dBuV/m	Margin dB	Detector	Comment
1	110.5100	37.75	-16.20	21.55	43.50	-21.95	Peak	
2	161.9200	34.91	-10.71	24.20	43.50	-19.30	Peak	
3	305.4800	29.64	-10.45	19.19	46.00	-26.81	Peak	
4	551.8600	30.29	-5.49	24.80	46.00	-21.20	Peak	
5	699.3000	30.69	-2.78	27.91	46.00	-18.09	Peak	
6 *	937.9200	30.79	0.92	31.71	46.00	-14.29	Peak	

Test Mode: UNII-1/TX A Mode 5200MHz

Vertical

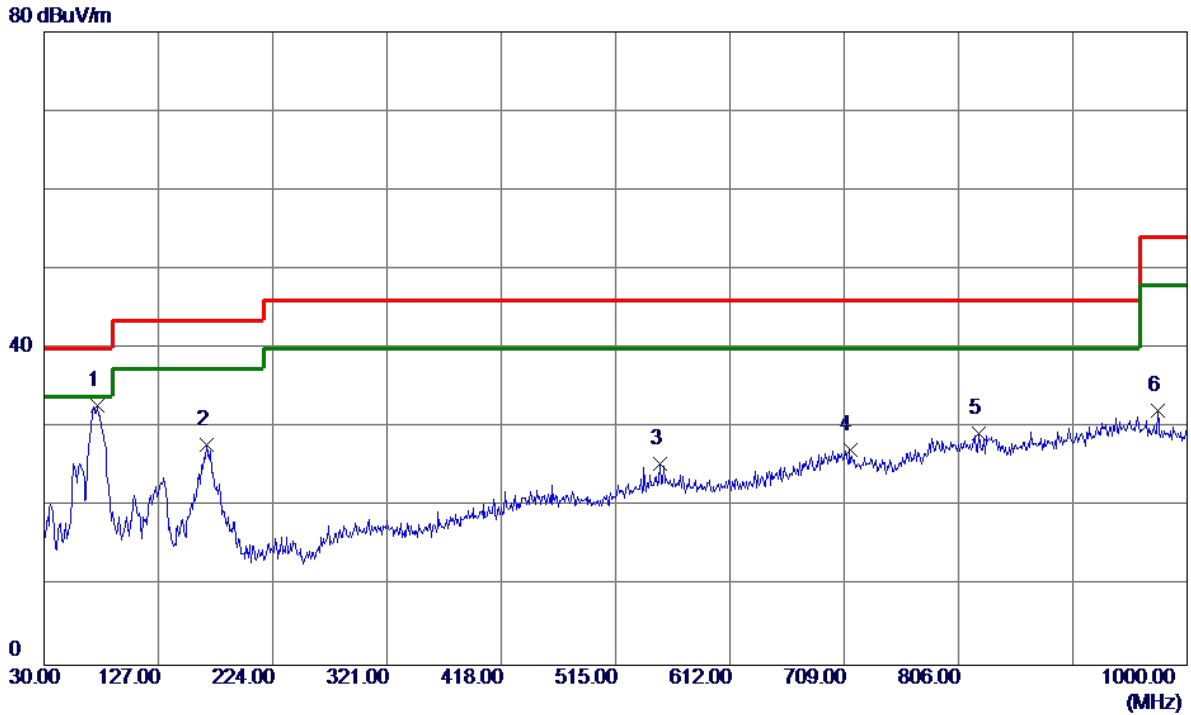

No.	Freq. MHz	Reading Level dBuV/m	Correct Factor dB	Measure ment dBuV/m	Limit dBuV/m	Margin dB	Detector	Comment
1 *	75.5899	51.24	-18.44	32.80	40.00	-7.20	Peak	
2	167.7400	38.93	-11.06	27.87	43.50	-15.63	Peak	
3	552.8300	30.99	-5.51	25.48	46.00	-20.52	Peak	
4	713.8500	30.27	-3.10	27.17	46.00	-18.83	Peak	
5	823.4600	30.68	-1.41	29.27	46.00	-16.73	Peak	
6	974.7800	31.36	0.82	32.18	54.00	-21.82	Peak	

Test Mode: UNII-1/TX A Mode 5200MHz

Horizontal

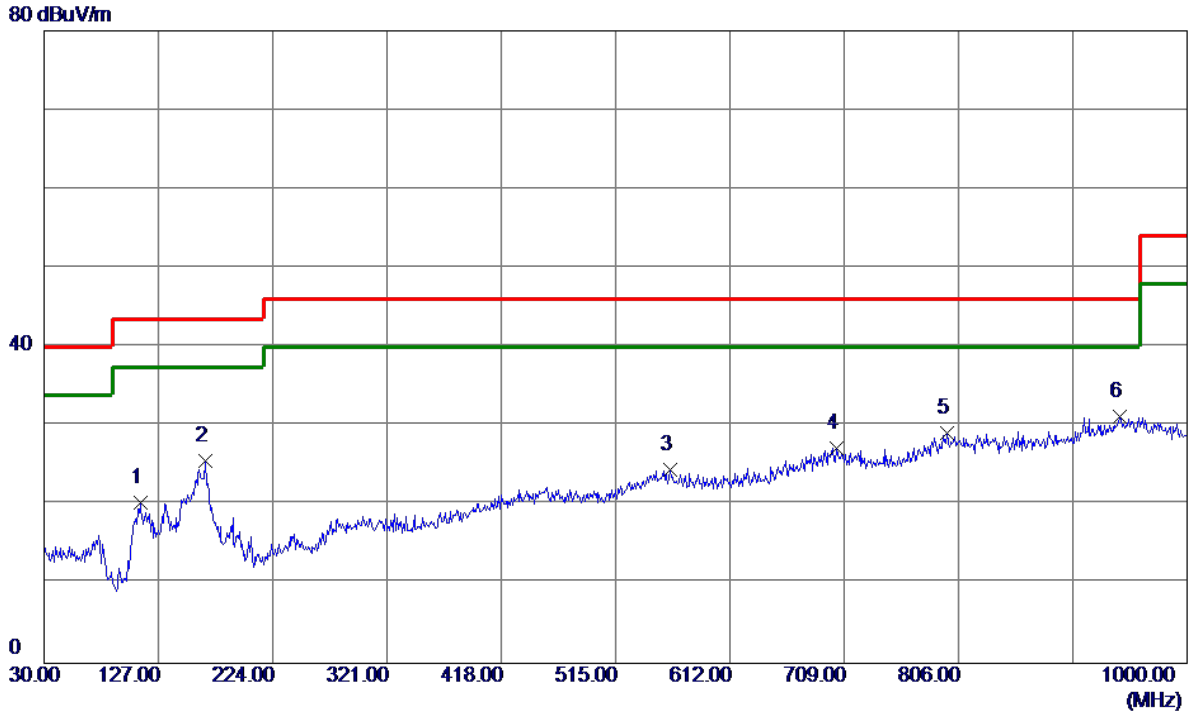

No.	Freq. MHz	Reading Level dBuV/m	Correct Factor dB	Measure ment dBuV/m	Limit dBuV/m	Margin dB	Detector	Comment
1	111.4800	36.31	-16.05	20.26	43.50	-23.24	Peak	
2	166.7700	36.67	-11.01	25.66	43.50	-17.84	Peak	
3	561.5600	30.16	-5.66	24.50	46.00	-21.50	Peak	
4	702.2100	29.99	-2.80	27.19	46.00	-18.81	Peak	
5	796.3000	30.44	-1.26	29.18	46.00	-16.82	Peak	
6 *	942.7700	30.03	1.12	31.15	46.00	-14.85	Peak	

Test Mode: UNII-1/TX A Mode 5240MHz

Vertical

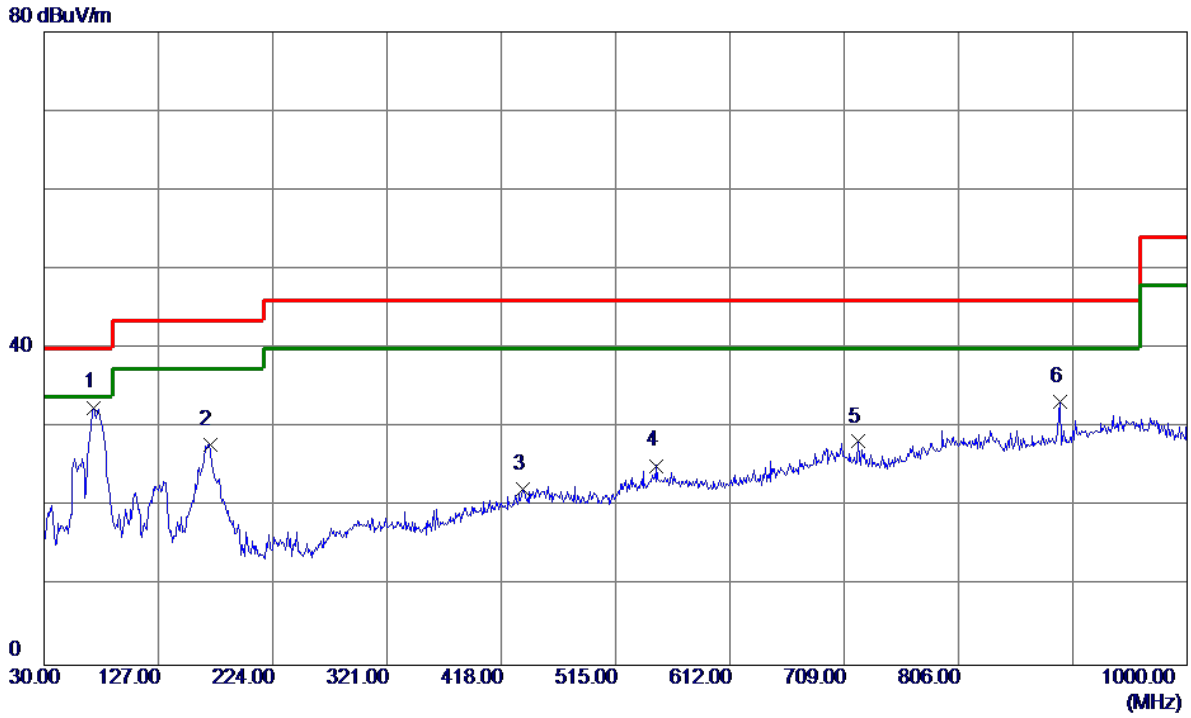

No.	Freq. MHz	Reading Level dBuV/m	Correct Factor dB	Measure ment dBuV/m	Limit dBuV/m	Margin dB	Detector	Comment
1 *	71.7100	50.29	-17.73	32.56	40.00	-7.44	Peak	
2	170.6500	39.19	-11.31	27.88	43.50	-15.62	Peak	
3	436.4300	30.14	-7.94	22.20	46.00	-23.80	Peak	
4	549.9200	30.67	-5.47	25.20	46.00	-20.80	Peak	
5	720.6400	31.52	-3.28	28.24	46.00	-17.76	Peak	
6	892.3300	34.11	-0.79	33.32	46.00	-12.68	Peak	

Test Mode: UNII-1/TX A Mode 5240MHz

Horizontal

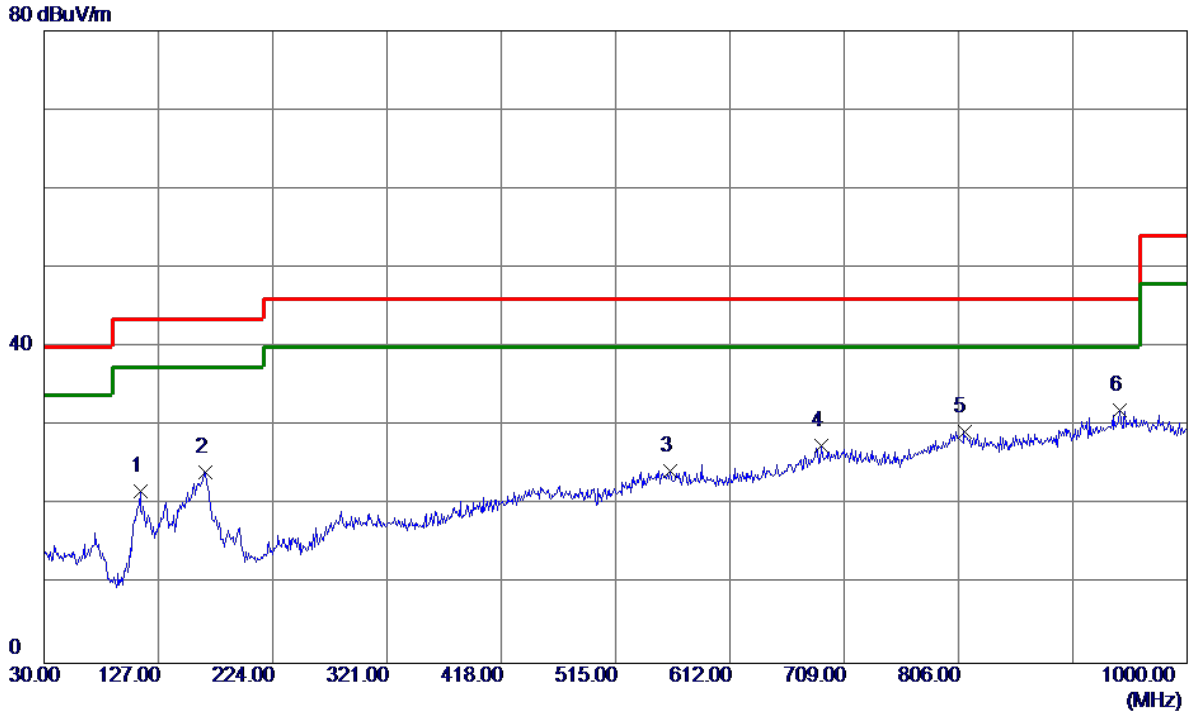

No.	Freq. MHz	Reading Level dBuV/m	Correct Factor dB	Measure ment dBuV/m	Limit dBuV/m	Margin dB	Detector	Comment
1	111.4800	37.80	-16.05	21.75	43.50	-21.75	Peak	
2	166.7700	35.13	-11.01	24.12	43.50	-19.38	Peak	
3	561.5600	29.96	-5.66	24.30	46.00	-21.70	Peak	
4	689.6000	30.70	-3.25	27.45	46.00	-18.55	Peak	
5	810.8500	30.51	-1.21	29.30	46.00	-16.70	Peak	
6 *	942.7700	30.93	1.12	32.05	46.00	-13.95	Peak	

Test Mode: UNII-2A/TX A Mode 5260MHz

Vertical

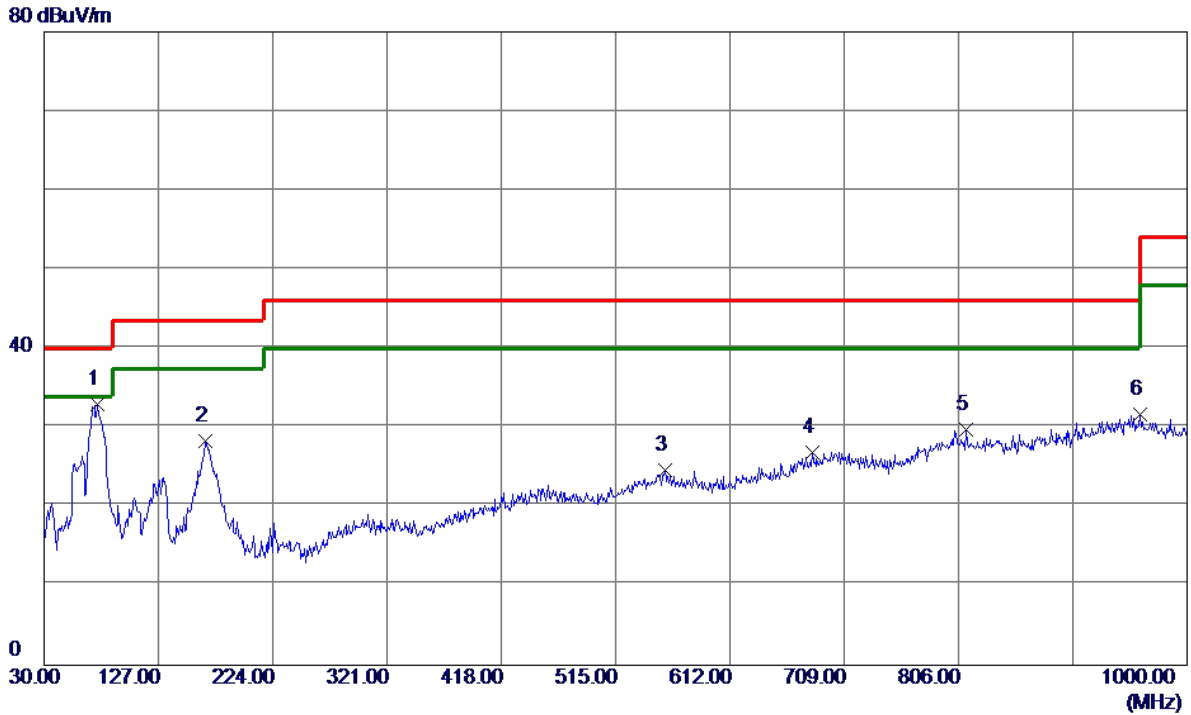

No.	Freq. MHz	Reading Level dBuV/m	Correct Factor dB	Measure ment dBuV/m	Limit dBuV/m	Margin dB	Detector	Comment
1 *	75.5899	51.45	-18.44	33.01	40.00	-6.99	Peak	
2	166.7700	39.32	-11.01	28.31	43.50	-15.19	Peak	
3	556.7100	30.29	-5.58	24.71	46.00	-21.29	Peak	
4	681.8400	30.56	-3.63	26.93	46.00	-19.07	Peak	
5	812.7900	31.00	-1.24	29.76	46.00	-16.24	Peak	
6	960.2300	30.46	1.17	31.63	54.00	-22.37	Peak	

Test Mode: UNII-2A/TX A Mode 5260MHz

Horizontal

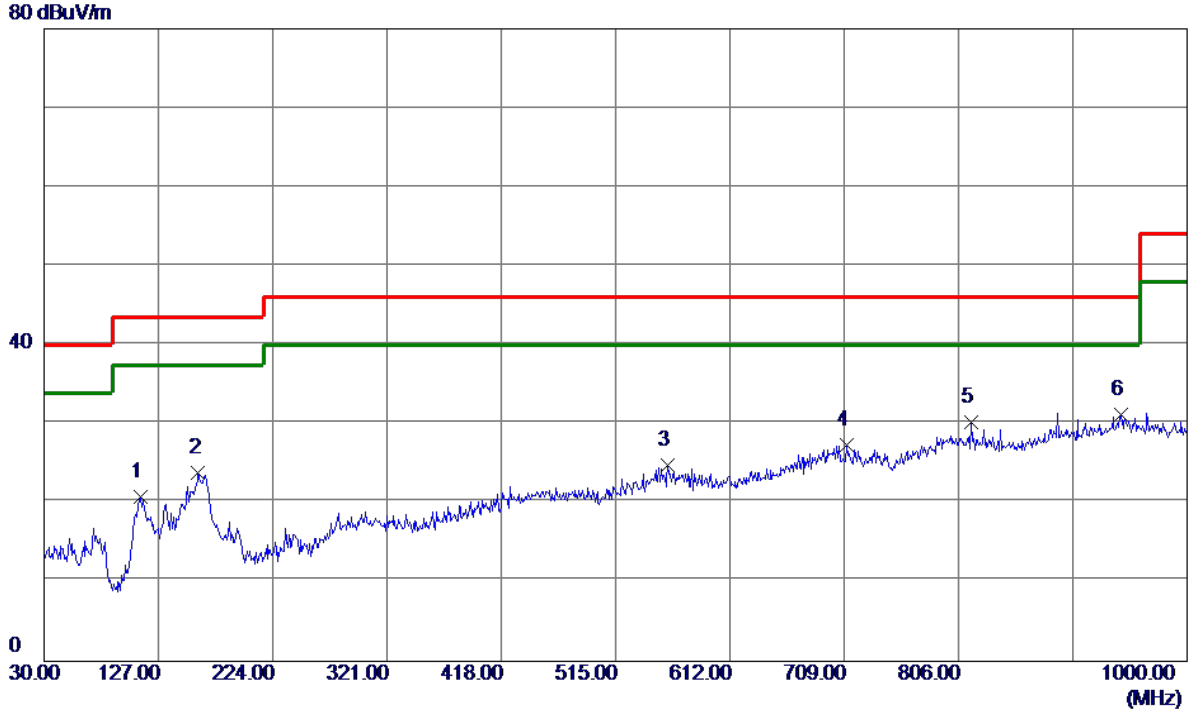

No.	Freq. MHz	Reading Level dBuV/m	Correct Factor dB	Measure ment dBuV/m	Limit dBuV/m	Margin dB	Detector	Comment
1	111.4800	36.90	-16.05	20.85	43.50	-22.65	Peak	
2	160.9500	34.44	-10.66	23.78	43.50	-19.72	Peak	
3	559.6200	30.35	-5.62	24.73	46.00	-21.27	Peak	
4	710.9400	30.37	-3.03	27.34	46.00	-18.66	Peak	
5	816.6700	31.47	-1.30	30.17	46.00	-15.83	Peak	
6 *	943.7400	30.05	1.16	31.21	46.00	-14.79	Peak	

Test Mode: UNII-2A/TX A Mode 5300MHz

Vertical

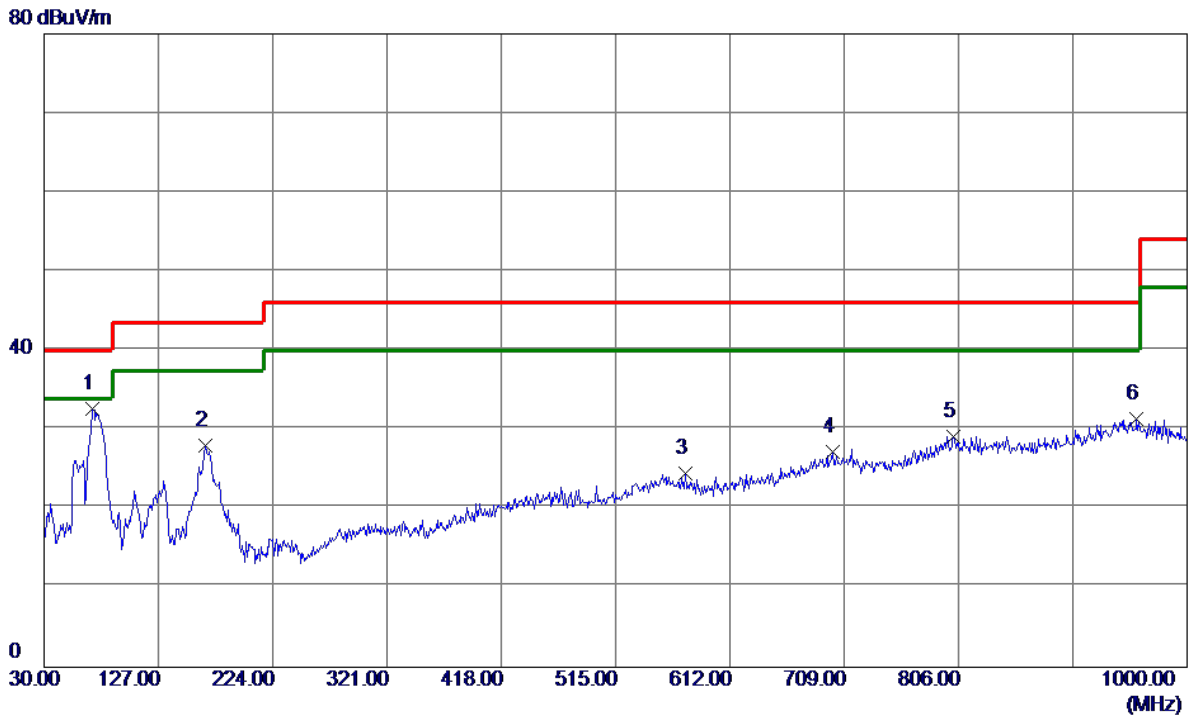

No.	Freq. MHz	Reading Level dBuV/m	Correct Factor dB	Measure ment dBuV/m	Limit dBuV/m	Margin dB	Detector	Comment
1 *	70.7400	50.10	-17.52	32.58	40.00	-7.42	Peak	
2	166.7700	39.04	-11.01	28.03	43.50	-15.47	Peak	
3	574.1700	30.40	-5.87	24.53	46.00	-21.47	Peak	
4	699.3000	29.92	-2.78	27.14	46.00	-18.86	Peak	
5	802.1200	30.26	-1.07	29.19	46.00	-16.81	Peak	
6	957.3200	30.05	1.24	31.29	46.00	-14.71	Peak	

Test Mode: UNII-2A/TX A Mode 5300MHz

Horizontal

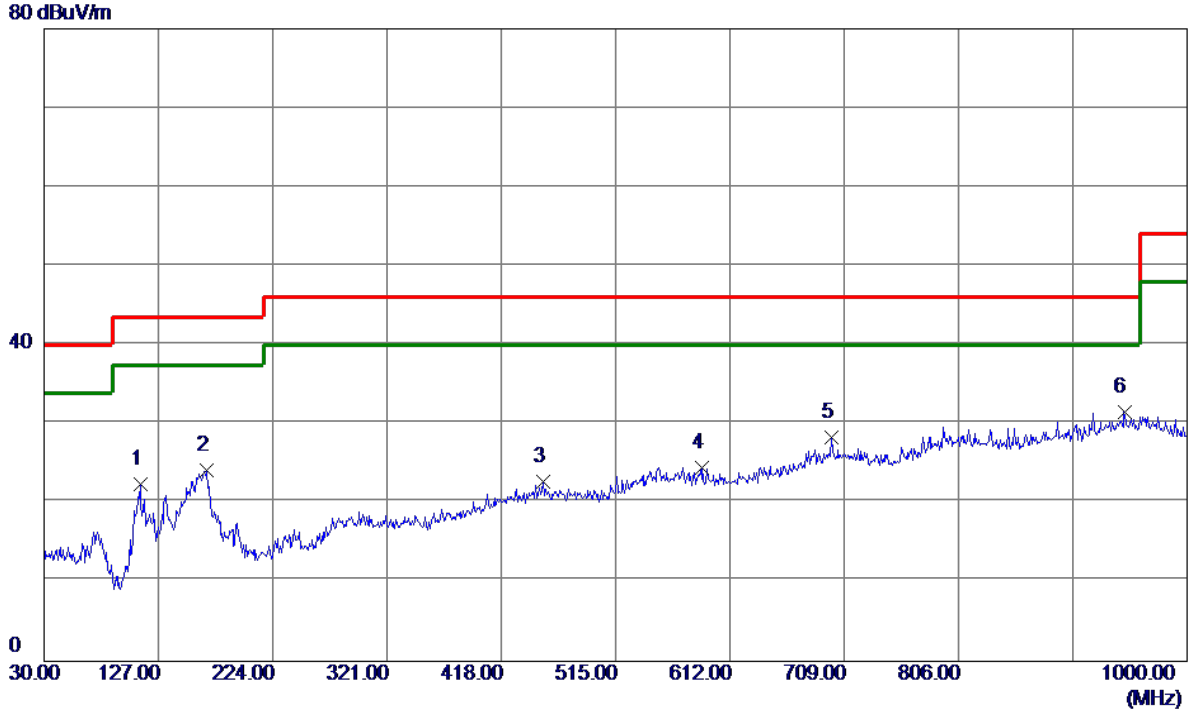

No.	Freq. MHz	Reading Level dBuV/m	Correct Factor dB	Measure ment dBuV/m	Limit dBuV/m	Margin dB	Detector	Comment
1	111.4800	38.46	-16.05	22.41	43.50	-21.09	Peak	
2	167.7400	35.17	-11.06	24.11	43.50	-19.39	Peak	
3	453.8900	30.17	-7.49	22.68	46.00	-23.32	Peak	
4	588.7199	30.64	-6.11	24.53	46.00	-21.47	Peak	
5	698.3300	31.14	-2.83	28.31	46.00	-17.69	Peak	
6 *	946.6500	30.28	1.28	31.56	46.00	-14.44	Peak	

Test Mode: UNII-2A/TX A Mode 5320MHz

Vertical

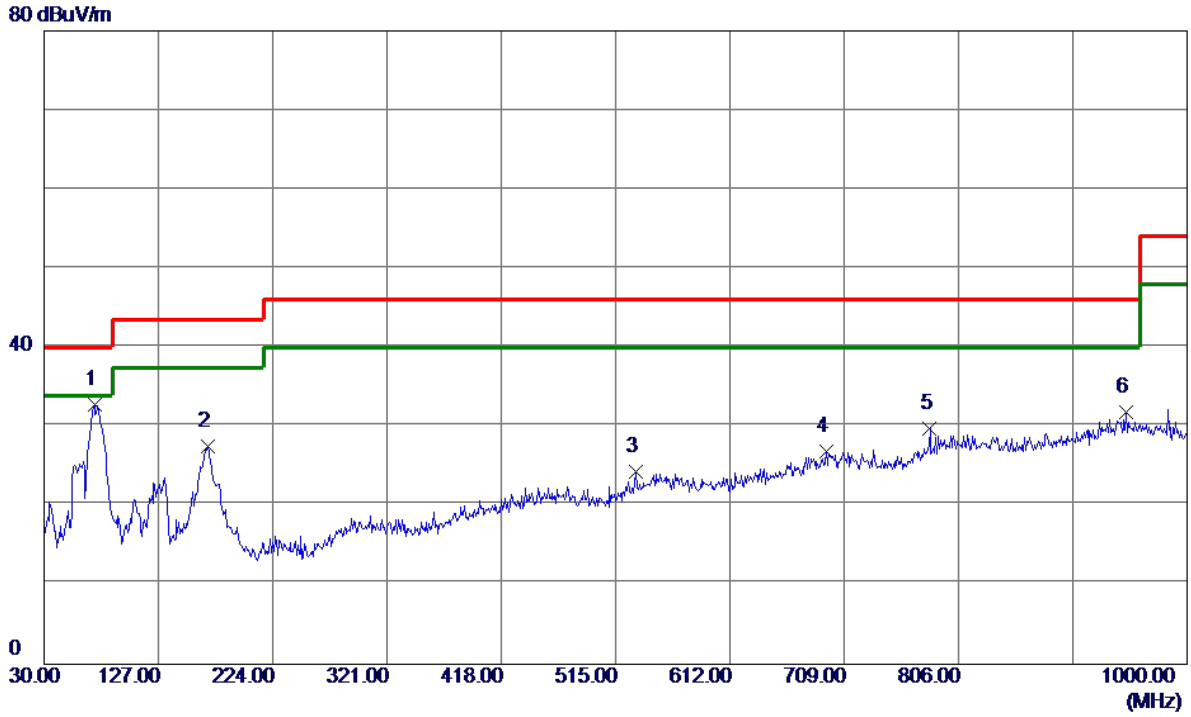

No.	Freq. MHz	Reading Level dBuV/m	Correct Factor dB	Measure ment dBuV/m	Limit dBuV/m	Margin dB	Detector	Comment
1 *	72.6800	50.70	-17.93	32.77	40.00	-7.23	Peak	
2	168.7100	38.59	-11.12	27.47	43.50	-16.03	Peak	
3	532.4600	30.87	-6.54	24.33	46.00	-21.67	Peak	
4	693.4800	29.99	-3.06	26.93	46.00	-19.07	Peak	
5	781.7500	31.91	-2.14	29.77	46.00	-16.23	Peak	
6	948.5900	30.56	1.35	31.91	46.00	-14.09	Peak	

Test Mode: UNII-2A/TX A Mode 5320MHz

Horizontal

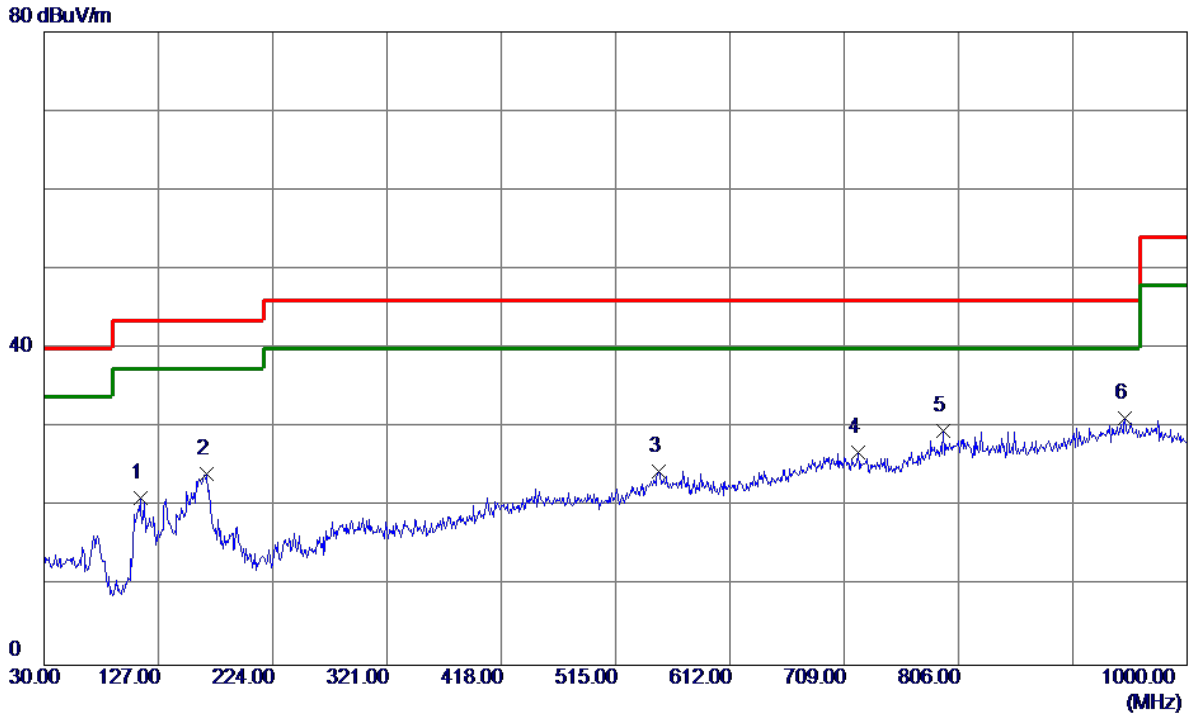

No.	Freq. MHz	Reading Level dBuV/m	Correct Factor dB	Measure ment dBuV/m	Limit dBuV/m	Margin dB	Detector	Comment
1	111.4800	37.19	-16.05	21.14	43.50	-22.36	Peak	
2	167.7400	35.17	-11.06	24.11	43.50	-19.39	Peak	
3	551.8600	30.00	-5.49	24.51	46.00	-21.49	Peak	
4	720.6400	30.09	-3.28	26.81	46.00	-19.19	Peak	
5	793.3900	31.11	-1.44	29.67	46.00	-16.33	Peak	
6 *	947.6200	29.95	1.31	31.26	46.00	-14.74	Peak	

Test Mode: UNII-2C/TX A Mode 5500MHz

Vertical

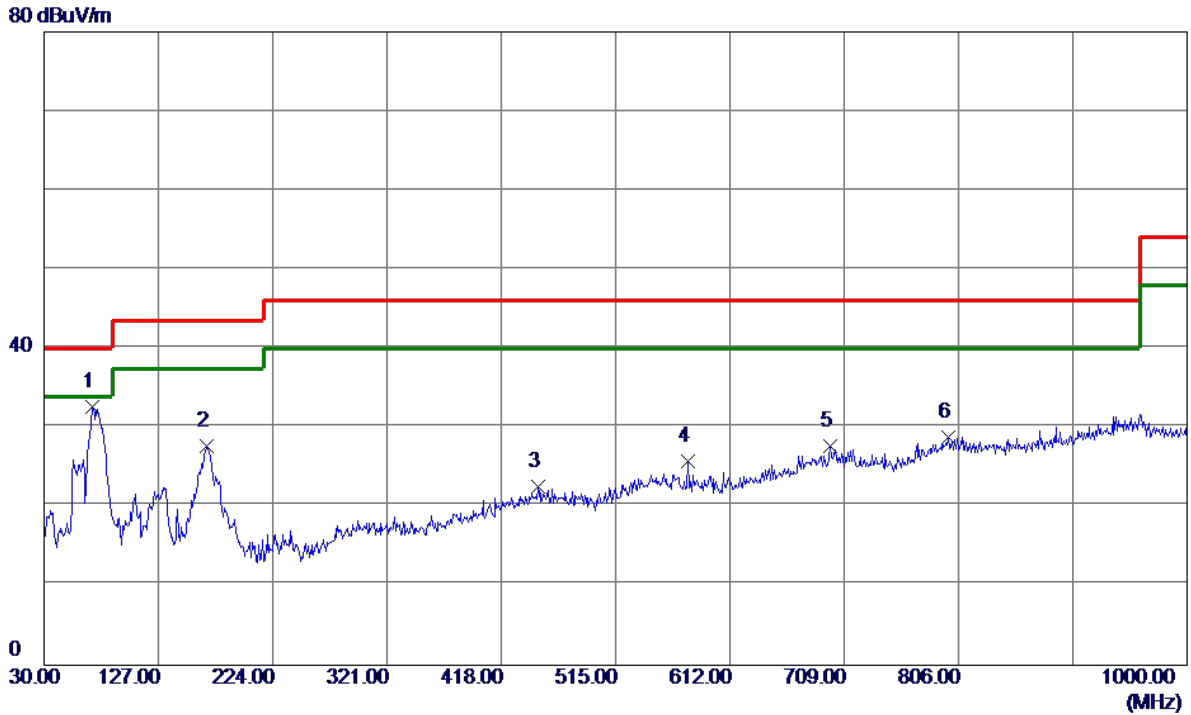

No.	Freq. MHz	Reading Level dBuV/m	Correct Factor dB	Measure ment dBuV/m	Limit dBuV/m	Margin dB	Detector	Comment
1 *	70.7400	50.22	-17.52	32.70	40.00	-7.30	Peak	
2	167.7400	38.71	-11.06	27.65	43.50	-15.85	Peak	
3	449.0400	30.06	-7.44	22.62	46.00	-23.38	Peak	
4	576.1100	31.65	-5.90	25.75	46.00	-20.25	Peak	
5	697.3600	30.51	-2.87	27.64	46.00	-18.36	Peak	
6	797.2700	30.03	-1.20	28.83	46.00	-17.17	Peak	

Test Mode: UNII-2C/TX A Mode 5500MHz

Horizontal

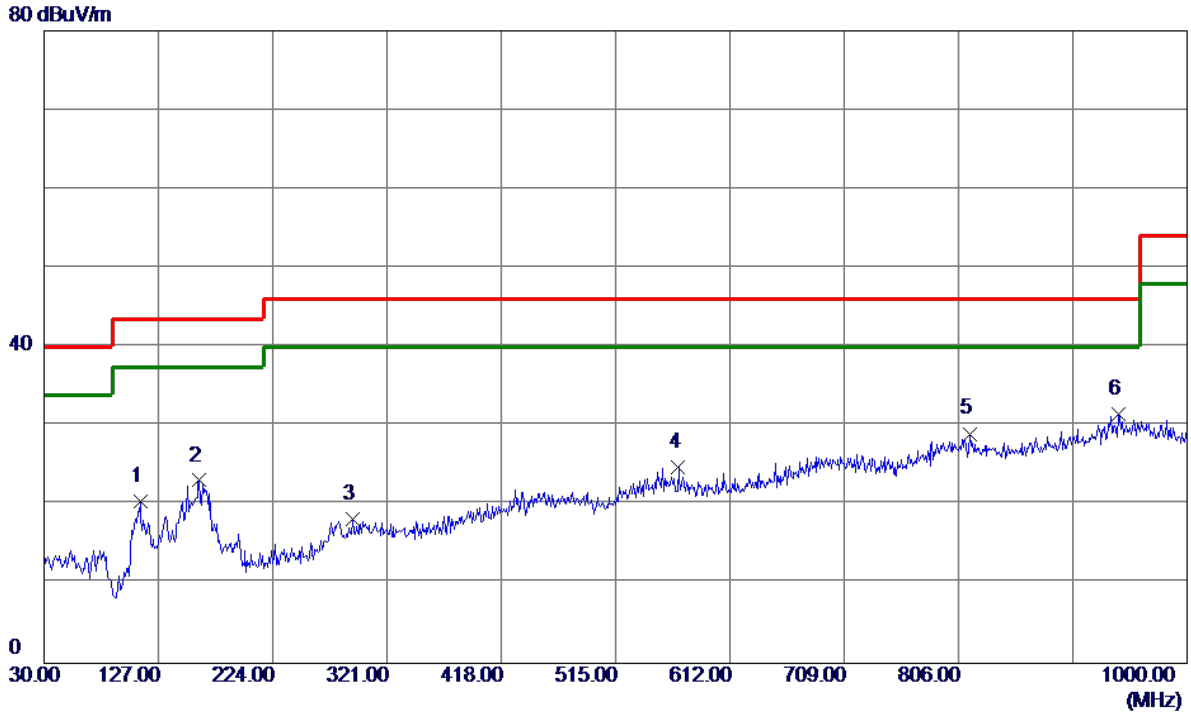

No.	Freq. MHz	Reading Level dBuV/m	Correct Factor dB	Measure ment dBuV/m	Limit dBuV/m	Margin dB	Detector	Comment
1	111.4800	36.51	-16.05	20.46	43.50	-23.04	Peak	
2	161.9200	33.83	-10.71	23.12	43.50	-20.38	Peak	
3	291.9000	29.07	-10.84	18.23	46.00	-27.77	Peak	
4	568.3500	30.51	-5.77	24.74	46.00	-21.26	Peak	
5	815.7000	30.33	-1.29	29.04	46.00	-16.96	Peak	
6 *	941.8000	30.39	1.08	31.47	46.00	-14.53	Peak	

Test Mode: UNII-2C/TX A Mode 5580MHz

Vertical

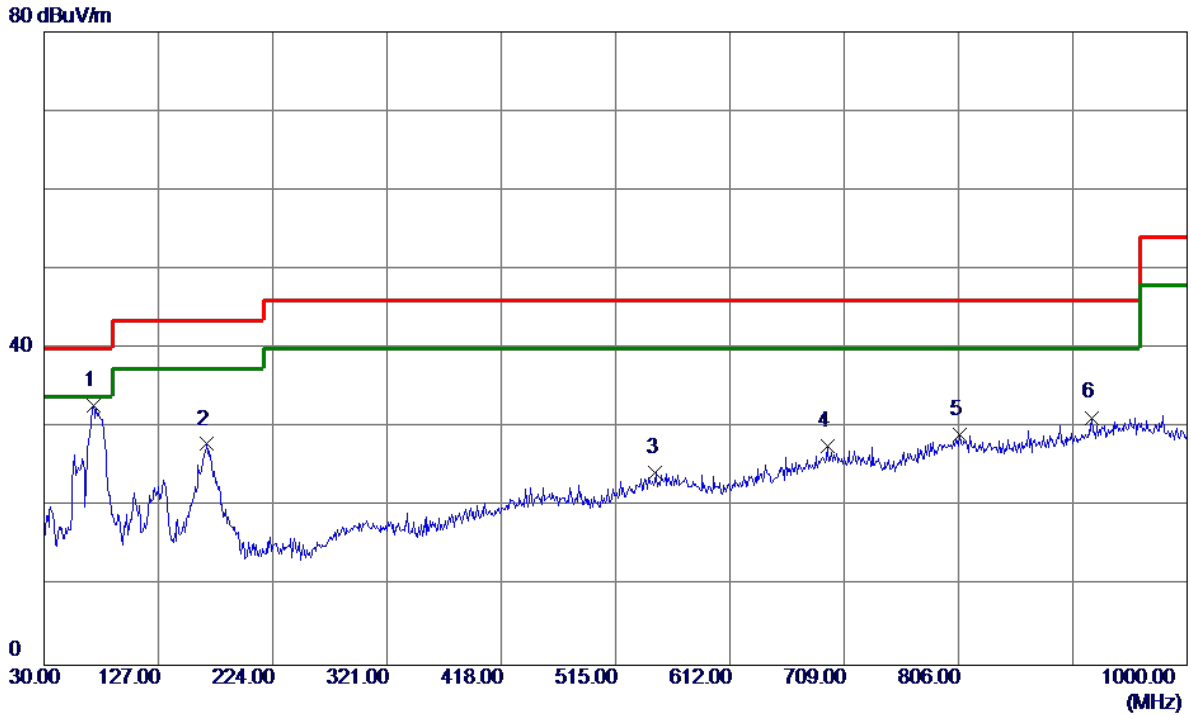

No.	Freq. MHz	Reading Level dBuV/m	Correct Factor dB	Measure ment dBuV/m	Limit dBuV/m	Margin dB	Detector	Comment
1 *	71.7100	50.53	-17.73	32.80	40.00	-7.20	Peak	
2	167.7400	38.98	-11.06	27.92	43.50	-15.58	Peak	
3	548.9500	29.90	-5.53	24.37	46.00	-21.63	Peak	
4	694.4500	30.63	-3.01	27.62	46.00	-18.38	Peak	
5	806.9699	30.29	-1.15	29.14	46.00	-16.86	Peak	
6	919.4900	31.10	0.18	31.28	46.00	-14.72	Peak	

Test Mode: UNII-2C/TX A Mode 5580MHz

Horizontal

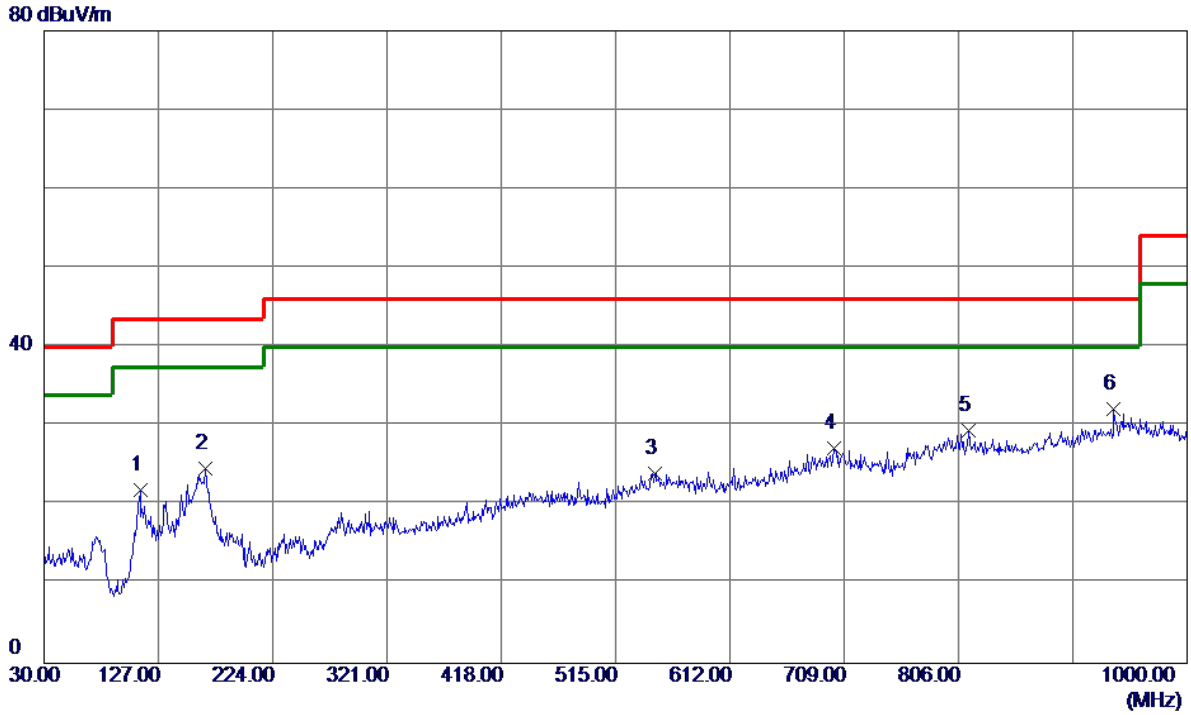

No.	Freq. MHz	Reading Level dBuV/m	Correct Factor dB	Measure ment dBuV/m	Limit dBuV/m	Margin dB	Detector	Comment
1	111.4800	38.04	-16.05	21.99	43.50	-21.51	Peak	
2	166.7700	35.64	-11.01	24.63	43.50	-18.87	Peak	
3	547.9800	29.65	-5.59	24.06	46.00	-21.94	Peak	
4	700.2700	29.88	-2.75	27.13	46.00	-18.87	Peak	
5	814.7300	30.73	-1.27	29.46	46.00	-16.54	Peak	
6 *	937.9200	31.17	0.92	32.09	46.00	-13.91	Peak	

Test Mode: UNII-2C/TX A Mode 5700MHz

Vertical

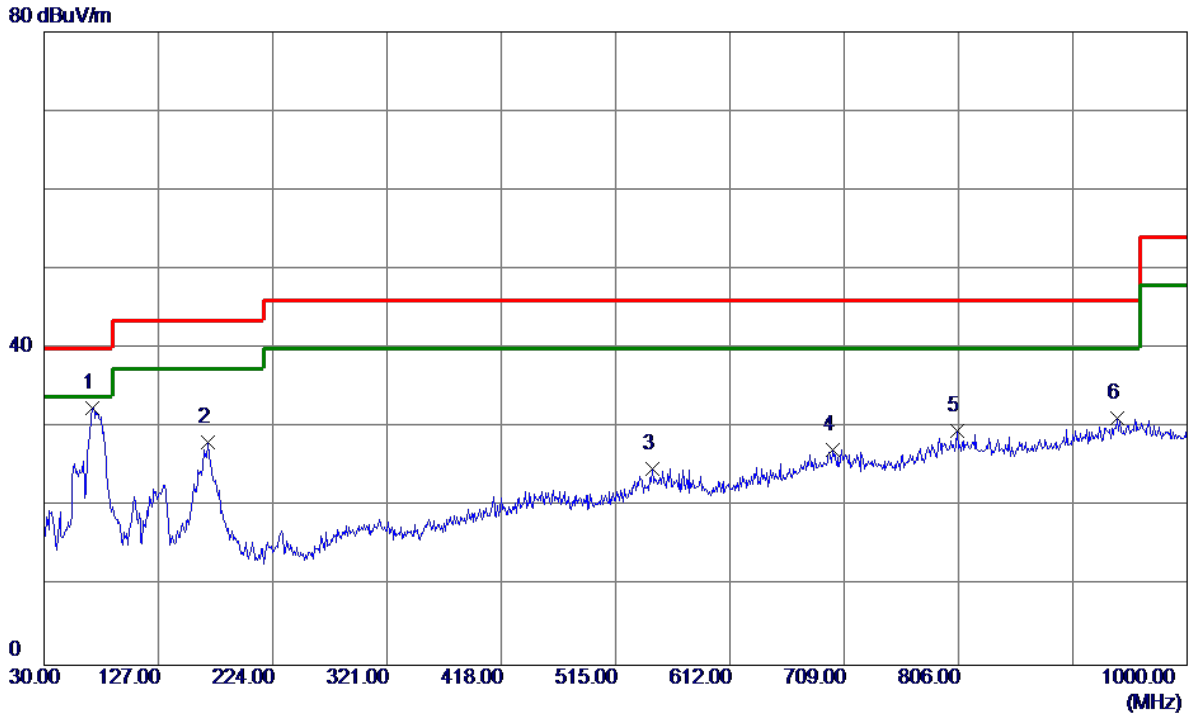

No.	Freq. MHz	Reading Level dBuV/m	Correct Factor dB	Measure ment dBuV/m	Limit dBuV/m	Margin dB	Detector	Comment
1 *	70.7400	50.06	-17.52	32.54	40.00	-7.46	Peak	
2	168.7100	39.25	-11.12	28.13	43.50	-15.37	Peak	
3	546.0400	30.46	-5.71	24.75	46.00	-21.25	Peak	
4	699.3000	30.05	-2.78	27.27	46.00	-18.73	Peak	
5	805.0300	30.75	-1.12	29.63	46.00	-16.37	Peak	
6	940.8300	30.13	1.04	31.17	46.00	-14.83	Peak	

Test Mode: UNII-2C/TX A Mode 5700MHz

Horizontal

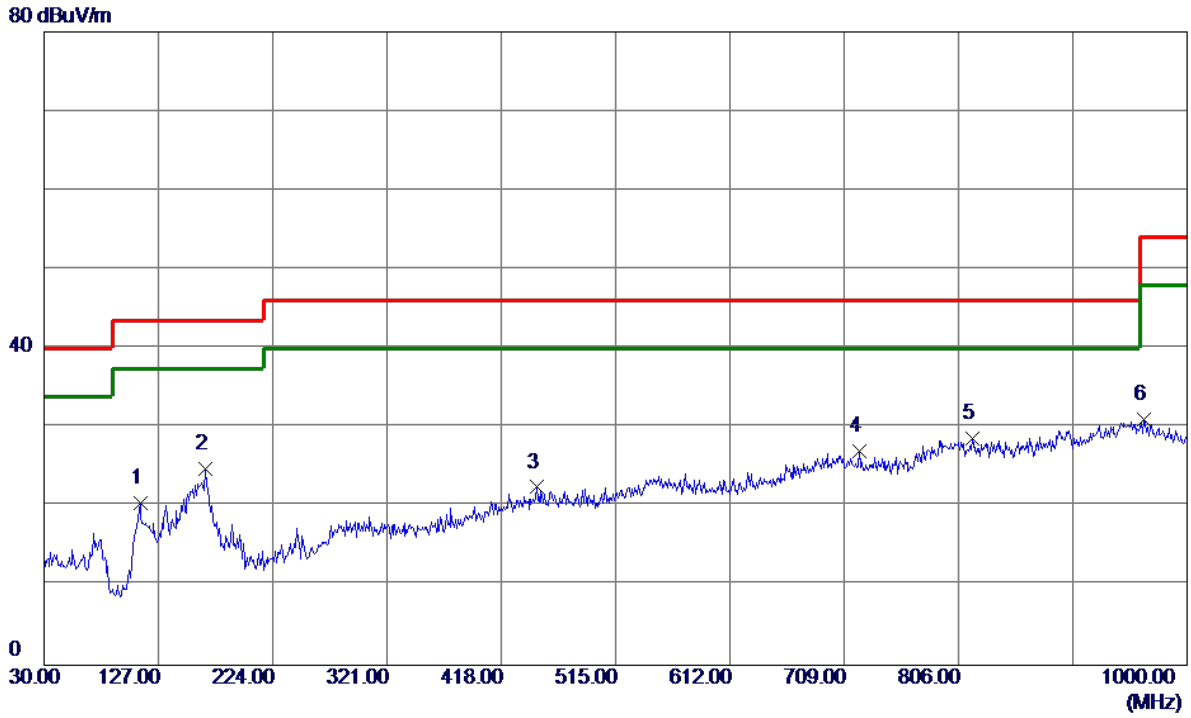

No.	Freq. MHz	Reading Level dBuV/m	Correct Factor dB	Measure ment dBuV/m	Limit dBuV/m	Margin dB	Detector	Comment
1	111.4800	36.54	-16.05	20.49	43.50	-23.01	Peak	
2	166.7700	35.82	-11.01	24.81	43.50	-18.69	Peak	
3	448.0700	29.96	-7.48	22.48	46.00	-23.52	Peak	
4	721.6100	30.42	-3.31	27.11	46.00	-18.89	Peak	
5 *	817.6400	29.98	-1.32	28.66	46.00	-17.34	Peak	
6	963.1400	29.98	1.10	31.08	54.00	-22.92	Peak	

Test Mode: UNII-3/TX A Mode 5745MHz

Vertical

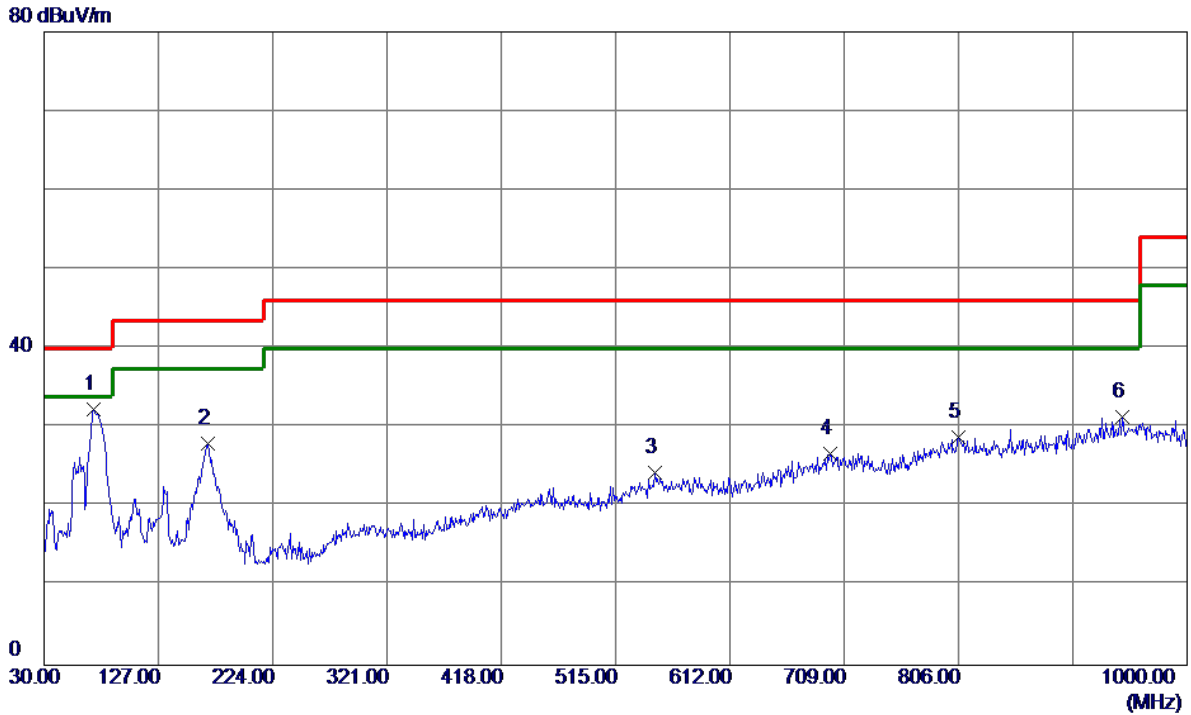

No.	Freq. MHz	Reading Level dBuV/m	Correct Factor dB	Measure ment dBuV/m	Limit dBuV/m	Margin dB	Detector	Comment
1 *	71.7100	50.07	-17.73	32.34	40.00	-7.66	Peak	
2	168.7100	39.07	-11.12	27.95	43.50	-15.55	Peak	
3	547.9800	29.92	-5.59	24.33	46.00	-21.67	Peak	
4	697.3600	29.54	-2.87	26.67	46.00	-19.33	Peak	
5	806.0000	29.93	-1.13	28.80	46.00	-17.20	Peak	
6	944.7100	30.20	1.20	31.40	46.00	-14.60	Peak	

Test Mode: UNII-3/TX A Mode 5745MHz

Horizontal

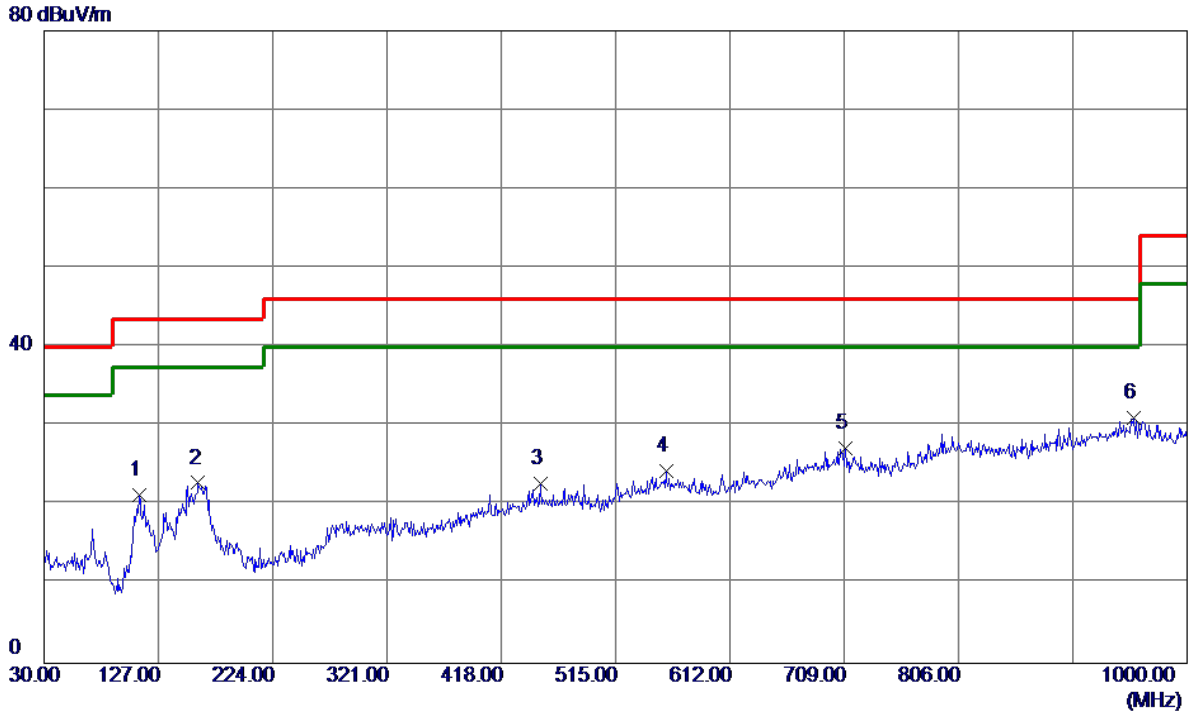

No.	Freq. MHz	Reading Level dBuV/m	Correct Factor dB	Measure ment dBuV/m	Limit dBuV/m	Margin dB	Detector	Comment
1	110.5100	37.50	-16.20	21.30	43.50	-22.20	Peak	
2	160.9500	33.46	-10.66	22.80	43.50	-20.70	Peak	
3	450.9800	30.15	-7.43	22.72	46.00	-23.28	Peak	
4	557.6800	29.91	-5.59	24.32	46.00	-21.68	Peak	
5	709.9699	30.23	-3.00	27.23	46.00	-18.77	Peak	
6 *	954.4100	29.72	1.31	31.03	46.00	-14.97	Peak	

Test Mode: UNII-3/TX A Mode 5785MHz

Vertical

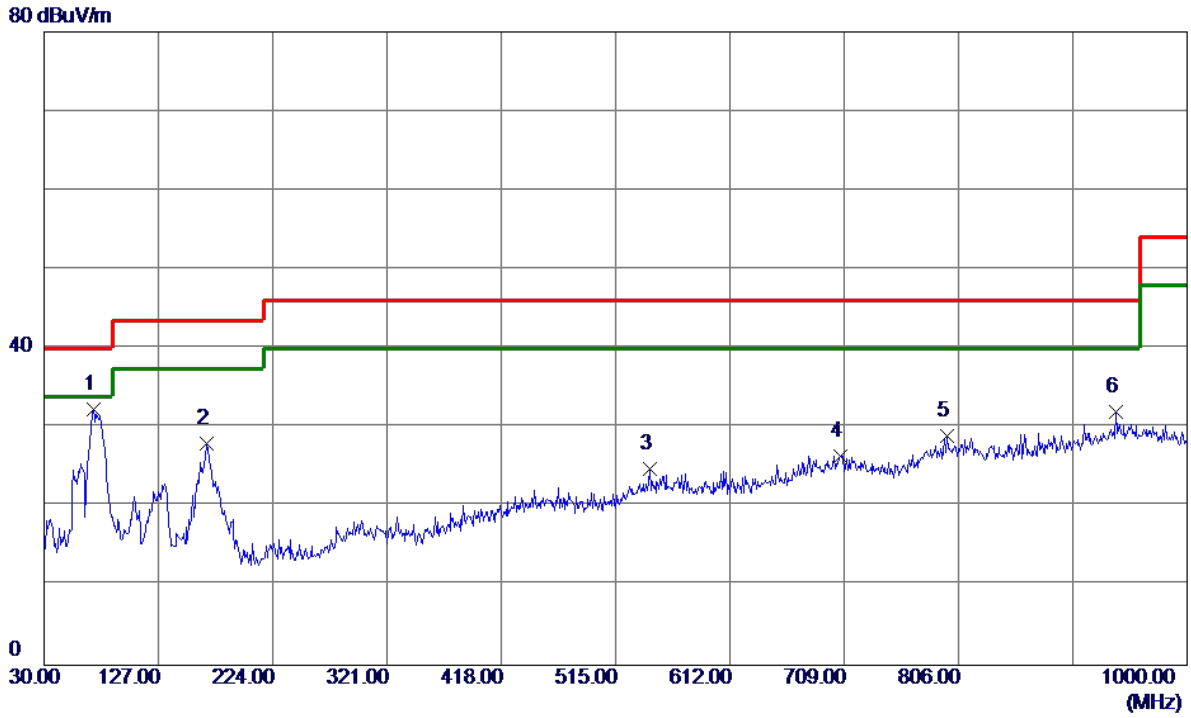

No.	Freq. MHz	Reading Level dBuV/m	Correct Factor dB	Measure ment dBuV/m	Limit dBuV/m	Margin dB	Detector	Comment
1 *	71.7100	50.07	-17.73	32.34	40.00	-7.66	Peak	
2	167.7400	39.03	-11.06	27.97	43.50	-15.53	Peak	
3	544.1000	30.56	-5.82	24.74	46.00	-21.26	Peak	
4	706.0900	29.37	-2.90	26.47	46.00	-19.53	Peak	
5	796.3000	30.15	-1.26	28.89	46.00	-17.11	Peak	
6	939.8600	31.01	1.00	32.01	46.00	-13.99	Peak	

Test Mode: UNII-3/TX A Mode 5785MHz

Horizontal

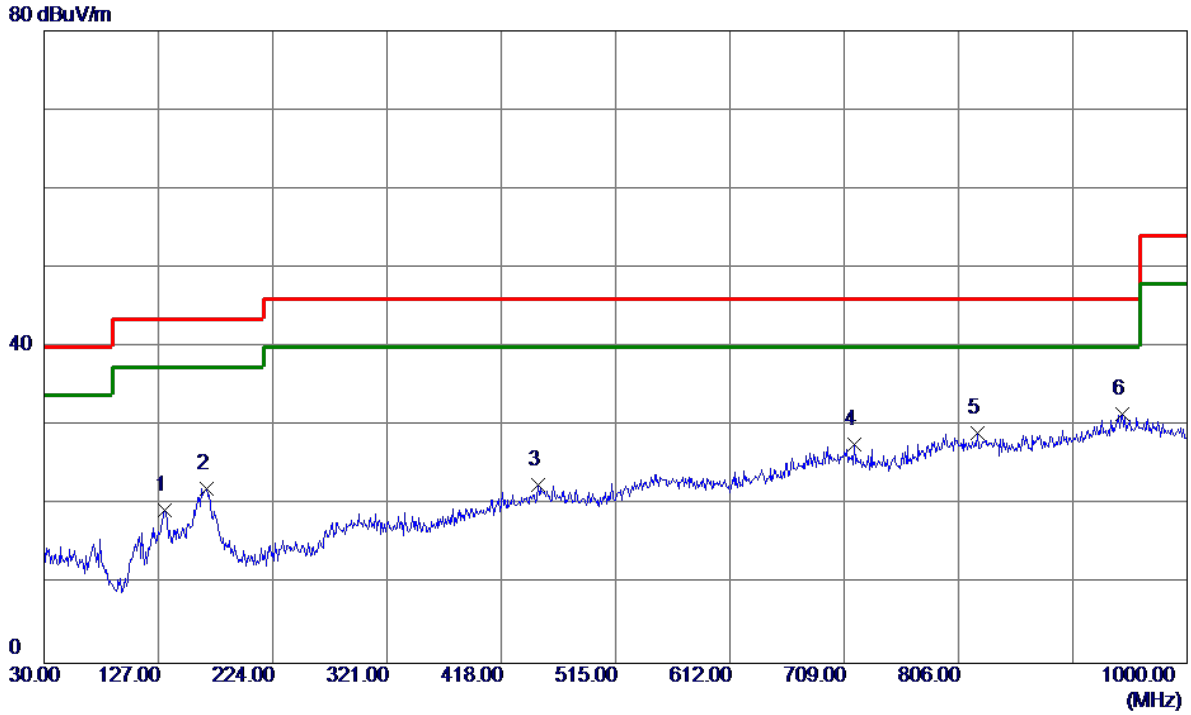

No.	Freq. MHz	Reading Level dBuV/m	Correct Factor dB	Measure ment dBuV/m	Limit dBuV/m	Margin dB	Detector	Comment
1	132.8200	32.45	-13.02	19.43	43.50	-24.07	Peak	
2	167.7400	33.10	-11.06	22.04	43.50	-21.46	Peak	
3	449.0400	30.00	-7.44	22.56	46.00	-23.44	Peak	
4	717.7300	30.83	-3.21	27.62	46.00	-18.38	Peak	
5	822.4900	30.58	-1.39	29.19	46.00	-16.81	Peak	
6 *	944.7100	30.30	1.20	31.50	46.00	-14.50	Peak	

Test Mode: UNII-3/TX A Mode 5825MHz

Vertical

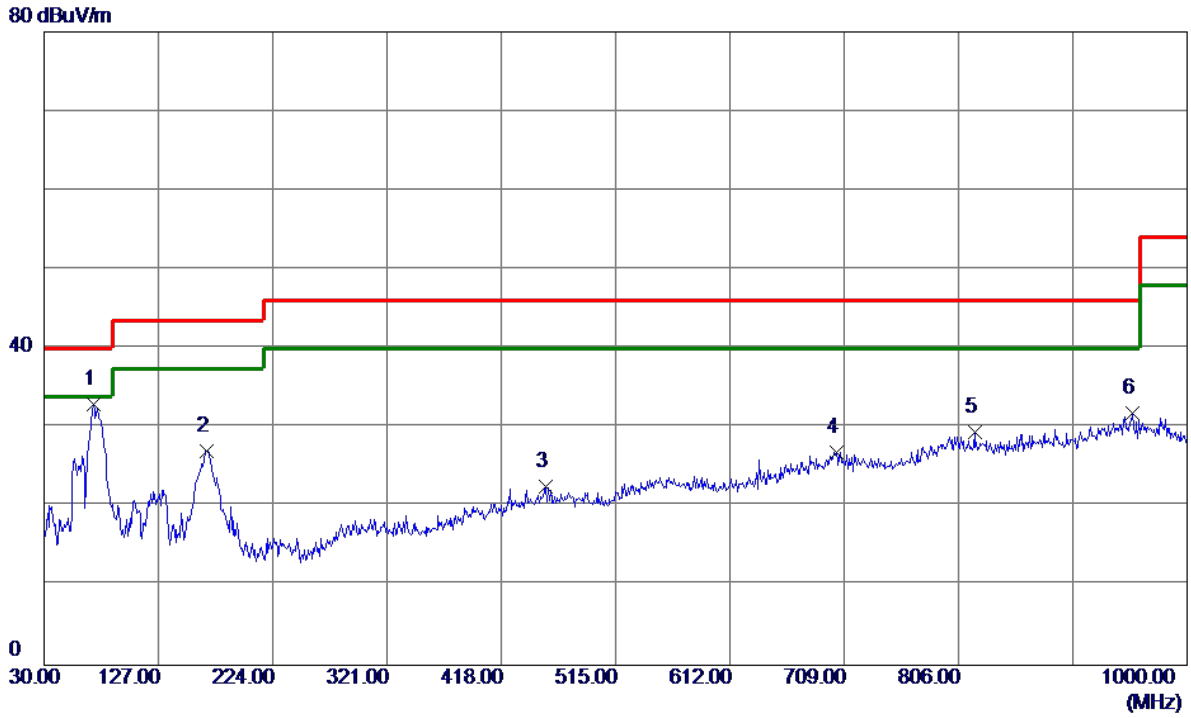

No.	Freq. MHz	Reading Level dBuV/m	Correct Factor dB	Measure ment dBuV/m	Limit dBuV/m	Margin dB	Detector	Comment
1 *	71.7100	50.62	-17.73	32.89	40.00	-7.11	Peak	
2	167.7400	38.17	-11.06	27.11	43.50	-16.39	Peak	
3	455.8300	30.17	-7.54	22.63	46.00	-23.37	Peak	
4	702.2100	29.68	-2.80	26.88	46.00	-19.12	Peak	
5	819.5800	30.78	-1.35	29.43	46.00	-16.57	Peak	
6	953.4400	30.47	1.33	31.80	46.00	-14.20	Peak	

Test Mode: UNII-3/TX A Mode 5825MHz

Horizontal

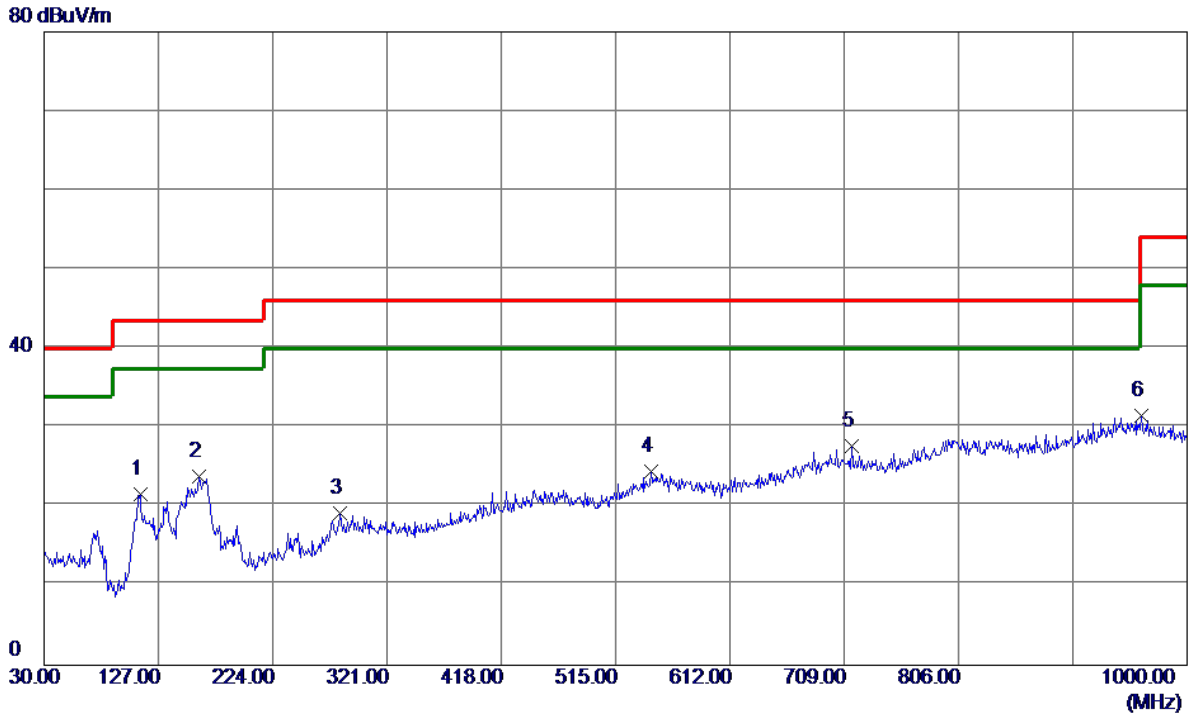

No.	Freq. MHz	Reading Level dBuV/m	Correct Factor dB	Measure ment dBuV/m	Limit dBuV/m	Margin dB	Detector	Comment
1	111.4800	37.65	-16.05	21.60	43.50	-21.90	Peak	
2	161.9200	34.60	-10.71	23.89	43.50	-19.61	Peak	
3	281.2300	30.54	-11.29	19.25	46.00	-26.75	Peak	
4	545.0700	30.18	-5.77	24.41	46.00	-21.59	Peak	
5 *	715.7900	30.78	-3.15	27.63	46.00	-18.37	Peak	
6	961.2000	30.38	1.14	31.52	54.00	-22.48	Peak	

APPENDIX D - RADIATED EMISSION (ABOVE 1000MHZ)

Orthogonal Axis:	X
Test Mode:	UNII-1/ TX A Mode 5180MHz

Vertical

130 dBuV/m

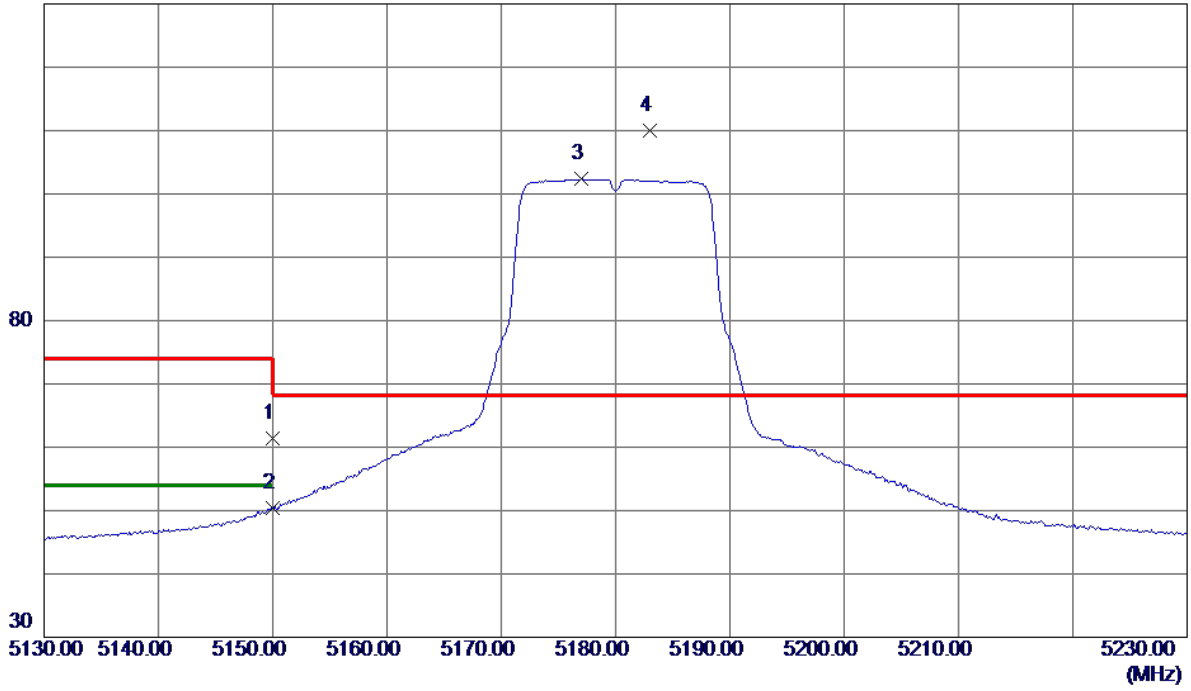

No.	Freq. MHz	Reading Level dBuV/m	Correct Factor dB	Measure ment dBuV/m	Limit dBuV/m	Margin dB	Detector	Comment
1	5150.0000	40.35	21.03	61.38	74.00	-12.62	Peak	
2	5150.0000	29.33	21.03	50.36	54.00	-3.64	AVG	
3	5177.0000	81.20	21.13	102.33	999.00	-896.67	AVG	No Limit
4 *	5183.0000	88.75	21.15	109.90	68.30	41.60	Peak	No Limit

Orthogonal Axis:	X
Test Mode:	UNII-1/ TX A Mode 5180MHz

Vertical

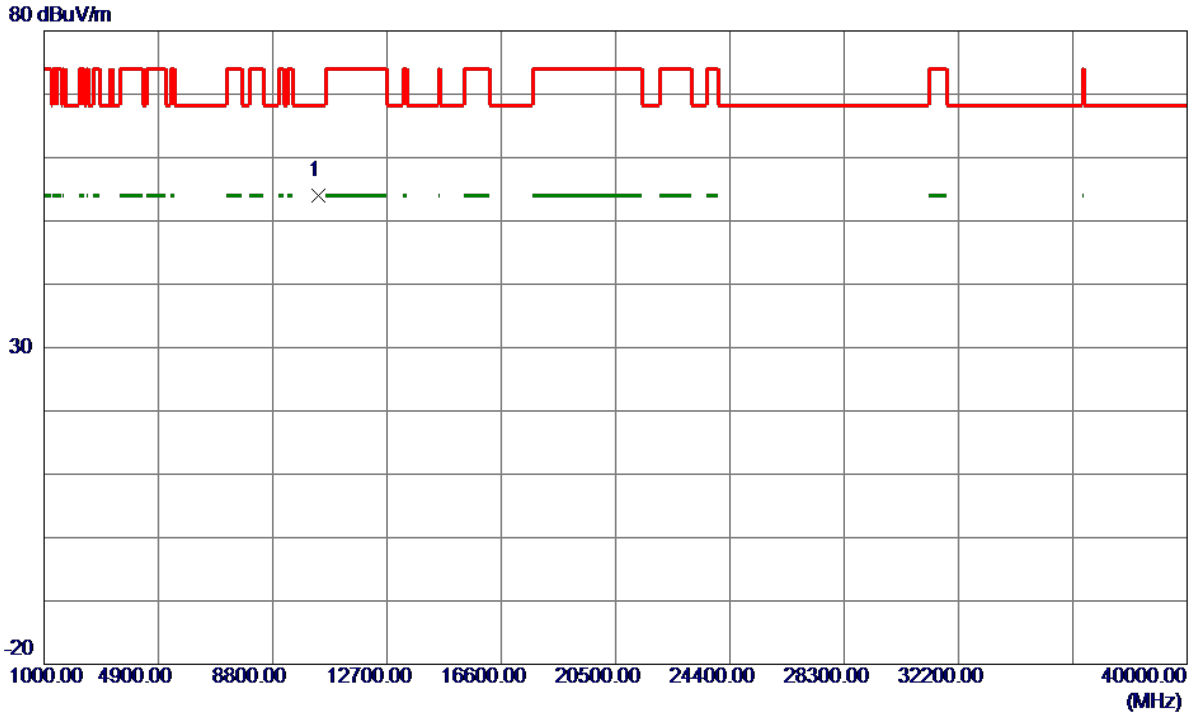

No.	Freq. MHz	Reading Level dBuV/m	Correct Factor dB	Measure ment dBuV/m	Limit dBuV/m	Margin dB	Detector	Comment
1 *	10361.9900	33.63	20.28	53.91	68.30	-14.39	Peak	

Orthogonal Axis:	X
Test Mode:	UNII-1/ TX A Mode 5180MHz

Horizontal

130 dBuV/m

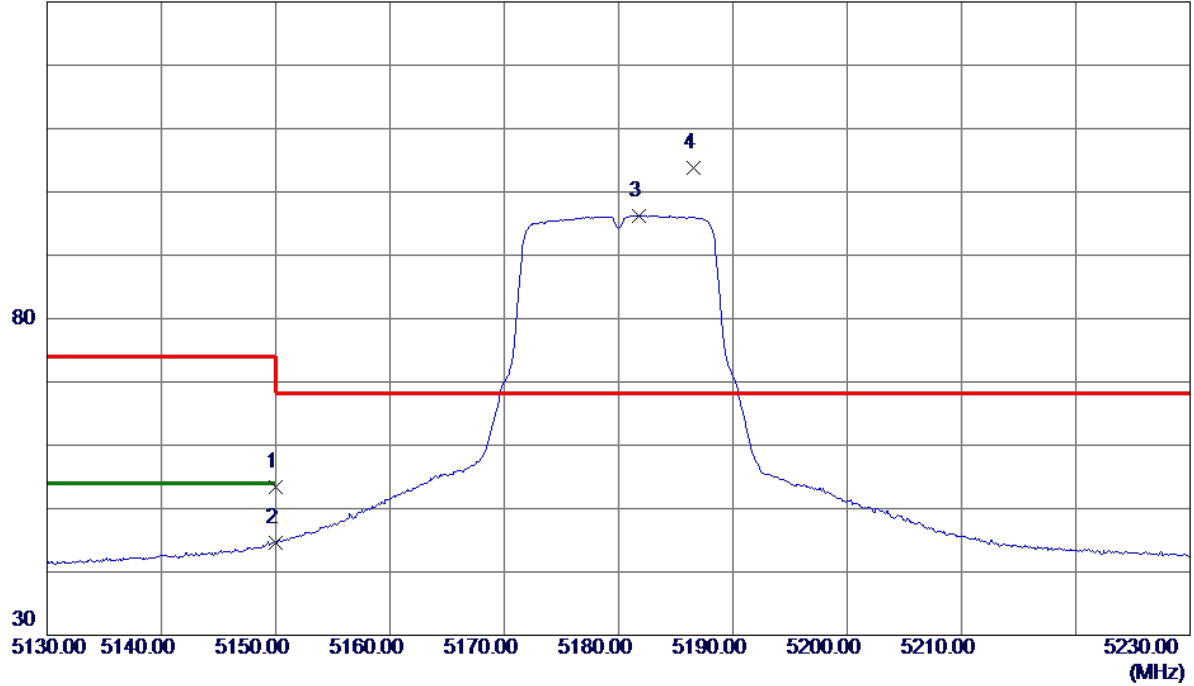

No.	Freq. MHz	Reading Level dBuV/m	Correct Factor dB	Measure ment dBuV/m	Limit dBuV/m	Margin dB	Detector	Comment
1	5150.0000	32.28	21.03	53.31	74.00	-20.69	Peak	
2	5150.0000	23.65	21.03	44.68	54.00	-9.32	AVG	
3	5181.8000	75.06	21.15	96.21	999.00	-902.79	AVG	No Limit
4 *	5186.6000	82.68	21.17	103.85	68.30	35.55	Peak	No Limit

Orthogonal Axis:	X
Test Mode:	UNII-1/ TX A Mode 5180MHz

Horizontal

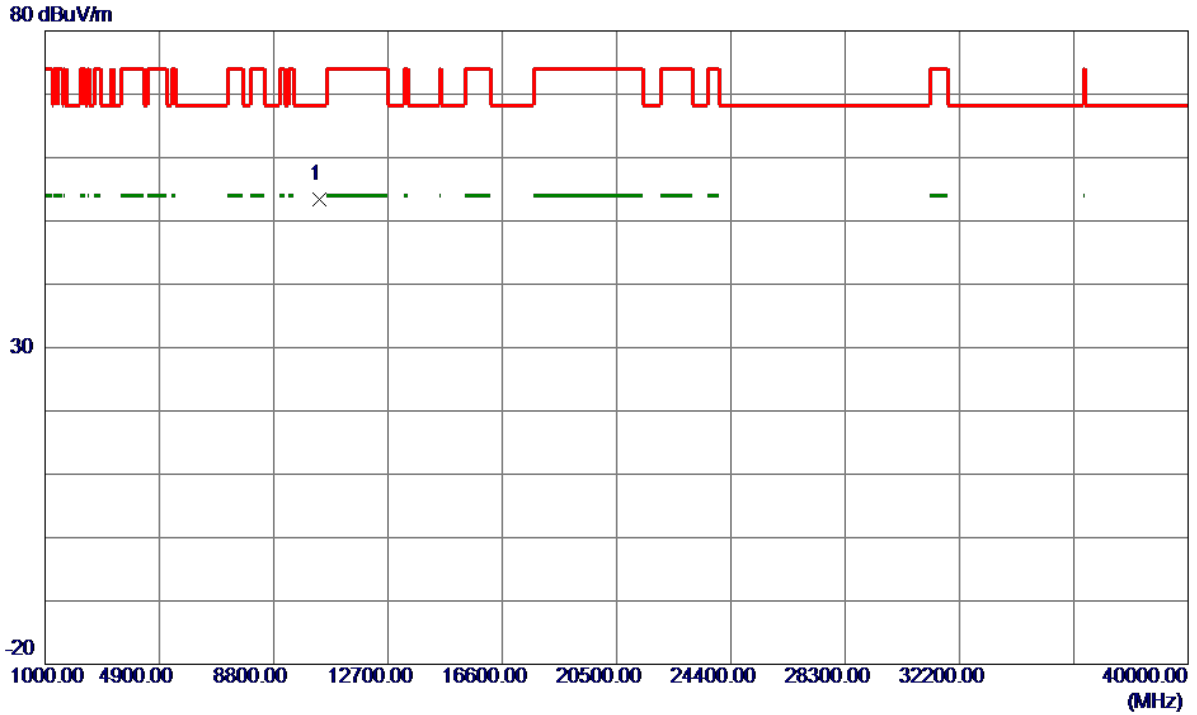

No.	Freq. MHz	Reading Level dBuV/m	Correct Factor dB	Measure ment dBuV/m	Limit dBuV/m	Margin dB	Detector	Comment
1 *	10360.1250	33.20	20.28	53.48	68.30	-14.82	Peak	

Orthogonal Axis:	X
Test Mode:	UNII-1/ TX A Mode 5200MHz

Vertical

130 dBuV/m

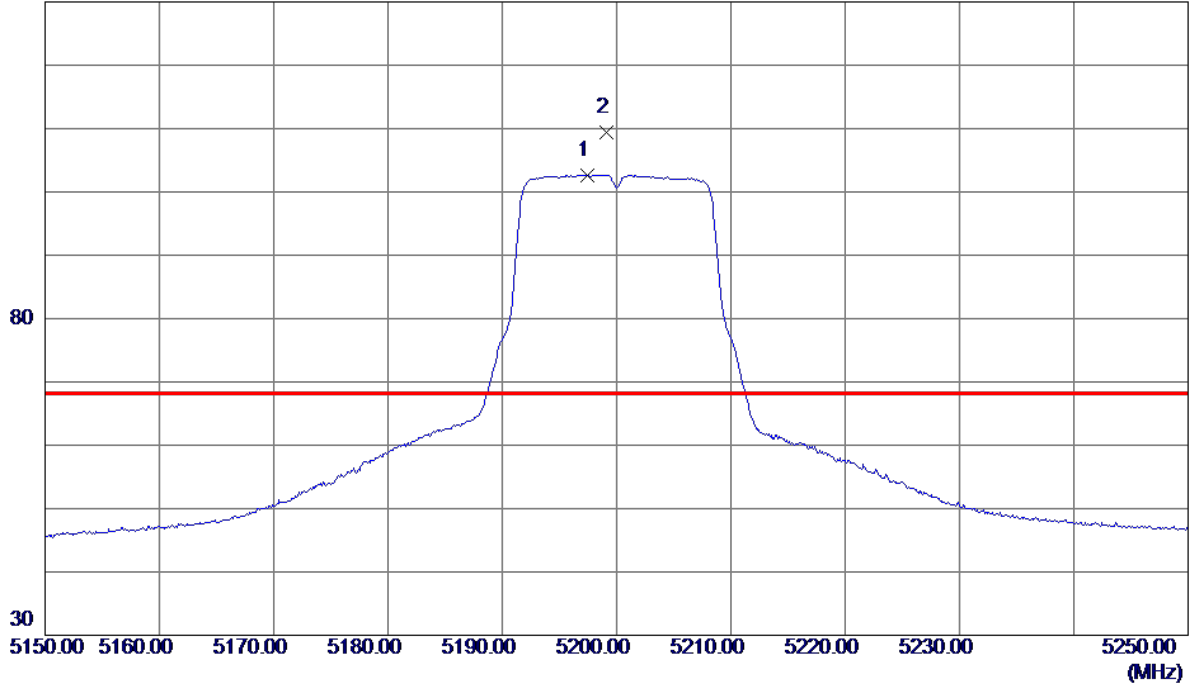

No.	Freq. MHz	Reading Level dBuV/m	Correct Factor dB	Measure ment dBuV/m	Limit dBuV/m	Margin dB	Detector	Comment
1	5197.4000	81.49	21.20	102.69	999.00	-896.31	AVG	No Limit
2 *	5199.1000	88.19	21.21	109.40	68.30	41.10	Peak	No Limit

Orthogonal Axis:	X
Test Mode:	UNII-1/ TX A Mode 5200MHz

Vertical

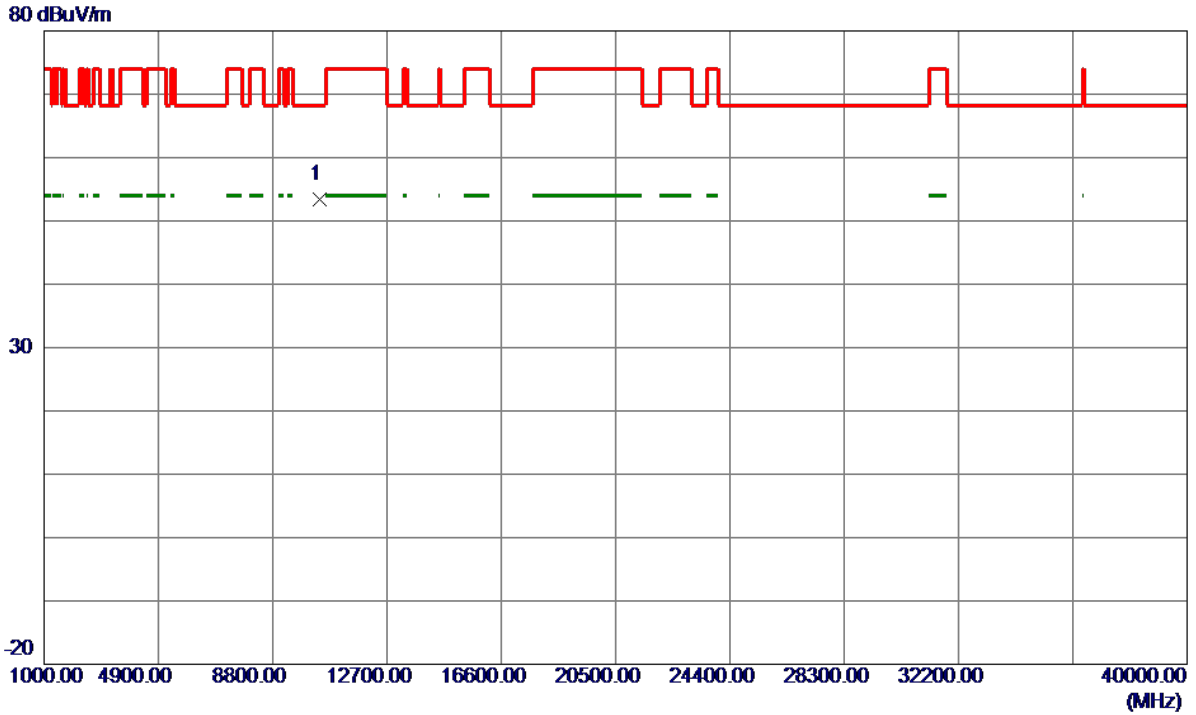

No.	Freq. MHz	Reading Level dBuV/m	Correct Factor dB	Measure ment dBuV/m	Limit dBuV/m	Margin dB	Detector	Comment
1 *	10401.9300	33.01	20.33	53.34	68.30	-14.96	Peak	

Orthogonal Axis:	X
Test Mode:	UNII-1/ TX A Mode 5200MHz

Horizontal

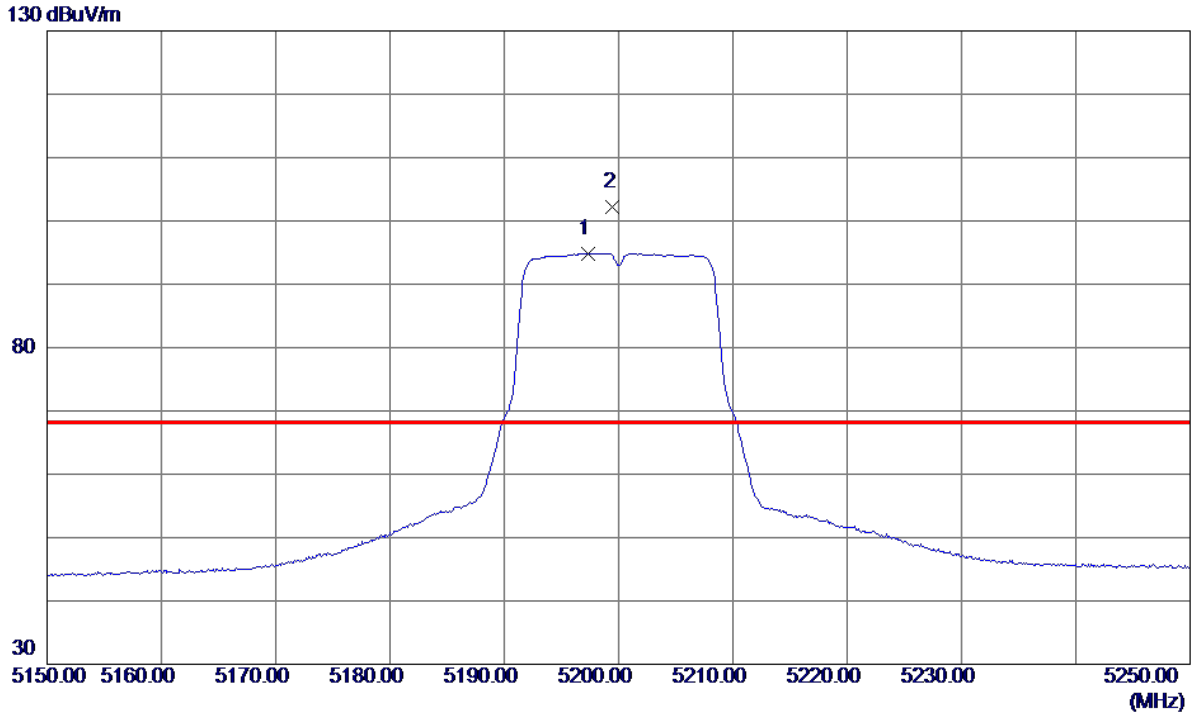

No.	Freq. MHz	Reading Level dBuV/m	Correct Factor dB	Measure ment dBuV/m	Limit dBuV/m	Margin dB	Detector	Comment
1	5197.3000	73.63	21.20	94.83	999.00	-904.17	AVG	No Limit
2 *	5199.5000	80.98	21.21	102.19	68.30	33.89	Peak	No Limit

Orthogonal Axis:	X
Test Mode:	UNII-1/ TX A Mode 5200MHz

Horizontal

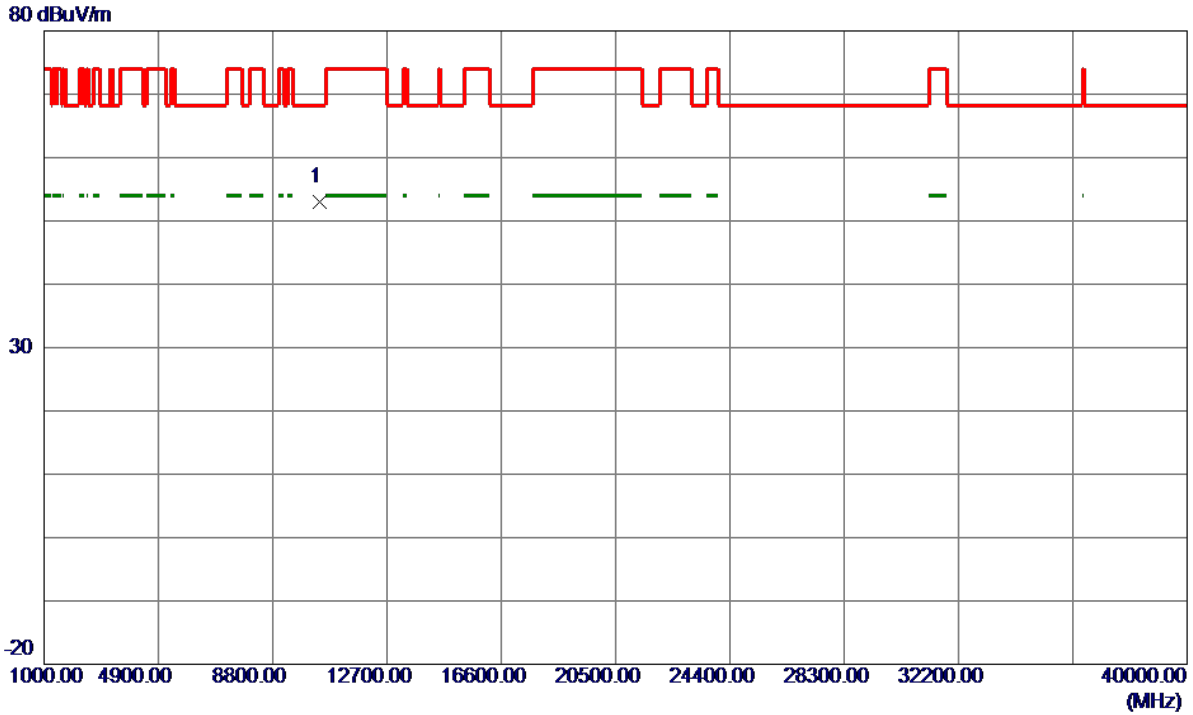

No.	Freq. MHz	Reading Level dBuV/m	Correct Factor dB	Measure ment dBuV/m	Limit dBuV/m	Margin dB	Detector	Comment
1 *	10397.6350	32.61	20.33	52.94	68.30	-15.36	Peak	

Orthogonal Axis:	X
Test Mode:	UNII-1/ TX A Mode 5240MHz

Vertical

130 dBuV/m

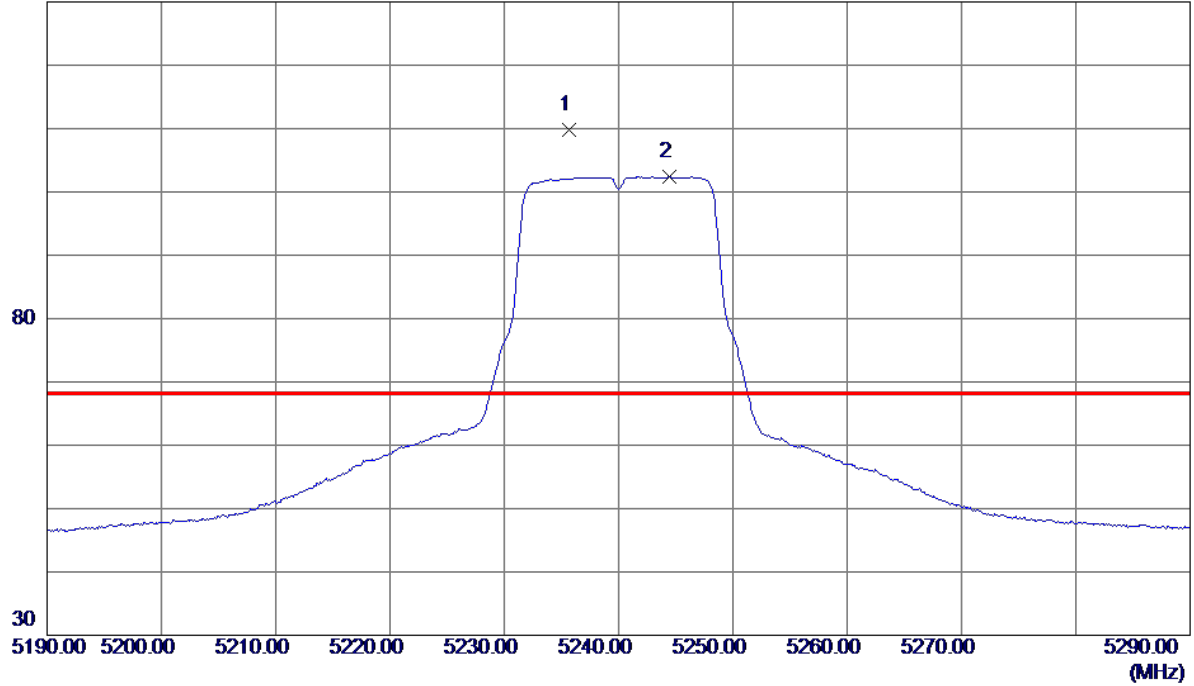

No.	Freq. MHz	Reading Level dBuV/m	Correct Factor dB	Measure ment dBuV/m	Limit dBuV/m	Margin dB	Detector	Comment
1 *	5235.7000	88.51	21.34	109.85	68.30	41.55	Peak	No Limit
2	5244.4000	80.99	21.37	102.36	999.00	-896.64	AVG	No Limit

Orthogonal Axis:	X
Test Mode:	UNII-1/ TX A Mode 5240MHz

Vertical

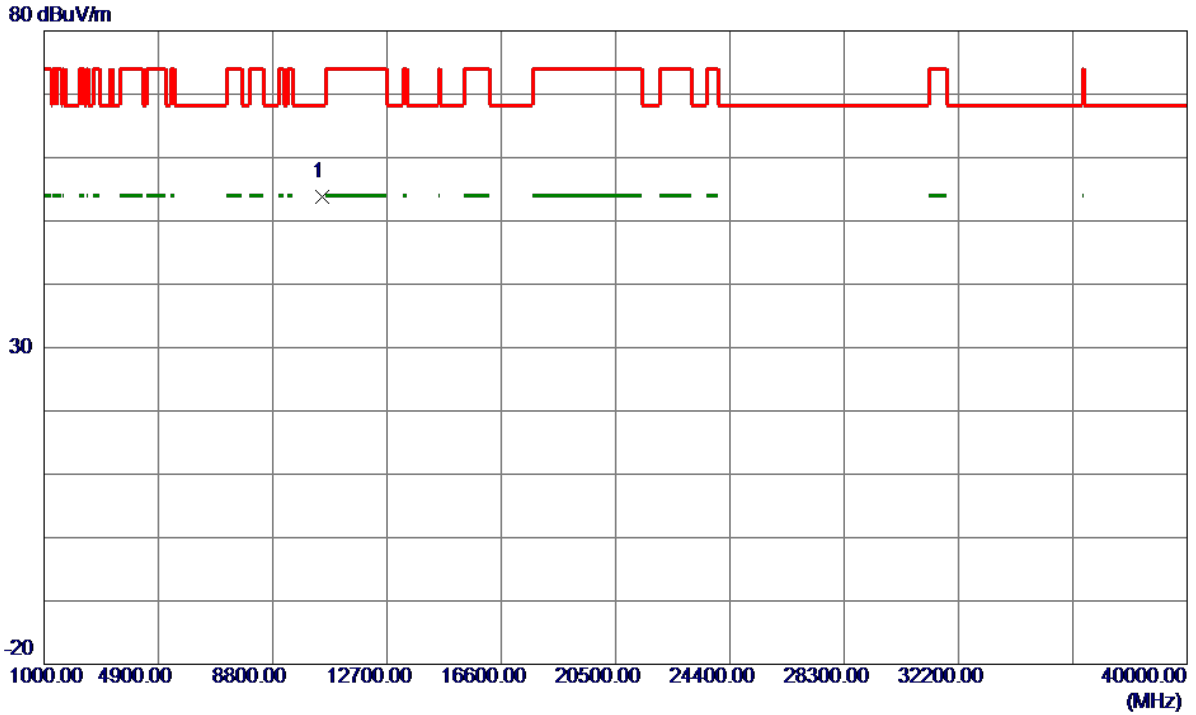

No.	Freq. MHz	Reading Level dBuV/m	Correct Factor dB	Measure ment dBuV/m	Limit dBuV/m	Margin dB	Detector	Comment
1 *	10478.6700	33.41	20.44	53.85	68.30	-14.45	Peak	

Orthogonal Axis:	X
Test Mode:	UNII-1/ TX A Mode 5240MHz

Horizontal

130 dBuV/m

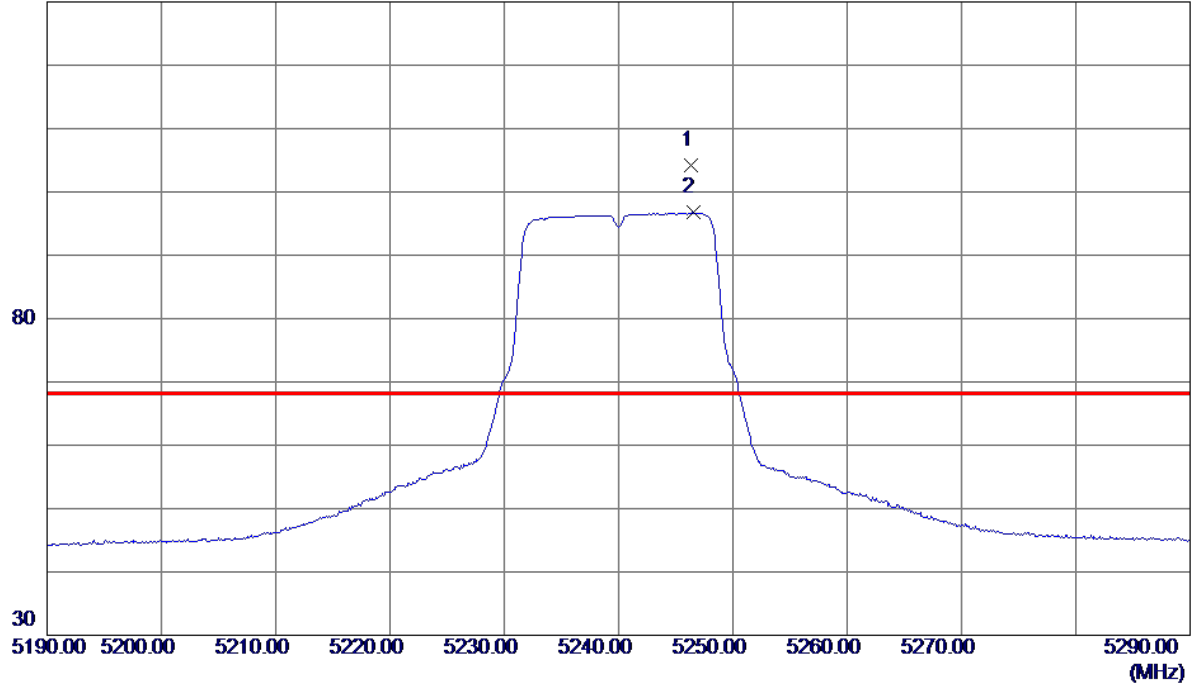

No.	Freq. MHz	Reading Level dBuV/m	Correct Factor dB	Measure ment dBuV/m	Limit dBuV/m	Margin dB	Detector	Comment
1 *	5246.3000	82.88	21.38	104.26	68.30	35.96	Peak	No Limit
2	5246.5000	75.40	21.38	96.78	999.00	-902.22	AVG	No Limit

Orthogonal Axis:	X
Test Mode:	UNII-1/ TX A Mode 5240MHz

Horizontal

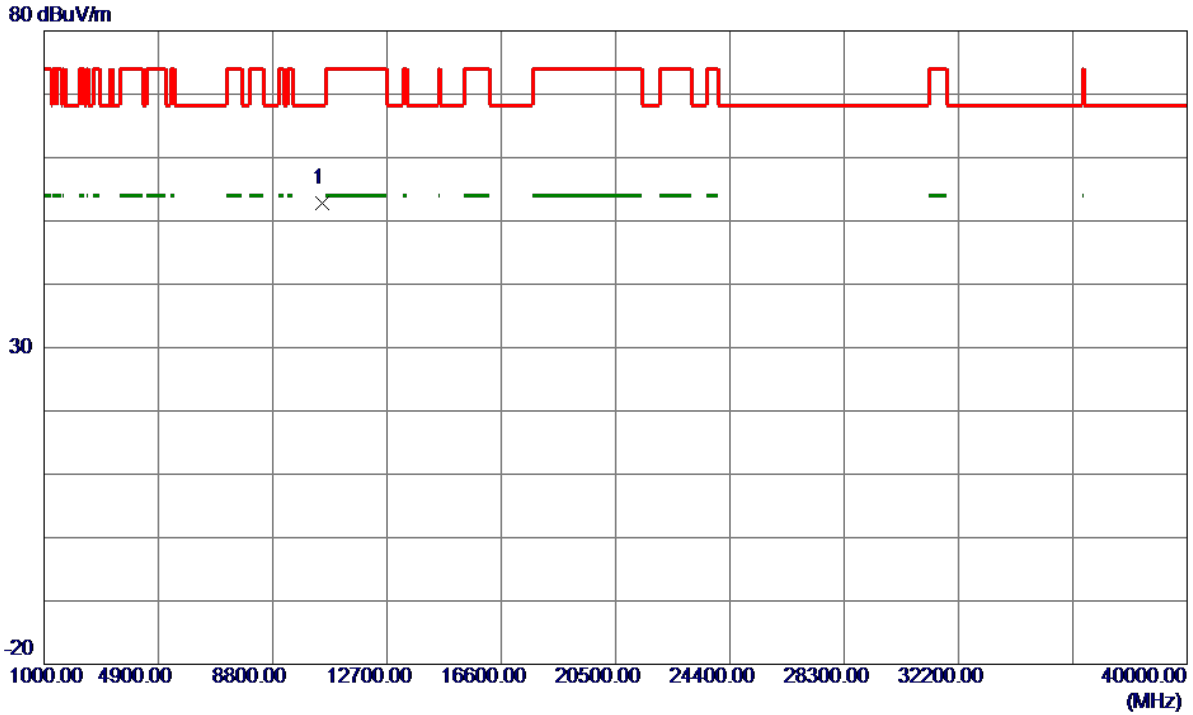

No.	Freq. MHz	Reading Level dBuV/m	Correct Factor dB	Measure ment dBuV/m	Limit dBuV/m	Margin dB	Detector	Comment
1 *	10480.6300	32.31	20.44	52.75	68.30	-15.55	Peak	

Orthogonal Axis:	X
Test Mode:	UNII-1/ TX N20 Mode 5180MHz

Vertical

130 dBuV/m

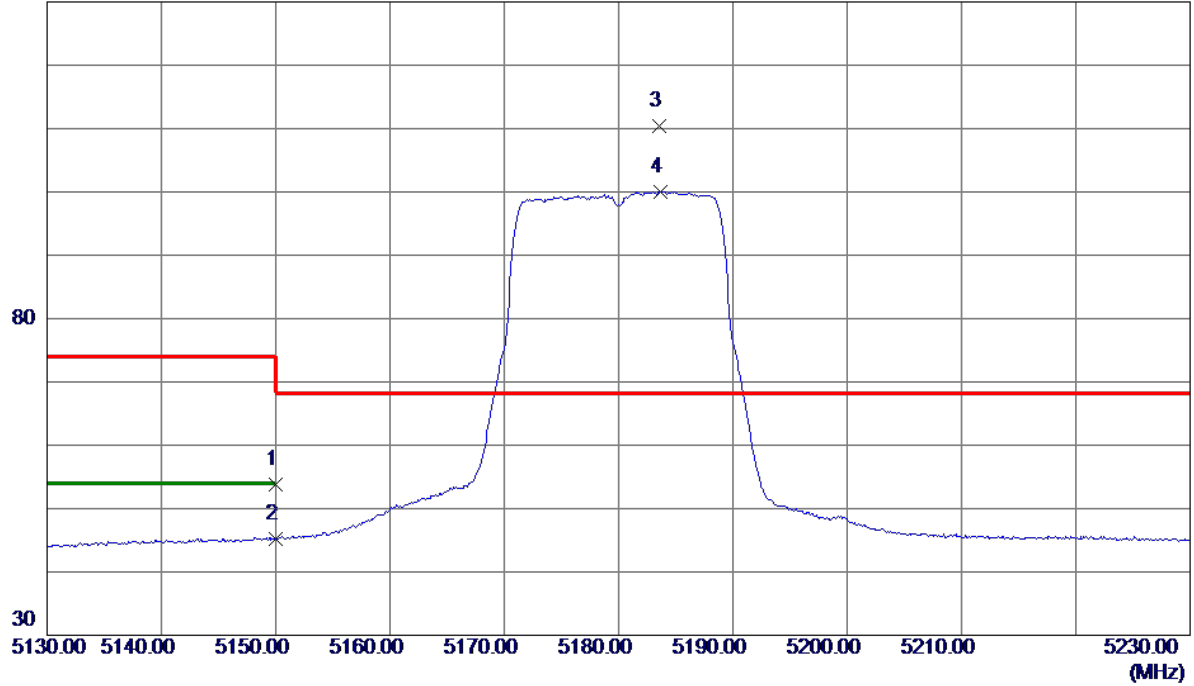

No.	Freq. MHz	Reading Level dBuV/m	Correct Factor dB	Measure ment dBuV/m	Limit dBuV/m	Margin dB	Detector	Comment
1	5150.0000	32.80	21.03	53.83	74.00	-20.17	Peak	
2	5150.0000	24.19	21.03	45.22	54.00	-8.78	AVG	
3 *	5183.6000	89.22	21.15	110.37	68.30	42.07	Peak	No Limit
4	5183.7000	78.93	21.15	100.08	999.00	-898.92	AVG	No Limit

Orthogonal Axis:	X
Test Mode:	UNII-1/ TX N20 Mode 5180MHz

Vertical

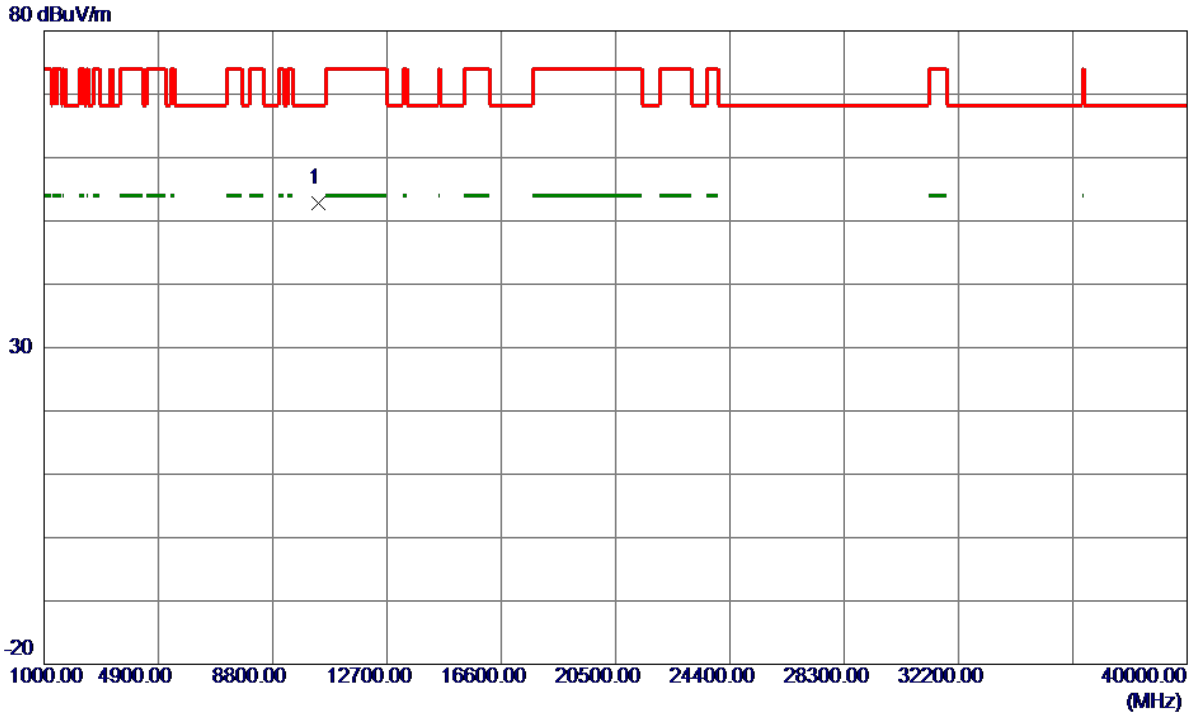

No.	Freq. MHz	Reading Level dBuV/m	Correct Factor dB	Measure ment dBuV/m	Limit dBuV/m	Margin dB	Detector	Comment
1 *	10358.6250	32.55	20.28	52.83	68.30	-15.47	Peak	

Orthogonal Axis:	X
Test Mode:	UNII-1/ TX N20 Mode 5180MHz

Horizontal

130 dBuV/m

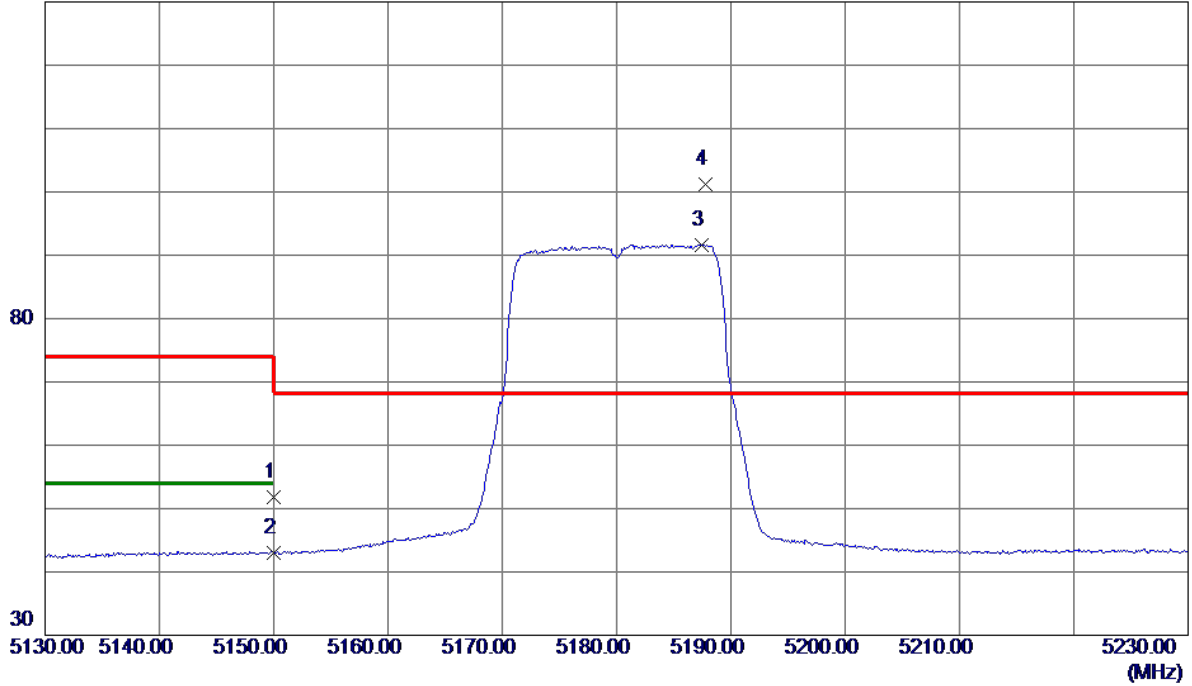

No.	Freq. MHz	Reading Level dBuV/m	Correct Factor dB	Measure ment dBuV/m	Limit dBuV/m	Margin dB	Detector	Comment
1	5150.0000	30.69	21.03	51.72	74.00	-22.28	Peak	
2	5150.0000	22.00	21.03	43.03	54.00	-10.97	AVG	
3	5187.4000	70.49	21.17	91.66	999.00	-907.34	AVG	No Limit
4 *	5187.8000	80.02	21.17	101.19	68.30	32.89	Peak	No Limit

Orthogonal Axis:	X
Test Mode:	UNII-1/ TX N20 Mode 5180MHz

Horizontal

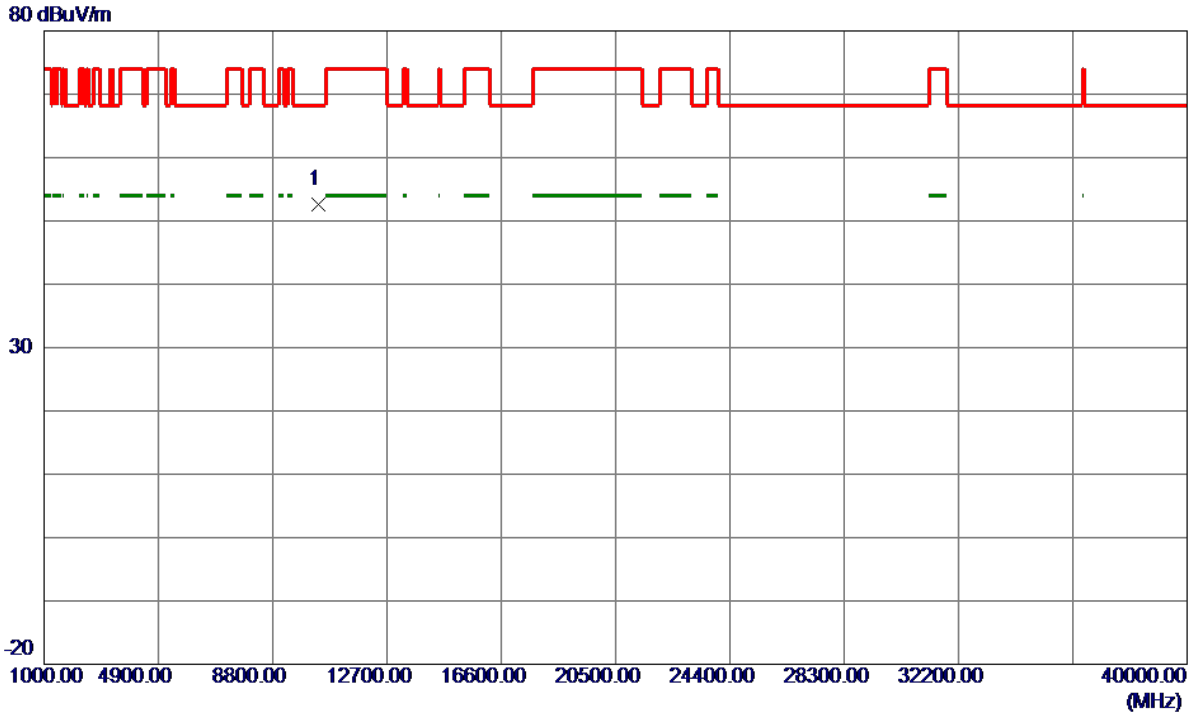

No.	Freq. MHz	Reading Level dBuV/m	Correct Factor dB	Measure ment dBuV/m	Limit dBuV/m	Margin dB	Detector	Comment
1 *	10362.0950	32.32	20.28	52.60	68.30	-15.70	Peak	

Orthogonal Axis:	X
Test Mode:	UNII-1/ TX N20 Mode 5200MHz

Vertical

130 dBuV/m

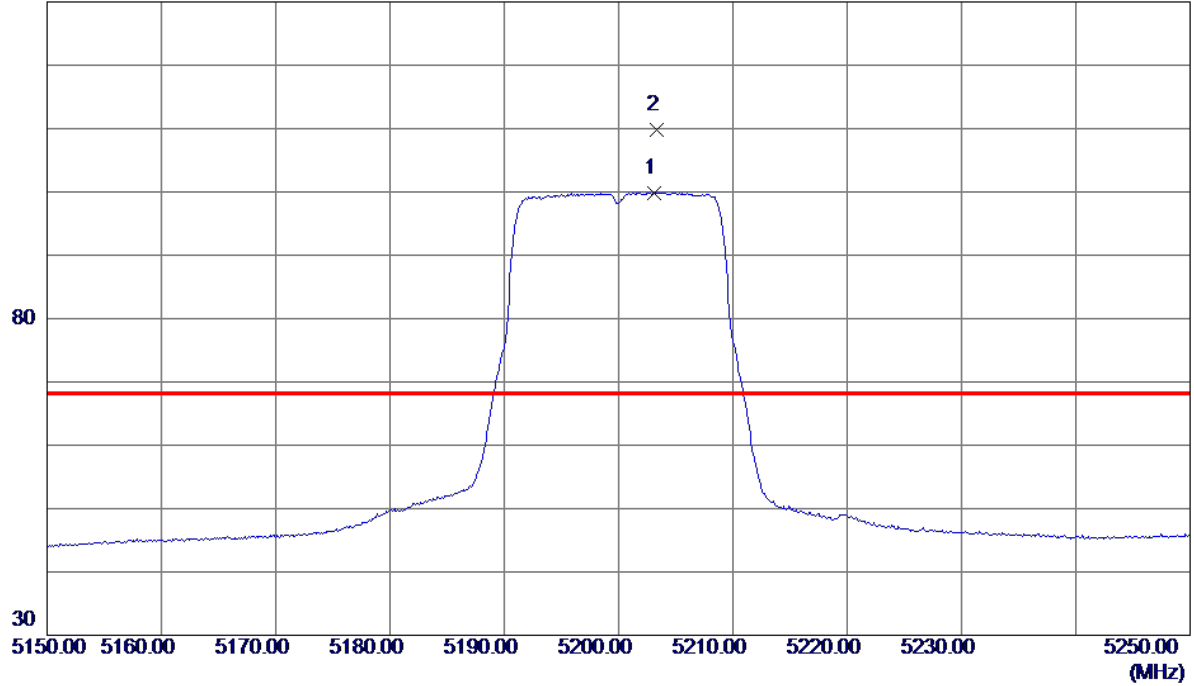

No.	Freq. MHz	Reading Level dBuV/m	Correct Factor dB	Measure ment dBuV/m	Limit dBuV/m	Margin dB	Detector	Comment
1	5203.1000	78.66	21.23	99.89	999.00	-899.11	AVG	No Limit
2 *	5203.3000	88.66	21.23	109.89	68.30	41.59	Peak	No Limit

Orthogonal Axis:	X
Test Mode:	UNII-1/ TX N20 Mode 5200MHz

Vertical

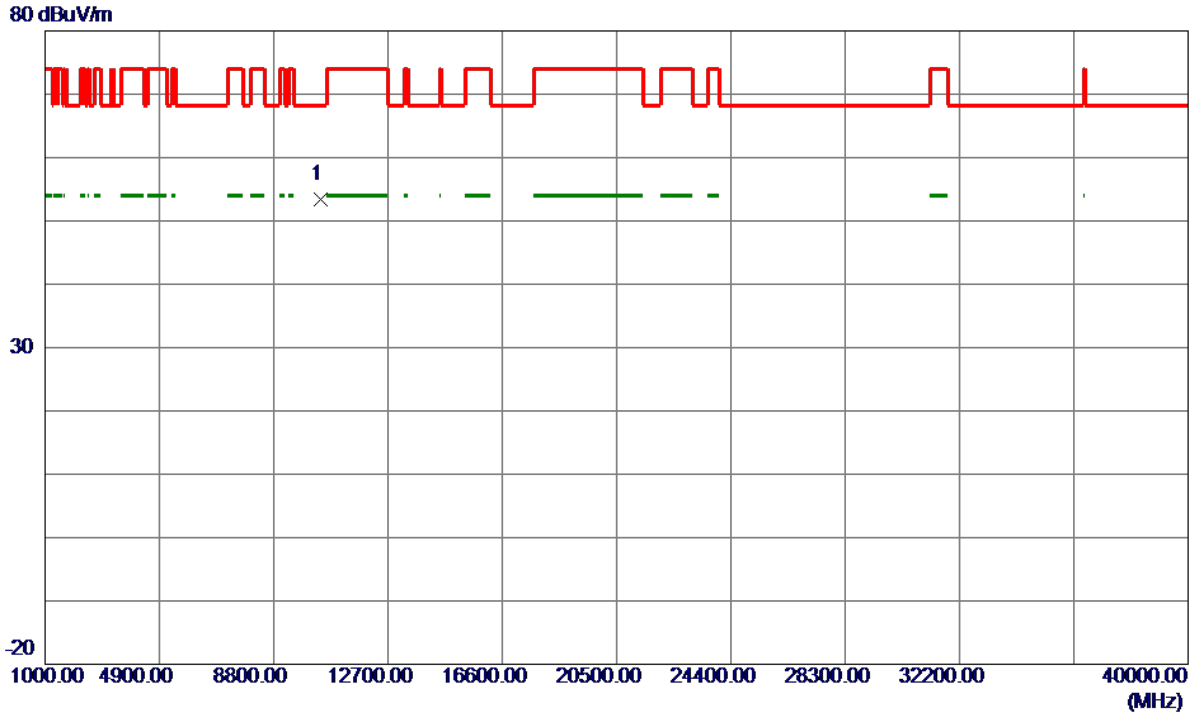

No.	Freq. MHz	Reading Level dBuV/m	Correct Factor dB	Measure ment dBuV/m	Limit dBuV/m	Margin dB	Detector	Comment
1 *	10400.8750	33.03	20.33	53.36	68.30	-14.94	Peak	

Orthogonal Axis:	X
Test Mode:	UNII-1/ TX N20 Mode 5200MHz

Horizontal

130 dBuV/m

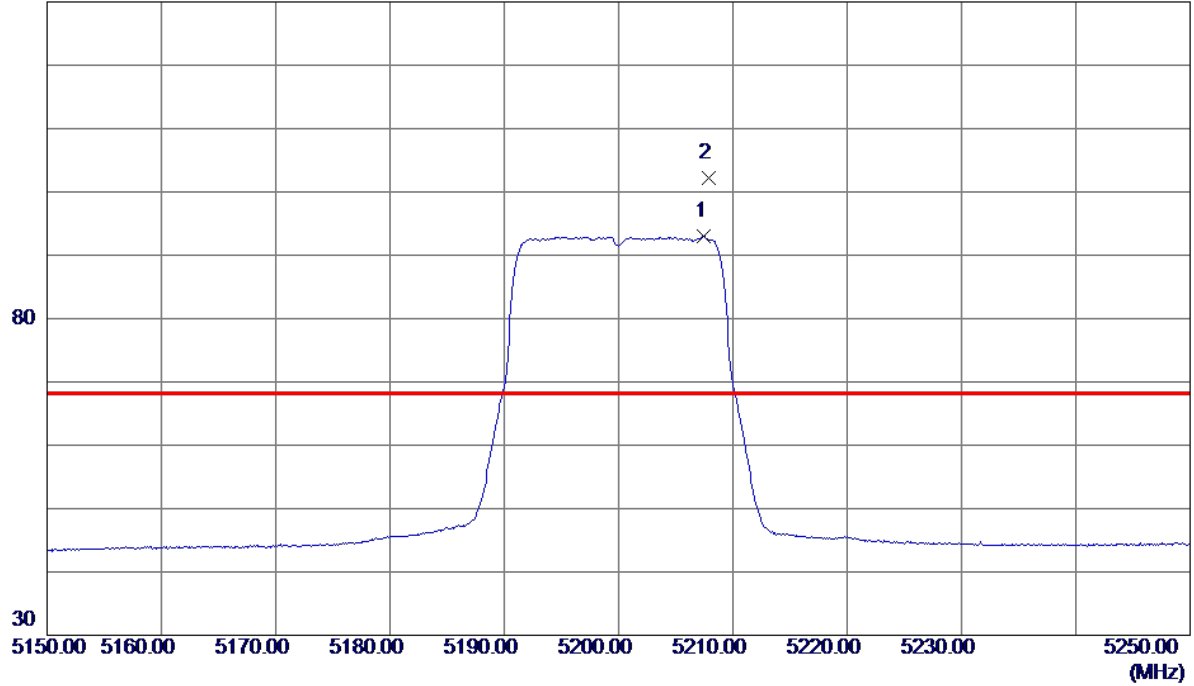

No.	Freq. MHz	Reading Level dBuV/m	Correct Factor dB	Measure ment dBuV/m	Limit dBuV/m	Margin dB	Detector	Comment
1	5207.5000	71.78	21.24	93.02	999.00	-905.98	AVG	No Limit
2 *	5207.9000	80.94	21.24	102.18	68.30	33.88	Peak	No Limit

Orthogonal Axis:	X
Test Mode:	UNII-1/ TX N20 Mode 5200MHz

Horizontal

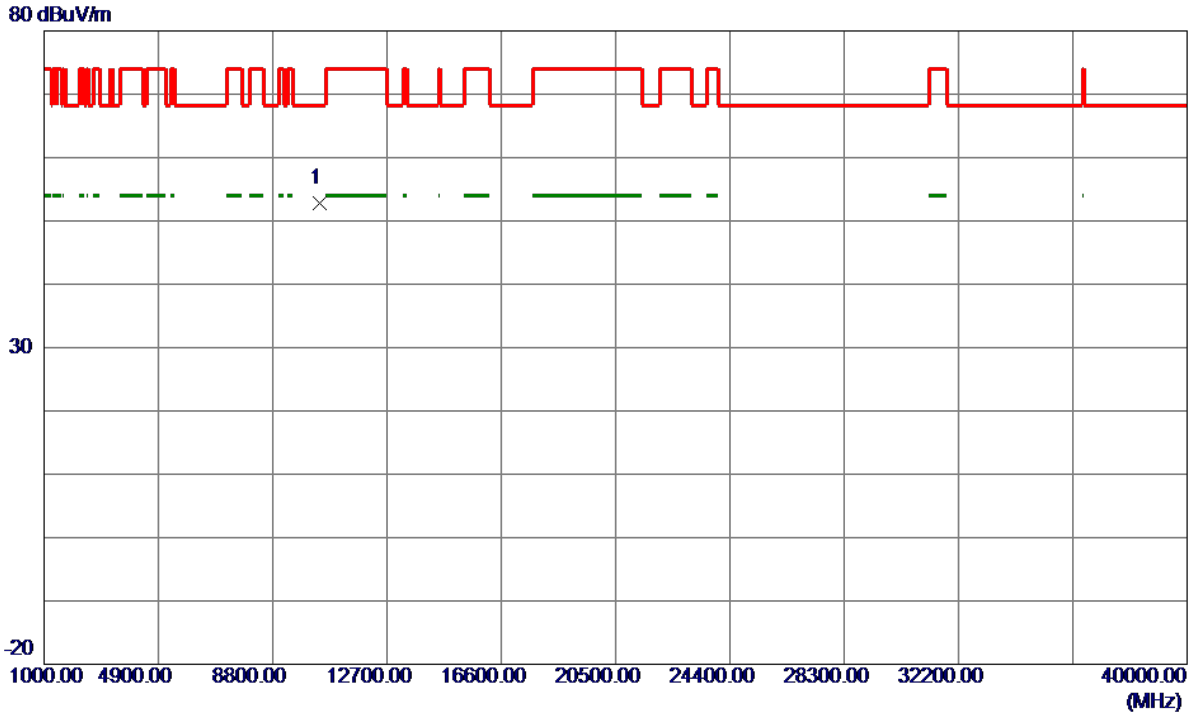

No.	Freq. MHz	Reading Level dBuV/m	Correct Factor dB	Measure ment dBuV/m	Limit dBuV/m	Margin dB	Detector	Comment
1 *	10401.3949	32.53	20.33	52.86	68.30	-15.44	Peak	

Orthogonal Axis:	X
Test Mode:	UNII-1/ TX N20 Mode 5240MHz

Vertical

130 dBuV/m

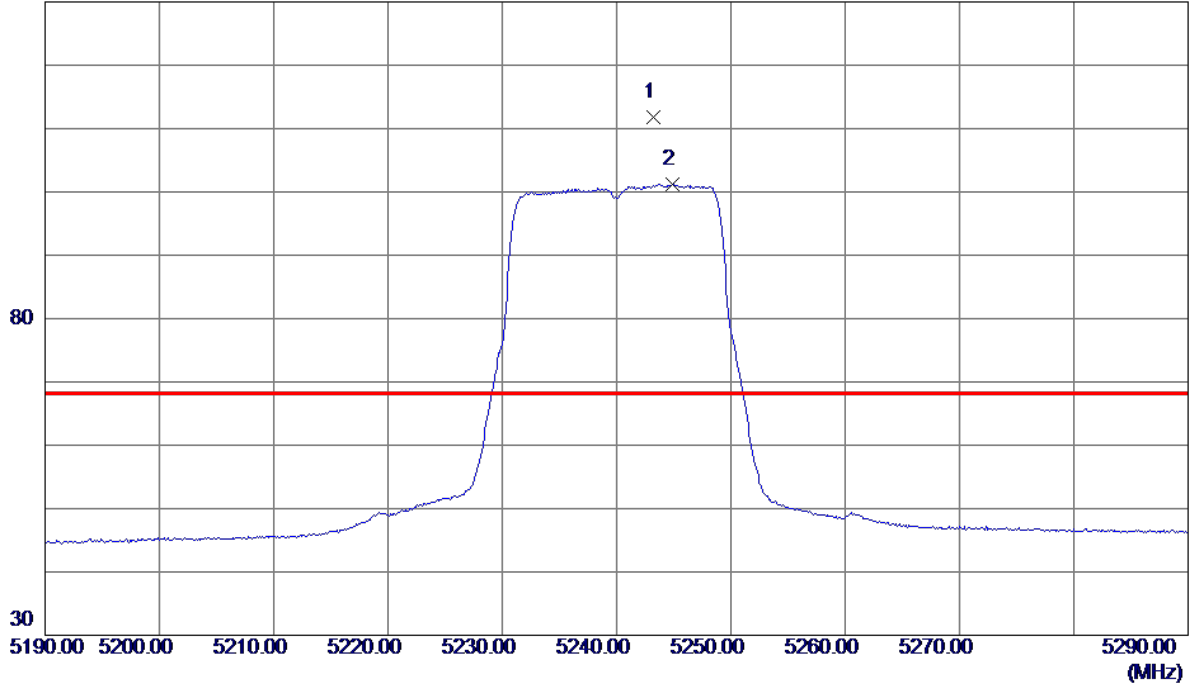

No.	Freq. MHz	Reading Level dBuV/m	Correct Factor dB	Measure ment dBuV/m	Limit dBuV/m	Margin dB	Detector	Comment
1 *	5243.2000	90.43	21.37	111.80	68.30	43.50	Peak	No Limit
2	5244.9000	79.79	21.38	101.17	999.00	-897.83	AVG	No Limit

Orthogonal Axis:	X
Test Mode:	UNII-1/ TX N20 Mode 5240MHz

Vertical

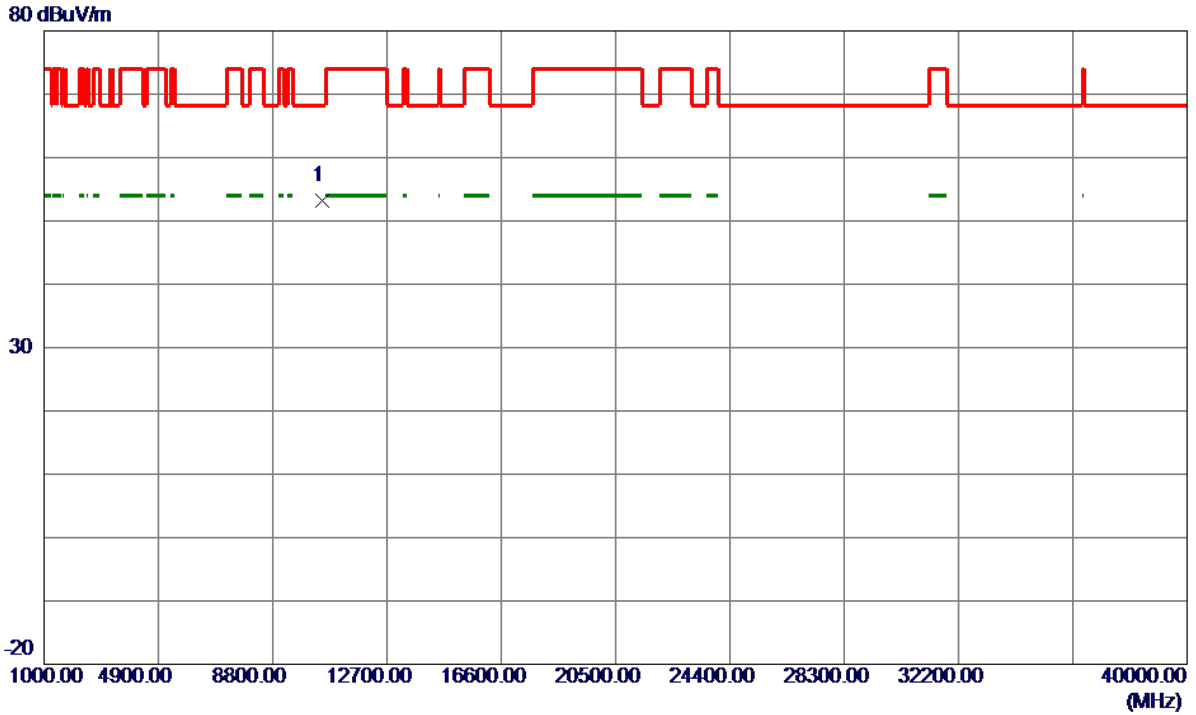

No.	Freq. MHz	Reading Level dBuV/m	Correct Factor dB	Measure ment dBuV/m	Limit dBuV/m	Margin dB	Detector	Comment
1 *	10478.2250	32.75	20.44	53.19	68.30	-15.11	Peak	

Orthogonal Axis:	X
Test Mode:	UNII-1/ TX N20 Mode 5240MHz

Horizontal

130 dBuV/m

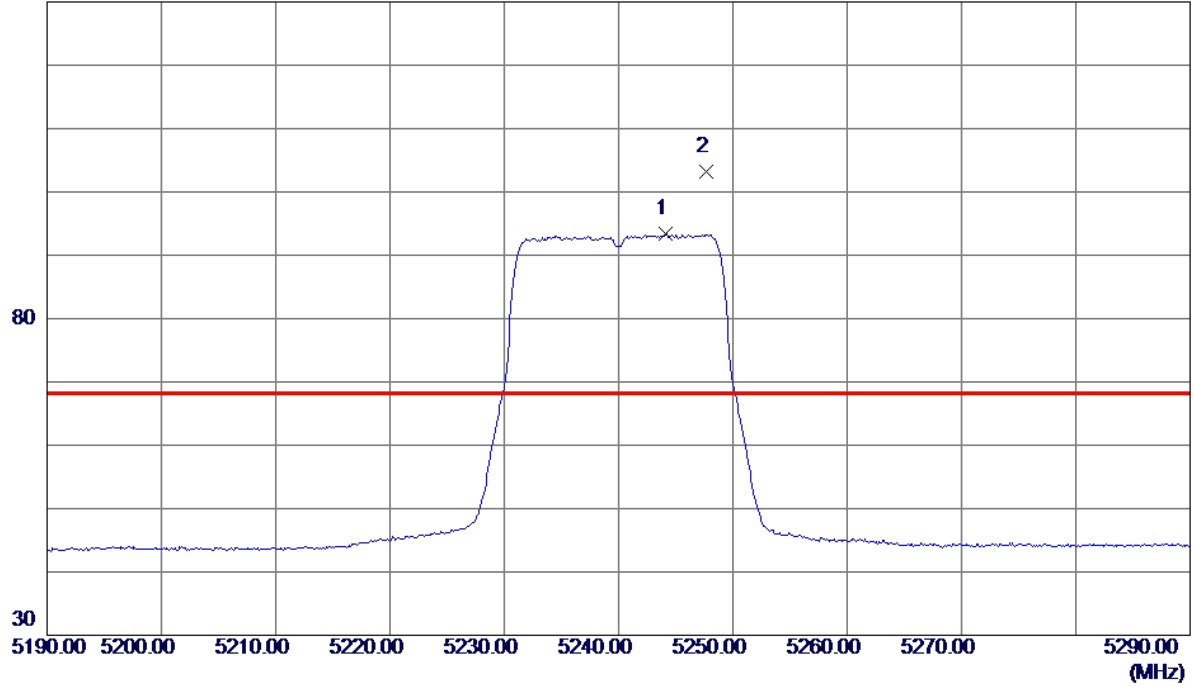

No.	Freq. MHz	Reading Level dBuV/m	Correct Factor dB	Measure ment dBuV/m	Limit dBuV/m	Margin dB	Detector	Comment
1	5244.1000	71.99	21.37	93.36	999.00	-905.64	AVG	No Limit
2 *	5247.7000	81.81	21.39	103.20	68.30	34.90	Peak	No Limit

Orthogonal Axis:	X
Test Mode:	UNII-1/ TX N20 Mode 5240MHz

Horizontal

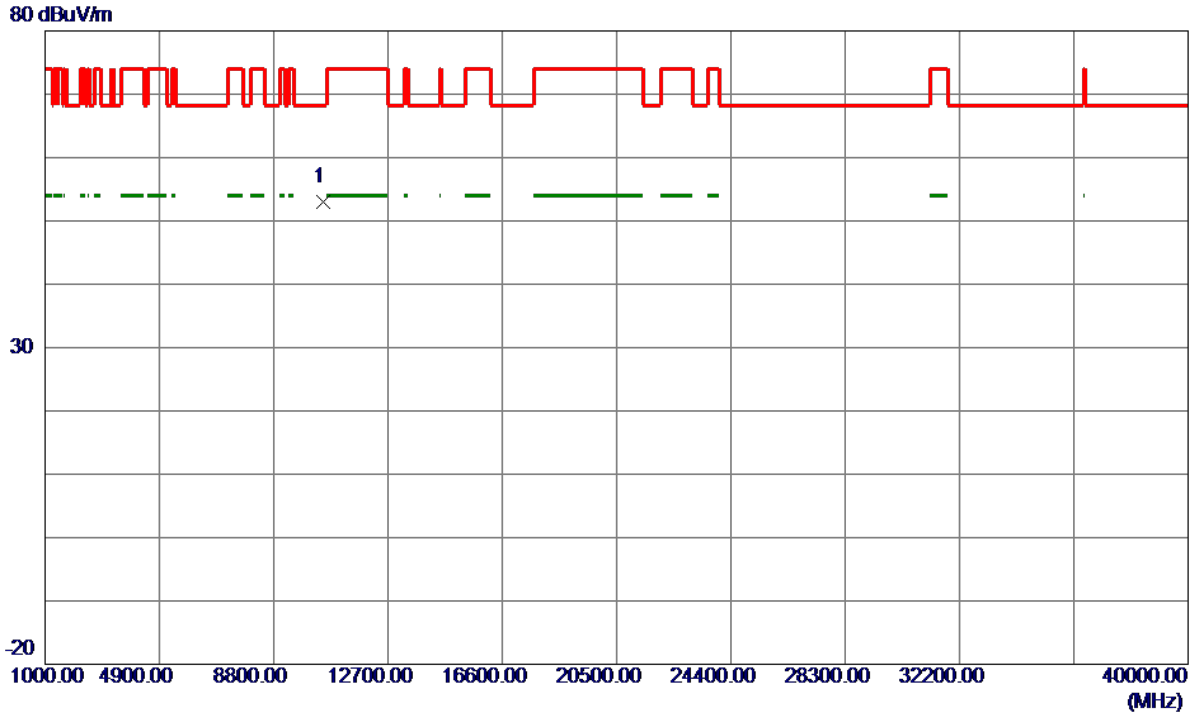

No.	Freq. MHz	Reading Level dBuV/m	Correct Factor dB	Measure ment dBuV/m	Limit dBuV/m	Margin dB	Detector	Comment
1 *	10481.5800	32.58	20.44	53.02	68.30	-15.28	Peak	

Orthogonal Axis:	X
Test Mode:	UNII-1/ TX N40 Mode 5190MHz

Vertical

130 dBuV/m

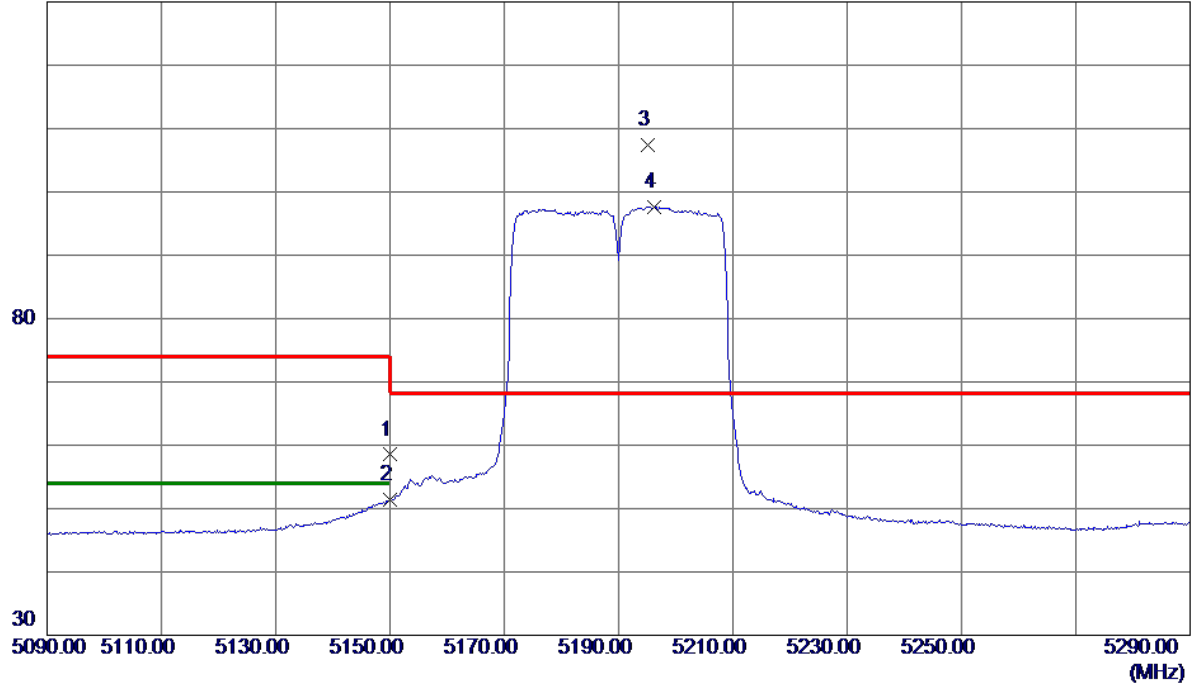

No.	Freq. MHz	Reading Level dBuV/m	Correct Factor dB	Measure ment dBuV/m	Limit dBuV/m	Margin dB	Detector	Comment
1	5150.0000	37.47	21.03	58.50	74.00	-15.50	Peak	
2	5150.0000	30.28	21.03	51.31	54.00	-2.69	AVG	
3 *	5195.2000	86.15	21.20	107.35	68.30	39.05	Peak	No Limit
4	5196.2000	76.46	21.20	97.66	999.00	-901.34	AVG	No Limit

Orthogonal Axis:	X
Test Mode:	UNII-1/ TX N40 Mode 5190MHz

Vertical

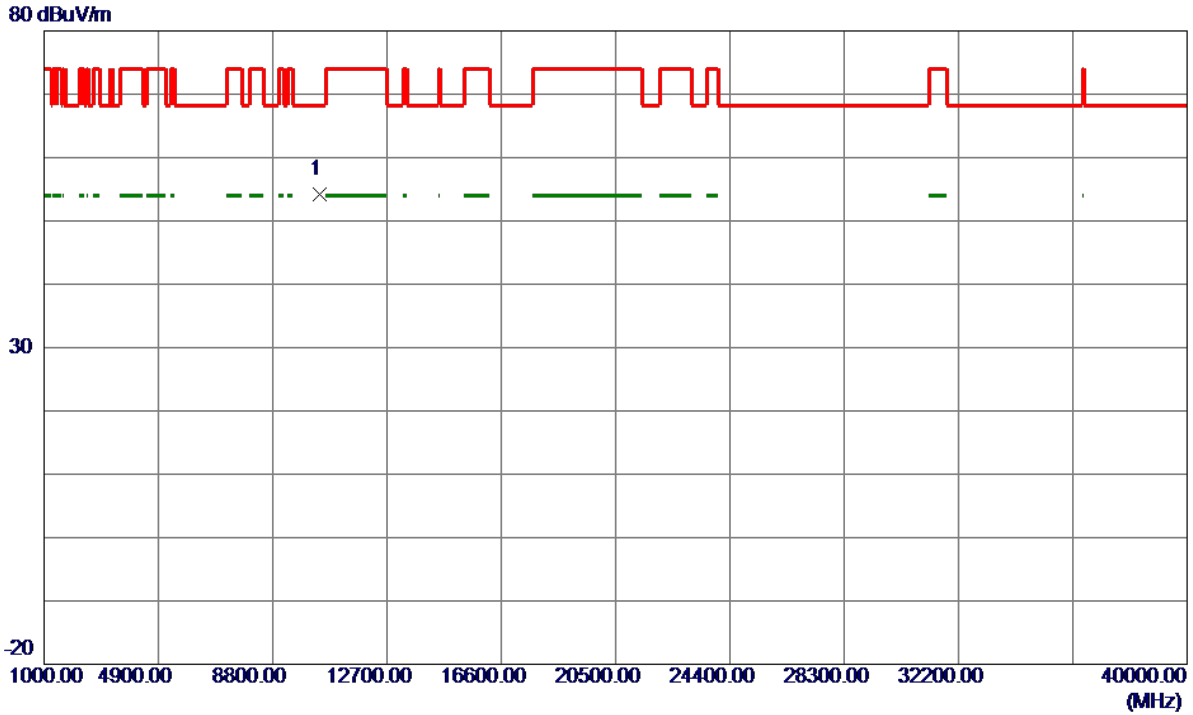

No.	Freq. MHz	Reading Level dBuV/m	Correct Factor dB	Measure ment dBuV/m	Limit dBuV/m	Margin dB	Detector	Comment
1 *	10383.6700	33.84	20.31	54.15	68.30	-14.15	Peak	

Orthogonal Axis:	X
Test Mode:	UNII-1/ TX N40 Mode 5190MHz

Horizontal

130 dBuV/m

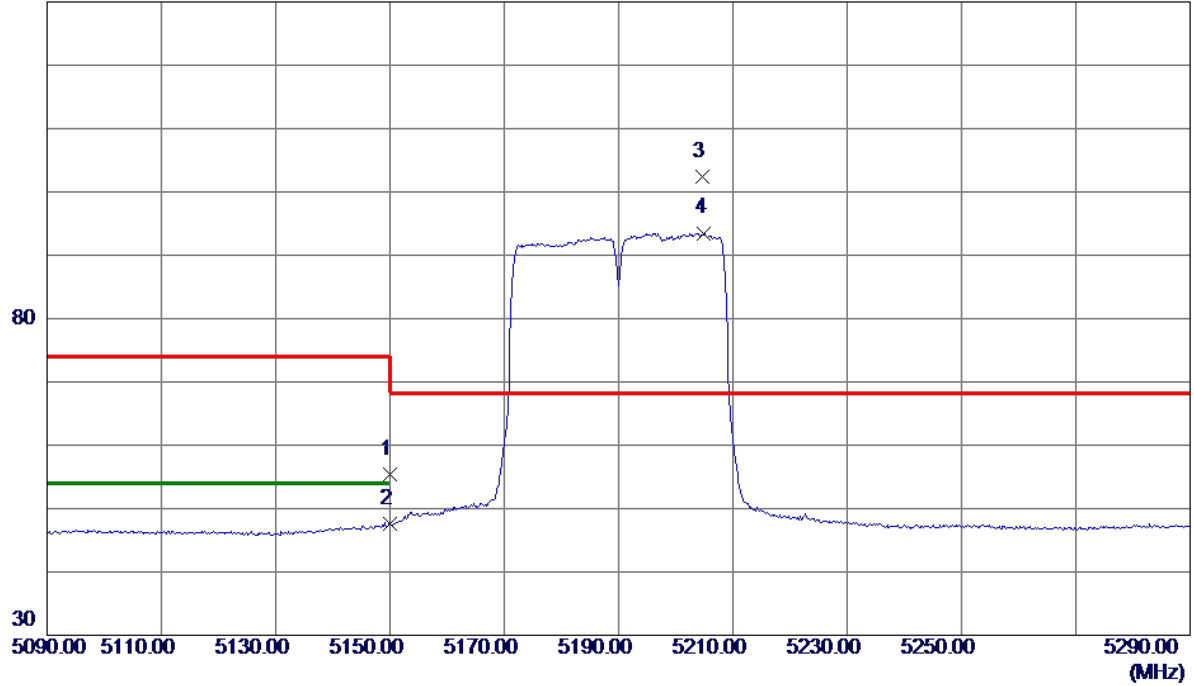

No.	Freq. MHz	Reading Level dBuV/m	Correct Factor dB	Measure ment dBuV/m	Limit dBuV/m	Margin dB	Detector	Comment
1	5150.0000	34.38	21.03	55.41	74.00	-18.59	Peak	
2	5150.0000	26.61	21.03	47.64	54.00	-6.36	AVG	
3 *	5204.6000	81.24	21.23	102.47	68.30	34.17	Peak	No Limit
4	5205.0000	72.27	21.23	93.50	999.00	-905.50	AVG	No Limit

Orthogonal Axis:	X
Test Mode:	UNII-1/ TX N40 Mode 5190MHz

Horizontal

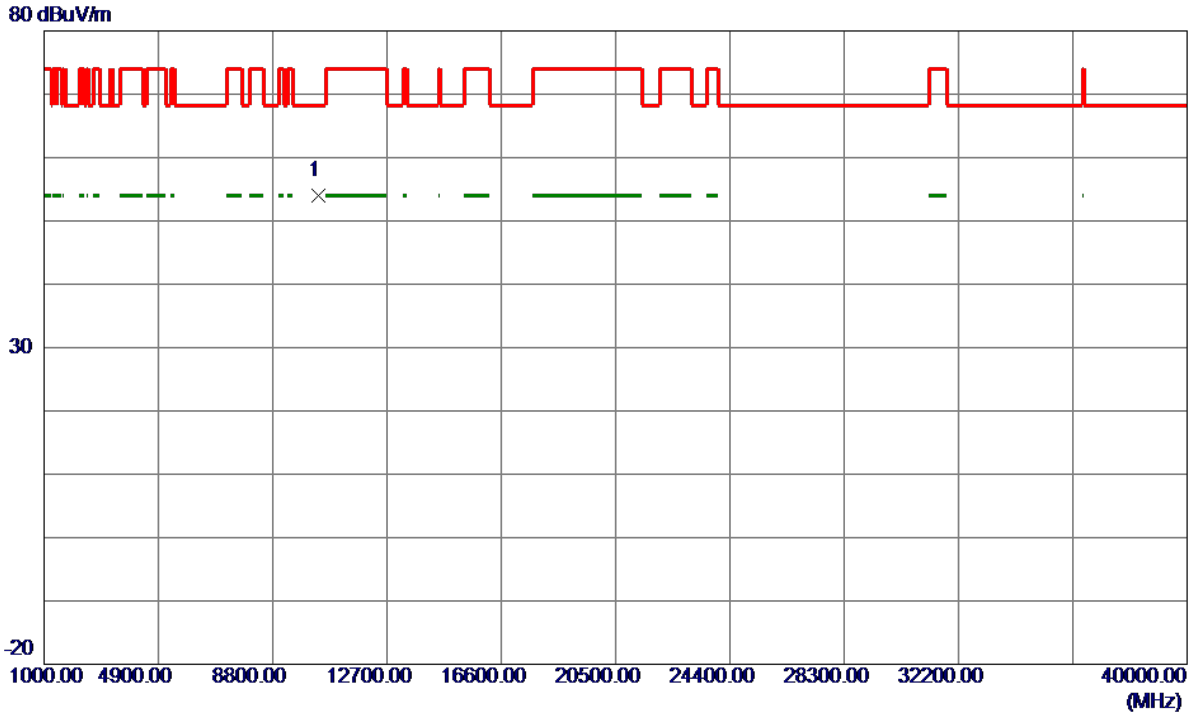

No.	Freq. MHz	Reading Level dBuV/m	Correct Factor dB	Measure ment dBuV/m	Limit dBuV/m	Margin dB	Detector	Comment
1 *	10381.5100	33.71	20.31	54.02	68.30	-14.28	Peak	

Orthogonal Axis:	X
Test Mode:	UNII-1/ TX N40 Mode 5230MHz

Vertical

130 dBuV/m

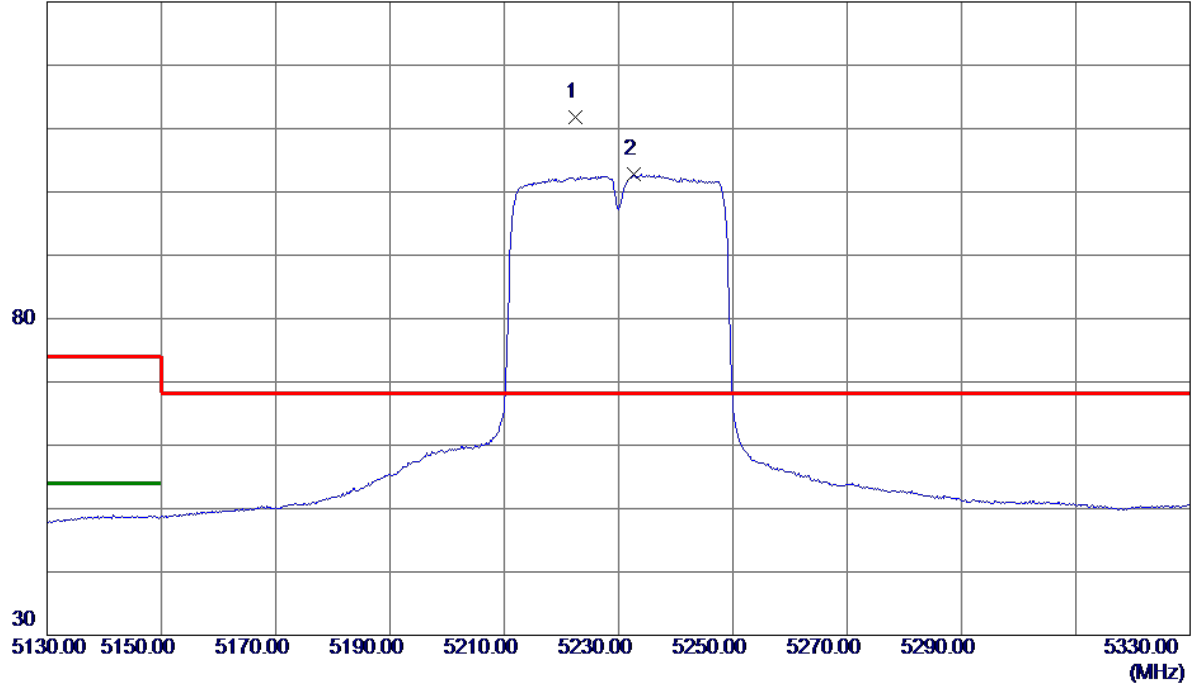

No.	Freq. MHz	Reading Level dBuV/m	Correct Factor dB	Measure ment dBuV/m	Limit dBuV/m	Margin dB	Detector	Comment
1 *	5222.4200	90.53	21.30	111.83	68.30	43.53	Peak	No Limit
2	5232.6000	81.38	21.33	102.71	999.00	-896.29	AVG	No Limit

Orthogonal Axis:	X
Test Mode:	UNII-1/ TX N40 Mode 5230MHz

Vertical

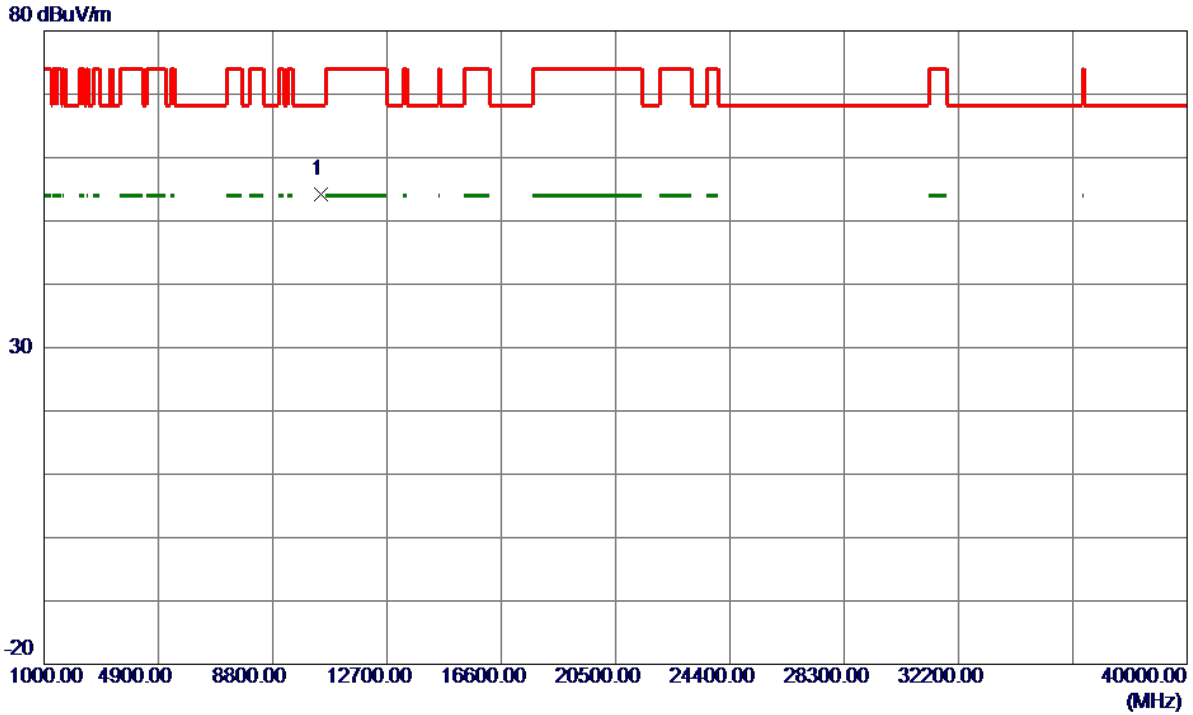

No.	Freq. MHz	Reading Level dBuV/m	Correct Factor dB	Measure ment dBuV/m	Limit dBuV/m	Margin dB	Detector	Comment
1 *	10460.0300	33.71	20.41	54.12	68.30	-14.18	Peak	

Orthogonal Axis:	X
Test Mode:	UNII-1/ TX N40 Mode 5230MHz

Horizontal

130 dBuV/m

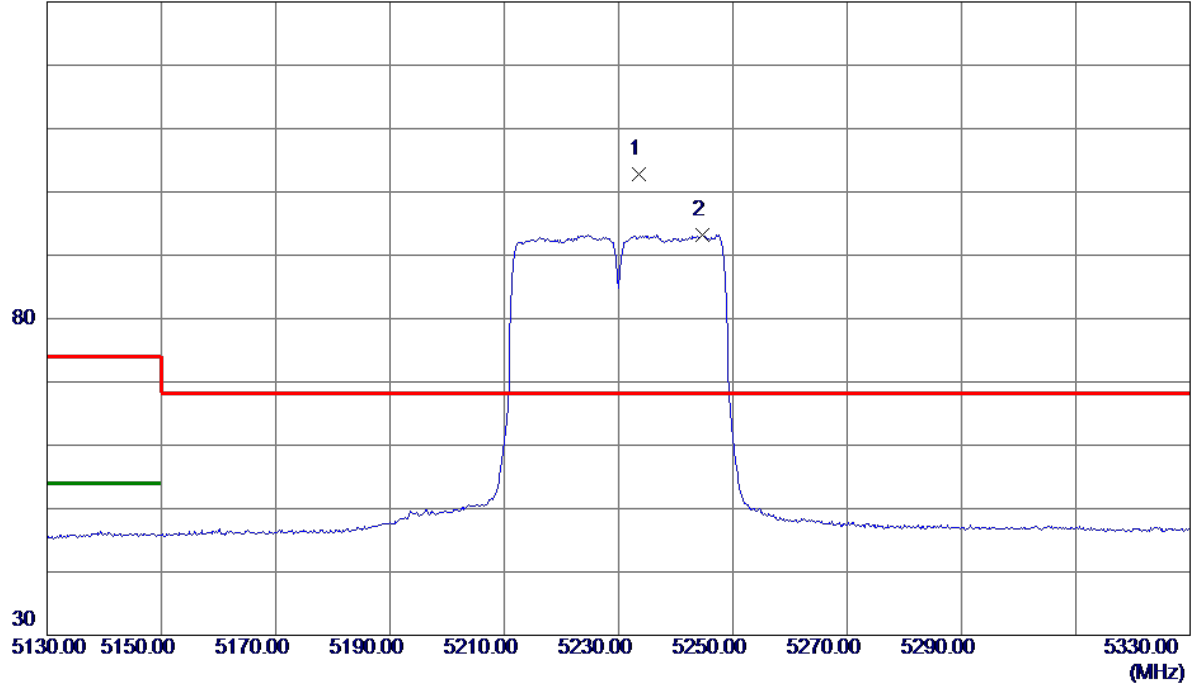

No.	Freq. MHz	Reading Level dBuV/m	Correct Factor dB	Measure ment dBuV/m	Limit dBuV/m	Margin dB	Detector	Comment
1 *	5233.6000	81.55	21.34	102.89	68.30	34.59	Peak	No Limit
2	5244.6000	71.82	21.38	93.20	999.00	-905.80	AVG	No Limit

Orthogonal Axis:	X
Test Mode:	UNII-1/ TX N40 Mode 5230MHz

Horizontal

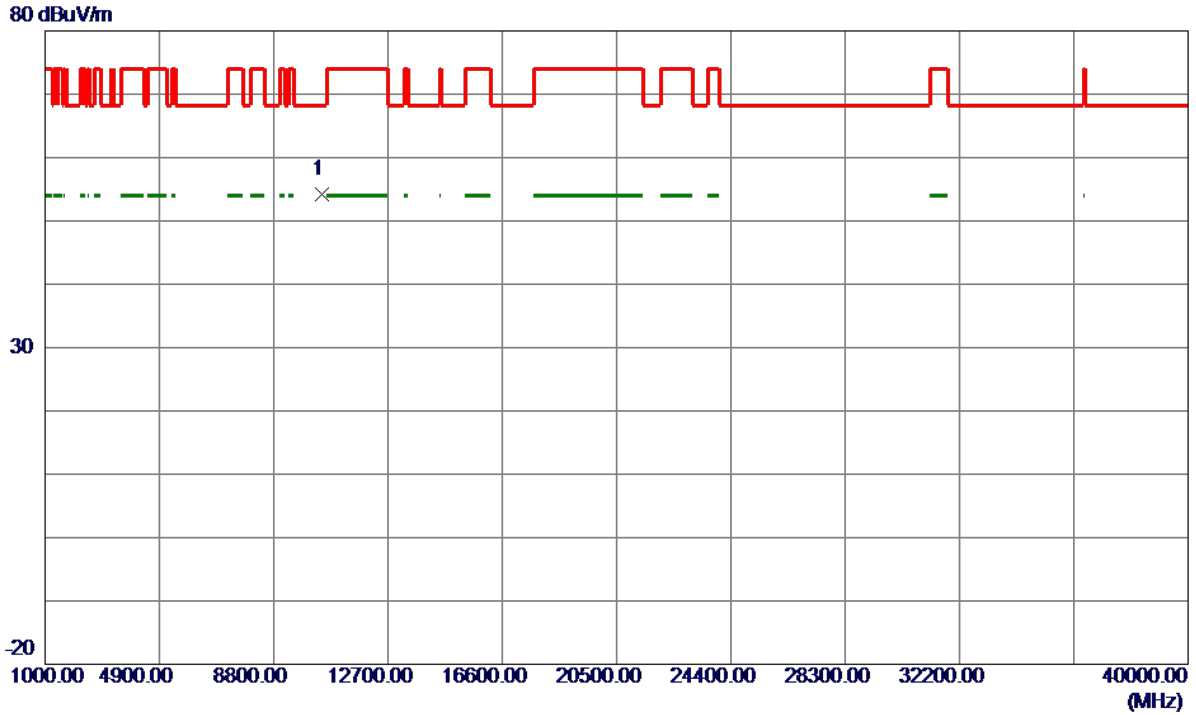

No.	Freq. MHz	Reading Level dBuV/m	Correct Factor dB	Measure ment dBuV/m	Limit dBuV/m	Margin dB	Detector	Comment
1 *	10457.6400	33.73	20.41	54.14	68.30	-14.16	Peak	

Orthogonal Axis :	X
Test Mode :	UNII-2A/ TX A Mode 5260MHz

Vertical

130 dBuV/m

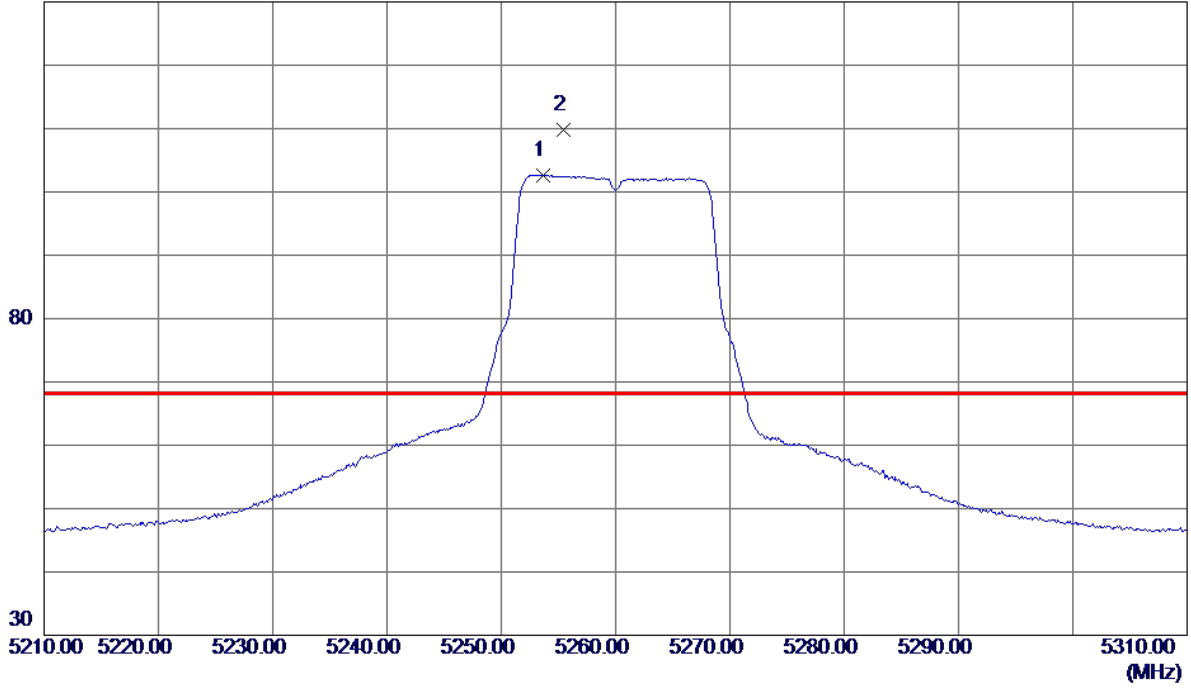

No.	Freq. MHz	Reading Level dBuV/m	Correct Factor dB	Measure ment dBuV/m	Limit dBuV/m	Margin dB	Detector	Comment
1	5253.7000	81.23	21.41	102.64	999.00	-896.36	AVG	No Limit
2 *	5255.4000	88.35	21.41	109.76	68.30	41.46	Peak	No Limit

Orthogonal Axis :	X
Test Mode :	UNII-2A/ TX A Mode 5260MHz

Vertical

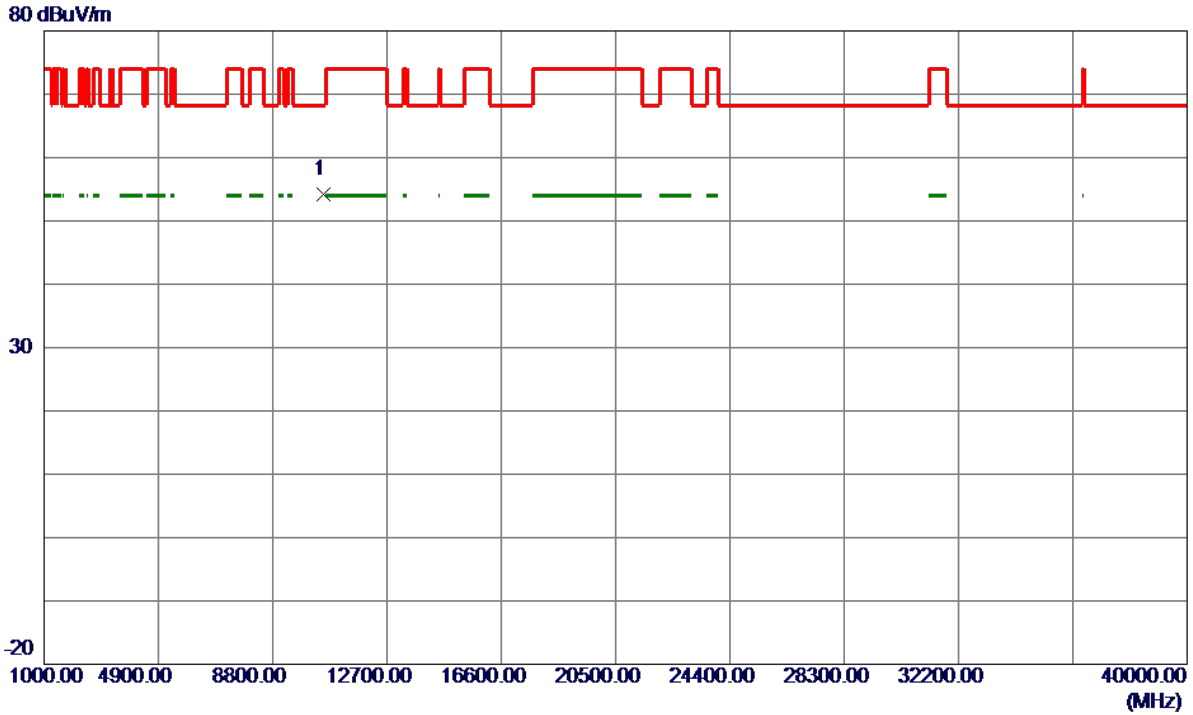

No.	Freq. MHz	Reading Level dBuV/m	Correct Factor dB	Measure ment dBuV/m	Limit dBuV/m	Margin dB	Detector	Comment
1 *	10518.5850	33.78	20.48	54.26	68.30	-14.04	Peak	

Orthogonal Axis :	X
Test Mode :	UNII-2A/ TX A Mode 5260MHz

Horizontal

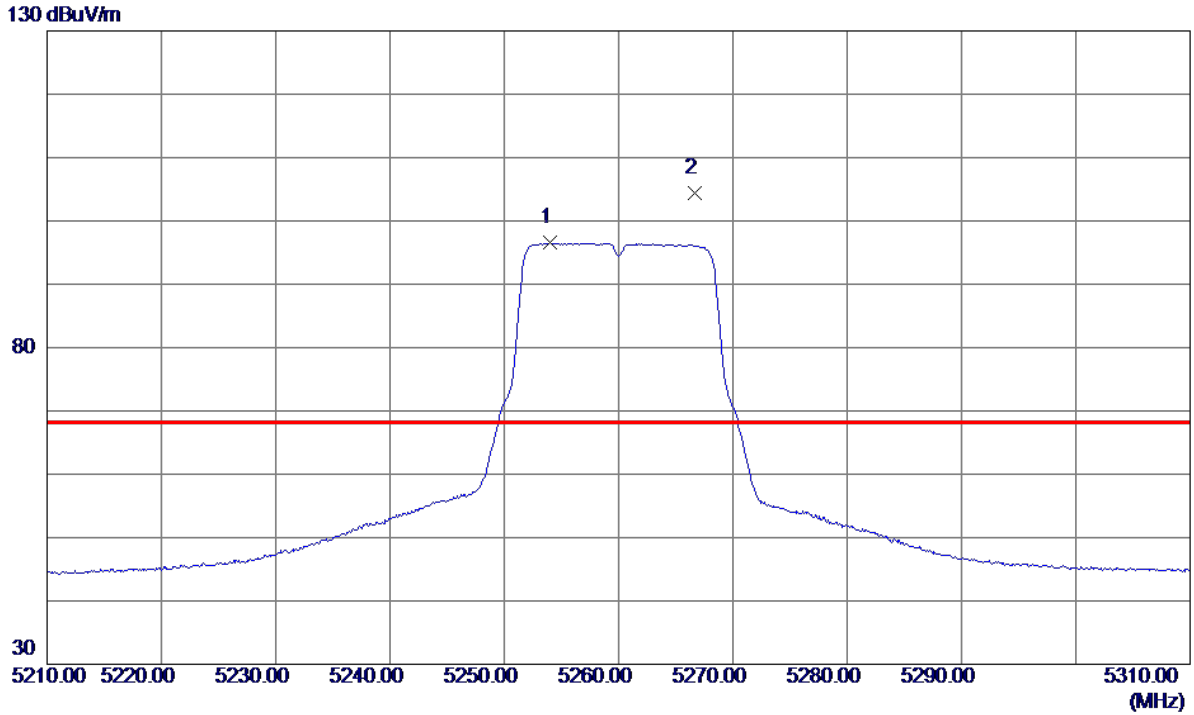

No.	Freq. MHz	Reading Level dBuV/m	Correct Factor dB	Measure ment dBuV/m	Limit dBuV/m	Margin dB	Detector	Comment
1	5254.0000	75.10	21.41	96.51	999.00	-902.49	AVG	No Limit
2 *	5266.7000	82.93	21.46	104.39	68.30	36.09	Peak	No Limit

Orthogonal Axis :	X
Test Mode :	UNII-2A/ TX A Mode 5260MHz

Horizontal

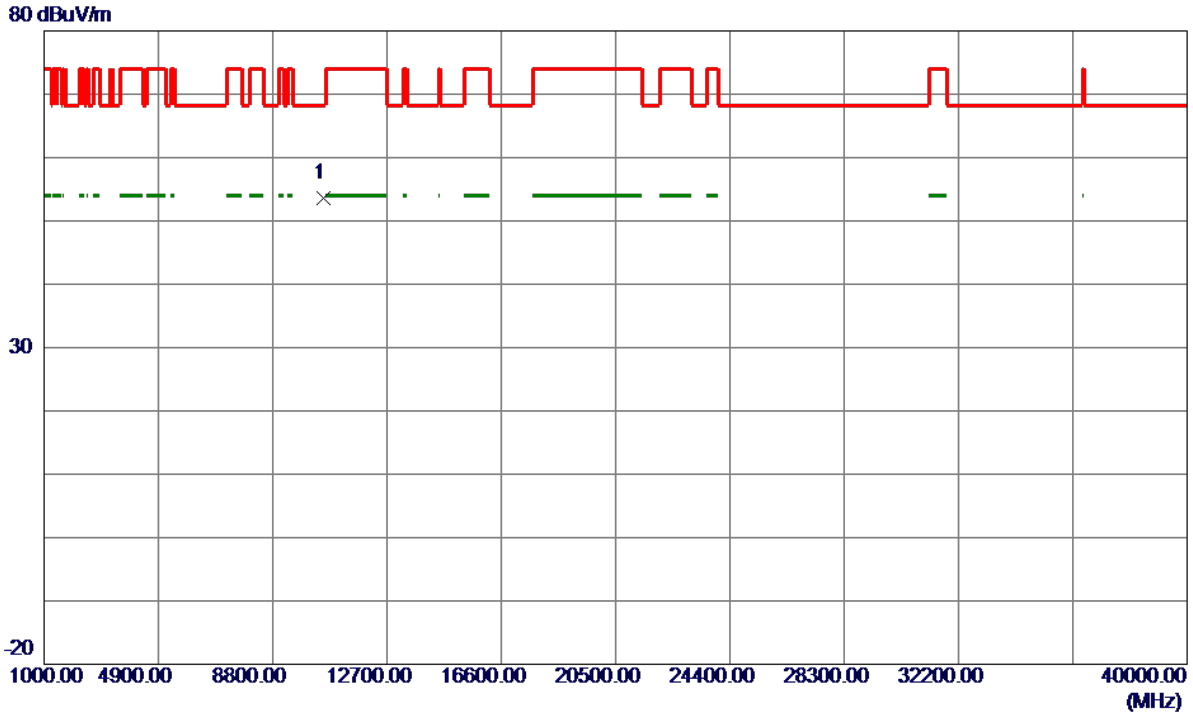

No.	Freq. MHz	Reading Level dBuV/m	Correct Factor dB	Measure ment dBuV/m	Limit dBuV/m	Margin dB	Detector	Comment
1 *	10521.0650	33.19	20.48	53.67	68.30	-14.63	Peak	

Orthogonal Axis :	X
Test Mode :	UNII-2A/ TX A Mode 5300MHz

Vertical

130 dBuV/m

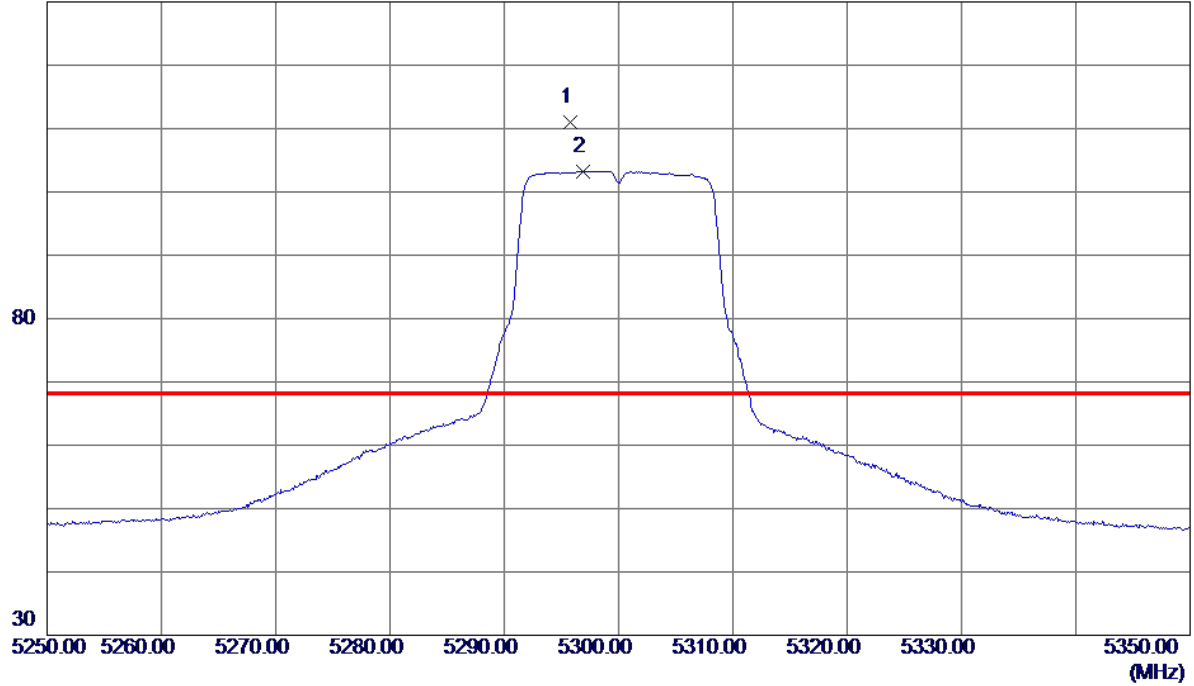

No.	Freq. MHz	Reading Level dBuV/m	Correct Factor dB	Measure ment dBuV/m	Limit dBuV/m	Margin dB	Detector	Comment
1 *	5295.8000	89.50	21.56	111.06	68.30	42.76	Peak	No Limit
2	5296.9000	81.69	21.56	103.25	999.00	-895.75	AVG	No Limit

Orthogonal Axis :	X
Test Mode :	UNII-2A/ TX A Mode 5300MHz

Vertical

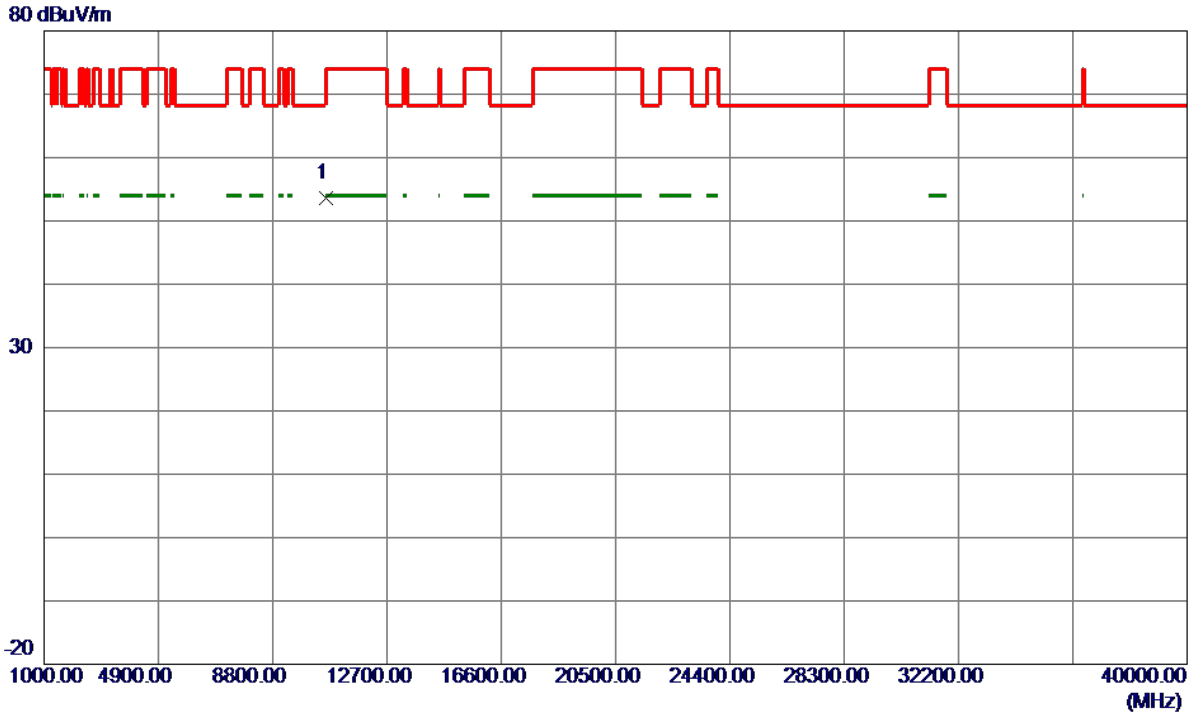

No.	Freq. MHz	Reading Level dBuV/m	Correct Factor dB	Measure ment dBuV/m	Limit dBuV/m	Margin dB	Detector	Comment
1 *	10599.3200	33.10	20.55	53.65	68.30	-14.65	Peak	

Orthogonal Axis :	X
Test Mode :	UNII-2A/ TX A Mode 5300MHz

Horizontal

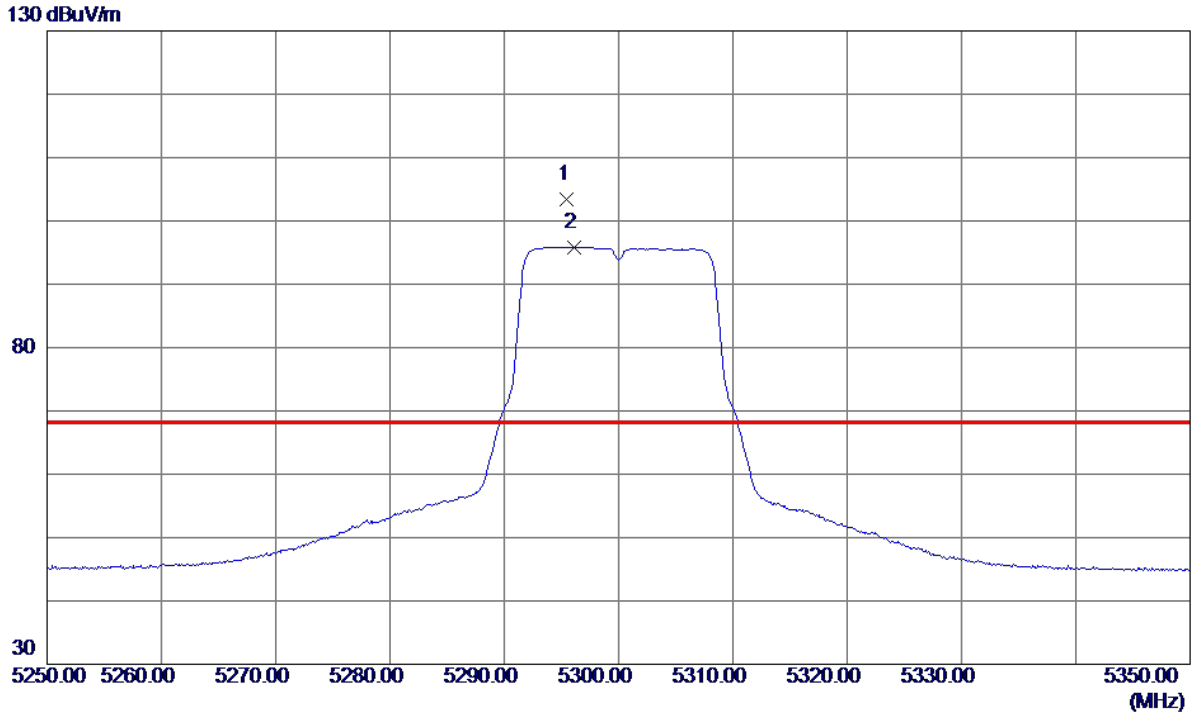

No.	Freq. MHz	Reading Level dBuV/m	Correct Factor dB	Measure ment dBuV/m	Limit dBuV/m	Margin dB	Detector	Comment
1 *	5295.5000	81.80	21.56	103.36	68.30	35.06	Peak	No Limit
2	5296.1000	74.32	21.56	95.88	999.00	-903.12	AVG	No Limit

Orthogonal Axis :	X
Test Mode :	UNII-2A/ TX A Mode 5300MHz

Horizontal

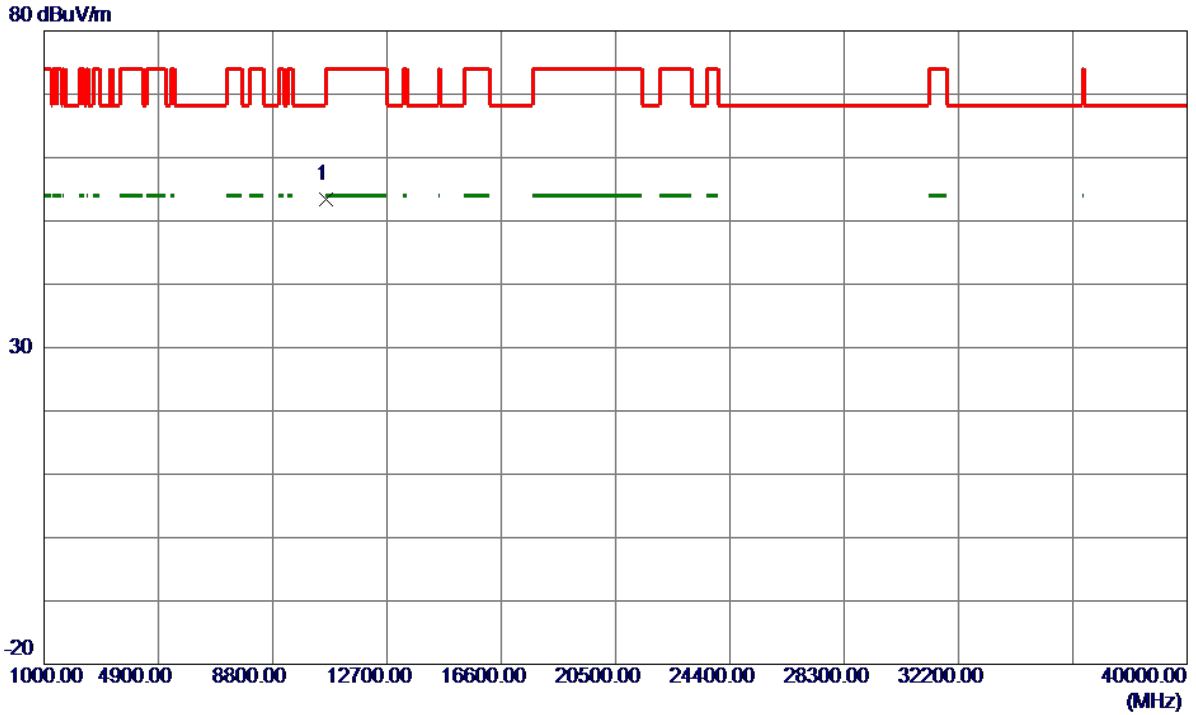

No.	Freq. MHz	Reading Level dBuV/m	Correct Factor dB	Measure ment dBuV/m	Limit dBuV/m	Margin dB	Detector	Comment
1 *	10599.8700	32.83	20.55	53.38	68.30	-14.92	Peak	

Orthogonal Axis :	X
Test Mode :	UNII-2A/ TX A Mode 5320MHz

Vertical

130 dBuV/m

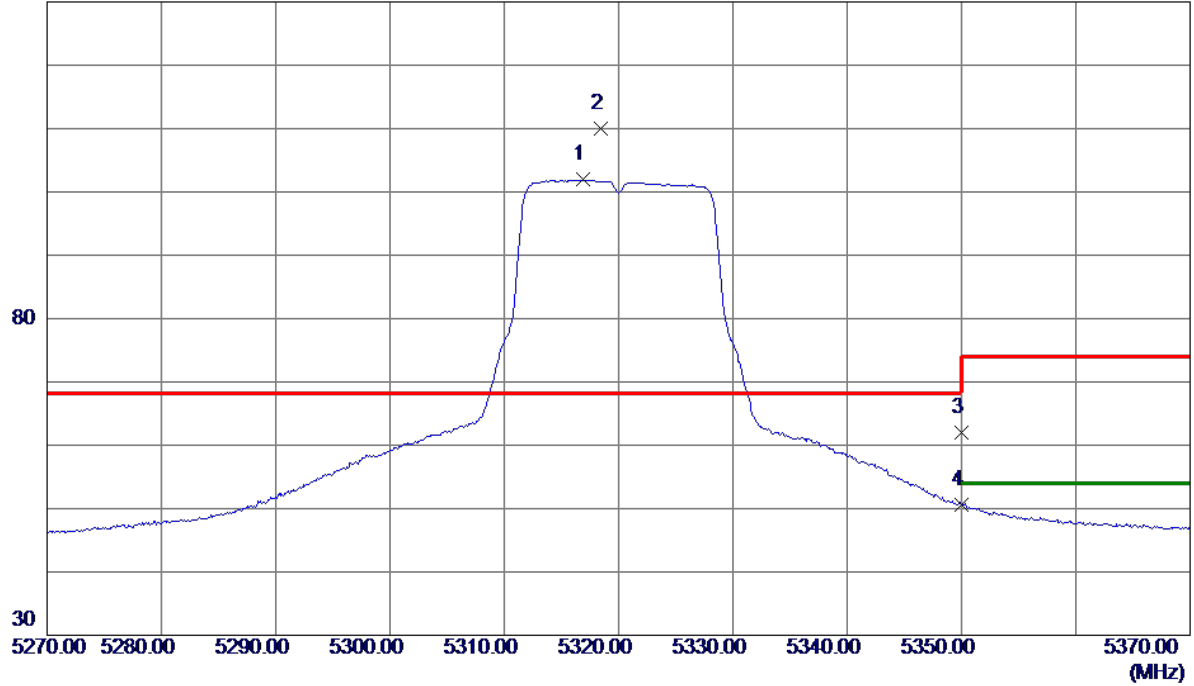

No.	Freq. MHz	Reading Level dBuV/m	Correct Factor dB	Measure ment dBuV/m	Limit dBuV/m	Margin dB	Detector	Comment
1	5316.9000	80.26	21.64	101.90	999.00	-897.10	AVG	No Limit
2 *	5318.4000	88.26	21.64	109.90	68.30	41.60	Peak	No Limit
3	5350.0000	40.26	21.76	62.02	74.00	-11.98	Peak	
4	5350.0000	28.88	21.76	50.64	999.00	-948.36	AVG	

Orthogonal Axis :	X
Test Mode :	UNII-2A/ TX A Mode 5320MHz

Vertical

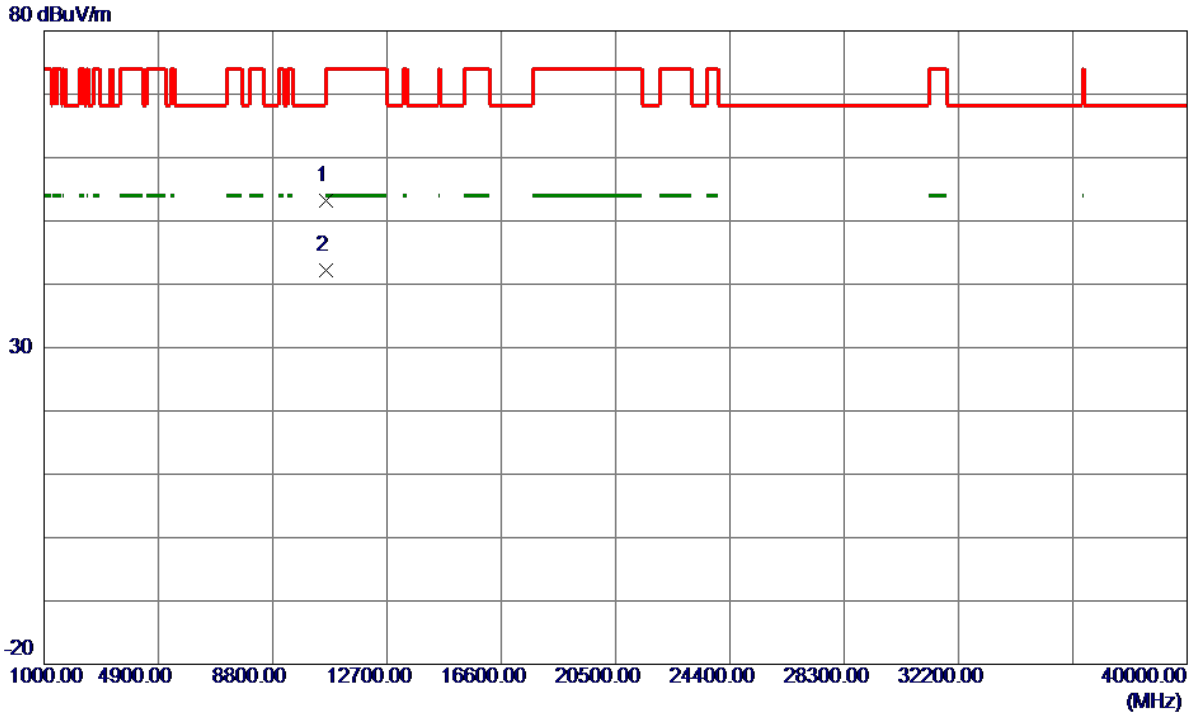

No.	Freq. MHz	Reading Level dBuV/m	Correct Factor dB	Measure ment dBuV/m	Limit dBuV/m	Margin dB	Detector	Comment
1	10638.1950	32.58	20.58	53.16	74.00	-20.84	Peak	
2 *	10640.4750	21.68	20.58	42.26	54.00	-11.74	AVG	

Orthogonal Axis :	X
Test Mode :	UNII-2A/ TX A Mode 5320MHz

Horizontal

130 dBuV/m

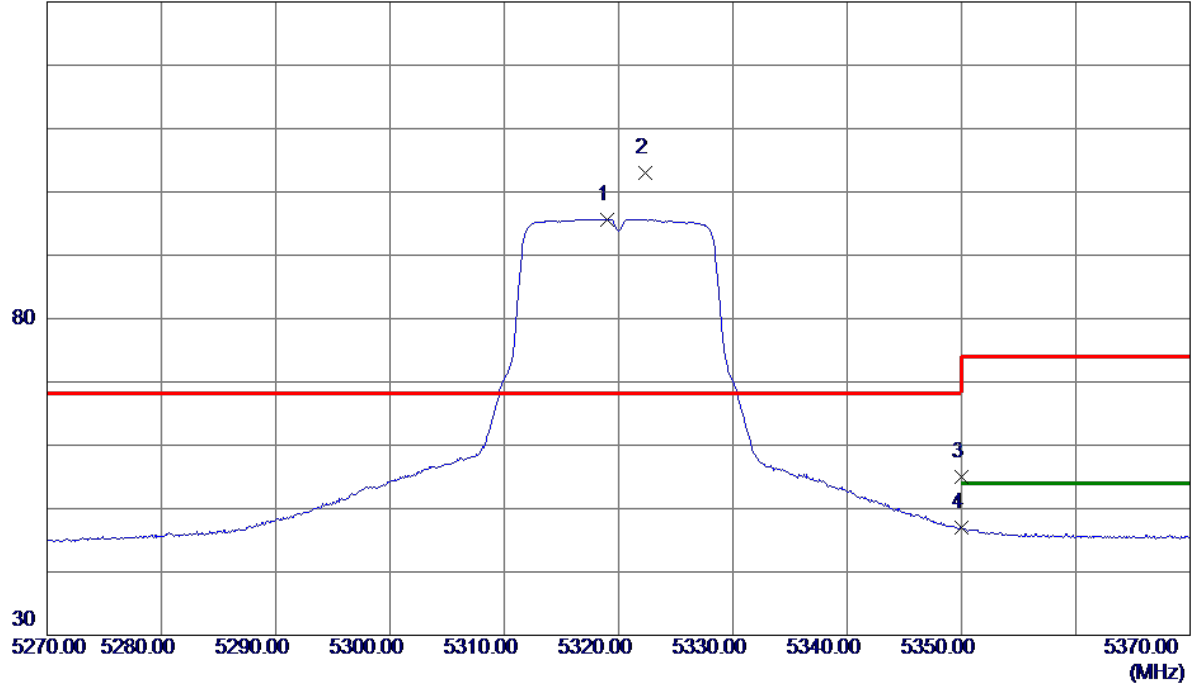

No.	Freq. MHz	Reading Level dBuV/m	Correct Factor dB	Measure ment dBuV/m	Limit dBuV/m	Margin dB	Detector	Comment
1	5319.0000	74.05	21.64	95.69	999.00	-903.31	AVG	No Limit
2 *	5322.3000	81.42	21.66	103.08	68.30	34.78	Peak	No Limit
3	5350.0000	33.17	21.76	54.93	74.00	-19.07	Peak	
4	5350.0000	25.24	21.76	47.00	999.00	-952.00	AVG	

Orthogonal Axis :	X
Test Mode :	UNII-2A/ TX A Mode 5320MHz

Horizontal

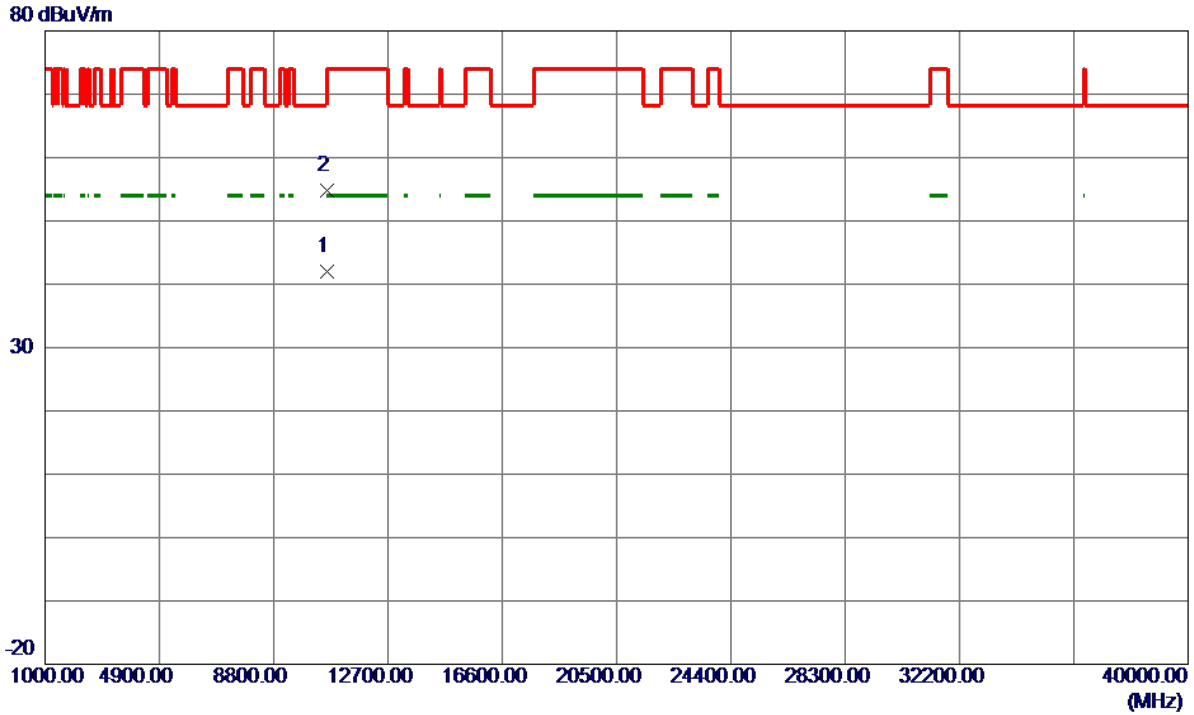

No.	Freq. MHz	Reading Level dBuV/m	Correct Factor dB	Measure ment dBuV/m	Limit dBuV/m	Margin dB	Detector	Comment
1 *	10640.5250	21.51	20.58	42.09	54.00	-11.91	AVG	
2	10641.5300	34.23	20.58	54.81	74.00	-19.19	Peak	

Orthogonal Axis :	X
Test Mode :	UNII-2A/ TX N20 Mode 5260MHz

Vertical

130 dBuV/m

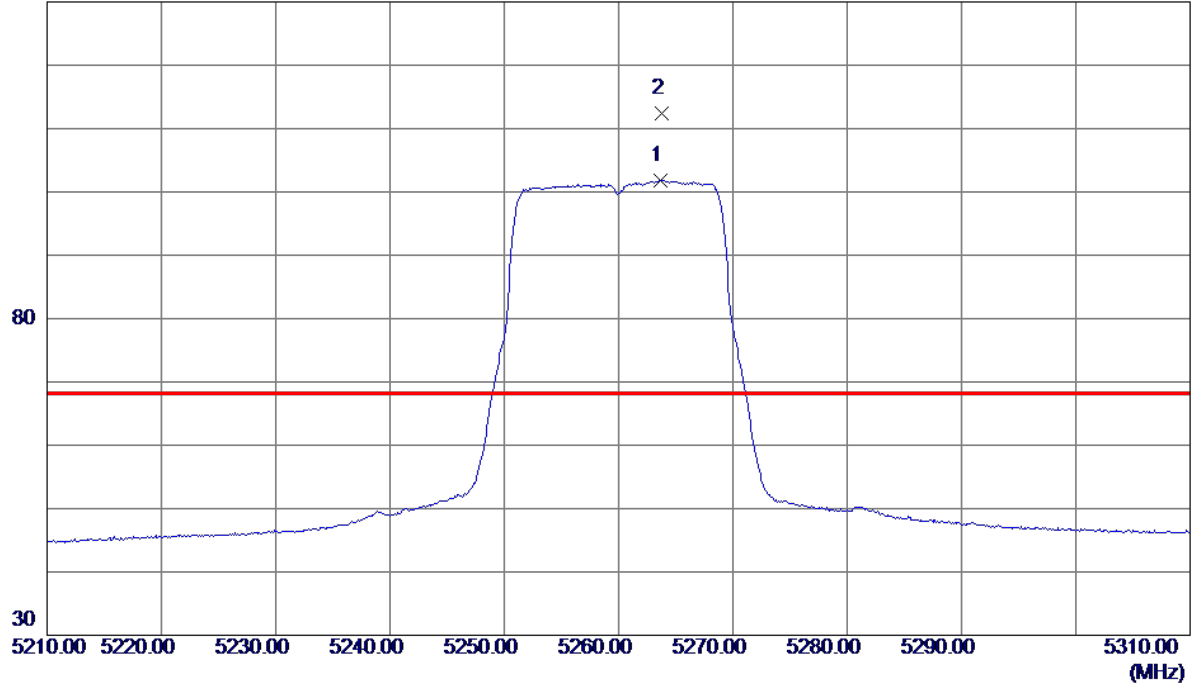

No.	Freq. MHz	Reading Level dBuV/m	Correct Factor dB	Measure ment dBuV/m	Limit dBuV/m	Margin dB	Detector	Comment
1	5263.7000	80.34	21.44	101.78	999.00	-897.22	AVG	No Limit
2 *	5263.8000	90.95	21.44	112.39	68.30	44.09	Peak	No Limit

Orthogonal Axis :	X
Test Mode :	UNII-2A/ TX N20 Mode 5260MHz

Vertical

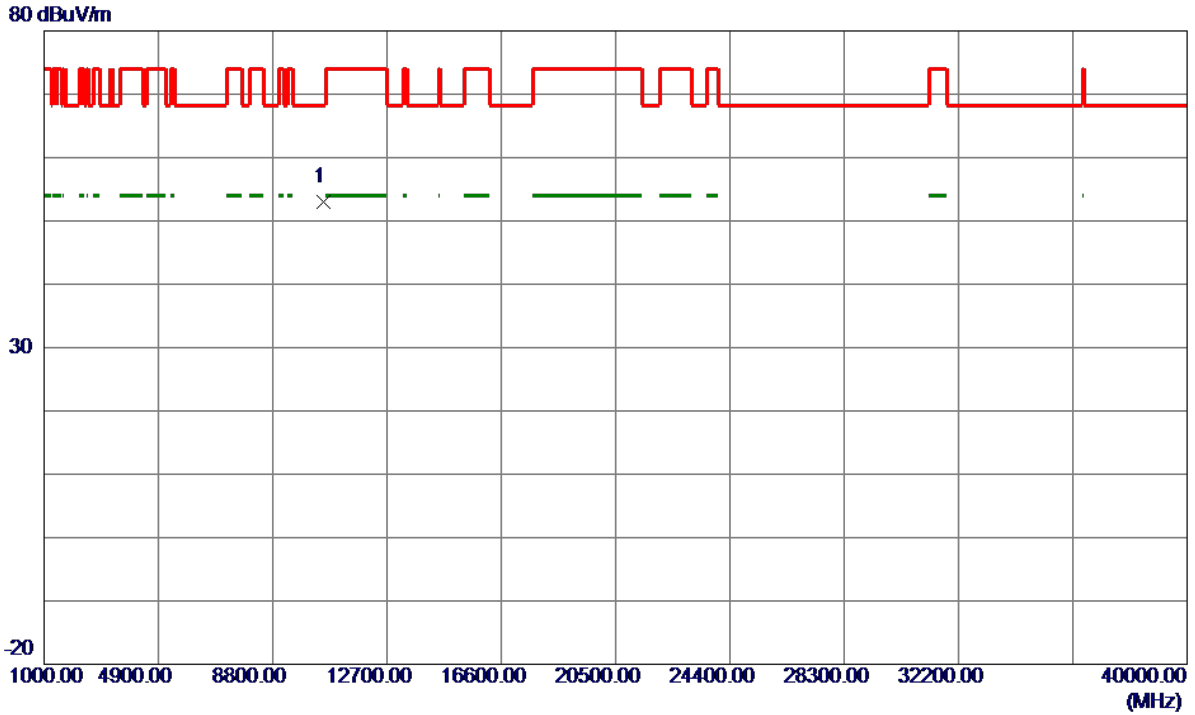

No.	Freq. MHz	Reading Level dBuV/m	Correct Factor dB	Measure ment dBuV/m	Limit dBuV/m	Margin dB	Detector	Comment
1 *	10519.9450	32.49	20.48	52.97	68.30	-15.33	Peak	

Orthogonal Axis :	X
Test Mode :	UNII-2A/ TX N20 Mode 5260MHz

Horizontal

130 dBuV/m

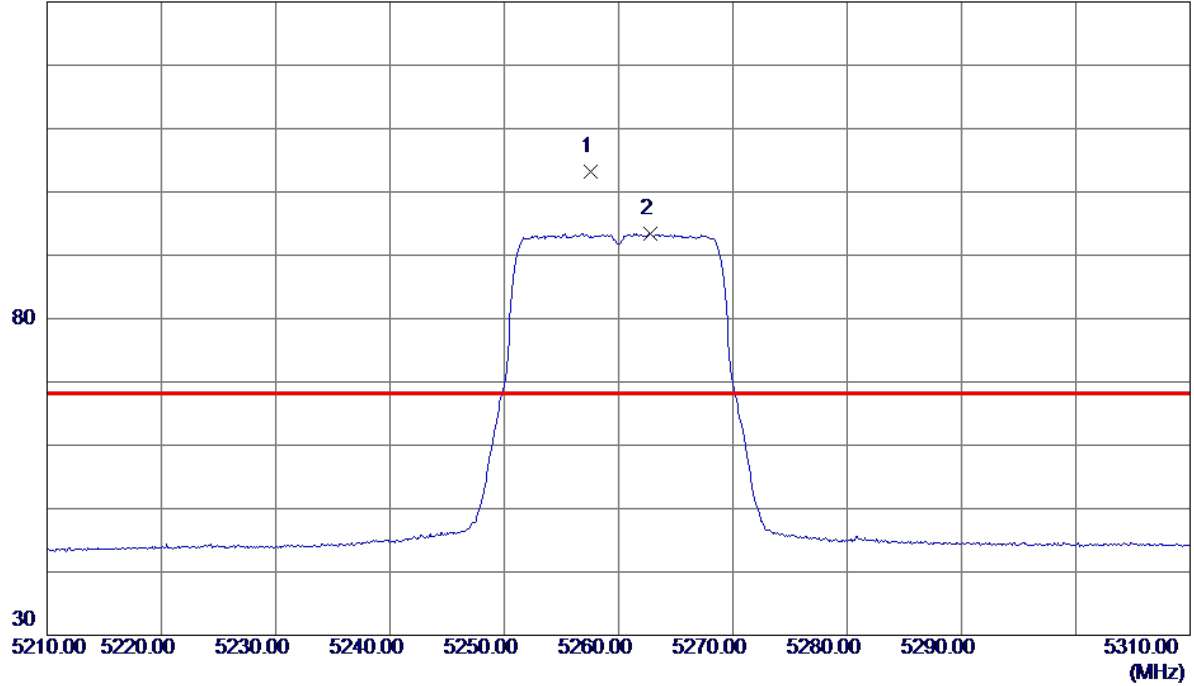

No.	Freq. MHz	Reading Level dBuV/m	Correct Factor dB	Measure ment dBuV/m	Limit dBuV/m	Margin dB	Detector	Comment
1 *	5257.6000	81.87	21.42	103.29	68.30	34.99	Peak	No Limit
2	5262.8000	72.03	21.44	93.47	999.00	-905.53	AVG	No Limit

Orthogonal Axis :	X
Test Mode :	UNII-2A/ TX N20 Mode 5260MHz

Horizontal

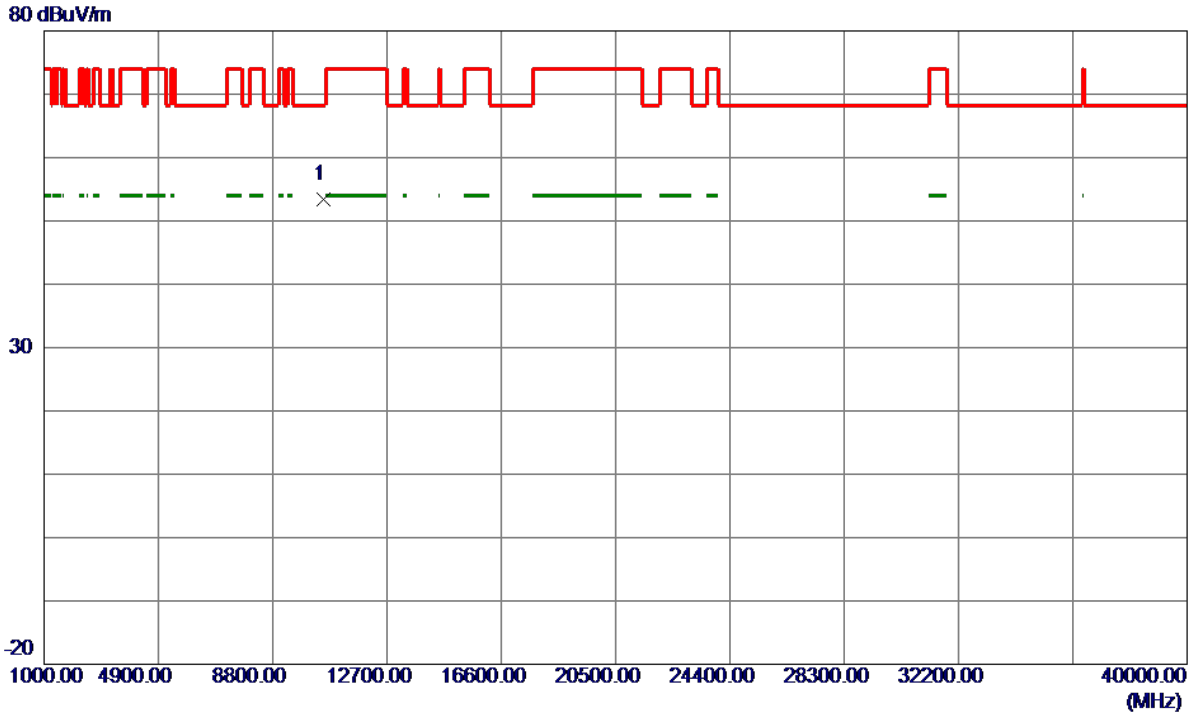

No.	Freq. MHz	Reading Level dBuV/m	Correct Factor dB	Measure ment dBuV/m	Limit dBuV/m	Margin dB	Detector	Comment
1 *	10522.2400	32.96	20.48	53.44	68.30	-14.86	Peak	

Orthogonal Axis :	X
Test Mode :	UNII-2A/ TX N20 Mode 5300MHz

Vertical

130 dBuV/m

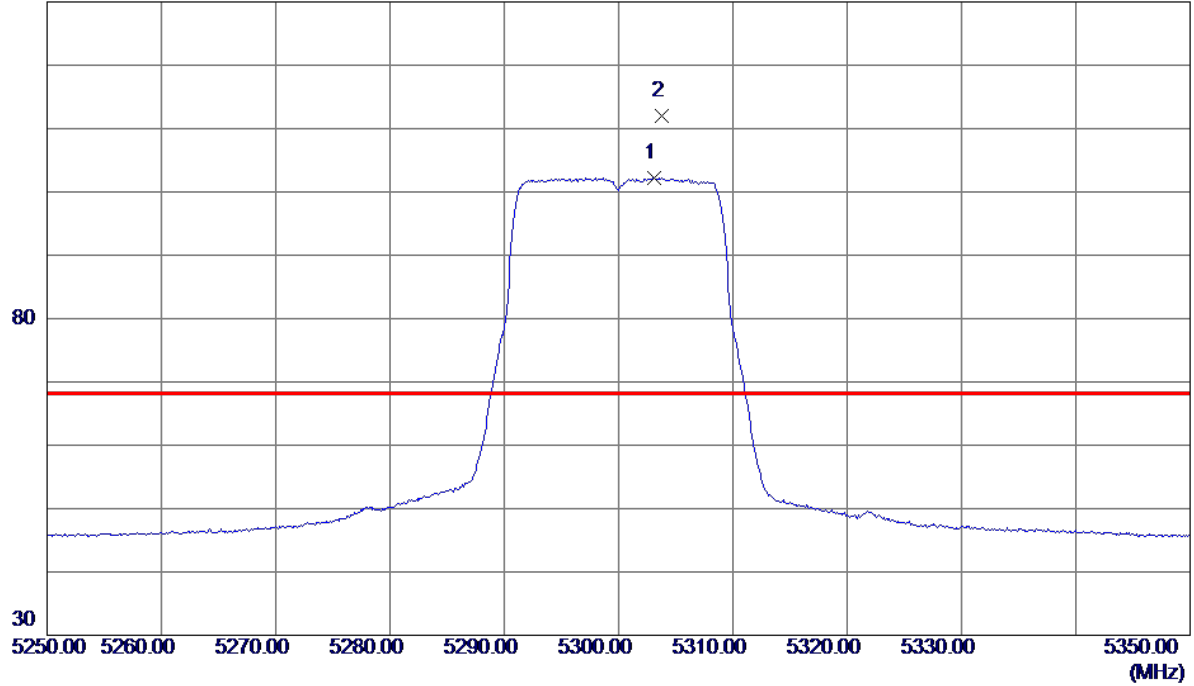

No.	Freq. MHz	Reading Level dBuV/m	Correct Factor dB	Measure ment dBuV/m	Limit dBuV/m	Margin dB	Detector	Comment
1	5303.1000	80.65	21.59	102.24	999.00	-896.76	AVG	No Limit
2 *	5303.8000	90.43	21.59	112.02	68.30	43.72	Peak	No Limit

Orthogonal Axis :	X
Test Mode :	UNII-2A/ TX N20 Mode 5300MHz

Vertical

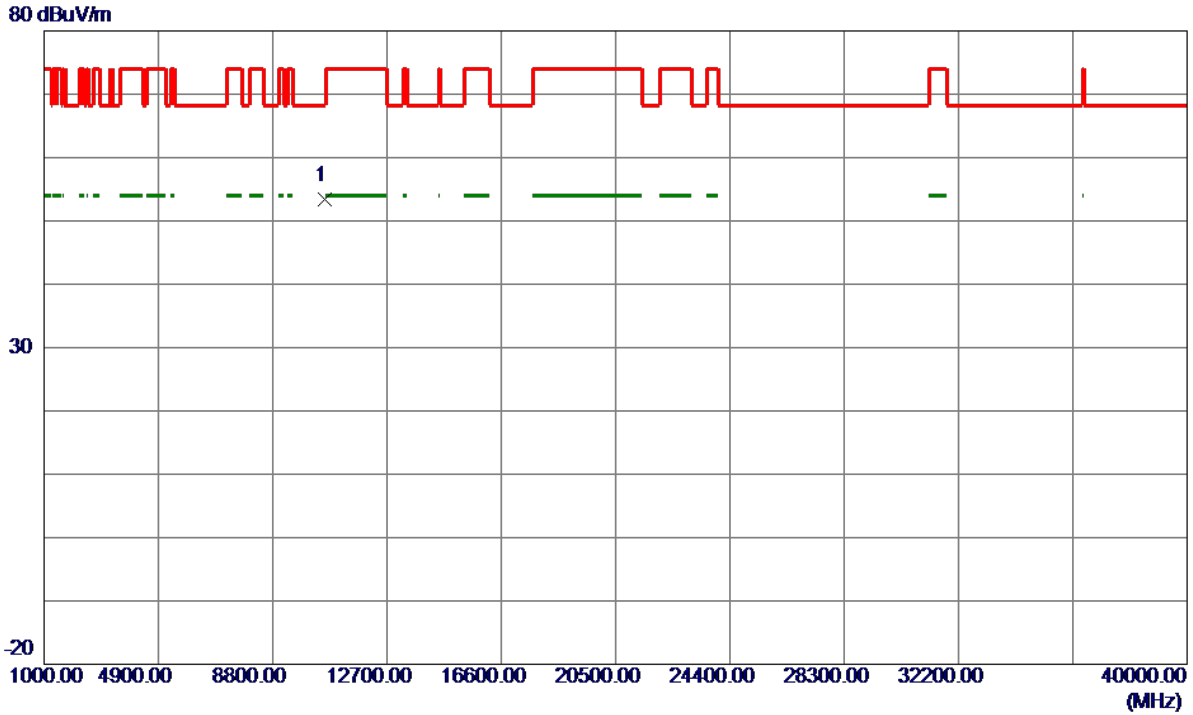

No.	Freq. MHz	Reading Level dBuV/m	Correct Factor dB	Measure ment dBuV/m	Limit dBuV/m	Margin dB	Detector	Comment
1 *	10597.5199	32.75	20.55	53.30	68.30	-15.00	Peak	

Orthogonal Axis :	X
Test Mode :	UNII-2A/ TX N20 Mode 5300MHz

Horizontal

130 dBuV/m

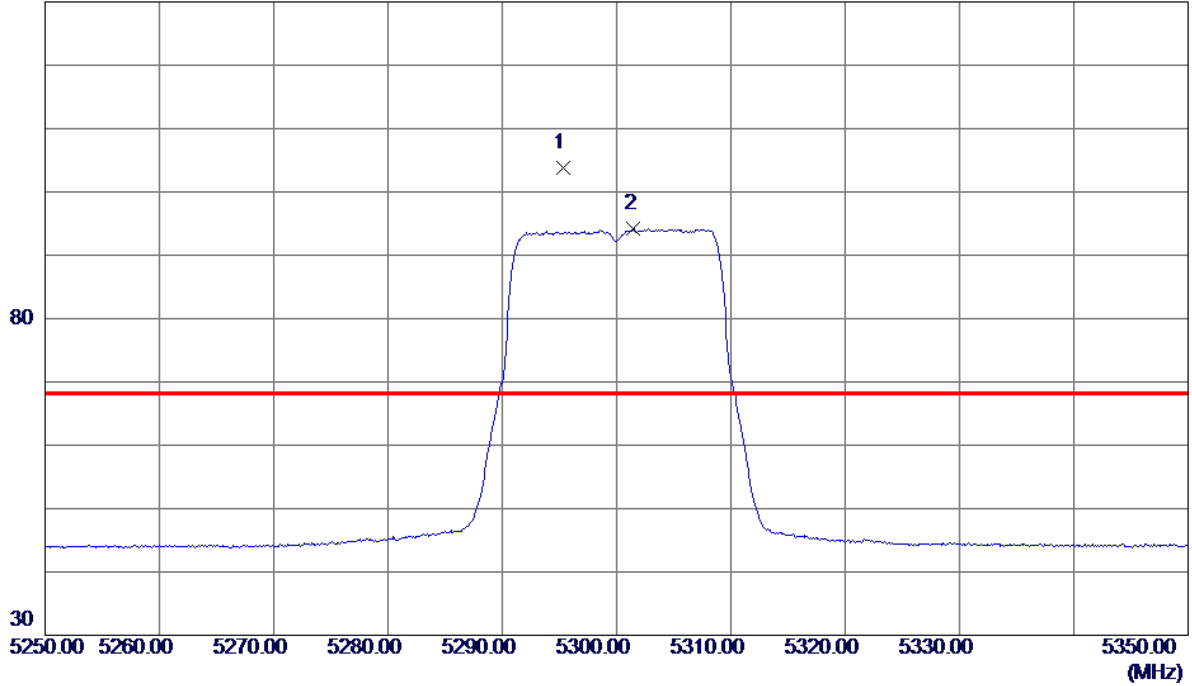

No.	Freq. MHz	Reading Level dBuV/m	Correct Factor dB	Measure ment dBuV/m	Limit dBuV/m	Margin dB	Detector	Comment
1 *	5295.3000	82.18	21.56	103.74	68.30	35.44	Peak	No Limit
2	5301.5000	72.66	21.58	94.24	999.00	-904.76	AVG	No Limit

Orthogonal Axis :	X
Test Mode :	UNII-2A/ TX N20 Mode 5300MHz

Horizontal

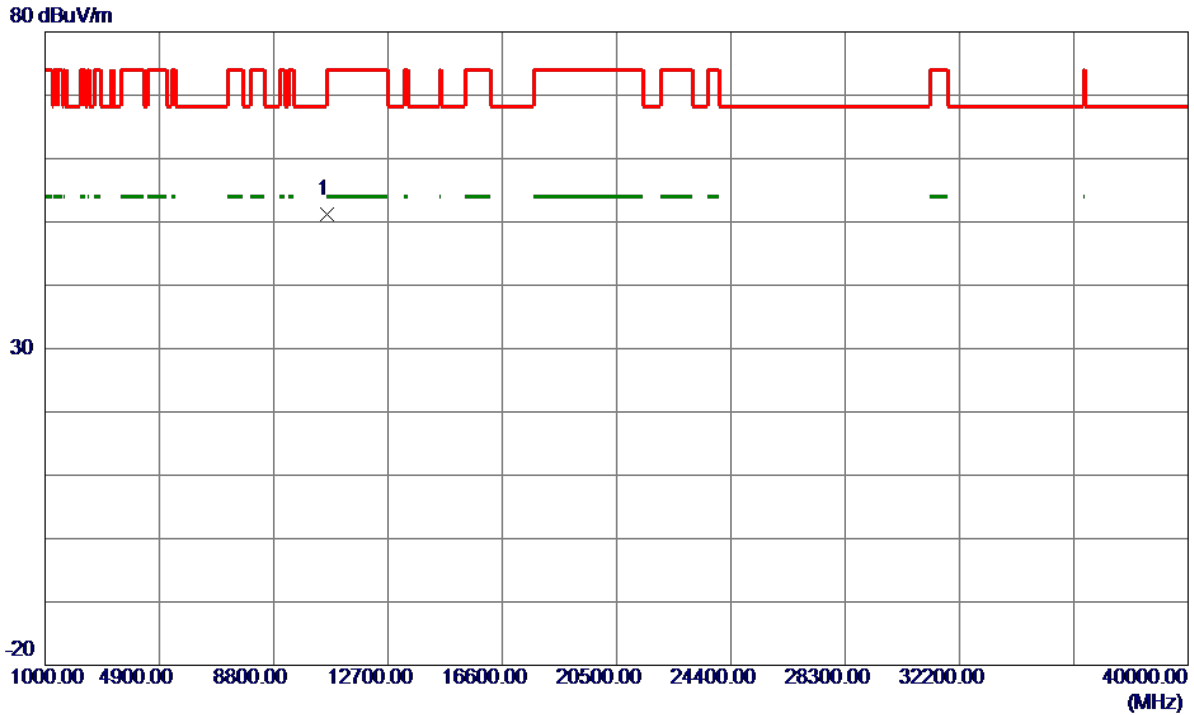

No.	Freq. MHz	Reading Level dBuV/m	Correct Factor dB	Measure ment dBuV/m	Limit dBuV/m	Margin dB	Detector	Comment
1 *	10599.5150	30.63	20.55	51.18	68.30	-17.12	Peak	

Orthogonal Axis :	X
Test Mode :	UNII-2A/ TX N20 Mode 5320MHz

Vertical

130 dBuV/m

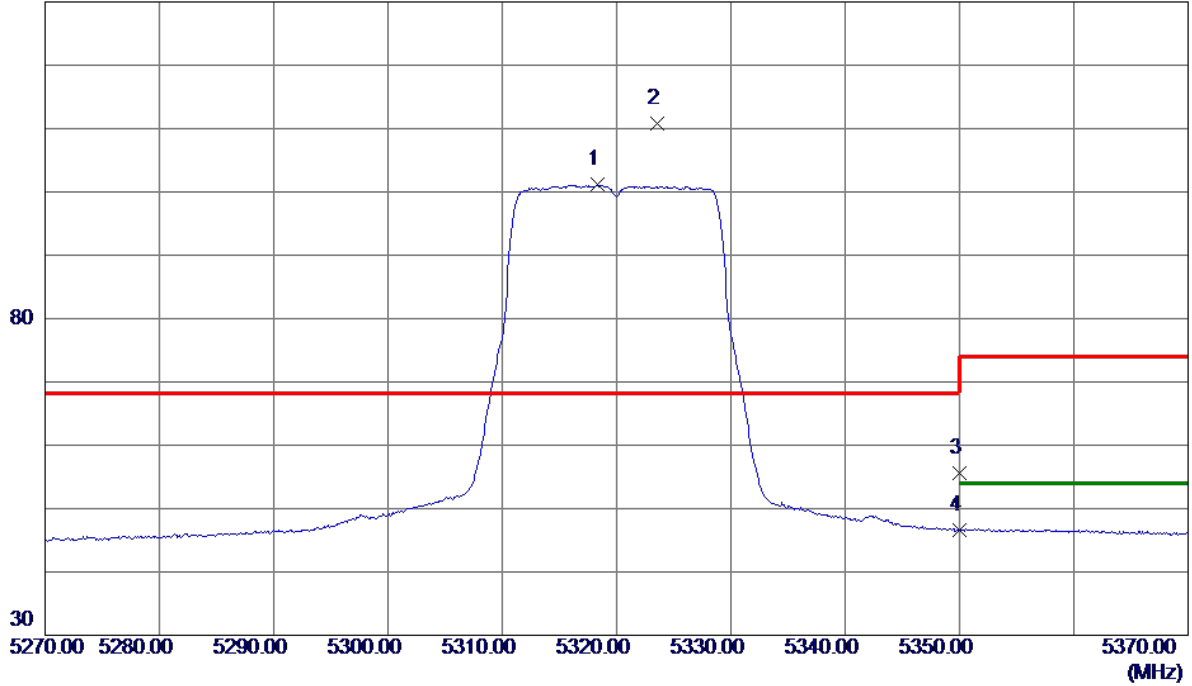

No.	Freq. MHz	Reading Level dBuV/m	Correct Factor dB	Measure ment dBuV/m	Limit dBuV/m	Margin dB	Detector	Comment
1	5318.3000	79.48	21.64	101.12	999.00	-897.88	AVG	No Limit
2 *	5323.6000	89.05	21.66	110.71	68.30	42.41	Peak	No Limit
3	5350.0000	33.77	21.76	55.53	74.00	-18.47	Peak	
4	5350.0000	24.85	21.76	46.61	999.00	-952.39	AVG	

Orthogonal Axis :	X
Test Mode :	UNII-2A/ TX N20 Mode 5320MHz

Vertical

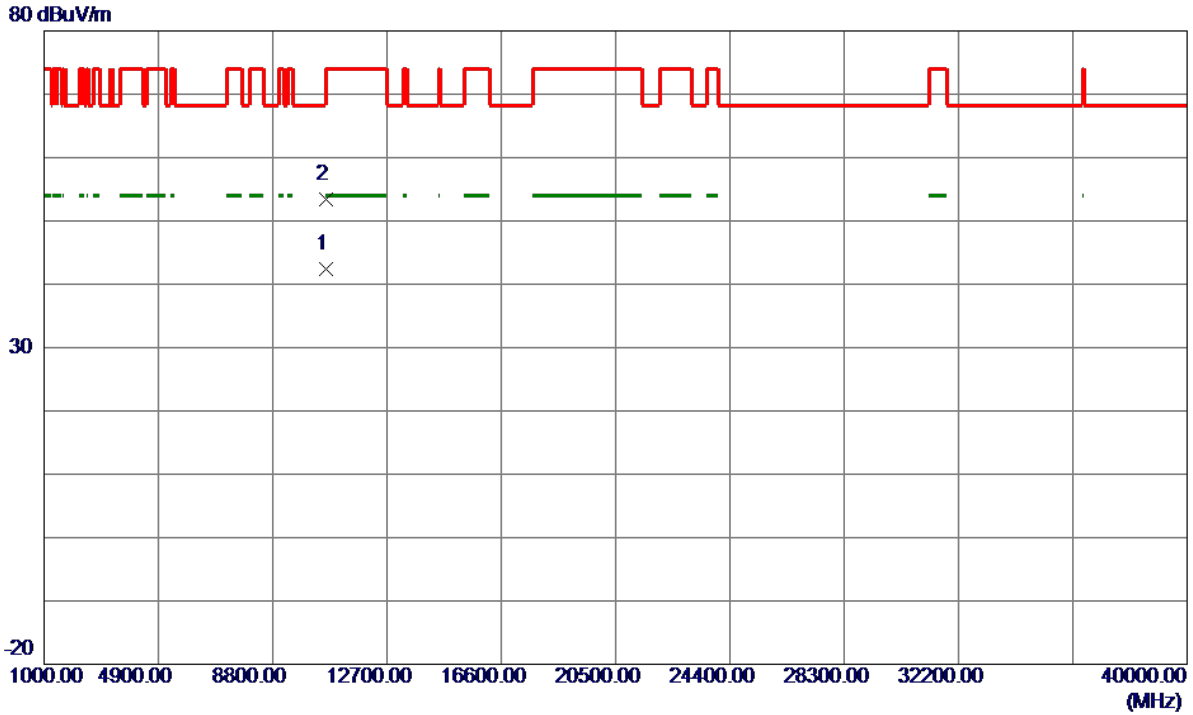

No.	Freq. MHz	Reading Level dBuV/m	Correct Factor dB	Measurement dBuV/m	Limit dBuV/m	Margin dB	Detector	Comment
1 *	10638.7650	21.73	20.58	42.31	54.00	-11.69	AVG	
2	10639.9050	32.73	20.58	53.31	74.00	-20.69	Peak	

Orthogonal Axis :	X
Test Mode :	UNII-2A/ TX N20 Mode 5320MHz

Horizontal

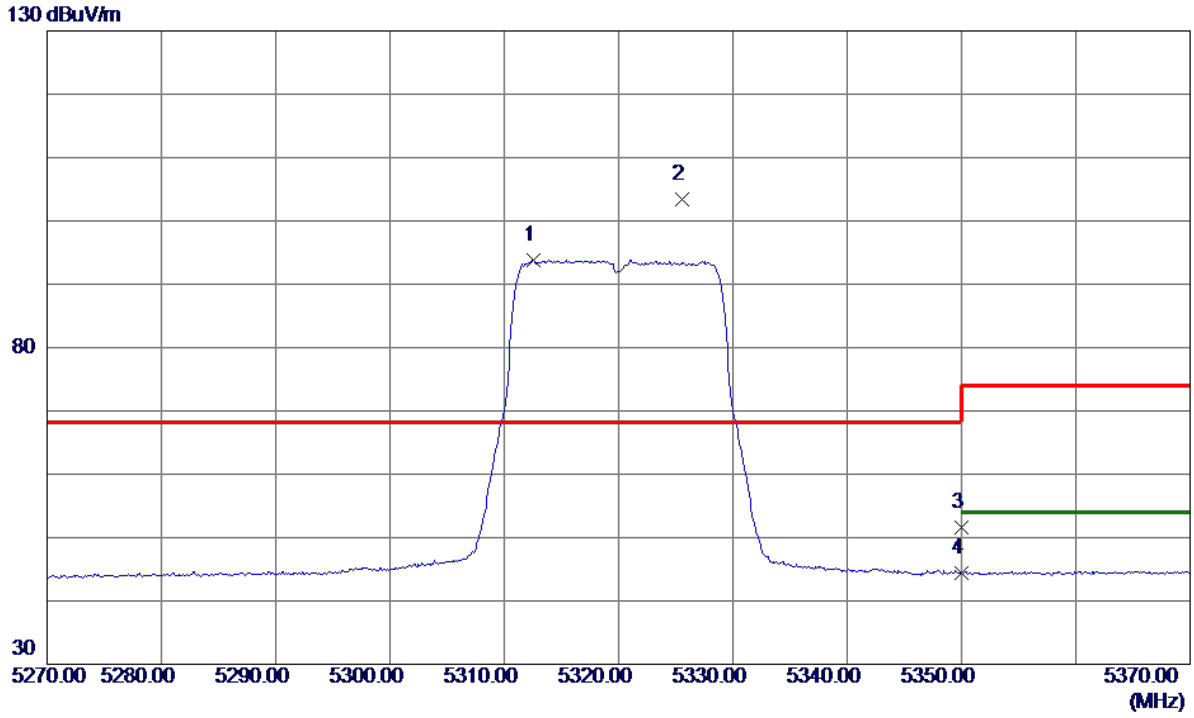

No.	Freq. MHz	Reading Level dBuV/m	Correct Factor dB	Measure ment dBuV/m	Limit dBuV/m	Margin dB	Detector	Comment
1	5312.6000	72.15	21.62	93.77	999.00	-905.23	AVG	No Limit
2 *	5325.6000	81.82	21.67	103.49	68.30	35.19	Peak	No Limit
3	5350.0000	29.76	21.76	51.52	74.00	-22.48	Peak	
4	5350.0000	22.58	21.76	44.34	999.00	-954.66	AVG	

Orthogonal Axis :	X
Test Mode :	UNII-2A/ TX N20 Mode 5320MHz

Horizontal

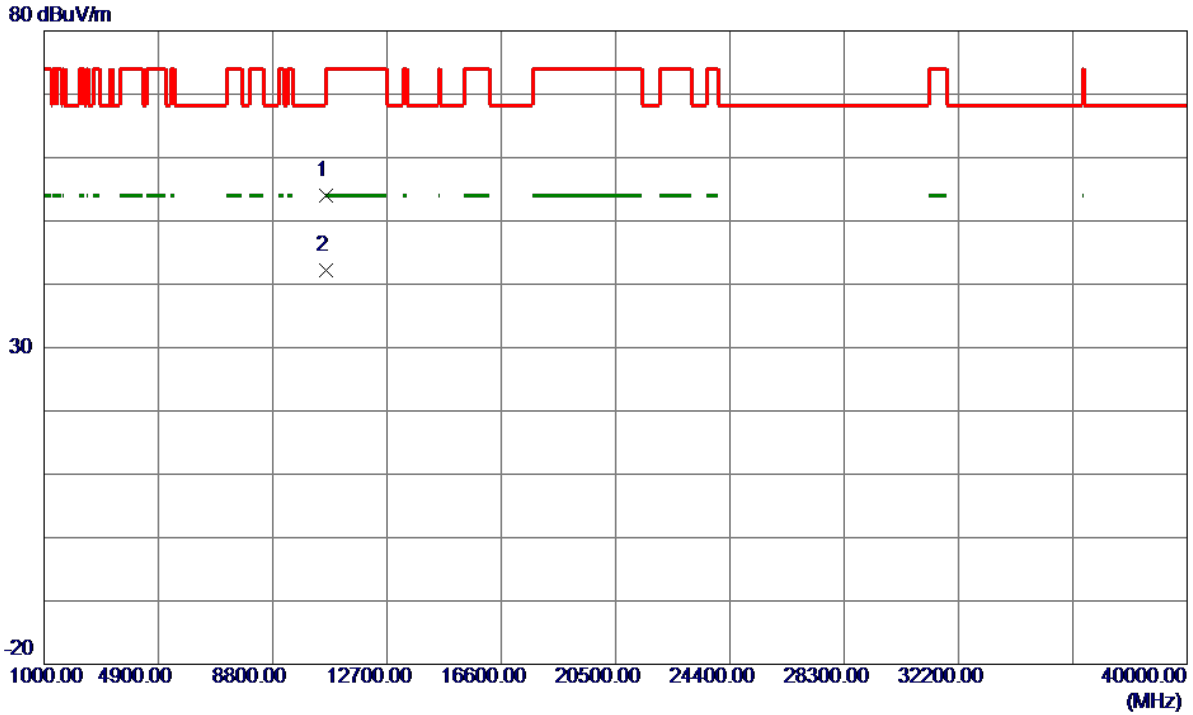

No.	Freq. MHz	Reading Level dBuV/m	Correct Factor dB	Measure ment dBuV/m	Limit dBuV/m	Margin dB	Detector	Comment
1	10638.6000	33.35	20.58	53.93	74.00	-20.07	Peak	
2 *	10638.8550	21.56	20.58	42.14	54.00	-11.86	AVG	

Orthogonal Axis :	X
Test Mode :	UNII-2A/ TX N40 Mode 5270MHz

Vertical

130 dBuV/m

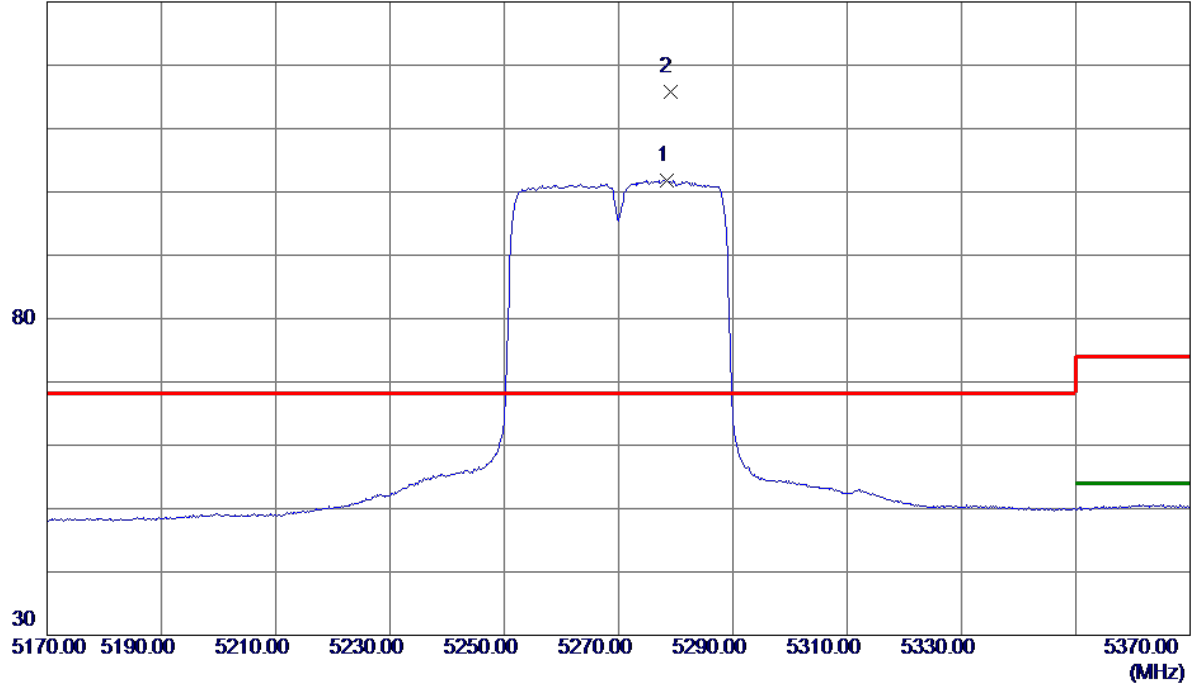

No.	Freq. MHz	Reading Level dBuV/m	Correct Factor dB	Measure ment dBuV/m	Limit dBuV/m	Margin dB	Detector	Comment
1	5278.4000	80.29	21.50	101.79	999.00	-897.21	AVG	No Limit
2 *	5279.0000	94.29	21.50	115.79	68.30	47.49	Peak	No Limit

Orthogonal Axis :	X
Test Mode :	UNII-2A/ TX N40 Mode 5270MHz

Vertical

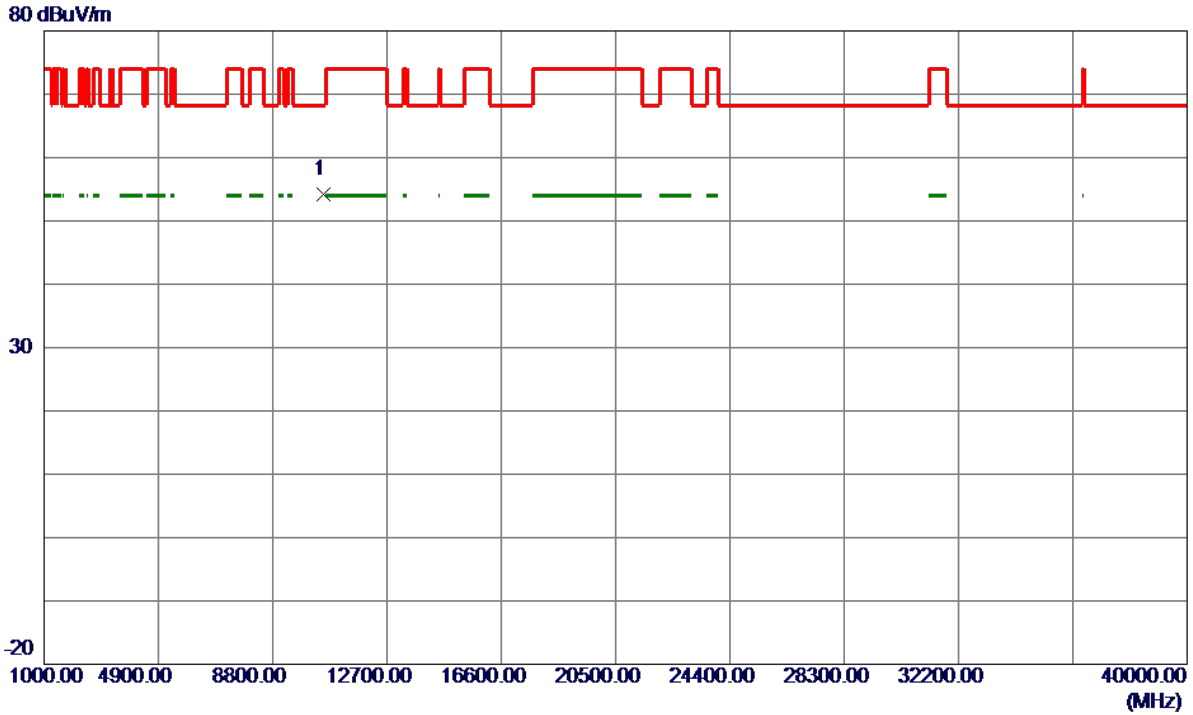

No.	Freq. MHz	Reading Level dBuV/m	Correct Factor dB	Measure ment dBuV/m	Limit dBuV/m	Margin dB	Detector	Comment
1 *	10537.4900	33.68	20.50	54.18	68.30	-14.12	Peak	

Orthogonal Axis :	X
Test Mode :	UNII-2A/ TX N40 Mode 5270MHz

Horizontal

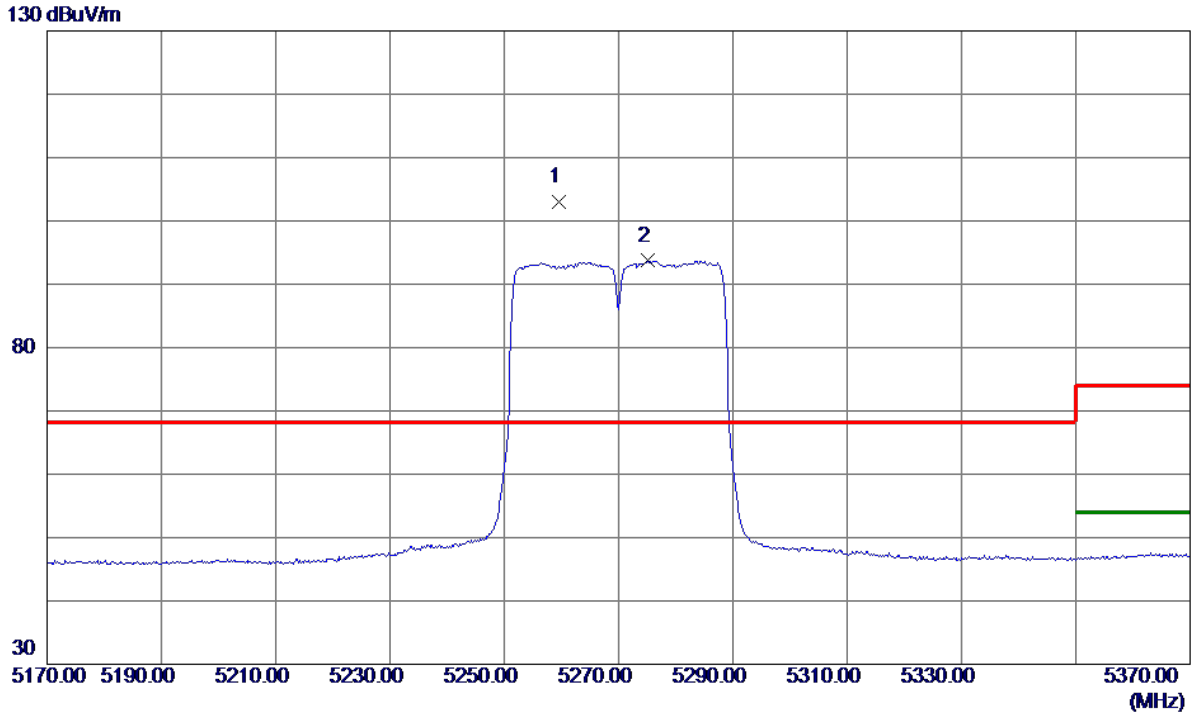

No.	Freq. MHz	Reading Level dBuV/m	Correct Factor dB	Measure ment dBuV/m	Limit dBuV/m	Margin dB	Detector	Comment
1 *	5259.6000	81.53	21.43	102.96	68.30	34.66	Peak	No Limit
2	5275.2000	72.21	21.49	93.70	999.00	-905.30	AVG	No Limit

Orthogonal Axis :	X
Test Mode :	UNII-2A/ TX N40 Mode 5270MHz

Horizontal

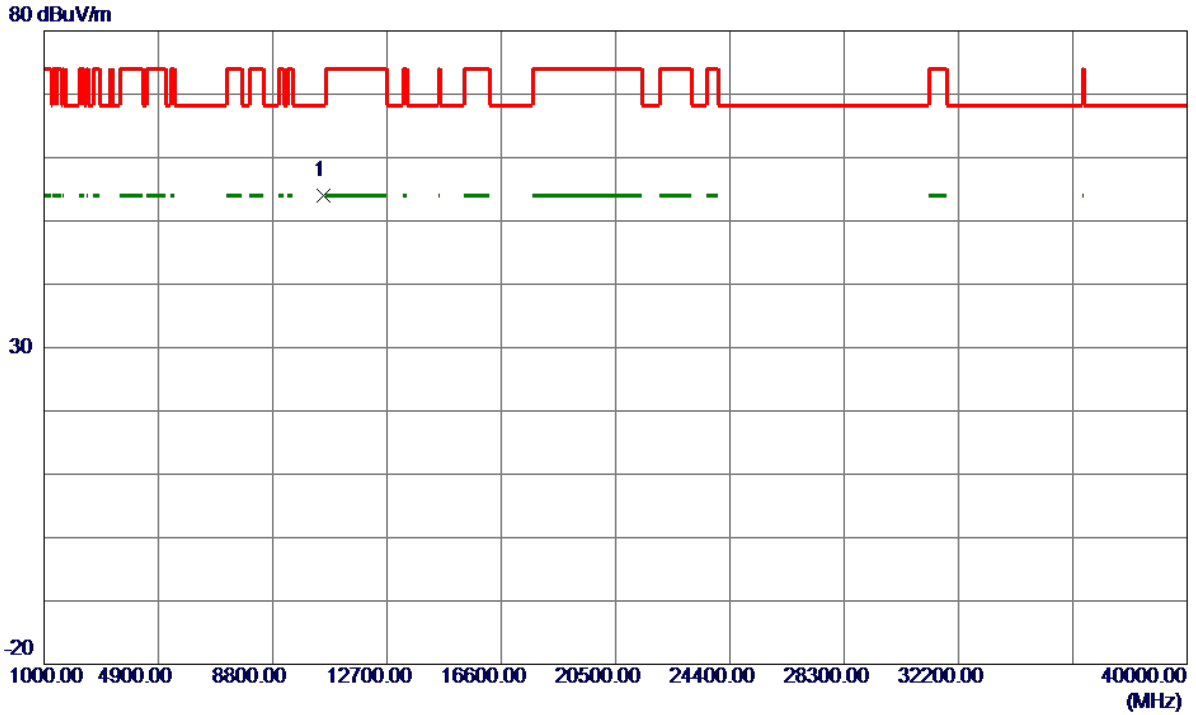

No.	Freq. MHz	Reading Level dBuV/m	Correct Factor dB	Measure ment dBuV/m	Limit dBuV/m	Margin dB	Detector	Comment
1 *	10535.1100	33.43	20.49	53.92	68.30	-14.38	Peak	

Orthogonal Axis :	X
Test Mode :	UNII-2A/ TX N40 Mode 5310MHz

Vertical

130 dBuV/m

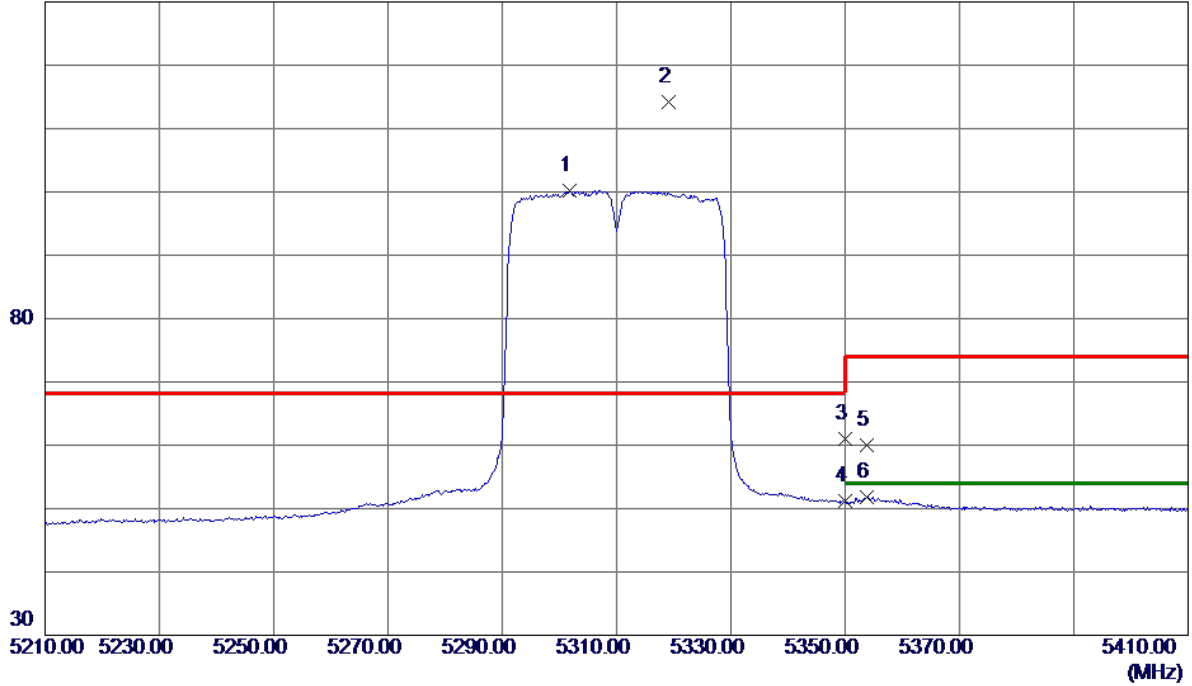

No.	Freq. MHz	Reading Level dBuV/m	Correct Factor dB	Measure ment dBuV/m	Limit dBuV/m	Margin dB	Detector	Comment
1	5301.8000	78.61	21.58	100.19	999.00	-898.81	AVG	No Limit
2 *	5319.2000	92.63	21.65	114.28	68.30	45.98	Peak	No Limit
3	5350.0000	39.24	21.76	61.00	74.00	-13.00	Peak	
4	5350.0000	29.36	21.76	51.12	999.00	-947.88	AVG	
5	5353.8000	38.18	21.77	59.95	74.00	-14.05	Peak	
6	5353.8000	30.07	21.77	51.84	54.00	-2.16	AVG	

Orthogonal Axis :	X
Test Mode :	UNII-2A/ TX N40 Mode 5310MHz

Vertical

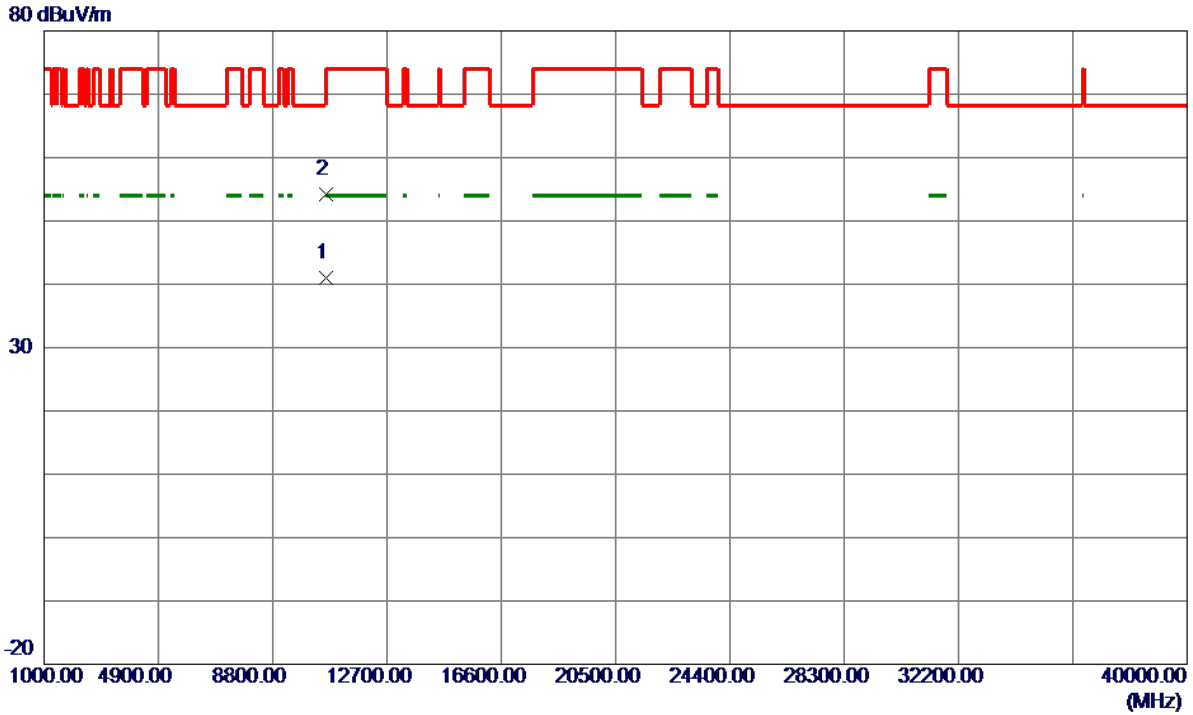

No.	Freq. MHz	Reading Level dBuV/m	Correct Factor dB	Measurement dBuV/m	Limit dBuV/m	Margin dB	Detector	Comment
1 *	10620.4500	20.41	20.56	40.97	54.00	-13.03	AVG	
2	10624.0100	33.69	20.57	54.26	74.00	-19.74	Peak	

Orthogonal Axis :	X
Test Mode :	UNII-2A/ TX N40 Mode 5310MHz

Horizontal

130 dBuV/m

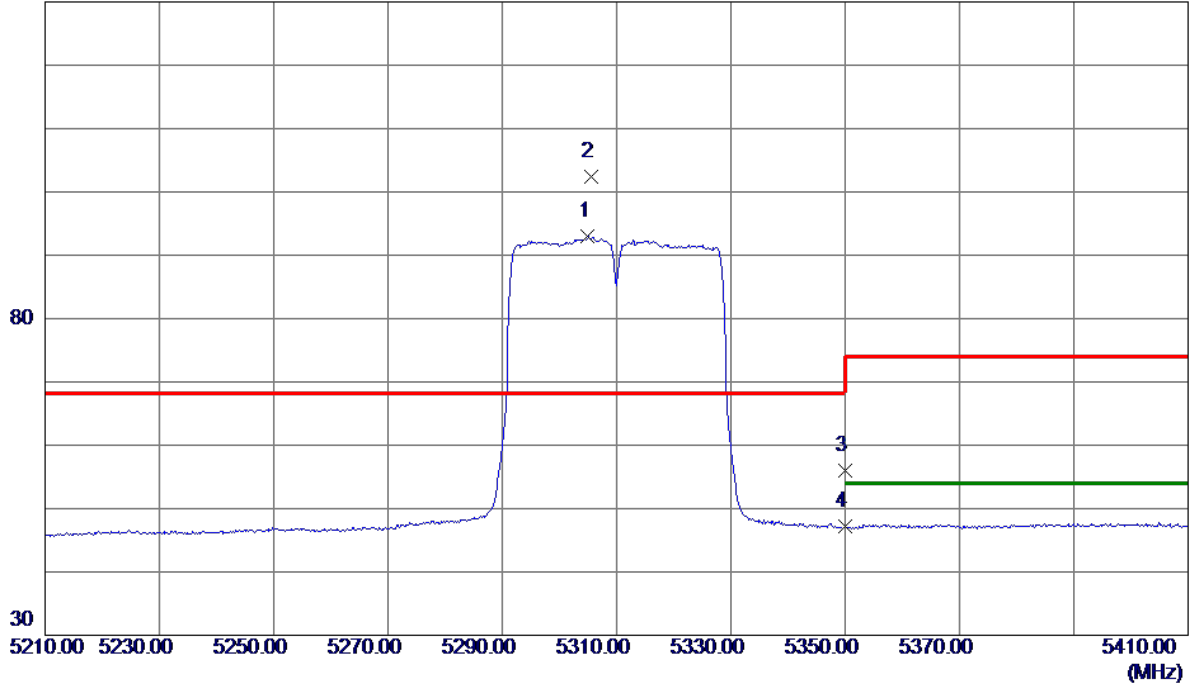

No.	Freq. MHz	Reading Level dBuV/m	Correct Factor dB	Measure ment dBuV/m	Limit dBuV/m	Margin dB	Detector	Comment
1	5305.0000	71.40	21.59	92.99	999.00	-906.01	AVG	No Limit
2 *	5305.6000	80.72	21.60	102.32	68.30	34.02	Peak	No Limit
3	5350.0000	34.28	21.76	56.04	74.00	-17.96	Peak	
4	5350.0000	25.35	21.76	47.11	999.00	-951.89	AVG	

Orthogonal Axis :	X
Test Mode :	UNII-2A/ TX N40 Mode 5310MHz

Horizontal

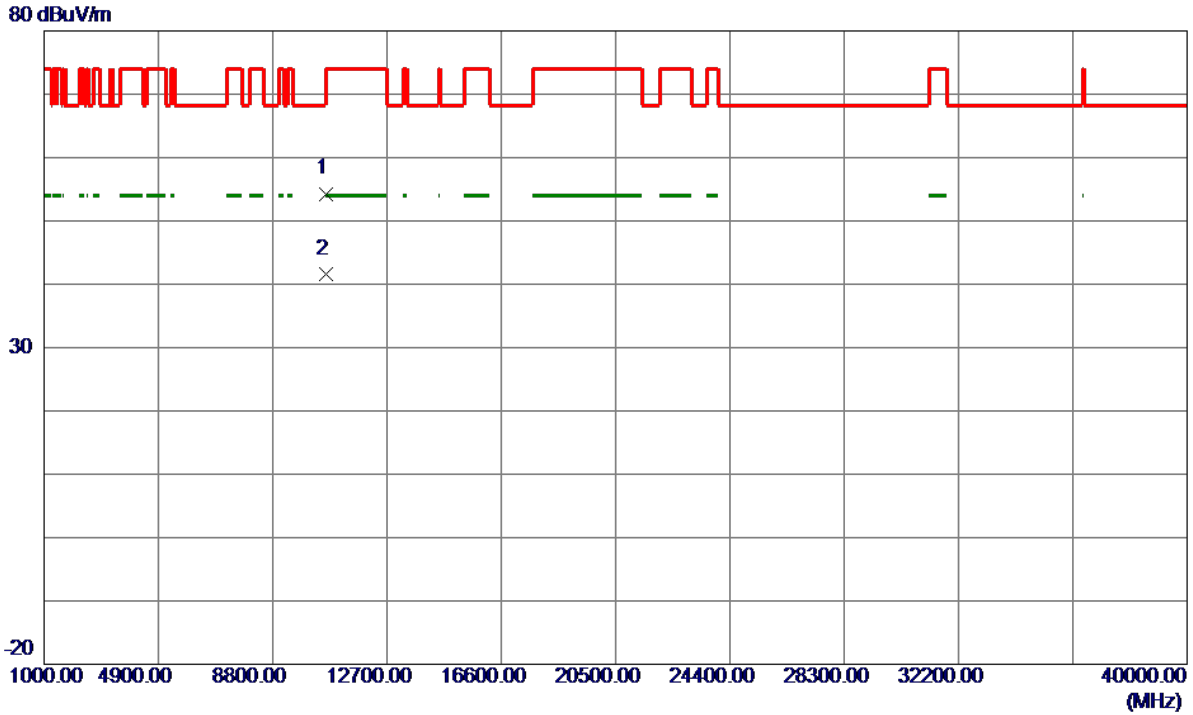

No.	Freq. MHz	Reading Level dBuV/m	Correct Factor dB	Measure ment dBuV/m	Limit dBuV/m	Margin dB	Detector	Comment
1	10620.4500	33.74	20.56	54.30	74.00	-19.70	Peak	
2 *	10622.6100	20.94	20.57	41.51	54.00	-12.49	AVG	

Orthogonal Axis :	X
Test Mode :	UNII-2C/ TX A Mode 5500MHz

Vertical

130 dBuV/m

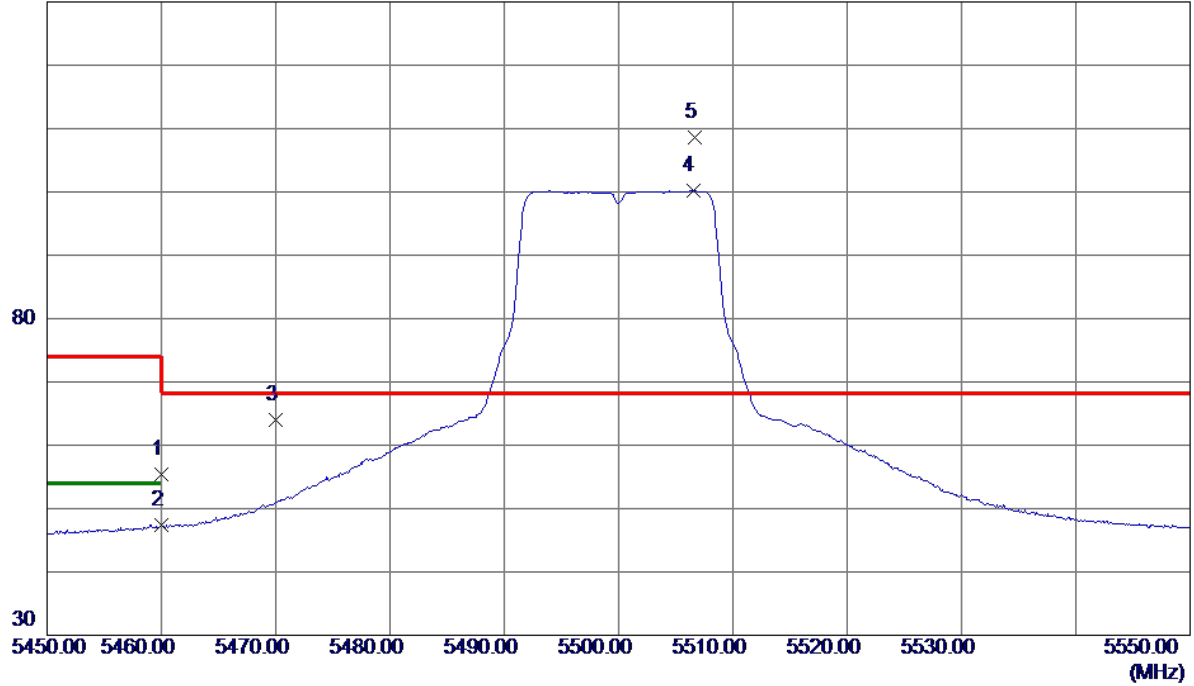

No.	Freq. MHz	Reading Level dBuV/m	Correct Factor dB	Measure ment dBuV/m	Limit dBuV/m	Margin dB	Detector	Comment
1	5460.0000	33.27	22.16	55.43	74.00	-18.57	Peak	
2	5460.0000	25.15	22.16	47.31	54.00	-6.69	AVG	
3	5470.0000	41.90	22.19	64.09	68.30	-4.21	Peak	
4	5506.5000	77.91	22.33	100.24	999.00	-898.76	AVG	No Limit
5 *	5506.7000	86.32	22.33	108.65	68.30	40.35	Peak	No Limit

Orthogonal Axis :	X
Test Mode :	UNII-2C/ TX A Mode 5500MHz

Vertical

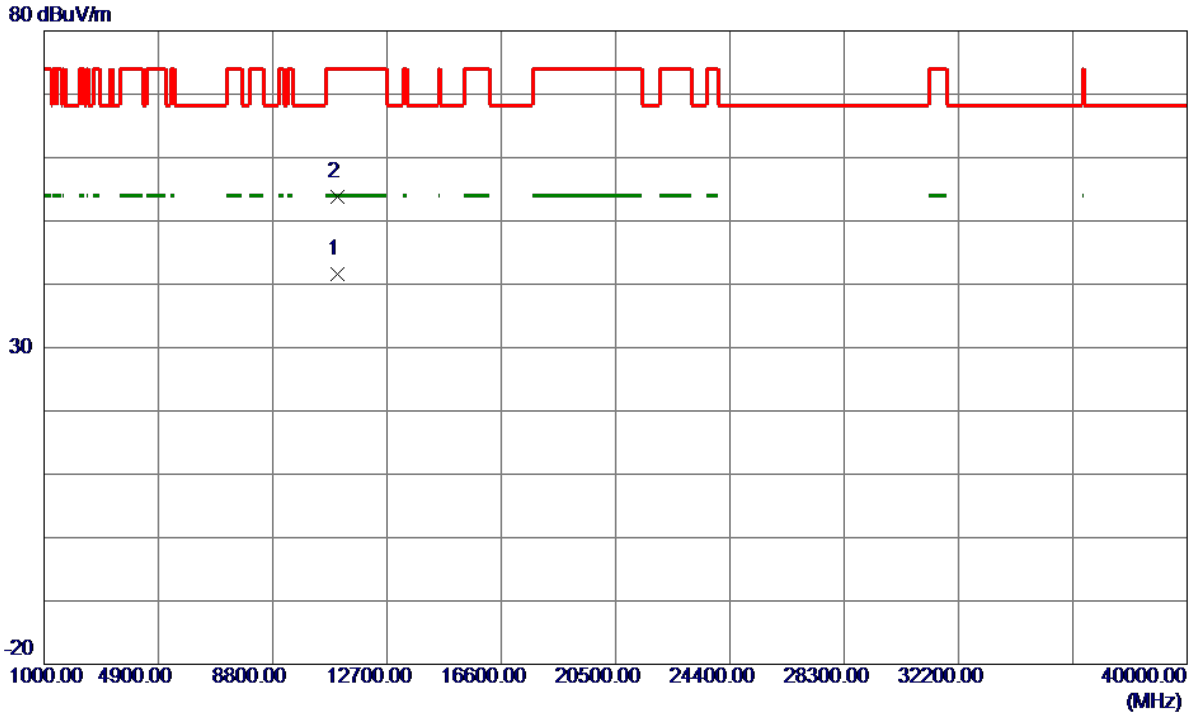

No.	Freq. MHz	Reading Level dBuV/m	Correct Factor dB	Measurement dBuV/m	Limit dBuV/m	Margin dB	Detector	Comment
1 *	10998.8650	20.71	20.88	41.59	54.00	-12.41	AVG	
2	11002.1250	32.92	20.88	53.80	74.00	-20.20	Peak	

Orthogonal Axis :	X
Test Mode :	UNII-2C/ TX A Mode 5500MHz

Horizontal

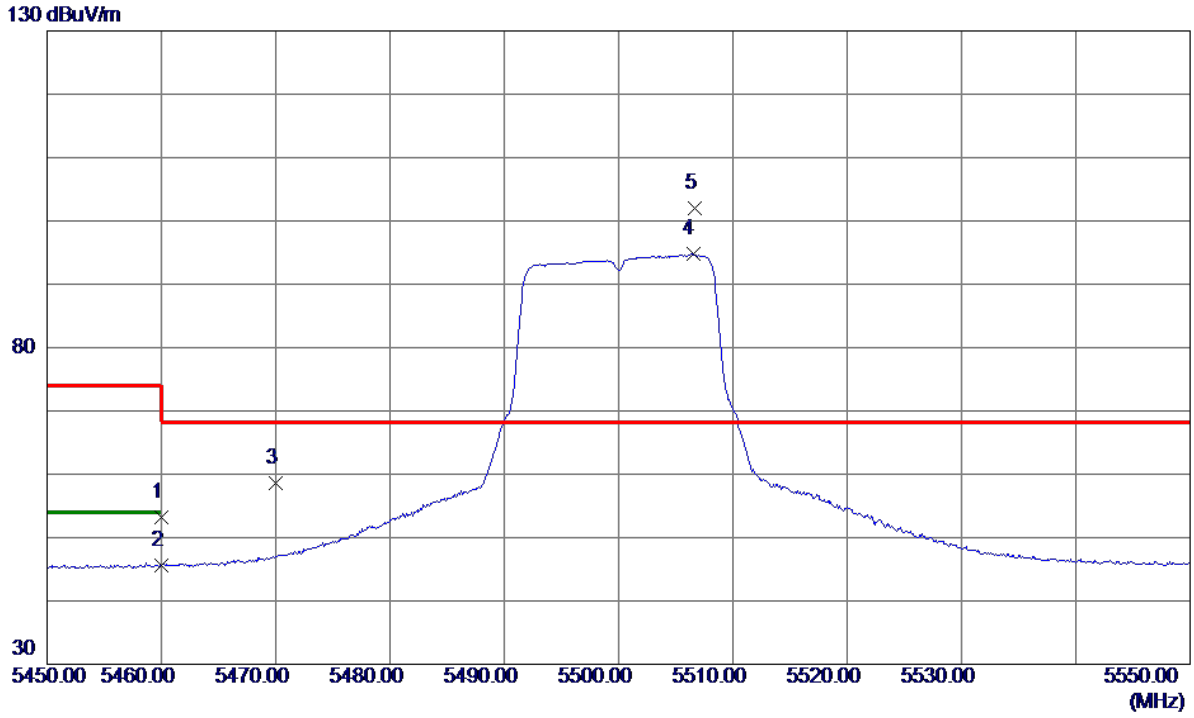

No.	Freq. MHz	Reading Level dBuV/m	Correct Factor dB	Measure ment dBuV/m	Limit dBuV/m	Margin dB	Detector	Comment
1	5460.0000	31.01	22.16	53.17	74.00	-20.83	Peak	
2	5460.0000	23.52	22.16	45.68	54.00	-8.32	AVG	
3	5470.0000	36.39	22.19	58.58	68.30	-9.72	Peak	
4	5506.5000	72.44	22.33	94.77	999.00	-904.23	AVG	No Limit
5 *	5506.7000	79.62	22.33	101.95	68.30	33.65	Peak	No Limit

Orthogonal Axis :	X
Test Mode :	UNII-2C/ TX A Mode 5500MHz

Horizontal



No.	Freq. MHz	Reading Level dBuV/m	Correct Factor dB	Measure ment dBuV/m	Limit dBuV/m	Margin dB	Detector	Comment
1 *	11000.9550	20.66	20.88	41.54	54.00	-12.46	AVG	
2	11000.9800	31.91	20.88	52.79	74.00	-21.21	Peak	

Orthogonal Axis :	X
Test Mode :	UNII-2C/ TX A Mode 5580MHz

Vertical

130 dBuV/m

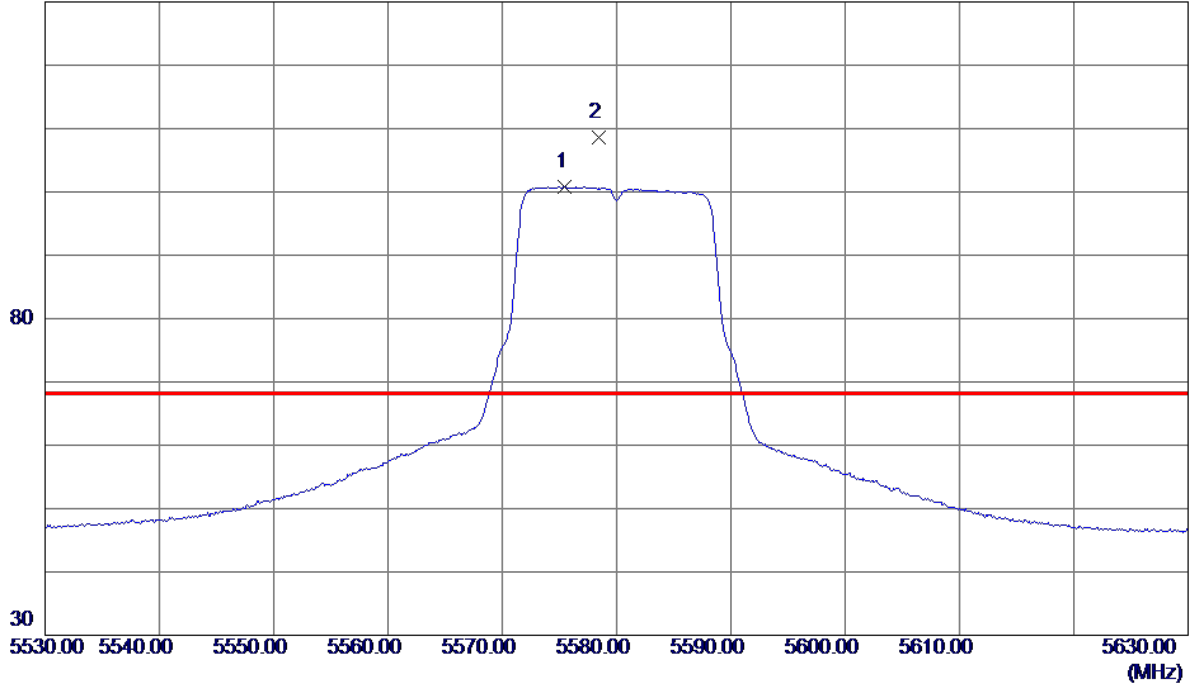

No.	Freq. MHz	Reading Level dBuV/m	Correct Factor dB	Measure ment dBuV/m	Limit dBuV/m	Margin dB	Detector	Comment
1	5575.5000	78.20	22.60	100.80	999.00	-898.20	AVG	No Limit
2 *	5578.4000	86.08	22.61	108.69	68.30	40.39	Peak	No Limit

Orthogonal Axis :	X
Test Mode :	UNII-2C/ TX A Mode 5580MHz

Vertical

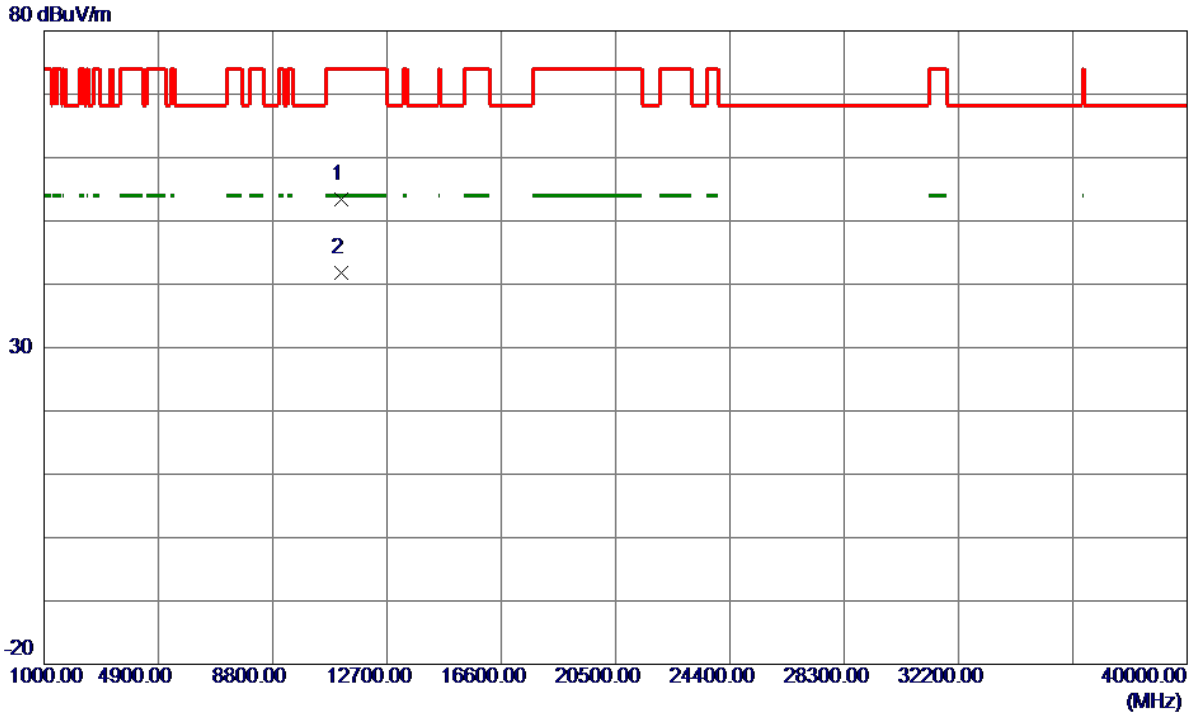

No.	Freq. MHz	Reading Level dBuV/m	Correct Factor dB	Measure ment dBuV/m	Limit dBuV/m	Margin dB	Detector	Comment
1	11157.5199	32.35	20.98	53.33	74.00	-20.67	Peak	
2 *	11158.0050	20.75	20.98	41.73	54.00	-12.27	AVG	

Orthogonal Axis :	X
Test Mode :	UNII-2C/ TX A Mode 5580MHz

Horizontal

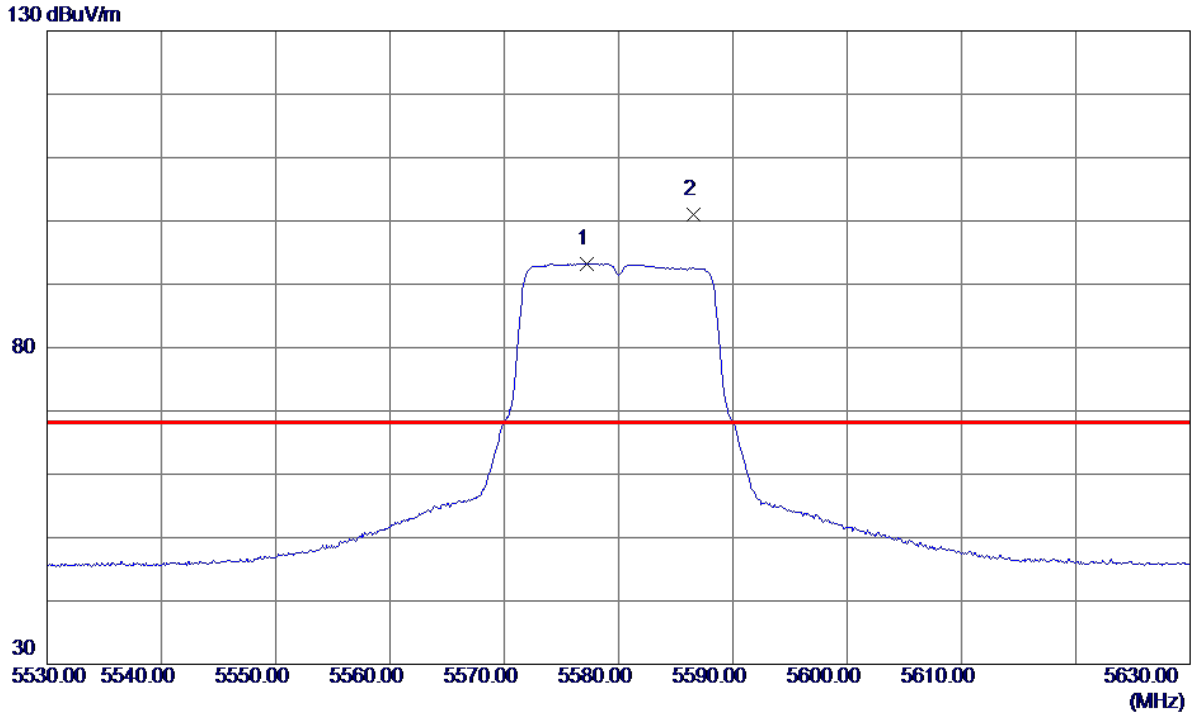

No.	Freq. MHz	Reading Level dBuV/m	Correct Factor dB	Measure ment dBuV/m	Limit dBuV/m	Margin dB	Detector	Comment
1	5577.2000	70.68	22.61	93.29	999.00	-905.71	AVG	No Limit
2 *	5586.6000	78.28	22.64	100.92	68.30	32.62	Peak	No Limit

Orthogonal Axis :	X
Test Mode :	UNII-2C/ TX A Mode 5580MHz

Horizontal

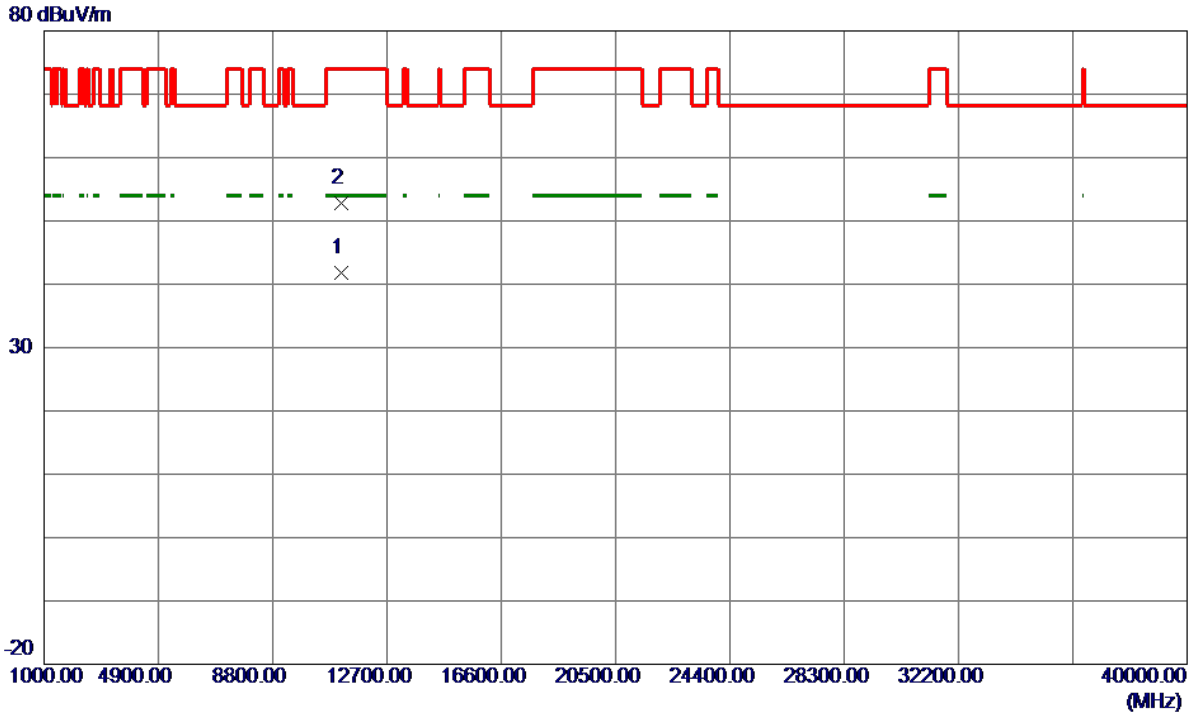

No.	Freq. MHz	Reading Level dBuV/m	Correct Factor dB	Measure ment dBuV/m	Limit dBuV/m	Margin dB	Detector	Comment
1 *	11158.6000	20.89	20.98	41.87	54.00	-12.13	AVG	
2	11159.8949	31.82	20.98	52.80	74.00	-21.20	Peak	

Orthogonal Axis :	X
Test Mode :	UNII-2C/ TX A Mode 5700MHz

Vertical

130 dBuV/m

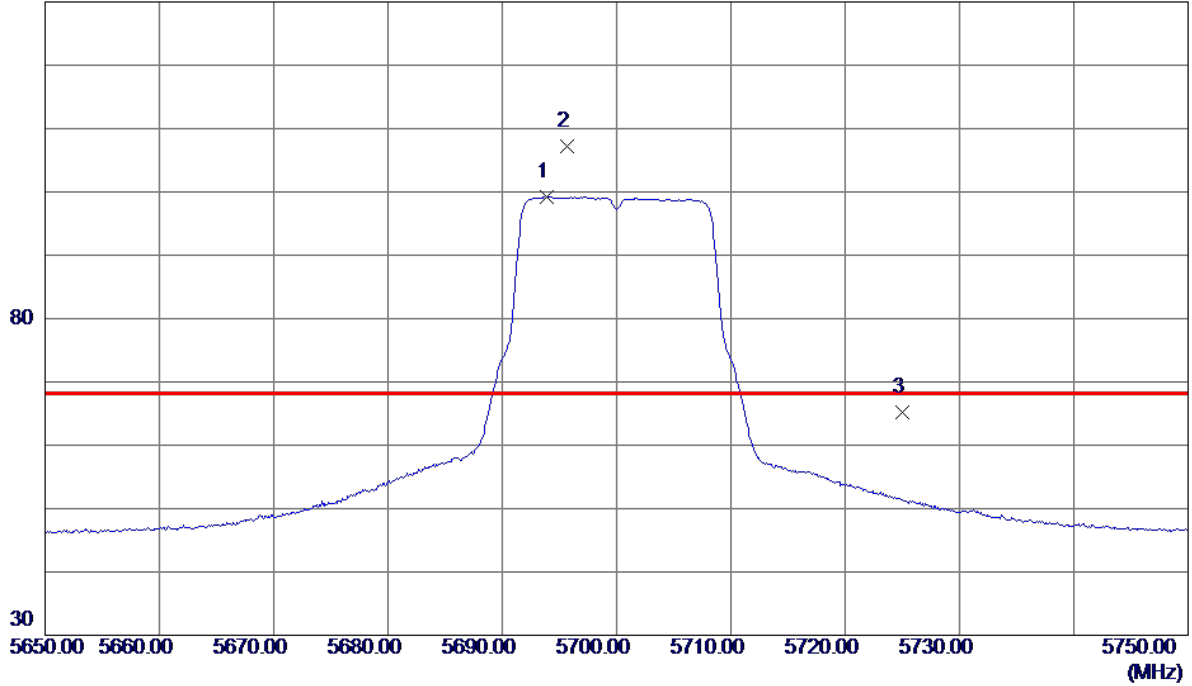

No.	Freq. MHz	Reading Level dBuV/m	Correct Factor dB	Measure ment dBuV/m	Limit dBuV/m	Margin dB	Detector	Comment
1	5693.9000	76.15	23.07	99.22	999.00	-899.78	AVG	No Limit
2 *	5695.7000	84.07	23.08	107.15	68.30	38.85	Peak	No Limit
3	5725.0000	41.92	23.20	65.12	68.30	-3.18	Peak	

Orthogonal Axis :	X
Test Mode :	UNII-2C/ TX A Mode 5700MHz

Vertical

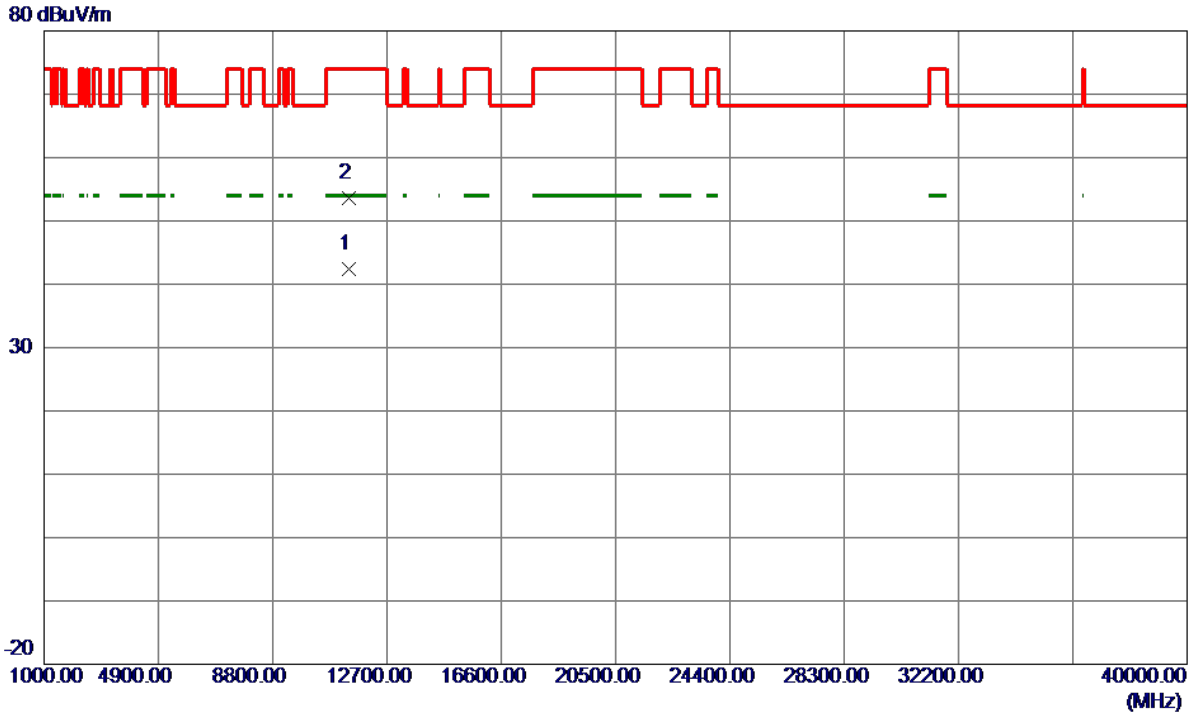

No.	Freq. MHz	Reading Level dBuV/m	Correct Factor dB	Measure ment dBuV/m	Limit dBuV/m	Margin dB	Detector	Comment
1 *	11397.9150	21.35	21.12	42.47	54.00	-11.53	AVG	
2	11400.9550	32.53	21.12	53.65	74.00	-20.35	Peak	

Orthogonal Axis :	X
Test Mode :	UNII-2C/ TX A Mode 5700MHz

Horizontal

130 dBuV/m

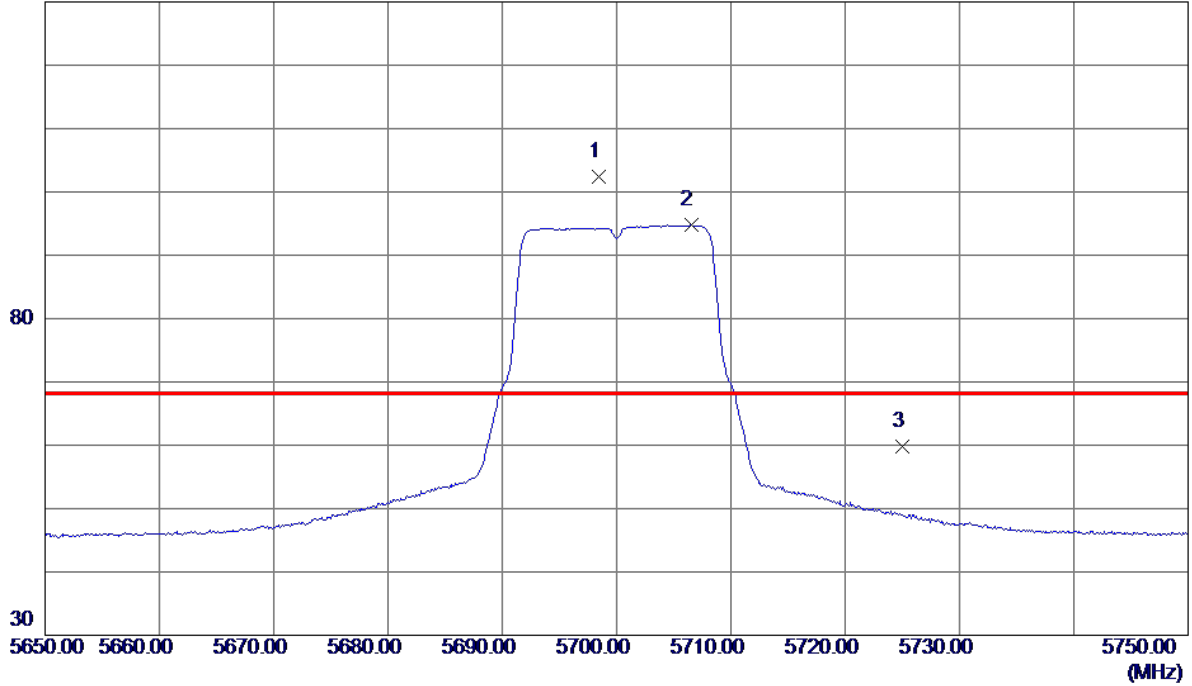

No.	Freq. MHz	Reading Level dBuV/m	Correct Factor dB	Measure ment dBuV/m	Limit dBuV/m	Margin dB	Detector	Comment
1 *	5698.4000	79.25	23.09	102.34	68.30	34.04	Peak	No Limit
2	5706.5000	71.69	23.12	94.81	999.00	-904.19	AVG	No Limit
3	5725.0000	36.63	23.20	59.83	68.30	-8.47	Peak	

Orthogonal Axis :	X
Test Mode :	UNII-2C/ TX A Mode 5700MHz

Horizontal

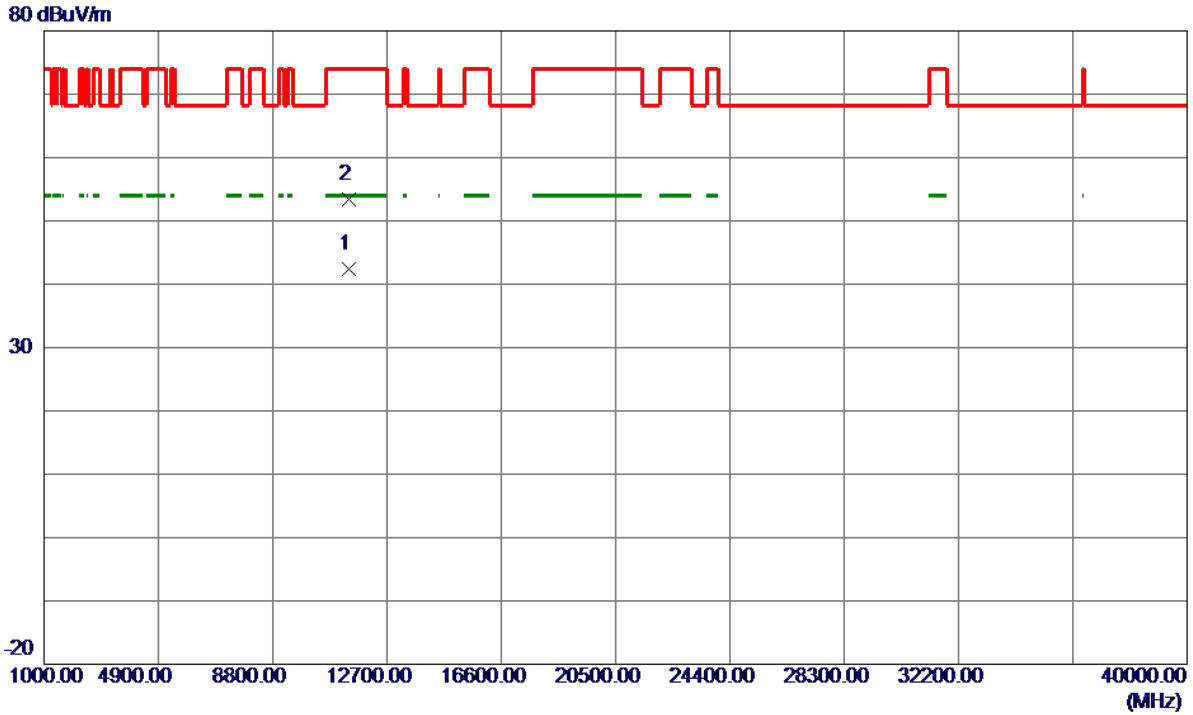

No.	Freq. MHz	Reading Level dBuV/m	Correct Factor dB	Measurement dBuV/m	Limit dBuV/m	Margin dB	Detector	Comment
1 *	11398.0350	21.25	21.12	42.37	54.00	-11.63	AVG	
2	11399.9550	32.33	21.12	53.45	74.00	-20.55	Peak	

Orthogonal Axis :	X
Test Mode :	UNII-2C/ TX N20 Mode 5500MHz

Vertical

130 dBuV/m

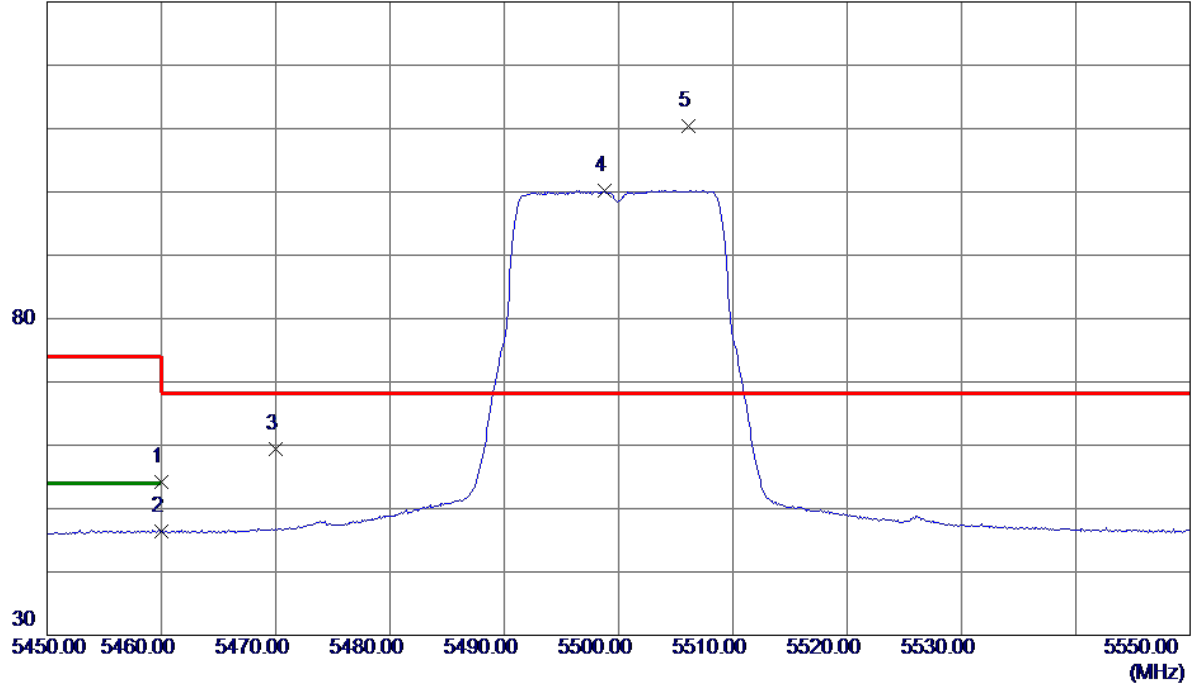

No.	Freq. MHz	Reading Level dBuV/m	Correct Factor dB	Measure ment dBuV/m	Limit dBuV/m	Margin dB	Detector	Comment
1	5460.0000	32.13	22.16	54.29	74.00	-19.71	Peak	
2	5460.0000	24.19	22.16	46.35	54.00	-7.65	AVG	
3	5470.0000	37.22	22.19	59.41	68.30	-8.89	Peak	
4	5498.8000	77.87	22.30	100.17	999.00	-898.83	AVG	No Limit
5 *	5506.1000	87.99	22.32	110.31	68.30	42.01	Peak	No Limit

Orthogonal Axis :	X
Test Mode :	UNII-2C/ TX N20 Mode 5500MHz

Vertical

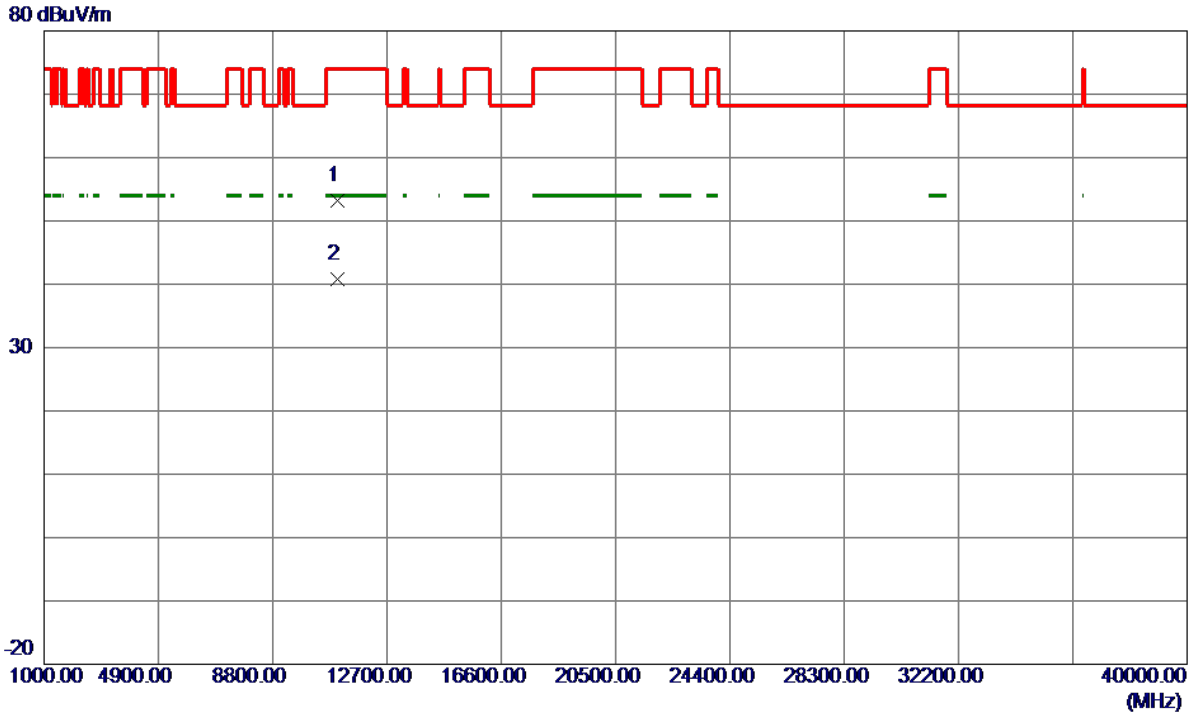

No.	Freq. MHz	Reading Level dBuV/m	Correct Factor dB	Measure ment dBuV/m	Limit dBuV/m	Margin dB	Detector	Comment
1	10996.2600	32.31	20.88	53.19	74.00	-20.81	Peak	
2 *	11009.1200	19.96	20.89	40.85	54.00	-13.15	AVG	

Orthogonal Axis :	X
Test Mode :	UNII-2C/ TX N20 Mode 5500MHz

Horizontal

130 dBuV/m

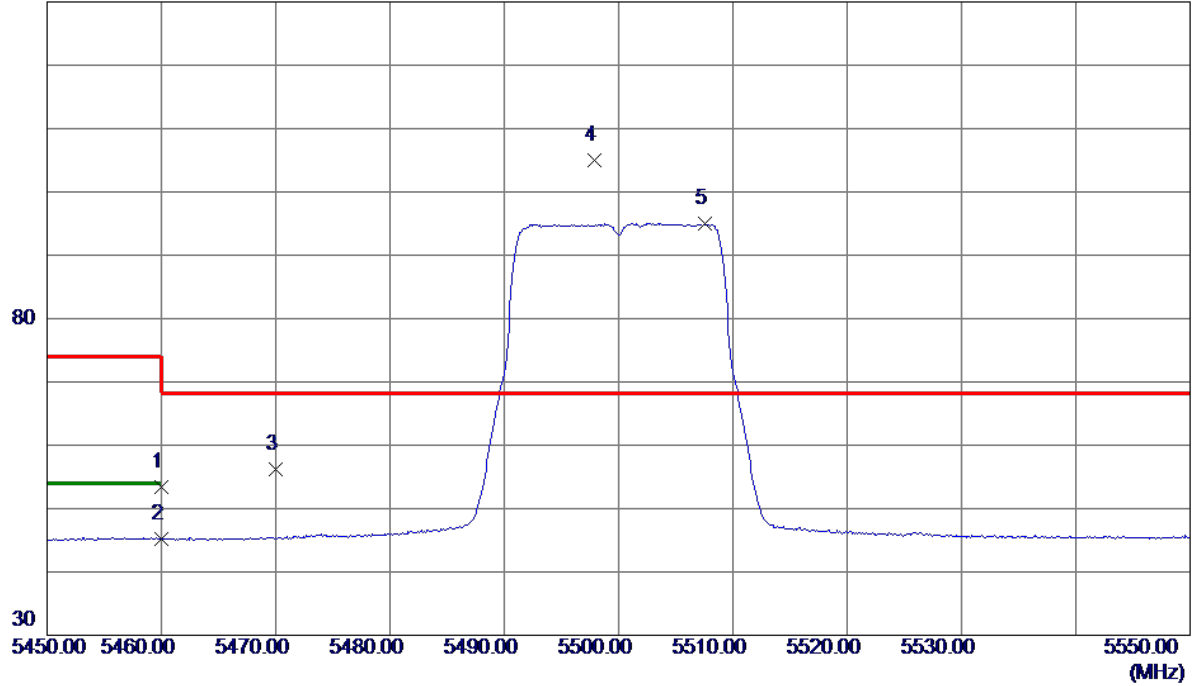

No.	Freq. MHz	Reading Level dBuV/m	Correct Factor dB	Measure ment dBuV/m	Limit dBuV/m	Margin dB	Detector	Comment
1	5460.0000	31.16	22.16	53.32	74.00	-20.68	Peak	
2	5460.0000	23.07	22.16	45.23	54.00	-8.77	AVG	
3	5470.0000	34.09	22.19	56.28	68.30	-12.02	Peak	
4 *	5497.9000	82.73	22.29	105.02	68.30	36.72	Peak	No Limit
5	5507.6000	72.69	22.33	95.02	999.00	-903.98	AVG	No Limit

Orthogonal Axis :	X
Test Mode :	UNII-2C/ TX N20 Mode 5500MHz

Horizontal

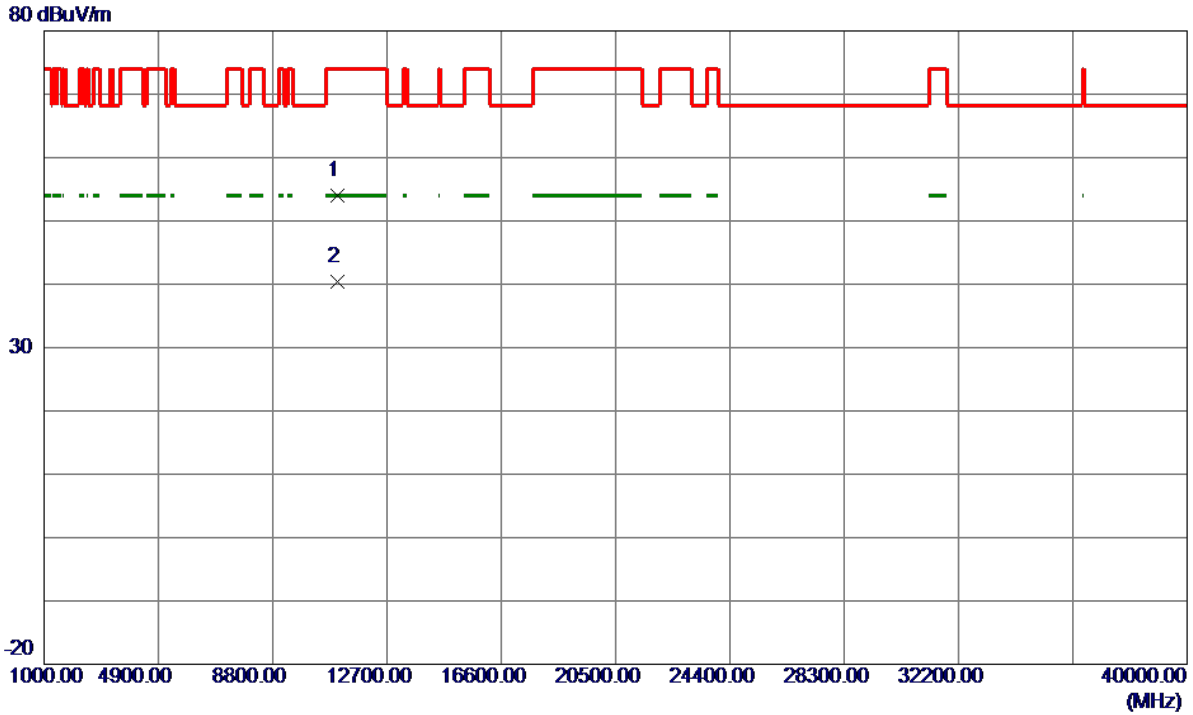

No.	Freq. MHz	Reading Level dBuV/m	Correct Factor dB	Measure ment dBuV/m	Limit dBuV/m	Margin dB	Detector	Comment
1	11003.7600	33.06	20.88	53.94	74.00	-20.06	Peak	
2 *	11009.8000	19.56	20.89	40.45	54.00	-13.55	AVG	

Orthogonal Axis :	X
Test Mode :	UNII-2C/ TX N20 Mode 5580MHz

Vertical

130 dBuV/m

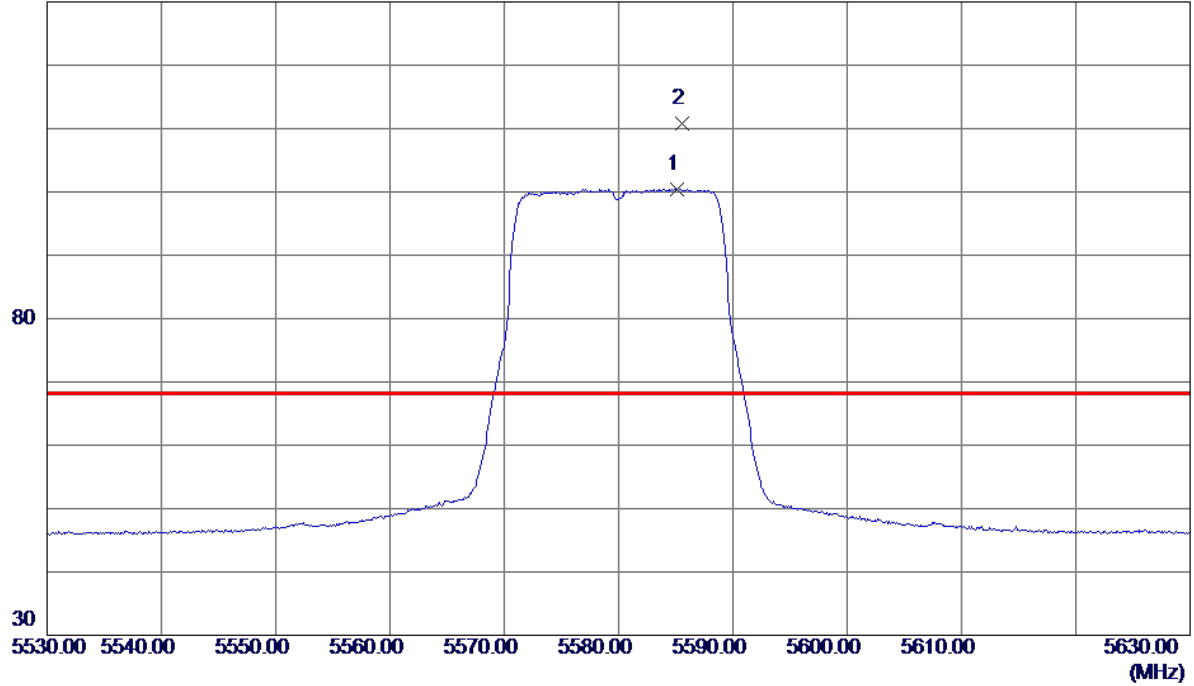

No.	Freq. MHz	Reading Level dBuV/m	Correct Factor dB	Measure ment dBuV/m	Limit dBuV/m	Margin dB	Detector	Comment
1	5585.1000	77.79	22.64	100.43	999.00	-898.57	AVG	No Limit
2 *	5585.6000	88.10	22.64	110.74	68.30	42.44	Peak	No Limit

Orthogonal Axis :	X
Test Mode :	UNII-2C/ TX N20 Mode 5580MHz

Vertical

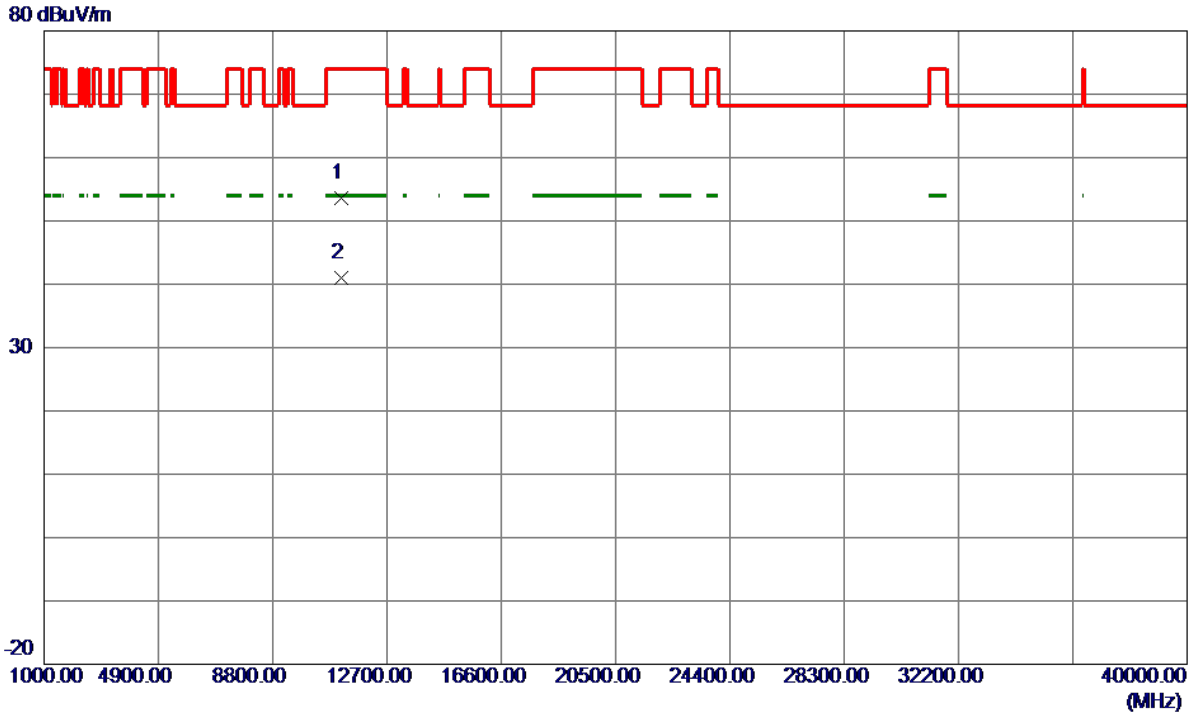

No.	Freq. MHz	Reading Level dBuV/m	Correct Factor dB	Measure ment dBuV/m	Limit dBuV/m	Margin dB	Detector	Comment
1	11158.3600	32.56	20.98	53.54	74.00	-20.46	Peak	
2 *	11160.0599	20.06	20.98	41.04	54.00	-12.96	AVG	

Orthogonal Axis :	X
Test Mode :	UNII-2C/ TX N20 Mode 5580MHz

Horizontal

130 dBuV/m

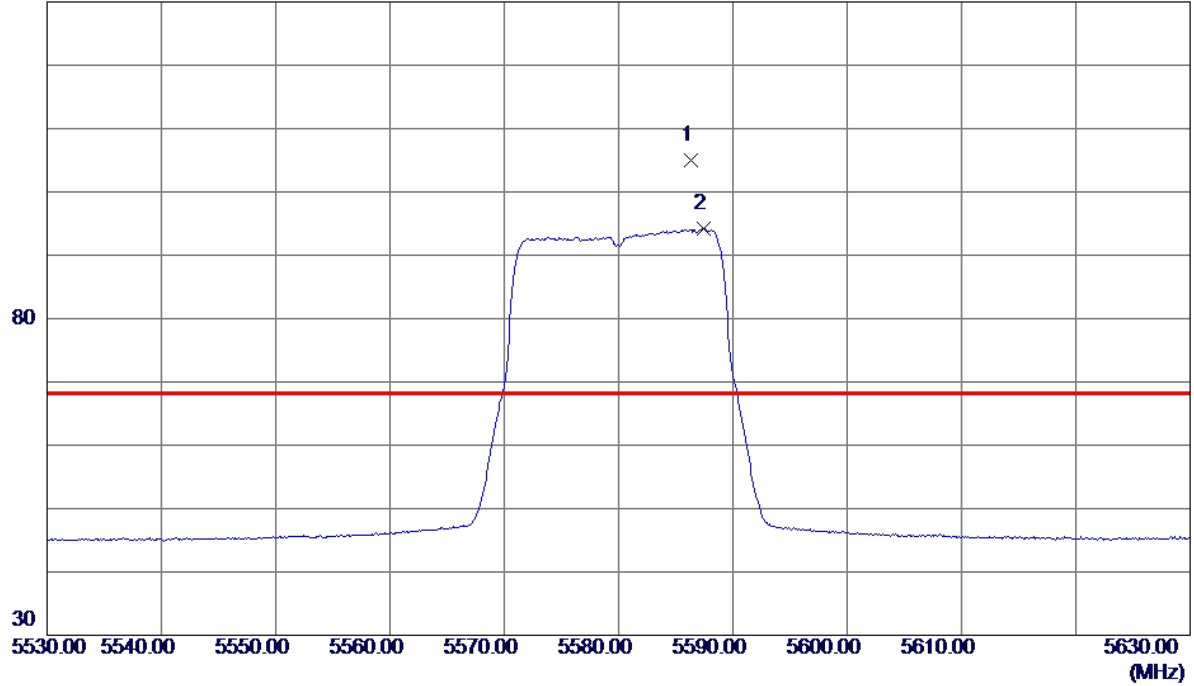

No.	Freq. MHz	Reading Level dBuV/m	Correct Factor dB	Measure ment dBuV/m	Limit dBuV/m	Margin dB	Detector	Comment
1 *	5586.3000	82.33	22.64	104.97	68.30	36.67	Peak	No Limit
2	5587.4000	71.63	22.65	94.28	999.00	-904.72	AVG	No Limit

Orthogonal Axis :	X
Test Mode :	UNII-2C/ TX N20 Mode 5580MHz

Horizontal

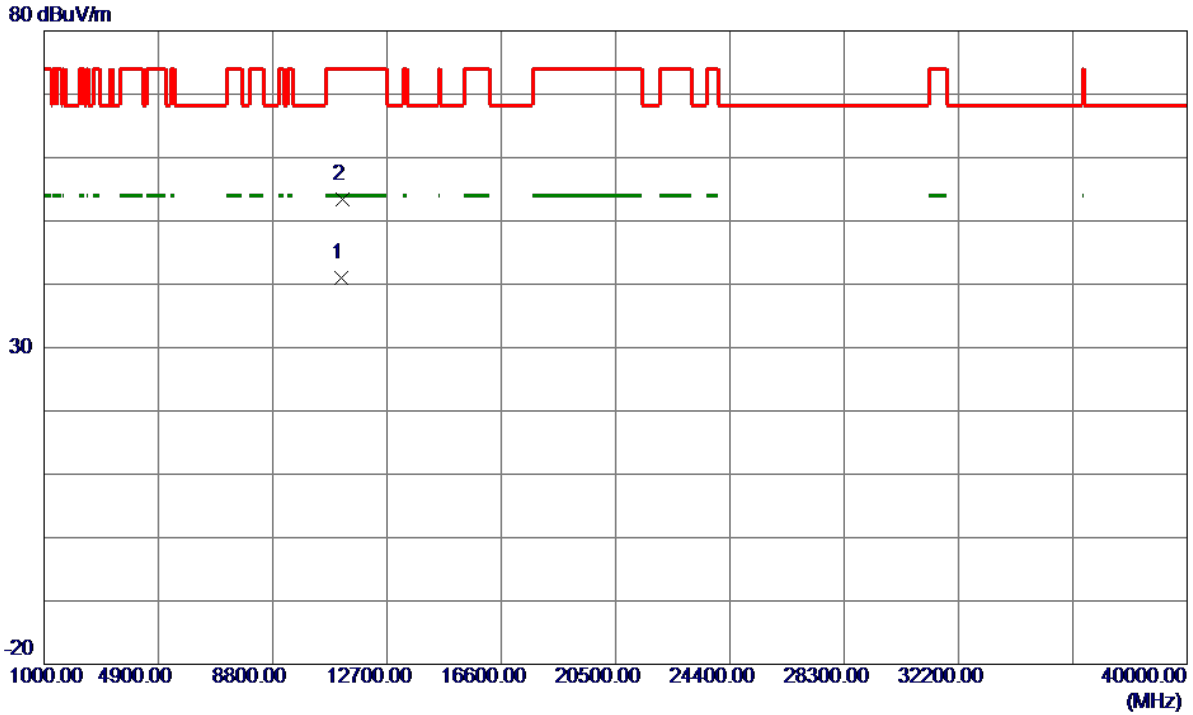

No.	Freq. MHz	Reading Level dBuV/m	Correct Factor dB	Measure ment dBuV/m	Limit dBuV/m	Margin dB	Detector	Comment
1 *	11152.8400	20.10	20.97	41.07	54.00	-12.93	AVG	
2	11168.3400	32.33	20.98	53.31	74.00	-20.69	Peak	

Orthogonal Axis :	X
Test Mode :	UNII-2C/ TX N20 Mode 5700MHz

Vertical

130 dBuV/m

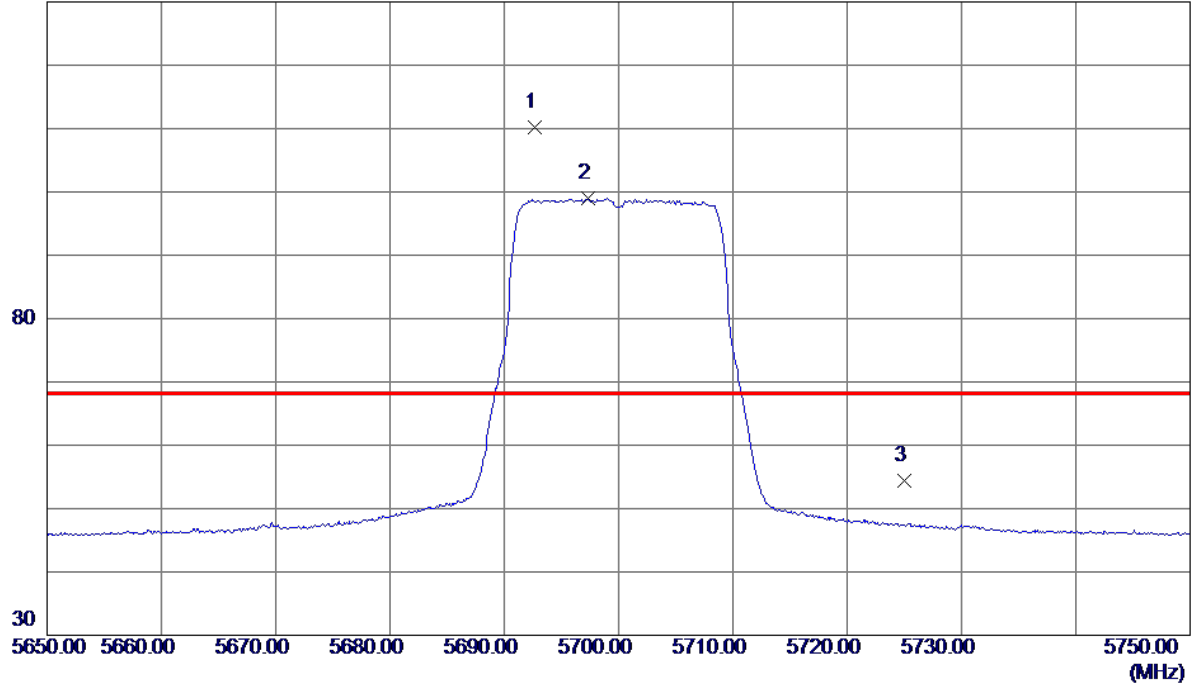

No.	Freq. MHz	Reading Level dBuV/m	Correct Factor dB	Measure ment dBuV/m	Limit dBuV/m	Margin dB	Detector	Comment
1 *	5692.7000	87.22	23.07	110.29	68.30	41.99	Peak	No Limit
2	5697.3000	75.86	23.09	98.95	999.00	-900.05	AVG	No Limit
3	5725.0000	31.18	23.20	54.38	68.30	-13.92	Peak	

Orthogonal Axis :	X
Test Mode :	UNII-2C/ TX N20 Mode 5700MHz

Vertical

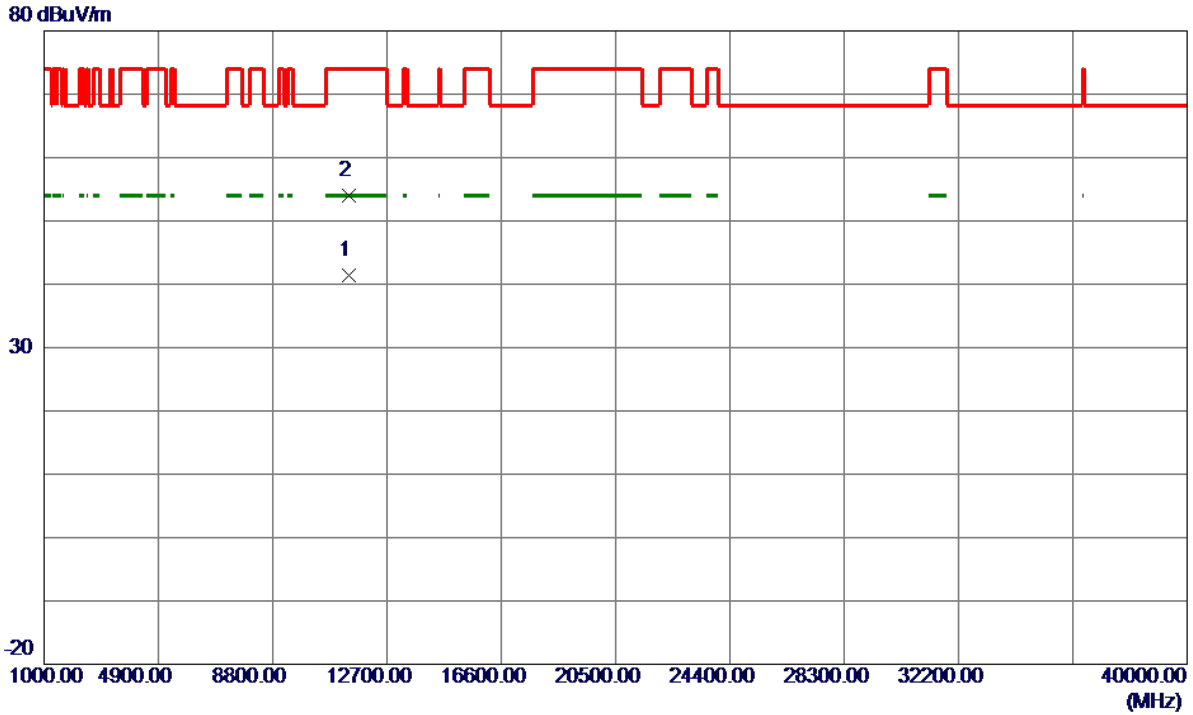

No.	Freq. MHz	Reading Level dBuV/m	Correct Factor dB	Measurement dBuV/m	Limit dBuV/m	Margin dB	Detector	Comment
1 *	11391.8000	20.33	21.12	41.45	54.00	-12.55	AVG	
2	11398.4200	32.87	21.12	53.99	74.00	-20.01	Peak	

Orthogonal Axis :	X
Test Mode :	UNII-2C/ TX N20 Mode 5700MHz

Horizontal

130 dBuV/m

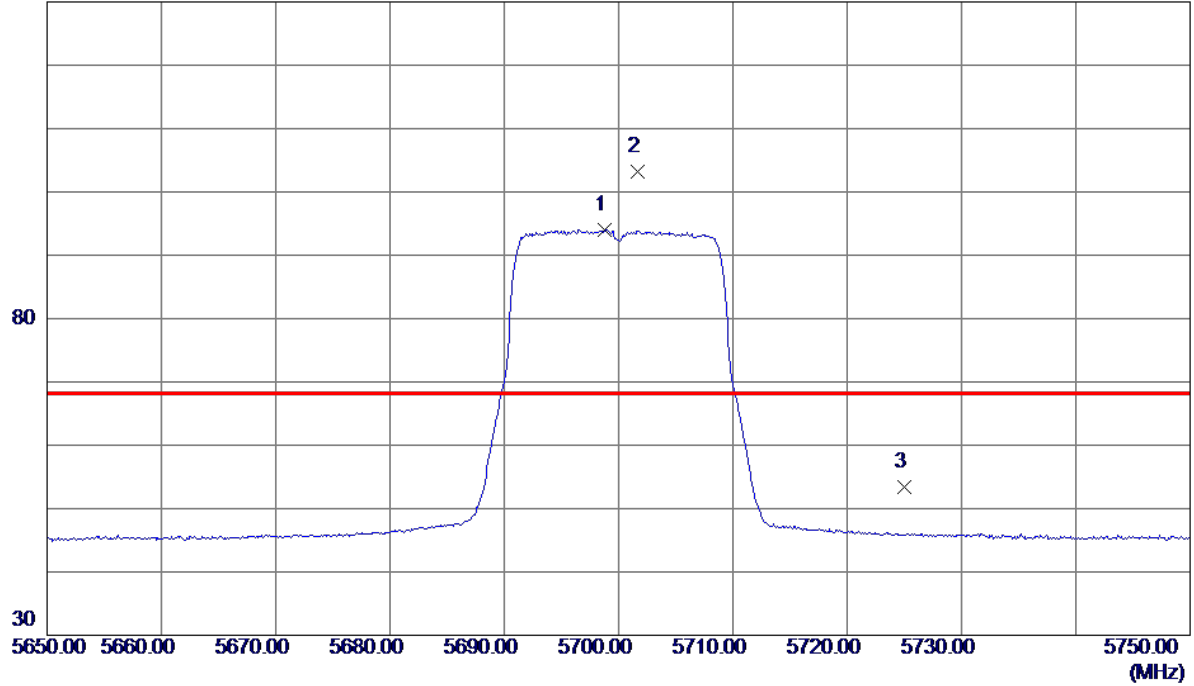

No.	Freq. MHz	Reading Level dBuV/m	Correct Factor dB	Measure ment dBuV/m	Limit dBuV/m	Margin dB	Detector	Comment
1	5698.8000	70.99	23.09	94.08	999.00	-904.92	AVG	No Limit
2 *	5701.7000	80.13	23.10	103.23	68.30	34.93	Peak	No Limit
3	5725.0000	30.17	23.20	53.37	68.30	-14.93	Peak	

Orthogonal Axis :	X
Test Mode :	UNII-2C/ TX N20 Mode 5700MHz

Horizontal

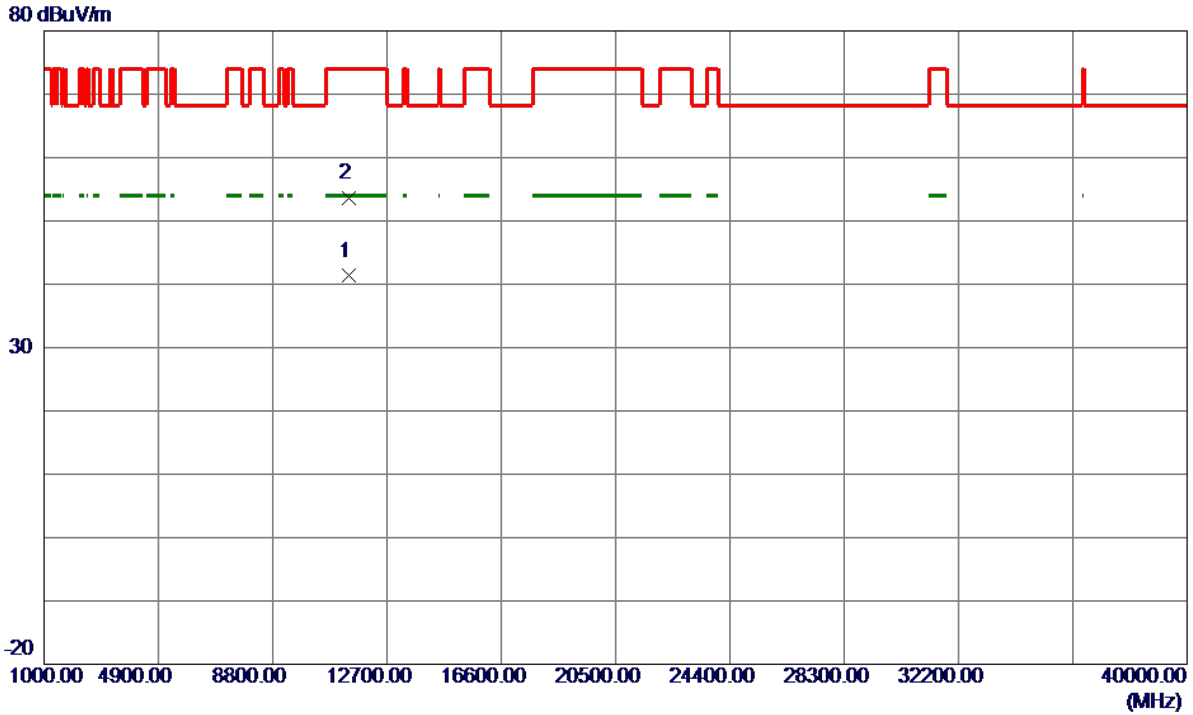

No.	Freq. MHz	Reading Level dBuV/m	Correct Factor dB	Measure ment dBuV/m	Limit dBuV/m	Margin dB	Detector	Comment
1 *	11393.7800	20.18	21.12	41.30	54.00	-12.70	AVG	
2	11394.4000	32.48	21.12	53.60	74.00	-20.40	Peak	

Orthogonal Axis :	X
Test Mode :	UNII-2C/ TX N40 Mode 5510MHz

Vertical

130 dBuV/m

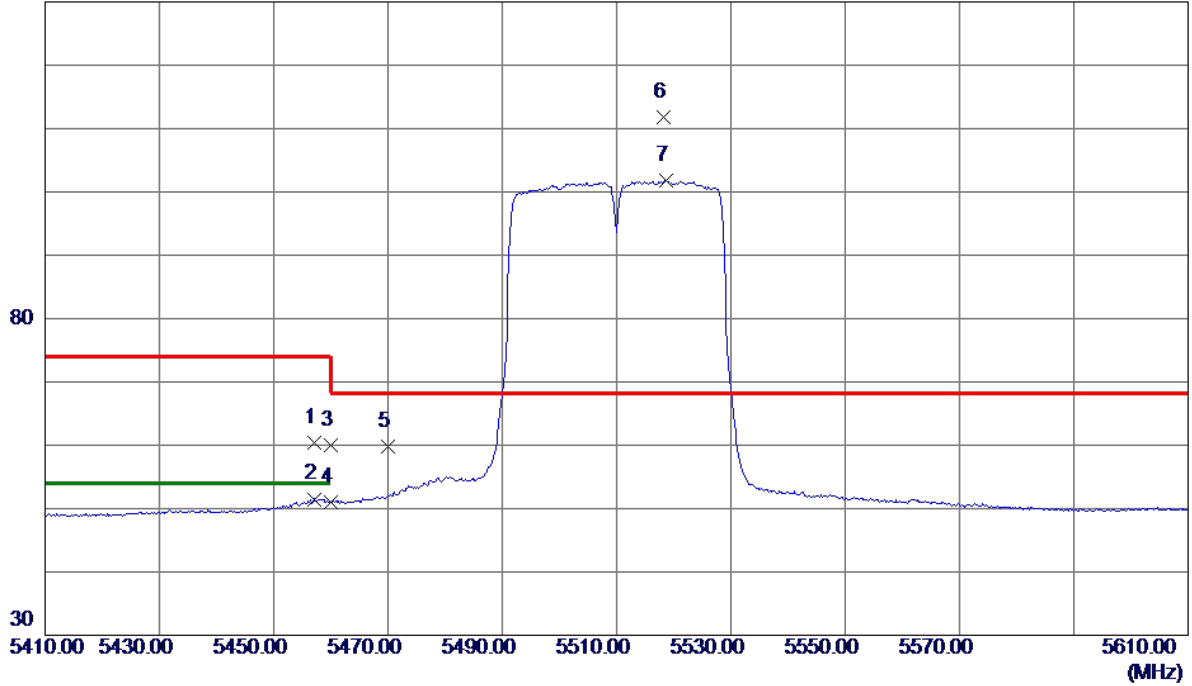

No.	Freq. MHz	Reading Level dBuV/m	Correct Factor dB	Measure ment dBuV/m	Limit dBuV/m	Margin dB	Detector	Comment
1	5457.2000	38.22	22.14	60.36	74.00	-13.64	Peak	
2	5457.2000	29.36	22.14	51.50	54.00	-2.50	AVG	
3	5460.0000	37.78	22.16	59.94	74.00	-14.06	Peak	
4	5460.0000	28.75	22.16	50.91	54.00	-3.09	AVG	
5	5470.0000	37.68	22.19	59.87	68.30	-8.43	Peak	
6 *	5518.2000	89.35	22.37	111.72	68.30	43.42	Peak	No Limit
7	5518.6000	79.35	22.37	101.72	999.00	-897.28	AVG	No Limit

Orthogonal Axis :	X
Test Mode :	UNII-2C/ TX N40 Mode 5510MHz

Vertical

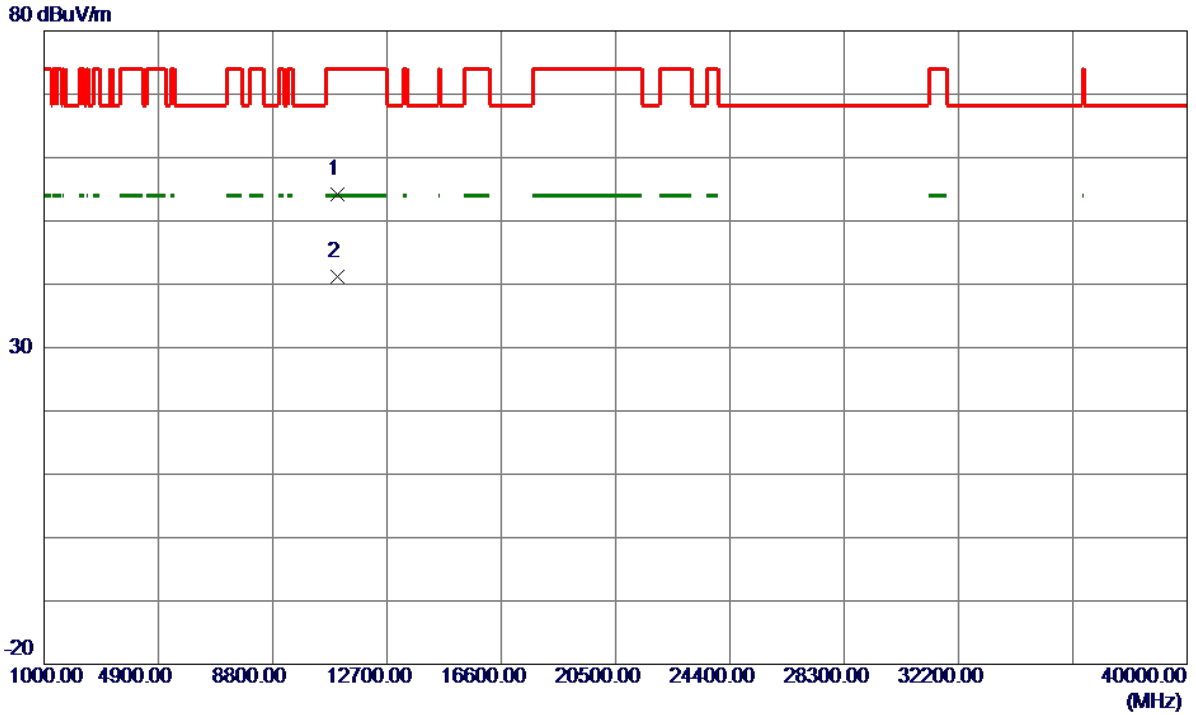

No.	Freq. MHz	Reading Level dBuV/m	Correct Factor dB	Measure ment dBuV/m	Limit dBuV/m	Margin dB	Detector	Comment
1	11015.4400	33.22	20.89	54.11	74.00	-19.89	Peak	
2 *	11020.6400	20.33	20.89	41.22	54.00	-12.78	AVG	

Orthogonal Axis :	X
Test Mode :	UNII-2C/ TX N40 Mode 5510MHz

Horizontal

130 dBuV/m

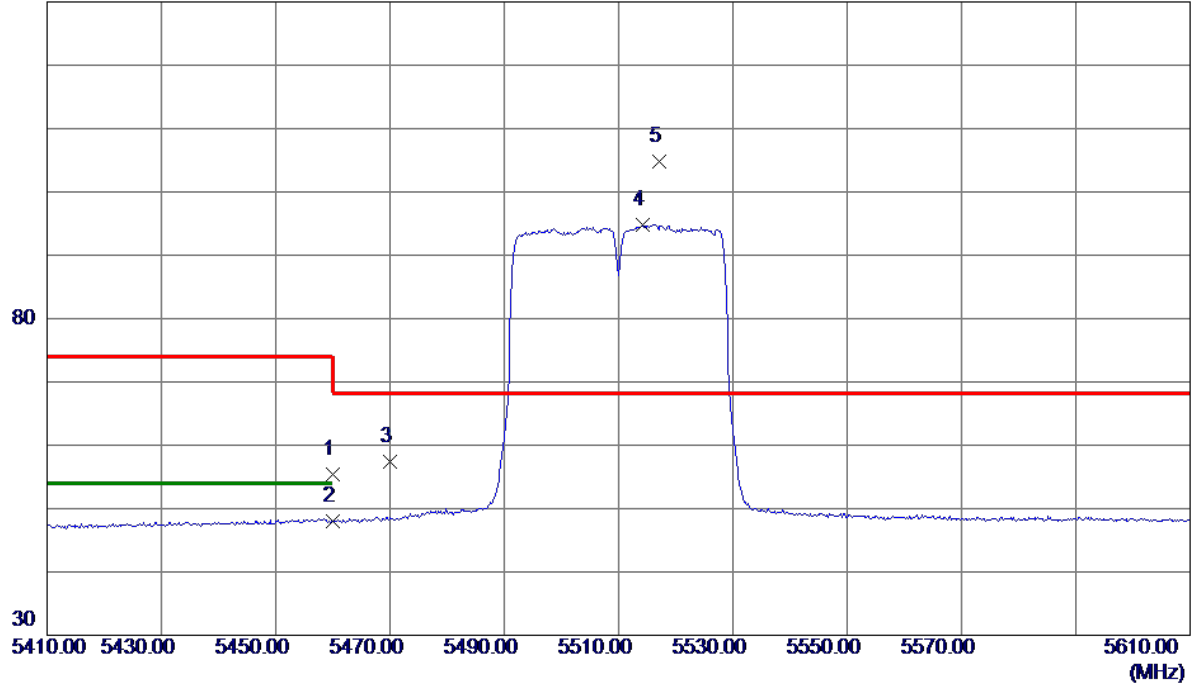

No.	Freq. MHz	Reading Level dBuV/m	Correct Factor dB	Measure ment dBuV/m	Limit dBuV/m	Margin dB	Detector	Comment
1	5460.0000	33.28	22.16	55.44	74.00	-18.56	Peak	
2	5460.0000	25.90	22.16	48.06	54.00	-5.94	AVG	
3	5470.0000	35.12	22.19	57.31	68.30	-10.99	Peak	
4	5514.2000	72.47	22.36	94.83	999.00	-904.17	AVG	No Limit
5 *	5517.2000	82.42	22.37	104.79	68.30	36.49	Peak	No Limit

Orthogonal Axis :	X
Test Mode :	UNII-2C/ TX N40 Mode 5510MHz

Horizontal

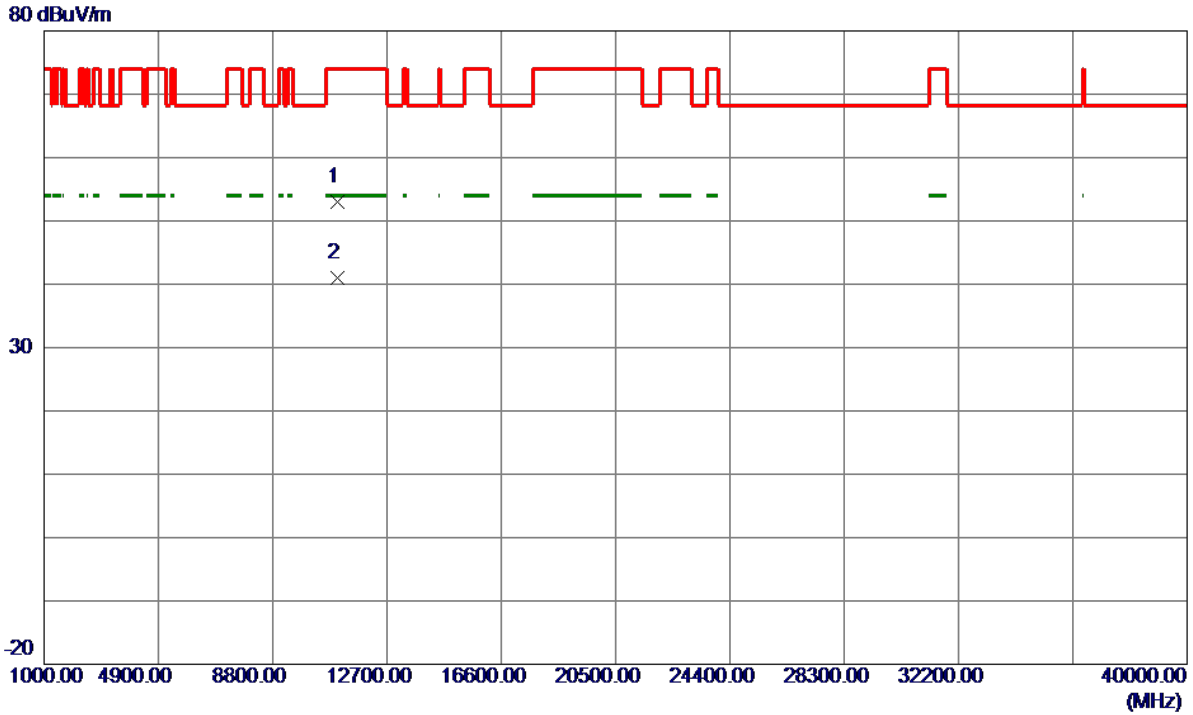

No.	Freq. MHz	Reading Level dBuV/m	Correct Factor dB	Measurement dBuV/m	Limit dBuV/m	Margin dB	Detector	Comment
1	11026.9600	32.15	20.90	53.05	74.00	-20.95	Peak	
2 *	11029.3400	20.16	20.90	41.06	54.00	-12.94	AVG	

Orthogonal Axis :	X
Test Mode :	UNII-2C/ TX N40 Mode 5550MHz

Vertical

130 dBuV/m

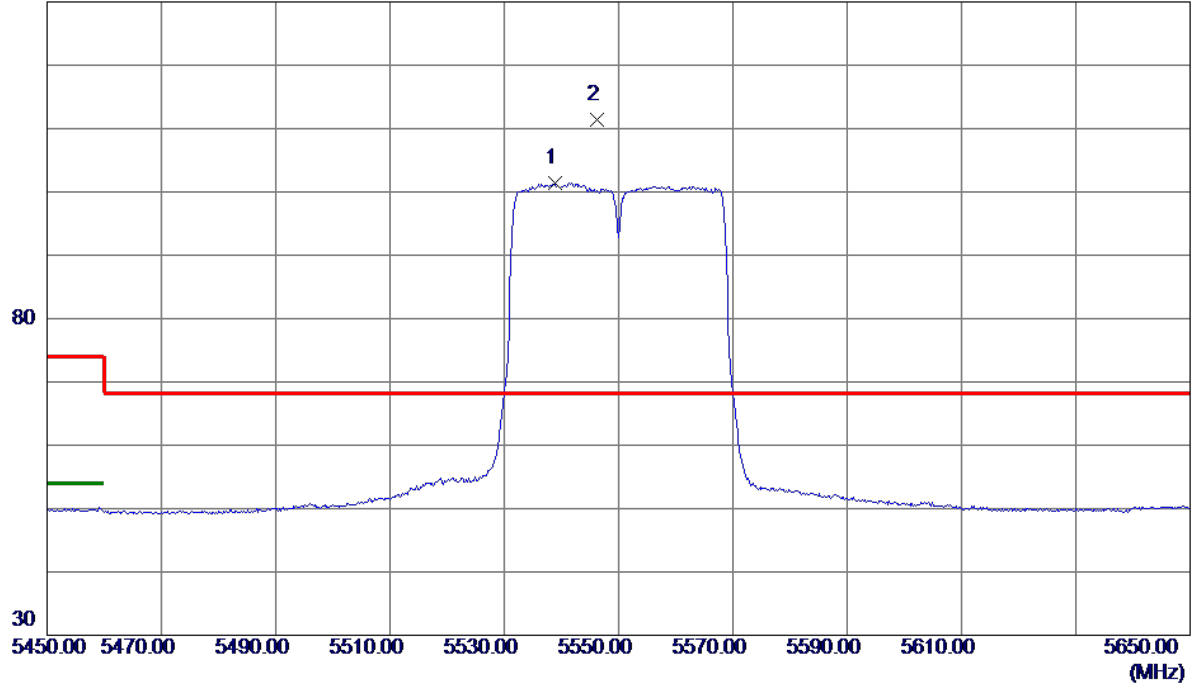

No.	Freq. MHz	Reading Level dBuV/m	Correct Factor dB	Measure ment dBuV/m	Limit dBuV/m	Margin dB	Detector	Comment
1	5538.8000	79.02	22.45	101.47	999.00	-897.53	AVG	No Limit
2 *	5546.2000	88.93	22.48	111.41	68.30	43.11	Peak	No Limit

Orthogonal Axis :	X
Test Mode :	UNII-2C/ TX N40 Mode 5550MHz

Vertical

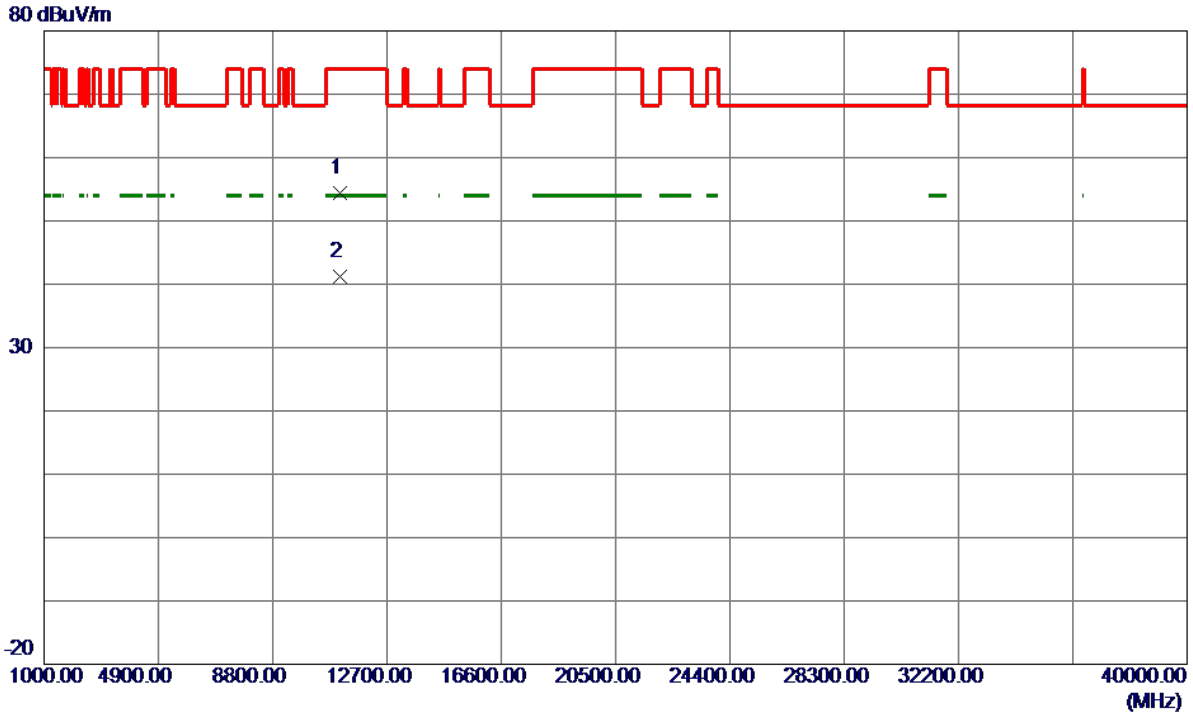

No.	Freq. MHz	Reading Level dBuV/m	Correct Factor dB	Measure ment dBuV/m	Limit dBuV/m	Margin dB	Detector	Comment
1	11099.7500	33.48	20.94	54.42	74.00	-19.58	Peak	
2 *	11103.7000	20.30	20.94	41.24	54.00	-12.76	AVG	

Orthogonal Axis :	X
Test Mode :	UNII-2C/ TX N40 Mode 5550MHz

Horizontal

130 dBuV/m

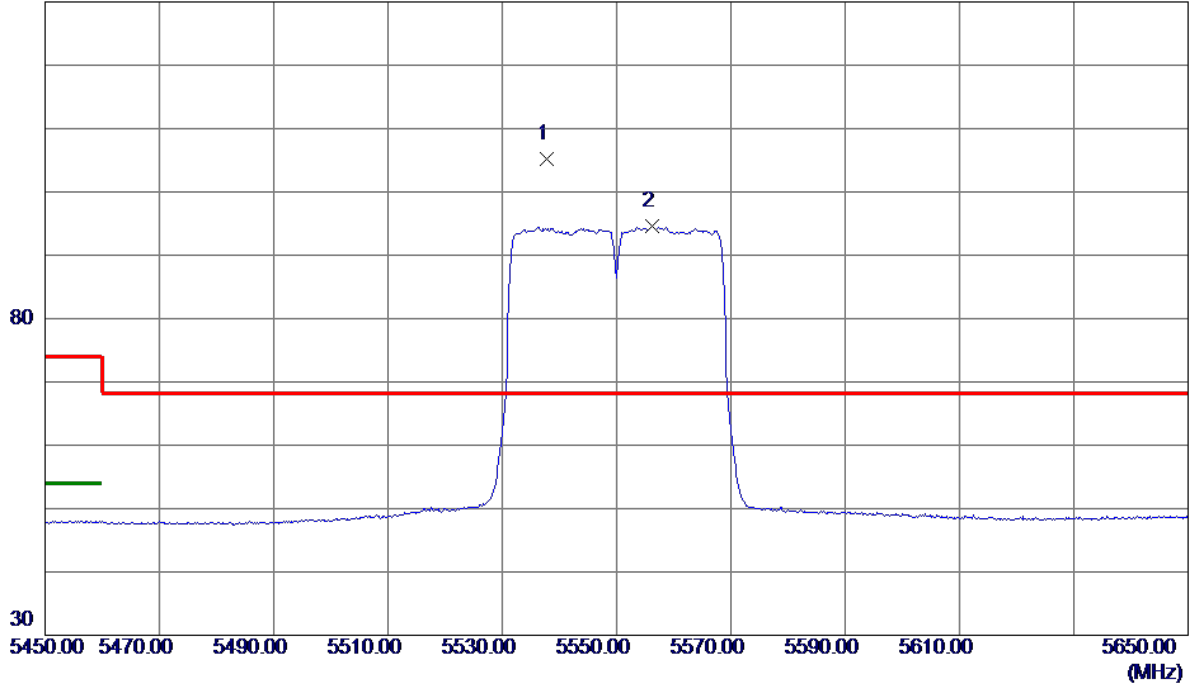

No.	Freq. MHz	Reading Level dBuV/m	Correct Factor dB	Measure ment dBuV/m	Limit dBuV/m	Margin dB	Detector	Comment
1 *	5537.8000	82.80	22.45	105.25	68.30	36.95	Peak	No Limit
2	5556.2000	72.09	22.52	94.61	999.00	-904.39	AVG	No Limit

Orthogonal Axis :	X
Test Mode :	UNII-2C/ TX N40 Mode 5550MHz

Horizontal

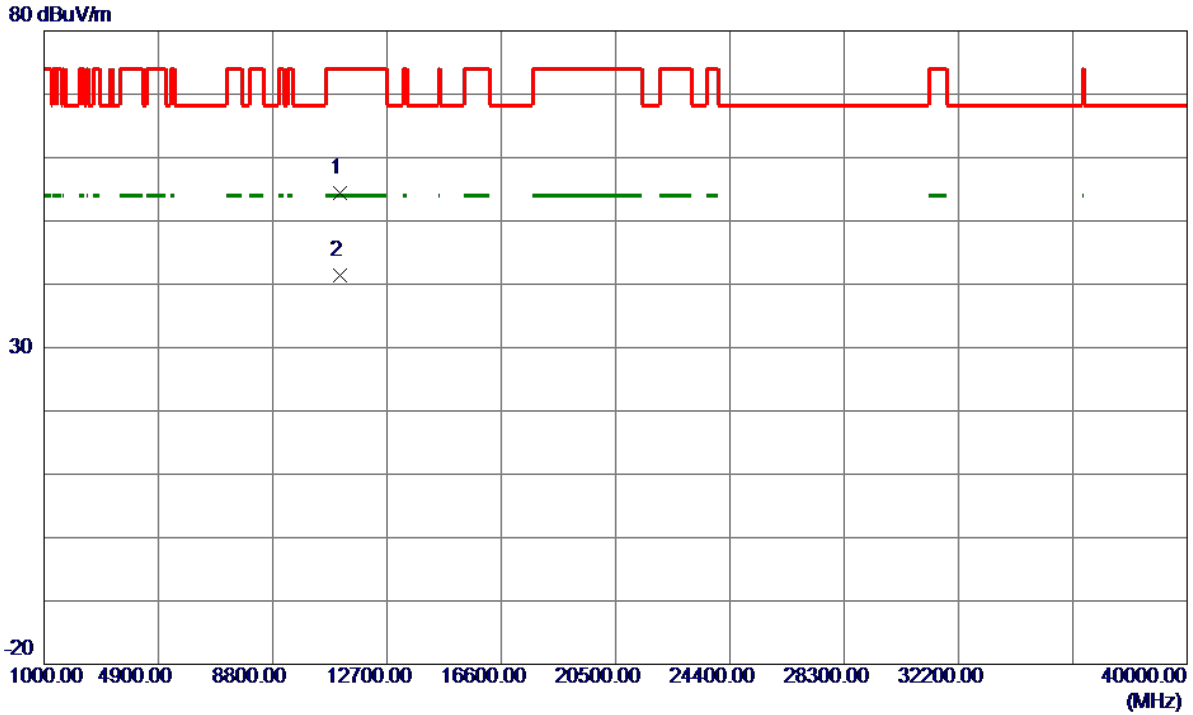

No.	Freq. MHz	Reading Level dBuV/m	Correct Factor dB	Measure ment dBuV/m	Limit dBuV/m	Margin dB	Detector	Comment
1	11095.3900	33.54	20.94	54.48	74.00	-19.52	Peak	
2 *	11103.4900	20.40	20.94	41.34	54.00	-12.66	AVG	

Orthogonal Axis :	X
Test Mode :	UNII-2C/ TX N40 Mode 5670MHz

Vertical

130 dBuV/m

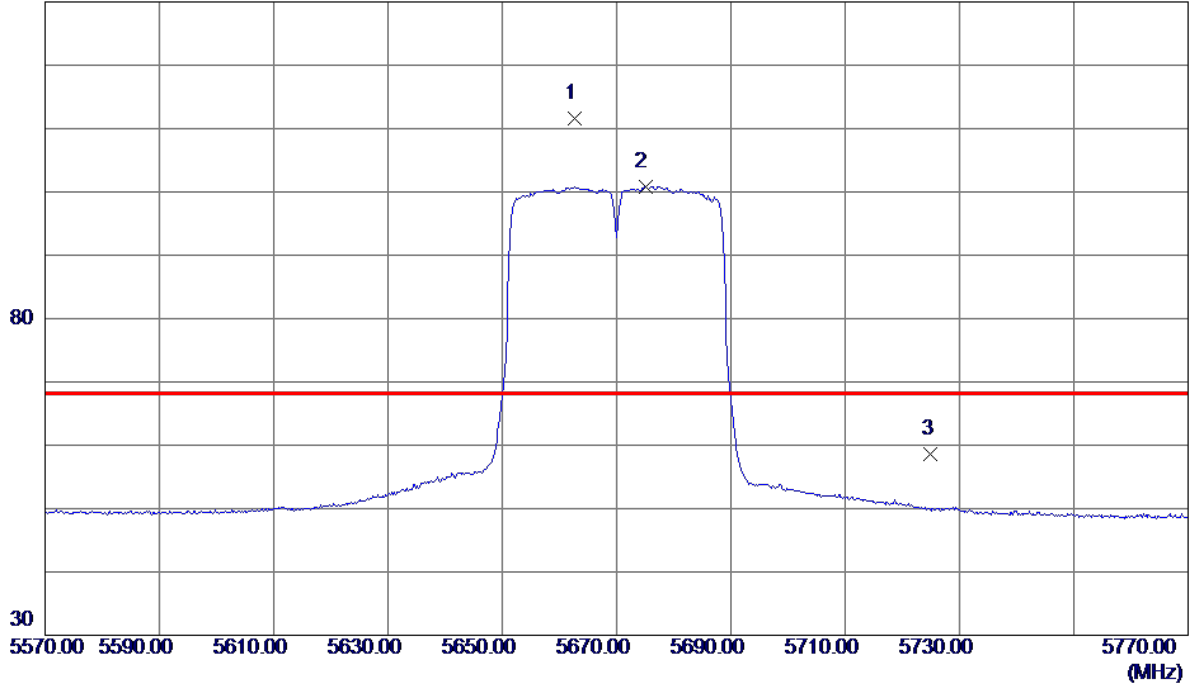

No.	Freq. MHz	Reading Level dBuV/m	Correct Factor dB	Measure ment dBuV/m	Limit dBuV/m	Margin dB	Detector	Comment
1 *	5662.6000	88.56	22.95	111.51	68.30	43.21	Peak	No Limit
2	5675.0000	77.88	23.00	100.88	999.00	-898.12	AVG	No Limit
3	5725.0000	35.48	23.20	58.68	68.30	-9.62	Peak	

Orthogonal Axis :	X
Test Mode :	UNII-2C/ TX N40 Mode 5670MHz

Vertical

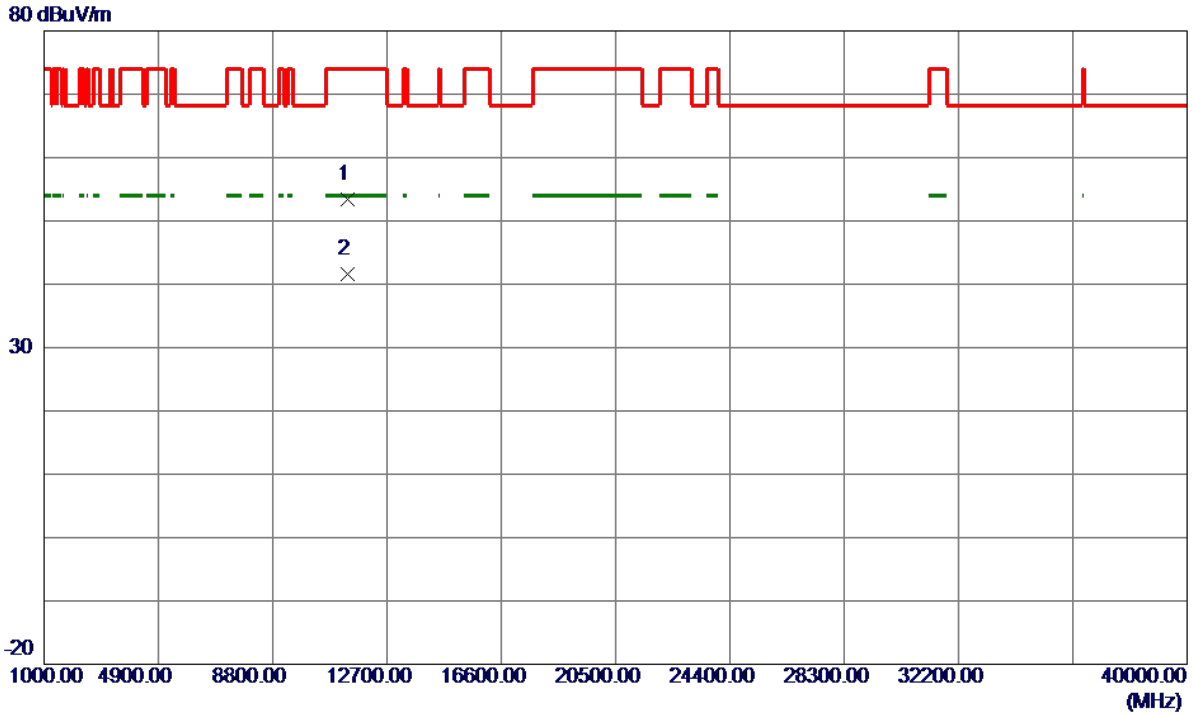

No.	Freq. MHz	Reading Level dBuV/m	Correct Factor dB	Measure ment dBuV/m	Limit dBuV/m	Margin dB	Detector	Comment
1	11340.2400	32.36	21.09	53.45	74.00	-20.55	Peak	
2 *	11343.6000	20.47	21.09	41.56	54.00	-12.44	AVG	

Orthogonal Axis :	X
Test Mode :	UNII-2C/ TX N40 Mode 5670MHz

Horizontal

130 dBuV/m

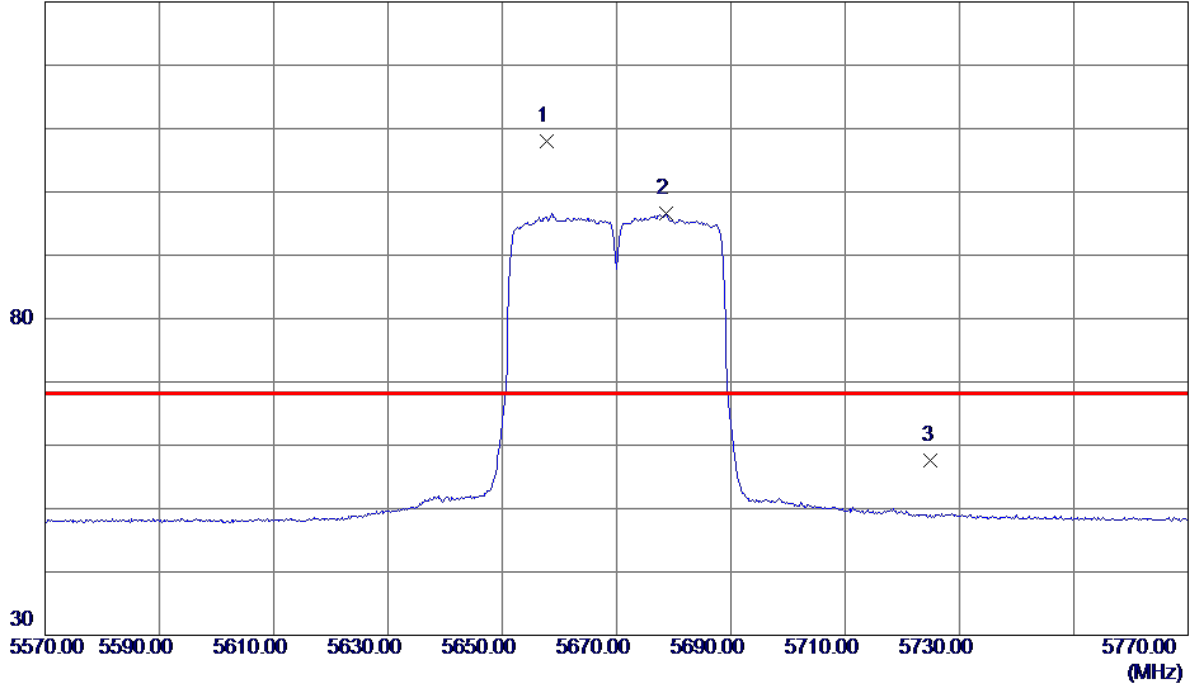

No.	Freq. MHz	Reading Level dBuV/m	Correct Factor dB	Measure ment dBuV/m	Limit dBuV/m	Margin dB	Detector	Comment
1 *	5657.8000	85.07	22.93	108.00	68.30	39.70	Peak	No Limit
2	5678.6000	73.59	23.01	96.60	999.00	-902.40	AVG	No Limit
3	5725.0000	34.40	23.20	57.60	68.30	-10.70	Peak	

Orthogonal Axis :	X
Test Mode :	UNII-2C/ TX N40 Mode 5670MHz

Horizontal

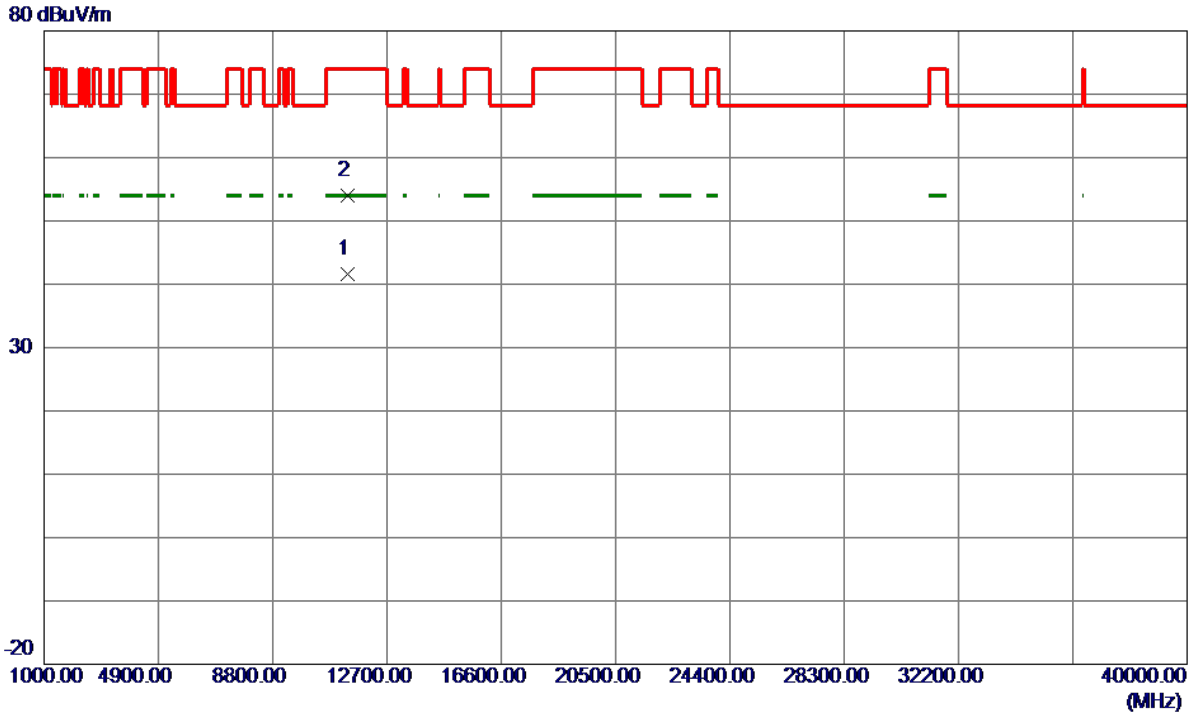

No.	Freq. MHz	Reading Level dBuV/m	Correct Factor dB	Measure ment dBuV/m	Limit dBuV/m	Margin dB	Detector	Comment
1 *	11340.0400	20.43	21.09	41.52	54.00	-12.48	AVG	
2	11342.7000	32.83	21.09	53.92	74.00	-20.08	Peak	

Orthogonal Axis:	X
Test Mode:	UNII-3/TX A Mode 5745MHz

Vertical

130 dBuV/m

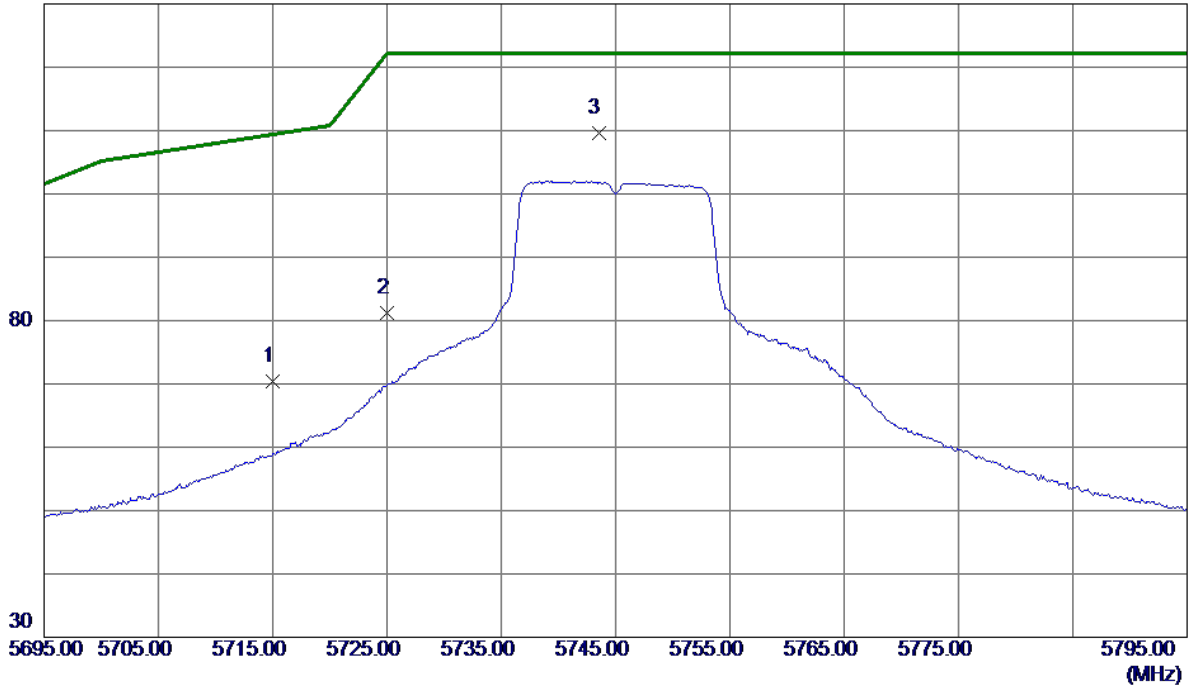

No.	Freq. MHz	Reading Level dBuV/m	Correct Factor dB	Measure ment dBuV/m	Limit dBuV/m	Margin dB	Detector	Comment
1	5715.0000	47.30	23.16	70.46	109.40	-38.94	Peak	
2	5725.0000	57.91	23.20	81.11	122.20	-41.09	Peak	
3 *	5743.5000	86.38	23.27	109.65	122.20	-12.55	Peak	

Orthogonal Axis:	X
Test Mode:	UNII-3/TX A Mode 5745MHz

Vertical

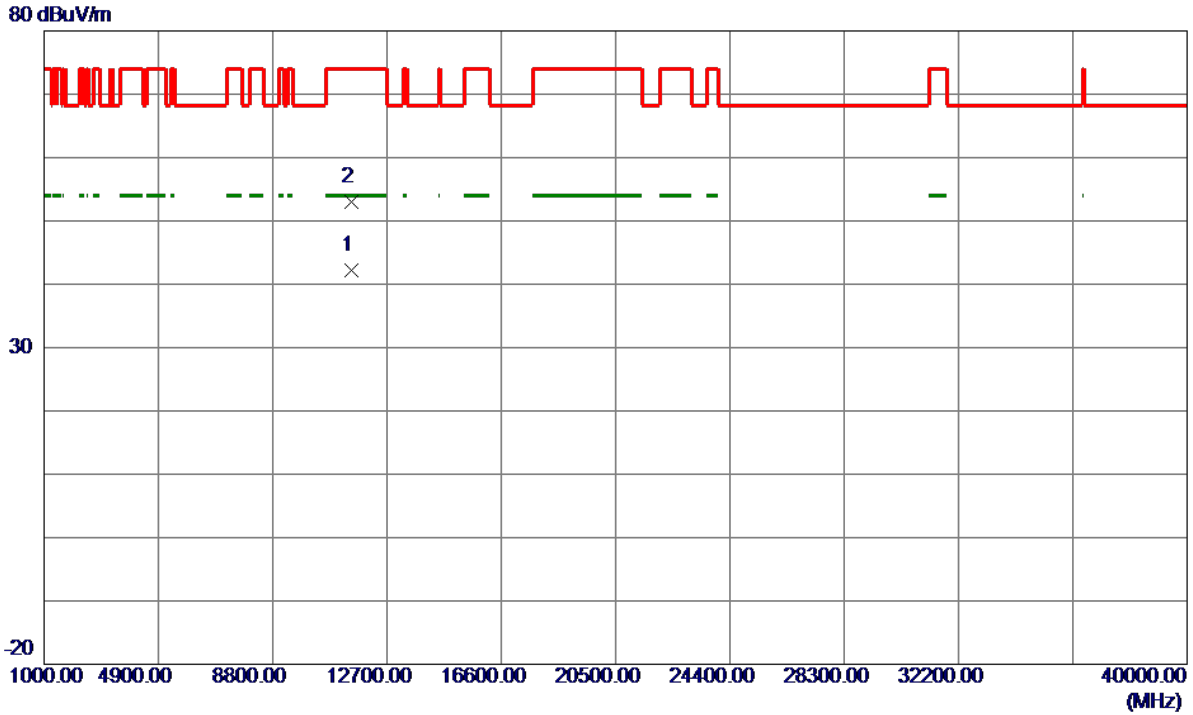

No.	Freq. MHz	Reading Level dBuV/m	Correct Factor dB	Measure ment dBuV/m	Limit dBuV/m	Margin dB	Detector	Comment
1 *	11491.4000	21.02	21.18	42.20	54.00	-11.80	AVG	
2	11492.0599	31.77	21.18	52.95	74.00	-21.05	Peak	

Orthogonal Axis:	X
Test Mode:	UNII-3/TX A Mode 5745MHz

Horizontal

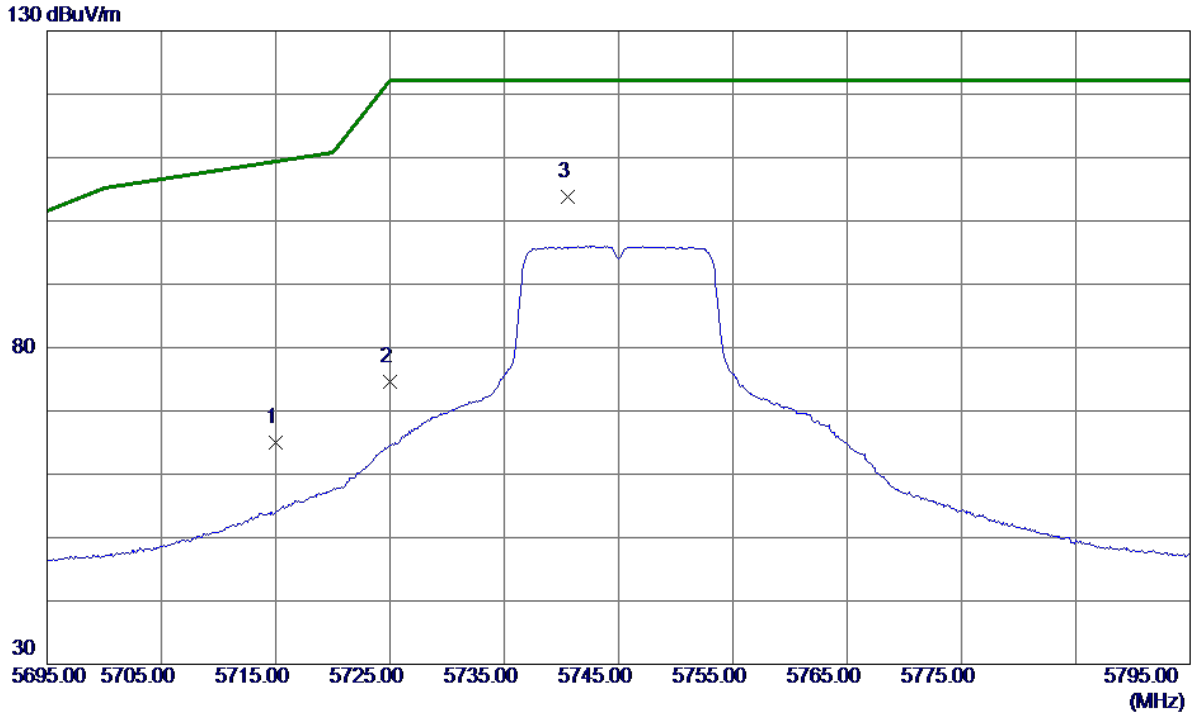

No.	Freq. MHz	Reading Level dBuV/m	Correct Factor dB	Measure ment dBuV/m	Limit dBuV/m	Margin dB	Detector	Comment
1	5715.0000	41.78	23.16	64.94	109.40	-44.46	Peak	
2	5725.0000	51.40	23.20	74.60	122.20	-47.60	Peak	
3 *	5740.6000	80.50	23.26	103.76	122.20	-18.44	Peak	

Orthogonal Axis:	X
Test Mode:	UNII-3/TX A Mode 5745MHz

Horizontal

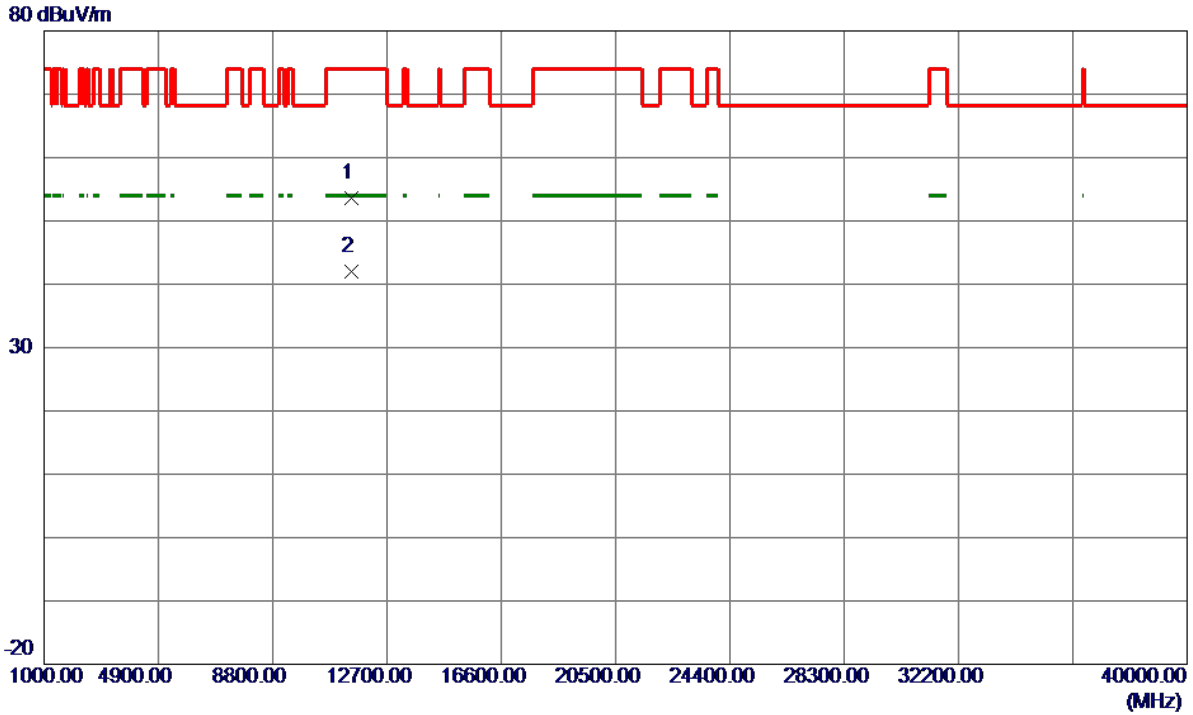

No.	Freq. MHz	Reading Level dBuV/m	Correct Factor dB	Measure ment dBuV/m	Limit dBuV/m	Margin dB	Detector	Comment
1	11489.5050	32.43	21.18	53.61	74.00	-20.39	Peak	
2 *	11492.1400	20.84	21.18	42.02	54.00	-11.98	AVG	

Orthogonal Axis:	X
Test Mode:	UNII-3/TX A Mode 5785MHz

Vertical

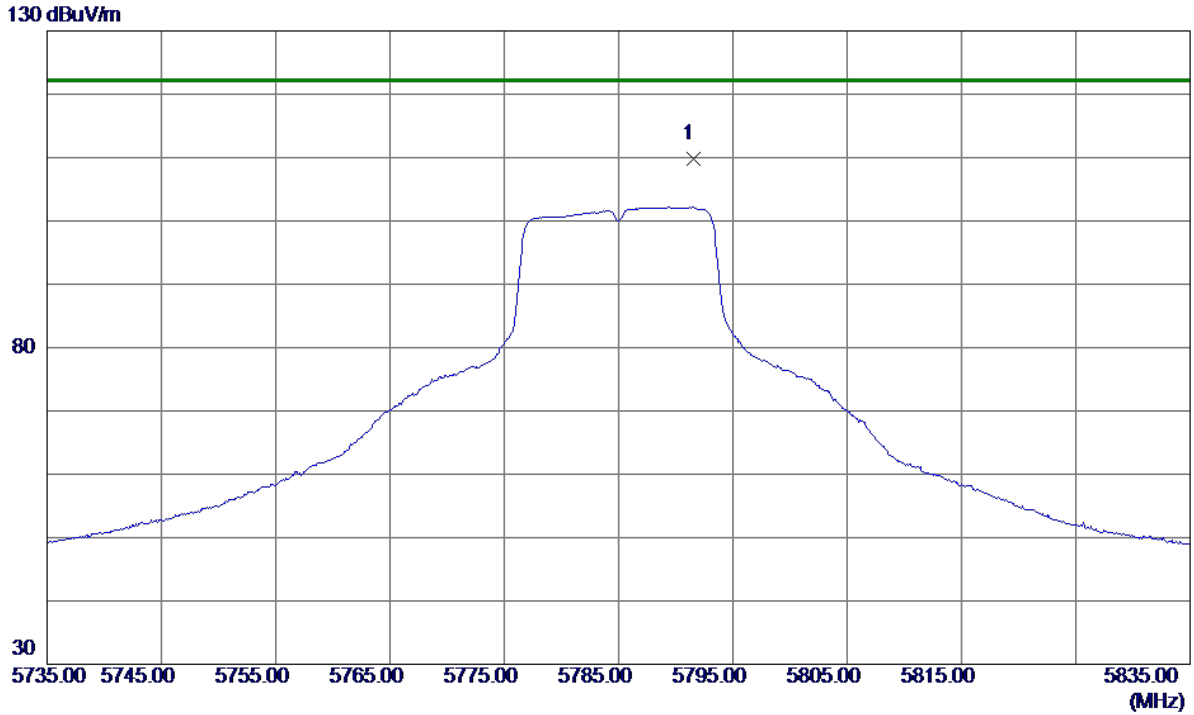

No.	Freq. MHz	Reading Level dBuV/m	Correct Factor dB	Measure ment dBuV/m	Limit dBuV/m	Margin dB	Detector	Comment
1 *	5791.5000	86.35	23.46	109.81	122.20	-12.39	Peak	

Orthogonal Axis:	X
Test Mode:	UNII-3/TX A Mode 5785MHz

Vertical

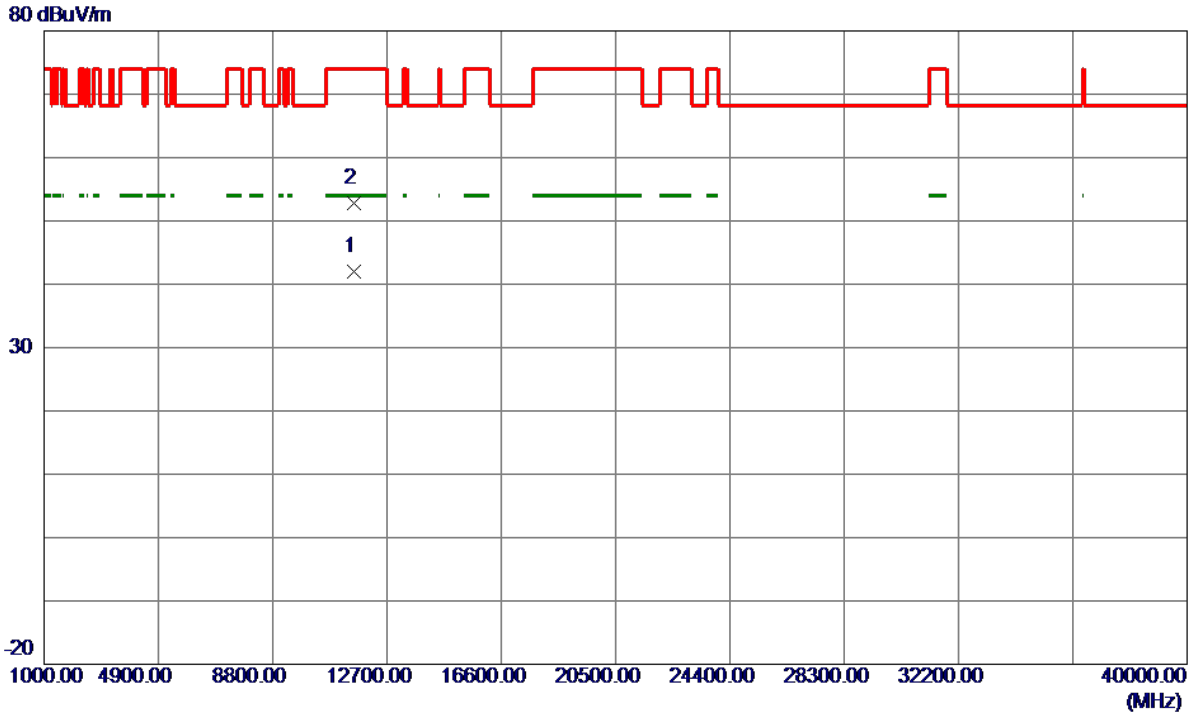

No.	Freq. MHz	Reading Level dBuV/m	Correct Factor dB	Measure ment dBuV/m	Limit dBuV/m	Margin dB	Detector	Comment
1 *	11568.3700	20.74	21.22	41.96	54.00	-12.04	AVG	
2	11569.4700	31.55	21.22	52.77	74.00	-21.23	Peak	

Orthogonal Axis:	X
Test Mode:	UNII-3/TX A Mode 5785MHz

Horizontal

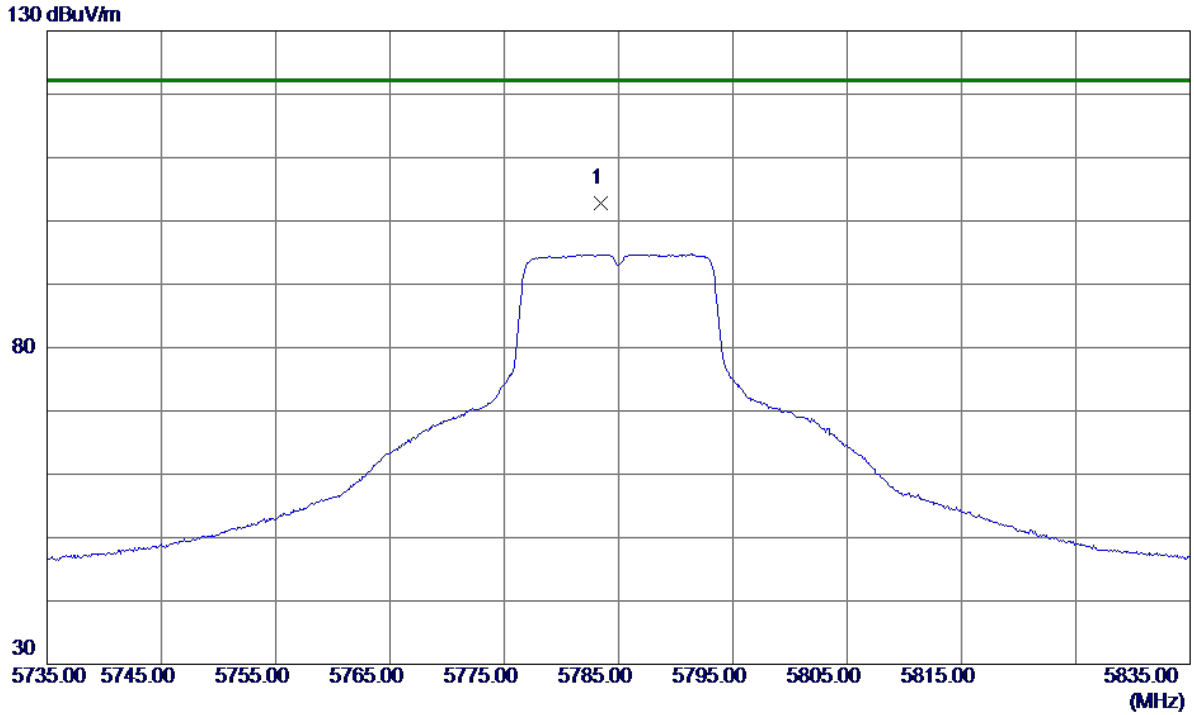

No.	Freq. MHz	Reading Level dBuV/m	Correct Factor dB	Measure ment dBuV/m	Limit dBuV/m	Margin dB	Detector	Comment
1 *	5783.4000	79.32	23.43	102.75	122.20	-19.45	Peak	

Orthogonal Axis:	X
Test Mode:	UNII-3/TX A Mode 5785MHz

Horizontal

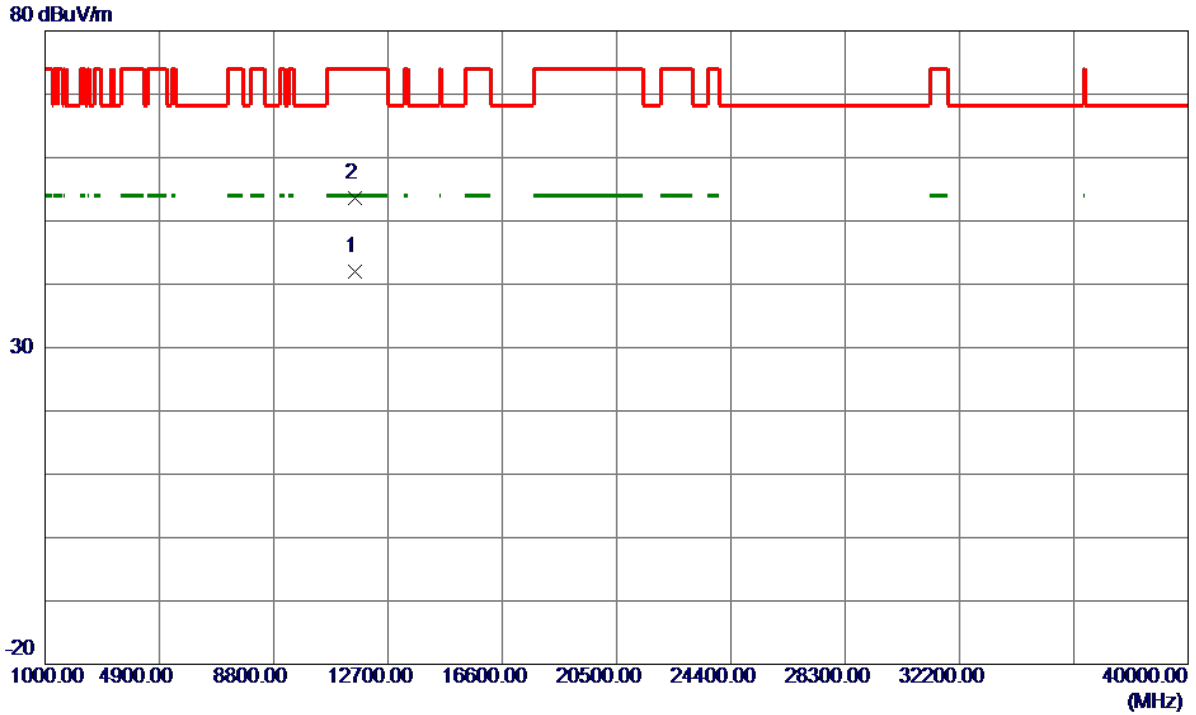

No.	Freq. MHz	Reading Level dBuV/m	Correct Factor dB	Measure ment dBuV/m	Limit dBuV/m	Margin dB	Detector	Comment
1 *	11569.4600	20.74	21.22	41.96	54.00	-12.04	AVG	
2	11569.6849	32.42	21.22	53.64	74.00	-20.36	Peak	