

# FCC Radio Test Report

## FCC ID: VW3DIW387

This report concerns (check one): Original Grant Class I Change Class II Change

Project No. : 1802C015A  
Equipment : Android TV DIW387 UHD  
Test Model : DIW387 UHD  
Series Model : N/A  
P/N : 253775312  
S/N : 618220036736  
Applicant : SAGEMCOM BROADBAND SAS  
Address : 250 Route de l'Empereur - 92848 RUEIL  
MALMAISON CEDEX- FRANCE

Date of Receipt : Jul. 10, 2018  
Date of Test : Jul. 11, 2018 ~ Jul. 28, 2018  
Issued Date : Sep. 14, 2018  
Tested by : BTL Inc.

Testing Engineer : Kai Xu  
(Kai Xu)

Technical Manager : Shawn Xiao  
(Shawn Xiao)

Authorized Signatory : Steven Lu  
(Steven Lu)

# **B T L I N C .**

No.3, Jinshagang 1st Road, Shixia, Dalang Town, Dongguan,  
Guangdong, China.

TEL: +86-769-8318-3000 FAX: +86-769-8319-6000



### **Declaration**

**BTL** represents to the client that testing is done in accordance with standard procedures as applicable and that test instruments used has been calibrated with standards traceable to international standard(s) and/or national standard(s).

**BTL's** reports apply only to the specific samples tested under conditions. It is manufacture's responsibility to ensure that additional production units of this model are manufactured with the identical electrical and mechanical components. **BTL** shall have no liability for any declarations, inferences or generalizations drawn by the client or others from **BTL** issued reports.

The report must not be used by the client to claim product certification, approval, or endorsement by NVLAP, NIST, or any agency of the U.S. Government.

This report is the confidential property of the client. As a mutual protection to the clients, the public and ourselves, the test report shall not be reproduced, except in full, without our written approval.

**BTL's** laboratory quality assurance procedures are in compliance with the **ISO Guide 17025** requirements, and accredited by the conformity assessment authorities listed in this test report.

**BTL** is not responsible for the sampling stage, so the results only apply to the sample as received.

The information, data and test plan are provided by manufacturer, so it is manufacturer's responsibility to ensure that the apparatus meets the essential requirements in all the possible configurations as representative of its intended use.

### **Limitation**

For the use of the authority's logo is limited unless the Test Standard(s)/Scope(s)/Item(s) mentioned in this test report is (are) included in the conformity assessment authorities acceptance respective.

<b>Table of Contents</b>	<b>Page</b>
<b>1 . CERTIFICATION</b>	<b>6</b>
<b>2 . SUMMARY OF TEST RESULTS</b>	<b>7</b>
2.1 TEST FACILITY	8
2.2 MEASUREMENT UNCERTAINTY	8
<b>3 . GENERAL INFORMATION</b>	<b>9</b>
3.1 GENERAL DESCRIPTION OF EUT	9
3.2 DESCRIPTION OF TEST MODES	11
3.3 TABLE OF PARAMETERS OF TEXT SOFTWARE SETTING	11
3.4 BLOCK DIAGRAM SHOWING THE CONFIGURATION OF SYSTEM TESTED	12
3.5 DESCRIPTION OF SUPPORT UNITS	12
<b>4 . EMC EMISSION TEST</b>	<b>13</b>
4.1 CONDUCTED EMISSION MEASUREMENT	13
4.1.1 POWER LINE CONDUCTED EMISSION LIMITS	13
4.1.2 TEST PROCEDURE	13
4.1.3 DEVIATION FROM TEST STANDARD	13
4.1.4 TEST SETUP	14
4.1.5 EUT OPERATING CONDITIONS	14
4.1.6 EUT TEST CONDITIONS	14
4.1.7 TEST RESULTS	14
4.2 RADIATED EMISSION MEASUREMENT	15
4.2.1 RADIATED EMISSION LIMITS	15
4.2.2 TEST PROCEDURE	16
4.2.3 DEVIATION FROM TEST STANDARD	16
4.2.4 TEST SETUP	17
4.2.5 EUT OPERATING CONDITIONS	18
4.2.6 EUT TEST CONDITIONS	18
4.2.7 TEST RESULTS (9KHZ TO 30MHZ)	18
4.2.8 TEST RESULTS (30MHZ TO 1000MHZ)	18
4.2.9 TEST RESULTS (ABOVE 1000MHZ)	18
<b>5 . BANDWIDTH TEST</b>	<b>19</b>
5.1 APPLIED PROCEDURES / LIMIT	19
5.1.1 TEST PROCEDURE	19
5.1.2 DEVIATION FROM STANDARD	19
5.1.3 TEST SETUP	19
5.1.4 EUT OPERATION CONDITIONS	19
5.1.5 EUT TEST CONDITIONS	19
5.1.6 TEST RESULTS	19
<b>6 . MAXIMUM OUTPUT POWER TEST</b>	<b>20</b>

<b>Table of Contents</b>	<b>Page</b>
<b>6.1 APPLIED PROCEDURES / LIMIT</b>	<b>20</b>
6.1.1 TEST PROCEDURE	20
6.1.2 DEVIATION FROM STANDARD	20
6.1.3 TEST SETUP	20
6.1.4 EUT OPERATION CONDITIONS	20
6.1.5 EUT TEST CONDITIONS	20
6.1.6 TEST RESULTS	20
<b>7 . ANTENNA CONDUCTED SPURIOUS EMISSION</b>	<b>21</b>
7.1 APPLIED PROCEDURES / LIMIT	21
7.1.1 TEST PROCEDURE	21
7.1.2 DEVIATION FROM STANDARD	21
7.1.3 TEST SETUP	21
7.1.4 EUT OPERATION CONDITIONS	21
7.1.5 EUT OPERATION CONDITIONS	21
7.1.6 TEST RESULTS	21
<b>8 . POWER SPECTRAL DENSITY TEST</b>	<b>22</b>
8.1 APPLIED PROCEDURES / LIMIT	22
8.1.1 TEST PROCEDURE	22
8.1.2 DEVIATION FROM STANDARD	22
8.1.3 TEST SETUP	22
8.1.4 EUT OPERATION CONDITIONS	22
8.1.5 EUT TEST CONDITIONS	22
8.1.6 TEST RESULTS	22
<b>9 . MEASUREMENT INSTRUMENTS LIST</b>	<b>23</b>
<b>10 . EUT TEST PHOTO</b>	<b>25</b>
<b>APPENDIX A - CONDUCTED EMISSION</b>	<b>29</b>
<b>APPENDIX B - RADIATED EMISSION (9KHZ TO 30MHZ)</b>	<b>32</b>
<b>APPENDIX C - RADIATED EMISSION (30MHZ TO 1000MHZ)</b>	<b>37</b>
<b>APPENDIX D - RADIATED EMISSION (ABOVE 1000MHZ)</b>	<b>44</b>
<b>APPENDIX E - BANDWIDTH</b>	<b>57</b>
<b>APPENDIX F - MAXIMUM OUTPUT POWER TEST</b>	<b>60</b>
<b>APPENDIX G - ANTENNA CONDUCTED SPURIOUS EMISSION</b>	<b>62</b>
<b>APPENDIX H - POWER SPECTRAL DENSITY TEST</b>	<b>69</b>

### REPORT ISSUED HISTORY

Issued No.	Description	Issued Date
BTL-FCCP-2-1802C015A	Original Issue.	Sep. 14, 2018

## 1. CERTIFICATION

Equipment : Android TV DIW387 UHD  
Brand Name : SAGEMCOM  
Test Model : DIW387 UHD  
Series Model : N/A  
P/N : 253775312  
S/N : 618220036736  
Applicant : SAGEMCOM BROADBAND SAS  
Manufacturer : SAGEMCOM BROADBAND SAS  
Address : 250 Route de l' Empereur - 92848 RUEIL MALMAISON CEDEX- FRANCE  
Date of Test : Jul. 11, 2018 ~ Jul. 28, 2018  
Test Sample : Engineering Sample No.: D180705661  
Standard(s) : FCC Part15, Subpart C (15.247)/ ANSI C63.10-2013

The above equipment has been tested and found compliance with the requirement of the relative standards by BTL Inc.

The test data, data evaluation, and equipment configuration contained in our test report (Ref No. BTL-FCCP-2-1802C015A) were obtained utilizing the test procedures, test instruments, test sites that has been accredited by the Authority of NVLAP according to the ISO-17025 quality assessment standard and technical standard(s).

**Test results included in this report is only for the Bluetooth LE part.**

## 2. SUMMARY OF TEST RESULTS

Test procedures according to the technical standard(s):

Applied Standard(s): FCC Part15 (15.247) , Subpart C			
Standard(s) Section	Test Item	Judgment	Remark
15.207	Conducted Emission	PASS	
15.247(d)	Antenna conducted Spurious Emission	PASS	
15.247(a)(2)	6dB Bandwidth	PASS	
15.247(b)(3)	Maximum output power	PASS	
15.247(e)	Power Spectral Density	PASS	
15.203	Antenna Requirement	PASS	
15.247(d)/ 15.205/ 15.209	Transmitter Radiated Emissions	PASS	

**NOTE:**

(1) "N/A" denotes test is not applicable to this device.

## 2.1 TEST FACILITY

The test facilities used to collect the test data in this report is at the location of No.3, Jinshagang 1st Road, Shixia, Dalang Town, Dongguan, Guangdong, China.

BTL's test firm number for FCC: 854385

BTL's designation number for FCC: CN5020

## 2.2 MEASUREMENT UNCERTAINTY

The measurement uncertainty figures shall be calculated according the methods described in the ETSI TR 100 028 and shall correspond to an expansion factor (coverage factor)  $k=1.96$  or  $k=2$ (which provide confidence levels of respectively 90% and 95.45% in the case where the distributions characterizing the actual measurement uncertainties are normal (Gaussian)). Measurement Uncertainty for a Level of Confidence of 95 %,  $U=2xUc(y)$ .

The BTL measurement uncertainty as below table:

### A. Conducted Measurement:

Test Site	Method	Measurement Frequency Range	U, (dB)
DG-C02	CISPR	150 KHz ~ 30MHz	2.32

### B. Radiated Measurement:

Test Site	Method	Measurement Frequency Range	Ant. H / V	U, (dB)
DG-CB03	CISPR	9KHz~30MHz	V	3.79
		9KHz~30MHz	H	3.57
		30MHz ~ 200MHz	V	3.82
		30MHz ~ 200MHz	H	3.78
		200MHz ~ 1,000MHz	V	4.10
		200MHz ~ 1,000MHz	H	4.06
		1GHz~18GHz	V	3.12
		1GHz~18GHz	H	3.68
		18GHz~40GHz	V	4.15
		18GHz~40GHz	H	4.14

Note: Unless specifically mentioned, the uncertainty of measurement has not been taken into account to declare the compliance or non-compliance to the specification.



### 3. GENERAL INFORMATION

#### 3.1 GENERAL DESCRIPTION OF EUT

Equipment	Android TV DIW387 UHD	
Brand Name	SAGEMCOM	
Test Model	DIW387 UHD	
Series Model	N/A	
Model Difference	N/A	
P/N	253775312	
S/N	618220036736	
Hardware Version	PCBA 253775268	
Software Version	BCM SDK:17.1 BOMODE:6	
Product Description	Operation Frequency	2402 ~ 2480 MHz
	Modulation Technology	GFSK(1Mbps)
	Bit Rate of Transmitter	
	Output Power (Max.)	3.72 dBm (1Mbps)
Power Source	DC voltage supplied from AC/DC adapter. Brand / Model: SAGEMCOM / NBS24K120200VU	
Power Rating	I/P: 100-120V~50/60Hz 0.6A O/P: 12V=2.0A	

Note:

1. For a more detailed features description, please refer to the manufacturer's specifications or the user's manual.

2. Channel List:

Channel	Frequency (MHz)	Channel	Frequency (MHz)
00	2402	20	2442
01	2404	21	2444
02	2406	22	2446
03	2408	23	2448
04	2410	24	2450
05	2412	25	2452
06	2414	26	2454
07	2416	27	2456
08	2418	28	2458
09	2420	29	2460
10	2422	30	2462
11	2424	31	2464
12	2426	32	2466
13	2428	33	2468
14	2430	34	2470
15	2432	35	2472
16	2434	36	2474
17	2436	37	2476
18	2438	38	2478
19	2440	39	2480

3. Table for Filed Antenna:

Ant.	Brand	Model Name	Antenna Type	Connector	Gain (dBi)
1	N/A	N/A	PCB	N/A	3.59

### 3.2 DESCRIPTION OF TEST MODES

To investigate the maximum EMI emission characteristics generates from EUT, the test system was pre-scanning tested base on the consideration of following EUT operation mode or test configuration mode which possible have effect on EMI emission level. Each of these EUT operation mode(s) or test configuration mode(s) mentioned above was evaluated respectively.

Pretest Mode	Description
Mode 1	TX Mode <b>NOTE (1)</b>

The EUT system operated these modes were found to be the worst case during the pre-scanning test as following:

For Conducted Test	
Final Test Mode	Description
Mode 1	TX Mode

For Radiated Test	
Final Test Mode	Description
Mode 1	TX Mode <b>NOTE (1)</b>

Note:

(1) The measurements are performed at the high, middle, low available channels.

### 3.3 TABLE OF PARAMETERS OF TEXT SOFTWARE SETTING

During testing channel & power controlling software provided by the customer was used to control the operating channel as well as the output power level. The RF output power selection is for the setting of RF output power expected by the customer and is going to be fixed on the firmware of the final end product power parameters of BT LE

Test Software Version	cmd		
Frequency (MHz)	2402	2440	2480
BT LE	N/A	N/A	N/A

### 3.4 BLOCK DIAGRAM SHOWING THE CONFIGURATION OF SYSTEM TESTED

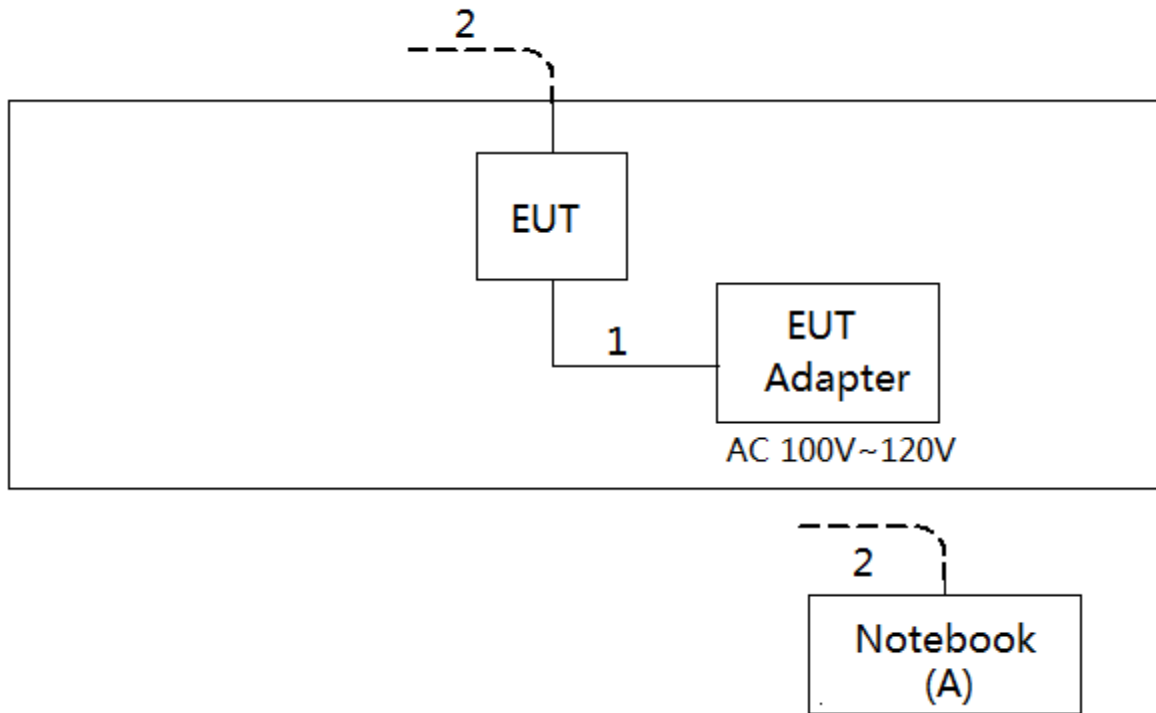

### 3.5 DESCRIPTION OF SUPPORT UNITS

The EUT has been tested as an independent unit together with other necessary accessories or support units. The following support units or accessories were used to form a representative test configuration during the tests.

Item	Equipment	Mfr/Brand	Model/Type No.	FCC ID	Series No.
A	Notebook	Dell	DCSM	DOC	G7K832X

Item	Shielded Type	Ferrite Core	Length	Note
1	NO	NO	2m	DC Cable
2	NO	NO	10m	RJ45 Cable

## 4. EMC EMISSION TEST

### 4.1 CONDUCTED EMISSION MEASUREMENT

#### 4.1.1 POWER LINE CONDUCTED EMISSION LIMITS (Frequency Range 150KHz-30MHz)

Frequency of Emission (MHz)	Conducted Limit (dB $\mu$ V)	
	Quasi-peak	Average
0.15 -0.5	66 to 56*	56 to 46*
0.50 -5.0	56	46
5.0 -30.0	60	50

Note:

- (1) The limit of " \* " decreases with the logarithm of the frequency
- (2) The test result calculated as following:  
 Measurement Value = Reading Level + Correct Factor  
 Correct Factor = Insertion Loss + Cable Loss + Attenuator Factor(if use)  
 Margin Level = Measurement Value - Limit Value

The following table is the setting of the receiver

Receiver Parameters	Setting
Attenuation	10 dB
Start Frequency	0.15 MHz
Stop Frequency	30 MHz
IF Bandwidth	9 kHz

#### 4.1.2 TEST PROCEDURE

- a. The EUT was placed 0.8 meters from the horizontal ground plane with EUT being connected to the power mains through a line impedance stabilization network (LISN). All other support equipment powered from additional LISN(s). The LISN provide 50 Ohm/ 50uH of coupling impedance for the measuring instrument.
- b. Interconnecting cables that hang closer than 40 cm to the ground plane shall be folded back and forth in the center forming a bundle 30 to 40 cm long.
- c. I/O cables that are not connected to a peripheral shall be bundled in the center. The end of the cable may be terminated, if required, using the correct terminating impedance. The overall length shall not exceed 1 m.
- d. LISN at least 80 cm from nearest part of EUT chassis.
- e. For the actual test configuration, please refer to the related Item –EUT Test Photos.

#### 4.1.3 DEVIATION FROM TEST STANDARD

No deviation

#### 4.1.4 TEST SETUP

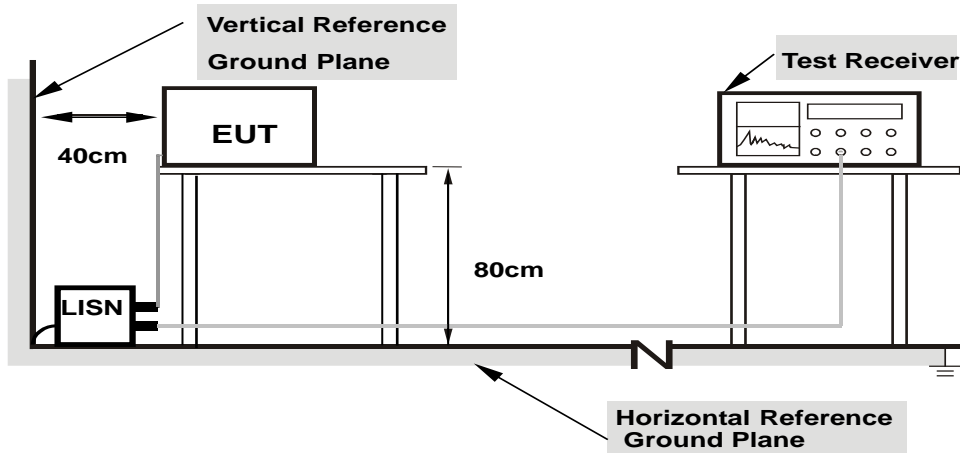

- Note:**
- 1.Support units were connected to second LISN.
  - 2.Both of LISNs (AMN) are 80 cm from EUT and at least 80 from other units and other metal planes

#### 4.1.5 EUT OPERATING CONDITIONS

The EUT was configured for testing in a typical fashion (as a customer would normally use it). The EUT has been programmed to continuously transmit during test. This operating condition was tested and used to collect the included data.

#### 4.1.6 EUT TEST CONDITIONS

Temperature: 24°C    Relative Humidity: 60%    Test Voltage: AC 120V/60Hz

#### 4.1.7 TEST RESULTS

Please refer to the Appendix A.

Remark:

- (1) All readings are QP Mode value unless otherwise stated AVG in column of『Note』. If the QP Mode Measured value compliance with the QP Limits and lower than AVG Limits, the EUT shall be deemed to meet both QP & AVG Limits and then only QP Mode was measured, but AVG Mode didn't perform. In this case, a " \* " marked in AVG Mode column of Interference Voltage Measured.
- (2) Measuring frequency range from 150KHz to 30MHz.
- (3) " N/A " denotes test is not applicable to this device.

## 4.2 RADIATED EMISSION MEASUREMENT

### 4.2.1 RADIATED EMISSION LIMITS

In case the emission fall within the restricted band specified on 15.205(a), then the 15.209(a) limit in the table below has to be followed.

#### LIMITS OF RADIATED EMISSION MEASUREMENT (9KHz-1000MHz)

Frequency (MHz)	Field Strength (microvolts/meter)	Measurement Distance (meters)
0.009~0.490	2400/F(KHz)	300
0.490~1.705	24000/F(KHz)	30
1.705~30.0	30	30
30~88	100	3
88~216	150	3
216~960	200	3
960~1000	500	3

#### LIMITS OF RADIATED EMISSION MEASUREMENT (Above 1000MHz)

Frequency (MHz)	(dBuV/m) (at 3 meters)	
	PEAK	AVERAGE
Above 1000	74	54

#### Notes:

- (1) The limit for radiated test was performed according to FCC PART 15C.
- (2) The tighter limit applies at the band edges.
- (3) Emission level (dBuV/m)=20log Emission level (uV/m).
- (4) The test result calculated as following:  
 Measurement Value = Reading Level + Correct Factor  
 Correct Factor = Antenna Factor + Cable Loss - Amplifier Gain(if use)  
 Margin Level = Measurement Value - Limit Value

Spectrum Parameter	Setting
Attenuation	Auto
Start Frequency	1000 MHz
Stop Frequency	10th carrier harmonic
RBW / VBW (Emission in restricted band)	RBW 1MHz VBW 3MHz peak detector for Pk value RMS detector for AV value

Receiver Parameter	Setting
Attenuation	Auto
Start ~ Stop Frequency	9KHz~90KHz for PK/AVG detector
Start ~ Stop Frequency	90KHz~110KHz for QP detector
Start ~ Stop Frequency	110KHz~490KHz for PK/AVG detector
Start ~ Stop Frequency	490KHz~30MHz for QP detector
Start ~ Stop Frequency	30MHz~1000MHz for QP detector

#### 4.2.2 TEST PROCEDURE

- a. The measuring distance of 3 m shall be used for measurements. The EUT was placed on the top of a rotating table 0.8 meter above the ground at a 3 meter semi-anechoic chamber. The table was rotated 360 degrees to determine the position of the highest radiation.(below 1GHz)
- b. The measuring distance of 3 m shall be used for measurements. The EUT was placed on the top of a rotating table 1.5 meter above the ground at a 3 meter semi-anechoic chamber. The table was rotated 360 degrees to determine the position of the highest radiation.(above 1GHz)
- c. The height of the equipment or of the substitution antenna shall be 0.8m or 1.5m; the height of the test antenna shall vary between 1 m to 4 m. Both horizontal and vertical polarizations of the antenna are set to make the measurement.
- d. For each suspected emission, the EUT was arranged to its worst case and then the antenna was tuned to heights find the maximum reading (used Bore sight function).
- e. The receiver system was set to peak and average detect function and specified bandwidth with maximum hold mode when the test frequency is above 1GHz.
- f. The initial step in collecting radiated emission data is a receiver peak detector mode pre-scanning the measurement frequency range. Significant peaks are then marked and then Quasi Peak detector mode re-measured.
- g. All readings are Peak unless otherwise stated QP in column of Note. Peak denotes that the Peak reading compliance with the QP Limits and then QP Mode measurement didn't perform. (below 1GHz)
- h. All readings are Peak Mode value unless otherwise stated AVG in column of Note. If the Peak Mode Measured value compliance with the Peak Limits and lower than AVG Limits, the EUT shall be deemed to meet both Peak & AVG Limits and then only Peak Mode was measured, but AVG Mode didn't perform. (above 1GHz)
- i. For the actual test configuration, please refer to the related Item –EUT Test Photos.

#### 4.2.3 DEVIATION FROM TEST STANDARD

No deviation



**4.2.4 TEST SETUP**

(A) Radiated Emission Test Set-Up Frequency Below 1 GHz

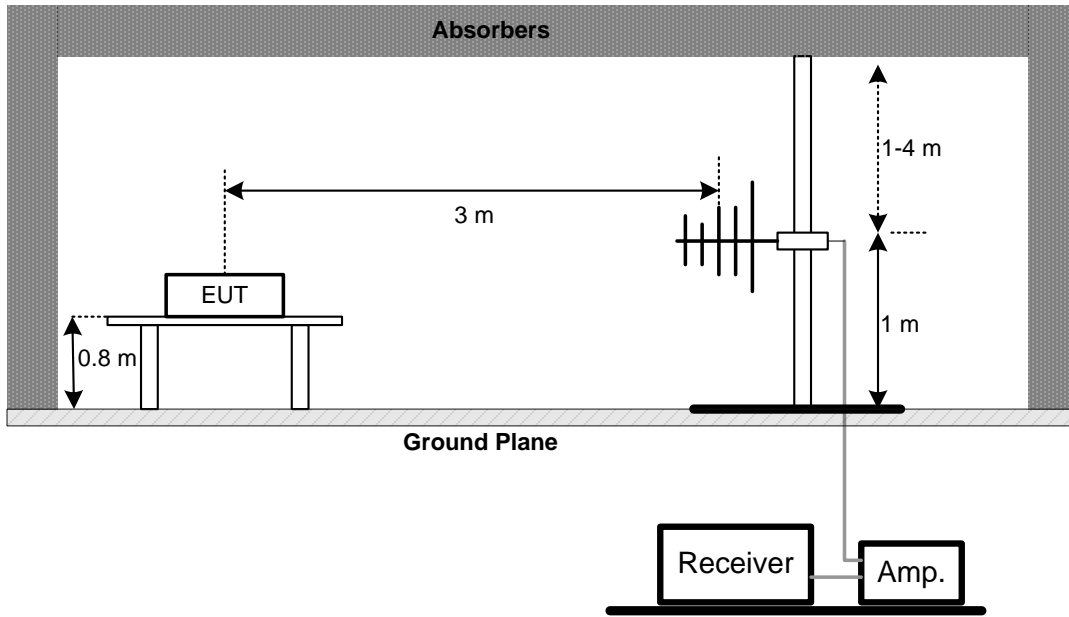

(B) Radiated Emission Test Set-Up Frequency Above 1 GHz

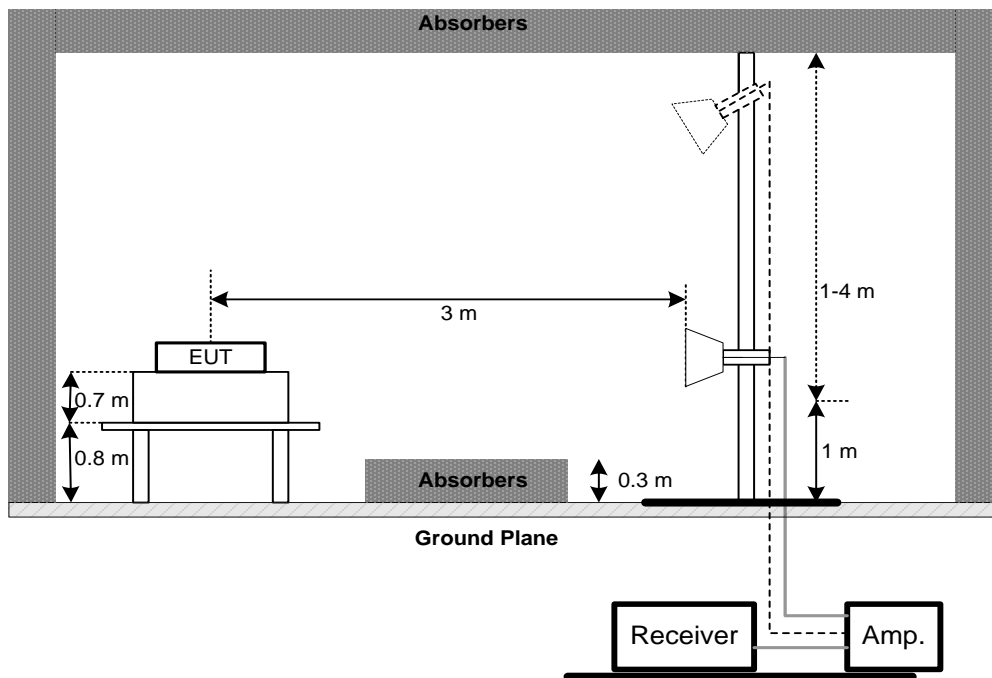

(C) For radiated emissions below 30MHz

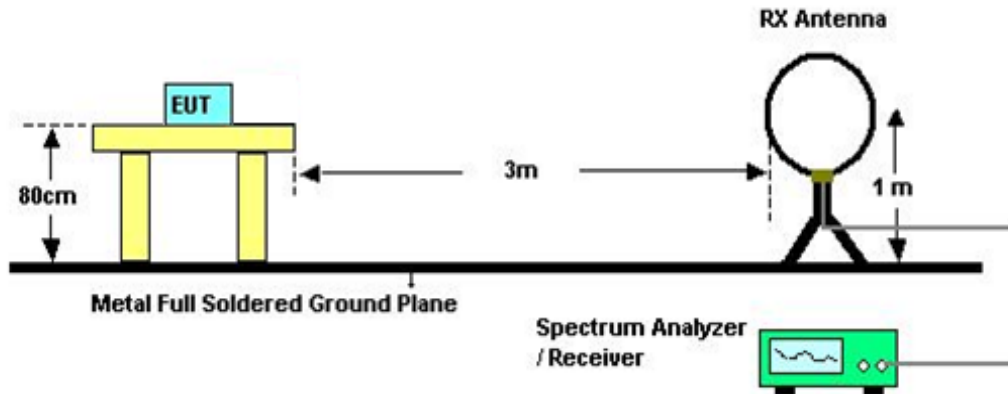

#### 4.2.5 EUT OPERATING CONDITIONS

The EUT was programmed to be in continuously transmitting mode.

#### 4.2.6 EUT TEST CONDITIONS

Temperature: 22°C Relative Humidity: 56% Test Voltage: AC 120V/60Hz

#### 4.2.7 TEST RESULTS (9KHZ TO 30MHZ)

Please refer to the Appendix B

Remark:

- (1) The amplitude of spurious emissions which are attenuated by more than 20 dB below the permissible value has no need to be reported.
- (2) Distance extrapolation factor =  $40 \log (\text{specific distance} / \text{test distance})$  (dB).
- (3) Limit line = specific limits (dBuV) + distance extrapolation factor.

#### 4.2.8 TEST RESULTS (30MHZ TO 1000MHZ)

Please refer to the Appendix C.

#### 4.2.9 TEST RESULTS (ABOVE 1000MHZ)

Please refer to the Appendix D.

Remark:

- (1) No limit: This is fundamental signal, the judgment is not applicable.  
For fundamental signal judgment was referred to Peak output test.

## 5. BANDWIDTH TEST

### 5.1 APPLIED PROCEDURES / LIMIT

FCC Part15 (15.247) , Subpart C				
Section	Test Item	Limit	Frequency Range (MHz)	Result
15.247(a)(2)	Bandwidth	$\geq 500\text{KHz}$ (6dB bandwidth)	2400-2483.5	PASS

#### 5.1.1 TEST PROCEDURE

- The EUT was directly connected to the spectrum analyzer and antenna output port as show in the block diagram below,
- Spectrum Setting : RBW= 100KHz, VBW=300KHz, Sweep time = 2.5 ms.

#### 5.1.2 DEVIATION FROM STANDARD

No deviation.

#### 5.1.3 TEST SETUP



#### 5.1.4 EUT OPERATION CONDITIONS

The EUT tested system was configured as the statements of 4.1.5 unless otherwise a special operating condition is specified in the follows during the testing.

#### 5.1.5 EUT TEST CONDITIONS

Temperature: 24°C    Relative Humidity: 60%    Test Voltage: AC 120V/60Hz

#### 5.1.6 TEST RESULTS

Please refer to the Appendix E.

## 6. MAXIMUM OUTPUT POWER TEST

### 6.1 APPLIED PROCEDURES / LIMIT

FCC Part15 (15.247) , Subpart C				
Section	Test Item	Limit	Frequency Range (MHz)	Result
15.247(b)(3)	Maximum Output Power	1 watt or 30dBm	2400-2483.5	PASS

#### 6.1.1 TEST PROCEDURE

- a. The EUT was directly connected to the power meter and antenna output port as show in the block diagram below,
- b. The maximum peak conducted output power was performed in accordance with method 9.1.2 of FCC KDB 558074 D01 DTS Meas Guidance.

#### 6.1.2 DEVIATION FROM STANDARD

No deviation.

#### 6.1.3 TEST SETUP

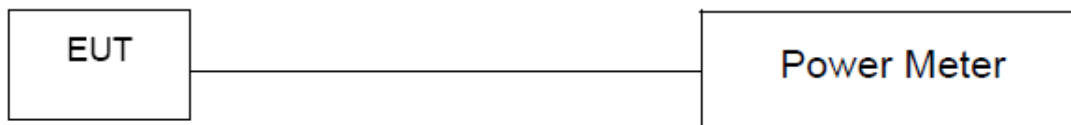

#### 6.1.4 EUT OPERATION CONDITIONS

The EUT tested system was configured as the statements of 4.1.5 unless otherwise a special operating condition is specified in the follows during the testing.

#### 6.1.5 EUT TEST CONDITIONS

Temperature: 24°C    Relative Humidity: 60%    Test Voltage: AC 120V/60Hz

#### 6.1.6 TEST RESULTS

Please refer to the Appendix F.

## 7. ANTENNA CONDUCTED SPURIOUS EMISSION

### 7.1 APPLIED PROCEDURES / LIMIT

In any 100 kHz bandwidth outside the frequency band in which the spread spectrum or digitally modulated intentional radiator is operating, the radio frequency power that is produced by the intentional radiator shall be at least 20 dB below that in the 100 kHz bandwidth within the band that contains the highest level of the desired power, based on either an RF conducted or a radiated measurement, provided the transmitter demonstrates compliance with the peak conducted power limits. If the transmitter complies with the conducted power limits based on the use of RMS averaging over a time interval, as permitted under paragraph (b)(3) of this section, the attenuation required under this paragraph shall be 30 dB instead of 20 dB. Attenuation below the general limits specified in Section 15.209(a) is not required. In addition, radiated emissions which fall in the restricted bands, as defined in Section 15.205(a), must also comply with the radiated emission limits specified in Section 15.209(a) (see Section 15.205(c)).

#### 7.1.1 TEST PROCEDURE

- a. The EUT was directly connected to the spectrum analyzer and antenna output port as show in the block diagram below,
- b. Spectrum Setting : RBW= 100KHz, VBW=300KHz, Sweep time = 10 ms.
- c. Offset=antenna gain+cable loss

#### 7.1.2 DEVIATION FROM STANDARD

No deviation.

#### 7.1.3 TEST SETUP



#### 7.1.4 EUT OPERATION CONDITIONS

The EUT tested system was configured as the statements of 4.1.5 unless otherwise a special operating condition is specified in the follows during the testing.

#### 7.1.5 EUT OPERATION CONDITIONS

Temperature: 24°C    Relative Humidity: 60%    Test Voltage: AC 120V/60Hz

#### 7.1.6 TEST RESULTS

Please refer to the Appendix G.

## 8. POWER SPECTRAL DENSITY TEST

### 8.1 APPLIED PROCEDURES / LIMIT

FCC Part15 (15.247) , Subpart C				
Section	Test Item	Limit	Frequency Range (MHz)	Result
15.247(e)	Power Spectral Density	8 dBm (in any 3KHz)	2400-2483.5	PASS

#### 8.1.1 TEST PROCEDURE

- a. The EUT was directly connected to the spectrum analyzer and antenna output port as show in the block diagram below,
- b. Spectrum Setting: RBW=3KHz, VBW=10 KHz, Sweep time = auto.

#### 8.1.2 DEVIATION FROM STANDARD

No deviation.

#### 8.1.3 TEST SETUP



#### 8.1.4 EUT OPERATION CONDITIONS

The EUT tested system was configured as the statements of 4.1.5 unless otherwise a special operating condition is specified in the follows during the testing.

#### 8.1.5 EUT TEST CONDITIONS

Temperature: 24°C    Relative Humidity: 60%    Test Voltage: AC 120V/60Hz

#### 8.1.6 TEST RESULTS

Please refer to the Appendix H.

## 9. MEASUREMENT INSTRUMENTS LIST

Conducted Emission Measurement					
Item	Kind of Equipment	Manufacturer	Type No.	Serial No.	Calibrated until
1	EMI Test Receiver	R&S	ESCI	100382	Mar. 11, 2019
2	LISN	EMCO	3816/2	52765	Mar. 11, 2019
3	50Ω Terminator	SHX	TF2-3G-A	8122901	Mar. 11, 2019
4	TWO-LINE V-NETWORK	R&S	ENV216	101447	Mar. 11, 2019
5	Measurement Software	Farad	EZ-EMC Ver.NB-03A1-01	N/A	N/A
6	Cable	N/A	RG223	12m	Oct. 19, 2018

Radiated Emission Measurement - 9KHZ TO 30MHZ					
Item	Kind of Equipment	Manufacturer	Type No.	Serial No.	Calibrated until
1	Loop Antenna	EM	EM-6876-1	230	Feb. 07, 2019
2	Cable	N/A	RG 213/U	C-102	Jun. 01, 2019
3	EMI Test Receiver	R&S	ESCI	100382	Mar. 11, 2019

Radiated Emission Measurement - 30MHZ TO 1000MHZ					
Item	Kind of Equipment	Manufacturer	Type No.	Serial No.	Calibrated until
1	Antenna	Schwarbeck	VULB9160	9160-3232	Mar. 11, 2019
2	Amplifier	HP	8447D	2944A09673	Oct. 19, 2018
3	Receiver	Agilent	N9038A	MY52130039	Aug. 20, 2018
4	Cable	emci	LMR-400(30MHz-1 GHz)(8m+5m)	N/A	May. 25, 2019
5	Controller	CT	SC100	N/A	N/A
6	Controller	MF	MF-7802	MF780208416	N/A
7	Measurement Software	Farad	EZ-EMC Ver.NB-03A1-01	N/A	N/A
8	Loop Antenna	EM	EM-6876-1	230	Feb. 07, 2019

**Radiated Emission Measurement - Above 1GHz**

Item	Kind of Equipment	Manufacturer	Type No.	Serial No.	Calibrated until
1	Double Ridged Guide Antenna	ETS	3115	75789	Mar. 11, 2019
2	Broad-Band Horn Antenna	Schwarzbeck	BBHA 9170	9170319	Jun. 30, 2019
3	Amplifier	Agilent	8449B	3008A02274	Mar. 11, 2019
4	Microwave Preamplifier With Adaptor	EMC INSTRUMENT	EMC2654045	980039 & HA01	Mar. 11, 2019
5	Receiver	Agilent	N9038A	MY52130039	Aug. 20, 2018
6	Controller	CT	SC100	N/A	N/A
7	Controller	MF	MF-7802	MF780208416	N/A
8	Cable	emci	CA500-SMSM-12M (1-26.5GHz)	N/A	Sep. 29, 2018
9	Measurement Software	Farad	EZ-EMC Ver.NB-03A1-01	N/A	N/A

**6dB Bandwidth Measurement**

Item	Kind of Equipment	Manufacturer	Type No.	Serial No.	Calibrated until
1	Spectrum Analyzer	R&S	FSP40	100185	Aug. 20, 2018

**Maximum Output Power Measurement**

Item	Kind of Equipment	Manufacturer	Type No.	Serial No.	Calibrated until
1	Power Meter	ANRITSU	ML2495A	1128009	Mar. 11, 2019
2	Pulse Power Sensor	ANRITSU	MA 2411B	1027500	Mar. 11, 2019

**Antenna Conducted Spurious Emission Measurement**

Item	Kind of Equipment	Manufacturer	Type No.	Serial No.	Calibrated until
1	Spectrum Analyzer	R&S	FSP40	100185	Aug. 20, 2018

**Power Spectral Density Measurement**

Item	Kind of Equipment	Manufacturer	Type No.	Serial No.	Calibrated until
1	Spectrum Analyzer	R&S	FSP40	100185	Aug. 20, 2018

Remark: "N/A" denotes no model name, serial no. or calibration specified.  
All calibration period of equipment list is one year.



## APPENDIX A - CONDUCTED EMISSION

Test Mode: TX Mode

### Line

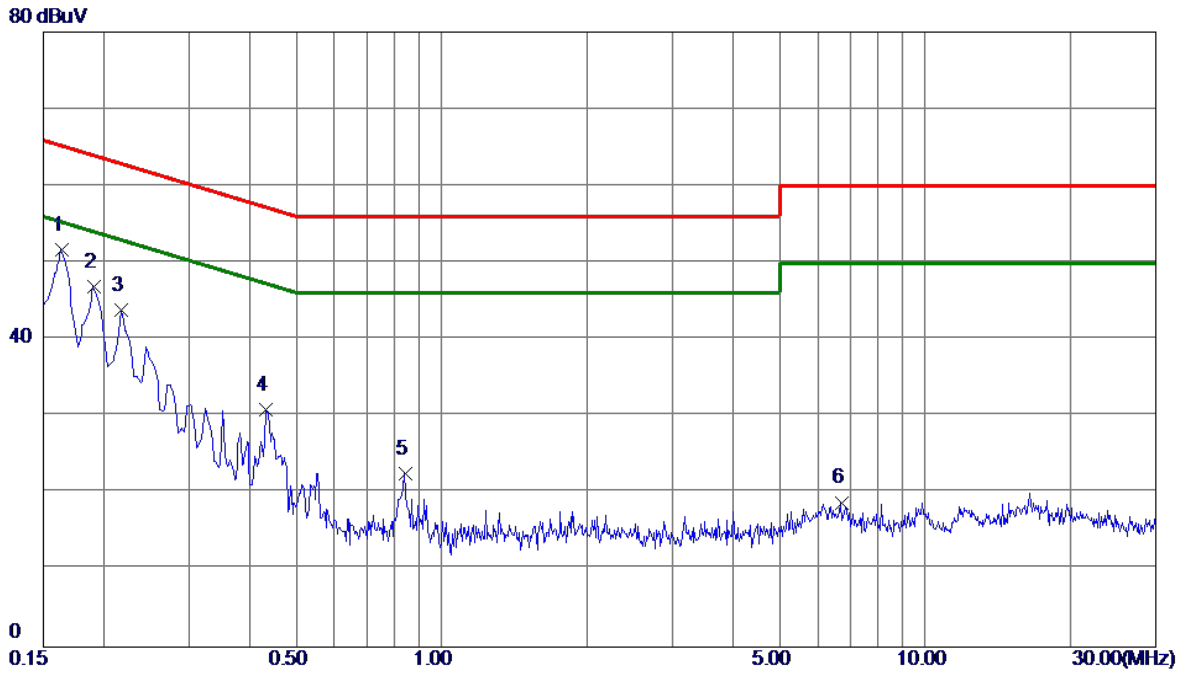

No.	Freq. MHz	Reading Level dBuV	Correct Factor dB	Measure ment dBuV	Limit dBuV	Margin dB	Detector	Comment
1 *	0.1635	41.94	9.74	51.68	65.28	-13.60	Peak	
2	0.1905	37.14	9.73	46.87	64.01	-17.14	Peak	
3	0.2175	34.10	9.72	43.82	62.91	-19.09	Peak	
4	0.4335	21.19	9.76	30.95	57.19	-26.24	Peak	
5	0.8430	12.83	9.77	22.60	56.00	-33.40	Peak	
6	6.7200	8.86	9.94	18.80	60.00	-41.20	Peak	

Test Mode: TX Mode

Neutral

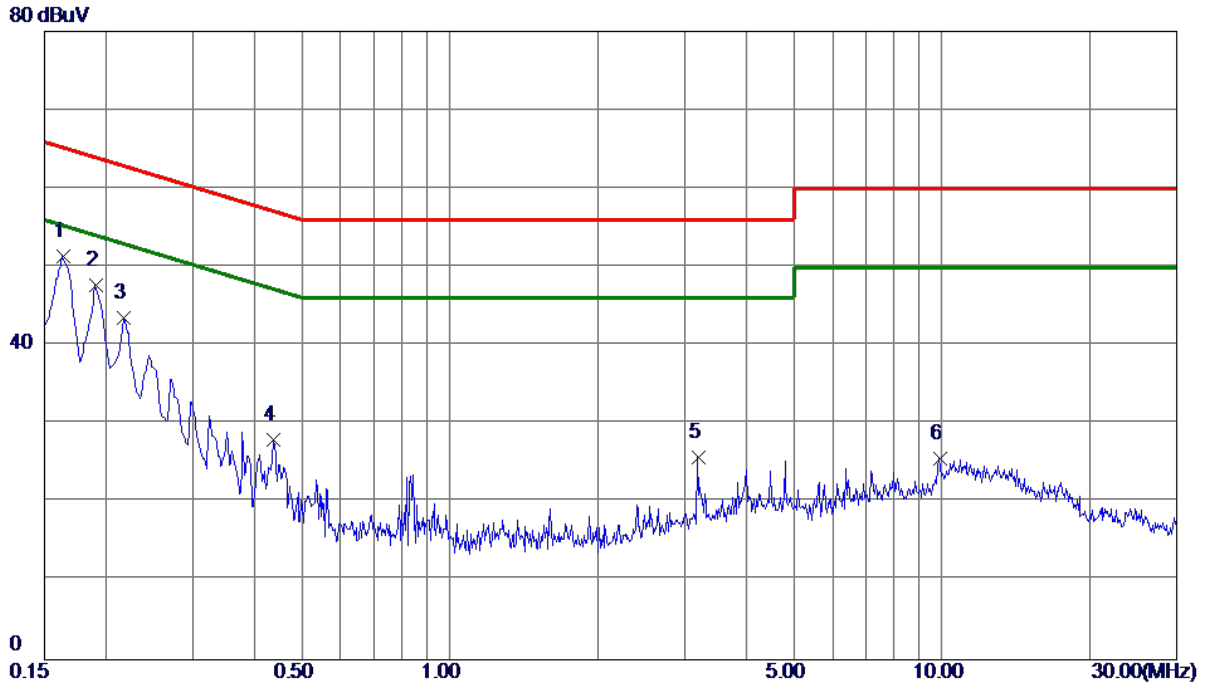

No.	Freq. MHz	Reading Level dBuV	Correct Factor dB	Measure ment dBuV	Limit dBuV	Margin dB	Detector	Comment
1 *	0.1635	41.56	9.74	51.30	65.28	-13.98	Peak	
2	0.1905	37.90	9.73	47.63	64.01	-16.38	Peak	
3	0.2175	33.79	9.72	43.51	62.91	-19.40	Peak	
4	0.4380	18.26	9.76	28.02	57.10	-29.08	Peak	
5	3.2055	15.90	9.86	25.76	56.00	-30.24	Peak	
6	9.9105	15.58	10.04	25.62	60.00	-34.38	Peak	

## APPENDIX B - RADIATED EMISSION (9KHZ TO 30MHZ)

Test Mode: TX Mode

Ant 0°

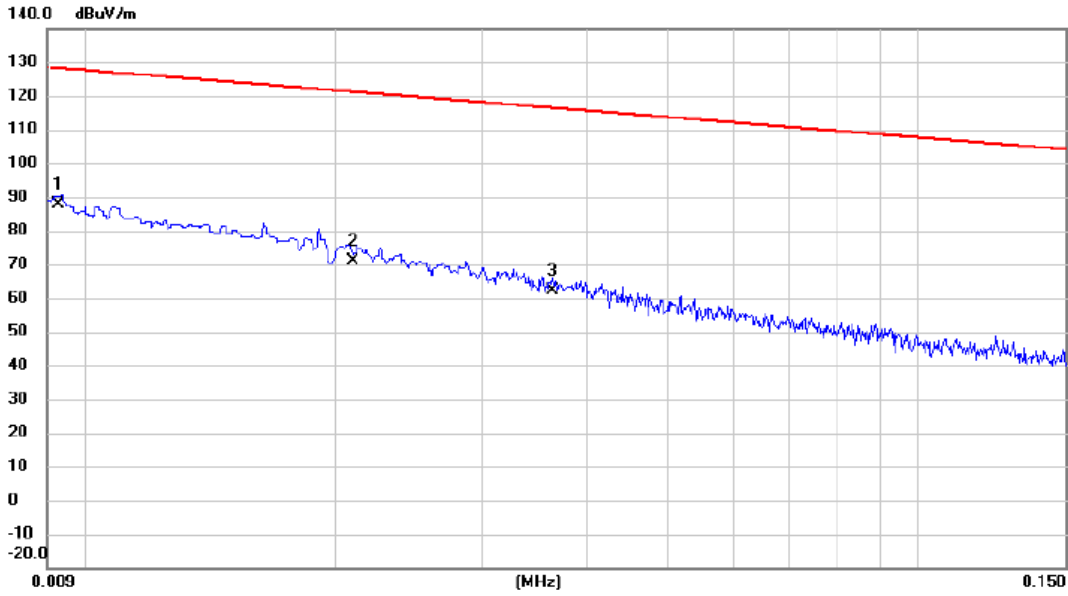

No.	Mk.	Freq. MHz	Reading Level dBuV	Correct Factor dB	Measure- ment dBuV/m	Limit dBuV/m	Margin dB	Detector	Comment
1	*	0.0093	66.90	21.06	87.96	128.24	-40.28	AVG	
2		0.0210	51.26	19.59	70.85	121.16	-50.31	AVG	
3		0.0364	43.26	19.13	62.39	116.38	-53.99	AVG	

Test Mode: TX Mode

Ant 0°

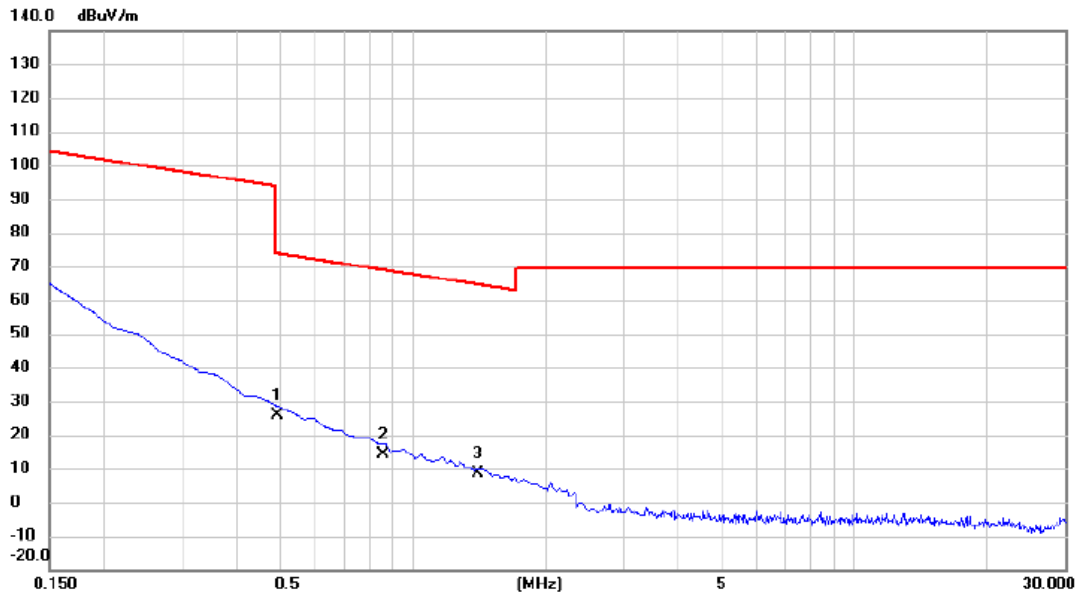

No.	Mk.	Freq. MHz	Reading Level dBuV	Correct Factor dB	Measure- ment dBuV/m	Limit dBuV/m	Margin dB	Detector	Comment
1	*	0.4941	9.34	16.47	25.81	73.73	-47.92	QP	
2		0.8573	-1.65	16.05	14.40	68.94	-54.54	QP	
3		1.4037	-7.07	15.74	8.67	64.66	-55.99	QP	

Test Mode: TX Mode

Ant 90°

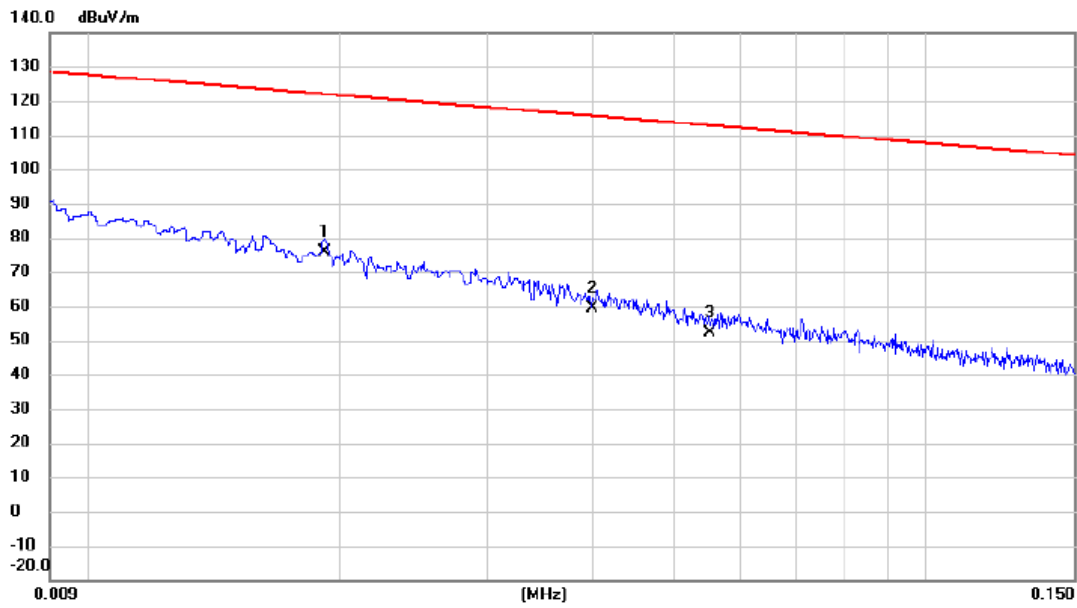

No.	Mk.	Freq. MHz	Reading Level dBuV	Correct Factor dB	Measure- ment dBuV/m	Limit dBuV/m	Margin dB	Detector	Comment
1	*	0.0192	55.91	19.72	75.63	121.94	-46.31	AVG	
2		0.0400	40.57	19.02	59.59	115.56	-55.97	AVG	
3		0.0552	33.51	18.63	52.14	112.77	-60.63	AVG	

Test Mode: TX Mode

Ant 90°

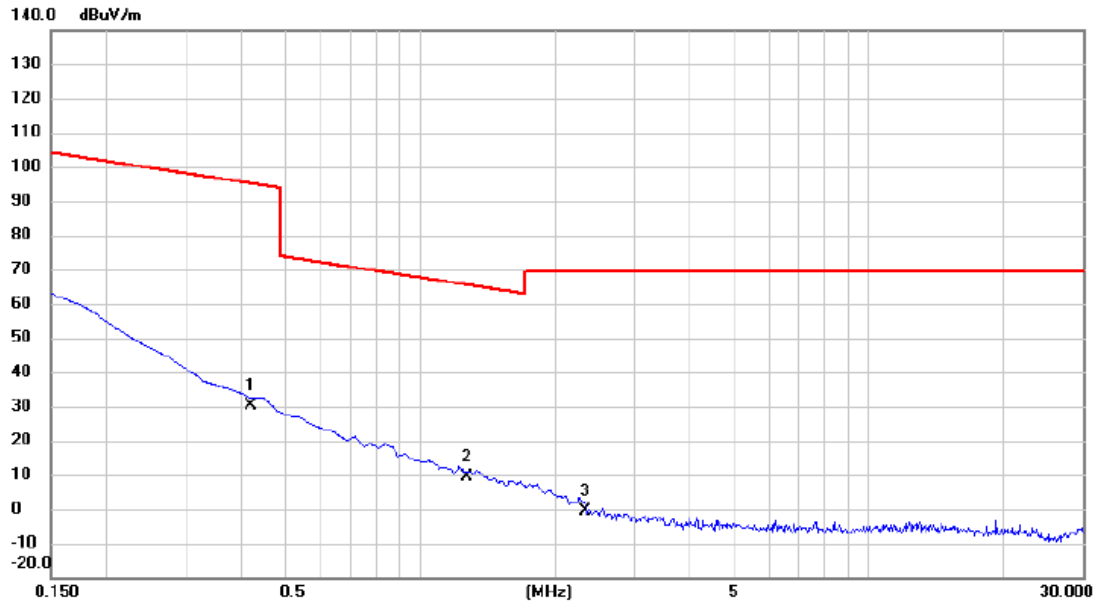

No.	Mk.	Freq. MHz	Reading Level dBuV	Correct Factor dB	Measure- ment dBuV/m	Limit dBuV/m	Margin dB	Detector	Comment
1		0.4187	13.52	16.54	30.06	95.17	-65.11	AVG	
2	*	1.2694	-6.56	15.79	9.23	65.53	-56.30	QP	
3		2.3291	-16.10	15.42	-0.68	69.54	-70.22	QP	



## APPENDIX C - RADIATED EMISSION (30MHZ TO 1000MHZ)

Test Mode: TX 2402MHz \_CH00\_1Mbps

**Vertical**

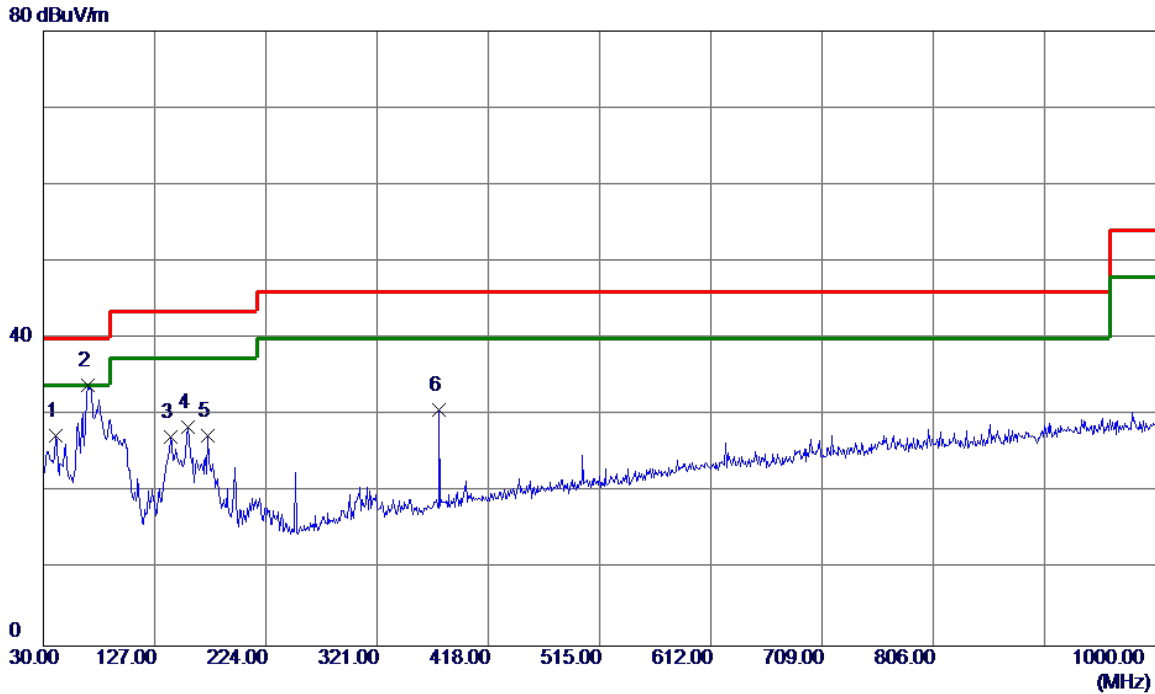

No.	Freq. MHz	Reading Level dBuV/m	Correct Factor dB	Measure ment dBuV/m	Limit dBuV/m	Margin dB	Detector	Comment
1	40.6699	41.20	-13.85	27.35	40.00	-12.65	Peak	
2 *	68.8000	50.11	-16.20	33.91	40.00	-6.09	Peak	
3	140.5800	41.32	-14.18	27.14	43.50	-16.36	Peak	
4	156.1000	41.70	-13.16	28.54	43.50	-14.96	Peak	
5	173.5600	39.63	-12.23	27.40	43.50	-16.10	Peak	
6	375.3200	42.44	-11.65	30.79	46.00	-15.21	Peak	

Test Mode: TX 2402MHz \_CH00\_1Mbps

### Horizontal

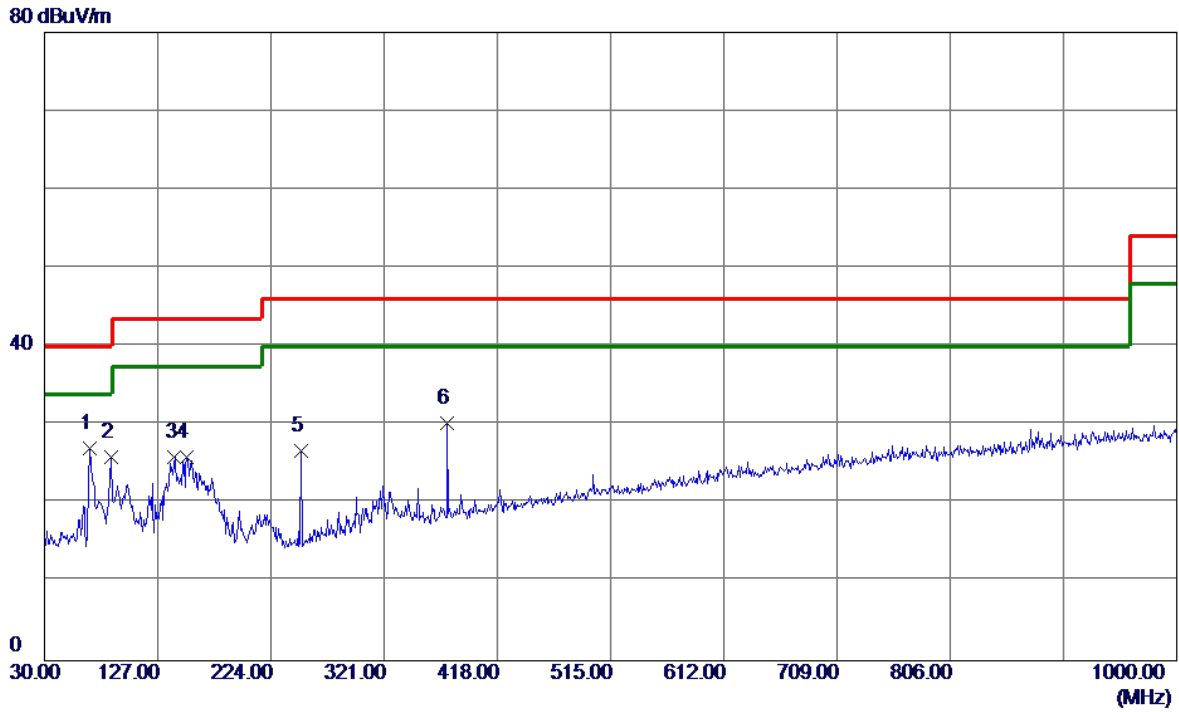

No.	Freq. MHz	Reading Level dBuV/m	Correct Factor dB	Measure ment dBuV/m	Limit dBuV/m	Margin dB	Detector	Comment
1 *	68.8000	43.29	-16.20	27.09	40.00	-12.91	Peak	
2	87.2300	44.39	-18.51	25.88	40.00	-14.12	Peak	
3	141.5500	40.06	-14.11	25.95	43.50	-17.55	Peak	
4	152.2200	39.24	-13.39	25.85	43.50	-17.65	Peak	
5	250.1900	41.66	-14.90	26.76	46.00	-19.24	Peak	
6	375.3200	41.95	-11.65	30.30	46.00	-15.70	Peak	

Test Mode: TX 2440MHz \_CH19\_1Mbps

### Vertical

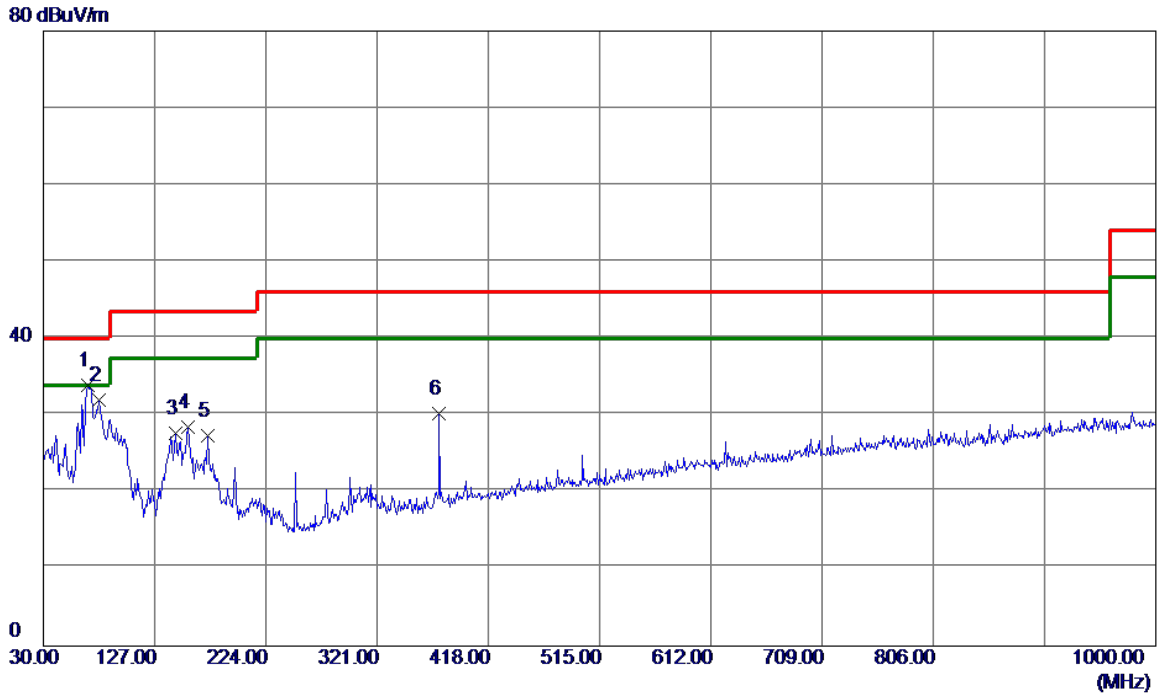

No.	Freq. MHz	Reading Level dBuV/m	Correct Factor dB	Measure ment dBuV/m	Limit dBuV/m	Margin dB	Detector	Comment
1 *	68.8000	50.11	-16.20	33.91	40.00	-6.09	Peak	
2	78.5000	49.95	-17.89	32.06	40.00	-7.94	Peak	
3	145.4299	41.54	-13.84	27.70	43.50	-15.80	Peak	
4	156.1000	41.70	-13.16	28.54	43.50	-14.96	Peak	
5	173.5600	39.63	-12.23	27.40	43.50	-16.10	Peak	
6	375.3200	41.94	-11.65	30.29	46.00	-15.71	Peak	

Test Mode: TX 2440MHz \_CH19\_1Mbps

### Horizontal

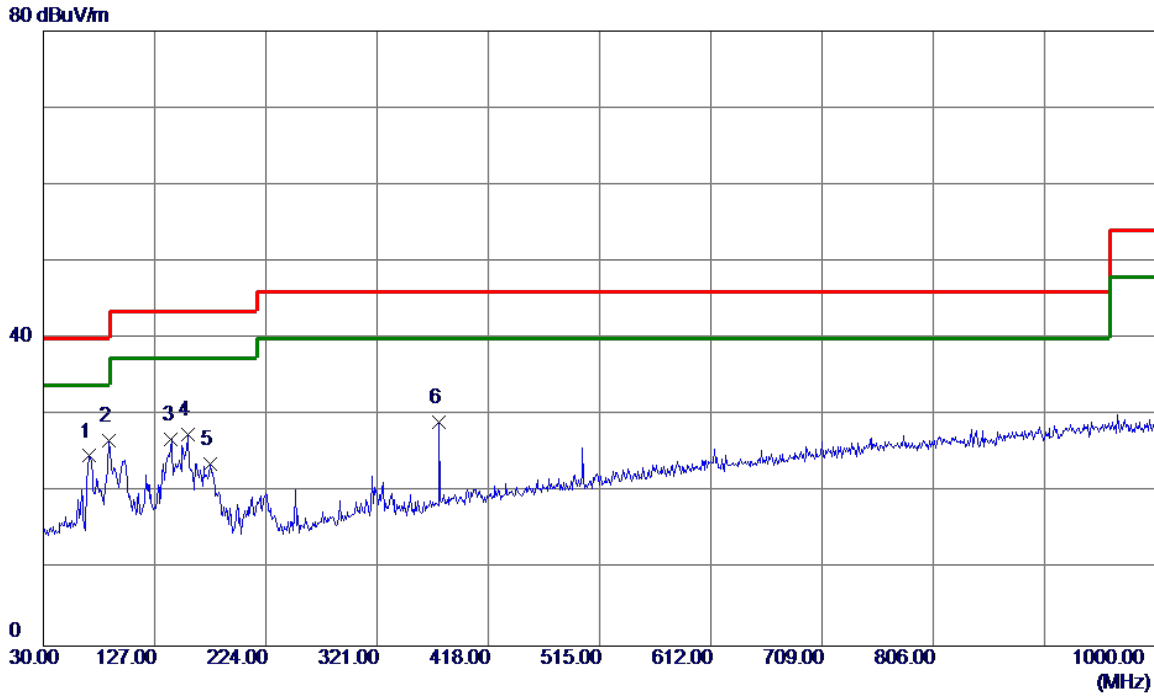

No.	Freq. MHz	Reading Level dBuV/m	Correct Factor dB	Measure ment dBuV/m	Limit dBuV/m	Margin dB	Detector	Comment
1	69.7699	41.18	-16.46	24.72	40.00	-15.28	Peak	
2 *	87.2300	45.16	-18.51	26.65	40.00	-13.35	Peak	
3	141.5500	40.95	-14.11	26.84	43.50	-16.66	Peak	
4	156.1000	40.65	-13.16	27.49	43.50	-16.01	Peak	
5	175.5000	35.89	-12.17	23.72	43.50	-19.78	Peak	
6	375.3200	40.73	-11.65	29.08	46.00	-16.92	Peak	

Test Mode: TX 2480MHz \_CH39\_1Mbps

### Vertical

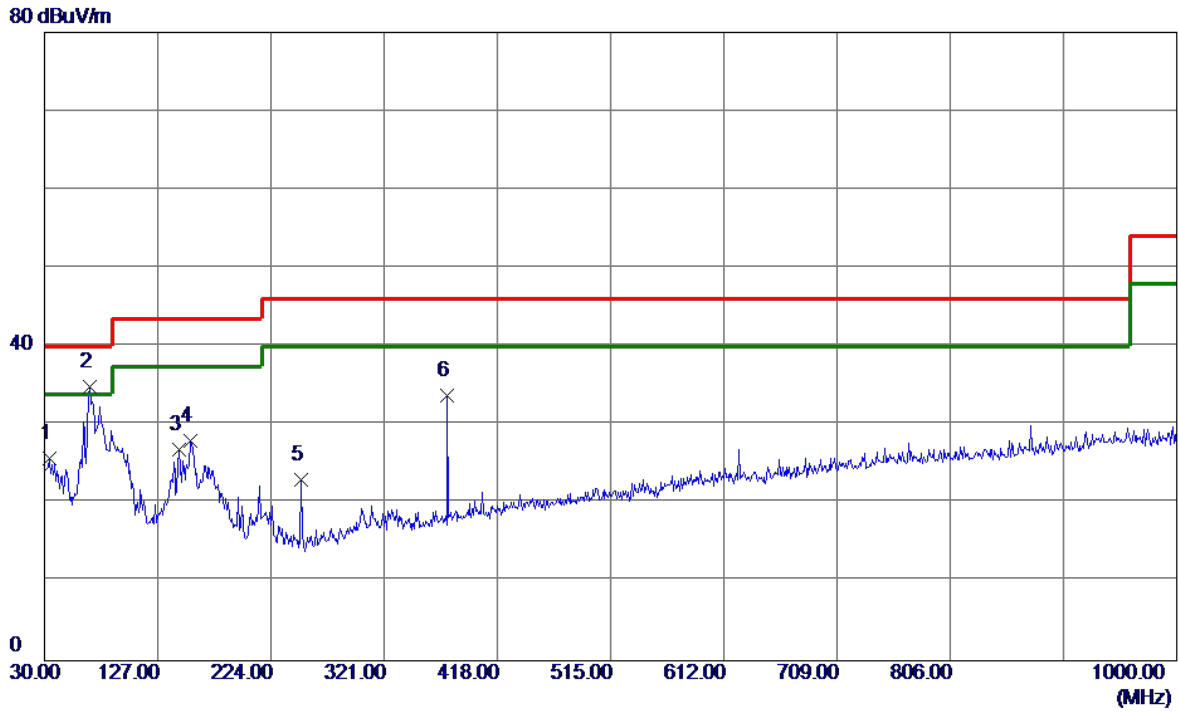

No.	Freq. MHz	Reading Level dBuV/m	Correct Factor dB	Measurement dBuV/m	Limit dBuV/m	Margin dB	Detector	Comment
1	33.8800	40.55	-14.73	25.82	40.00	-14.18	Peak	
2 *	68.8000	51.14	-16.20	34.94	40.00	-5.06	Peak	
3	145.4299	40.69	-13.84	26.85	43.50	-16.65	Peak	
4	155.1300	41.16	-13.22	27.94	43.50	-15.56	Peak	
5	250.1900	37.93	-14.90	23.03	46.00	-22.97	Peak	
6	375.3200	45.41	-11.65	33.76	46.00	-12.24	Peak	

Test Mode: TX 2480MHz \_CH39\_1Mbps

### Horizontal

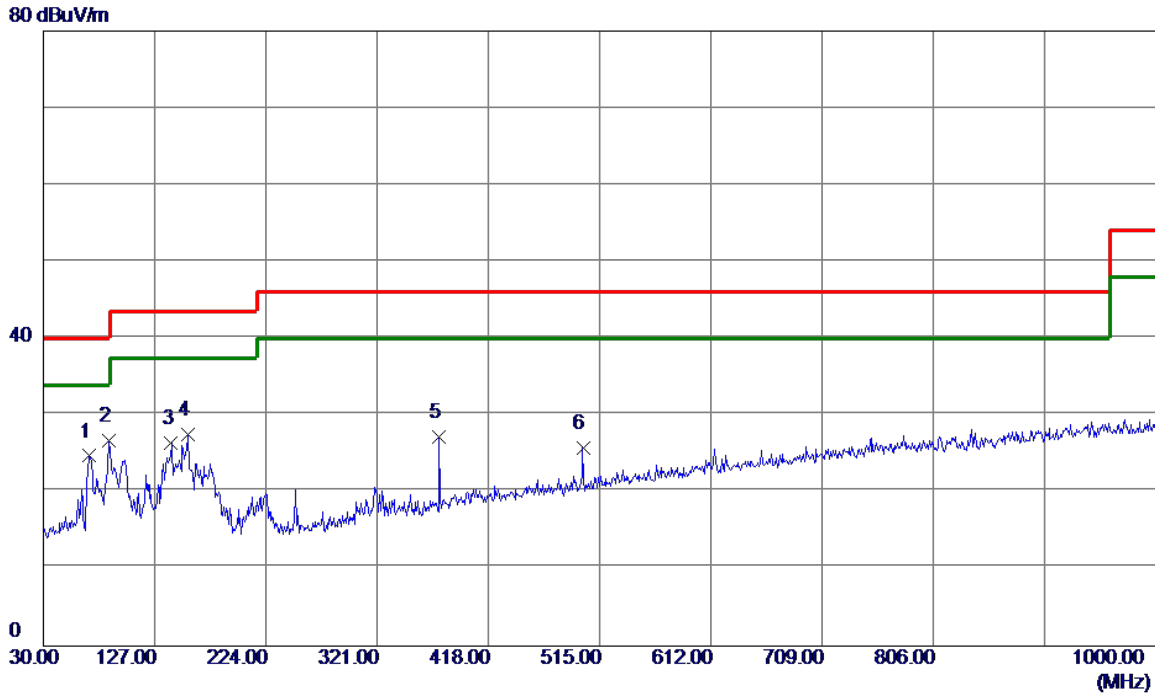

No.	Freq. MHz	Reading Level dBuV/m	Correct Factor dB	Measure ment dBuV/m	Limit dBuV/m	Margin dB	Detector	Comment
1	69.7699	41.18	-16.46	24.72	40.00	-15.28	Peak	
2 *	87.2300	45.16	-18.51	26.65	40.00	-13.35	Peak	
3	141.5500	40.57	-14.11	26.46	43.50	-17.04	Peak	
4	156.1000	40.65	-13.16	27.49	43.50	-16.01	Peak	
5	375.3200	38.83	-11.65	27.18	46.00	-18.82	Peak	
6	500.4500	34.42	-8.71	25.71	46.00	-20.29	Peak	

## APPENDIX D - RADIATED EMISSION (ABOVE 1000MHZ)



Test Mode : TX 2402MHz \_CH00\_1Mbps

**Vertical**

110 dBuV/m

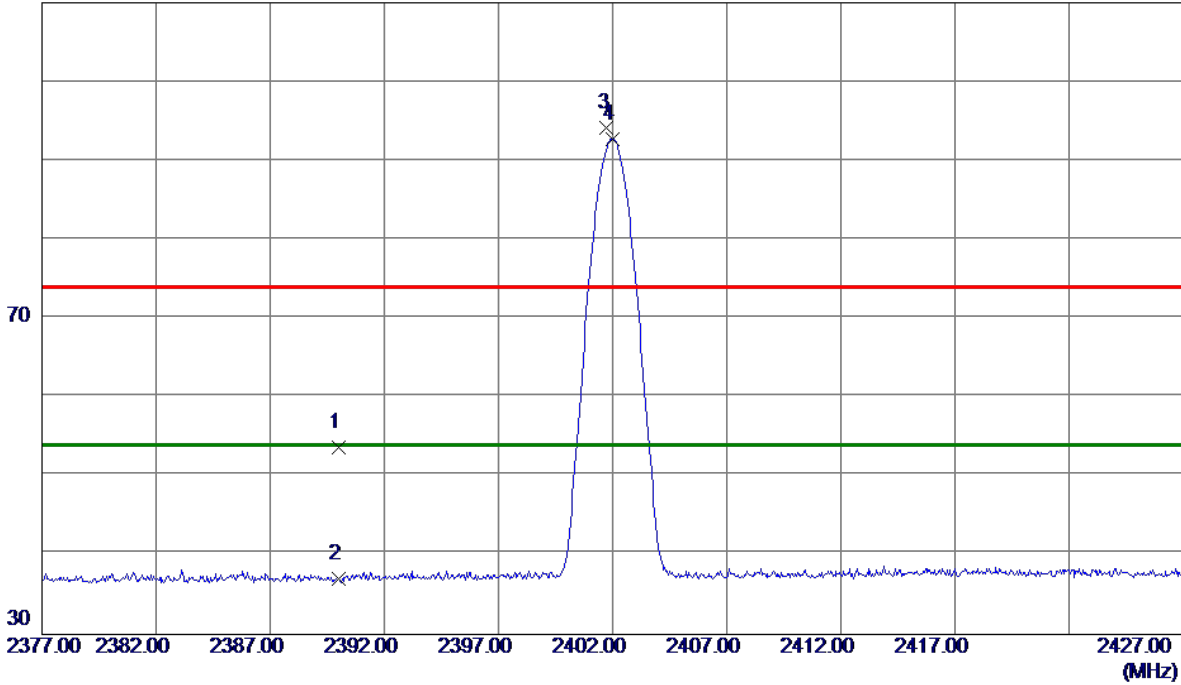

No.	Freq. MHz	Reading Level dBuV/m	Correct Factor dB	Measure ment dBuV/m	Limit dBuV/m	Margin dB	Detector	Comment
1	2390.0000	20.57	33.06	53.63	74.00	-20.37	Peak	
2	2390.0000	3.91	33.06	36.97	54.00	-17.03	AVG	
3	2401.7500	61.04	33.10	94.14	74.00	20.14	Peak	No Limit
4 *	2402.0000	59.68	33.10	92.78	54.00	38.78	AVG	No Limit

Test Mode : TX 2402MHz \_CH00\_1Mbps

Vertical

80 dBuV/m

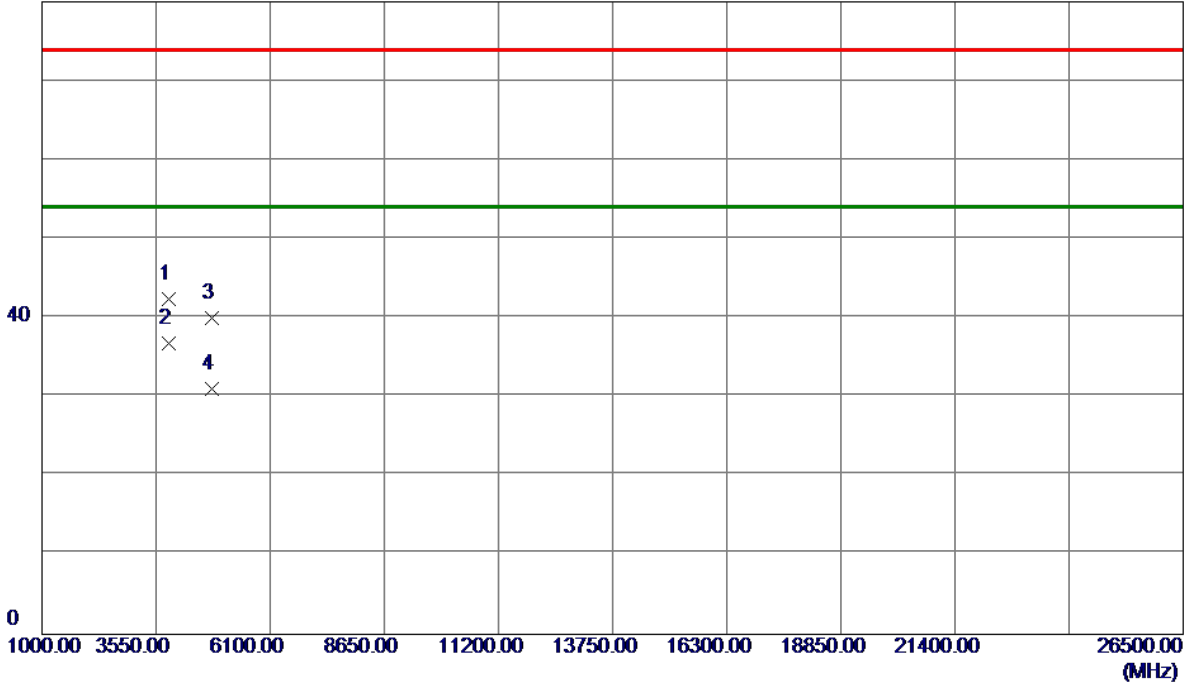

No.	Freq. MHz	Reading Level dBuV/m	Correct Factor dB	Measure ment dBuV/m	Limit dBuV/m	Margin dB	Detector	Comment
1	3842.9550	38.93	3.48	42.41	74.00	-31.59	Peak	
2 *	3843.2270	33.30	3.48	36.78	54.00	-17.22	AVG	
3	4804.0680	33.36	6.59	39.95	74.00	-34.05	Peak	
4	4804.1800	24.39	6.59	30.98	54.00	-23.02	AVG	

Test Mode : TX 2402MHz \_CH00\_1Mbps

**Horizontal**

110 dBuV/m

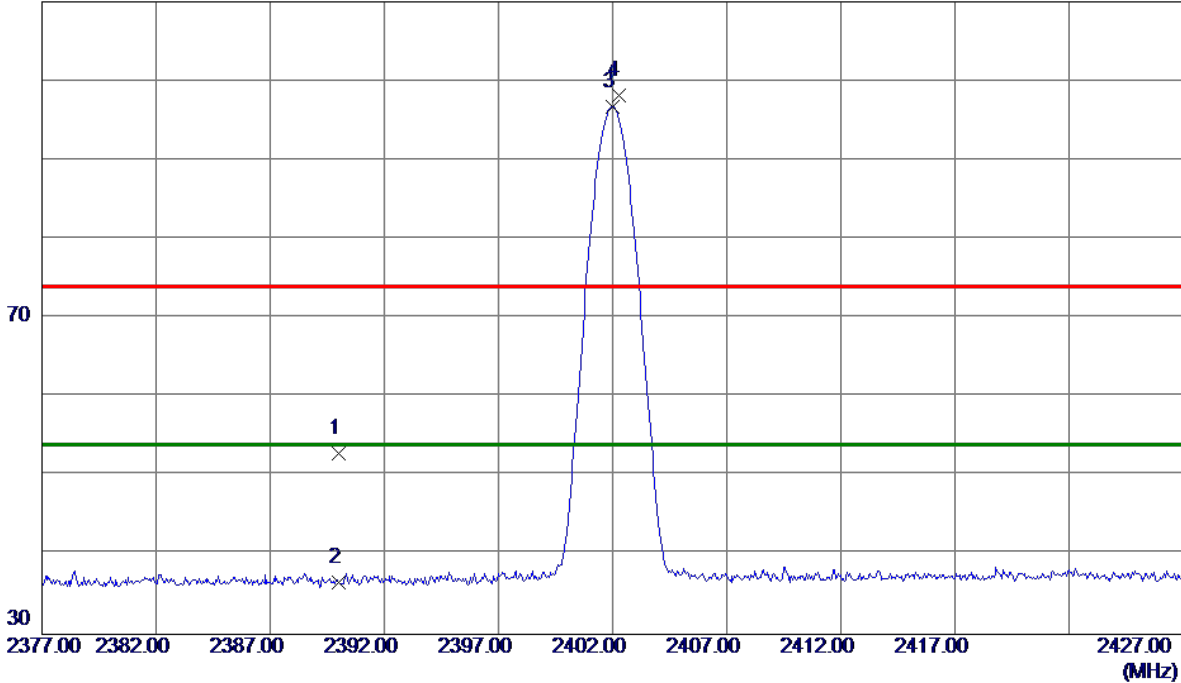

No.	Freq. MHz	Reading Level dBuV/m	Correct Factor dB	Measure ment dBuV/m	Limit dBuV/m	Margin dB	Detector	Comment
1	2390.0000	19.78	33.06	52.84	74.00	-21.16	Peak	
2	2390.0000	3.46	33.06	36.52	54.00	-17.48	AVG	
3 *	2402.0000	63.64	33.10	96.74	54.00	42.74	AVG	No Limit
4	2402.2500	65.05	33.10	98.15	74.00	24.15	Peak	No Limit

Test Mode : TX 2402MHz \_CH00\_1Mbps

### Horizontal

80 dBuV/m

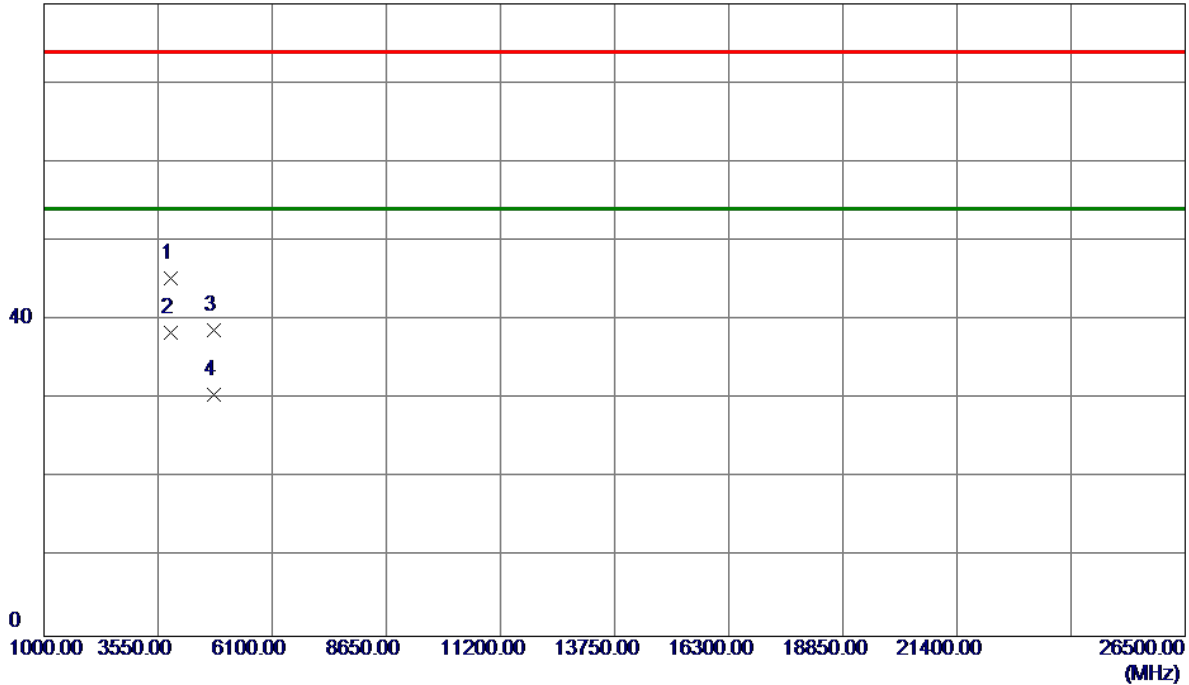

No.	Freq. MHz	Reading Level dBuV/m	Correct Factor dB	Measure ment dBuV/m	Limit dBuV/m	Margin dB	Detector	Comment
1	3843.1500	41.75	3.48	45.23	74.00	-28.77	Peak	
2 *	3843.1950	34.86	3.48	38.34	54.00	-15.66	AVG	
3	4804.0450	32.12	6.59	38.71	74.00	-35.29	Peak	
4	4804.1450	24.03	6.59	30.62	54.00	-23.38	AVG	

Test Mode : TX 2440MHz \_CH19\_1Mbps

**Vertical**

110 dBuV/m

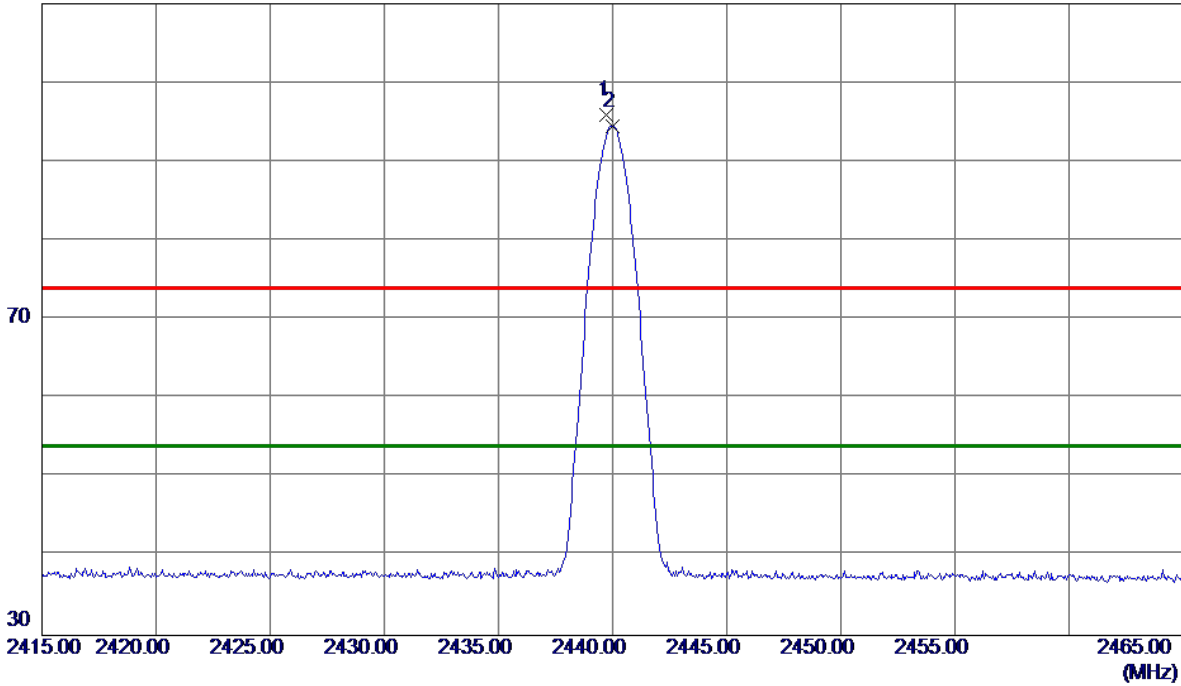

No.	Freq. MHz	Reading Level dBuV/m	Correct Factor dB	Measure ment dBuV/m	Limit dBuV/m	Margin dB	Detector	Comment
1	2439.7500	62.67	33.24	95.91	74.00	21.91	Peak	No Limit
2 *	2440.0000	61.27	33.24	94.51	54.00	40.51	AVG	No Limit

Test Mode : TX 2440MHz \_CH19\_1Mbps

Vertical

80 dBuV/m

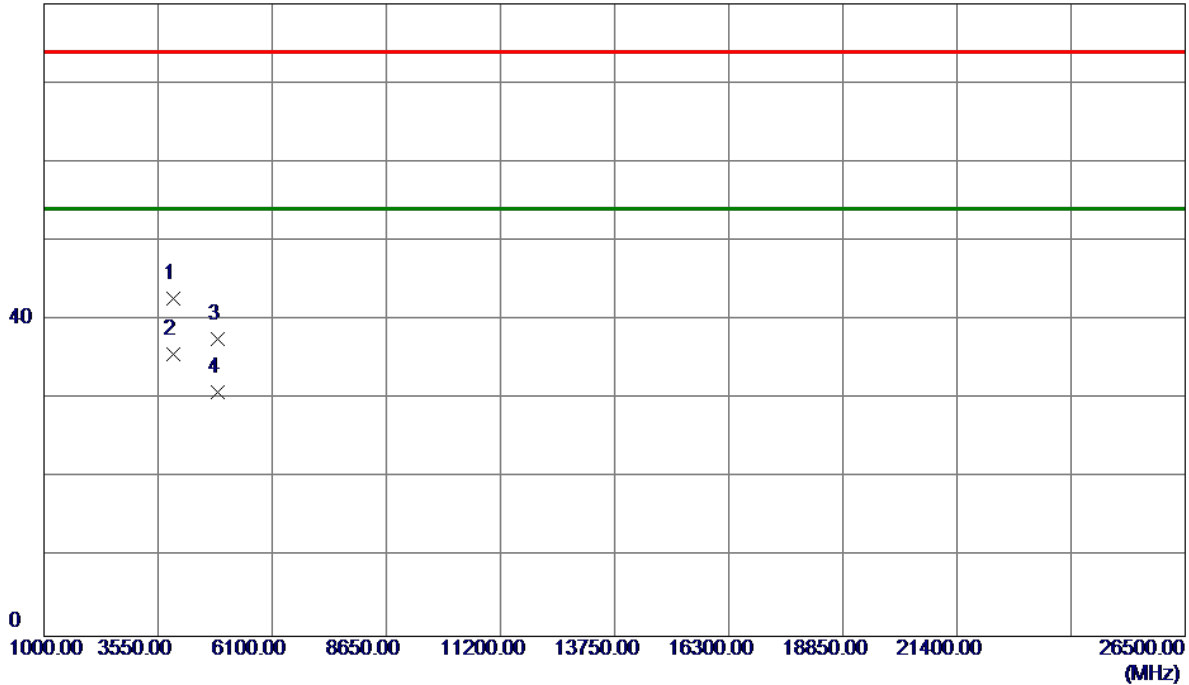

No.	Freq. MHz	Reading Level dBuV/m	Correct Factor dB	Measure ment dBuV/m	Limit dBuV/m	Margin dB	Detector	Comment
1	3903.7600	39.05	3.62	42.67	74.00	-31.33	Peak	
2 *	3903.9600	32.00	3.62	35.62	54.00	-18.38	AVG	
3	4879.5500	30.79	6.86	37.65	74.00	-36.35	Peak	
4	4879.7000	23.99	6.86	30.85	54.00	-23.15	AVG	

Test Mode : TX 2440MHz \_CH19\_1Mbps

Horizontal

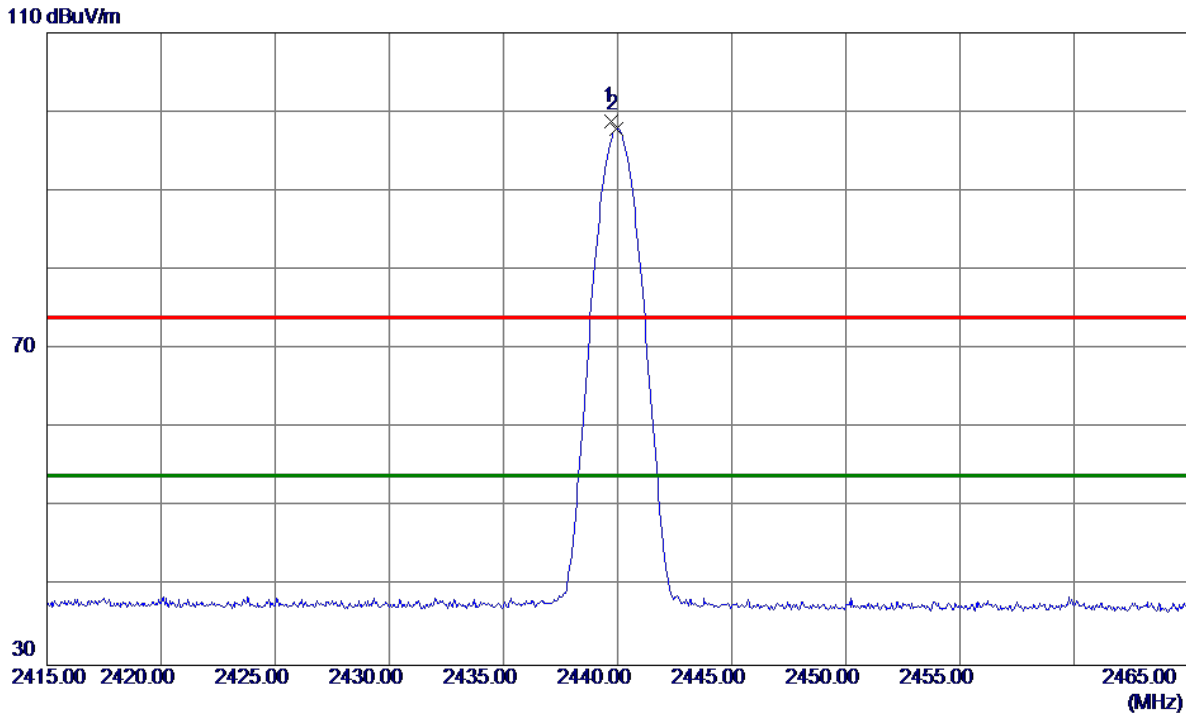

No.	Freq. MHz	Reading Level dBuV/m	Correct Factor dB	Measure ment dBuV/m	Limit dBuV/m	Margin dB	Detector	Comment
1	2439.7500	65.63	33.24	98.87	74.00	24.87	Peak	No Limit
2 *	2439.9500	64.55	33.24	97.79	54.00	43.79	AVG	No Limit

Test Mode : TX 2440MHz \_CH19\_1Mbps

### Horizontal

80 dBuV/m

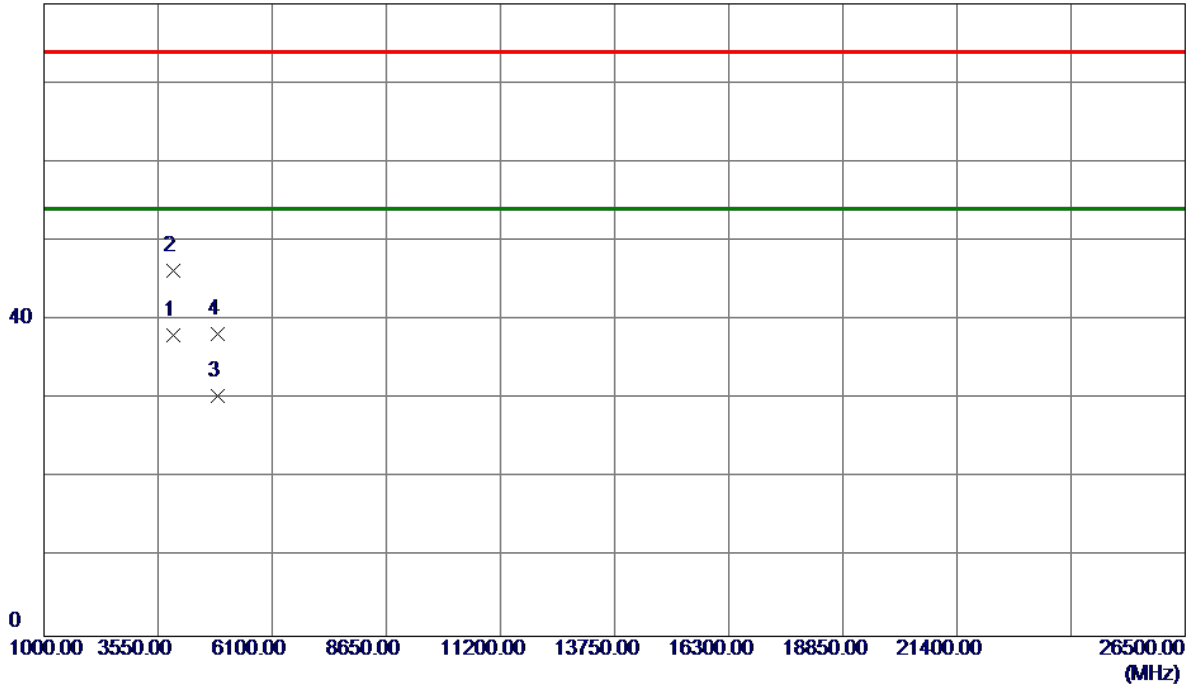

No.	Freq. MHz	Reading Level dBuV/m	Correct Factor dB	Measurement dBuV/m	Limit dBuV/m	Margin dB	Detector	Comment
1 *	3903.9700	34.40	3.62	38.02	54.00	-15.98	AVG	
2	3904.0800	42.58	3.62	46.20	74.00	-27.80	Peak	
3	4880.2200	23.56	6.86	30.42	54.00	-23.58	AVG	
4	4881.5400	31.44	6.86	38.30	74.00	-35.70	Peak	



Test Mode : TX 2480MHz \_CH39\_1Mbps

**Vertical**

110 dBuV/m

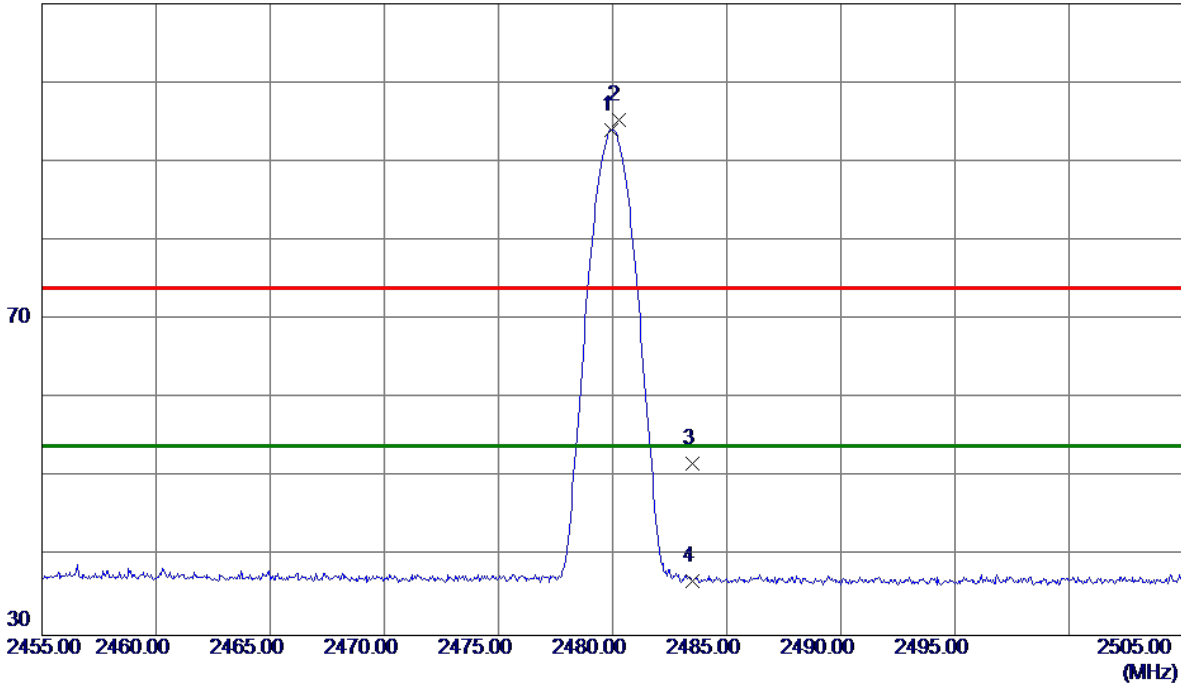

No.	Freq. MHz	Reading Level dBuV/m	Correct Factor dB	Measure ment dBuV/m	Limit dBuV/m	Margin dB	Detector	Comment
1 *	2479.9500	60.66	33.39	94.05	54.00	40.05	AVG	No Limit
2	2480.2500	61.85	33.40	95.25	74.00	21.25	Peak	No Limit
3	2483.5000	18.34	33.41	51.75	74.00	-22.25	Peak	
4	2483.5000	3.49	33.41	36.90	54.00	-17.10	AVG	

Test Mode : TX 2480MHz \_CH39\_1Mbps

Vertical

80 dBuV/m

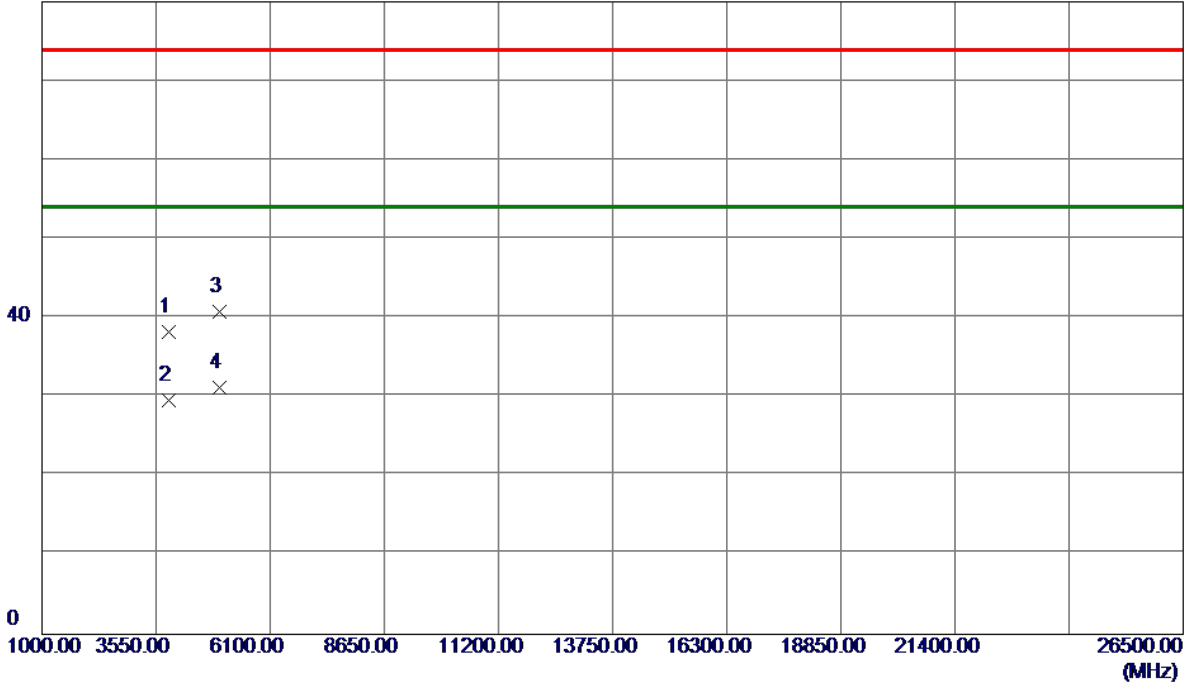

No.	Freq. MHz	Reading Level dBuV/m	Correct Factor dB	Measure ment dBuV/m	Limit dBuV/m	Margin dB	Detector	Comment
1	3844.6800	34.73	3.49	38.22	74.00	-35.78	Peak	
2	3845.9600	26.13	3.49	29.62	54.00	-24.38	AVG	
3	4958.9900	33.71	7.14	40.85	74.00	-33.15	Peak	
4 *	4960.5500	24.09	7.15	31.24	54.00	-22.76	AVG	

Test Mode : TX 2480MHz \_CH39\_1Mbps

### Horizontal

110 dBuV/m

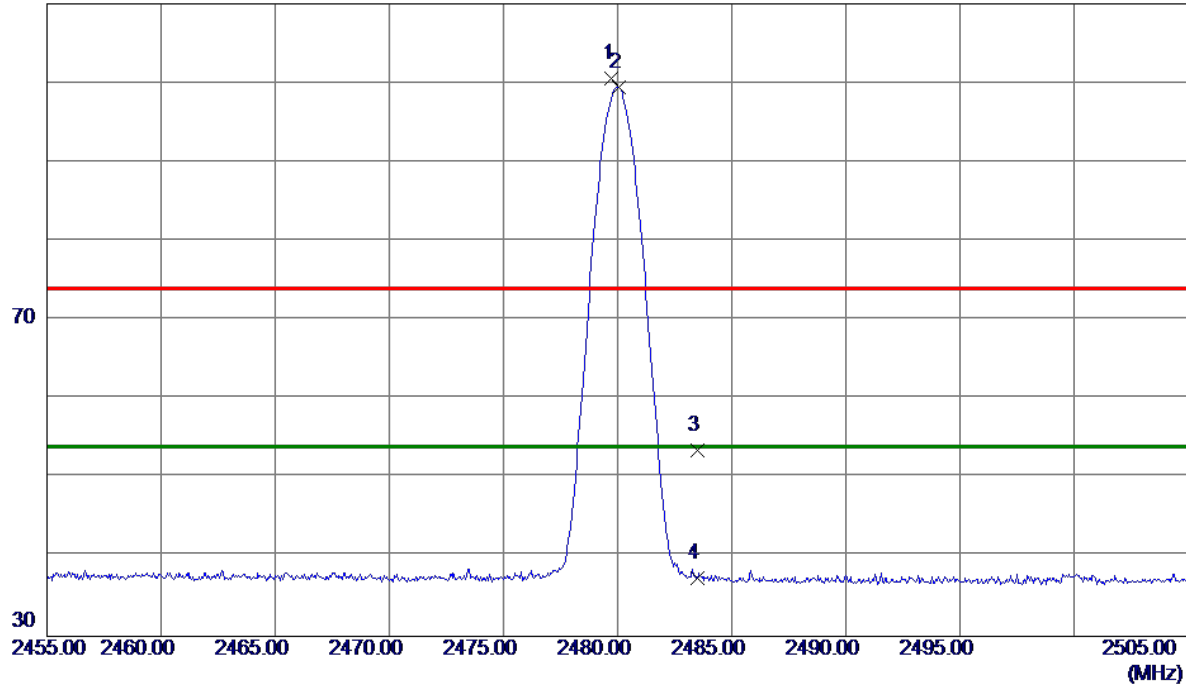

No.	Freq. MHz	Reading Level dBuV/m	Correct Factor dB	Measure ment dBuV/m	Limit dBuV/m	Margin dB	Detector	Comment
1	2479.7500	67.09	33.39	100.48	74.00	26.48	Peak	No Limit
2 *	2480.0500	66.04	33.39	99.43	54.00	45.43	AVG	No Limit
3	2483.5000	20.07	33.41	53.48	74.00	-20.52	Peak	
4	2483.5000	3.89	33.41	37.30	54.00	-16.70	AVG	

Test Mode : TX 2480MHz \_CH39\_1Mbps

**Horizontal**

80 dBuV/m

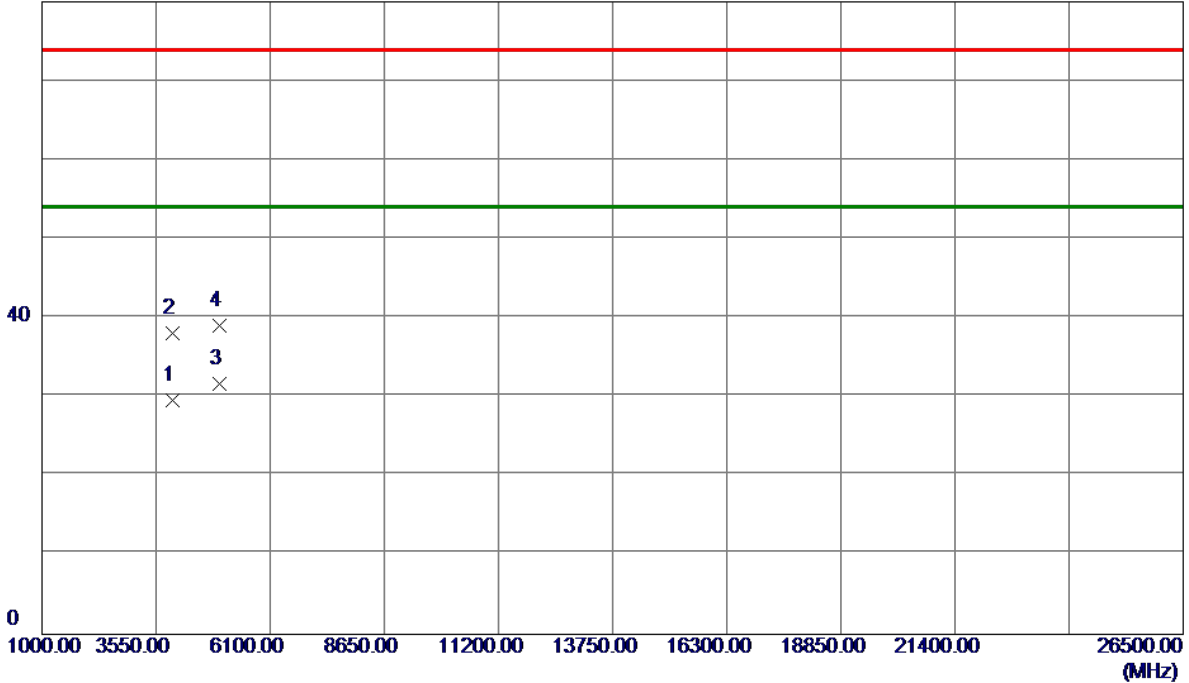

No.	Freq. MHz	Reading Level dBuV/m	Correct Factor dB	Measure ment dBuV/m	Limit dBuV/m	Margin dB	Detector	Comment
1	3904.2850	25.96	3.62	29.58	54.00	-24.42	AVG	
2	3904.6550	34.49	3.62	38.11	74.00	-35.89	Peak	
3 *	4960.1100	24.51	7.15	31.66	54.00	-22.34	AVG	
4	4961.3300	31.92	7.15	39.07	74.00	-34.93	Peak	

## APPENDIX E - BANDWIDTH

Test Mode: TX Mode

Frequency (MHz)	6dB Bandwidth (MHz)	99% Occupied BW (MHz)	Min. Limit (kHz)	Test Result
2402	0.696	1.076	500	Pass
2440	0.722	1.080	500	Pass
2480	0.716	1.084	500	Pass

### TX CH00

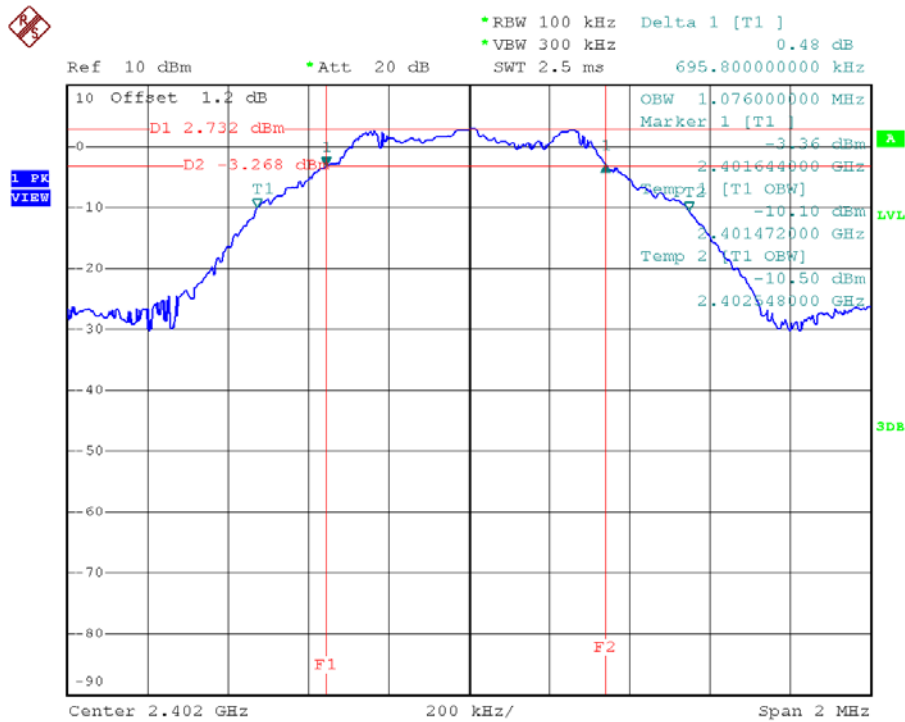

**TX CH19**

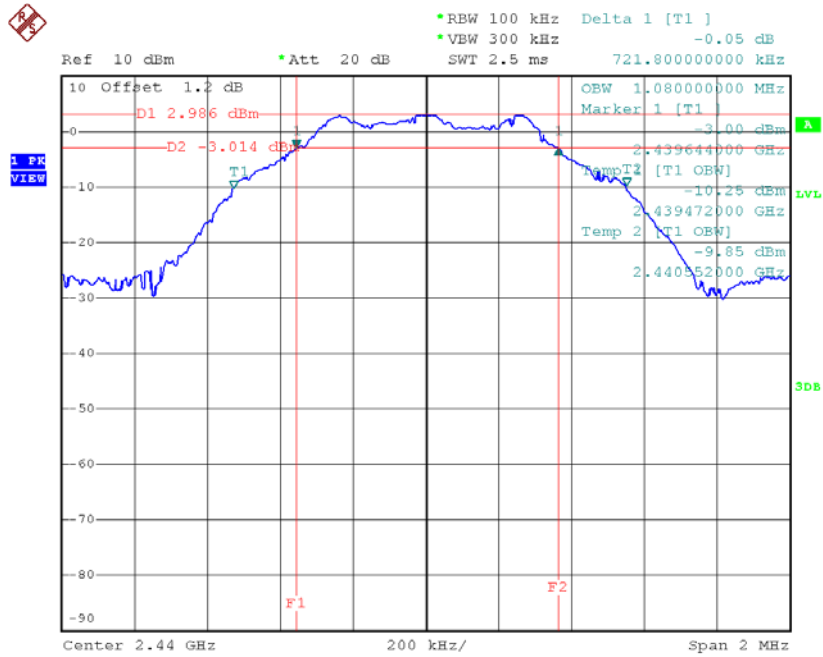

**TX CH39**

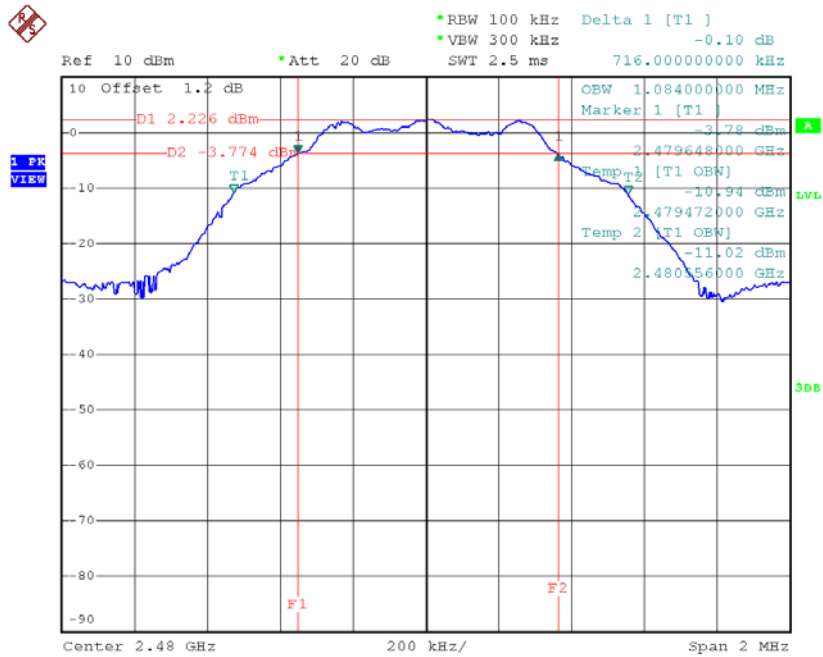

## APPENDIX F - MAXIMUM OUTPUT POWER TEST



Test Mode : CH00, CH19 , CH39 - 1Mbps

Frequency (MHz)	Conducted Power (dBm)	Conducted Power (W)	Max. Limit (dBm)	Max. Limit (W)	Test Result
2402	2.90	0.0019	30.00	1.00	Pass
2440	3.72	0.0024	30.00	1.00	Pass
2480	2.93	0.0020	30.00	1.00	Pass

## APPENDIX G - ANTENNA CONDUCTED SPURIOUS EMISSION

Test Mode : CH00, CH19 , CH39 - 1Mbps

**CH00 (Lower) - 1Mbps**

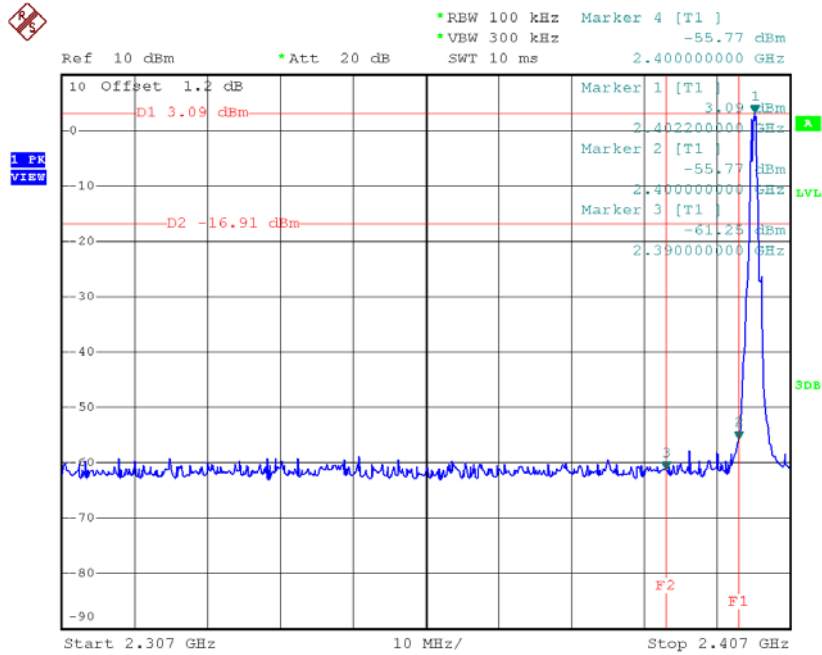

**CH39 (upper) - 1Mbps**

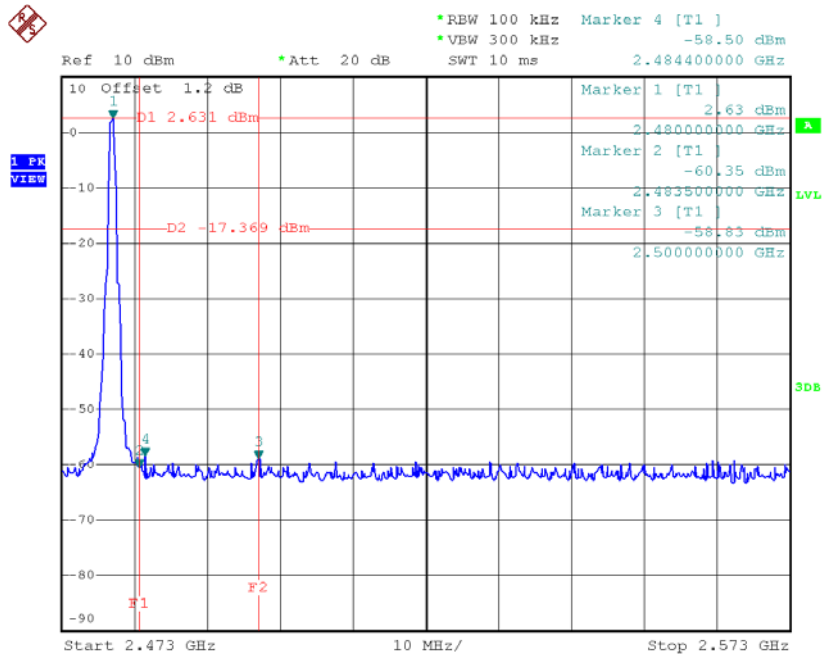

### CH00 (10 Harmonic of the frequency) 1

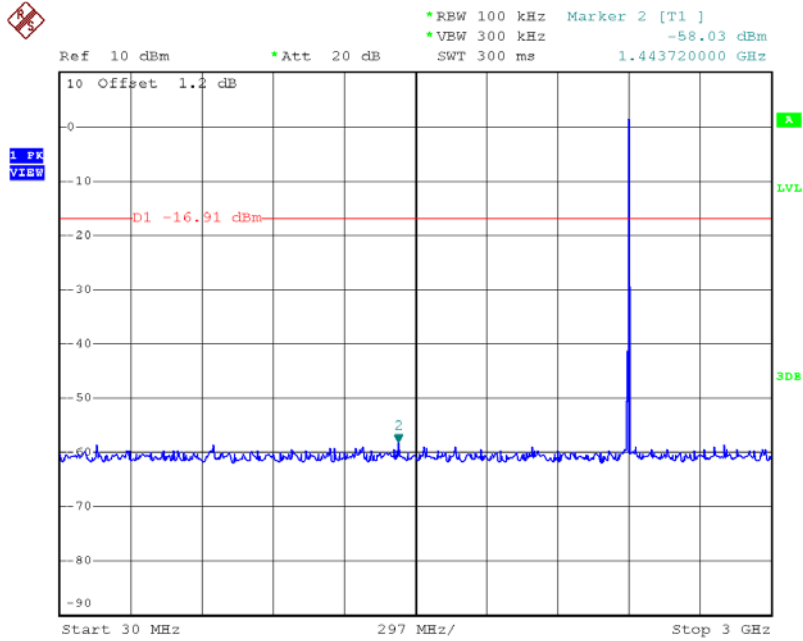

### CH00 (10 Harmonic of the frequency) 2

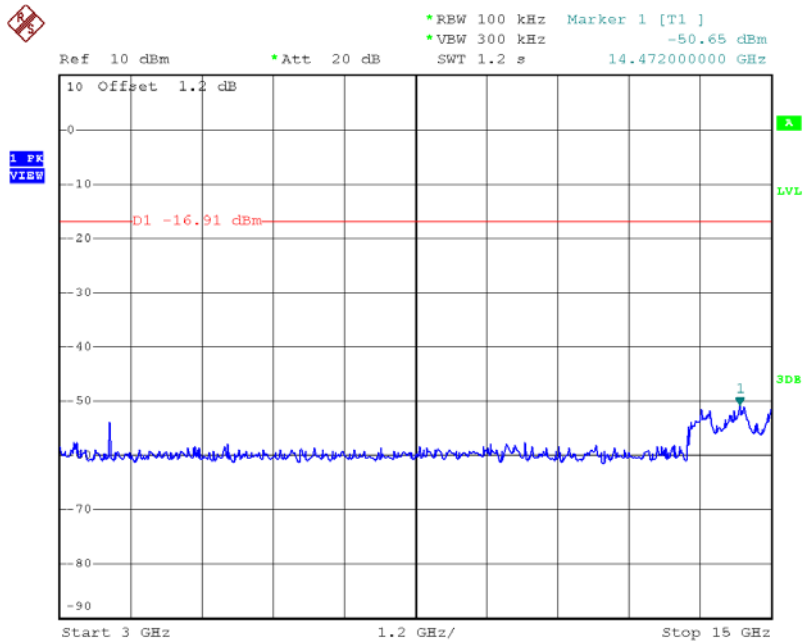

### CH00 (10 Harmonic of the frequency) 3

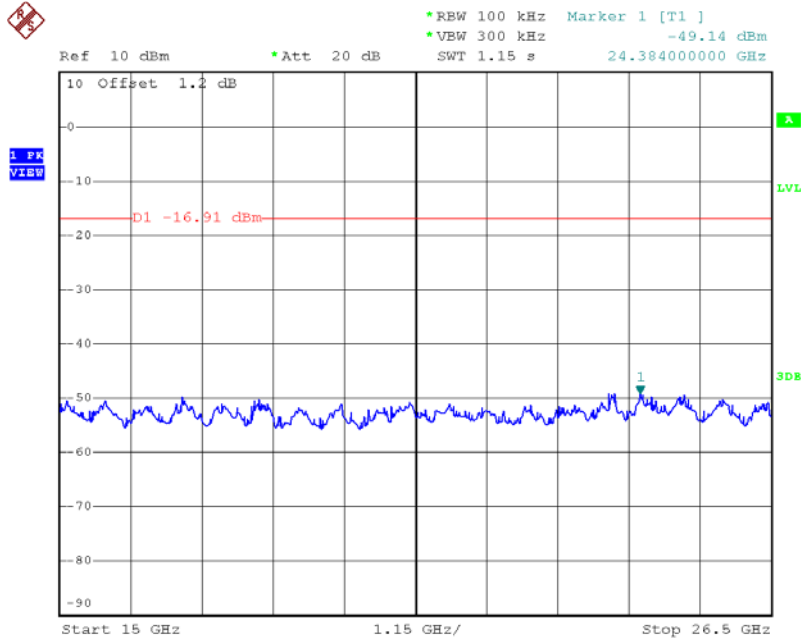

### CH19 (10 Harmonic of the frequency) 1

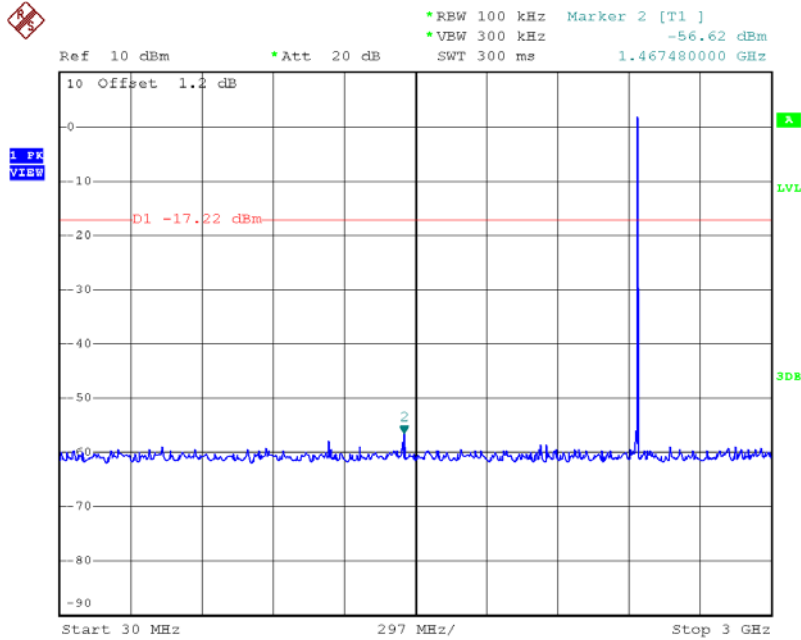

### CH19 (10 Harmonic of the frequency) 2

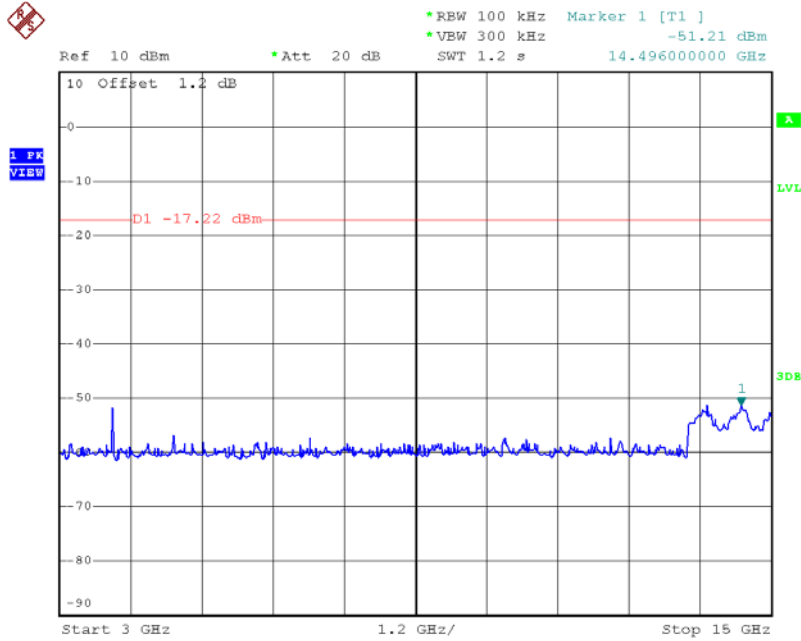

### CH19 (10 Harmonic of the frequency) 3

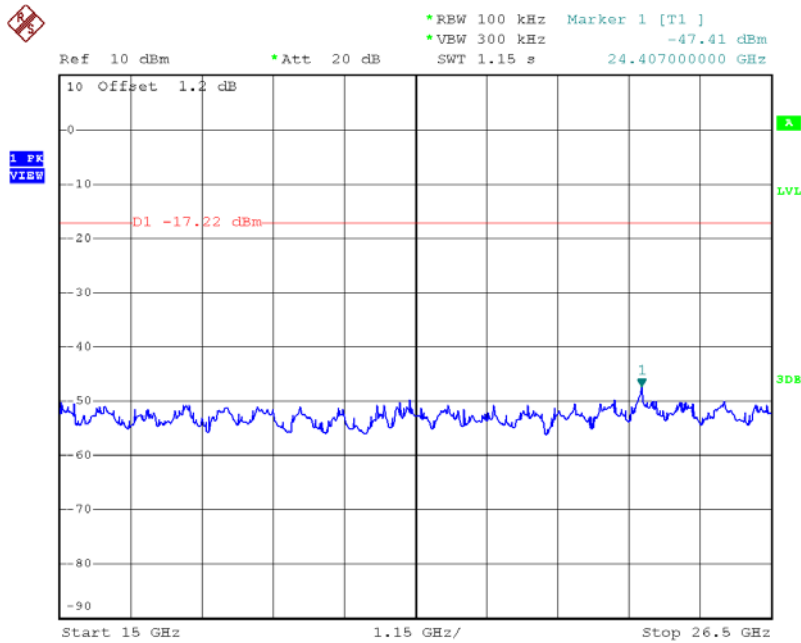

### CH39 (10 Harmonic of the frequency) 1

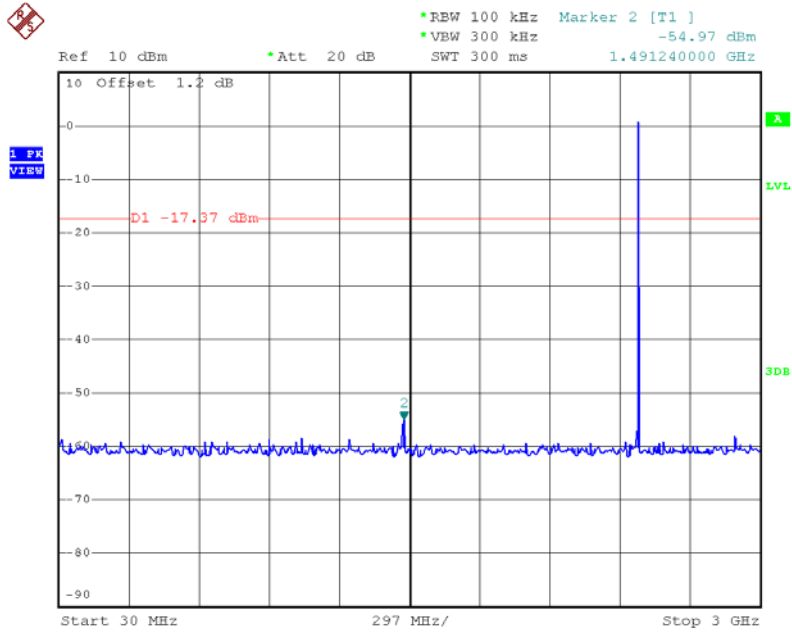

### CH39 (10 Harmonic of the frequency) 2

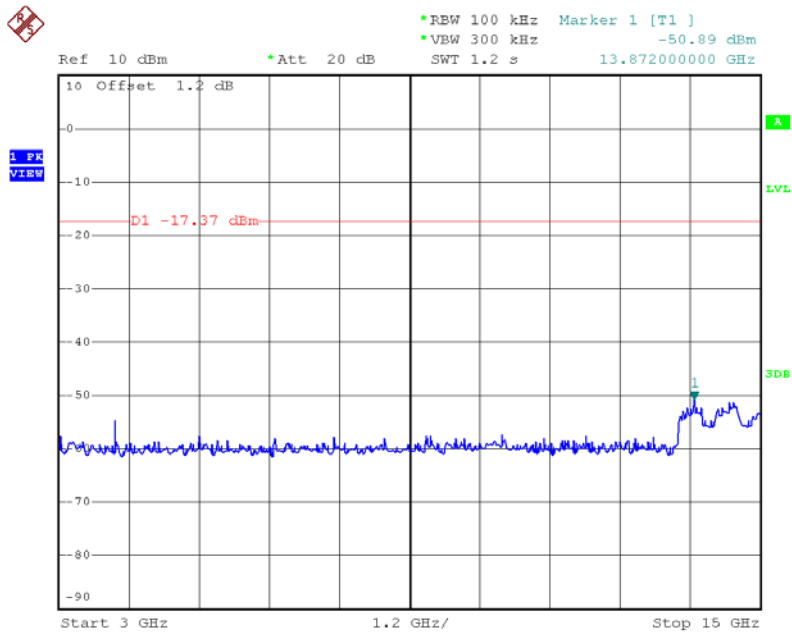

### CH39 (10 Harmonic of the frequency) 3

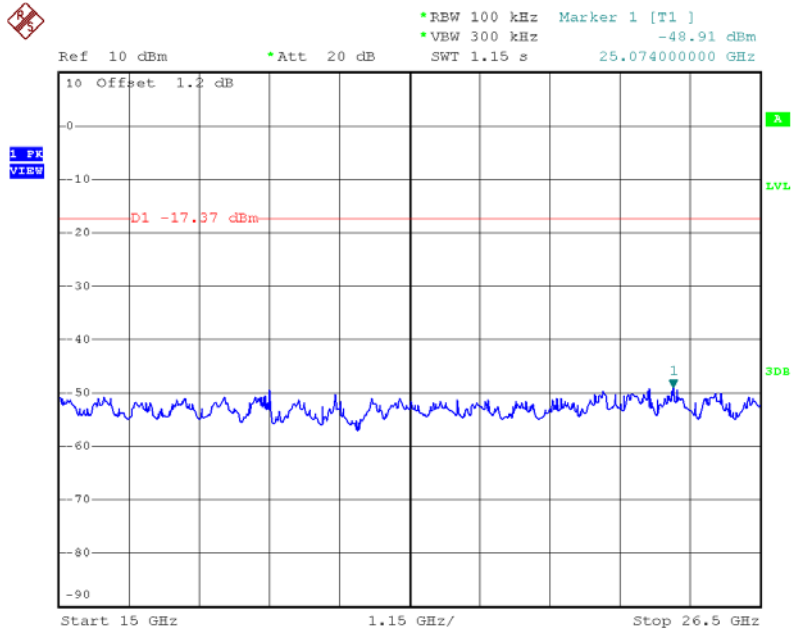



## APPENDIX H - POWER SPECTRAL DENSITY TEST

Test Mode: CH00, CH19 , CH39 - 1Mbps

Frequency (MHz)	Power Density (dBm/3kHz)	Power Density (mW/3kHz)	Max. Limit (dBm/3kHz)	Test Result
2402	-10.680	0.086	8.00	Pass
2440	-10.340	0.092	8.00	Pass
2480	-11.280	0.074	8.00	Pass

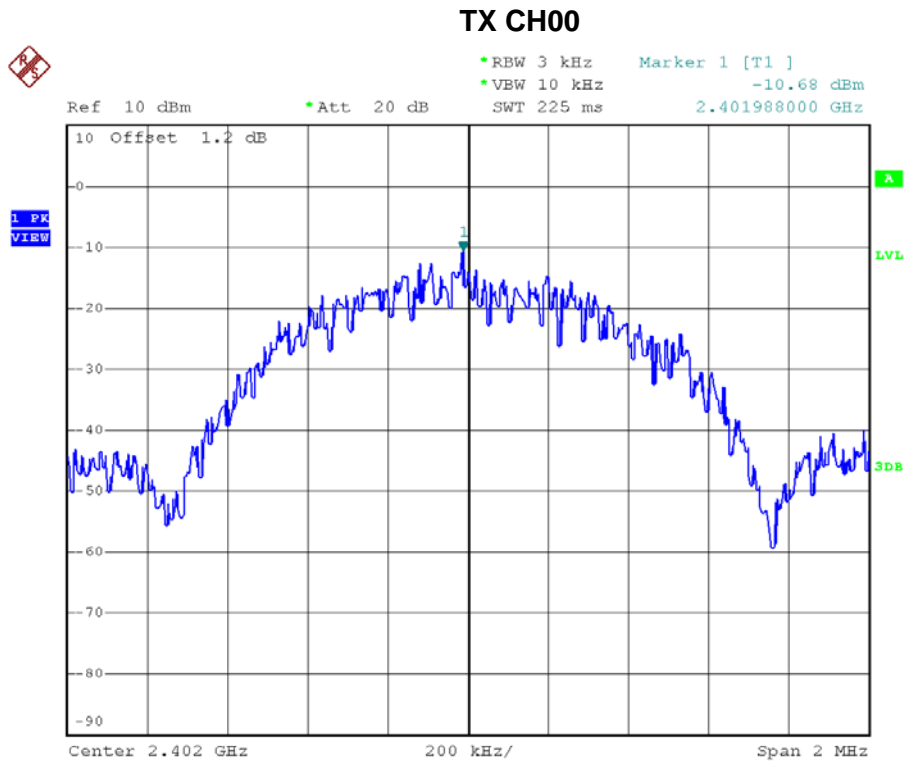

### TX CH19

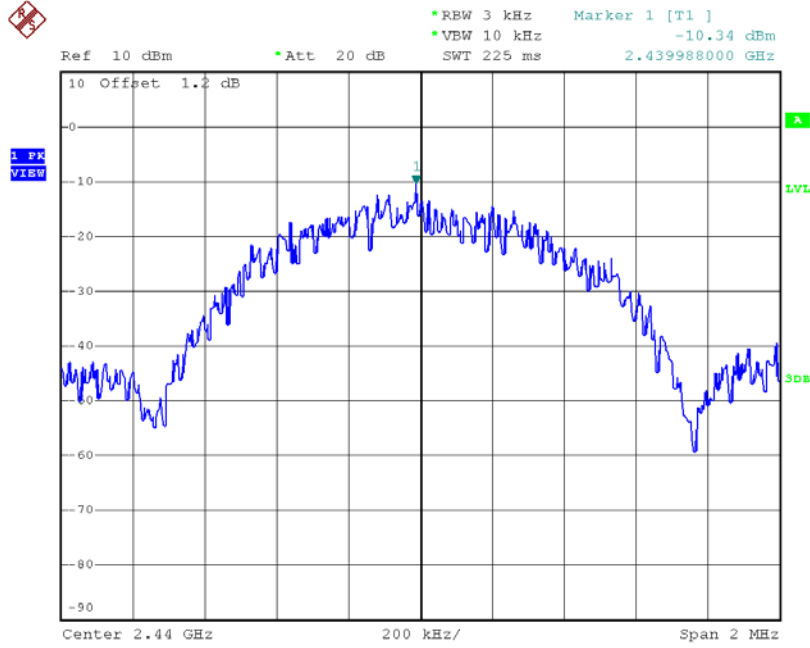

### TX CH39

