



TEST REPORT

Test report no.: 23-1-0068401T005a

BNetzA-CAB-02/21-102

Testing laboratory

cetecom advanced GmbH
Untertuerkheimer Strasse 6 – 10
66117 Saarbruecken / Germany
Phone: + 49 681 5 98 - 0
Fax: + 49 681 5 98 - 9075
Internet: <https://cetecomadvanced.com>
e-mail: mail@cetecomadvanced.com

Accredited Testing Laboratory:

The testing laboratory (area of testing) is accredited according to DIN EN ISO/IEC 17025 (2018-03) by the Deutsche Akkreditierungsstelle GmbH (DAkkS)
The accreditation is valid for the scope of testing procedures as stated in the accreditation certificate starting with the registration number: D-PL-12076-01.

Applicant

SAGEMCOM BROADBAND SAS
250, route de l' Empereur
92848 Rueil-Malmaison Cedex / FRANCE
Phone: -/-
Contact: Stéphane Hergault
e-mail: stephane.hergault@sagemcom.com

Manufacturer

SAGEMCOM BROADBAND SAS
250, route de l' Empereur
92848 Rueil-Malmaison Cedex / FRANCE

Test standard/s

FCC - Title 47 CFR Part 15 FCC - Title 47 of the Code of Federal Regulations; Chapter I; Part 15 - Radio frequency devices

For further applied test standards please refer to section 3 of this test report.

Test Item

Kind of test item: **Video Player**
Model name: **DIW377 DISH**
FCC ID: **VW3DIW377D**
Frequency: 5150 MHz to 5850 MHz
Technology tested: WLAN (DFS only)
Antenna: Two integrated antennas
Power supply: 115V AC by mains
Temperature range: 0°C to 40°C

This test report is electronically signed and valid without handwritten signature. For verification of the electronic signatures, the public keys can be requested at the testing laboratory.

Test report authorized:

David Lang
Lab Manager
Radio Labs

Test performed:

Andreas Kurzkurt
Testing Manager
Radio Labs

1 Table of contents

1	Table of contents.....	2
2	General information.....	3
2.1	Notes and disclaimer.....	3
2.2	Application details.....	3
2.3	Test laboratories sub-contracted.....	3
3	Test standard/s, references and accreditations.....	4
4	Reporting statements of conformity – decision rule.....	5
5	Test environment.....	6
6	Test item.....	6
6.1	General description.....	6
6.2	Additional information.....	6
7	Measurement uncertainty.....	7
8	Summary of measurement results.....	8
9	Additional comments.....	9
10	RF measurements.....	10
10.1	Description of test setup.....	10
10.1.1	Conducted measurements.....	10
10.2	Parameters of DFS test signals.....	11
10.2.1	DFS Detection Thresholds for Master Devices as well as Client Devices With Radar Detection.....	11
10.2.2	DFS Response Requirement Values.....	11
10.2.3	Radar Test Waveforms.....	12
10.3	Test preparation.....	15
10.3.1	Setting the test signal level of all radar pulses as of 10.2.1 (only pulse 0 recorded).....	15
10.3.2	Channel loading.....	16
10.3.3	99% Bandwidth to determine the U-NII-bandwidth.....	17
10.3.4	Radar burst timing signal.....	18
10.4	Test results (prior to use of a channel).....	19
10.5	Test results (during normal operation).....	19
10.5.1	Channel move time / channel closing transmission time.....	19
11	Observations.....	21
12	Glossary.....	21
13	Document history.....	22
14	Accreditation Certificate – D-PL-12076-01-05.....	22

2 General information

2.1 Notes and disclaimer

The test results of this test report relate exclusively to the test item specified in this test report. cetecom advanced GmbH does not assume responsibility for any conclusions and generalizations drawn from the test results with regard to other specimens or samples of the type of the equipment represented by the test item.

The test report may only be reproduced or published in full. Reproduction or publication of extracts from the report requires the prior written approval of cetecom advanced GmbH.

The testing service provided by cetecom advanced GmbH has been rendered under the current "General Terms and Conditions for cetecom advanced GmbH".

cetecom advanced GmbH will not be liable for any loss or damage resulting from false, inaccurate, inappropriate or incomplete product information provided by the customer.

Under no circumstances does the cetecom advanced GmbH test report include any endorsement or warranty regarding the functionality, quality or performance of any other product or service provided.

Under no circumstances does the cetecom advanced GmbH test report include or imply any product or service warranties from cetecom advanced GmbH, including, without limitation, any implied warranties of merchantability, fitness for purpose, or non-infringement, all of which are expressly disclaimed by cetecom advanced GmbH.

All rights and remedies regarding vendor's products and services for which cetecom advanced GmbH has prepared this test report shall be provided by the party offering such products or services and not by cetecom advanced GmbH.

In no case this test report can be considered as a Letter of Approval.

This test report is electronically signed and valid without handwritten signature. For verification of the electronic signatures, the public keys can be requested at the testing laboratory.

2.2 Application details

Date of receipt of test item:	2023-06-19
Start of test:*	2023-06-28
End of test:*	2023-06-28
Person(s) present during the test:	-/-

*Date of each measurement, if not shown in the plot, can be requested. Dates are stored in the measurement software.

2.3 Test laboratories sub-contracted

None

3 Test standard/s, references and accreditations

Test standard	Date	Description
FCC - Title 47 CFR Part 15		FCC - Title 47 of the Code of Federal Regulations; Chapter I; Part 15 - Radio frequency devices

Guidance	Version	Description
KDB 789033 D02	v02r01	Guidelines for Compliance Testing of Unlicensed National Information Infrastructure (U-NII) Devices - Part 15, Subpart E
ANSI C63.4-2014	-/-	American National Standard for Methods of Measurement of Radio-Noise Emissions from Low-Voltage Electrical and Electronic Equipment in the Range of 9 kHz to 40 GHz
ANSI C63.10-2013	-/-	American National Standard of Procedures for Compliance Testing of Unlicensed Wireless Devices
KDB 662911 D01	v02r01	Emissions Testing of Transmitters with Multiple Outputs in the Same Band
UNII: KDB 905462 D02	v02	Compliance measurement procedures for unlicensed - national information infrastructure devices operating in the 5250 - 5350 MHz and 5470 - 5725 MHz bands incorporating dynamic frequency selection
UNII: KDB 905462 D03	v01r02	Client Without DFS New Rules
UNII: KDB 905462 D04	v01	Operational Modes for DFS Testing New Rules

Accreditation	Description
D-PL-12076-01-05	Telecommunication FCC requirements https://www.dakks.de/as/ast/d/D-PL-12076-01-05e.pdf



FCC designation number: DE0002

4 Reporting statements of conformity – decision rule

Only the measured values related to their corresponding limits will be used to decide whether the equipment under test meets the requirements of the test standards listed in chapter 3. The measurement uncertainty is mentioned in this test report, see chapter 7, but is not taken into account - neither to the limits nor to the measurement results. Measurement results with a smaller margin to the corresponding limits than the measurement uncertainty have a potential risk of more than 5% that the decision might be wrong."

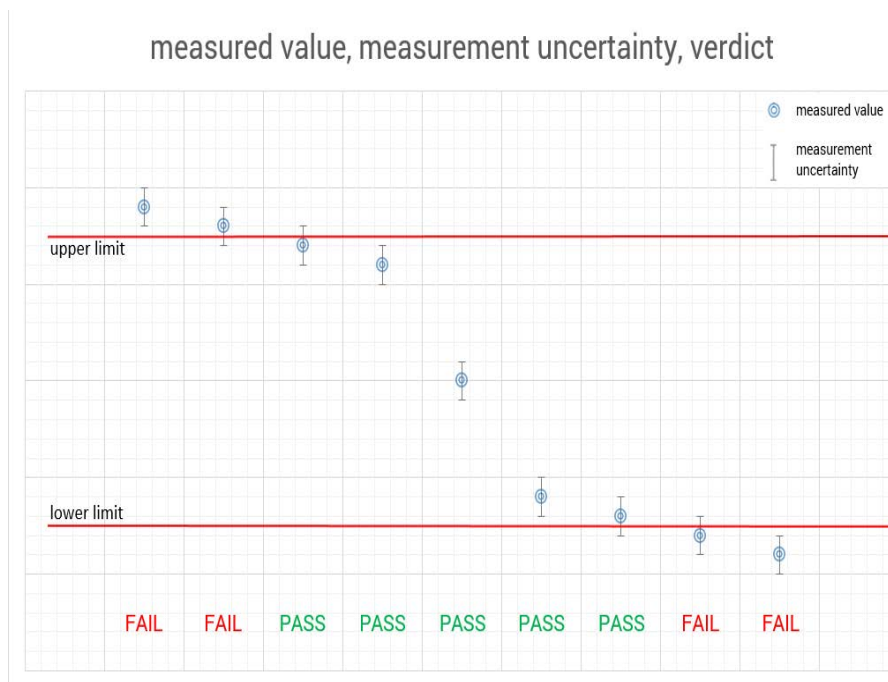

5 Test environment

Temperature	:	T_{nom} 20 °C during room temperature tests T_{max} No tests under extreme temperature conditions required. T_{min} No tests under extreme temperature conditions required.
Relative humidity content	:	45 %
Barometric pressure	:	Not relevant for this kind of testing
Power supply	:	V_{nom} 115 V AC by mains V_{max} No tests under extreme voltage conditions required. V_{min} No tests under extreme voltage conditions required.

6 Test item

6.1 General description

Kind of test item	:	Video Player
Model name	:	DIW377 DISH
S/N serial number	:	123456789012
Hardware status	:	CIE : 254046629 CIU : 253996495
Software status	:	TTHW compiled Wed 10 May 2023 09:31:07 AM CEST by Jenkins From 0f5de0b Broadcom SDK 22.0.1 Boxmode:2
Firmware status	:	STB_BCM4375B1_100.010_4375B1_UART_37_4MHz_fcbga_ipa_ref_stbda_cl ass2.hcd
Frequency band	:	5150 MHz to 5850 MHz
Type of radio transmission	:	OFDM
Use of frequency spectrum	:	
Type of modulation	:	(D)BPSK, (D)QPSK, 16 – QAM, 64 – QAM
Number of channels	:	25 with 20 MHz channel bandwidth 12 with 40 MHz channel bandwidth 6 with 80 MHz channel bandwidth
Antenna	:	Two integrated antennas
Power supply	:	115 V AC by mains
Temperature range	:	0°C to 40°C

6.2 Additional information

The content of the following annexes is defined in the QA. It may be that not all of the listed annexes are necessary for this report, thus some values in between may be missing.

Test setup and EUT photos are included in test report:

- 23-1-0068401T004_A2
- 23-1-0068401T004_A3
- 23-1-0068401T004_A4

7 Measurement uncertainty

Measurement uncertainty	
Test case	Uncertainty
Frequency accuracy (radar burst)	0.2 Hz
Level accuracy (radar burst)	± 1.83 dB

8 Summary of measurement results

<input checked="" type="checkbox"/>	No deviations from the technical specifications were ascertained
<input type="checkbox"/>	There were deviations from the technical specifications ascertained
<input checked="" type="checkbox"/>	This test report is only a partial test report. The content and verdict of the performed test cases are listed below.

TC Identifier	Description	Verdict	Date	Remark
DFS-Testing	CFR Part 15, FCC 06-96	Pass	2023-07-06	DFS only

Test Standard Clause	Test Case	Bandwidth	C	NC	NA	NP	Remark
7.8.1* ³	U-NII Detection Bandwidth	-/-	<input type="checkbox"/>	<input type="checkbox"/>	<input checked="" type="checkbox"/>	<input type="checkbox"/>	*1*2*3
§15.407 (h)(2)	DFS Detection Threshold	-/-	<input type="checkbox"/>	<input type="checkbox"/>	<input checked="" type="checkbox"/>	<input type="checkbox"/>	*1*2*3
§15.407 (h)(2) (ii) & 7.8.2* ³	Channel Availability Check Time	-/-	<input type="checkbox"/>	<input type="checkbox"/>	<input checked="" type="checkbox"/>	<input type="checkbox"/>	*1*3
§15.407 (h)(2) (iv) & 7.8.3* ³	Non-Occupancy Period	-/-	<input type="checkbox"/>	<input type="checkbox"/>	<input checked="" type="checkbox"/>	<input type="checkbox"/>	*2
§15.407 (h)(2) (iii) & 7.8.2* ³	Channel Move Time / Channel Closing Transmission Time	80 MHz	<input checked="" type="checkbox"/>	<input type="checkbox"/>	<input type="checkbox"/>	<input type="checkbox"/>	*2
7.8.3 & 7.8.4* ³	In-Service Monitoring / Statistical Performance Check	-/-	<input type="checkbox"/>	<input type="checkbox"/>	<input checked="" type="checkbox"/>	<input type="checkbox"/>	*2*3

Abbreviations/References:

- C Compliant
- NC Not compliant
- NA Not applicable
- NP Not performed
- *1 Prior to use of a channel
- *2 During normal operation
- *3 Not applicable for Client Devices without radar detection.

9 Additional comments

Reference documents: None

Configuration descriptions: Iperf was used to generate the required channel load (duty cycle greater 17 percent).

DFS functionality: Master device
 Client with radar detection
 Client without radar detection

EUT selection: Only one device available
 Devices selected by the customer
 Devices selected by the laboratory (Randomly)

10 RF measurements

10.1 Description of test setup

10.1.1 Conducted measurements

Setup

Figure 1 shows a setup whereby the UUT is a RLAN device operating in slave mode, without Radar Interference Detection function. This setup also contains a RLAN device operating in master mode. The radar test signals are injected into the master device. The UUT (slave device) is associated with the master device.

Figure 1 shows an example

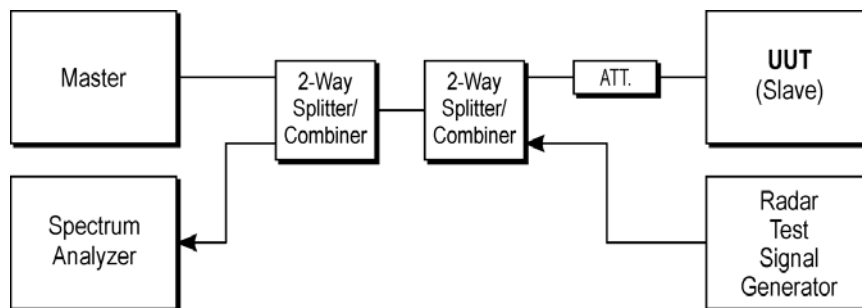

Figure 1: Setup

RPP = SG - CA

(RPP-radar pulse power; SG-signal generator power; CA-loss signal path)

Example calculation:

$$RPP [dBm] = -30.0 [dBm] - 33.0 [dB] = -63.0 [dBm]$$

Equipment table:

No.	Lab / Item	Equipment	Type	Manufacturer	Serial No.	INV. No Cetecom	Kind of Calibration	Last Calibration	Next Calibration
1	A	Spectrum Analyzer 9kHz - 30 GHz	FSP30	R&S	100623	300003464	vIKI!	14.12.2022	31.12.2024
2	A	Vector Signal Generator	SMU200A	R&S	101633	300003496	vIKI!	04.01.2022	31.01.2025
3	A	DFS-test site	div. Splitter, Cables, Attenuators	Mini-Circuits	na	300004557	ev	-/-	-/-
4	A	RF-Cable WLAN-Tester Port 2	ST18/SMAm/SMAm /48	Huber & Suhner	Batch no. 54877	400001217	ev	-/-	-/-
5	A	RF-Cable WLAN-Tester Port 1	ST18/SMAm/SMAm /48	Huber & Suhner	Batch no. 54877	400001218	ev	-/-	-/-
6	A	RF-Cable WLAN-Tester Analyzer	ST18/SMAm/SMAm /36	Huber & Suhner	Batch no. 54876	400001220	ev	-/-	-/-
7	A	RF-Cable WLAN-Tester Vector Signal Generator	ST18/SMAm/SMAm /60	Huber & Suhner	Batch no. 606844	400001222	ev	-/-	-/-
8	A	Dual Band Gigabit Router	RT-AC68U*	Asus	F11MOH056666	400001244	ne	-/-	-/-
9	A	Isolating Transformer	RT5A	Grundig	12780	300001166	ev	-/-	-/-

* FCC ID: MSQ-RTAC68U

10.2 Parameters of DFS test signals

10.2.1 DFS Detection Thresholds for Master Devices as well as Client Devices With Radar Detection

Maximum Transmit Power EIRP	Value (see note)
≥ 200 mW	-64 dBm
< 200 mW and power spectral density < 10 dBm/MHz	-62 dBm
< 200 mW and That do not meet the power spectral density < 10 dBm/MHz	-64 dBm

Note 1: This is the level at the input of the receiver assuming a 0 dBi receive antenna.
Note 2: Throughout these test procedures an additional 1 dB has been added to the amplitude of the test transmission waveforms to account for variations in measurement equipment. This will ensure that the test signal is at or above the detection threshold level to trigger a DFS response.
Note3: EIRP is based on the highest antenna gain. For MIMO devices refer to KDB Publication 662911 D01.

10.2.2 DFS Response Requirement Values

Parameter	Value
Non-occupancy period	minimum 30 minutes
Channel Availability Check Time	60 seconds
Channel Move Time	10 seconds See Note 1.
Channel Closing Transmission Time	200 milliseconds + an aggregate of 60 milliseconds over remaining 10 second period. See Notes 1 and 2.
U-NII Detection Bandwidth	Minimum 100% of the U-NII 99% transmission power bandwidth. See Note 3.

Note 1: Channel Move Time and the Channel Closing Transmission Time should be performed with Radar Type 0. The measurement timing begins at the end of the Radar Type 0 burst.
Note 2: The Channel Closing Transmission Time is comprised of 200 milliseconds starting at the beginning of the Channel Move Time plus any additional intermittent control signals required to facilitate a Channel move (an aggregate of 60 milliseconds) during the remainder of the 10 second period. The aggregate duration of control signals will not count quiet periods in between transmissions.
Note 3: During the U-NII Detection Bandwidth detection test, radar type 0 should be used. For each frequency step the minimum percentage of detection is 90 percent. Measurements are performed with no data traffic.

10.2.3 Radar Test Waveforms

This section provides the parameters for required test waveforms, minimum percentage of successful detections, and the minimum number of trials that must be used for determining DFS conformance.

Short Pulse Radar Test Waveforms

Radar Type	Pulse Width (µsec)	PRI (µsec)	Number of Pulses	Minimum Percentage of Successful Detection	Minimum Number of Trials
0	1	1428	18	See Note 1	See Note 1
1	1	Test A: 15 unique PRI values randomly selected from the list of 23 PRI values in Table 5a	Roundup $\left\lceil \left(\frac{1}{360} \cdot \frac{19 \cdot 10^6}{PRI_{\mu sec}} \right) \right\rceil$	60%	30
		Test B: 15 unique PRI values randomly selected within the range of 518-3066 µsec, with a minimum increment of 1 µsec, excluding PRI values selected in Test A			
2	1-5	150-230	23-29	60%	30
3	6-10	200-500	16-18	60%	30
4	11-20	200-500	12-16	60%	30
Aggregate (Radar Types 1-4)				80%	120
Note 1: Short Pulse Radar Type 0 should be used for the detection bandwidth test, channel move time, and channel closing time tests.					

A minimum of 30 unique waveforms are required for each of the Short Pulse Radar Types 2 through 4.

Pulse Repetition Intervals Values for Test A

Pulse Repetition Frequency Number	Pulse Repetition Frequency (Pulses Per Second)	Pulse Repetition Interval (Microseconds)
1	1930.5	518
2	1858.7	538
3	1792.1	558
4	1730.1	578
5	1672.2	598
6	1618.1	618
7	1567.4	638
8	1519.8	658
9	1474.9	678
10	1432.7	698
11	1392.8	718
12	1355	738
13	1319.3	758
14	1285.3	778
15	1253.1	798
16	1222.5	818
17	1193.3	838
18	1165.6	858
19	1139	878
20	1113.6	898
21	1089.3	918
22	1066.1	938
23	326.2	3066

Long Pulse Radar Test Waveform

Radar Type	Pulse Width (µsec)	Chirp Width (MHz)	PRI (µsec)	Number of Pulses per Burst	Number of Bursts	Minimum Percentage of Successful Detection	Minimum Number of Trials
5	50-100	5-20	1000-2000	1-3	8-20	80%	30

The parameters for this waveform are randomly chosen. Thirty unique waveforms are required for the Long Pulse Radar Type waveforms.

Frequency Hopping Radar Test Waveform

Radar Type	Pulse Width (µsec)	Chirp Width (MHz)	Pulses per Hop	Hopping Rate (kHz)	Hopping Sequence Length (msec)	Minimum Percentage of Successful Detection	Minimum Number of Trials
6	1	333	9	0.333	300	70%	30

For the Frequency Hopping Radar Type, the same Burst parameters are used for each waveform. The hopping sequence is different for each waveform and a 100-length segment is selected from the hopping sequence defined.

The first frequency in a hopping sequence is selected randomly from the group of 475 integer frequencies from 5250 – 5724 MHz. Next, the frequency that was just chosen is removed from the group and a frequency is randomly selected from the remaining 474 frequencies in the group. This process continues until all 475 frequencies are chosen for the set.

10.3 Test preparation

10.3.1 Setting the test signal level of all radar pulses as of 10.2.1 (only pulse 0 recorded).

Example plot

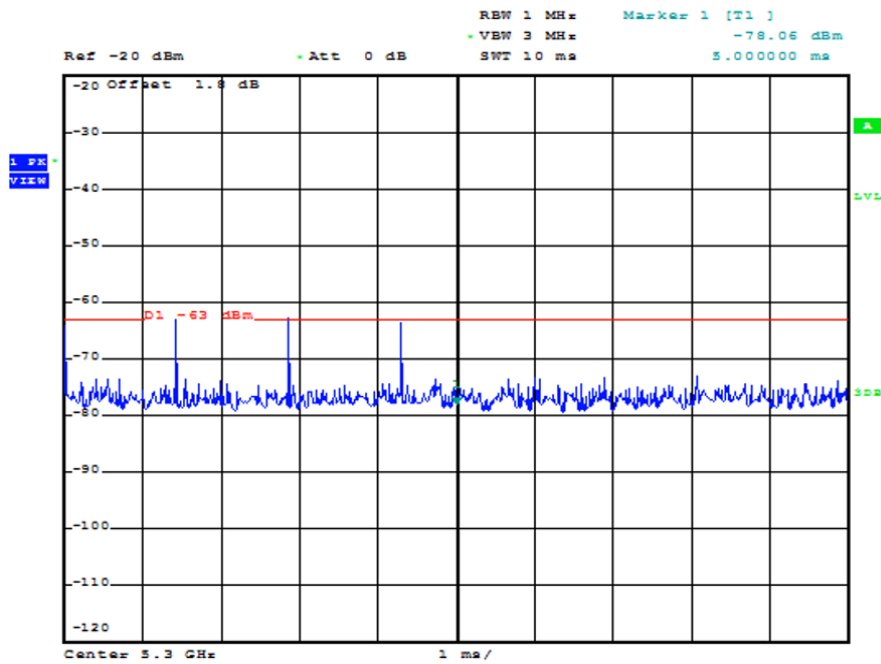

Plot 1

10.3.2 Channel loading

Timing plots are required with calculations demonstrating a minimum channel loading of approximately 17% or greater. For example, channel loading can be estimated by setting the spectrum analyzer for zero span and approximate the Time On/ (Time On + Off Time). This can be done with any appropriate channel BW and modulation type.

HT80-Mode: Calculated duty cycle = 17.1%

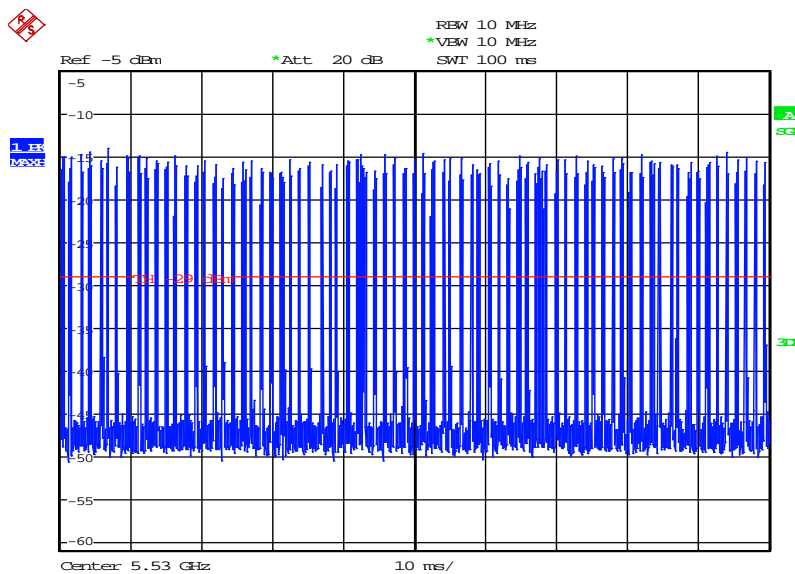

Date: 28.JUN.2023 10:19:15

Plot 2

10.3.399% Bandwidth to determine the U-NII-bandwidth

HT80-Mode: 76.16 MHz

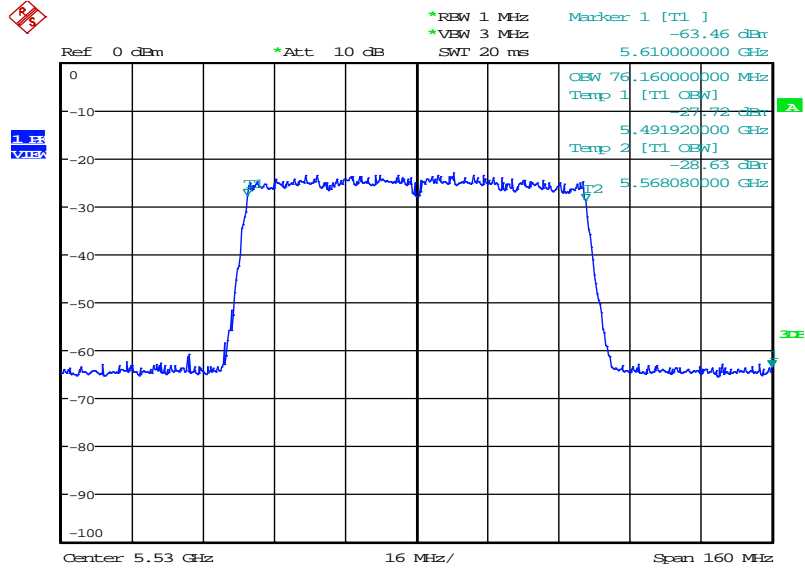

Date: 28.JUN.2023 10:19:56

Plot 3

10.3.4 Radar burst timing signal

To accurately determine the channel closing time and channel closing transmission time the spectrum analyser is triggered at the end of the radar burst (see marker at $t = 0$ ms).

Example plot

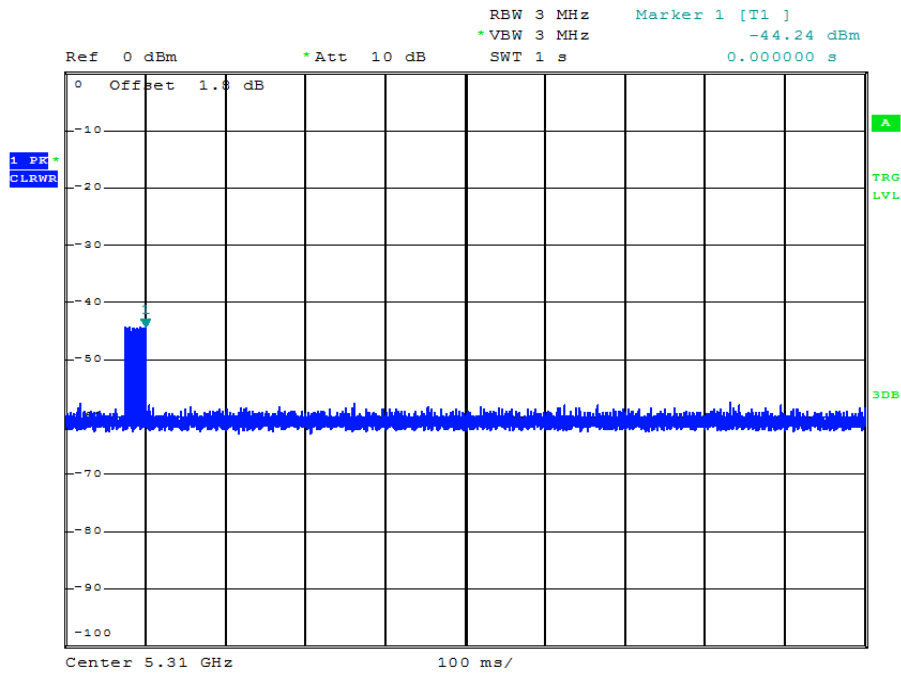

Plot 4

10.4 Test results (prior to use of a channel)

Not applicable.

10.5 Test results (during normal operation)

10.5.1 Channel move time / channel closing transmission time

After a radar's presence is detected, all transmissions shall cease on the operating channel within 10 seconds. Transmissions during this period shall consist of normal traffic for a maximum of 200 ms after detection of the radar signal. In addition, intermittent management and control signals can be sent during the remaining time to facilitate vacating the operating channel not exceeding 60ms.

The test is performed during normal operation with the highest bandwidth supported by the DUT.

Channel Closing Time

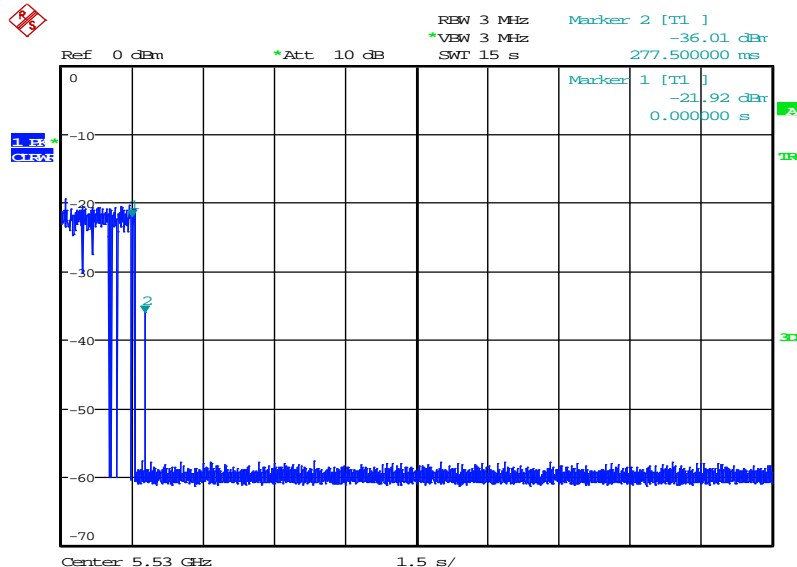

Date: 28.JUN.2023 10:20:34

Plot 5

Note: With Marker 1 at the end of the radar pulse ($t = 0$ ms) the Channel Closing Time is determined by setting

a Delta-Marker to the point where the last transmission occurred.

The Channel Closing Time is 277 ms.

Channel Closing Transmission Time

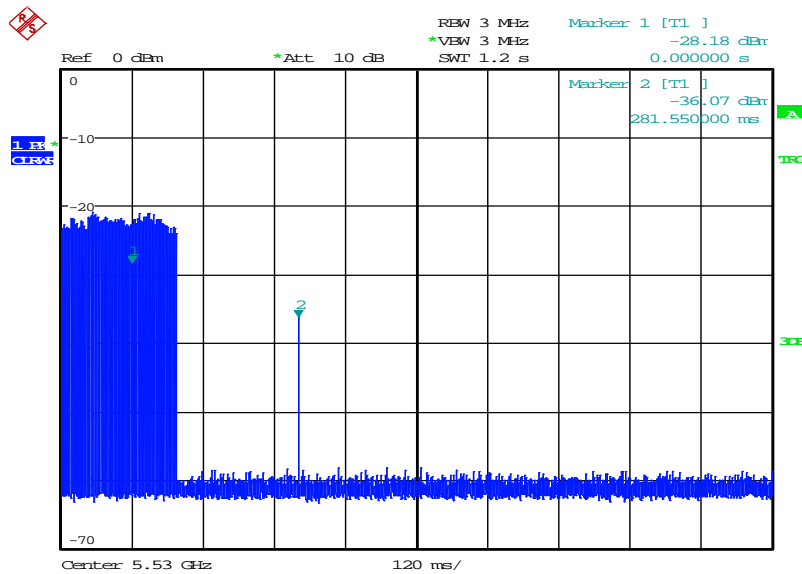

Date: 28.JUN.2023 10:41:14

Plot 6

Note: The accumulated transmission time is calculated by the number of bins occurring after $t = 0$ ms multiplied with the Time-per-sweep point-factor resulting from the Sweep Time and number of Sweep Points of the Spectrum Analyser.
 The Channel Closing Transmission Time is 0.2ms.

11 Observations

No observations except those reported with the single test cases have been made.

12 Glossary

EUT	Equipment under test
DUT	Device under test
UUT	Unit under test
FCC	Federal Communications Commission
FCC ID	Company Identifier at FCC
IC	Industry Canada
PMN	Product marketing name
HMN	Host marketing name
HVIN	Hardware version identification number
FVIN	Firmware version identification number
EMC	Electromagnetic Compatibility
HW	Hardware
SW	Software
Inv. No.	Inventory number
S/N or SN	Serial number
C	Compliant
NC	Not compliant
NA	Not applicable
NP	Not performed
PP	Positive peak
AVG	Average
OC	Operating channel
OCW	Operating channel bandwidth
OBW	Occupied bandwidth
OOB	Out of band
DFS	Dynamic frequency selection
CAC	Channel availability check
OP	Occupancy period
NOP	Non occupancy period
DC	Duty cycle
CW	Clean wave
MC	Modulated carrier
WLAN	Wireless local area network
RLAN	Radio local area network
DSSS	Dynamic sequence spread spectrum
OFDM	Orthogonal frequency division multiplexing
FHSS	Frequency hopping spread spectrum
GNSS	Global Navigation Satellite System

13 Document history

Version	Applied changes	Date of release
-/-	Initial release	2023-06-28

14 Accreditation Certificate – D-PL-12076-01-05

first page	last page
 <p>Deutsche Akkreditierungsstelle GmbH</p> <p>Entrusted according to Section 8 subsection 1 AkkStelleG in connection with Section 1 subsection 1 AkkStelleGBV Signatory to the Multilateral Agreements of EA, ILAC and IAF for Mutual Recognition</p> <p>Accreditation </p> <p>The Deutsche Akkreditierungsstelle GmbH attests that the testing laboratory CTC advanced GmbH Untertürkheimer Straße 6-10, 66117 Saarbrücken is competent under the terms of DIN EN ISO/IEC 17025:2018 to carry out tests in the following fields: Telecommunication (FCC Requirements)</p> <p>The accreditation certificate shall only apply in connection with the notice of accreditation of 09.06.2020 with the accreditation number D-PL-12076-01. It comprises the cover sheet, the reverse side of the cover sheet and the following annex with a total of 05 pages. Registration number of the certificate: D-PL-12076-01-05</p> <p>Frankfurt am Main, 09.06.2020 by  Dr. Ing. (FH) Alf Eigner Head of Division</p> <p><small>The certificate together with its annex reflects the status at the time of the date of issue. The current status of the scope of accreditation can be found in the database of accredited bodies of Deutsche Akkreditierungsstelle GmbH. https://www.dakks.de/en/content/accredited-bodies-dakks See notes overleaf.</small></p>	<p>Deutsche Akkreditierungsstelle GmbH</p> <p>Office Berlin Spittelmarkt 10 10117 Berlin</p> <p>Office Frankfurt am Main Europa-Allee 52 60327 Frankfurt am Main</p> <p>Office Braunschweig Bundesallee 100 38116 Braunschweig</p> <p>The publication of extracts of the accreditation certificate is subject to the prior written approval by Deutsche Akkreditierungsstelle GmbH (DAkks). Exempted is the unchanged form of separate disseminations of the cover sheet by the conformity assessment body mentioned overleaf.</p> <p>No impression shall be made that the accreditation also extends to fields beyond the scope of accreditation attested by DAkks.</p> <p>The accreditation was granted pursuant to the Act on the Accreditation Body (AkkStelleG) of 31 July 2009 (Federal Law Gazette I p. 2525) and the Regulation (EC) No 765/2008 of the European Parliament and of the Council of 9 July 2008 setting out the requirements for accreditation and market surveillance relating to the marketing of products (Official Journal of the European Union L 218 of 9 July 2008, p. 30). DAkks is a signatory to the Multilateral Agreements for Mutual Recognition of the European co-operation for Accreditation (EA), International Accreditation Forum (IAF) and International Laboratory Accreditation Cooperation (ILAC). The signatories to these agreements recognise each other's accreditations.</p> <p>The up-to-date state of membership can be retrieved from the following websites: EA: www.european-accreditation.org ILAC: www.ilac.org IAF: www.iaf.nu</p>

Note: The current certificate annex is published on the websites (link see below).

<https://www.dakks.de/files/data/as/pdf/D-PL-12076-01-05e.pdf>

or

https://cetecomadvanced.com/files/pdfs/d-pl-12076-01-05_tcb_usa.pdf

END OF TEST REPORT