



LCIE

WIFI 5GHz Template: Release October 03rd, 2016

TEST REPORT

N°: 155636-721608E

Version : 01







Subject

Radio spectrum matters
tests according to standards:
47 CFR Part 15.407 (DFS Only) 

Issued to

SAGEMCOM BROADBAND SAS
250 Route de l' Empereur
92500 – RUEIL MALMAISON
FRANCE

Apparatus under test

-  Product
-  Trade mark
-  Manufacturer
-  Model under test
-  Serial number
-  FCC ID

Home router
SAGEMCOM
SAGEMCOM
DCIWA384 UHD Alt US V2
253764997
VW3DCIWA384-V2

Test date

: September 3, 2018 to September 5, 2018

Test location

Fontenay Aux Roses

Composition of document

98 pages

Document issued on

September 13, 2018

Written by :
Mathieu CERISIER
Tests operator



This document shall not be reproduced, except in full, without the written approval of the LCIE. This document contains results related only to the items tested. It does not imply the conformity of the whole production to the items tested. Unless otherwise specified, the decision of conformity takes into account the uncertainty of measurement. This document doesn't anticipate any certification decision.

LCIE

Laboratoire Central des Industries Electriques
Une société de Bureau Veritas

33, Av du Général Leclerc
92266 Fontenay Aux Roses
FRANCE

Tél : +33 1 40 95 60 60
contact@lcie.fr
www.lcie.fr



PUBLICATION HISTORY

Version	Date	Author	Modification
01	June 22, 2018	Mathieu CERISIER	Creation of the document



L C I E

SUMMARY

1.	TEST PROGRAM	4
2.	EQUIPMENT UNDER TEST: CONFIGURATION (DECLARED BY PROVIDER).....	5
3.	DFS DETECTION THRESHOLDS DETERMINATION, REFERENCE NOISE LEVEL & CHANNEL LOADING	20
4.	DYNAMIC FREQUENCY SELECTION (DFS): CHANNEL AVAILABILITY CHECK & DFS DETECTION THRESHOLD	29
5.	DYNAMIC FREQUENCY SELECTION (DFS): U-NII DETECTION BANDWIDTH	35
6.	DYNAMIC FREQUENCY SELECTION (DFS): STATISTICAL PERFORMANCE CHECK.....	41
7.	DYNAMIC FREQUENCY SELECTION (DFS): CHANNEL CLOSING TRANSMISSION TIME & CHANNEL MOVE TIME.....	47
8.	DYNAMIC FREQUENCY SELECTION (DFS): NON-OCCUPANCY PERIOD	53
9.	ANNEX 1: U-NII DETECTION BANDWIDTH DATA SHEET	59
10.	ANNEX 2: STATISTICAL PERFORMANCE CHECK DATA SHEET	62
11.	ANNEX 3: RADAR TEST SIGNAL TYPE 5 & 0	68
12.	UNCERTAINTIES CHART	98



1. TEST PROGRAM

References

- 47 CFR Part 15.407 (DFS requirements)
- KDB 905462 D02 UNII DFS Compliance Procedures New Rules v02
- KDB 905462 D04 Test Mode New Rules v01
- KDB 905462 D03 Client Without DFS New Rules v01r02
- KDB 905462 D06 802.11 Channel Plans New Rules v02
- KDB 905462 D07 Overview UNII Rules v02

Radio requirement:

Clause (47CFR Part 15.407) Test Description	Test result - Comments			
Channel Availability Check Time & DFS Detection Threshold P	<input checked="" type="checkbox"/> PASS	<input type="checkbox"/> FAIL	<input type="checkbox"/> NA(1)(2)	<input type="checkbox"/> NP(3)
U-NII Detection Bandwidth P	<input checked="" type="checkbox"/> PASS	<input type="checkbox"/> FAIL	<input type="checkbox"/> NA(1)	<input type="checkbox"/> NP(3)
Statistical Performance Check & DFS Detection Threshold P	<input checked="" type="checkbox"/> PASS	<input type="checkbox"/> FAIL	<input type="checkbox"/> NA	<input type="checkbox"/> NP(3)
Channel Closing Transmission Time & Channel Move Time P	<input checked="" type="checkbox"/> PASS	<input type="checkbox"/> FAIL	<input type="checkbox"/> NA	<input type="checkbox"/> NP(3)
Non-occupancy period P	<input checked="" type="checkbox"/> PASS	<input type="checkbox"/> FAIL	<input type="checkbox"/> NA(1)	<input type="checkbox"/> NP(3)
This table is a summary of test report, see conclusion of each clause of this test report for detail.				

- (1): Client without radar detection
 (2): Client with radar detection
 (3): Limited program

2. EQUIPMENT UNDER TEST: CONFIGURATION (DECLARED BY PROVIDER)

2.1. HARDWARE IDENTIFICATION (EUT AND AUXILIARIES):

Equipment under test (EUT):
SAGEMCOM DCIWA384 UHD Alt US V2

Serial Number: 253764997



Front face



Back face



Rear face



DOKOCOM Power supply

Equipment Under Test



MOSO Power supply

NetBit Power supply

Equipment Under Test

Inputs/outputs - Cable:

Access	Type	Length used (m)	Declared <3m	Shielded	Under test	Comments
Ethernet cable	-	-	<input type="checkbox"/>	<input type="checkbox"/>	<input type="checkbox"/>	-
Power supply cable	-	-	<input type="checkbox"/>	<input type="checkbox"/>	<input type="checkbox"/>	-

Auxiliary equipment used during test:

Type	Reference	Sn	Comments
Laptop computer	-	-	-



L C I E

Equipment information:

Type:	WIFI			
Frequency band:	<input checked="" type="checkbox"/> 5150MHz-5250MHz	<input checked="" type="checkbox"/> 5250MHz-5350MHz	<input checked="" type="checkbox"/> 5470MHz-5725MHz	
	<input checked="" type="checkbox"/> 5725MHz-5850MHz			
Standard:	<input checked="" type="checkbox"/> 802.11a	<input checked="" type="checkbox"/> 802.11n HT20	<input checked="" type="checkbox"/> 802.11n HT40	
	<input checked="" type="checkbox"/> 802.11ac VHT20	<input checked="" type="checkbox"/> 802.11ac VHT40	<input checked="" type="checkbox"/> 802.11ac VHT80	
	<input type="checkbox"/> 802.11ac VHT160			
Spectrum Modulation:	<input checked="" type="checkbox"/> OFDM			
Channel bandwidth:	<input checked="" type="checkbox"/> 20MHz	<input checked="" type="checkbox"/> 40MHz	<input checked="" type="checkbox"/> 80MHz	<input type="checkbox"/> 160MHz
Antenna Type:	<input checked="" type="checkbox"/> Integral	<input type="checkbox"/> External	<input type="checkbox"/> Dedicated	
Antenna connector:	<input checked="" type="checkbox"/> Yes	<input type="checkbox"/> No	<input type="checkbox"/> Temporary for test	
Transmit chains:	<input type="checkbox"/> 1	<input type="checkbox"/> 2	<input type="checkbox"/> 3	<input checked="" type="checkbox"/> 4
	<input type="checkbox"/> 5	<input type="checkbox"/> 6	<input type="checkbox"/> 7	<input type="checkbox"/> 8
TPC:	<input checked="" type="checkbox"/> Yes		<input type="checkbox"/> No	
Receiver chains	<input type="checkbox"/> 1	<input type="checkbox"/> 2	<input type="checkbox"/> 3	<input checked="" type="checkbox"/> 4
	<input type="checkbox"/> 5	<input type="checkbox"/> 6	<input type="checkbox"/> 7	<input type="checkbox"/> 8
Type of equipment:	<input checked="" type="checkbox"/> Stand-alone	<input type="checkbox"/> Plug-in	<input type="checkbox"/> Combined	
Operating temperature range:	Tmin:	<input type="checkbox"/> -20°C	<input checked="" type="checkbox"/> 0°C	<input type="checkbox"/> X °C
	Tnom:	20°C		
	Tmax:	<input type="checkbox"/> 35°C	<input type="checkbox"/> 55°C	<input checked="" type="checkbox"/> 45 °C
Type of power source:	<input checked="" type="checkbox"/> AC power supply	<input type="checkbox"/> DC power supply	<input type="checkbox"/> Battery Battery Type	
Operating voltage range:	Vnom:	<input checked="" type="checkbox"/> 120V/60Hz	<input type="checkbox"/> X Vdc	
Mode:	<input checked="" type="checkbox"/> Master	<input type="checkbox"/> Slave with radar detection	<input checked="" type="checkbox"/> Slave without radar detection	
	<input checked="" type="checkbox"/> Bridge		<input type="checkbox"/> Mesh	
Fixed outdoor P to P/M application:	<input type="checkbox"/> Yes	<input checked="" type="checkbox"/> No		
System architectures:	<input checked="" type="checkbox"/> IP based		<input type="checkbox"/> Frame based	
Time require for EUT to complete its power cycle on	X s			
User access restriction:	<input checked="" type="checkbox"/> Yes (The manufacturer declares that information regarding the parameters of the detected Radar Waveforms is not available to the end user)		<input type="checkbox"/> No	



L C I E

Antenna Characteristic			
Antenna assembly	Gain (dBi)	Frequency Band (MHz)	Impedance(Ω)
1	1.58	5150-5350	50
2	1.02	5150-5350	50
3	2	5150-5350	50
4	1.7	5150-5350	50
Accumulated	7.6	5150-5350	50
Antenna assembly	Gain (dBi)	Frequency Band (MHz)	Impedance(Ω)
1	2.62	5470-5850	50
2	2.1	5470-5850	50
3	2.96	5470-5850	50
4	2.8	5470-5850	50
Accumulated	8.65	5470-5850	50

Accumulated gain calculation		
Formula used for calculation	KDB	Correlated
$\text{Directional gain} = 10 \log\left[\frac{10^{G_1/20} + 10^{G_2/20} + \dots + 10^{G_N/20}}{2 / N_{\text{ANT}}}\right] \text{ dBi}$	KDB 662911 D01 v02r01	<input checked="" type="checkbox"/> Yes / <input type="checkbox"/> No



L C I E

CHANNEL PLAN		
802.11a / 802.11n HT20/ 802.11ac VHT20		
Channel	Frequency (MHz)	Available Channel
36	5180	<input checked="" type="checkbox"/>
40	5200	<input checked="" type="checkbox"/>
44	5220	<input checked="" type="checkbox"/>
48	5240	<input checked="" type="checkbox"/>
52	5260	<input checked="" type="checkbox"/>
56	5280	<input checked="" type="checkbox"/>
60	5300	<input checked="" type="checkbox"/>
C6=64	5320	<input checked="" type="checkbox"/>
C7=100	5500	<input checked="" type="checkbox"/>
104	5520	<input checked="" type="checkbox"/>
108	5540	<input checked="" type="checkbox"/>
112	5560	<input checked="" type="checkbox"/>
116	5580	<input checked="" type="checkbox"/>
120	5600	<input checked="" type="checkbox"/>
124	5620	<input checked="" type="checkbox"/>
128	5640	<input checked="" type="checkbox"/>
132	5660	<input checked="" type="checkbox"/>
136	5680	<input checked="" type="checkbox"/>
140	5700	<input checked="" type="checkbox"/>
144	5720	<input checked="" type="checkbox"/>
149	5745	<input checked="" type="checkbox"/>
153	5765	<input checked="" type="checkbox"/>
157	5785	<input checked="" type="checkbox"/>
161	5805	<input checked="" type="checkbox"/>
165	5825	<input checked="" type="checkbox"/>



L C I E

CHANNEL PLAN		
802.11n HT40/ 802.11ac VHT40		
Channel	Frequency (MHz)	Available Channel
36+40	5190	<input checked="" type="checkbox"/>
44+48	5230	<input checked="" type="checkbox"/>
52+56	5270	<input checked="" type="checkbox"/>
C17=60+64	5310	<input checked="" type="checkbox"/>
C18=100+104	5510	<input checked="" type="checkbox"/>
108+112	5550	<input checked="" type="checkbox"/>
116+120	5590	<input checked="" type="checkbox"/>
124+128	5630	<input checked="" type="checkbox"/>
132+136	5670	<input checked="" type="checkbox"/>
140+144	5710	<input checked="" type="checkbox"/>
149+153	5755	<input checked="" type="checkbox"/>
157+161	5795	<input checked="" type="checkbox"/>

CHANNEL PLAN		
802.11ac VHT80		
Channel	Frequency (MHz)	Available Channel
36+40+44+48	5210	<input checked="" type="checkbox"/>
C25=52+56+60+64	5290	<input checked="" type="checkbox"/>
C26=100+104+108+112	5530	<input checked="" type="checkbox"/>
116+120+124+128	5610	<input checked="" type="checkbox"/>
132+136+140+144	5690	<input checked="" type="checkbox"/>
149+153+157+161	5775	<input checked="" type="checkbox"/>

No DFS Channel
DFS Channel
Weather DFS Channel



L C I E

DATA RATE		
802.11a		
Data Rate (Mbps)	Modulation Type	Modulation Worst Case
6	BPSK	<input checked="" type="checkbox"/>
9	BPSK	<input type="checkbox"/>
12	QPSK	<input type="checkbox"/>
18	QPSK	<input type="checkbox"/>
24	16-QAM	<input type="checkbox"/>
36	16-QAM	<input type="checkbox"/>
48	64-QAM	<input type="checkbox"/>
54	64-QAM	<input type="checkbox"/>



L C I E

DATA RATE										
802.11n HT20										
Available for EUT	MCS Index	Spatial streams	Modulation				Data Rate (Mbps)		Worst Case Modulation	
							(GI = 800ns)	(GI = 400ns)		
☑	0	1	BPSK				6.5	7.2	☑	
	1	1	QPSK				13	14.4	☐	
	2	1	QPSK				19.5	21.7	☐	
	3	1	16-QAM				26	28.9	☐	
	4	1	16-QAM				39	43.3	☐	
	5	1	64-QAM				52	57.8	☐	
	6	1	64-QAM				58.5	65	☐	
☑	7	1	64-QAM				65	72.2	☐	
	8	2	BPSK				13	14.4	☐	
	9	2	QPSK				26	28.9	☐	
	10	2	QPSK				39	43.3	☐	
	11	2	16-QAM				52	57.8	☐	
	12	2	16-QAM				78	86.7	☐	
	13	2	64-QAM				104	115.6	☐	
☑	14	2	64-QAM				117	130.3	☐	
	15	2	64-QAM				130	144.4	☐	
	16	3	BPSK				19.5	21.7	☐	
	17	3	QPSK				39	43.3	☐	
	18	3	QPSK				58.5	65	☐	
	19	3	16-QAM				78	86.7	☐	
	20	3	16-QAM				117	130	☐	
☑	21	3	64-QAM				156	173.3	☐	
	22	3	64-QAM				175.5	195	☐	
	23	3	64-QAM				195	216.7	☐	
	24	4	BPSK				26	28.9	☑	
	25	4	QPSK				52	57.8	☐	
	26	4	QPSK				78	86.7	☐	
	27	4	16-QAM				104	115.6	☐	
☑	28	4	16-QAM				156	173.3	☐	
	29	4	64-QAM				208	231.1	☐	
	30	4	64-QAM				234	260	☐	
	31	4	64-QAM				260	288.9	☐	
	32	1	BPSK	-	-	-	-	-	☐	
	☐	33	2	16-QAM	QPSK	-	-	39	43.3	☐
		34	2	64-QAM	QPSK	-	-	52	57.8	☐
35		2	64-QAM	16-QAM	-	-	65	72.2	☐	
36		2	16-QAM	QPSK	-	-	58.5	65	☐	
37		2	64-QAM	QPSK	-	-	78	86.7	☐	
38		2	64-QAM	16-QAM	-	-	97.5	108.3	☐	
39		3	16-QAM	QPSK	QPSK	-	52	57.8	☐	
☐	40	3	16-QAM	16-QAM	QPSK	-	65	72.2	☐	
	41	3	64-QAM	QPSK	QPSK	-	65	72.2	☐	
	42	3	64-QAM	16-QAM	QPSK	-	78	86.7	☐	
	43	3	64-QAM	16-QAM	16-QAM	-	91	101.1	☐	
	44	3	64-QAM	64-QAM	QPSK	-	91	101.1	☐	
	45	3	64-QAM	64-QAM	16-QAM	-	104	115.6	☐	
	46	3	16-QAM	QPSK	QPSK	-	78	86.7	☐	
	47	3	16-QAM	16-QAM	QPSK	-	97.5	108.3	☐	
	48	3	64-QAM	QPSK	QPSK	-	97.5	108.3	☐	
	49	3	64-QAM	16-QAM	QPSK	-	117	130	☐	
	50	3	64-QAM	16-QAM	16-QAM	-	136.5	151.7	☐	
	51	3	64-QAM	64-QAM	QPSK	-	136.5	151.7	☐	
52	3	64-QAM	64-QAM	16-QAM	-	156	173.3	☐		
☐	53	4	16-QAM	QPSK	QPSK	QPSK	65	72.2	☐	
	54	4	16-QAM	16-QAM	QPSK	QPSK	78	86.7	☐	
	55	4	16-QAM	16-QAM	16-QAM	QPSK	91	101.1	☐	
	56	4	64-QAM	QPSK	QPSK	QPSK	78	86.7	☐	
	57	4	64-QAM	16-QAM	QPSK	QPSK	91	101.1	☐	
	58	4	64-QAM	16-QAM	16-QAM	QPSK	104	115.6	☐	
	59	4	64-QAM	16-QAM	16-QAM	16-QAM	117	130	☐	
	60	4	64-QAM	QPSK	QPSK	QPSK	104	115.6	☐	
	61	4	64-QAM	16-QAM	16-QAM	QPSK	117	130	☐	
	62	4	64-QAM	16-QAM	16-QAM	16-QAM	130	144.4	☐	
	63	4	64-QAM	64-QAM	64-QAM	QPSK	130	144.4	☐	
	64	4	64-QAM	64-QAM	64-QAM	16-QAM	143	158.9	☐	
	65	4	16-QAM	QPSK	QPSK	QPSK	97.5	108.3	☐	
	66	4	16-QAM	16-QAM	QPSK	QPSK	117	130	☐	
	67	4	16-QAM	16-QAM	16-QAM	QPSK	136.5	151.7	☐	
	68	4	64-QAM	QPSK	QPSK	QPSK	117	130	☐	
	69	4	64-QAM	16-QAM	QPSK	QPSK	136.5	151.7	☐	
	70	4	64-QAM	16-QAM	16-QAM	QPSK	156	173.3	☐	
	71	4	64-QAM	16-QAM	16-QAM	16-QAM	175.5	195	☐	
	72	4	64-QAM	64-QAM	QPSK	QPSK	156	173.3	☐	
	73	4	64-QAM	64-QAM	16-QAM	QPSK	175.5	195	☐	
	74	4	64-QAM	64-QAM	16-QAM	16-QAM	195	216.7	☐	
	75	4	64-QAM	64-QAM	64-QAM	QPSK	195	216.7	☐	
	76	4	64-QAM	64-QAM	64-QAM	16-QAM	214.5	238.3	☐	



L C I E

DATA RATE										
802.11n HT40										
Available for EUT	MCS Index	Spatial streams	Modulation				Data Rate (Mbps)		Worst Case Modulation	
							(GI = 800ns)	(GI = 400ns)		
☑	0	1	BPSK				13	15	☑	
	1	1	QPSK				27	30	☐	
	2	1	QPSK				40.5	45	☐	
	3	1	16-QAM				54	60	☐	
	4	1	16-QAM				81	90	☐	
	5	1	64-QAM				108	120	☐	
	6	1	64-QAM				121.5	135	☐	
☑	7	1	64-QAM				135	150	☐	
	8	2	BPSK				27	30	☐	
	9	2	QPSK				54	60	☐	
	10	2	QPSK				81	90	☐	
	11	2	16-QAM				108	120	☐	
	12	2	16-QAM				162	180	☐	
	13	2	64-QAM				216	240	☐	
☑	14	2	64-QAM				243	270	☐	
	15	2	64-QAM				270	300	☐	
	16	3	BPSK				40.5	45	☐	
	17	3	QPSK				81	90	☐	
	18	3	QPSK				121.5	135	☐	
	19	3	16-QAM				162	180	☐	
	20	3	16-QAM				243	270	☐	
☑	21	3	64-QAM				324	360	☐	
	22	3	64-QAM				364.5	405	☐	
	23	3	64-QAM				405	450	☐	
	24	4	BPSK				54	60	☑	
	25	4	QPSK				108	120	☐	
	26	4	QPSK				162	180	☐	
	27	4	16-QAM				216	240	☐	
☑	28	4	16-QAM				324	360	☐	
	29	4	64-QAM				432	480	☐	
	30	4	64-QAM				486	540	☐	
	31	4	64-QAM				540	600	☐	
	32	1	BPSK	-	-	-	6.0	6.7	☐	
	☐	33	2	16-QAM	QPSK	-	-	81	90.0	☐
		34	2	64-QAM	QPSK	-	-	108	120	☐
35		2	64-QAM	16-QAM	-	-	135	150	☐	
36		2	16-QAM	QPSK	-	-	121.5	135	☐	
37		2	64-QAM	QPSK	-	-	162	180	☐	
38		2	64-QAM	16-QAM	-	-	202.5	225	☐	
39		3	16-QAM	QPSK	QPSK	-	108	120	☐	
☐	40	3	16-QAM	16-QAM	QPSK	-	135	150	☐	
	41	3	64-QAM	QPSK	QPSK	-	135	150	☐	
	42	3	64-QAM	16-QAM	QPSK	-	162	180	☐	
	43	3	64-QAM	16-QAM	16-QAM	-	189	210	☐	
	44	3	64-QAM	64-QAM	QPSK	-	189	210	☐	
	45	3	64-QAM	64-QAM	16-QAM	-	216	240	☐	
	46	3	16-QAM	QPSK	QPSK	-	162	180	☐	
	47	3	16-QAM	16-QAM	QPSK	-	202.5	225	☐	
	48	3	64-QAM	QPSK	QPSK	-	202.5	225	☐	
	49	3	64-QAM	16-QAM	QPSK	-	243	270	☐	
	50	3	64-QAM	16-QAM	16-QAM	-	283.5	315	☐	
	51	3	64-QAM	64-QAM	QPSK	-	283.5	315	☐	
	52	3	64-QAM	64-QAM	16-QAM	-	324	360	☐	
☐	53	4	16-QAM	QPSK	QPSK	QPSK	135	150	☐	
	54	4	16-QAM	16-QAM	QPSK	QPSK	162	180	☐	
	55	4	16-QAM	16-QAM	16-QAM	QPSK	189	210	☐	
	56	4	64-QAM	QPSK	QPSK	QPSK	162	180	☐	
	57	4	64-QAM	16-QAM	QPSK	QPSK	189	210	☐	
	58	4	64-QAM	16-QAM	16-QAM	QPSK	216	240	☐	
	59	4	64-QAM	16-QAM	16-QAM	16-QAM	243	270	☐	
	60	4	64-QAM	QPSK	QPSK	QPSK	216	240	☐	
	61	4	64-QAM	16-QAM	16-QAM	QPSK	243	270	☐	
	62	4	64-QAM	16-QAM	16-QAM	16-QAM	270	300	☐	
	63	4	64-QAM	64-QAM	64-QAM	QPSK	270	300	☐	
	64	4	64-QAM	64-QAM	64-QAM	16-QAM	297	330	☐	
	65	4	16-QAM	QPSK	QPSK	QPSK	202.5	225	☐	
	66	4	16-QAM	16-QAM	QPSK	QPSK	243	270	☐	
	67	4	16-QAM	16-QAM	16-QAM	QPSK	283.5	315	☐	
	68	4	64-QAM	QPSK	QPSK	QPSK	243	270	☐	
	69	4	64-QAM	16-QAM	QPSK	QPSK	283.5	315	☐	
	70	4	64-QAM	16-QAM	16-QAM	QPSK	324	360	☐	
	71	4	64-QAM	16-QAM	16-QAM	16-QAM	364.5	405	☐	
	72	4	64-QAM	64-QAM	QPSK	QPSK	324	360	☐	
	73	4	64-QAM	64-QAM	16-QAM	QPSK	364.5	405	☐	
	74	4	64-QAM	64-QAM	16-QAM	16-QAM	405	450	☐	
	75	4	64-QAM	64-QAM	64-QAM	QPSK	405	450	☐	
	76	4	64-QAM	64-QAM	64-QAM	16-QAM	445.5	495	☐	



L C I E

DATA RATE: 802.11ac VHT20							
Available for EUT	MCS Index	Nbr of spatial streams	Modulation (Stream 1/2/3/4)	Coding rate	GI = 800ns	GI = 400ns	Worst Case Modulation
☑	0	1	BPSK	1/2	6,5	7,2	<input type="checkbox"/>
	1	1	QPSK	1/2	13	14,4	<input type="checkbox"/>
	2	1	QPSK	3/4	19,5	21,7	<input type="checkbox"/>
	3	1	16-QAM	1/2	26	28,9	<input type="checkbox"/>
	4	1	16-QAM	3/4	39	43,3	<input type="checkbox"/>
	5	1	64-QAM	2/3	52	57,8	<input type="checkbox"/>
	6	1	64-QAM	3/4	58,5	65	<input type="checkbox"/>
	7	1	64-QAM	5/6	65	72,2	<input type="checkbox"/>
	8	1	256-QAM	3/4	78	86,7	<input type="checkbox"/>
☑	9	1	256-QAM	5/6	N/A	N/A	<input type="checkbox"/>
	10	2	BPSK	1/2	13	14,4	<input type="checkbox"/>
	11	2	QPSK	1/2	26	28,8	<input type="checkbox"/>
	12	2	QPSK	3/4	39	43,4	<input type="checkbox"/>
	13	2	16-QAM	1/2	52	57,8	<input type="checkbox"/>
	14	2	16-QAM	3/4	78	86,6	<input type="checkbox"/>
	15	2	64-QAM	2/3	104	115,6	<input type="checkbox"/>
	16	2	64-QAM	3/4	117	130	<input type="checkbox"/>
	17	2	64-QAM	5/6	130	144,4	<input type="checkbox"/>
☑	18	2	256-QAM	3/4	156	173,4	<input type="checkbox"/>
	19	2	256-QAM	5/6	N/A	N/A	<input type="checkbox"/>
	20	3	BPSK	1/2	19,5	21,6	<input type="checkbox"/>
	21	3	QPSK	1/2	39	43,2	<input type="checkbox"/>
	22	3	QPSK	3/4	58,5	65,1	<input type="checkbox"/>
	23	3	16-QAM	1/2	78	86,7	<input type="checkbox"/>
	24	3	16-QAM	3/4	117	129,9	<input type="checkbox"/>
	25	3	64-QAM	2/3	156	173,4	<input type="checkbox"/>
	26	3	64-QAM	3/4	175,5	195	<input type="checkbox"/>
☑	27	3	64-QAM	5/6	195	216,6	<input type="checkbox"/>
	28	3	256-QAM	3/4	234	260,1	<input type="checkbox"/>
	29	3	256-QAM	5/6	N/A	N/A	<input type="checkbox"/>
	30	4	BPSK	1/2	26	28,8	<input checked="" type="checkbox"/>
	31	4	QPSK	1/2	52	57,6	<input type="checkbox"/>
	32	4	QPSK	3/4	78	86,8	<input type="checkbox"/>
	33	4	16-QAM	1/2	104	115,6	<input type="checkbox"/>
	34	4	16-QAM	3/4	156	173,2	<input type="checkbox"/>
	35	4	64-QAM	2/3	208	231,2	<input type="checkbox"/>
☐	36	4	64-QAM	3/4	234	260	<input type="checkbox"/>
	37	4	64-QAM	5/6	260	288,8	<input type="checkbox"/>
	38	4	256-QAM	3/4	312	346,8	<input type="checkbox"/>
	39	4	256-QAM	5/6	N/A	N/A	<input type="checkbox"/>
	40	5	BPSK	1/2	32,5	36	<input type="checkbox"/>
	41	5	QPSK	1/2	65	72	<input type="checkbox"/>
	42	5	QPSK	3/4	97,5	108,5	<input type="checkbox"/>
	43	5	16-QAM	1/2	130	144,5	<input type="checkbox"/>
	44	5	16-QAM	3/4	195	216,5	<input type="checkbox"/>
☐	45	5	64-QAM	2/3	260	289	<input type="checkbox"/>
	46	5	64-QAM	3/4	292,5	325	<input type="checkbox"/>
	47	5	64-QAM	5/6	325	361	<input type="checkbox"/>
	48	5	256-QAM	3/4	390	433,5	<input type="checkbox"/>
	49	5	256-QAM	5/6	N/A	N/A	<input type="checkbox"/>
	50	6	BPSK	1/2	39	43,2	<input type="checkbox"/>
	51	6	QPSK	1/2	78	86,4	<input type="checkbox"/>
	52	6	QPSK	3/4	117	130,2	<input type="checkbox"/>
	53	6	16-QAM	1/2	156	173,4	<input type="checkbox"/>
☐	54	6	16-QAM	3/4	234	259,8	<input type="checkbox"/>
	55	6	64-QAM	2/3	312	346,8	<input type="checkbox"/>
	56	6	64-QAM	3/4	351	390	<input type="checkbox"/>
	57	6	64-QAM	5/6	390	433,2	<input type="checkbox"/>
	58	6	256-QAM	3/4	468	520,2	<input type="checkbox"/>
	59	6	256-QAM	5/6	N/A	N/A	<input type="checkbox"/>
	60	7	BPSK	1/2	45,5	50,4	<input type="checkbox"/>
	61	7	QPSK	1/2	91	100,8	<input type="checkbox"/>
	62	7	QPSK	3/4	136,5	151,9	<input type="checkbox"/>
☐	63	7	16-QAM	1/2	182	202,3	<input type="checkbox"/>
	64	7	16-QAM	3/4	273	303,1	<input type="checkbox"/>
	65	7	64-QAM	2/3	364	404,6	<input type="checkbox"/>
	66	7	64-QAM	3/4	409,5	455	<input type="checkbox"/>
	67	7	64-QAM	5/6	455	505,4	<input type="checkbox"/>
	68	7	256-QAM	3/4	546	606,9	<input type="checkbox"/>
	69	7	256-QAM	5/6	N/A	N/A	<input type="checkbox"/>
	70	8	BPSK	1/2	52	57,6	<input type="checkbox"/>
	71	8	QPSK	1/2	104	115,2	<input type="checkbox"/>
☐	72	8	QPSK	3/4	156	173,6	<input type="checkbox"/>
	73	8	16-QAM	1/2	208	231,2	<input type="checkbox"/>
	74	8	16-QAM	3/4	312	346,4	<input type="checkbox"/>
	75	8	64-QAM	2/3	416	462,4	<input type="checkbox"/>
	76	8	64-QAM	3/4	468	520	<input type="checkbox"/>
	77	8	64-QAM	5/6	520	577,6	<input type="checkbox"/>
	78	8	256-QAM	3/4	624	693,6	<input type="checkbox"/>
	79	8	256-QAM	5/6	N/A	N/A	<input type="checkbox"/>



L C I E

DATA RATE: 802.11ac VHT40							
Available for EUT	MCS Index	Nbr of spatial streams	Modulation (Stream 1/2/3/4)	Coding rate	GI = 800ns	GI = 400ns	Worst Case Modulation
☑	0	1	BPSK	1/2	13,5	15	<input type="checkbox"/>
	1	1	QPSK	1/2	27	30	<input type="checkbox"/>
	2	1	QPSK	3/4	40,5	45	<input type="checkbox"/>
	3	1	16-QAM	1/2	54	60	<input type="checkbox"/>
	4	1	16-QAM	3/4	81	90	<input type="checkbox"/>
	5	1	64-QAM	2/3	108	120	<input type="checkbox"/>
	6	1	64-QAM	3/4	121,5	135	<input type="checkbox"/>
	7	1	64-QAM	5/6	135	150	<input type="checkbox"/>
	8	1	256-QAM	3/4	162	180	<input type="checkbox"/>
☑	9	1	256-QAM	5/6	180	200	<input type="checkbox"/>
	10	2	BPSK	1/2	27	30	<input type="checkbox"/>
	11	2	QPSK	1/2	54	60	<input type="checkbox"/>
	12	2	QPSK	3/4	81	90	<input type="checkbox"/>
	13	2	16-QAM	1/2	108	120	<input type="checkbox"/>
	14	2	16-QAM	3/4	162	180	<input type="checkbox"/>
	15	2	64-QAM	2/3	216	240	<input type="checkbox"/>
	16	2	64-QAM	3/4	243	270	<input type="checkbox"/>
	17	2	64-QAM	5/6	270	300	<input type="checkbox"/>
☑	18	2	256-QAM	3/4	324	360	<input type="checkbox"/>
	19	2	256-QAM	5/6	360	400	<input type="checkbox"/>
	20	3	BPSK	1/2	40,5	45	<input type="checkbox"/>
	21	3	QPSK	1/2	81	90	<input type="checkbox"/>
	22	3	QPSK	3/4	121,5	135	<input type="checkbox"/>
	23	3	16-QAM	1/2	162	180	<input type="checkbox"/>
	24	3	16-QAM	3/4	243	270	<input type="checkbox"/>
	25	3	64-QAM	2/3	324	360	<input type="checkbox"/>
	26	3	64-QAM	3/4	364,5	405	<input type="checkbox"/>
☑	27	3	64-QAM	5/6	405	450	<input type="checkbox"/>
	28	3	256-QAM	3/4	486	540	<input type="checkbox"/>
	29	3	256-QAM	5/6	540	600	<input type="checkbox"/>
	30	4	BPSK	1/2	54	60	<input checked="" type="checkbox"/>
	31	4	QPSK	1/2	108	120	<input type="checkbox"/>
	32	4	QPSK	3/4	162	180	<input type="checkbox"/>
	33	4	16-QAM	1/2	216	240	<input type="checkbox"/>
	34	4	16-QAM	3/4	324	360	<input type="checkbox"/>
	35	4	64-QAM	2/3	432	480	<input type="checkbox"/>
☐	36	4	64-QAM	3/4	486	540	<input type="checkbox"/>
	37	4	64-QAM	5/6	540	600	<input type="checkbox"/>
	38	4	256-QAM	3/4	648	720	<input type="checkbox"/>
	39	4	256-QAM	5/6	720	800	<input type="checkbox"/>
	40	5	BPSK	1/2	67,5	75	<input type="checkbox"/>
	41	5	QPSK	1/2	135	150	<input type="checkbox"/>
	42	5	QPSK	3/4	202,5	225	<input type="checkbox"/>
	43	5	16-QAM	1/2	270	300	<input type="checkbox"/>
	44	5	16-QAM	3/4	405	450	<input type="checkbox"/>
☐	45	5	64-QAM	2/3	540	600	<input type="checkbox"/>
	46	5	64-QAM	3/4	607,5	675	<input type="checkbox"/>
	47	5	64-QAM	5/6	675	750	<input type="checkbox"/>
	48	5	256-QAM	3/4	810	900	<input type="checkbox"/>
	49	5	256-QAM	5/6	900	1000	<input type="checkbox"/>
	50	6	BPSK	1/2	81	90	<input type="checkbox"/>
	51	6	QPSK	1/2	162	180	<input type="checkbox"/>
	52	6	QPSK	3/4	243	270	<input type="checkbox"/>
	53	6	16-QAM	1/2	324	360	<input type="checkbox"/>
☐	54	6	16-QAM	3/4	486	540	<input type="checkbox"/>
	55	6	64-QAM	2/3	648	720	<input type="checkbox"/>
	56	6	64-QAM	3/4	729	810	<input type="checkbox"/>
	57	6	64-QAM	5/6	810	900	<input type="checkbox"/>
	58	6	256-QAM	3/4	972	1080	<input type="checkbox"/>
	59	6	256-QAM	5/6	1080	1200	<input type="checkbox"/>
	60	7	BPSK	1/2	94,5	105	<input type="checkbox"/>
	61	7	QPSK	1/2	189	210	<input type="checkbox"/>
	62	7	QPSK	3/4	283,5	315	<input type="checkbox"/>
☐	63	7	16-QAM	1/2	378	420	<input type="checkbox"/>
	64	7	16-QAM	3/4	567	630	<input type="checkbox"/>
	65	7	64-QAM	2/3	756	840	<input type="checkbox"/>
	66	7	64-QAM	3/4	850,5	945	<input type="checkbox"/>
	67	7	64-QAM	5/6	945	1050	<input type="checkbox"/>
	68	7	256-QAM	3/4	1134	1260	<input type="checkbox"/>
	69	7	256-QAM	5/6	1260	1400	<input type="checkbox"/>
	70	8	BPSK	1/2	108	120	<input type="checkbox"/>
	71	8	QPSK	1/2	216	240	<input type="checkbox"/>
☐	72	8	QPSK	3/4	324	360	<input type="checkbox"/>
	73	8	16-QAM	1/2	432	480	<input type="checkbox"/>
	74	8	16-QAM	3/4	648	720	<input type="checkbox"/>
	75	8	64-QAM	2/3	864	960	<input type="checkbox"/>
	76	8	64-QAM	3/4	972	1080	<input type="checkbox"/>
	77	8	64-QAM	5/6	1080	1200	<input type="checkbox"/>
	78	8	256-QAM	3/4	1296	1440	<input type="checkbox"/>
	79	8	256-QAM	5/6	1440	1600	<input type="checkbox"/>



L C I E

DATA RATE: 802.11ac VHT80							
Available for EUT	MCS Index	Nbr of spatial streams	Modulation (Stream 1/2/3/4)	Coding rate	GI = 800ns	GI = 400ns	Worst Case Modulation
☑	0	1	BPSK	1/2	29.3	32.5	<input checked="" type="checkbox"/>
	1	1	QPSK	1/2	58.5	65	<input type="checkbox"/>
	2	1	QPSK	3/4	87.8	97.5	<input type="checkbox"/>
	3	1	16-QAM	1/2	117	130	<input type="checkbox"/>
	4	1	16-QAM	3/4	175.5	195	<input type="checkbox"/>
	5	1	64-QAM	2/3	234	260	<input type="checkbox"/>
	6	1	64-QAM	3/4	263.3	292.5	<input type="checkbox"/>
	7	1	64-QAM	5/6	292.5	325	<input type="checkbox"/>
	8	1	256-QAM	3/4	351	390	<input type="checkbox"/>
☑	9	1	256-QAM	5/6	390	433.3	<input type="checkbox"/>
	10	2	BPSK	1/2	58.6	65	<input type="checkbox"/>
	11	2	QPSK	1/2	117	130	<input type="checkbox"/>
	12	2	QPSK	3/4	175.6	195	<input type="checkbox"/>
	13	2	16-QAM	1/2	234	260	<input type="checkbox"/>
	14	2	16-QAM	3/4	351	390	<input type="checkbox"/>
	15	2	64-QAM	2/3	468	520	<input type="checkbox"/>
	16	2	64-QAM	3/4	526.6	585	<input type="checkbox"/>
	17	2	64-QAM	5/6	585	650	<input type="checkbox"/>
☑	18	2	256-QAM	3/4	702	780	<input type="checkbox"/>
	19	2	256-QAM	5/6	780	866.6	<input type="checkbox"/>
	20	3	BPSK	1/2	87.9	97.5	<input type="checkbox"/>
	21	3	QPSK	1/2	175.5	195	<input type="checkbox"/>
	22	3	QPSK	3/4	263.4	292.5	<input type="checkbox"/>
	23	3	16-QAM	1/2	351	390	<input type="checkbox"/>
	24	3	16-QAM	3/4	526.5	585	<input type="checkbox"/>
	25	3	64-QAM	2/3	702	780	<input type="checkbox"/>
	26	3	64-QAM	3/4	789.9	877.5	<input type="checkbox"/>
☑	27	3	64-QAM	5/6	877.5	975	<input type="checkbox"/>
	28	3	256-QAM	3/4	1053	1170	<input type="checkbox"/>
	29	3	256-QAM	5/6	1170	1299.9	<input type="checkbox"/>
	30	4	BPSK	1/2	117.2	130	<input checked="" type="checkbox"/>
	31	4	QPSK	1/2	234	260	<input type="checkbox"/>
	32	4	QPSK	3/4	351.2	390	<input type="checkbox"/>
	33	4	16-QAM	1/2	468	520	<input type="checkbox"/>
	34	4	16-QAM	3/4	702	780	<input type="checkbox"/>
	35	4	64-QAM	2/3	936	1040	<input type="checkbox"/>
☐	36	4	64-QAM	3/4	1053.2	1170	<input type="checkbox"/>
	37	4	64-QAM	5/6	1170	1300	<input type="checkbox"/>
	38	4	256-QAM	3/4	1404	1560	<input type="checkbox"/>
	39	4	256-QAM	5/6	1560	1733.2	<input type="checkbox"/>
	40	5	BPSK	1/2	146.5	162.5	<input type="checkbox"/>
	41	5	QPSK	1/2	292.5	325	<input type="checkbox"/>
	42	5	QPSK	3/4	439	487.5	<input type="checkbox"/>
	43	5	16-QAM	1/2	585	650	<input type="checkbox"/>
	44	5	16-QAM	3/4	877.5	975	<input type="checkbox"/>
☐	45	5	64-QAM	2/3	1170	1300	<input type="checkbox"/>
	46	5	64-QAM	3/4	1316.5	1462.5	<input type="checkbox"/>
	47	5	64-QAM	5/6	1462.5	1625	<input type="checkbox"/>
	48	5	256-QAM	3/4	1755	1950	<input type="checkbox"/>
	49	5	256-QAM	5/6	1950	2166.5	<input type="checkbox"/>
	50	6	BPSK	1/2	175.8	195	<input type="checkbox"/>
	51	6	QPSK	1/2	351	390	<input type="checkbox"/>
	52	6	QPSK	3/4	526.8	585	<input type="checkbox"/>
	53	6	16-QAM	1/2	702	780	<input type="checkbox"/>
☐	54	6	16-QAM	3/4	1053	1170	<input type="checkbox"/>
	55	6	64-QAM	2/3	1404	1560	<input type="checkbox"/>
	56	6	64-QAM	3/4	1579.8	1755	<input type="checkbox"/>
	57	6	64-QAM	5/6	1755	1950	<input type="checkbox"/>
	58	6	256-QAM	3/4	2106	2340	<input type="checkbox"/>
	59	6	256-QAM	5/6	2340	2599.8	<input type="checkbox"/>
	60	7	BPSK	1/2	205.1	227.5	<input type="checkbox"/>
	61	7	QPSK	1/2	409.5	455	<input type="checkbox"/>
	62	7	QPSK	3/4	614.6	682.5	<input type="checkbox"/>
☐	63	7	16-QAM	1/2	819	910	<input type="checkbox"/>
	64	7	16-QAM	3/4	1228.5	1365	<input type="checkbox"/>
	65	7	64-QAM	2/3	1638	1820	<input type="checkbox"/>
	66	7	64-QAM	3/4	1843.1	2047.5	<input type="checkbox"/>
	67	7	64-QAM	5/6	2047.5	2275	<input type="checkbox"/>
	68	7	256-QAM	3/4	2457	2730	<input type="checkbox"/>
	69	7	256-QAM	5/6	2730	3033.1	<input type="checkbox"/>
	70	8	BPSK	1/2	234.4	260	<input type="checkbox"/>
	71	8	QPSK	1/2	468	520	<input type="checkbox"/>
☐	72	8	QPSK	3/4	702.4	780	<input type="checkbox"/>
	73	8	16-QAM	1/2	936	1040	<input type="checkbox"/>
	74	8	16-QAM	3/4	1404	1560	<input type="checkbox"/>
	75	8	64-QAM	2/3	1872	2080	<input type="checkbox"/>
	76	8	64-QAM	3/4	2106.4	2340	<input type="checkbox"/>
	77	8	64-QAM	5/6	2340	2600	<input type="checkbox"/>
	78	8	256-QAM	3/4	2808	3120	<input type="checkbox"/>
	79	8	256-QAM	5/6	3120	3466.4	<input type="checkbox"/>



Test report reference: N°155636-721608D

802.11a		
Channel	C6	C7
EIRP TPC Max (dBm)	27,5	27,6
EIRP TPC Min (dBm)	21,6	21,5
Occupied Bandwidth (MHz)	16,92	16,9

802.11n HT20/ac VHT20		
Channel	C6	C7
EIRP TPC Max (dBm)	27,6	27,8
EIRP TPC Min (dBm)	21,9	21,8
Occupied Bandwidth (MHz)	17,93	17,81

802.11n HT40/ac VHT40		
Channel	C17	C18
EIRP TPC Max (dBm)	28,4	28,1
EIRP TPC Min (dBm)	22,9	22,6
Occupied Bandwidth (MHz)	36,55	36,57

802.11ac VHT80		
Channel	C25	C26
EIRP TPC Max (dBm)	27,7	27,4
EIRP TPC Min (dBm)	22,4	22,2
Occupied Bandwidth (MHz)	79,93	75,94

2.2. RUNNING MODE

The EUT is set in the following modes during tests:

- Emission-reception with a duty cycle above 17% in the data rate that produced the highest output power

Following commands with the specific test document “CR-20180405 - WIFI compliance test command of M384R-US-4L FCC 5GHz.docx” is used to set the product:

-System testings is performed with iperf test software in udp mode from the Master Device to the Client Device on the test channel. The data traffic is performed Laptop 2 to Laptop 1

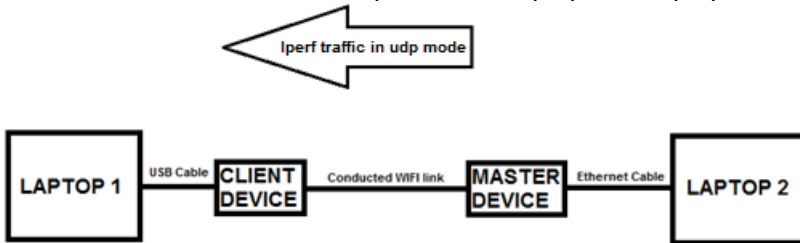



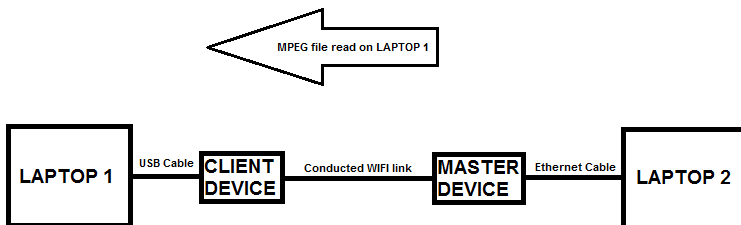

- System testing is performed with the designed MPEG test file (<http://ntiacsd.ntia.doc.gov/dfs/>) that streams full motion video at 30 frames per second for channel loading from the Master Device to the Client Device on the test channel. This MPEG file is played via 2 laptops as follow:



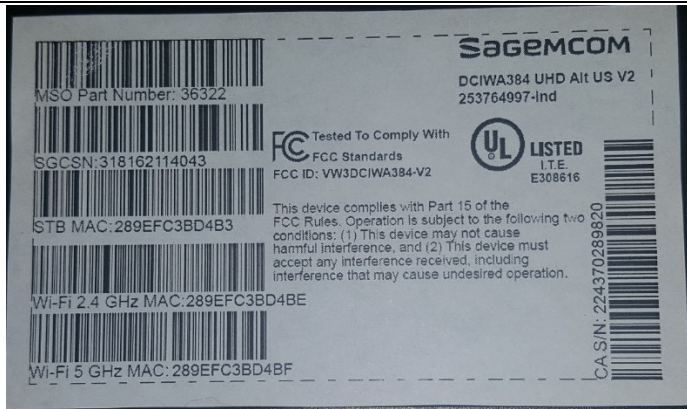
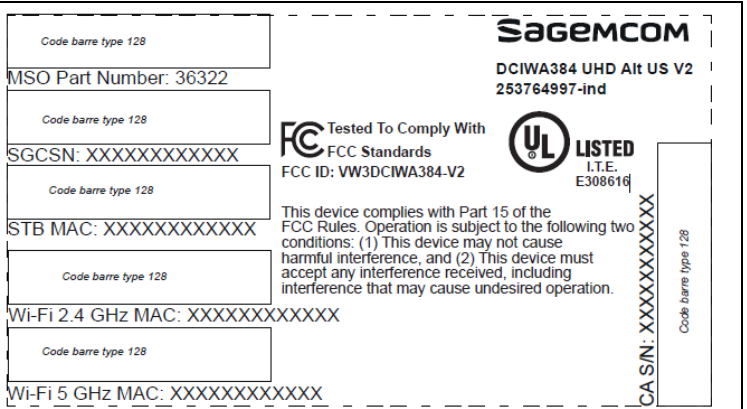

L C I E

2.3. EQUIPMENT LABELLING

 <p>SagemCOM DCIWA384 UHD Ait US V2 253764997-Ind</p> <p>MSO Part Number: 36322</p> <p>SGCSN: 318162114043</p> <p>STB MAC: 289EFC3BD4B3</p> <p>Wi-Fi 2.4 GHz MAC: 289EFC3BD4BE</p> <p>Wi-Fi 5 GHz MAC: 289EFC3BD4BF</p> <p>FCC Tested To Comply With FCC Standards FCC ID: VW3DCIWA384-V2</p> <p>UL LISTED I.T.E. E308616</p> <p>This device complies with Part 15 of the FCC Rules. Operation is subject to the following two conditions: (1) This device may not cause harmful interference, and (2) This device must accept any interference received, including interference that may cause undesired operation.</p> <p>CASIN: 224370289620</p>	 <p>SagemCOM DCIWA384 UHD Ait US V2 253764997-Ind</p> <p>MSO Part Number: 36322</p> <p>SGCSN: XXXXXXXXXXXXX</p> <p>STB MAC: XXXXXXXXXXXXX</p> <p>Wi-Fi 2.4 GHz MAC: XXXXXXXXXXXXX</p> <p>Wi-Fi 5 GHz MAC: XXXXXXXXXXXXX</p> <p>FCC Tested To Comply With FCC Standards FCC ID: VW3DCIWA384-V2</p> <p>UL LISTED I.T.E. E308616</p> <p>This device complies with Part 15 of the FCC Rules. Operation is subject to the following two conditions: (1) This device may not cause harmful interference, and (2) This device must accept any interference received, including interference that may cause undesired operation.</p> <p>CASIN: XXXXXXXXXXXXX</p>	
 <p>SagemCOM Switching Power Adapter CS 50001 92848 RUEIL CEDEX-FRANCE P/N:191360131-XX MODEL:MSA-Z3800IC12.0-48W-P INPUT:100-120V~ 50/60Hz 1.2A max. OUTPUT:12.0V = 3.8A EFFICIENCY LEVEL: VI</p> <p>LPS</p> <p>FCC LISTED 2214987 31024</p> <p>H18403E131000014 MOSO POWER SUPPLY TECHNOLOGY CO., LTD.</p>	 <p>SagemCOM SWITCH MODE POWER SUPPLY P/N:191359307-XX Model:LLPL-C046120380ZS Input:120V~50/60Hz 1.3A Max Output:12V = 3.8A</p> <p>CAUTION: FOR INDOOR USE ONLY FOR USE WITH AUDIO AND VIDEO EQUIPMENT FOR USE WITH INFORMATION TECHNOLOGY EQUIPMENT</p> <p>UL LISTED I.T.E. E344329 AV power supply</p> <p>MADE IN CHINA BY DOXOCOM</p>	 <p>SagemCOM SWITCH MODE POWER SUPPLY P/N:191357366-XX MODEL:NBS42C120380M2 INPUT:120V~50/60Hz 1.0A OUTPUT:12V = 3.8A</p> <p>CAUTION: FOR INDOOR USE ONLY FOR USE WITH INFORMATION TECHNOLOGY EQUIPMENT FOR USE WITH AUDIO AND VIDEO EQUIPMENT</p> <p>UL LISTED I.T.E. E344329 AV power supply</p> <p>MADE IN CHINA BY NetBit</p>

2.4. EQUIPMENT MODIFICATION

None Modification:

3. DFS DETECTION THRESHOLDS DETERMINATION, REFERENCE NOISE LEVEL & CHANNEL LOADING

3.1. TEST CONDITIONS

Test performed by : Mathieu CERISIER
 Date of test : September 3, 2018 to September 5, 2018
 Ambient temperature : 23 °C
 Relative humidity : 42 %

3.2. TEST SETUP

- The Equipment Under Test is:

- On a table
- In an anechoic chamber

- Measurement is performed with a spectrum analyzer:

- On the EUT conducted access
- On the EUT with a test fixture

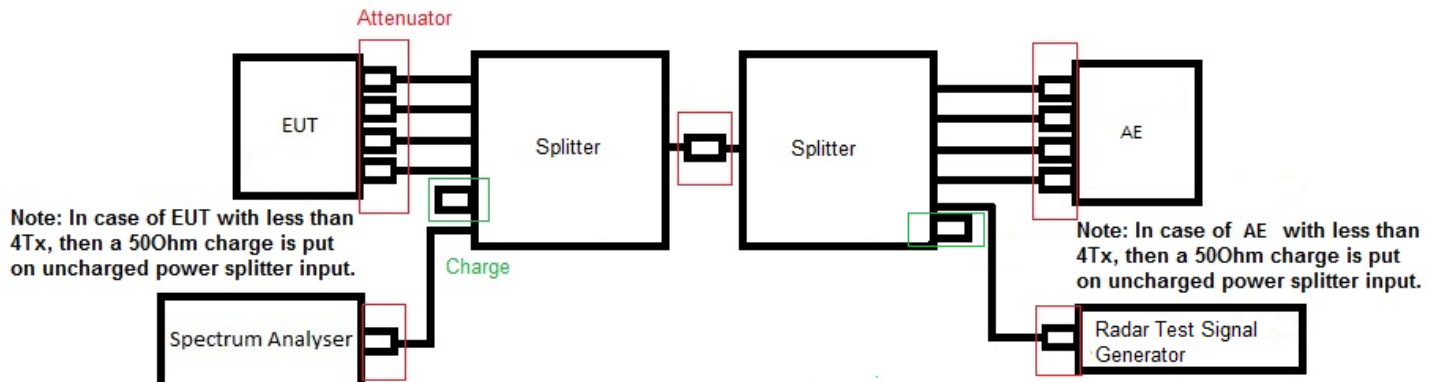



L C I E



Photograph for DFS Detection Thresholds Determination, Reference Noise Level, Channel Loading

3.3. TEST EQUIPMENT LIST

Description	Constructor	Model	N°	Cal. Date	Cal. Due
Multimeter	Keithley	2000	A1242090	2017/05	2019/05
EMI receiver	ROHDE & SCHWARZ	ESR 7	A2642026	2017/02	2019/02
Cable	STORMFLEX	920-0202-024	A5329662	2018/05	2019/05
Cable	STORMFLEX	920-0202-025	A5329663	2018/05	2019/05
Cable	STORMFLEX	920-0202-026	A5329664	2018/05	2019/05
Cable	STORMFLEX	920-0202-027	A5329665	2018/05	2019/05
Cable	STORMFLEX	920-0202-028	A5329666	2018/05	2019/05
Cable	STORMFLEX	920-0202-029	A5329667	2018/05	2019/05
Cable	STORMFLEX	920-0202-030	A5329668	2018/05	2019/05
Cable	STORMFLEX	920-0202-031	A5329670	2018/05	2019/05
Cable	STORMFLEX	920-0202-033	A5329672	2018/05	2019/05
Cable	STORMFLEX	920-0202-034	A5329673	2018/05	2019/05
Power supply	KIKUSUI	PCR500M	A7040079	Verified with calibrated multimeter	
Signal generator	ROHDE & SCHWARZ	SMJ100A	A5444007	Verified with calibrated EMI receiver	
Attenuator 10dB	MINI CIRCUITS	BW-S10W2+	A7122229	2018/05	2019/05
Attenuator 10dB	MINI CIRCUITS	BW-S10W2+	A7122230	2018/05	2019/05
RF cable & Attenuator 20dB	Télédyne & MINI CIRCUITS	920-0202-024 & FW-20+	A5329661	2018/05	2019/05
RF cable & Attenuator 20dB	Télédyne & MINI CIRCUITS	920-0202-024 & FW-20+	A5329676	2018/05	2019/05
RF cable & Attenuator 20dB	Télédyne & MINI CIRCUITS	920-0202-024 & FW-20+	A5329674	2018/05	2019/05
RF cable & Attenuator 20dB	Télédyne & MINI CIRCUITS	920-0202-024 & FW-20+	A5329675	2018/05	2019/05
Attenuator 3dB	MINI CIRCUITS	BW-S3W2+	A7122238	2018/05	2019/05
Attenuator 3dB	MINI CIRCUITS	BW-S3W2+	A7122239	2018/05	2019/05
Attenuator 3dB	MINI CIRCUITS	BW-S3W2+	A7122240	2018/05	2019/05
Attenuator 3dB	MINI CIRCUITS	BW-S3W2+	A7122241	2018/05	2019/05
Attenuator 3dB	MINI CIRCUITS	BW-S3W2+	A7122242	2018/05	2019/05
Attenuator 3dB	MINI CIRCUITS	BW-S3W2+	A7122243	2018/05	2019/05
Power splitter	Mini-Circuits	ZN6PD-63W-S+	A7132040	2018/05	2019/05
Power splitter	Mini-Circuits	ZN6PD-63W-S+	A7132041	2018/05	2019/05
Load 50 ohms	Fairview Microwave	ST0635F	A7152075	2018/05	2019/05
Load 50 ohms	Fairview Microwave	ST0635F	A7152076	2018/05	2019/05
Load 50 ohms	Fairview Microwave	ST0635F	A7152077	2018/05	2019/05
Load 50 ohms	Fairview Microwave	ST0635F	A7152078	2018/05	2019/05

Note: In our quality system, the test equipment calibration due is more & less 2 months



L C I E

3.4. RESULTS

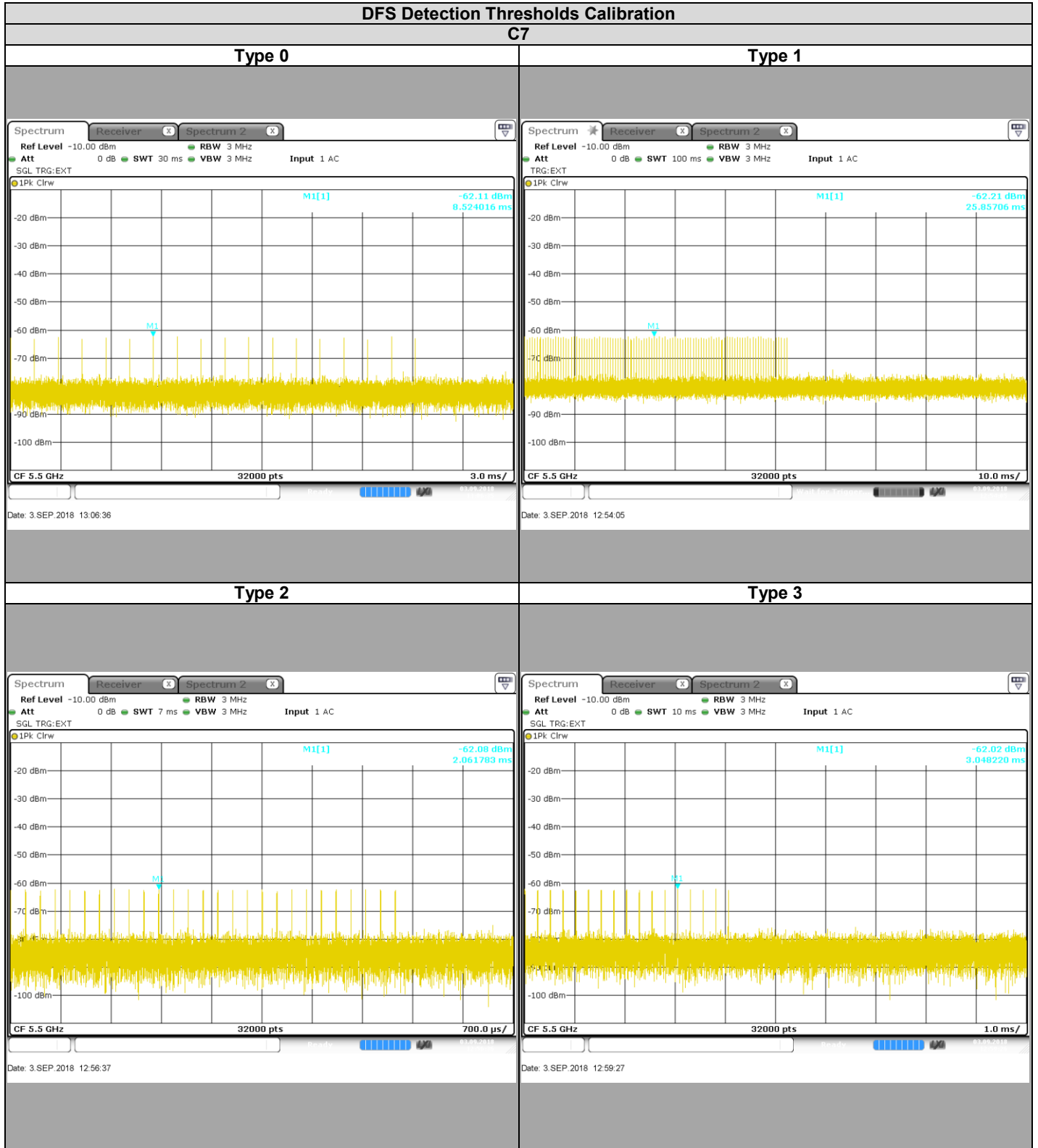



L C I E

DFS Detection Thresholds Calibration

C7

Type 4

Type 5

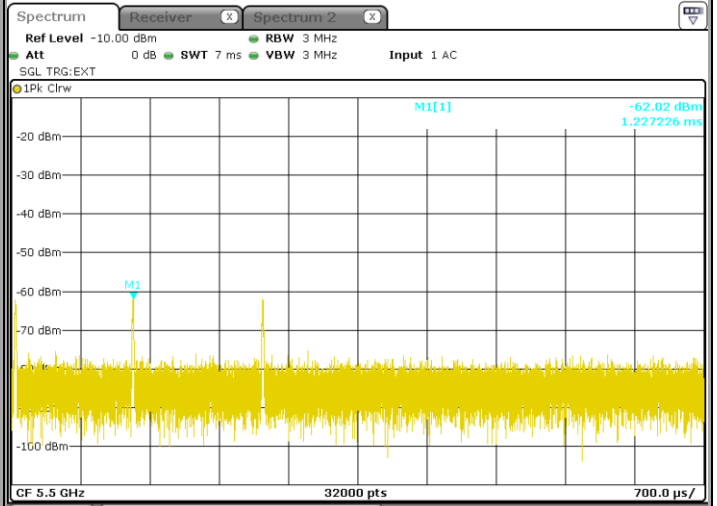
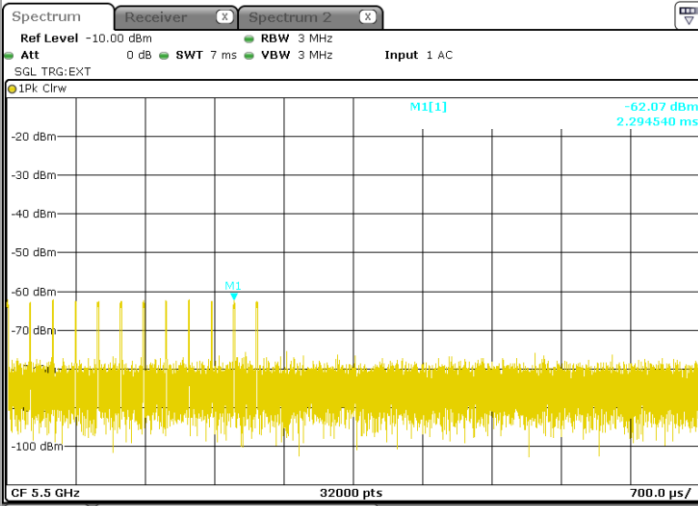

Date: 3.SEP.2018 13:00:32

Date: 3.SEP.2018 13:03:08

Type 6 (C26)

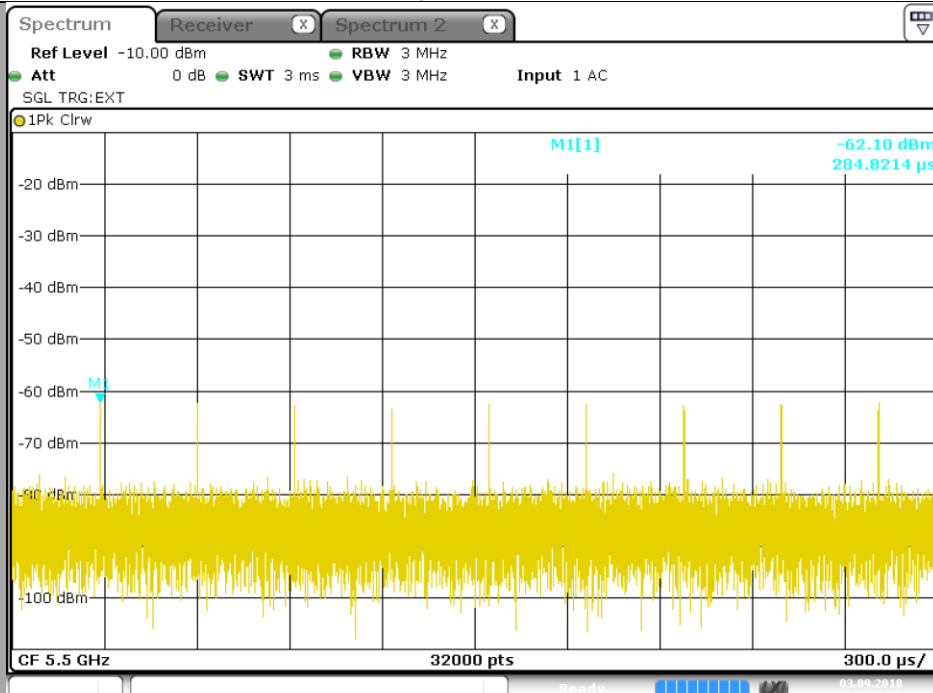

Date: 3.SEP.2018 13:10:29



L C I E

Channel	Channel
Applicable Level (dBm)	-64
Lowest Antenna Gain (dBi)	1,02
DFS Detection Thresholds (dBm)	-62,98
Additional Level (dB)	1
Radar Level (dBm)	-61,98

Channel	Channel
EIRP (See test report from FCC ID: RRK2012060056-1)	338,065mW
DFS Detection thresholds applied	-64dBm
Additional Level (dB)	1
DFS Detection thresholds applied	-63dBm



L C I E

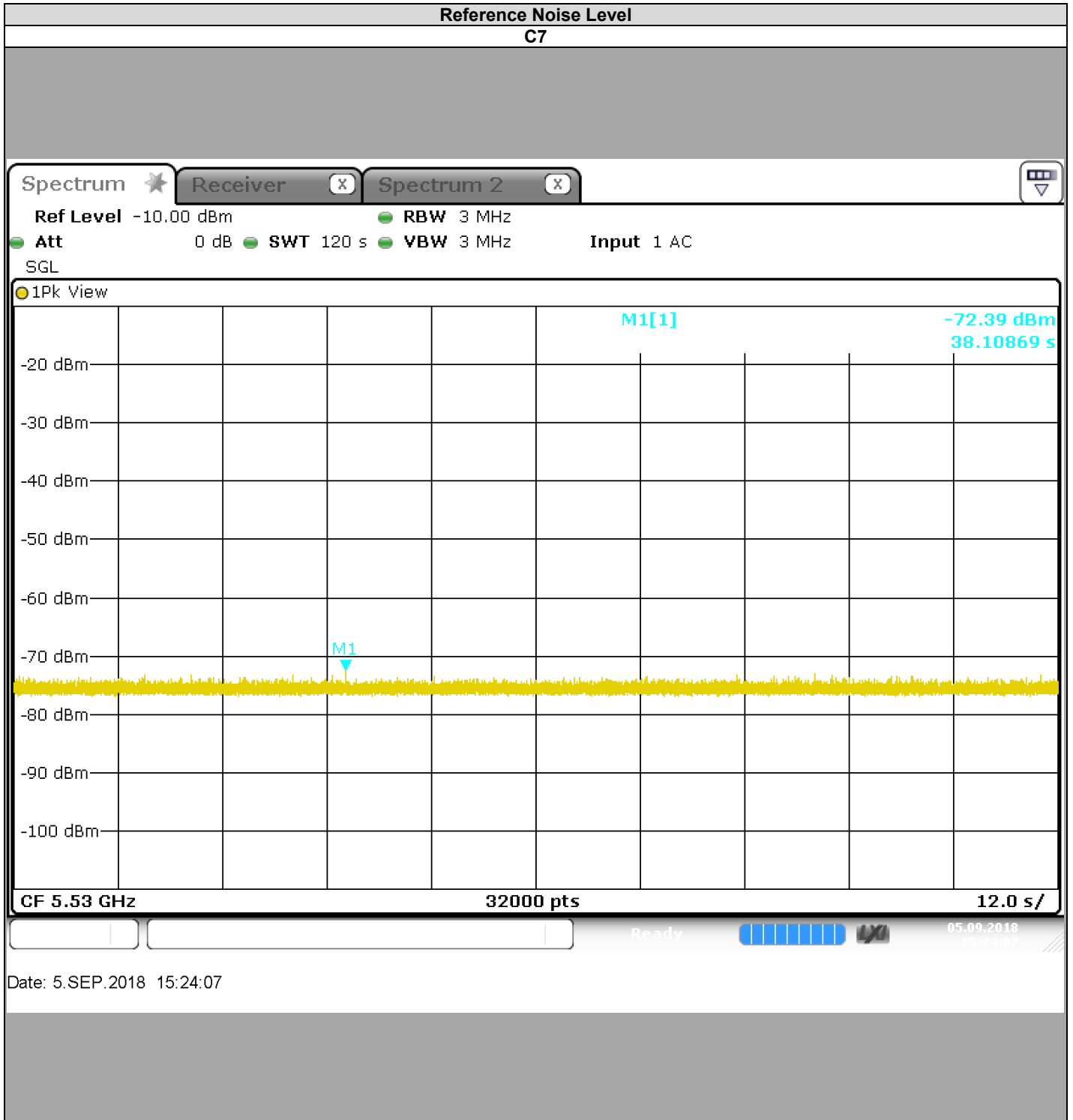



L C I E

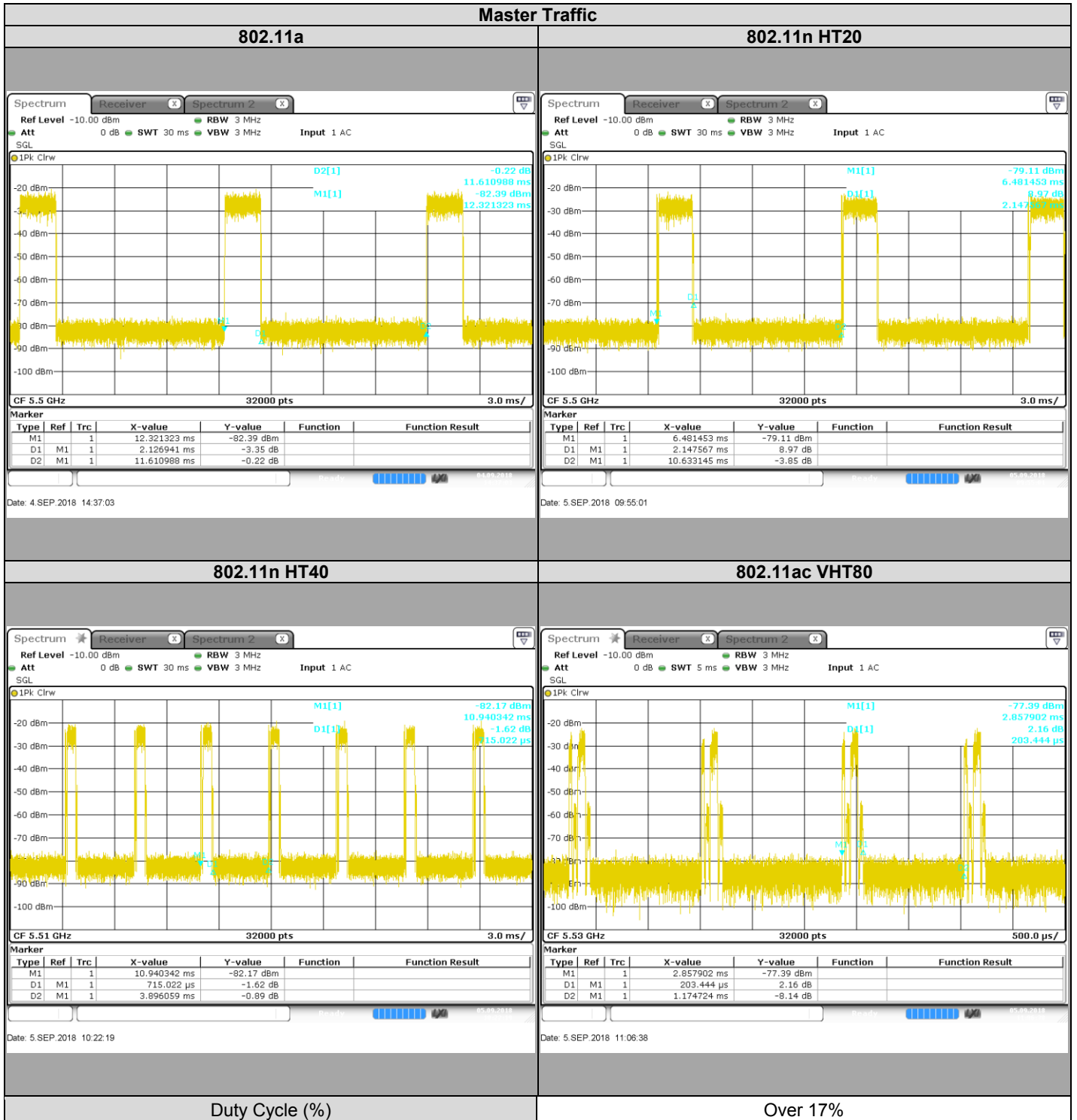



L C I E

DFS Detection Thresholds Calibration

Client

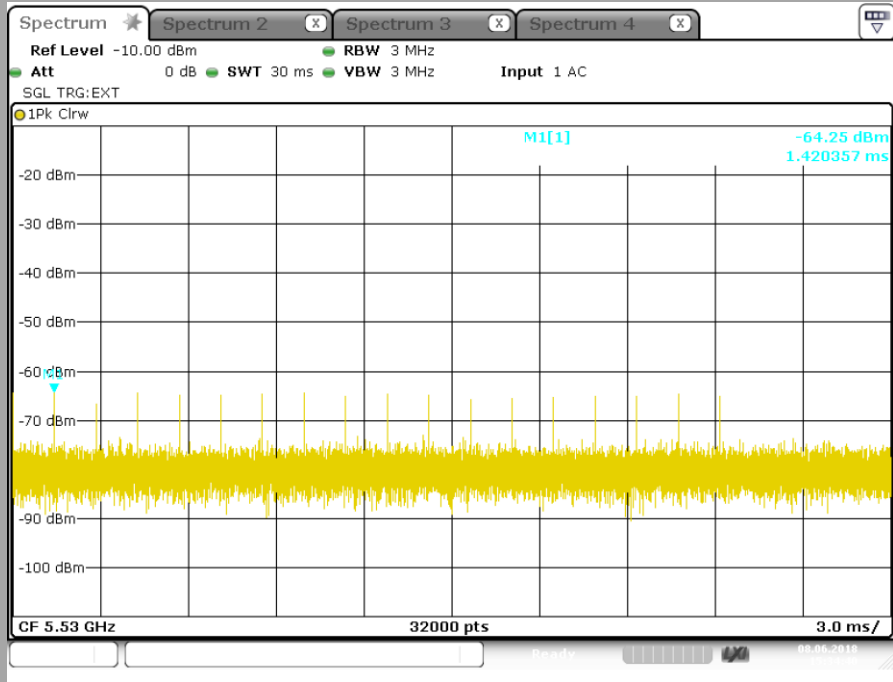

4. DYNAMIC FREQUENCY SELECTION (DFS): CHANNEL AVAILABILITY CHECK & DFS DETECTION THRESHOLD

4.1. TEST CONDITIONS

Test performed by : Mathieu CERISIER
 Date of test : September 4, 2018
 Ambient temperature : 24 °C
 Relative humidity : 44 %

4.2. TEST SETUP

- The Equipment Under Test is:

- On a table
- In an anechoic chamber

- Measurement is performed with a spectrum analyzer:

- On the EUT conducted access
- On the EUT with a test fixture

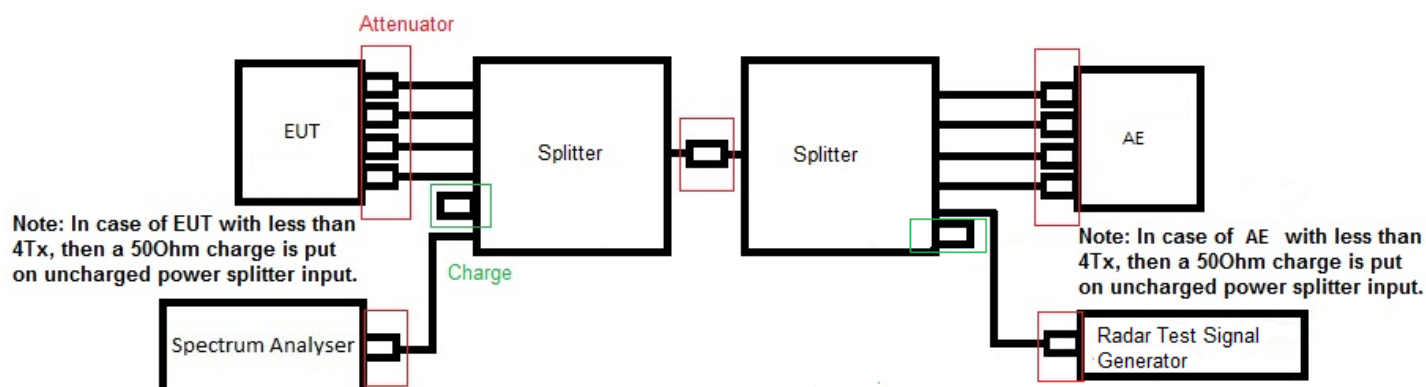



L C I E



Photograph for Channel Availability Check Time & DFS Detection Threshold

4.3. LIMIT

Channel Availability Check Time shall exceed 60 seconds
Radard burst must be detected at the start & the end of Channel Availability Check Time

4.4. TEST EQUIPMENT LIST

Description	Constructor	Model	N°	Cal. Date	Cal. Due
Multimeter	Keithley	2000	A1242090	2017/05	2019/05
EMI receiver	ROHDE & SCHWARZ	ESR 7	A2642026	2017/02	2019/02
Cable	STORMFLEX	920-0202-024	A5329662	2018/05	2019/05
Cable	STORMFLEX	920-0202-025	A5329663	2018/05	2019/05
Cable	STORMFLEX	920-0202-026	A5329664	2018/05	2019/05
Cable	STORMFLEX	920-0202-027	A5329665	2018/05	2019/05
Cable	STORMFLEX	920-0202-028	A5329666	2018/05	2019/05
Cable	STORMFLEX	920-0202-029	A5329667	2018/05	2019/05
Cable	STORMFLEX	920-0202-030	A5329668	2018/05	2019/05
Cable	STORMFLEX	920-0202-031	A5329670	2018/05	2019/05
Cable	STORMFLEX	920-0202-033	A5329672	2018/05	2019/05
Cable	STORMFLEX	920-0202-034	A5329673	2018/05	2019/05
Power supply	KIKUSUI	PCR500M	A7040079	Verified with calibrated multimeter	
Signal generator	ROHDE & SCHWARZ	SMJ100A	A5444007	Verified with calibrated EMI receiver	
Attenuator 10dB	MINI CIRCUITS	BW-S10W2+	A7122229	2018/05	2019/05
Attenuator 10dB	MINI CIRCUITS	BW-S10W2+	A7122230	2018/05	2019/05
RF cable & Attenuator 20dB	Télédyne & MINI CIRCUITS	920-0202-024 & FW-20+	A5329661	2018/05	2019/05
RF cable & Attenuator 20dB	Télédyne & MINI CIRCUITS	920-0202-024 & FW-20+	A5329676	2018/05	2019/05
RF cable & Attenuator 20dB	Télédyne & MINI CIRCUITS	920-0202-024 & FW-20+	A5329674	2018/05	2019/05
RF cable & Attenuator 20dB	Télédyne & MINI CIRCUITS	920-0202-024 & FW-20+	A5329675	2018/05	2019/05
Attenuator 3dB	MINI CIRCUITS	BW-S3W2+	A7122238	2018/05	2019/05
Attenuator 3dB	MINI CIRCUITS	BW-S3W2+	A7122239	2018/05	2019/05
Attenuator 3dB	MINI CIRCUITS	BW-S3W2+	A7122240	2018/05	2019/05
Attenuator 3dB	MINI CIRCUITS	BW-S3W2+	A7122241	2018/05	2019/05
Attenuator 3dB	MINI CIRCUITS	BW-S3W2+	A7122242	2018/05	2019/05
Attenuator 3dB	MINI CIRCUITS	BW-S3W2+	A7122243	2018/05	2019/05
Power splitter	Mini-Circuits	ZN6PD-63W-S+	A7132040	2018/05	2019/05
Power splitter	Mini-Circuits	ZN6PD-63W-S+	A7132041	2018/05	2019/05
Load 50 ohms	Fairview Microwave	ST0635F	A7152075	2018/05	2019/05
Load 50 ohms	Fairview Microwave	ST0635F	A7152076	2018/05	2019/05
Load 50 ohms	Fairview Microwave	ST0635F	A7152077	2018/05	2019/05
Load 50 ohms	Fairview Microwave	ST0635F	A7152078	2018/05	2019/05

Note: In our quality system, the test equipment calibration due is more & less 2 months



4.5. DIVERGENCE, ADDITION OR SUPPRESSION ON THE TEST SPECIFICATION

None Divergence:



L C I E

4.6. RESULTS

Channel Availability Check		
802.11ac VHT80		
C26		
<p>Channel Availability Check Time</p> <p>Date: 4 SEP 2018 14:19:29</p>	<p>Radar Type 0 at the beginning of the Channel Availability Check Time</p> <p>Date: 4 SEP 2018 14:23:44</p>	
<p>Radar Type 0 at the end of the Channel Availability Check Time</p> <p>Date: 4 SEP 2018 14:27:36</p>		
Channel Availability Check Time (s)	60,28	
Radar burst Type 0 at the beginning of Channel Availability Check time detected & no transmission from the EUT on the tested channel	<input checked="" type="checkbox"/> Yes	<input type="checkbox"/> No
Radar burst Type 0 at the end of Channel Availability Check time detected & no transmission from the EUT on the tested channel	<input checked="" type="checkbox"/> Yes	<input type="checkbox"/> No



4.7. CONCLUSION

Channel Availability Check Time & DFS Detection Threshold measurement performed on the sample of the product **SAGEMCOM DCIWA384 UHD AIt US V2**, SN: **253764997**, in configuration and description presented in this test report, show levels **compliant** to the **47 CFR PART 15.407** limits.

5. DYNAMIC FREQUENCY SELECTION (DFS): U-NII DETECTION BANDWIDTH

5.1. TEST CONDITIONS

Test performed by : Mathieu CERISIER
 Date of test : September 4, 2018 to September 5, 2018
 Ambient temperature : 24 °C
 Relative humidity : 44 %

5.2. TEST SETUP

- The Equipment Under Test is:

- On a table
- In an anechoic chamber

- Measurement is performed with a spectrum analyzer:

- On the EUT conducted access
- On the EUT with a test fixture

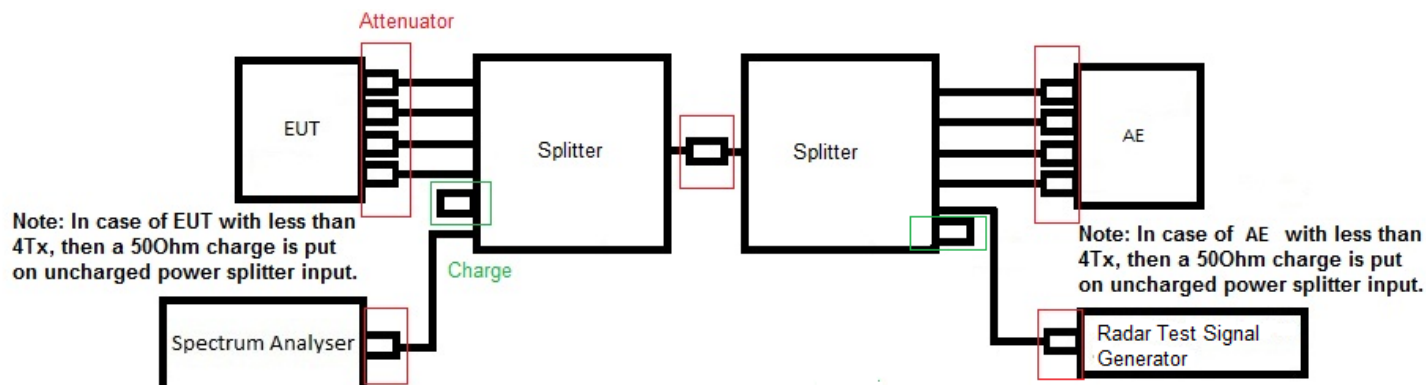



L C I E



Photograph for U-NII Detection Bandwidth

5.3. LIMIT

Minimum 100% of the U-NII 99% transmission power bandwidth

5.4. TEST EQUIPMENT LIST

Description	Constructor	Model	N°	Cal. Date	Cal. Due
Multimeter	Keithley	2000	A1242090	2017/05	2019/05
EMI receiver	ROHDE & SCHWARZ	ESR 7	A2642026	2017/02	2019/02
Cable	STORMFLEX	920-0202-024	A5329662	2018/05	2019/05
Cable	STORMFLEX	920-0202-025	A5329663	2018/05	2019/05
Cable	STORMFLEX	920-0202-026	A5329664	2018/05	2019/05
Cable	STORMFLEX	920-0202-027	A5329665	2018/05	2019/05
Cable	STORMFLEX	920-0202-028	A5329666	2018/05	2019/05
Cable	STORMFLEX	920-0202-029	A5329667	2018/05	2019/05
Cable	STORMFLEX	920-0202-030	A5329668	2018/05	2019/05
Cable	STORMFLEX	920-0202-031	A5329670	2018/05	2019/05
Cable	STORMFLEX	920-0202-033	A5329672	2018/05	2019/05
Cable	STORMFLEX	920-0202-034	A5329673	2018/05	2019/05
Power supply	KIKUSUI	PCR500M	A7040079	Verified with calibrated multimeter	
Signal generator	ROHDE & SCHWARZ	SMJ100A	A5444007	Verified with calibrated EMI receiver	
Attenuator 10dB	MINI CIRCUITS	BW-S10W2+	A7122229	2018/05	2019/05
Attenuator 10dB	MINI CIRCUITS	BW-S10W2+	A7122230	2018/05	2019/05
RF cable & Attenuator 20dB	Télédyne & MINI CIRCUITS	920-0202-024 & FW-20+	A5329661	2018/05	2019/05
RF cable & Attenuator 20dB	Télédyne & MINI CIRCUITS	920-0202-024 & FW-20+	A5329676	2018/05	2019/05
RF cable & Attenuator 20dB	Télédyne & MINI CIRCUITS	920-0202-024 & FW-20+	A5329674	2018/05	2019/05
RF cable & Attenuator 20dB	Télédyne & MINI CIRCUITS	920-0202-024 & FW-20+	A5329675	2018/05	2019/05
Attenuator 3dB	MINI CIRCUITS	BW-S3W2+	A7122238	2018/05	2019/05
Attenuator 3dB	MINI CIRCUITS	BW-S3W2+	A7122239	2018/05	2019/05
Attenuator 3dB	MINI CIRCUITS	BW-S3W2+	A7122240	2018/05	2019/05
Attenuator 3dB	MINI CIRCUITS	BW-S3W2+	A7122241	2018/05	2019/05
Attenuator 3dB	MINI CIRCUITS	BW-S3W2+	A7122242	2018/05	2019/05
Attenuator 3dB	MINI CIRCUITS	BW-S3W2+	A7122243	2018/05	2019/05
Power splitter	Mini-Circuits	ZN6PD-63W-S+	A7132040	2018/05	2019/05
Power splitter	Mini-Circuits	ZN6PD-63W-S+	A7132041	2018/05	2019/05
Load 50 ohms	Fairview Microwave	ST0635F	A7152075	2018/05	2019/05
Load 50 ohms	Fairview Microwave	ST0635F	A7152076	2018/05	2019/05
Load 50 ohms	Fairview Microwave	ST0635F	A7152077	2018/05	2019/05
Load 50 ohms	Fairview Microwave	ST0635F	A7152078	2018/05	2019/05

Note: In our quality system, the test equipment calibration due is more & less 2 months



5.5. DIVERGENCE, ADDITION OR SUPPRESSION ON THE TEST SPECIFICATION

None Divergence:



L C I E

5.6. RESULTS

802.11a	
Channel	Channel
FL (MHz)	5490
FH (MHz)	5510
U- NII Detection bandwidth (MHz)	20
99% Occupied bandwidth (MHz)	17,13
U- NII Detection Bandwidth (%)	116,8

802.11n HT20	
Channel	Channel
FL (MHz)	5490
FH (MHz)	5510
U- NII Detection bandwidth (MHz)	20
99% Occupied bandwidth (MHz)	18,08
U- NII Detection Bandwidth (%)	110,6

802.11n HT40	
Channel	Channel
FL (MHz)	5490
FH (MHz)	5530
U- NII Detection bandwidth (MHz)	40
99% Occupied bandwidth (MHz)	36,9
U- NII Detection Bandwidth (%)	108,4



802.11ac VHT80	
Channel	Channel
FL (MHz)	5490
FH (MHz)	5570
U-NII Detection bandwidth (MHz)	80
99% Occupied bandwidth (MHz)	79,93
U-NII Detection Bandwidth (%)	100,1

5.7. CONCLUSION

U-NII Detection Bandwidth measurement performed on the sample of the product **SAGEMCOM DCIWA384 UHD AIt US V2**, SN: **253764997**, in configuration and description presented in this test report, show levels **compliant** to the 47 CFR PART 15.407 limits.

6. DYNAMIC FREQUENCY SELECTION (DFS): STATISTICAL PERFORMANCE CHECK

6.1. TEST CONDITIONS

Test performed by : Mathieu CERISIER
 Date of test : September 5, 2018
 Ambient temperature : 24 °C
 Relative humidity : 44 %

6.2. TEST SETUP

- The Equipment Under Test is:

- On a table
- In an anechoic chamber

- Measurement is performed with a spectrum analyzer:

- On the EUT conducted access
- On the EUT with a test fixture

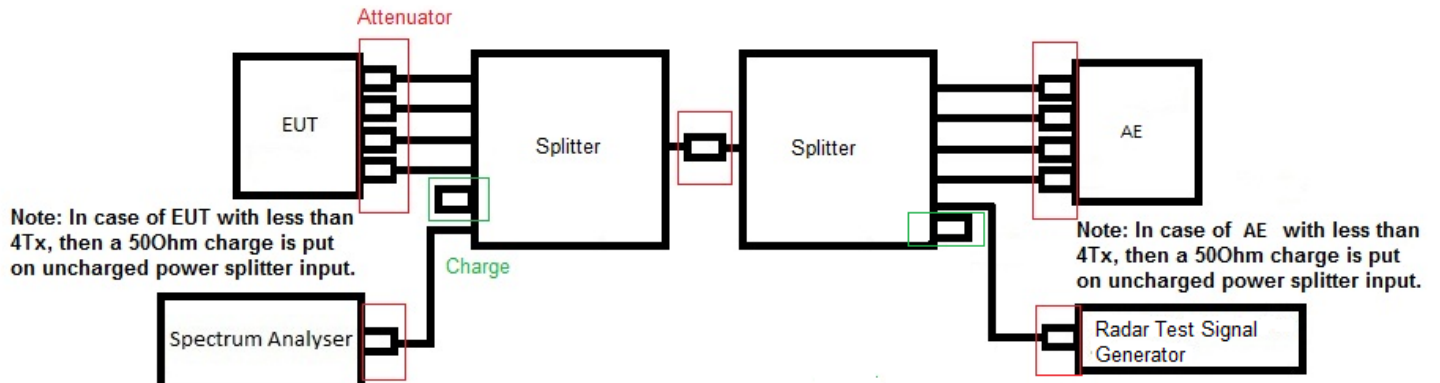



L C I E



Photograph for Statistical Performance Check



L C I E

6.3. LIMIT

Short Pulse Radar Test Waveform					
Radar Type	Pulse Width (µsec)	PRI (µsec)	Number of Pulses	Minimum Percentage of Successful Detection	Minimum Number of Trials
1	1	See pulse sequence	$(1/360) \cdot (19 \cdot 10^6 / 3066)$	60%	30
2	1-5	150-230	23-29	60%	30
3	6-10	200-500	16-18	60%	30
4	11-20	200-500	12-16	60%	30
Aggregate Radar Type 1-4 (%)				80%	120

Long Pulse Radar Test Waveform							
Radar Type	Pulse Width (µsec)	Chirp Width (MHz)	PRI (µsec)	Number of Pulses	Number of Bursts	Minimum Percentage of Successful Detection	Minimum Number of Trials
5	50-100	5-20	1000-2000	1-3	8-20	80%	30

Frequency Hopping Radar Test Waveform							
Radar Type	Pulse Width (µsec)	PRI (µsec)	Pulses per Hop	Hopping Rate (kHz)	Hopping Sequence Length (msec)	Minimum Percentage of Successful Detection	Minimum Number of Trials
6	1	333	9	0.333	300	70%	30

6.4. TEST EQUIPMENT LIST

Description	Constructor	Model	N°	Cal. Date	Cal. Due
Multimeter	Keithley	2000	A1242090	2017/05	2019/05
EMI receiver	ROHDE & SCHWARZ	ESR 7	A2642026	2017/02	2019/02
Cable	STORMFLEX	920-0202-024	A5329662	2018/05	2019/05
Cable	STORMFLEX	920-0202-025	A5329663	2018/05	2019/05
Cable	STORMFLEX	920-0202-026	A5329664	2018/05	2019/05
Cable	STORMFLEX	920-0202-027	A5329665	2018/05	2019/05
Cable	STORMFLEX	920-0202-028	A5329666	2018/05	2019/05
Cable	STORMFLEX	920-0202-029	A5329667	2018/05	2019/05
Cable	STORMFLEX	920-0202-030	A5329668	2018/05	2019/05
Cable	STORMFLEX	920-0202-031	A5329670	2018/05	2019/05
Cable	STORMFLEX	920-0202-033	A5329672	2018/05	2019/05
Cable	STORMFLEX	920-0202-034	A5329673	2018/05	2019/05
Power supply	KIKUSUI	PCR500M	A7040079	Verified with calibrated multimeter	
Signal generator	ROHDE & SCHWARZ	SMJ100A	A5444007	Verified with calibrated EMI receiver	
Attenuator 10dB	MINI CIRCUITS	BW-S10W2+	A7122229	2018/05	2019/05
Attenuator 10dB	MINI CIRCUITS	BW-S10W2+	A7122230	2018/05	2019/05
RF cable & Attenuator 20dB	Télédyne & MINI CIRCUITS	920-0202-024 & FW-20+	A5329661	2018/05	2019/05
RF cable & Attenuator 20dB	Télédyne & MINI CIRCUITS	920-0202-024 & FW-20+	A5329676	2018/05	2019/05
RF cable & Attenuator 20dB	Télédyne & MINI CIRCUITS	920-0202-024 & FW-20+	A5329674	2018/05	2019/05
RF cable & Attenuator 20dB	Télédyne & MINI CIRCUITS	920-0202-024 & FW-20+	A5329675	2018/05	2019/05
Attenuator 3dB	MINI CIRCUITS	BW-S3W2+	A7122238	2018/05	2019/05
Attenuator 3dB	MINI CIRCUITS	BW-S3W2+	A7122239	2018/05	2019/05
Attenuator 3dB	MINI CIRCUITS	BW-S3W2+	A7122240	2018/05	2019/05
Attenuator 3dB	MINI CIRCUITS	BW-S3W2+	A7122241	2018/05	2019/05
Attenuator 3dB	MINI CIRCUITS	BW-S3W2+	A7122242	2018/05	2019/05
Attenuator 3dB	MINI CIRCUITS	BW-S3W2+	A7122243	2018/05	2019/05
Power splitter	Mini-Circuits	ZN6PD-63W-S+	A7132040	2018/05	2019/05
Power splitter	Mini-Circuits	ZN6PD-63W-S+	A7132041	2018/05	2019/05
Load 50 ohms	Fairview Microwave	ST0635F	A7152075	2018/05	2019/05
Load 50 ohms	Fairview Microwave	ST0635F	A7152076	2018/05	2019/05
Load 50 ohms	Fairview Microwave	ST0635F	A7152077	2018/05	2019/05
Load 50 ohms	Fairview Microwave	ST0635F	A7152078	2018/05	2019/05

Note: In our quality system, the test equipment calibration due is more & less 2 months



L C I E

6.5. DIVERGENCE, ADDITION OR SUPPRESSION ON THE TEST SPECIFICATION

None Divergence:

6.6. RESULTS

802.11a	
Short Pulse Radar	
Channel	Channel
Detection Radar Type 1 (%)	96,7
Detection Radar Type 2 (%)	100
Detection Radar Type 3 (%)	100
Detection Radar Type 4 (%)	93,3
Aggregate Radar Type 1-4 (%)	97,5
Long Pulse Radar	
Detection Radar Type 5 (%)	100
Frequency Hopping Radar	
Detection Radar Type 6 (%)	100

802.11n HT20	
Short Pulse Radar	
Channel	Channel
Detection Radar Type 1 (%)	100
Detection Radar Type 2 (%)	100
Detection Radar Type 3 (%)	96,7
Detection Radar Type 4 (%)	90
Aggregate Radar Type 1-4 (%)	96,675
Long Pulse Radar	
Detection Radar Type 5 (%)	100
Frequency Hopping Radar	
Detection Radar Type 6 (%)	100



802.11n HT40	
Short Pulse Radar	
Channel	Channel
Detection Radar Type 1 (%)	90,0
Detection Radar Type 2 (%)	100,0
Detection Radar Type 3 (%)	100,0
Detection Radar Type 4 (%)	73,3
Aggregate Radar Type 1-4 (%)	90,8
Long Pulse Radar	
Detection Radar Type 5 (%)	100
Frequency Hopping Radar	
Detection Radar Type 6 (%)	100

802.11ac VHT80	
Short Pulse Radar	
Channel	Channel
Detection Radar Type 1 (%)	93,3
Detection Radar Type 2 (%)	80,0
Detection Radar Type 3 (%)	86,7
Detection Radar Type 4 (%)	76,7
Aggregate Radar Type 1-4 (%)	84,2
Long Pulse Radar	
Detection Radar Type 5 (%)	100
Frequency Hopping Radar	
Detection Radar Type 6 (%)	100

6.7. CONCLUSION

Statistical Performance Check measurement performed on the sample of the product **SAGEMCOM DCIWA384 UHD Ait US V2**, SN: **253764997**, in configuration and description presented in this test report, show levels **compliant** to the 47 CFR PART 15.407 limits.



7. DYNAMIC FREQUENCY SELECTION (DFS): CHANNEL CLOSING TRANSMISSION TIME & CHANNEL MOVE TIME

7.1. TEST CONDITIONS

Test performed by : Mathieu CERISIER
Date of test : September 5, 2018
Ambient temperature : 24 °C
Relative humidity : 44 %

7.2. TEST SETUP

- The Equipment Under Test is:

- On a table
- In an anechoic chamber

- Measurement is performed with a spectrum analyzer:

- On the EUT conducted access
- On the EUT with a test fixture

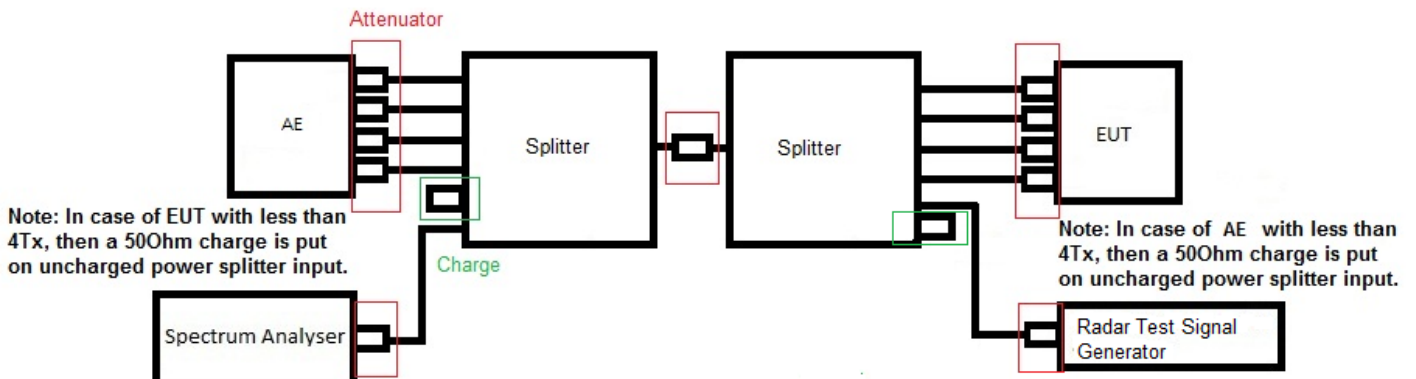
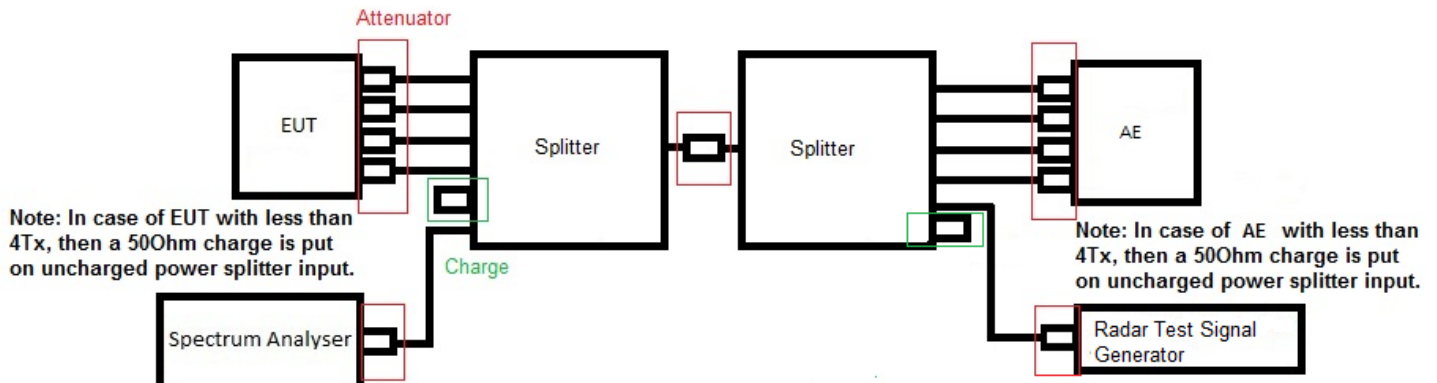



L C I E



Photograph for DFS Channel Closing Transmission Time & Channel Move Time

7.3. LIMIT

Channel Closing Transmission Time shall not exceed 0.26second
Channel Move Time shall not exceed 10seconds

7.4. TEST EQUIPMENT LIST

Description	Constructor	Model	N°	Cal. Date	Cal. Due
Multimeter	Keithley	2000	A1242090	2017/05	2019/05
EMI receiver	ROHDE & SCHWARZ	ESR 7	A2642026	2017/02	2019/02
Cable	STORMFLEX	920-0202-024	A5329662	2018/05	2019/05
Cable	STORMFLEX	920-0202-025	A5329663	2018/05	2019/05
Cable	STORMFLEX	920-0202-026	A5329664	2018/05	2019/05
Cable	STORMFLEX	920-0202-027	A5329665	2018/05	2019/05
Cable	STORMFLEX	920-0202-028	A5329666	2018/05	2019/05
Cable	STORMFLEX	920-0202-029	A5329667	2018/05	2019/05
Cable	STORMFLEX	920-0202-030	A5329668	2018/05	2019/05
Cable	STORMFLEX	920-0202-031	A5329670	2018/05	2019/05
Cable	STORMFLEX	920-0202-033	A5329672	2018/05	2019/05
Cable	STORMFLEX	920-0202-034	A5329673	2018/05	2019/05
Power supply	KIKUSUI	PCR500M	A7040079	Verified with calibrated multimeter	
Signal generator	ROHDE & SCHWARZ	SMJ100A	A5444007	Verified with calibrated EMI receiver	
Attenuator 10dB	MINI CIRCUITS	BW-S10W2+	A7122229	2018/05	2019/05
Attenuator 10dB	MINI CIRCUITS	BW-S10W2+	A7122230	2018/05	2019/05
RF cable & Attenuator 20dB	Télédyne & MINI CIRCUITS	920-0202-024 & FW-20+	A5329661	2018/05	2019/05
RF cable & Attenuator 20dB	Télédyne & MINI CIRCUITS	920-0202-024 & FW-20+	A5329676	2018/05	2019/05
RF cable & Attenuator 20dB	Télédyne & MINI CIRCUITS	920-0202-024 & FW-20+	A5329674	2018/05	2019/05
RF cable & Attenuator 20dB	Télédyne & MINI CIRCUITS	920-0202-024 & FW-20+	A5329675	2018/05	2019/05
Attenuator 3dB	MINI CIRCUITS	BW-S3W2+	A7122238	2018/05	2019/05
Attenuator 3dB	MINI CIRCUITS	BW-S3W2+	A7122239	2018/05	2019/05
Attenuator 3dB	MINI CIRCUITS	BW-S3W2+	A7122240	2018/05	2019/05
Attenuator 3dB	MINI CIRCUITS	BW-S3W2+	A7122241	2018/05	2019/05
Attenuator 3dB	MINI CIRCUITS	BW-S3W2+	A7122242	2018/05	2019/05
Attenuator 3dB	MINI CIRCUITS	BW-S3W2+	A7122243	2018/05	2019/05
Power splitter	Mini-Circuits	ZN6PD-63W-S+	A7132040	2018/05	2019/05
Power splitter	Mini-Circuits	ZN6PD-63W-S+	A7132041	2018/05	2019/05
Load 50 ohms	Fairview Microwave	ST0635F	A7152075	2018/05	2019/05
Load 50 ohms	Fairview Microwave	ST0635F	A7152076	2018/05	2019/05
Load 50 ohms	Fairview Microwave	ST0635F	A7152077	2018/05	2019/05
Load 50 ohms	Fairview Microwave	ST0635F	A7152078	2018/05	2019/05

Note: In our quality system, the test equipment calibration due is more & less 2 months



7.5. DIVERGENCE, ADDITION OR SUPPRESSION ON THE TEST SPECIFICATION

None Divergence:

7.6. RESULTS

Channel Closing Transmission Time & Channel Move Time Master
802.11ac VHT80
C26

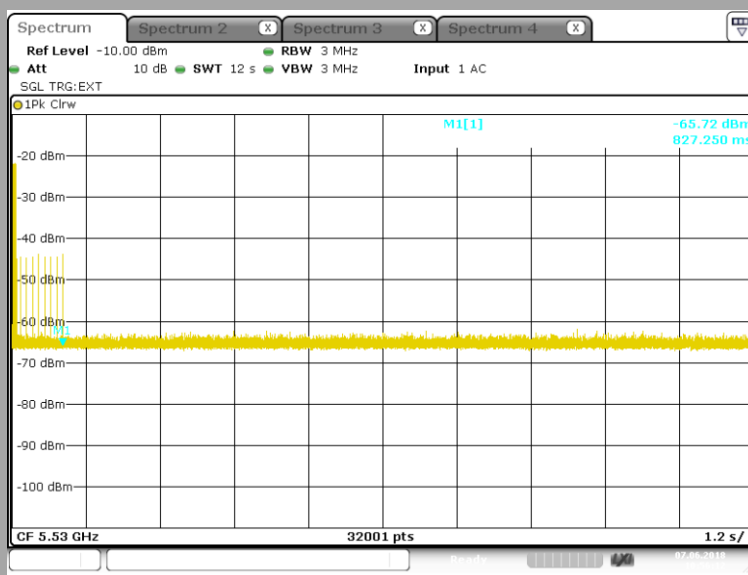
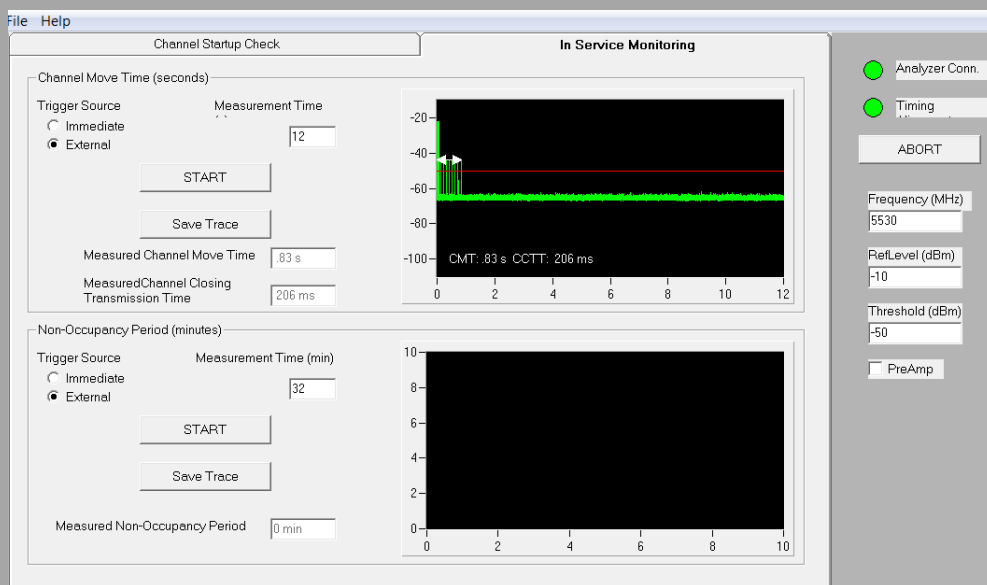

Channel Closing Transmission Time (s)	0,206
Channel Move Time (s)	0,83



L C I E

Channel Closing Transmission Time & Channel Move Time slave
802.11ac VHT80

C26

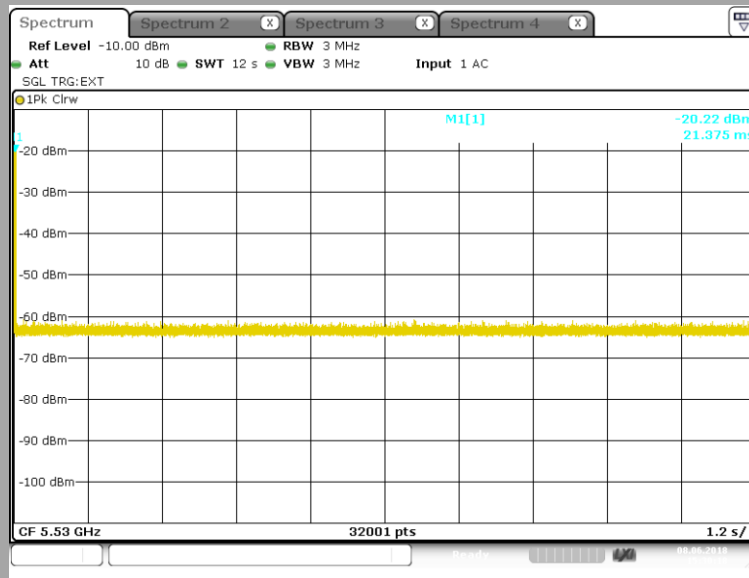
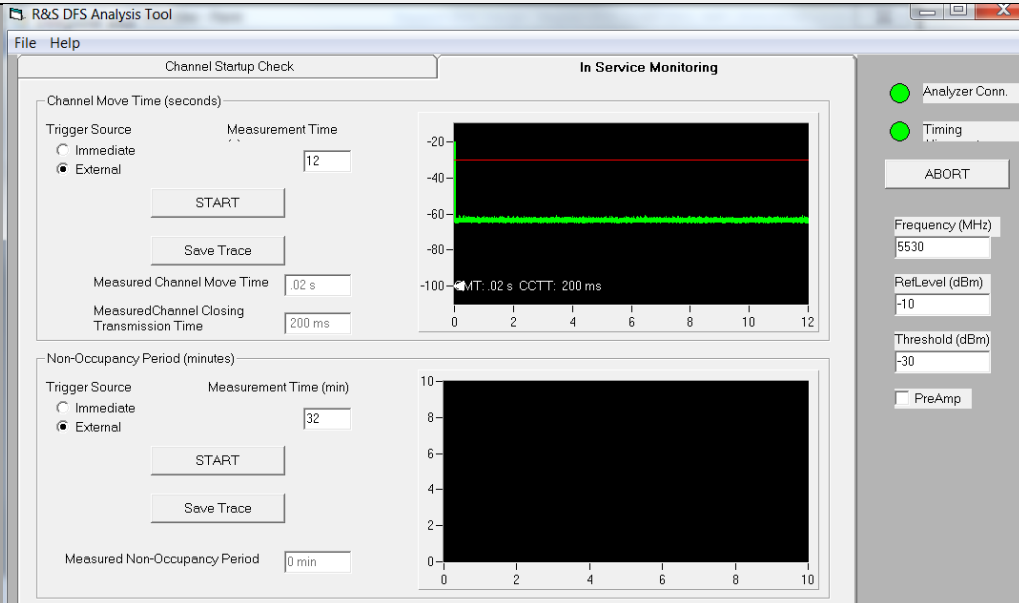

Channel Closing Transmission Time (s)	0,2
Channel Move Time (s)	0,2

7.7. CONCLUSION

Channel Closing Transmission Time & Channel Move Time measurement performed on the sample of the product **SAGEMCOM DCIWA384 UHD Ait US V2**, SN: **253764997**, in configuration and description presented in this test report, show levels **compliant** to the 47 CFR PART 15.407 limits.

8. DYNAMIC FREQUENCY SELECTION (DFS): NON-OCCUPANCY PERIOD

8.1. TEST CONDITIONS

Test performed by : Mathieu CERISIER
 Date of test : September 4, 2018 to September 5, 2018
 Ambient temperature : 24 °C
 Relative humidity : 44 %

8.2. TEST SETUP

- The Equipment Under Test is:

- On a table
- In an anechoic chamber

- Measurement is performed with a spectrum analyzer:

- On the EUT conducted access
- On the EUT with a test fixture

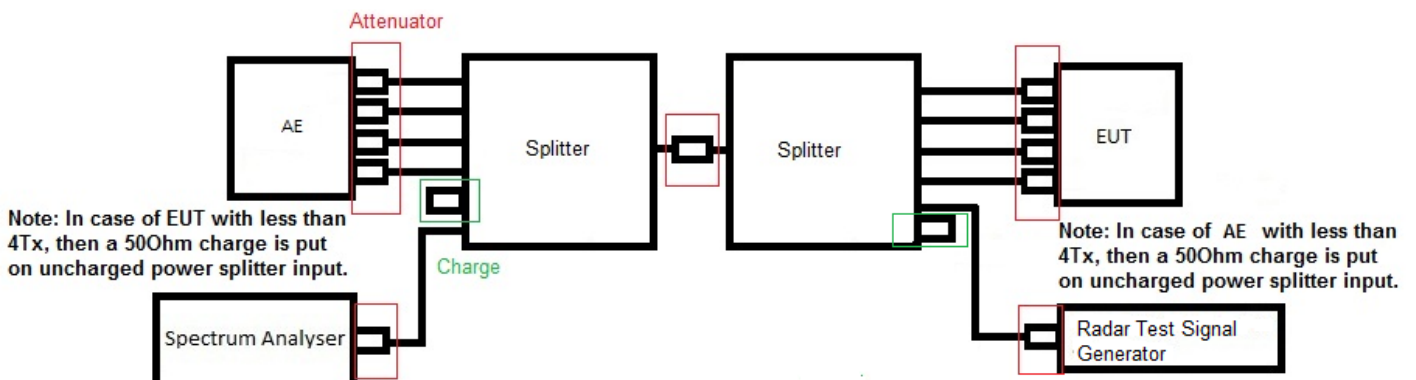
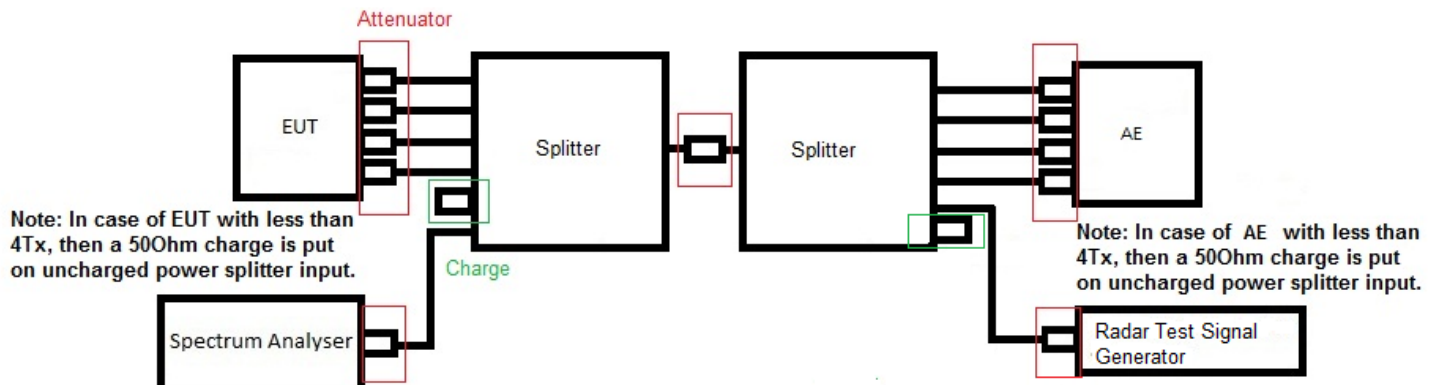



L C I E



Photograph for DFS Non-Occupancy Period

8.3. LIMIT

Non-Occupancy Period shall exceed 1800 seconds

8.4. TEST EQUIPMENT LIST

Description	Constructor	Model	N°	Cal. Date	Cal. Due
Multimeter	Keithley	2000	A1242090	2017/05	2019/05
EMI receiver	ROHDE & SCHWARZ	ESR 7	A2642026	2017/02	2019/02
Cable	STORMFLEX	920-0202-024	A5329662	2018/05	2019/05
Cable	STORMFLEX	920-0202-025	A5329663	2018/05	2019/05
Cable	STORMFLEX	920-0202-026	A5329664	2018/05	2019/05
Cable	STORMFLEX	920-0202-027	A5329665	2018/05	2019/05
Cable	STORMFLEX	920-0202-028	A5329666	2018/05	2019/05
Cable	STORMFLEX	920-0202-029	A5329667	2018/05	2019/05
Cable	STORMFLEX	920-0202-030	A5329668	2018/05	2019/05
Cable	STORMFLEX	920-0202-031	A5329670	2018/05	2019/05
Cable	STORMFLEX	920-0202-033	A5329672	2018/05	2019/05
Cable	STORMFLEX	920-0202-034	A5329673	2018/05	2019/05
Power supply	KIKUSUI	PCR500M	A7040079	Verified with calibrated multimeter	
Signal generator	ROHDE & SCHWARZ	SMJ100A	A5444007	Verified with calibrated EMI receiver	
Attenuator 10dB	MINI CIRCUITS	BW-S10W2+	A7122229	2018/05	2019/05
Attenuator 10dB	MINI CIRCUITS	BW-S10W2+	A7122230	2018/05	2019/05
RF cable & Attenuator 20dB	Télédyne & MINI CIRCUITS	920-0202-024 & FW-20+	A5329661	2018/05	2019/05
RF cable & Attenuator 20dB	Télédyne & MINI CIRCUITS	920-0202-024 & FW-20+	A5329676	2018/05	2019/05
RF cable & Attenuator 20dB	Télédyne & MINI CIRCUITS	920-0202-024 & FW-20+	A5329674	2018/05	2019/05
RF cable & Attenuator 20dB	Télédyne & MINI CIRCUITS	920-0202-024 & FW-20+	A5329675	2018/05	2019/05
Attenuator 3dB	MINI CIRCUITS	BW-S3W2+	A7122238	2018/05	2019/05
Attenuator 3dB	MINI CIRCUITS	BW-S3W2+	A7122239	2018/05	2019/05
Attenuator 3dB	MINI CIRCUITS	BW-S3W2+	A7122240	2018/05	2019/05
Attenuator 3dB	MINI CIRCUITS	BW-S3W2+	A7122241	2018/05	2019/05
Attenuator 3dB	MINI CIRCUITS	BW-S3W2+	A7122242	2018/05	2019/05
Attenuator 3dB	MINI CIRCUITS	BW-S3W2+	A7122243	2018/05	2019/05
Power splitter	Mini-Circuits	ZN6PD-63W-S+	A7132040	2018/05	2019/05
Power splitter	Mini-Circuits	ZN6PD-63W-S+	A7132041	2018/05	2019/05
Load 50 ohms	Fairview Microwave	ST0635F	A7152075	2018/05	2019/05
Load 50 ohms	Fairview Microwave	ST0635F	A7152076	2018/05	2019/05
Load 50 ohms	Fairview Microwave	ST0635F	A7152077	2018/05	2019/05
Load 50 ohms	Fairview Microwave	ST0635F	A7152078	2018/05	2019/05

Note: In our quality system, the test equipment calibration due is more & less 2 months



8.5. DIVERGENCE, ADDITION OR SUPPRESSION ON THE TEST SPECIFICATION

None Divergence:



L C I E

8.6. RESULTS

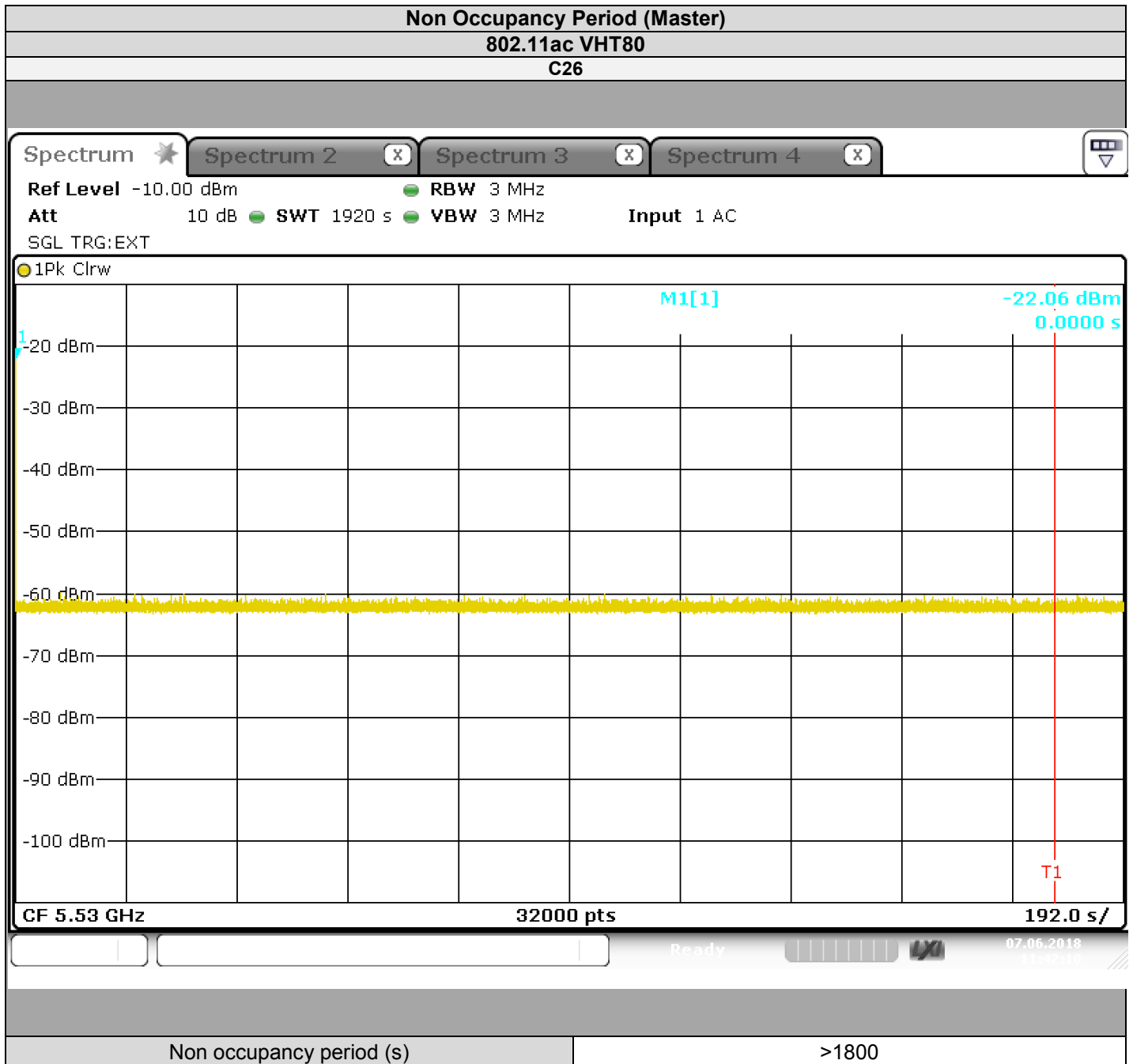



L C I E

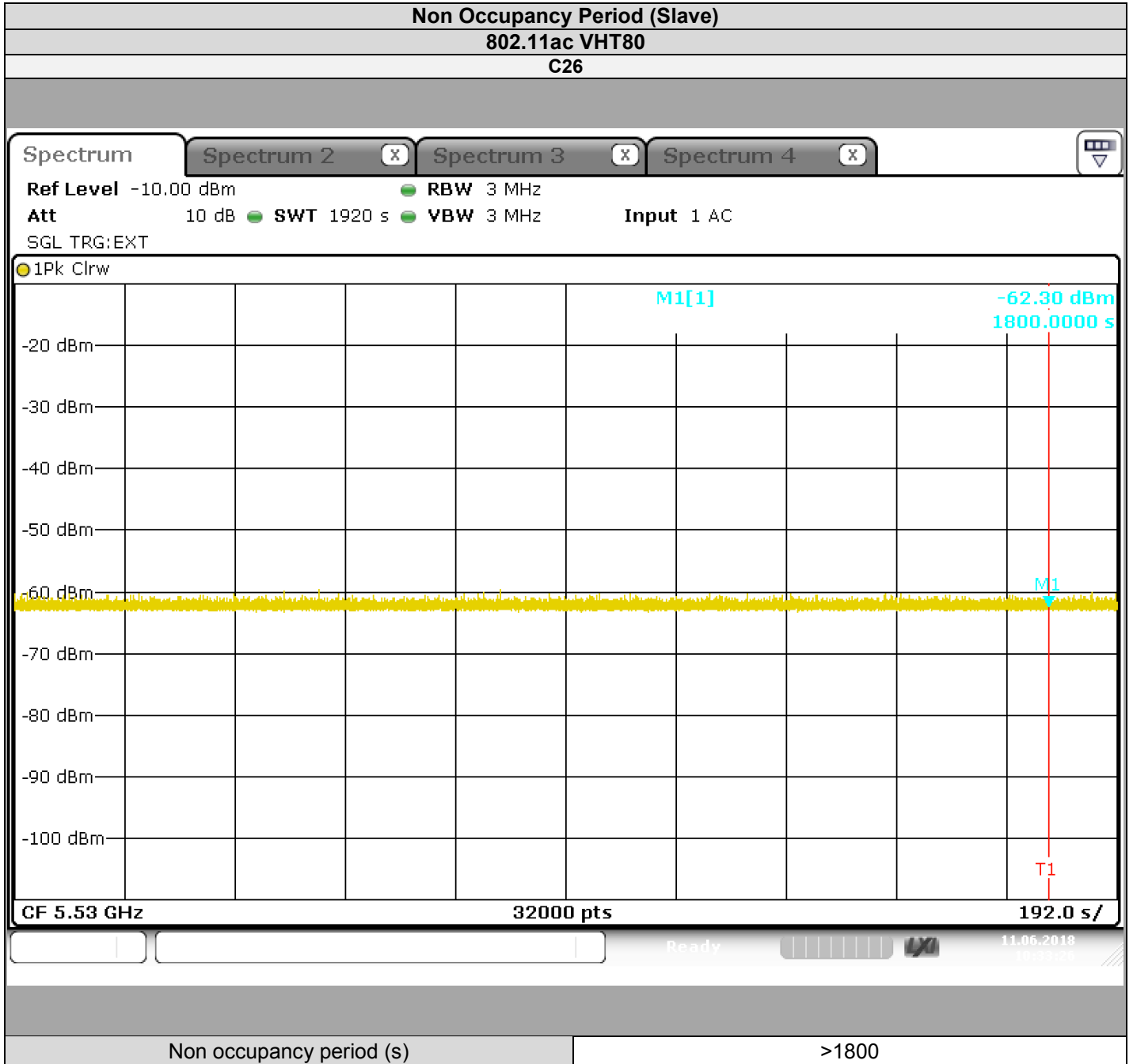

8.7. CONCLUSION

Non-Occupancy period measurement performed on the sample of the product **SAGEMCOM DCIWA384 UHD Ait US V2**, SN: **253764997**, in configuration and description presented in this test report, show levels **compliant** to the 47 CFR PART 15.407 limits.



L C I E

9. ANNEX 1: U-NII DETECTION BANDWIDTH DATA SHEET

802.11a	Channel		5500		MHz						
	U-NII Detection Bandwidth										
	Trial: Detection=1 & No Detection=0										
Radar Frequency (MHz)	Trial 1	Trial 2	Trial 3	Trial 4	Trial 5	Trial 6	Trial 7	Trial 8	Trial 9	Trial 10	Detection (%)
5490	1	1	1	1	1	1	1	1	1	1	100
5491	1	1	1	1	1	1	1	1	1	1	100
5492	1	1	1	1	1	1	1	1	1	1	100
5493	1	1	1	1	1	1	1	1	1	1	100
5494	1	1	1	1	1	1	1	1	1	1	100
5495	1	1	1	1	1	1	1	1	1	1	100
5496	1	1	1	1	1	1	1	1	1	1	100
5497	1	1	1	1	1	1	1	1	1	1	100
5498	1	1	1	1	1	1	1	1	1	1	100
5499	1	1	1	1	1	1	1	1	1	1	100
5500	1	1	1	1	1	1	1	1	1	1	100
5501	1	1	1	1	1	1	1	1	1	1	100
5502	1	1	1	1	1	1	1	1	1	1	100
5503	1	1	1	1	1	1	1	1	1	1	100
5504	1	1	1	1	1	1	1	1	1	1	100
5505	1	1	1	1	1	1	1	1	1	1	100
5506	1	1	1	1	1	1	1	1	1	1	100
5507	1	1	1	1	1	1	1	1	1	1	100
5508	1	1	1	1	1	1	1	1	1	1	100
5509	1	1	1	1	1	1	1	1	1	1	100
5510	1	1	1	1	1	1	1	1	1	1	100

802.11n HT20	Channel		5500		MHz						
	U-NII Detection Bandwidth										
	Trial: Detection=1 & No Detection=0										
Radar Frequency (MHz)	Trial 1	Trial 2	Trial 3	Trial 4	Trial 5	Trial 6	Trial 7	Trial 8	Trial 9	Trial 10	Detection (%)
5490	1	1	1	1	1	1	1	1	1	1	100
5491	1	1	1	1	1	1	1	1	1	1	100
5492	1	1	1	1	1	1	1	1	1	1	100
5493	1	1	1	1	1	1	1	1	1	1	100
5494	1	1	1	1	1	1	1	1	1	1	100
5495	1	1	1	1	1	1	1	1	1	1	100
5496	1	1	1	1	1	1	1	1	1	1	100
5497	1	1	1	1	1	1	1	1	1	1	100
5498	1	1	1	1	1	1	1	1	1	1	100
5499	1	1	1	1	1	1	1	1	1	1	100
5500	1	1	1	1	1	1	1	1	1	1	100
5501	1	1	1	1	1	1	1	1	1	1	100
5502	1	1	1	1	1	1	1	1	1	1	100
5503	1	1	1	1	1	1	1	1	1	1	100
5504	1	1	1	1	1	1	1	1	1	1	100
5505	1	1	1	1	1	1	1	1	1	1	100
5506	1	1	1	1	1	1	1	1	1	1	100
5507	1	1	1	1	1	1	1	1	1	1	100
5508	1	1	1	1	1	1	1	1	1	1	100
5509	1	1	1	1	1	1	1	1	1	1	100
5510	1	1	1	1	1	1	1	1	1	1	100



L C I E

802.11n HT40	Channel		5510 MHz								
	U-NII Detection Bandwidth										
	Trial: Detection=1 & No Detection=0										
Radar Frequency (MHz)	Trial 1	Trial 2	Trial 3	Trial 4	Trial 5	Trial 6	Trial 7	Trial 8	Trial 9	Trial 10	Detection (%)
5490	1	1	1	1	1	1	1	1	1	1	100
5491	1	1	1	1	1	1	1	1	1	1	100
5492	1	1	1	1	1	1	1	1	1	1	100
5493	1	1	1	1	1	1	1	1	1	1	100
5494	1	1	1	1	1	1	1	1	1	1	100
5495	1	1	1	1	1	1	1	1	1	1	100
5496	1	1	1	1	1	1	1	1	1	1	100
5497	1	1	1	1	1	1	1	1	1	1	100
5498	1	1	1	1	1	1	1	1	1	1	100
5499	1	1	1	1	1	1	1	1	1	1	100
5500	1	1	1	1	1	1	1	1	1	1	100
5501	1	1	1	1	1	1	1	1	1	1	100
5502	1	1	1	1	1	1	1	1	1	1	100
5503	1	1	1	1	1	1	1	1	1	1	100
5504	1	1	1	1	1	1	1	1	1	1	100
5505	1	1	1	1	1	1	1	1	1	1	100
5506	1	1	1	1	1	1	1	1	1	1	100
5507	1	1	1	1	1	1	1	1	1	1	100
5508	1	1	1	1	1	1	1	1	1	1	100
5509	1	1	1	1	1	1	1	1	1	1	100
5510	1	1	1	1	1	1	1	1	1	1	100
5511	1	1	1	1	1	1	1	1	1	1	100
5512	1	1	1	1	1	1	1	1	1	1	100
5513	1	1	1	1	1	1	1	1	1	1	100
5514	1	1	1	1	1	1	1	1	1	1	100
5515	1	1	1	1	1	1	1	1	1	1	100
5516	1	1	1	1	1	1	1	1	1	1	100
5517	1	1	1	1	1	1	1	1	1	1	100
5518	1	1	1	1	1	1	1	1	1	1	100
5519	1	1	1	1	1	1	1	1	1	1	100
5520	1	1	1	1	1	1	1	1	1	1	100
5521	1	1	1	1	1	1	1	1	1	1	100
5522	1	1	1	1	1	1	1	1	1	1	100
5523	1	1	1	1	1	1	1	1	1	1	100
5524	1	1	1	1	1	1	1	1	1	1	100
5525	1	1	1	1	1	1	1	1	1	1	100
5526	1	1	1	1	1	1	1	1	1	1	100
5527	1	1	1	1	1	1	1	1	1	1	100
5528	1	1	1	1	1	1	1	1	1	1	100
5529	1	1	1	1	1	1	1	1	1	1	100
5530	1	1	1	1	1	1	1	1	1	1	100



L C I E

802.11ac VHT80	Channel		5530 MHz								
	U-NII Detection Bandwidth										
	Trial: Detection=1 & No Detection=0										
Radar Frequency (MHz)	Trial 1	Trial 2	Trial 3	Trial 4	Trial 5	Trial 6	Trial 7	Trial 8	Trial 9	Trial 10	Detection (%)
5490	1	1	1	1	1	1	1	1	1	1	100
5491	1	1	1	1	1	1	1	1	1	1	100
5492	1	1	1	1	1	1	1	1	1	1	100
5493	1	1	1	1	1	1	1	1	1	1	100
5494	1	1	1	1	1	1	1	1	1	1	100
5495	1	1	1	1	1	1	1	1	1	1	100
5496	1	1	1	1	1	1	1	1	1	1	100
5497	1	1	1	1	1	1	1	1	1	1	100
5498	1	1	1	1	1	1	1	1	1	1	100
5499	1	1	1	1	1	1	1	1	1	1	100
5500	1	1	1	1	1	1	1	1	1	1	100
5501	1	1	1	1	1	1	1	1	1	1	100
5502	1	1	1	1	1	1	1	1	1	1	100
5503	1	1	1	1	1	1	1	1	1	1	100
5504	1	1	1	1	1	1	1	1	1	1	100
5505	1	1	1	1	1	1	1	1	1	1	100
5506	1	1	1	1	1	1	1	1	1	1	100
5507	1	1	1	1	1	1	1	1	1	1	100
5508	1	1	1	1	1	1	1	1	1	1	100
5509	1	1	1	1	1	1	1	1	1	1	100
5510	1	1	1	1	1	1	1	1	1	1	100
5511	1	1	1	1	1	1	1	1	1	1	100
5512	1	1	1	1	1	1	1	1	1	1	100
5513	1	1	1	1	1	1	1	1	1	1	100
5514	1	1	1	1	1	1	1	1	1	1	100
5515	1	1	1	1	1	1	1	1	1	1	100
5516	1	1	1	1	1	1	1	1	1	1	100
5517	1	1	1	1	1	1	1	1	1	1	100
5518	1	1	1	1	1	1	1	1	1	1	100
5519	1	1	1	1	1	1	1	1	1	1	100
5520	1	1	1	1	1	1	1	1	1	1	100
5521	1	1	1	1	1	1	1	1	1	1	100
5522	1	1	1	1	1	1	1	1	1	1	100
5523	1	1	1	1	1	1	1	1	1	1	100
5524	1	1	1	1	1	1	1	1	1	1	100
5525	1	1	1	1	1	1	1	1	1	1	100
5526	1	1	1	1	1	1	1	1	1	1	100
5527	1	1	1	1	1	1	1	1	1	1	100
5528	1	1	1	1	1	1	1	1	1	1	100
5529	1	1	1	1	1	1	1	1	1	1	100
5530	1	1	1	1	1	1	1	1	1	1	100
5531	1	1	1	1	1	1	1	1	1	1	100
5532	1	1	1	1	1	1	1	1	1	1	100
5533	1	1	1	1	1	1	1	1	1	1	100
5534	1	1	1	1	1	1	1	1	1	1	100
5535	1	1	1	1	1	1	1	1	1	1	100
5536	1	1	1	1	1	1	1	1	1	1	100
5537	1	1	1	1	1	1	1	1	1	1	100
5538	1	1	1	1	1	1	1	1	1	1	100
5539	1	1	1	1	1	1	1	1	1	1	100
5540	1	1	1	1	1	1	1	1	1	1	100
5541	1	1	1	1	1	1	1	1	1	1	100
5542	1	1	1	1	1	1	1	1	1	1	100
5543	1	1	1	1	1	1	1	1	1	1	100
5544	1	1	1	1	1	1	1	1	1	1	100
5545	1	1	1	1	1	1	1	1	1	1	100
5546	1	1	1	1	1	1	1	1	1	1	100
5547	1	1	1	1	1	1	1	1	1	1	100
5548	1	1	1	1	1	1	1	1	1	1	100
5549	1	1	1	1	1	1	1	1	1	1	100
5550	1	1	1	1	1	1	1	1	1	1	100
5551	1	1	1	1	1	1	1	1	1	1	100
5552	1	1	1	1	1	1	1	1	1	1	100
5553	1	1	1	1	1	1	1	1	1	1	100
5554	1	1	1	1	1	1	1	1	1	1	100
5555	1	1	1	1	1	1	1	1	1	1	100
5556	1	1	1	1	1	1	1	1	1	1	100
5557	1	1	1	1	1	1	1	1	1	1	100
5558	1	1	1	1	1	1	1	1	1	1	100
5559	1	1	1	1	1	1	1	1	1	1	100
5560	1	1	1	1	1	1	1	1	1	1	100
5561	1	1	1	1	1	1	1	1	1	1	100
5562	1	1	1	1	1	1	1	1	1	1	100
5563	1	1	1	1	1	1	1	1	1	1	100
5564	1	1	1	1	1	1	1	1	1	1	100
5565	1	1	1	1	1	1	1	1	1	1	100
5566	1	1	1	1	1	1	1	1	1	1	100
5567	1	1	1	1	1	1	1	1	1	1	100
5568	1	1	1	1	1	1	1	1	1	1	100
5569	1	1	1	1	1	1	1	1	1	1	100
5570	1	1	1	1	1	1	1	1	1	1	100



L C I E

10. ANNEX 2: STATISTICAL PERFORMANCE CHECK DATA SHEET

RADAR TYPE 1				802.11a	802.11n HT20	802.11n HT40	802.11ac VHT80
Trial #	Number of Pulses per Burst	Pulse Width (µsec)	PRI (µs)	Detection (1=yes/0=no)	Detection (1=yes/0=no)	Detection (1=yes/0=no)	Detection (1=yes/0=no)
1	102	1	518	1	1	1	1
2	99	1	538	1	1	1	1
3	95	1	558	1	1	1	1
4	92	1	577	1	1	1	1
5	89	1	598	1	1	1	1
6	86	1	618	1	1	0	1
7	83	1	638	1	1	1	1
8	81	1	658	1	1	1	1
9	78	1	678	1	1	1	1
10	74	1	718	0	1	1	1
11	72	1	738	1	1	0	1
12	70	1	758	1	1	1	1
13	68	1	778	1	1	1	1
14	67	1	797	1	1	1	1
15	65	1	818	1	1	1	1
16	88	1	600	1	1	1	0
17	76	1	700	1	1	1	1
18	66	1	800	1	1	1	1
19	53	1	1000	1	1	1	1
20	44	1	1200	1	1	1	1
21	38	1	1400	1	1	0	1
22	33	1	1600	1	1	1	1
23	30	1	1800	1	1	1	1
24	27	1	2000	1	1	1	0
25	24	1	2200	1	1	1	1
26	22	1	2400	1	1	1	1
27	21	1	2600	1	1	1	1
28	19	1	2800	1	1	1	1
29	19	1	2900	1	1	1	1
30	18	1	3000	1	1	1	1
Statistical Performance Check (%)				96,7	100,0	90,0	93,3



L C I E

RADAR TYPE 2				802.11a	802.11n HT20	802.11n HT40	802.11ac VHT80
Trial #	Number of Pulses per Burst	Pulse Width (µsec)	PRI (µs)	Detection (1=yes/0=no)	Detection (1=yes/0=no)	Detection (1=yes/0=no)	Detection (1=yes/0=no)
1	27	3	206	1	1	1	1
2	25	1,9	154	1	1	1	1
3	25	1,6	171	1	1	1	0
4	27	4,6	222	1	1	1	1
5	26	3,4	150	1	1	1	1
6	23	4,1	165	1	1	1	1
7	23	3,7	194	1	1	1	1
8	26	4,1	219	1	1	1	1
9	29	3,9	212	1	1	1	0
10	24	1,6	207	1	1	1	1
11	25	2,1	194	1	1	1	1
12	28	2,3	185	1	1	1	1
13	25	1,8	221	1	1	1	1
14	28	1,5	228	1	1	1	1
15	28	1,9	183	1	1	1	0
16	28	2,2	163	1	1	1	1
17	24	4,7	178	1	1	1	1
18	27	3,3	165	1	1	1	1
19	26	3,3	153	1	1	1	1
20	26	5	169	1	1	1	1
21	24	1,1	209	1	1	1	0
22	28	3,1	154	1	1	1	1
23	27	2,7	222	1	1	1	1
24	23	2,2	211	1	1	1	1
25	28	2,6	172	1	1	1	0
26	24	1,9	152	1	1	1	1
27	28	4,2	157	1	1	1	0
28	27	1,5	227	1	1	1	1
29	27	3,3	164	1	1	1	1
30	26	1,6	170	1	1	1	1
Statistical Performance Check (%)				100,0	100,0	100,0	80,0



L C I E

RADAR TYPE 3				802.11a	802.11n HT20	802.11n HT40	802.11ac VHT80
Trial #	Number of Pulses per Burst	Pulse Width (µsec)	PRI (µs)	Detection (1=yes/0=no)	Detection (1=yes/0=no)	Detection (1=yes/0=no)	Detection (1=yes/0=no)
1	18	6,2	483	1	1	1	1
2	16	6,6	487	1	1	1	1
3	17	9,2	441	1	1	1	1
4	18	9	283	1	1	1	1
5	16	9,7	391	1	1	1	1
6	16	6,3	419	1	1	1	0
7	16	7,3	315	1	1	1	1
8	16	8,8	494	1	1	1	1
9	18	8,3	277	1	1	1	1
10	18	6,1	452	1	1	1	1
11	16	6,8	274	1	1	1	1
12	17	9,8	488	1	1	1	1
13	17	9,8	387	1	1	1	1
14	16	9,5	385	1	1	1	0
15	17	9,2	372	1	1	1	1
16	18	7,2	337	1	1	1	1
17	17	7,1	465	1	1	1	1
18	17	8,9	258	1	1	1	1
19	16	8	292	1	1	1	1
20	17	6,1	332	1	1	1	1
21	17	10	477	1	1	1	0
22	17	6,7	468	1	1	1	1
23	17	8,9	299	1	1	1	1
24	18	7,7	383	1	1	1	1
25	17	6,7	429	1	1	1	1
26	17	8,2	490	1	1	1	1
27	17	7,6	421	1	1	1	1
28	18	6,4	387	1	1	1	0
29	17	6,5	258	1	0	1	1
30	16	6,3	357	1	1	1	1
Statistical Performance Check (%)				100,0	96,7	100,0	86,7



L C I E

RADAR TYPE 4				802.11a	802.11n HT20	802.11n HT40	802.11ac VHT80
Trial #	Number of Pulses per Burst	Pulse Width (µsec)	PRI (µs)	Detection (1=yes/0=no)	Detection (1=yes/0=no)	Detection (1=yes/0=no)	Detection (1=yes/0=no)
1	16	17,4	252	1	1	1	1
2	12	14,1	229	1	1	1	1
3	15	16,5	229	1	1	1	1
4	15	17,4	270	1	1	1	0
5	15	16,9	360	1	1	1	1
6	12	17,1	362	1	1	0	1
7	14	12,1	296	1	0	1	1
8	12	12	482	1	1	0	1
9	14	17,9	220	1	1	0	1
10	15	13,1	391	1	1	1	0
11	12	13,7	396	1	1	1	0
12	13	13	355	1	1	1	1
13	15	16,9	405	1	1	1	0
14	12	16,1	241	1	1	1	1
15	13	19,8	388	1	1	1	1
16	14	17	386	1	0	0	1
17	12	12,7	497	1	1	0	1
18	15	14,2	432	0	1	1	1
19	14	11,4	320	1	1	1	0
20	12	16,9	478	1	1	1	1
21	15	13,6	314	1	1	1	1
22	12	20	467	0	1	1	1
23	16	13,8	398	1	0	1	1
24	16	19,8	459	1	1	1	0
25	15	17,4	399	1	1	1	1
26	15	16,9	226	1	1	0	1
27	13	16,9	345	1	1	0	1
28	12	13,7	404	1	1	1	0
29	15	15	295	1	1	0	1
30	15	14,5	313	1	1	1	1
Statistical Performance Check (%)				93,3	90,0	73,3	76,7



L C I E

RADAR TYPE 5		802.11a	802.11n HT20	802.11n HT40	802.11ac VHT80
Trial #	See Annex	Detection (1=yes/0=no)	Detection (1=yes/0=no)	Detection (1=yes/0=no)	Detection (1=yes/0=no)
1	Trial 1	1	1	1	1
2	Trial 2	1	1	1	1
3	Trial 3	1	1	1	1
4	Trial 4	1	1	1	1
5	Trial 5	1	1	1	1
6	Trial 6	1	1	1	1
7	Trial 7	1	1	1	1
8	Trial 8	1	1	1	1
9	Trial 9	1	1	1	1
10	Trial 10	1	1	1	1
11	Trial 11	1	1	1	1
12	Trial 12	1	1	1	1
13	Trial 13	1	1	1	1
14	Trial 14	1	1	1	1
15	Trial 15	1	1	1	1
16	Trial 16	1	1	1	1
17	Trial 17	1	1	1	1
18	Trial 18	1	1	1	1
19	Trial 19	1	1	1	1
20	Trial 20	1	1	1	1
21	Trial 21	1	1	1	1
22	Trial 22	1	1	1	1
23	Trial 23	1	1	1	1
24	Trial 24	1	1	1	1
25	Trial 25	1	1	1	1
26	Trial 26	1	1	1	1
27	Trial 27	1	1	1	1
28	Trial 28	1	1	1	1
29	Trial 29	1	1	1	1
30	Trial 30	1	1	1	1
Statistical Performance Check (%)		100,0	100,0	100,0	100,0



L C I E

RADAR TYPE 6		802.11a	802.11n HT20	802.11n HT40	802.11ac VHT80
Trial #	http://ntiacsd.ntia.doc.gov/dfs/HopFreqInRlanBW.txt	Detection (1=yes/0=no)	Detection (1=yes/0=no)	Detection (1=yes/0=no)	Detection (1=yes/0=no)
1	Burst 0	1	1	1	1
2	Burst 1	1	1	1	1
3	Burst 2	1	1	1	1
4	Burst 3	1	1	1	1
5	Burst 4	1	1	1	1
6	Burst 5	1	1	1	1
7	Burst 6	1	1	1	1
8	Burst 7	1	1	1	1
9	Burst 8	1	1	1	1
10	Burst 9	1	1	1	1
11	Burst 10	1	1	1	1
12	Burst 11	1	1	1	1
13	Burst 12	1	1	1	1
14	Burst 13	1	1	1	1
15	Burst 14	1	1	1	1
16	Burst 15	1	1	1	1
17	Burst 16	1	1	1	1
18	Burst 17	1	1	1	1
19	Burst 18	1	1	1	1
20	Burst 19	1	1	1	1
21	Burst 20	1	1	1	1
22	Burst 21	1	1	1	1
23	Burst 22	1	1	1	1
24	Burst 23	1	1	1	1
25	Burst 24	1	1	1	1
26	Burst 25	1	1	1	1
27	Burst 26	1	1	1	1
28	Burst 27	1	1	1	1
29	Burst 28	1	1	1	1
30	Burst 29	1	1	1	1
Statistical Performance Check (%)		100,0	100,0	100,0	100,0



L C I E

11. ANNEX 3: RADAR TEST SIGNAL TYPE 5 & 0

TYPE 5 PARAMETER SHEET

Rohde & Schwarz
K6 Pulse Sequencer

Trial Number : 1

Bursts in Trial: 8

Burst	Number of Pulses	Pulse Width (µsec)	Chirp Width (MHz)	Pulse 1-to-2 Spacing (µsec)	Pulse 2-to-3 Spacing (µsec)	Start Location Within Interval (msec)
1	1	83	8			1028
2	2	89,2	20	928		137
3	2	51,3	13	1091		1139
4	3	74,1	20	1114	1237	1423
5	2	81,3	15	1828		714
6	2	64,5	7	1706		1035
7	3	87	18	1045	954	1492
8	2	79,6	19	1047		577
9						
10						
11						
12						
13						
14						
15						
16						
17						
18						
19						
20						



L C I E

TYPE 5 PARAMETER SHEET

Rohde & Schwarz
K6 Pulse Sequencer

Trial Number : 2

Bursts in Trial: 9

Burst	Number of Pulses	Pulse Width (µsec)	Chirp Width (MHz)	Pulse 1-to-2 Spacing (µsec)	Pulse 2-to-3 Spacing (µsec)	Start Location Within Interval (msec)
1	1	84,8	7			1057
2	2	69,4	8	1611		744
3	2	52,8	7	1026		294
4	2	58,4	11	1001		596
5	3	87,9	17	1130	923	432
6	1	79,1	7			812
7	1	68	20			702
8	3	66,3	15	1213	1920	301
9	2	86	8	1066		430
10						
11						
12						
13						
14						
15						
16						
17						
18						
19						
20						



L C I E

TYPE 5 PARAMETER SHEET

Rohde & Schwarz
K6 Pulse Sequencer

Trial Number : 3

Bursts in Trial: 10

Burst	Number of Pulses	Pulse Width (µsec)	Chirp Width (MHz)	Pulse 1-to-2 Spacing (µsec)	Pulse 2-to-3 Spacing (µsec)	Start Location Within Interval (msec)
1	3	98,2	9	1535	1372	264
2	3	73,6	18	985	1379	670
3	2	96	9	931		1069
4	2	95,1	7	1755		457
5	2	75,7	9	1863		543
6	2	71,7	15	1452		84
7	2	74,5	17	1126		525
8	3	80,6	14	1615	1146	967
9	2	56,5	19	1319		291
10	3	55,2	15	993	1070	1016
11						
12						
13						
14						
15						
16						
17						
18						
19						
20						



L C I E

TYPE 5 PARAMETER SHEET

Rohde & Schwarz
K6 Pulse Sequencer

Trial Number : 4

Bursts in Trial: 11

Burst	Number of Pulses	Pulse Width (µsec)	Chirp Width (MHz)	Pulse 1-to-2 Spacing (µsec)	Pulse 2-to-3 Spacing (µsec)	Start Location Within Interval (msec)
1	1	91,3	7			70
2	2	96,1	20	1397		244
3	2	92,9	8	1222		569
4	1	93,7	9			1024
5	3	73,3	15	1243	1066	815
6	3	88,1	13	1133	1652	549
7	2	93,7	14	920		1027
8	1	99,1	6			834
9	3	88,6	17	1511	1909	600
10	2	92,5	10	1050		314
11	2	53,7	17	1624		7
12						
13						
14						
15						
16						
17						
18						
19						
20						



L C I E

TYPE 5 PARAMETER SHEET

Rohde & Schwarz
K6 Pulse Sequencer

Trial Number : 5

Bursts in Trial: 12

Burst	Number of Pulses	Pulse Width (µsec)	Chirp Width (MHz)	Pulse 1-to-2 Spacing (µsec)	Pulse 2-to-3 Spacing (µsec)	Start Location Within Interval (msec)
1	1	51,8	20			641
2	2	80,1	8	1641		875
3	2	88,2	8	1852		33
4	2	71,8	10	1048		476
5	2	91,8	6	1778		910
6	2	56,8	19	1212		570
7	1	69,6	13			637
8	2	94,6	13	1595		347
9	3	52,7	18	1682	1384	483
10	2	65,5	5	1082		39
11	3	68,6	17	1467	1397	337
12	1	94,1	14			378
13						
14						
15						
16						
17						
18						
19						
20						



L C I E

TYPE 5 PARAMETER SHEET

Rohde & Schwarz
K6 Pulse Sequencer

Trial Number : 6

Bursts in Trial: 13

Burst	Number of Pulses	Pulse Width (µsec)	Chirp Width (MHz)	Pulse 1-to-2 Spacing (µsec)	Pulse 2-to-3 Spacing (µsec)	Start Location Within Interval (msec)
1	2	80,3	8	1655		381
2	2	54,5	5	1022		363
3	3	68,3	12	967	1634	209
4	3	64	18	1382	1616	337
5	3	73,2	20	1339	1044	432
6	2	77,8	20	1441		910
7	1	57,2	13			137
8	3	77,3	15	1284	1888	320
9	2	72,4	10	1040		349
10	2	83,9	5	1843		849
11	2	95	13	1021		352
12	1	63,3	10			583
13	2	60,3	11	1658		285
14						
15						
16						
17						
18						
19						
20						



L C I E

TYPE 5 PARAMETER SHEET

Rohde & Schwarz
K6 Pulse Sequencer

Trial Number : 7

Bursts in Trial: 14

Burst	Number of Pulses	Pulse Width (µsec)	Chirp Width (MHz)	Pulse 1-to-2 Spacing (µsec)	Pulse 2-to-3 Spacing (µsec)	Start Location Within Interval (msec)
1	1	60,8	19			487
2	2	91	14	1147		817
3	1	57,8	9			597
4	1	77,6	8			20
5	2	66,3	13	1151		92
6	1	97,5	7			569
7	1	90,1	10			716
8	1	53	6			403
9	3	50,5	17	1524	1311	397
10	1	55,8	10			121
11	2	73,7	12	1777		285
12	3	55,3	12	968	1848	240
13	2	79,8	7	1709		178
14	3	84,3	6	1627	1577	180
15						
16						
17						
18						
19						
20						



L C I E

TYPE 5 PARAMETER SHEET

Rohde & Schwarz
K6 Pulse Sequencer

Trial Number : 8

Bursts in Trial: 15

Burst	Number of Pulses	Pulse Width (µsec)	Chirp Width (MHz)	Pulse 1-to-2 Spacing (µsec)	Pulse 2-to-3 Spacing (µsec)	Start Location Within Interval (msec)
1	2	65,3	10	1635		169
2	2	90,7	9	1682		356
3	1	87,7	18			265
4	1	82,7	6			216
5	1	85,2	20			370
6	2	67,9	6	1090		639
7	3	61,6	11	1413	990	778
8	2	73,1	7	1591		519
9	3	51,6	15	1882	1340	551
10	1	83,4	12			743
11	2	93,1	5	1741		660
12	2	88,6	7	1004		746
13	3	91,9	19	1291	1892	313
14	2	90,7	20	1628		362
15	1	52,4	17			37
16						
17						
18						
19						
20						



L C I E

TYPE 5 PARAMETER SHEET

Rohde & Schwarz
K6 Pulse Sequencer

Trial Number : 9

Bursts in Trial: 16

Burst	Number of Pulses	Pulse Width (µsec)	Chirp Width (MHz)	Pulse 1-to-2 Spacing (µsec)	Pulse 2-to-3 Spacing (µsec)	Start Location Within Interval (msec)
1	2	84,1	7	1896		659
2	2	69,1	7	1696		266
3	1	71,7	7			703
4	1	83	20			631
5	2	96,8	11	1232		567
6	2	61,1	11	1241		647
7	1	70,1	5			418
8	2	62,5	19	1144		149
9	2	78,3	13	1703		296
10	2	97,4	15	1728		700
11	3	88,9	17	1759	1060	246
12	3	91	13	1606	1572	468
13	3	76,5	11	1082	1896	231
14	1	64,5	12			182
15	2	60,2	18	1314		311
16	3	90,4	14	1415	1474	705
17						
18						
19						
20						



L C I E

TYPE 5 PARAMETER SHEET

Rohde & Schwarz
K6 Pulse Sequencer

Trial Number : 10

Bursts in Trial: 17

Burst	Number of Pulses	Pulse Width (µsec)	Chirp Width (MHz)	Pulse 1-to-2 Spacing (µsec)	Pulse 2-to-3 Spacing (µsec)	Start Location Within Interval (msec)
1	2	66,2	20	1769		164
2	1	83	8			264
3	2	99,6	18	1270		570
4	3	98,4	14	1283	1283	221
5	3	55,6	13	1939	1733	185
6	2	97,5	20	1492		485
7	1	55,5	17			652
8	3	77,4	5	1637	1876	182
9	1	77,6	15			610
10	2	71,9	15	1457		246
11	3	80	15	1005	1786	413
12	1	65,2	11			118
13	2	92	8	1265		519
14	3	68,6	18	1138	1708	457
15	1	94,3	8			451
16	2	70,7	18	1093		207
17	2	63,4	8	1080		132
18						
19						
20						



L C I E

TYPE 5 PARAMETER SHEET

Rohde & Schwarz
K6 Pulse Sequencer

Trial Number : 11

Bursts in Trial: 18

Burst	Number of Pulses	Pulse Width (µsec)	Chirp Width (MHz)	Pulse 1-to-2 Spacing (µsec)	Pulse 2-to-3 Spacing (µsec)	Start Location Within Interval (msec)
1	2	79,7	5	1563		647
2	2	59,3	19	1693		423
3	2	52,1	13	1625		110
4	1	93,8	19			194
5	2	93	6	1550		97
6	2	87,6	14	1233		448
7	3	62	7	1063	1503	144
8	3	95,4	19	1430	1577	282
9	1	82,8	7			514
10	3	51,2	15	1404	1885	187
11	2	81	8	1554		392
12	3	81,6	5	1254	1055	387
13	2	62,1	14	1006		291
14	2	82	13	1003		435
15	2	60,9	18	1027		508
16	1	58,2	10			230
17	2	80,6	6	1027		468
18	2	65,7	15	1878		279
19						
20						



L C I E

TYPE 5 PARAMETER SHEET

Rohde & Schwarz
K6 Pulse Sequencer

Trial Number : 12

Bursts in Trial: 19

Burst	Number of Pulses	Pulse Width (µsec)	Chirp Width (MHz)	Pulse 1-to-2 Spacing (µsec)	Pulse 2-to-3 Spacing (µsec)	Start Location Within Interval (msec)
1	2	78,6	10	1208		558
2	3	93,2	11	1743	1155	475
3	2	86	13	1719		70
4	1	76,4	13			529
5	1	84,4	10			144
6	1	68,4	5			422
7	2	65,1	11	1250		524
8	2	58,6	13	1372		384
9	3	68,6	15	1499	1321	476
10	3	91,8	13	1201	1475	19
11	3	88,4	7	1274	1510	451
12	2	91,2	20	1331		469
13	3	87,7	11	1356	1716	214
14	3	61,1	13	1718	957	29
15	3	77,1	11	1257	1093	477
16	2	81,7	7	1792		256
17	3	53,6	13	1304	1449	246
18	1	68,2	19			237
19	1	93,8	20			57
20						



L C I E

TYPE 5 PARAMETER SHEET

Rohde & Schwarz
K6 Pulse Sequencer

Trial Number : 13

Bursts in Trial: 20

Burst	Number of Pulses	Pulse Width (µsec)	Chirp Width (MHz)	Pulse 1-to-2 Spacing (µsec)	Pulse 2-to-3 Spacing (µsec)	Start Location Within Interval (msec)
1	2	67,2	11	1581		422
2	2	64,9	13	1929		404
3	2	88,1	10	1131		298
4	2	75,5	18	1884		18
5	3	69,9	9	1348	1175	523
6	2	80,4	9	1074		12
7	2	55	9	1831		4
8	2	70,1	11	988		320
9	3	98,8	17	1502	1211	35
10	3	58,8	12	1019	1687	83
11	2	67,9	8	1268		285
12	1	85,6	7			410
13	2	93,5	19	1574		134
14	3	58,4	10	968	1893	168
15	1	73,8	17			266
16	3	95	19	922	1739	183
17	3	63,6	5	1267	1251	146
18	2	74,8	10	1175		336
19	2	62,9	5	1110		131
20	1	72,8	15			496



L C I E

TYPE 5 PARAMETER SHEET

Rohde & Schwarz
K6 Pulse Sequencer

Trial Number : 14

Bursts in Trial: 8

Burst	Number of Pulses	Pulse Width (µsec)	Chirp Width (MHz)	Pulse 1-to-2 Spacing (µsec)	Pulse 2-to-3 Spacing (µsec)	Start Location Within Interval (msec)
1	3	64,2	19	1609	1360	1089
2	2	88,4	17	1751		1357
3	1	51,1	14			1003
4	3	63,6	15	963	962	1376
5	1	84,3	11			937
6	3	90,7	5	1098	986	1068
7	2	93	20	1130		1124
8	2	67,4	12	1308		574
9						
10						
11						
12						
13						
14						
15						
16						
17						
18						
19						
20						



L C I E

TYPE 5 PARAMETER SHEET

Rohde & Schwarz
K6 Pulse Sequencer

Trial Number : 15

Bursts in Trial: 9

Burst	Number of Pulses	Pulse Width (µsec)	Chirp Width (MHz)	Pulse 1-to-2 Spacing (µsec)	Pulse 2-to-3 Spacing (µsec)	Start Location Within Interval (msec)
1	1	62,3	5			128
2	3	76,5	8	1019	1323	486
3	2	82,5	5	1183		911
4	2	54	10	1805		972
5	3	94,7	18	1565	1079	46
6	3	53,9	19	1625	1139	570
7	3	55,6	13	1623	1927	1143
8	2	68,3	13	1890		1163
9	3	99,8	8	1857	1735	249
10						
11						
12						
13						
14						
15						
16						
17						
18						
19						
20						



L C I E

TYPE 5 PARAMETER SHEET

Rohde & Schwarz
K6 Pulse Sequencer

Trial Number : 16

Bursts in Trial: 10

Burst	Number of Pulses	Pulse Width (µsec)	Chirp Width (MHz)	Pulse 1-to-2 Spacing (µsec)	Pulse 2-to-3 Spacing (µsec)	Start Location Within Interval (msec)
1	2	54,1	5	1152		389
2	2	78,9	13	1150		881
3	1	77,6	13			980
4	1	85,8	14			40
5	3	74,8	15	1596	976	418
6	1	99,2	5			129
7	3	71,5	6	1454	1858	947
8	1	67,5	5			413
9	2	68,7	9	1840		1060
10	3	81,2	13	1604	1132	803
11						
12						
13						
14						
15						
16						
17						
18						
19						
20						



L C I E

TYPE 5 PARAMETER SHEET

Rohde & Schwarz
K6 Pulse Sequencer

Trial Number : 17

Bursts in Trial: 11

Burst	Number of Pulses	Pulse Width (µsec)	Chirp Width (MHz)	Pulse 1-to-2 Spacing (µsec)	Pulse 2-to-3 Spacing (µsec)	Start Location Within Interval (msec)
1	1	78,5	8			441
2	1	60,8	9			62
3	1	96,8	11			942
4	2	65,9	17	1306		1079
5	3	95,3	6	1571	1562	269
6	2	67	17	962		44
7	2	92,9	19	1635		503
8	3	74,3	14	1463	1896	264
9	3	77,7	10	1875	1453	115
10	2	75,1	6	1036		465
11	1	94,8	19			676
12						
13						
14						
15						
16						
17						
18						
19						
20						



L C I E

TYPE 5 PARAMETER SHEET

Rohde & Schwarz
K6 Pulse Sequencer

Trial Number : 18

Bursts in Trial: 12

Burst	Number of Pulses	Pulse Width (µsec)	Chirp Width (MHz)	Pulse 1-to-2 Spacing (µsec)	Pulse 2-to-3 Spacing (µsec)	Start Location Within Interval (msec)
1	2	53,1	8	1042		583
2	2	59,6	13	989		824
3	3	72,4	5	1686	1217	658
4	2	66,6	17	1726		663
5	3	57,3	6	1791	1191	602
6	1	51,9	18			955
7	1	56,1	13			900
8	2	96,1	6	1368		599
9	1	93,4	18			634
10	1	97,3	11			534
11	3	50,5	7	1103	1061	599
12	2	67,1	18	1036		489
13						
14						
15						
16						
17						
18						
19						
20						



L C I E

TYPE 5 PARAMETER SHEET

Rohde & Schwarz
K6 Pulse Sequencer

Trial Number : 19

Bursts in Trial: 8

Burst	Number of Pulses	Pulse Width (µsec)	Chirp Width (MHz)	Pulse 1-to-2 Spacing (µsec)	Pulse 2-to-3 Spacing (µsec)	Start Location Within Interval (msec)
1	2	61,4	18	1761		1229
2	3	69,1	7	1759	1639	1136
3	3	56,5	8	961	1228	508
4	1	87,2	19			993
5	2	96	7	1852		1374
6	3	51,8	15	1295	1517	522
7	3	71,8	17	1651	1422	1394
8	2	54,3	20	1296		952
9						
10						
11						
12						
13						
14						
15						
16						
17						
18						
19						
20						



L C I E

TYPE 5 PARAMETER SHEET

Rohde & Schwarz
K6 Pulse Sequencer

Trial Number : 20

Bursts in Trial: 9

Burst	Number of Pulses	Pulse Width (µsec)	Chirp Width (MHz)	Pulse 1-to-2 Spacing (µsec)	Pulse 2-to-3 Spacing (µsec)	Start Location Within Interval (msec)
1	1	84,5	6			890
2	2	89,4	8	1712		681
3	2	86,5	13	1634		839
4	2	57,4	18	1601		1217
5	2	95,7	5	1062		798
6	3	94,5	5	1745	1189	216
7	2	70,5	12	1385		548
8	2	69,9	11	1924		134
9	2	96	13	1778		692
10						
11						
12						
13						
14						
15						
16						
17						
18						
19						
20						



L C I E

TYPE 5 PARAMETER SHEET

Rohde & Schwarz
K6 Pulse Sequencer

Trial Number : 21

Bursts in Trial: 10

Burst	Number of Pulses	Pulse Width (µsec)	Chirp Width (MHz)	Pulse 1-to-2 Spacing (µsec)	Pulse 2-to-3 Spacing (µsec)	Start Location Within Interval (msec)
1	2	61,1	18	1731		841
2	1	69,6	17			421
3	2	80,5	7	1015		29
4	2	51,3	14	1021		657
5	2	52,7	14	1046		790
6	2	63,3	20	1279		230
7	1	63,9	12			310
8	3	52,2	9	1109	1579	593
9	2	63,6	14	1519		807
10	3	56	17	1375	1076	205
11						
12						
13						
14						
15						
16						
17						
18						
19						
20						



L C I E

TYPE 5 PARAMETER SHEET

Rohde & Schwarz
K6 Pulse Sequencer

Trial Number : 22

Bursts in Trial: 11

Burst	Number of Pulses	Pulse Width (µsec)	Chirp Width (MHz)	Pulse 1-to-2 Spacing (µsec)	Pulse 2-to-3 Spacing (µsec)	Start Location Within Interval (msec)
1	1	85,3	9			517
2	1	60,9	19			1056
3	3	65,2	7	1138	1571	1076
4	3	53,5	8	1862	1214	174
5	2	55,8	13	1101		639
6	2	64,9	7	1630		809
7	2	84,3	19	1556		686
8	2	60,8	13	981		363
9	3	86,7	14	1450	1851	531
10	3	82,4	17	1139	1862	239
11	3	58,1	18	1102	1299	307
12						
13						
14						
15						
16						
17						
18						
19						
20						



L C I E

TYPE 5 PARAMETER SHEET

Rohde & Schwarz
K6 Pulse Sequencer

Trial Number : 23

Bursts in Trial: 12

Burst	Number of Pulses	Pulse Width (µsec)	Chirp Width (MHz)	Pulse 1-to-2 Spacing (µsec)	Pulse 2-to-3 Spacing (µsec)	Start Location Within Interval (msec)
1	1	65,7	8			549
2	1	81,7	6			6
3	2	61,8	5	1257		610
4	2	99,5	7	1559		681
5	2	75,5	20	1196		923
6	2	77,7	15	1495		99
7	2	56	7	1268		285
8	2	78,5	9	1892		142
9	2	96,7	17	1834		977
10	2	85,6	13	1022		478
11	1	88,1	19			212
12	2	86,8	17	1007		483
13						
14						
15						
16						
17						
18						
19						
20						



L C I E

TYPE 5 PARAMETER SHEET

Rohde & Schwarz
K6 Pulse Sequencer

Trial Number : 24

Bursts in Trial: 13

Burst	Number of Pulses	Pulse Width (µsec)	Chirp Width (MHz)	Pulse 1-to-2 Spacing (µsec)	Pulse 2-to-3 Spacing (µsec)	Start Location Within Interval (msec)
1	1	79,5	20			383
2	3	88,7	20	1519	1294	340
3	2	64,6	5	1619		597
4	2	65,1	17	1365		367
5	2	56,2	20	1095		229
6	3	50,7	11	1637	1159	633
7	3	87,7	14	944	1559	719
8	3	65,6	9	1644	1834	745
9	2	81,4	13	1455		898
10	1	90,7	15			382
11	2	85,6	9	1419		461
12	2	88,3	17	1801		103
13	2	59	14	1701		698
14						
15						
16						
17						
18						
19						
20						



L C I E

TYPE 5 PARAMETER SHEET

Rohde & Schwarz
K6 Pulse Sequencer

Trial Number : 25

Bursts in Trial: 14

Burst	Number of Pulses	Pulse Width (µsec)	Chirp Width (MHz)	Pulse 1-to-2 Spacing (µsec)	Pulse 2-to-3 Spacing (µsec)	Start Location Within Interval (msec)
1	2	90,3	20	1361		325
2	2	63,8	10	1434		802
3	1	68,6	5			129
4	1	69,6	13			410
5	3	75,2	13	1208	1604	189
6	2	82,1	18	1766		131
7	2	92,5	18	1688		91
8	2	65,1	17	1648		822
9	3	99,6	18	1235	1393	742
10	2	81,9	18	1280		705
11	2	82,3	12	1255		849
12	1	94,3	5			19
13	2	55,9	15	1784		741
14	3	83,1	15	1226	1329	205
15						
16						
17						
18						
19						
20						



L C I E

TYPE 5 PARAMETER SHEET

Rohde & Schwarz
K6 Pulse Sequencer

Trial Number : 26

Bursts in Trial: 15

Burst	Number of Pulses	Pulse Width (µsec)	Chirp Width (MHz)	Pulse 1-to-2 Spacing (µsec)	Pulse 2-to-3 Spacing (µsec)	Start Location Within Interval (msec)
1	3	87,6	9	1547	1025	642
2	2	82,5	10	1377		607
3	3	56,5	9	1437	994	231
4	2	99	6	1240		478
5	1	79,6	5			695
6	2	87,7	18	1830		633
7	3	60,5	18	1504	1118	258
8	3	97,1	18	1587	1144	394
9	3	79,3	14	1071	1272	450
10	1	56,6	7			322
11	2	93,2	19	967		6
12	2	85,7	5	1861		603
13	2	90	8	1177		109
14	2	67	20	1690		441
15	2	90,9	9	1469		138
16						
17						
18						
19						
20						



L C I E

TYPE 5 PARAMETER SHEET

Rohde & Schwarz
K6 Pulse Sequencer

Trial Number : 27

Bursts in Trial: 16

Burst	Number of Pulses	Pulse Width (µsec)	Chirp Width (MHz)	Pulse 1-to-2 Spacing (µsec)	Pulse 2-to-3 Spacing (µsec)	Start Location Within Interval (msec)
1	2	80,7	5	1043		405
2	3	61,7	9	1412	1823	24
3	1	63,1	9			261
4	2	67	5	1819		532
5	1	58,3	13			172
6	1	71,3	12			40
7	2	94,2	10	1776		347
8	2	75,3	12	1395		397
9	2	91,3	11	1908		163
10	3	66,5	14	1133	1814	711
11	2	68	13	1780		518
12	3	72,4	6	1796	1266	180
13	3	98,4	14	955	1835	64
14	2	81	6	1065		635
15	2	57,2	18	1274		676
16	2	99,1	18	1873		740
17						
18						
19						
20						



L C I E

TYPE 5 PARAMETER SHEET

Rohde & Schwarz
K6 Pulse Sequencer

Trial Number : 28

Bursts in Trial: 17

Burst	Number of Pulses	Pulse Width (µsec)	Chirp Width (MHz)	Pulse 1-to-2 Spacing (µsec)	Pulse 2-to-3 Spacing (µsec)	Start Location Within Interval (msec)
1	3	78,2	15	1832	1762	213
2	2	66,4	8	1589		177
3	2	79,5	5	1417		52
4	3	71	13	1906	1049	75
5	1	85,5	9			515
6	2	56,2	14	1332		209
7	2	82,3	12	1444		296
8	2	55,9	18	1519		49
9	2	73,5	6	1892		371
10	1	94,9	10			184
11	3	59,7	13	974	1059	240
12	1	84	20			593
13	2	87,4	9	1647		77
14	1	97,5	13			567
15	2	74,8	7	1235		518
16	2	90	19	1543		266
17	2	53,9	9	1207		557
18						
19						
20						



L C I E

TYPE 5 PARAMETER SHEET

Rohde & Schwarz
K6 Pulse Sequencer

Trial Number : 29

Bursts in Trial: 18

Burst	Number of Pulses	Pulse Width (µsec)	Chirp Width (MHz)	Pulse 1-to-2 Spacing (µsec)	Pulse 2-to-3 Spacing (µsec)	Start Location Within Interval (msec)
1	2	68,2	13	1691		590
2	3	84,7	6	1099	1764	138
3	3	52,7	13	1147	1362	205
4	2	52,5	15	1254		96
5	2	87,6	8	1432		346
6	3	99,6	17	1038	1096	435
7	1	55,1	12			471
8	1	91,7	10			315
9	2	86,6	9	1755		225
10	2	76,2	13	1067		200
11	3	70,3	20	1773	1044	612
12	2	79,5	11	1328		6
13	2	73,8	5	1213		61
14	1	93,8	10			657
15	3	98,9	20	1284	1416	297
16	3	85,5	8	1732	1580	54
17	2	65,2	19	1483		368
18	1	74	20			297
19						
20						



L C I E

TYPE 5 PARAMETER SHEET

Rohde & Schwarz
K6 Pulse Sequencer

Trial Number : 30

Bursts in Trial: 19

Burst	Number of Pulses	Pulse Width (µsec)	Chirp Width (MHz)	Pulse 1-to-2 Spacing (µsec)	Pulse 2-to-3 Spacing (µsec)	Start Location Within Interval (msec)
1	3	92,9	13	1390	1002	447
2	2	89,7	11	979		5
3	3	59,1	13	1015	1601	394
4	2	66,4	17	1571		415
5	1	81,2	18			172
6	3	52,3	17	1727	1599	460
7	2	95,1	19	1074		366
8	3	55,3	7	975	1524	92
9	2	70,2	14	1322		193
10	3	78,9	13	1252	1503	235
11	1	54	7			171
12	2	81,3	20	1439		67
13	2	77,2	13	1747		520
14	3	78,3	20	1714	1589	317
15	2	75,6	15	1838		199
16	2	87,3	7	1050		319
17	1	97,8	17			377
18	3	76,3	17	1183	952	557
19	3	66,4	9	1031	1586	608
20						

TYPE 0

Pulses per Burst	Pulse Width (µsec)	PRI (µs)
18	1	1428

12. UNCERTAINTIES CHART

47 CFR Part 15.209 & 15.207 Kind of test	Wide uncertainty laboratory (k=2) ±x(dB) / (Hz)/ ms	Uncertainty limit
Measurement of conducted disturbances in voltage on the AC power port (9 kHz – 150 kHz)	2,67	3.8
Measurement of conducted disturbances in voltage on the AC power port (150 kHz – 30 MHz)	2,67	3.4
Measurement of conducted disturbances in voltage on the telecommunication port. (AAN)	3,67	5.0
Measurement of conducted disturbances in current (current clamp)	2,73	2.9
Measurement of disturbance power	2,67	4.5
Measurement of radiated magnetic field from 10kHz to 30MHz in SAC V01	4,48	/
Measurement of radiated magnetic field from 10kHz to 30MHz in SAC C01	4,48	/
Measurement of radiated electric field from 30 to 1000MHz in horizontal position on the OATS (Ecuellas)	4,88	6.3
Measurement of radiated electric field from 1 to 18GHz on the Ecuellas site	5.16	/
Measurement of radiated electric field from 30 to 1000MHz in vertical position on the OATS (Ecuellas)	4,99	6.3
Measurement of radiated electric field from 30 to 1000MHz in horizontal position in SAC C01	5,08	6.3
Measurement of radiated electric field from 30 to 1000MHz in vertical position in SAC C01	5,16	6.3
Measurement of radiated electric field from 30 to 1000MHz in horizontal position in SAC V01	5,08	6.3
Measurement of radiated electric field from 30 to 1000MHz in vertical position in SAC V01	5,15	6.3
Measurement of radiated electric field from 1 to 6 GHz C01	5,1	5.2
Measurement of radiated electric field from 1 to 6 GHz V01	4,85	5.2
Measurement of radiated magnetic field from 10kHz to 30MHz on the OATS (Ecuellas)	4,48	/

The uncertainty values calculated by the laboratory are lower than limit uncertainty values defined by the CISPR. The conformity of the sample is directly established by the applicable limits values. This table includes all uncertainties maximum feasible for testing in the laboratory, whether or not made in this report