





FCC PART 15D  
MEASUREMENT AND TEST REPORT

For

**Sagemcom SAS**

250 route de l'Empereur 92848 RUEIL-MALMAISON France

**FCC ID: VW3D680C**

<b>Report Type:</b> Original Report	<b>Product Type:</b> DECT Phone (Handset Unit)
<b>Test Engineer:</b> Sula Huang	
<b>Report Number:</b> RSZ130709001-00PP	
<b>Report Date:</b> 2013-09-17	
<b>Reviewed By:</b> RF Leader	Alvin Huang 
<b>Prepared By:</b>	Bay Area Compliance Laboratories Corp. (Shenzhen) 6/F, the 3rd Phase of WanLi Industrial Building ShiHua Road, FuTian Free Trade Zone Shenzhen, Guangdong, China Tel: +86-755-33320018 Fax: +86-755-33320008 <a href="http://www.baclcorp.com.cn">www.baclcorp.com.cn</a>

**Note:** This test report is prepared for the customer shown above and for the equipment described herein. It may not be duplicated or used in part without prior written consent from Bay Area Compliance Laboratories Corp. This report **must not** be used by the customer to claim product certification, approval, or endorsement by NVLAP\*, or any agency of the Federal Government.

## TABLE OF CONTENTS

<b>GENERAL INFORMATION.....</b>	<b>4</b>
PRODUCT DESCRIPTION FOR EQUIPMENT UNDER TEST (EUT).....	4
OBJECTIVE.....	4
RELATED SUBMITTAL(S)/GRANT(S).....	4
TEST METHODOLOGY.....	4
TEST FACILITY.....	5
<b>SYSTEM TEST CONFIGURATION.....</b>	<b>6</b>
DESCRIPTION OF TEST CONFIGURATION.....	6
EQUIPMENT MODIFICATIONS.....	6
LOCAL SUPPORT EQUIPMENT LIST AND DETAILS.....	6
BLOCK DIAGRAM OF TEST SETUP.....	6
<b>SUMMARY OF TEST RESULTS.....</b>	<b>7</b>
<b>FCC §15. 319 (I) &amp; §2.1093 - RF EXPOSURE.....</b>	<b>8</b>
APPLICABLE STANDARD.....	8
<b>FCC§15.317&amp;§15.203 - ANTENNA REQUIREMENT.....</b>	<b>9</b>
APPLICABLE STANDARD.....	9
ANTENNA CONNECTOR CONSTRUCTION.....	9
<b>FCC§15.323 (A) - EMISSION BANDWIDTH.....</b>	<b>10</b>
APPLICABLE STANDARD.....	10
TEST PROCEDURE.....	10
TEST EQUIPMENT LIST AND DETAILS.....	10
TEST DATA.....	11
<b>FCC§15.319 (C) - PEAK TRANSMIT POWER.....</b>	<b>13</b>
APPLICABLE STANDARD.....	13
TEST PROCEDURE.....	13
TEST EQUIPMENT LIST AND DETAILS.....	13
TEST DATA.....	14
<b>FCC§15.319 (D) - POWER SPECTRAL DENSITY.....</b>	<b>16</b>
APPLICABLE STANDARD.....	16
TEST PROCEDURE.....	16
TEST EQUIPMENT LIST AND DETAILS.....	16
TEST DATA.....	16
<b>FCC§15.323 (D) - EMISSION INSIDE AND OUTSIDE THE SUB-BAND.....</b>	<b>21</b>
APPLICABLE STANDARD.....	21
TEST PROCEDURE.....	21
TEST EQUIPMENT LIST AND DETAILS.....	21
TEST DATA.....	21
<b>FCC§15.319 (G) - RADIATED EMISSIONS.....</b>	<b>30</b>
APPLICABLE STANDARD.....	30
MEASUREMENT UNCERTAINTY.....	30
EUT SETUP.....	30
EMI TEST RECEIVER & SPECTRUM ANALYZER SETUP.....	31
TEST PROCEDURE.....	31

---

---

TEST EQUIPMENT LIST AND DETAILS.....	31
CORRECTED AMPLITUDE & MARGIN CALCULATION .....	31
TEST RESULTS SUMMARY .....	32
TEST DATA .....	32
<b>FCC§15.323 (F) - FREQUENCY STABILITY.....</b>	<b>36</b>
APPLICABLE STANDARD .....	36
TEST PROCEDURE .....	36
TEST EQUIPMENT LIST AND DETAILS.....	36
TEST DATA .....	37
<b>FCC§15.323 (C) (E) &amp; §15.319(F) – SPECIFIC REQUIREMENTS FOR UPCS DEVICE.....</b>	<b>38</b>
<b>PRODUCT SIMILARITY DECLARATION LETTER.....</b>	<b>43</b>

## GENERAL INFORMATION

---

### Product Description for Equipment under Test (EUT)

The Sagemcom SAS's product, model number: D680C (FCC ID: VW3D680C) (the "EUT") in this report was a handset unit of DECT Phone, which was measured approximately: 15.4 cm (L) x 5.0 cm (W) x 3.0 cm (H), rated with input voltage: DC 2\*1.2V rechargeable NI-MH battery.

*Note: The series product, model D680C, D680C Solo, D680C Duo and D680C handset, they share the same product only named differently due to different combination per client's request. Model D680C was selected for testing, the detailed information can be referred to the attached declaration letter that stated and guaranteed by the applicant.*

*\* All measurement and test data in this report was gathered from production sample serial number: PO13100C9C00001 (Assigned by Applicant). The EUT supplied by the applicant was received on 2013-07-09.*

### Objective

This test report was based on the Electromagnetic Interference (EMI) tests performed on the EUT. The EMI measurements were performed according to the measurement procedure described in ANSI C63.17 - 2006 and ANSI C63.4-2009.

The tests were performed in order to determine the compliance of the EUT with FCC Part 15-Subpart D, section 15.203, 15.315, 15.317, 15.319 and 15.323 rules.

### Related Submittal(s)/Grant(s)

FCC part 15D base unit submission with FCC ID: VW3D680C.

### Test Methodology

All measurements contained in this report were conducted with ANSI C63.17 - 2006, American National Standard for Methods of Measurement of Radio-Noise Emissions from Low-Voltage Electrical and Electronic Equipment in the range of 9 kHz to 40 GHz. All radiated and conducted emissions measurement was performed at Bay Area Compliance Laboratories Corp. (Shenzhen).

The radiated testing was performed at an antenna-to-EUT distance of 3 meters.

Measurement uncertainty with radiated emission is 5.91 dB for 30MHz-1GHz and 4.92 dB for above 1GHz, 1.95dB for conducted measurement.

## Test Facility

The Test site used by Bay Area Compliance Laboratories Corp. (Shenzhen) to collect test data is located on the 6/F, the 3rd Phase of WanLi Industrial Building, ShiHua Road, FuTian Free Trade Zone Shenzhen, Guangdong, China.

Test site at Bay Area Compliance Laboratories Corp. (Shenzhen) has been fully described in reports submitted to the Federal Communication Commission (FCC). The details of these reports have been found to be in compliance with the requirements of Section 2.948 of the FCC Rules on December 06, 2010. The facility also complies with the radiated and AC line conducted test site criteria set forth in ANSI C63.4-2009.

The Federal Communications Commission has the reports on file and is listed under FCC Registration No.: 382179. The test site has been approved by the FCC for public use and is listed in the FCC Public Access Link (PAL) database.

Additionally, Bay Area Compliance Laboratories Corp. (Shenzhen) is an ISO/IEC 17025 accredited laboratory, and is accredited by National Voluntary Laboratory Accredited Program (Lab Code 200707-0).



The current scope of accreditations can be found at <http://ts.nist.gov/Standards/scopes/2007070.htm>.

## SYSTEM TEST CONFIGURATION

### Description of Test Configuration

The system was configured for testing in TBR6 mode which is provided by the manufacturer.

### Equipment Modifications

No modification was made to the EUT tested.

### Local Support Equipment List and Details

Manufacturer	Description	Model	Serial Number
R&S	Digital Radio-Communication Tester	CMD60	829902/026

### Block Diagram of Test Setup

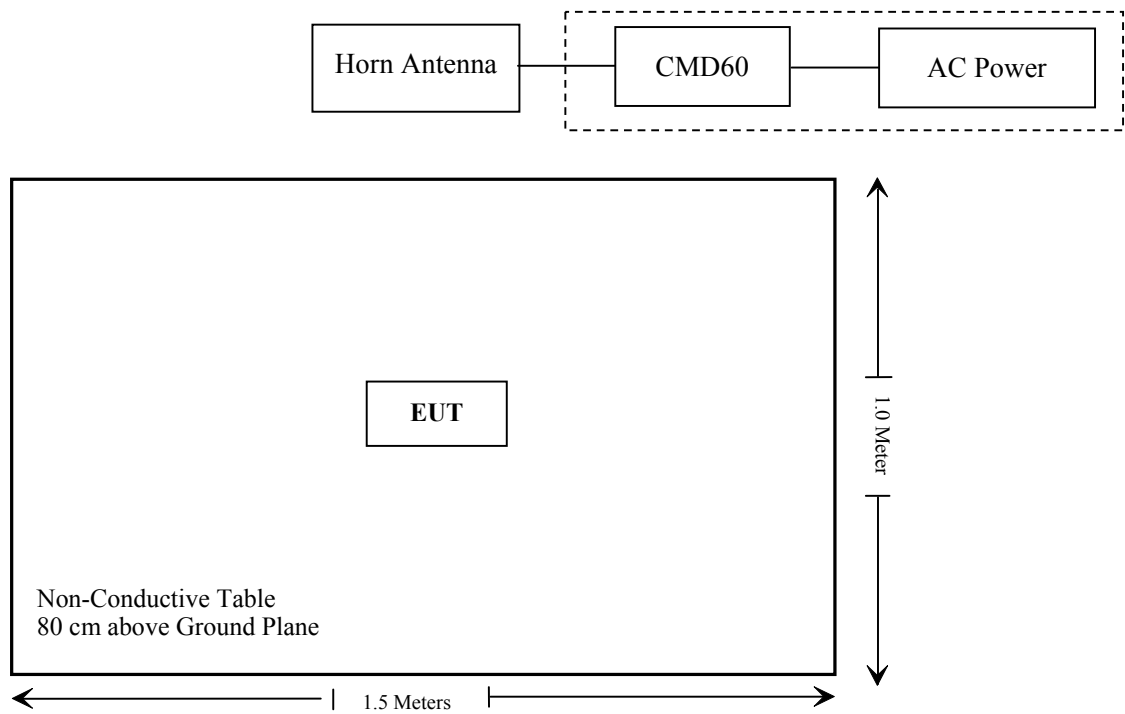

## SUMMARY OF TEST RESULTS

FCC Rules	Description of Test	Result
§ 15.319 (i)&2.1093	RF Exposure	Compliance
§ 15.317 § 15.203	Antenna Requirement	Compliance
§ 15.315 § 15.207	Conducted Emission	Not Applicable
§ 15.323 (a)	Emission Bandwidth	Compliance
§ 15.319 (c)	Peak Transmit Power	Compliance
§ 15.319 (d)	Power Spectral Density	Compliance
§ 15.323 (d)	Emission Inside and Outside the sub-band	Compliance
§ 15.319 (g)	Radiated Emission	Compliance
§ 15.323 (f)	Frequency Stability Handset	Compliance
§ 15.323 (c)(e) § 15.319 (f)	Specific Requirements for UPCS	Compliance

Note: The EUT is powered by battery only, so conducted emission test is not required.

---

## **FCC §15. 319 (i) & §2.1093 - RF EXPOSURE**

---

### **Applicable Standard**

According to FCC Part 15.319 (i), Unlicensed PCS devices are subject to the radiofrequency radiation exposure requirements specified in §1.1307(b) and 2.1093 of this chapter, as appropriate. All equipment shall be considered to operate in a “general population/uncontrolled” environment. Applications for equipment authorization of devices operating under this section must contain a statement confirming compliance with these requirements for both fundamental emissions and unwanted emissions. Technical information showing the basis for this statement must be submitted to the Commission upon request.

### **Result:**

Please refer to SAR test report RSZ130709001-20.



---

## **FCC§15.317&§15.203 - ANTENNA REQUIREMENT**

---

### **Applicable Standard**

According to FCC § 15.203, an intentional radiator shall be designed to ensure that no antenna other than that furnished by the responsible party shall be used with the device. The use of a permanently attached antenna or of an antenna that uses a unique coupling to the intentional radiator shall be considered sufficient to comply with the provisions of this Section. The manufacturer may design the unit so that a broken antenna can be replaced by the user, but the use of a standard antenna jack or electrical connector is prohibited.

### **Antenna Connector Construction**

The EUT has one integrated antenna arrangement, which was permanently attached and the gain was 0 dBi, fulfill the requirement of this section. Please refer to the internal photos.

**Result:** Compliant.

## FCC§15.323 (a) - EMISSION BANDWIDTH

### Applicable Standard

Operation shall be contained within the 1920–1930 MHz band. The emission bandwidth shall be less than 2.5 MHz and greater than 50 kHz.

The emission bandwidth is measured in accordance with ANSI C63.17 sub-clause 6.1.3 using the setup below:

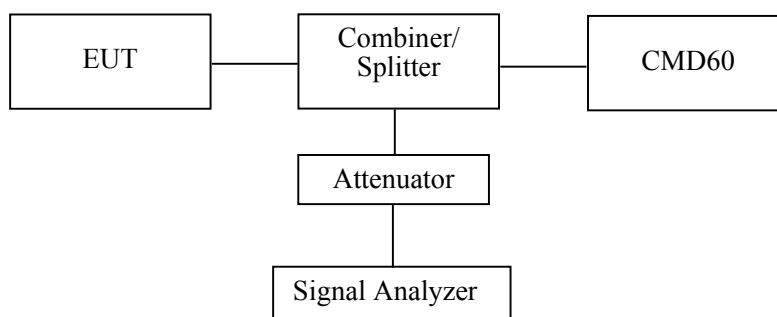

The width, in Hz, of the signal between two points, one below the carrier center frequency and one above the carrier center frequency, that is 26 dB down relative to the maximum level of the modulated carrier. It is based on the use of measurement instrumentation employing a peak detector function with an instrument resolution bandwidth approximately equal to 1% of the emission band-width of the device under measurement. [Extraction from 47 CFR 15, subpart D, 15.303 (C)].

### Test Procedure

Using the manufacturer’s information on occupied bandwidth set the spectrum analyzer as follows:

Resolution bandwidth	1.0% of the emission bandwidth (as close as possible)
Video bandwidth	>3 times the resolution bandwidth
Number of sweeps	sufficient to stability the trace
Detection mode	peak detection with maximum hold

### Test Equipment List and Details

Manufacturer	Description	Model	Serial Number	Calibration Date	Calibration Due Date
BIZI	Signal Analyzer	FSIQ26	8386001028	2012-11-24	2013-11-23

\* **Statement of Traceability:** Bay Area Compliance Laboratories Corp. (Shenzhen) attests that all calibrations have been performed in accordance to NVLAP requirements, traceable to National Primary Standards and International System of Units (SI).

**Test Data**

**Environmental Conditions**

<b>Temperature:</b>	25°C
<b>Relative Humidity:</b>	54%
<b>ATM Pressure:</b>	101.0 kPa

The testing was performed by Sula Huang on 2013-07-13.

Test mode: Transmitting

Channel	Center Frequency (MHz)	26 dB Emission Bandwidth (MHz)	Limit
4	1921.536	1.467	50 kHz < OBW < 2.5 MHz
2	1924.992	1.467	50 kHz < OBW < 2.5 MHz
0	1928.448	1.467	50 kHz < OBW < 2.5 MHz

**Test Result:** Compliance. Please refer to the attached plots.

**Channel 4**

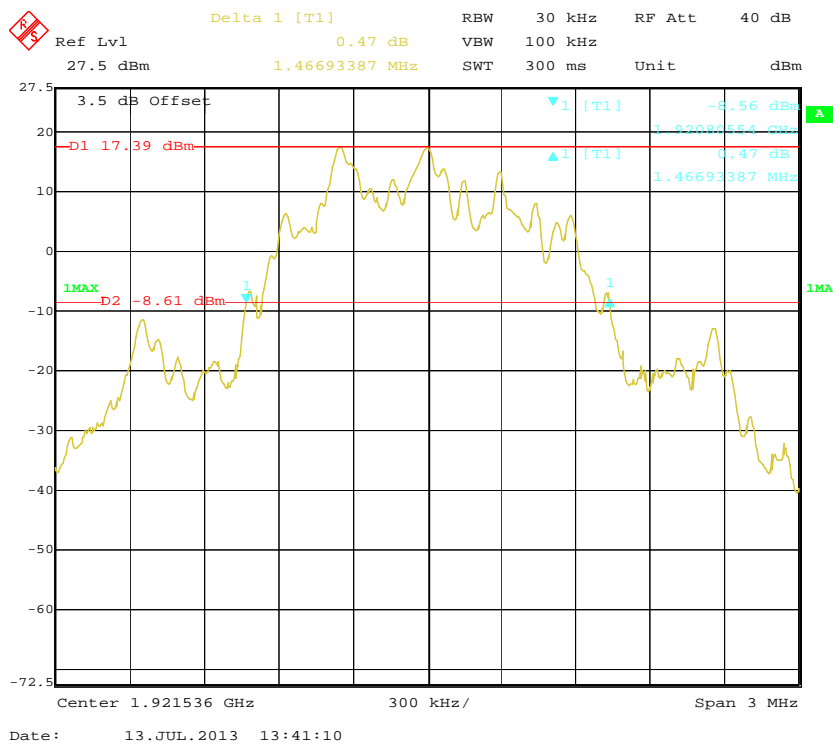

### Channel 2

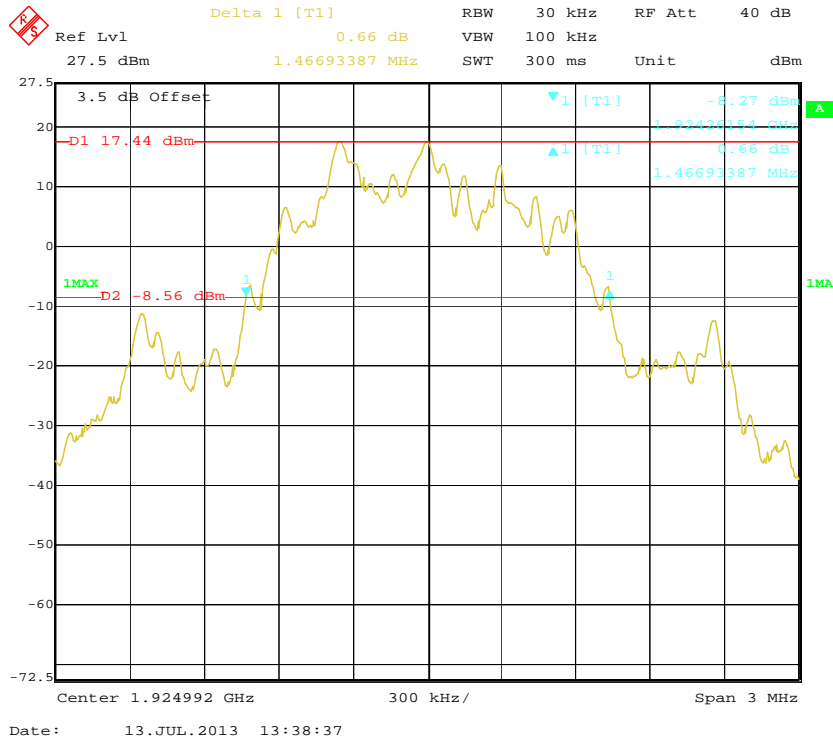

### Channel 0

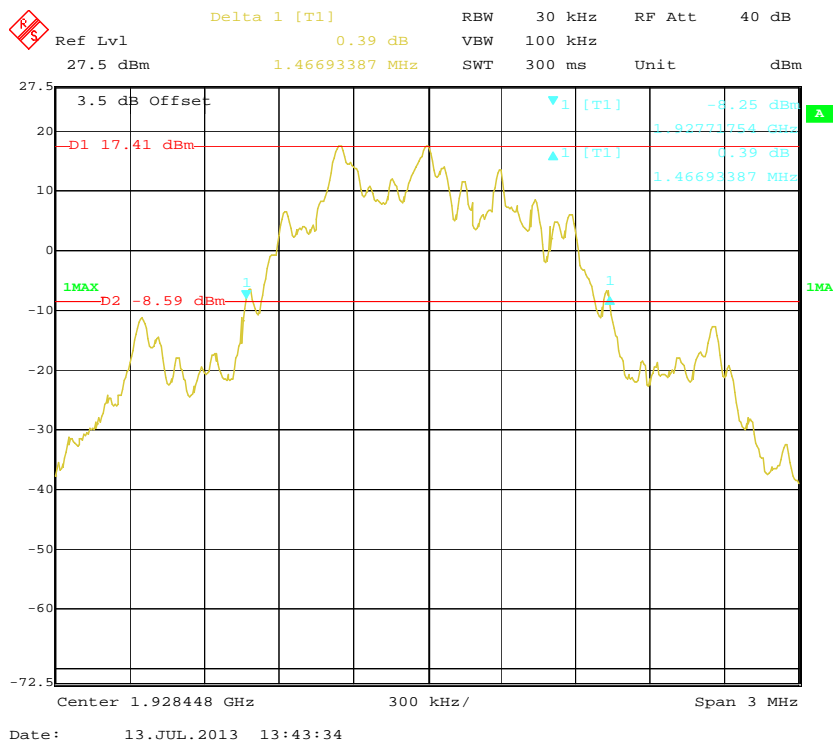

## FCC§15.319 (c) - PEAK TRANSMIT POWER

### Applicable Standard

The peak power output as measured over an interval of time equal to the frame rate or transmission burst of the device under all conditions of modulation. Usually this parameter is measured as a conducted emission by direct connection of a calibrated test instrument to the equipment under test. If the device cannot be connected directly, alternative techniques acceptable to the Commission may be used [47 CFR 15, subpart D, 15.303].

The peak transmit power is according to ANSI C63.17-2006 §6.1.2

Per FCC Part 15.319 (c) Peak transmit power shall not exceed 100 microwatts multiplied by the square root of the emission bandwidth in hertz. Peak transmit power must be measured over any interval of continuous transmission using instrumentation calibrated in terms of an rms-equivalent voltage. The measurement results shall be properly adjusted for any instrument limitations, such as detector response times, limited resolution bandwidth capability when compared to the emission bandwidth, sensitivity, etc., so as to obtain a true peak measurement for the emission in question over the full bandwidth of the channel.

Calculation of Peak Transmit Power Limit:

$$\text{Peak Transmit Power Limit} = 100\mu\text{W} \times (\text{EBW})^{1/2}$$

EBW is the transmit emission bandwidth in Hz determined in the other test item:

### Test Procedure

Using the manufacturer's information on occupied bandwidth set the spectrum analyzer as follows:

RBW	≥ Emission bandwidth
Video bandwidth	≥ RBW
Span	Zero
Center frequency	Nominal center frequency of channels
Amplitude scale	Log (linear may be used if analyzer has sufficient linear dynamic range and accuracy)
Detection	Peak detection
Trigger	Video
Sweep rate	Sufficiently rapid to permit the transmit pulse to be resolved accurately

### Test Equipment List and Details

Manufacturer	Description	Model	Serial Number	Calibration Date	Calibration Due Date
BIZI	Signal Analyzer	FSIQ26	8386001028	2012-11-24	2013-11-23

\* **Statement of Traceability:** Bay Area Compliance Laboratories Corp. (Shenzhen) attests that all calibrations have been performed in accordance to NVLAP requirements, traceable to National Primary Standards and International System of Units (SI).

**Test Data**

**Environmental Conditions**

<b>Temperature:</b>	25°C
<b>Relative Humidity:</b>	54%
<b>ATM Pressure:</b>	101.0 kPa

The testing was performed by Sula Huang on 2013-07-13.

Test Result: Compliance. Please refer to the following plots.

Channel	Frequency (MHz)	Peak Transmit Power (dBm)	Limit (dBm)
4	1921.536	18.96	20.83
2	1924.992	18.98	20.83
0	1928.448	18.98	20.83

EBW = 1467000 Hz,  $P_{max} = 100 \mu W \times (1467000)^{1/2} = 20.83 \text{ dBm}$

**Channel 4**

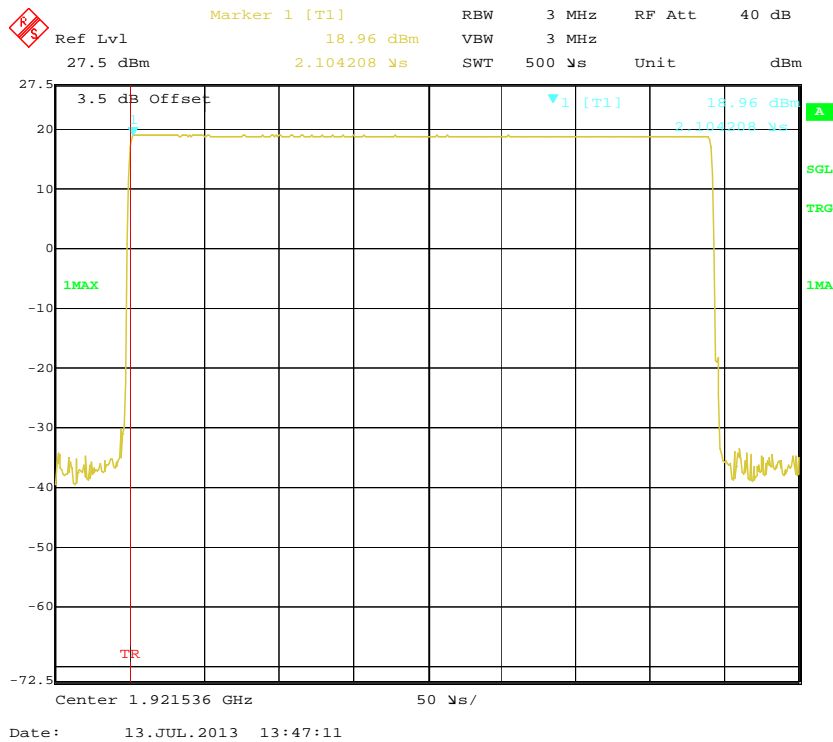

### Channel 2

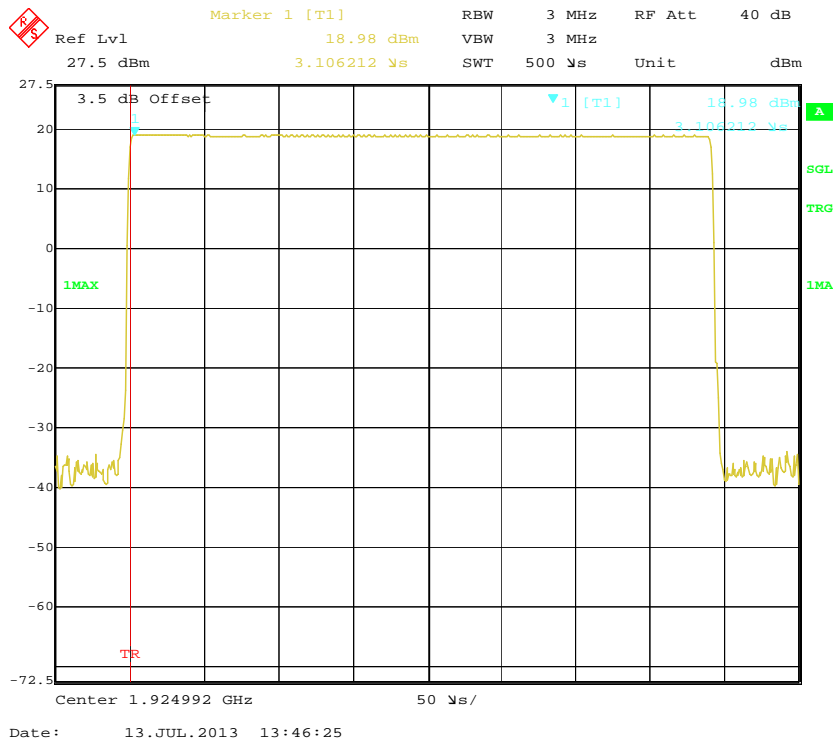

### Channel 0

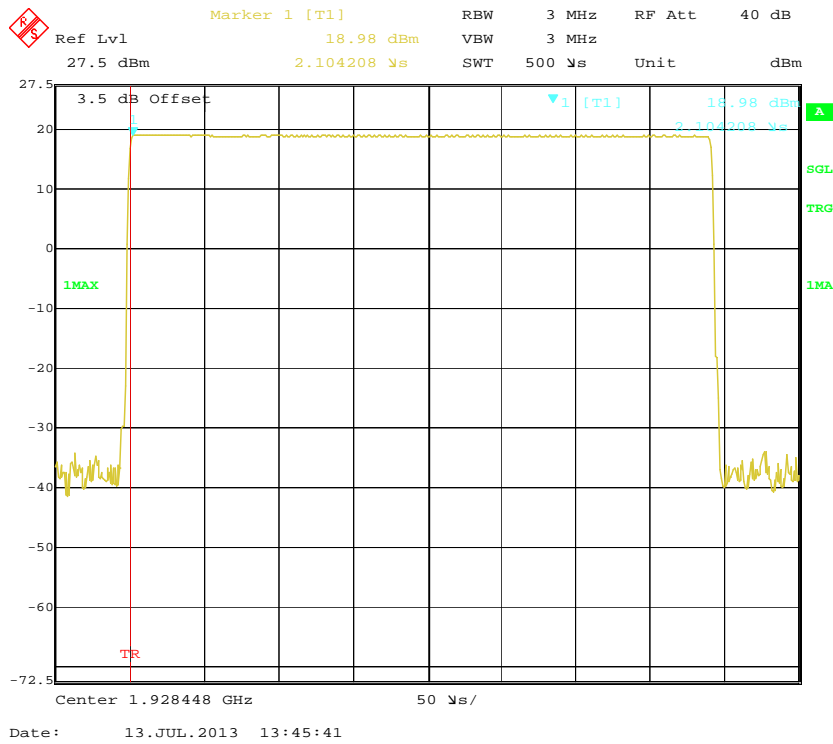

## FCC§15.319 (d) - POWER SPECTRAL DENSITY

### Applicable Standard

The average pulse energy in a 3 kHz bandwidth is divided by the pulse duration.

The power spectral density shall not exceed 3mW in any 3 kHz bandwidth as measured with a spectrum analyzer having a resolution bandwidth of 3 kHz.

The power spectral density is measured in accordance with ANSI C63.17.2006 Clause 6.1.5.

### Test Procedure

Using the manufacturer's information on occupied bandwidth set the spectrum analyzer as follows:

RBW	3 kHz
Video bandwidth	$\geq 3 \times \text{RBW}$
Span	Zero span at frequency with the maximum level (frequency determined in 6.1.3 if the same type of signal (continuous versus burst) was used in 6.1.3)
Center frequency	Spectral peak as determined in 6.1.3
Sweep time	For burst signals, sufficient to include essentially all of the maximum length burst at the output of a 3 kHz filter (e.g., maximum input burst duration plus 600 $\mu\text{s}$ ). For continuous signals, 20 ms.
Amplitude scale	Log power
Detection	Sample detection and averaged for a minimum of 100 sweeps
Trigger	External or internal

### Test Equipment List and Details

Manufacturer	Description	Model	Serial Number	Calibration Date	Calibration Due Date
Rohde & Schwarz	EMI Test Receiver	ESCI	101122	2013-05-09	2014-05-09

\* **Statement of Traceability:** Bay Area Compliance Laboratories Corp. (Shenzhen) attests that all calibrations have been performed in accordance to NVLAP requirements, traceable to National Primary Standards and International System of Units (SI).

### Test Data

#### Environmental Conditions

Temperature:	25°C
Relative Humidity:	54%
ATM Pressure:	101.0 kPa

*The testing was performed by Sula Huang on 2013-07-13.*

*Test mode: Transmitting*



Test Result: Compliance. Please refer to following tables and plots

Channel	Frequency (MHz)	Power Spectral Density		Limit (mW/3kHz)	Result
		(dBm/3kHz)	(mW/3kHz)		
4	1921.536	-2.28	0.592	3	Pass
2	1924.992	-2.25	0.596	3	Pass
0	1928.448	-2.56	0.555	3	Pass

Channel 4

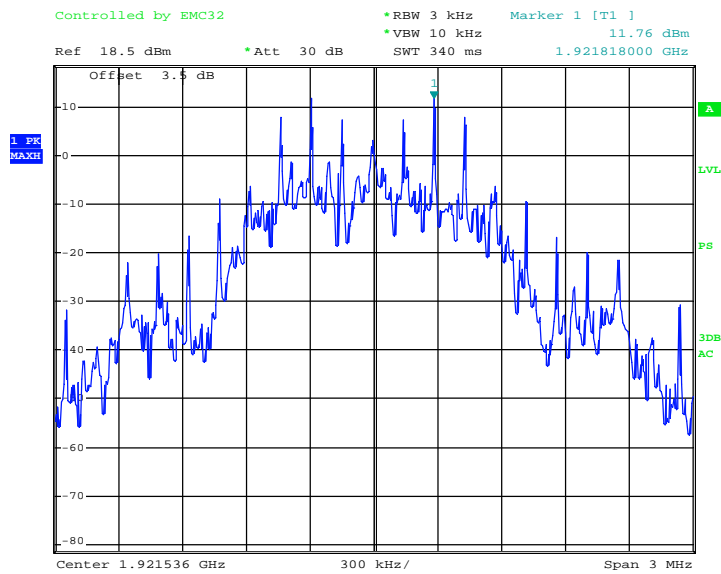

EUT  
Date: 13.JUL.2013 08:03:09

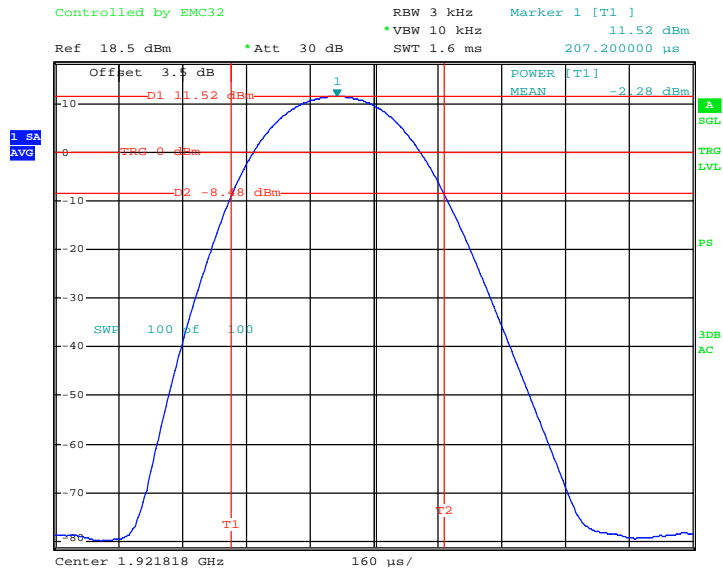

EUT

Date: 13.JUL.2013 08:04:31

### Channel 2

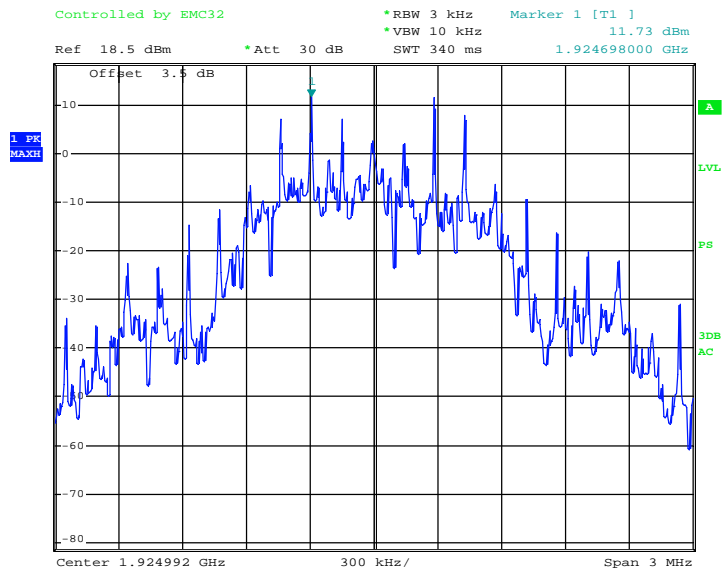

EUT

Date: 13.JUL.2013 07:59:04

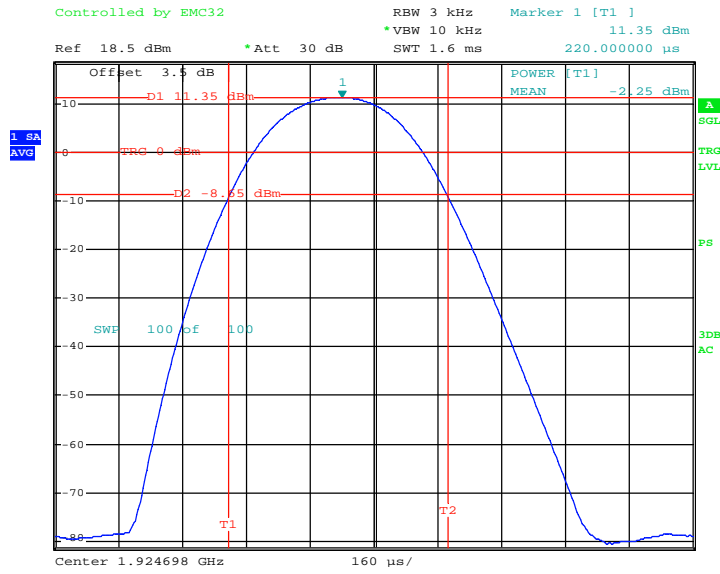

EUT

Date: 13.JUL.2013 08:01:10

### Channel 0

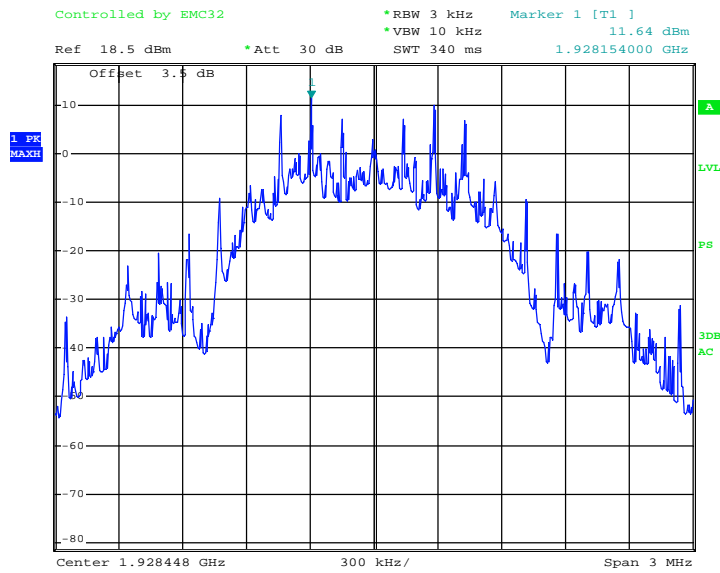

EUT

Date: 13.JUL.2013 07:53:53

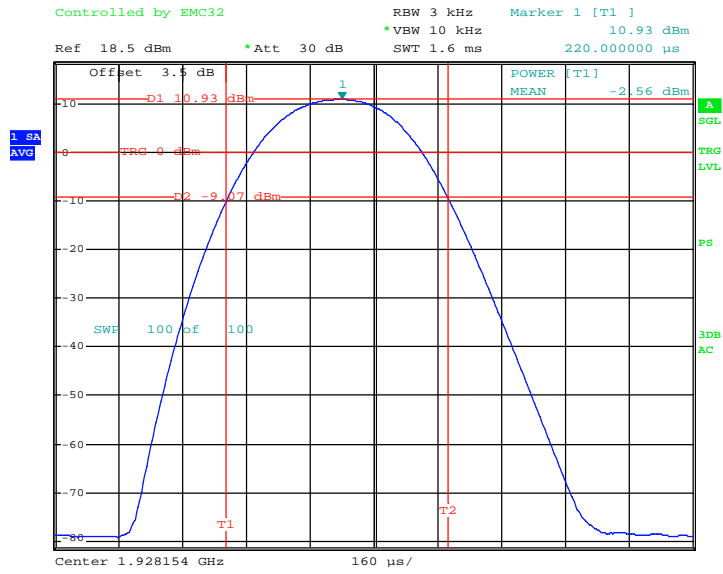

EUT

Date: 13.JUL.2013 07:56:43

## **FCC§15.323 (d) - EMISSION INSIDE AND OUTSIDE THE SUB-BAND**

### **Applicable Standard**

Emissions inside the sub-band must comply with the following emission mask:

1. In the bands between 1B and 2B measured from the center of the emission bandwidth the total power emitted by the device shall be at least 30 dB below the transmit power permitted for that device;
2. in the bands between 2B and 3B measured from the center of the emission bandwidth the total power emitted by an intentional radiator shall be at least 50 dB below the transmit power permitted for that radiator;
3. in the bands between 3B and the sub-band edge the total power emitted by an intentional radiator in the measurement bandwidth shall be at least 60 dB below the transmit power permitted for that radiator.

Where B = emission bandwidth

Emission Outside the sub-band shall be attenuated below a reference power of 112 mW (20.5 dBm) as follows:

1. 30 dB between the sub-band and 1.25 MHz above or below the sub-band;
2. 50 dB between 1.25 and 2.5 MHz above or below the sub-band;
3. 60 dB at 2.5 MHz or greater above or below the sub-band.

### **Test Procedure**

According to ANSI C63.17.2006 Clause 6.1.6.

### **Test Equipment List and Details**

Manufacturer	Description	Model	Serial Number	Calibration Date	Calibration Due Date
BIZI	Signal Analyzer	FSIQ26	8386001028	2012-11-24	2013-11-23

\* **Statement of Traceability:** Bay Area Compliance Laboratories Corp. (Shenzhen) attests that all calibrations have been performed in accordance to NVLAP requirements, traceable to National Primary Standards and International System of Units (SI).

### **Test Data**

#### **Environmental Conditions**

<b>Temperature:</b>	25°C
<b>Relative Humidity:</b>	54%
<b>ATM Pressure:</b>	101.0 kPa

*The testing was performed by Sula Huang on 2013-07-13.*

*Test mode: Transmitting*

*Test Result: Compliance. Please refer to following tables and plots*

### Channel 4 (Unwanted Emission inside the Sub-band)

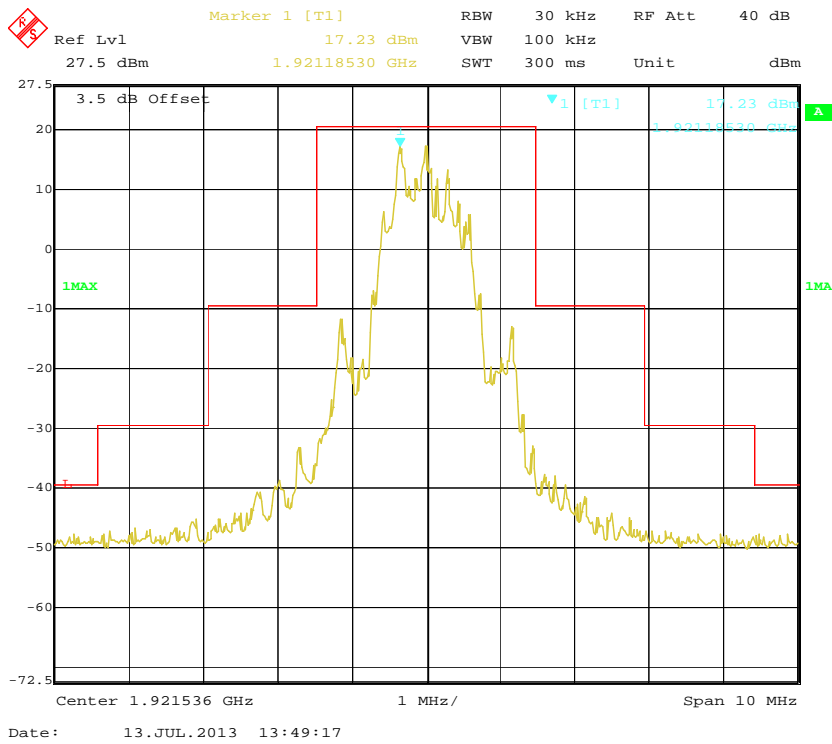

### Channel 2 (Unwanted Emission inside the Sub-band)

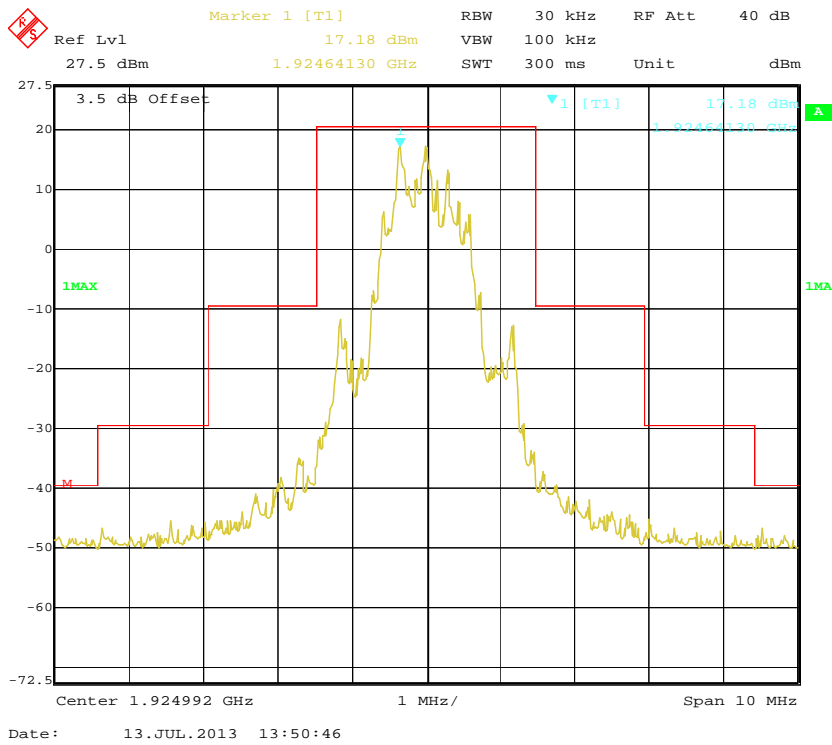

**Channel 0 (Unwanted Emission inside the Sub-band)**

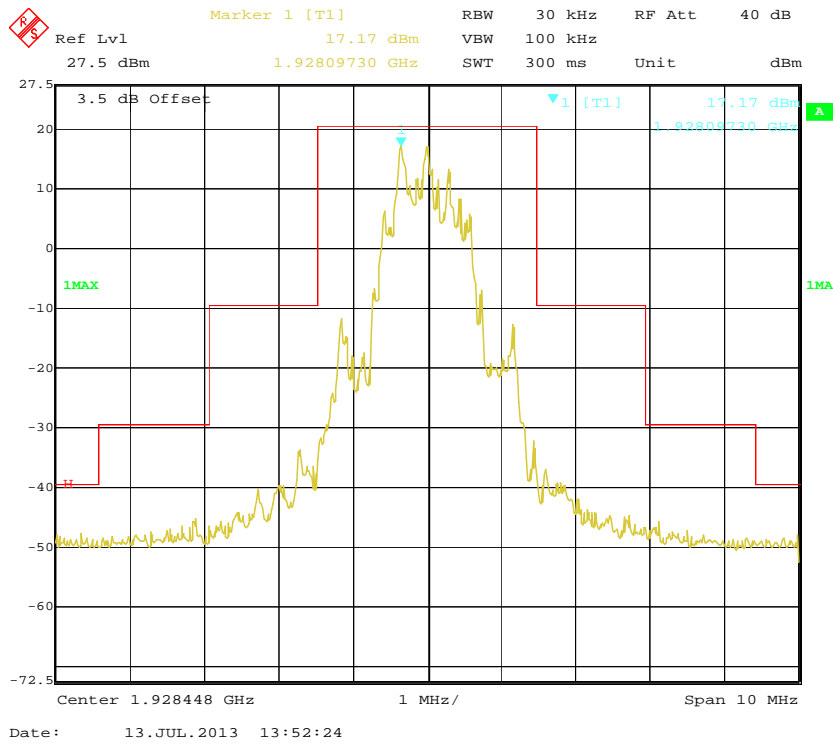

**Channel 4 (Unwanted Emission outside the Sub-band)**

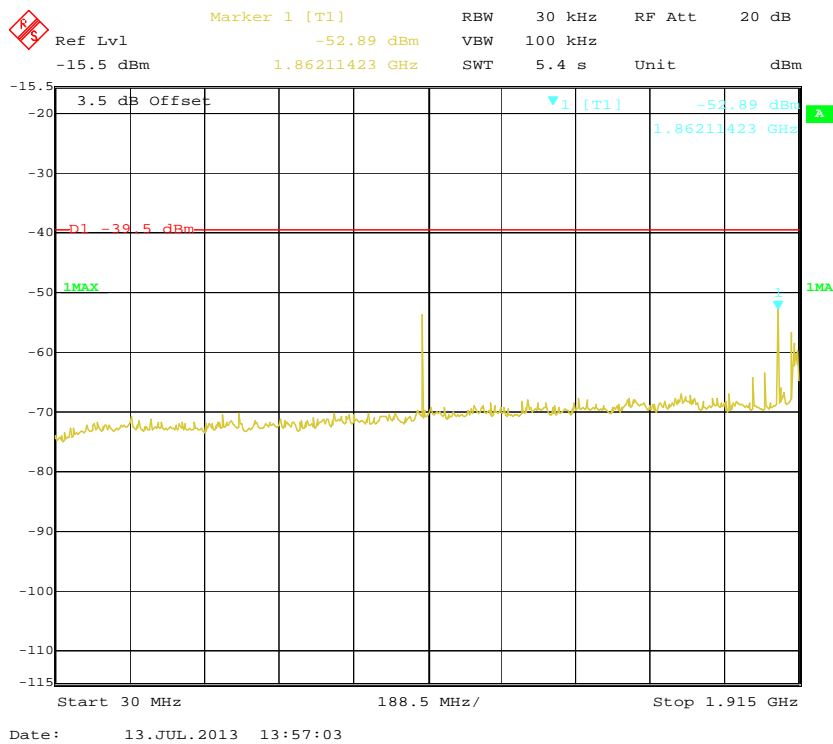

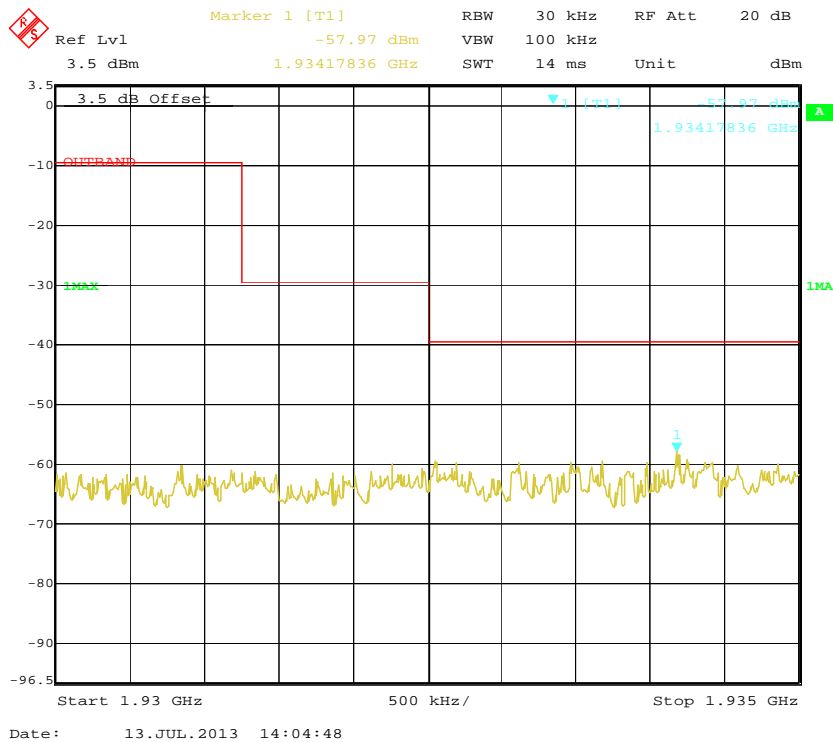
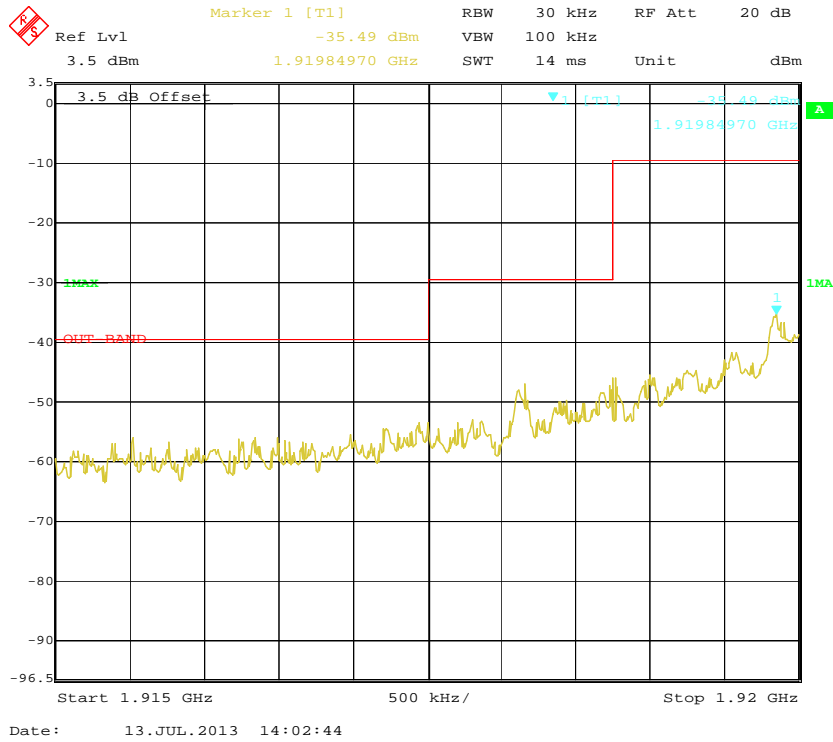



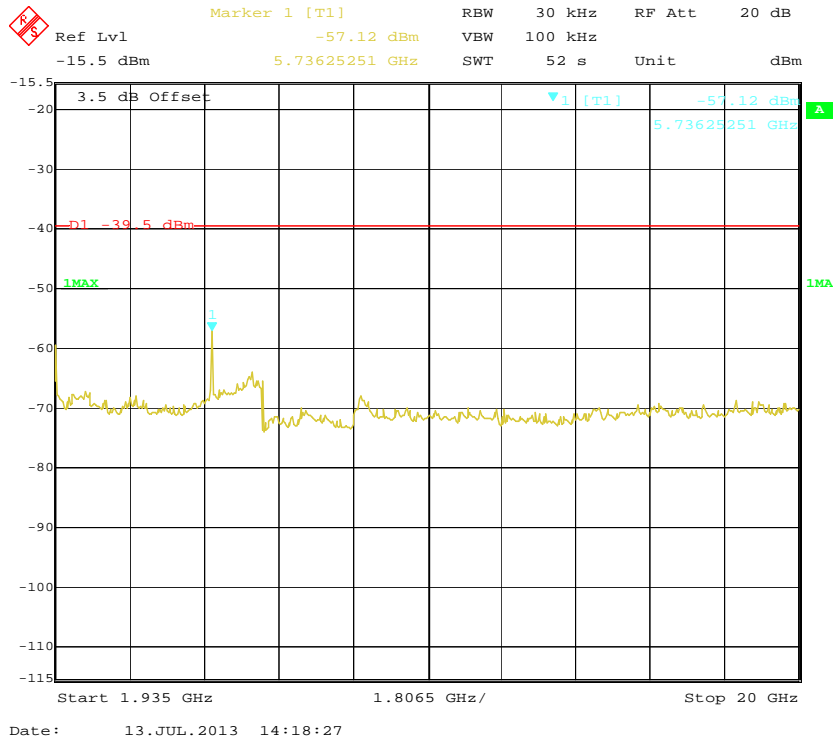

**Channel 2 (Unwanted Emission outside the Sub-band)**

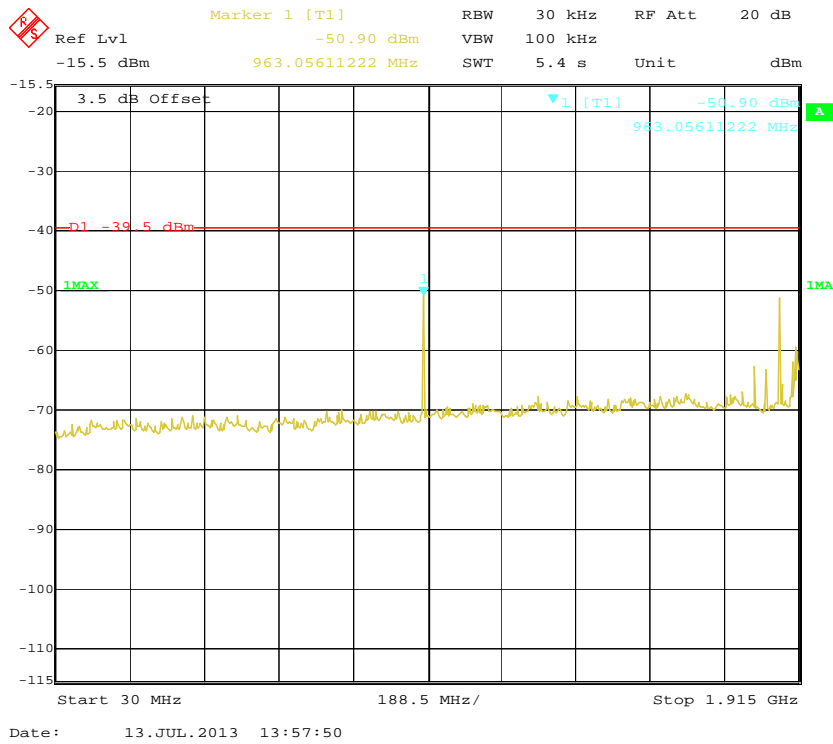

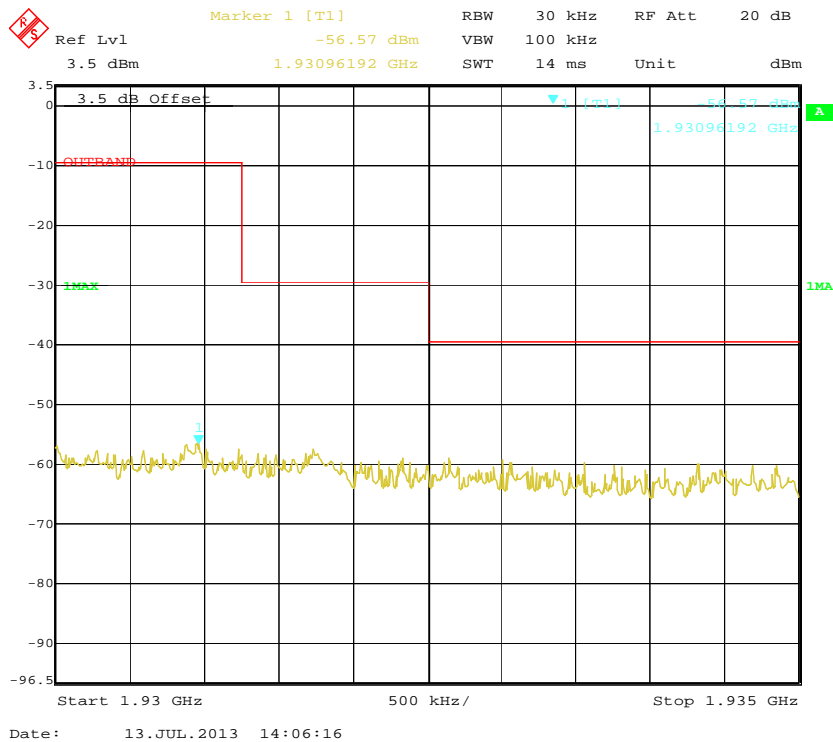
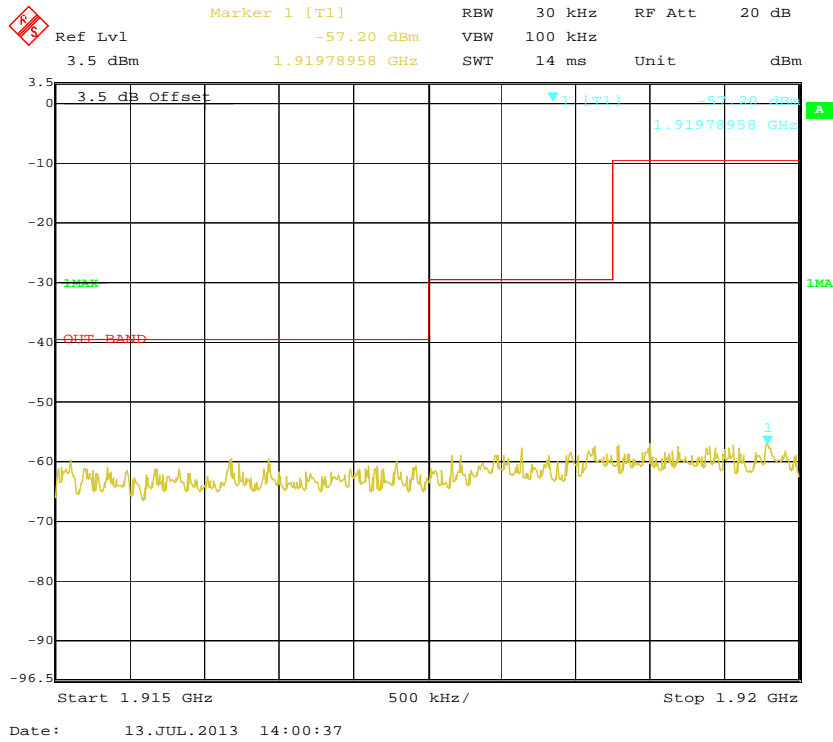

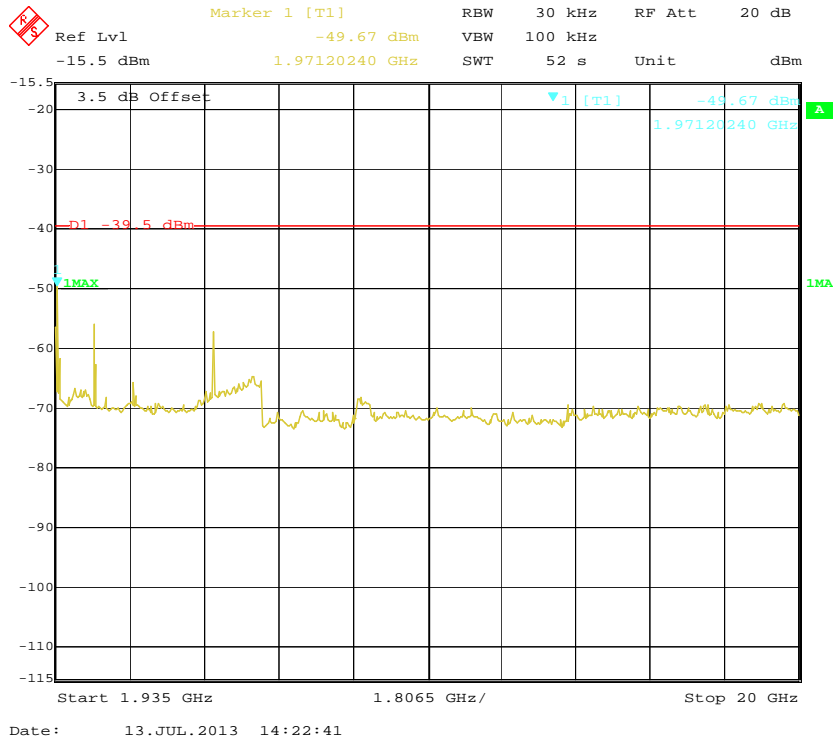

**Channel 0 (Unwanted Emission outside the Sub-band)**

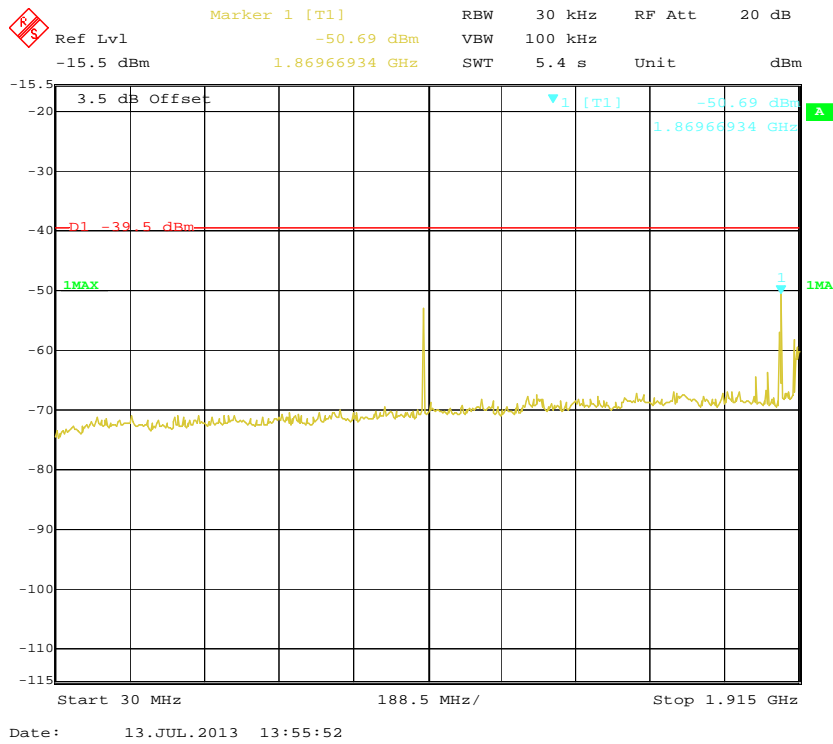

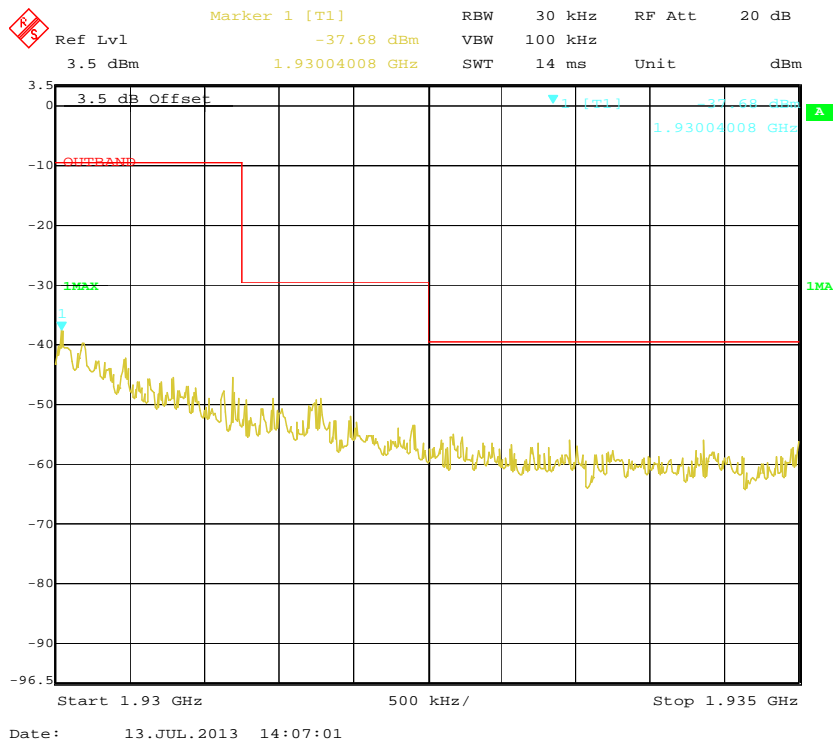
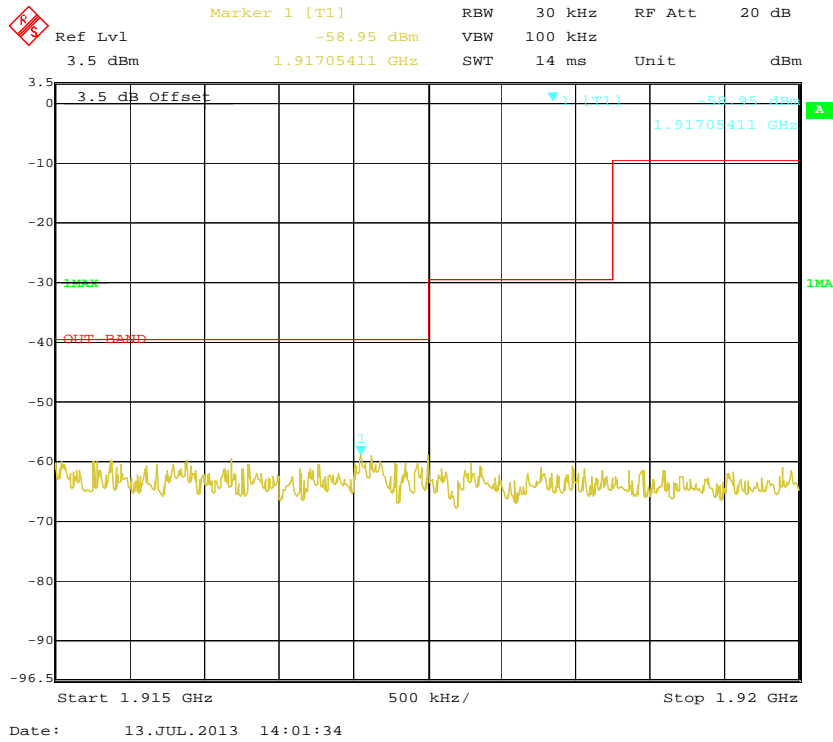

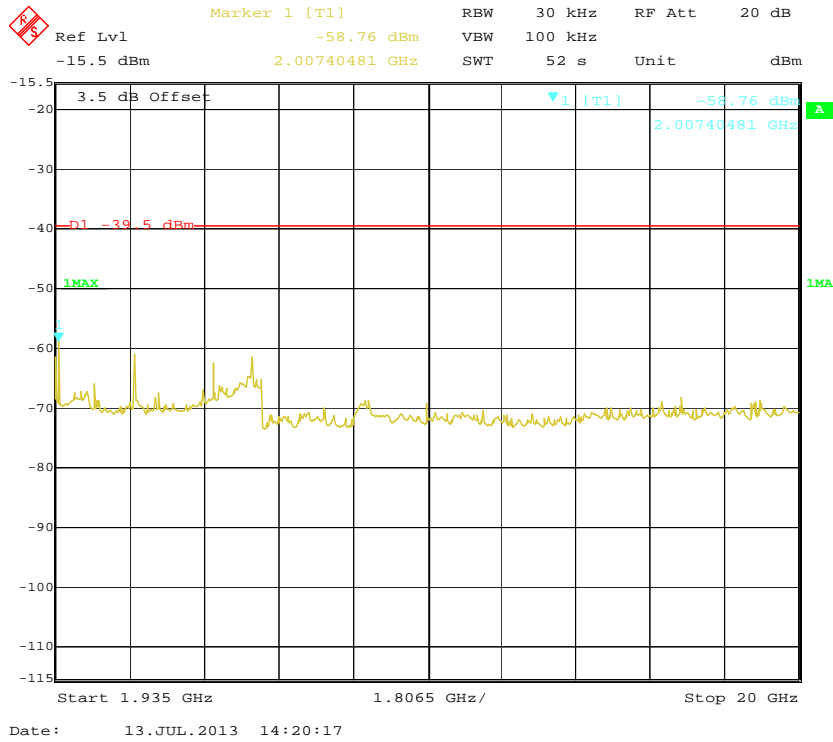

## FCC§15.319 (g) - RADIATED EMISSIONS

### Applicable Standard

According to FCC§15.319(g), notwithstanding other technical requirements specified in this subpart, attenuation of emissions below the general emission limits in §15.209 is not required.

### Measurement Uncertainty

All measurements involve certain levels of uncertainties, especially in field of EMC. The factors contributing to uncertainties are spectrum analyzer, cable loss, antenna factor calibration, antenna directivity, antenna factor variation with height, antenna phase center variation, antenna factor frequency interpolation, measurement distance variation, site imperfections, mismatch (average), and system repeatability.

Based on CISPR 16-4-2:2011, the expanded combined standard uncertainty of radiation emissions at Bay Area Compliance Laboratories Corp. (Shenzhen) will not be taken into consideration for the test data recorded in the report

### EUT Setup

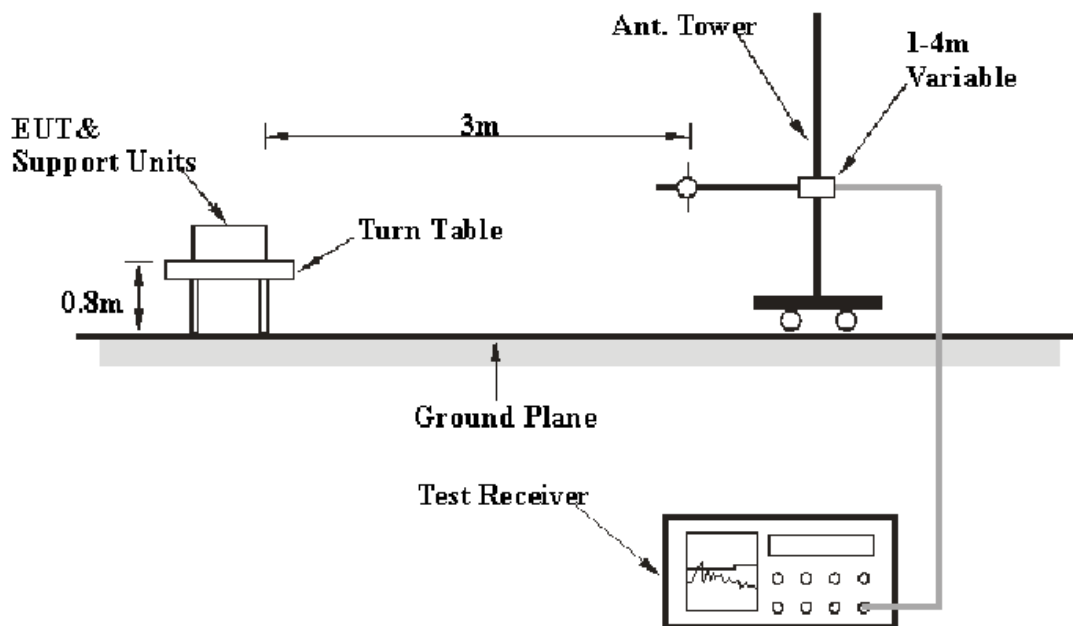

The radiated emission tests were performed in the 3 meters test site, using the setup accordance with the ANSI C63.17 - 2006. The specification used was the FCC 15§ 15.319(g).

The external I/O cables were draped along the test table and formed a bundle 30 to 40 cm long in the middle.

## EMI Test Receiver & Spectrum Analyzer Setup

The system was investigated from 30 MHz to 20 GHz.

During the radiated emission test, the EMI test receiver & Spectrum Analyzer Setup were set with the following configurations:

Frequency Range	RBW	Video B/W	IF B/W	Detector
30MHz – 1000 MHz	100 kHz	300 kHz	120 kHz	QP
Above 1 GHz	1 MHz	3 MHz	/	PK
	1 MHz	10 Hz	/	Ave.

## Test Procedure

Maximizing procedure was performed on the highest emissions to ensure that the EUT complied with all installation combinations.

Data was recorded in Quasi-peak detection mode for frequency range of 30 MHz-1 GHz and peak and Average detection modes for frequencies above 1 GHz.

## Test Equipment List and Details

Manufacturer	Description	Model	Serial Number	Calibration Date	Calibration Due Date
HP	Amplifier	8447E	1937A01046	2012-11-24	2013-11-23
Rohde & Schwarz	EMI Test Receiver	ESCI	101122	2013-05-09	2014-05-09
Sunol Sciences	Broadband Antenna	JB1	A040904-2	2011-11-28	2014-11-27
SUPER ULTRA	Amplifier	ZVA-213+	N/A	2012-11-24	2013-11-23
Sunol Sciences	Horn Antenna	DRH-118	A052304	2011-12-01	2014-11-30
BIZI	Signal Analyzer	FSIQ26	8386001028	2012-11-24	2013-11-23
the electro-Mechanics Co.	Horn Antenna	3116	9510-2270	2010-10-14	2013-10-13

\* **Statement of Traceability:** Bay Area Compliance Laboratories Corp. (Shenzhen) attests that all calibrations have been performed in accordance to NVLAP requirements, traceable to National Primary Standards and International System of Units (SI).

## Corrected Amplitude & Margin Calculation

The Corrected Amplitude is calculated by adding the Antenna Factor and Cable Loss, and subtracting the Amplifier Gain from the Meter Reading. The basic equation is as follows:

$$\text{Corrected Amplitude} = \text{Meter Reading} + \text{Antenna Factor} + \text{Cable Loss} - \text{Amplifier Gain}$$

The “**Margin**” column of the following data tables indicates the degree of compliance with the applicable limit. For example, a margin of 7dB means the emission is 7dB below the maximum limit. The equation for margin calculation is as follows:

$$\text{Margin} = \text{Limit} - \text{Corrected Amplitude}$$

## Test Results Summary

According to the data in the following table, the EUT complied with the FCC Part 15.319 (g), with the worst margin reading of:

**10.6 dB at 352.52 MHz in the Vertical polarization**

## Test Data

### Environmental Conditions

Temperature:	25°C
Relative Humidity:	54%
ATM Pressure:	101.0 kPa

\*The testing was performed by Sula Huang on 2013-07-13.

Test mode: Transmitting

**30 MHz ~ 20 GHz:**

Frequency (MHz)	Receiver		Turntable Degree	Rx Antenna		Corrected Factor (dB)	Corrected Amplitude (dBμV/m)	FCC Part 15.319(g)/209/205	
	Reading (dBμV)	Detector (PK/QP/Ave.)		Height (m)	Polar (H/V)			Limit (dBμV/m)	Margin (dB)
<b>Channel 4 (1921.536 MHz)</b>									
1921.4	107.33	PK	313	1.6	H	2.63	109.96	/	/
1921.4	109.14	PK	148	2.2	V	2.63	111.77	/	/
352.52	48.80	QP	300	1.3	V	-13.50	35.30	46.00	10.70
3843.1	52.21	PK	220	1.4	V	10.23	62.44	74.00	11.56
45.83	45.90	QP	199	1.0	V	-18.20	27.70	40.00	12.30
41.35	42.80	QP	320	1.0	V	-15.30	27.50	40.00	12.50
32.22	35.90	QP	247	1.0	V	-8.60	27.30	40.00	12.70
345.58	46.00	QP	52	1.9	V	-13.50	32.50	46.00	13.50
3843.1	48.67	PK	198	1.5	H	10.23	58.90	74.00	15.10
50.40	45.00	QP	218	1.0	V	-20.30	24.70	40.00	15.30
7686.3	41.03	PK	216	1.3	H	16.47	57.50	74.00	16.50
5764.6	43.13	PK	48	1.2	H	13.87	57.00	74.00	17.00
7686.3	36.54	PK	236	1.2	V	16.47	53.01	74.00	20.99
5764.6	36.34	PK	45	2.1	V	13.87	50.21	74.00	23.79



Frequency (MHz)	Receiver		Turntable Degree	Rx Antenna		Corrected Factor (dB)	Corrected Amplitude (dBµV/m)	FCC Part 15.319(g)/209/205	
	Reading (dBµV)	Detector (PK/QP/Ave.)		Height (m)	Polar (H/V)			Limit (dBµV/m)	Margin (dB)
<b>Channel 2 (1924.992 MHz)</b>									
1924.9	107.19	PK	310	1.6	H	3.07	110.26	/	/
1924.9	109.60	PK	145	2.2	V	3.07	112.67	/	/
352.52	48.70	QP	302	1.2	V	-13.50	35.20	46.00	10.80
3849.8	52.38	PK	222	1.4	V	10.23	62.61	74.00	11.39
41.35	42.90	QP	321	1.0	V	-15.30	27.60	40.00	12.40
45.83	45.70	QP	200	1.0	V	-18.20	27.50	40.00	12.50
32.22	36.00	QP	248	1.0	V	-8.60	27.40	40.00	12.60
345.58	46.10	QP	54	2.0	V	-13.50	32.60	46.00	13.40
3849.8	49.17	PK	200	1.5	H	10.23	59.40	74.00	14.60
50.40	44.80	QP	220	1.0	V	-20.30	24.50	40.00	15.50
7699.6	41.19	PK	210	1.3	H	16.47	57.66	74.00	16.34
5774.9	43.27	PK	46	1.2	H	13.87	57.14	74.00	16.86
7699.6	36.70	PK	235	1.2	V	16.47	53.17	74.00	20.83
5774.9	36.48	PK	45	2.1	V	13.87	50.35	74.00	23.65
<b>Channel 0 (1928.448 MHz)</b>									
1928.4	106.83	PK	316	1.7	H	3.07	109.90	/	/
1928.4	108.82	PK	146	1.7	V	3.07	111.89	/	/
352.52	48.90	QP	305	1.2	V	-13.50	35.40	46.00	10.60
3856.8	52.15	PK	220	1.4	V	10.23	62.38	74.00	11.62
32.22	36.20	QP	246	1.0	V	-8.60	27.60	40.00	12.40
41.35	42.70	QP	322	1.0	V	-15.30	27.40	40.00	12.60
45.83	45.50	QP	201	1.0	V	-18.20	27.30	40.00	12.70
345.58	45.90	QP	52	2.0	V	-13.50	32.40	46.00	13.60
3856.8	48.51	PK	201	1.5	H	10.23	58.74	74.00	15.26
50.4	44.90	QP	218	1.0	V	-20.30	24.60	40.00	15.40
7713.6	40.85	PK	208	1.3	H	16.47	57.32	74.00	16.68
5785.2	43.35	PK	48	1.2	H	13.87	57.22	74.00	16.78
7713.6	36.37	PK	236	1.2	V	16.47	52.84	74.00	21.16
5785.2	36.17	PK	44	2.1	V	13.87	50.04	74.00	23.96

Field Strength of Radiated Emission Average							
Freq. (MHz)	Peak Corrected Amplitude. @3m (dBµV/m)	Polar (H/V)	Duty Cycle Factor (dB)	Corrected Amplitude. (dBµV/m)	FCC Part 15.319/15.205/15.209		Comment
					Limit (dBµV/m)	Margin	
<b>Channel 4 (1921.536 MHz)</b>							
3843.1	62.44	V	-27.11	35.33	54.00	18.67	Harmonic
3843.1	58.90	H	-27.11	31.79	54.00	22.21	Harmonic
7686.3	57.50	H	-27.11	30.39	54.00	23.61	Harmonic
5764.6	57.00	H	-27.11	29.89	54.00	24.11	Harmonic
7686.3	53.01	V	-27.11	25.90	54.00	28.10	Harmonic
5764.6	50.21	V	-27.11	23.10	54.00	30.90	Harmonic
<b>Channel 2 (1924.992 MHz)</b>							
3849.8	62.61	V	-27.11	35.50	54.00	18.50	Harmonic
3849.8	59.40	H	-27.11	32.29	54.00	21.71	Harmonic
7699.6	57.66	H	-27.11	30.55	54.00	23.45	Harmonic
5774.9	57.14	H	-27.11	30.03	54.00	23.97	Harmonic
7699.6	53.17	V	-27.11	26.06	54.00	27.94	Harmonic
5774.9	50.35	V	-27.11	23.24	54.00	30.76	Harmonic
<b>Channel 0 (1928.448 MHz)</b>							
3856.8	62.38	V	-27.11	35.27	54.00	18.73	Harmonic
3856.8	58.74	H	-27.11	31.63	54.00	22.37	Harmonic
7713.6	57.32	H	-27.11	30.21	54.00	23.79	Harmonic
5785.2	57.22	H	-27.11	30.11	54.00	23.89	Harmonic
7713.6	52.84	V	-27.11	25.73	54.00	28.27	Harmonic
5785.2	50.04	V	-27.11	22.93	54.00	31.07	Harmonic

Note:

Corrected Amplitude = Corrected Factor + Reading

Corrected Factor = Antenna factor (RX) + cable loss – amplifier factor

Margin = Limit - Corr. Amplitude

Duty Cycle = Ton/Tp\*100%, Ton = 0.44ms, Tp = 9.98ms

Duty cycle factor = 20lg (Duty Cycle) = -27.11

AV = Peak Corrected Amplitude + 20\* lg(Duty Cycle)

### Duty Cycle

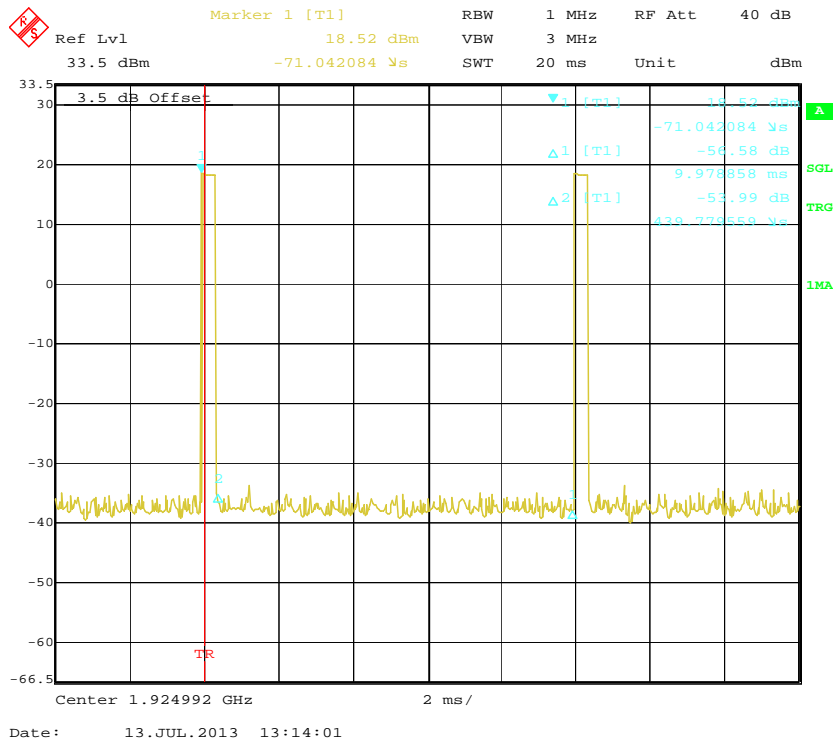

### Duty Cycle (100ms)

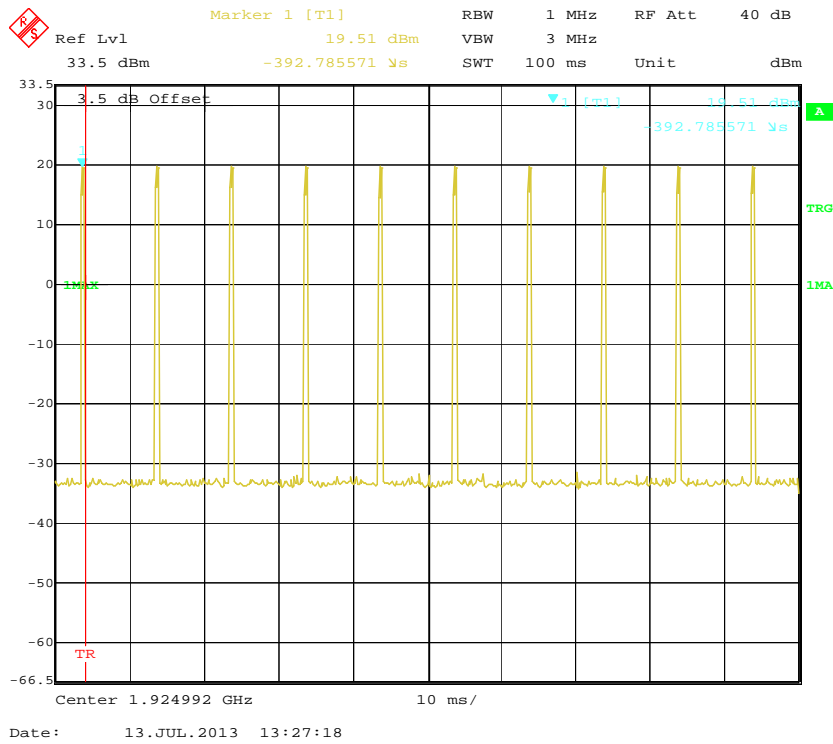

## FCC§15.323 (f) - FREQUENCY STABILITY

### Applicable Standard

Per §15.323(f), the frequency stability of the carrier frequency of the intentional radiator shall be maintained within  $\pm 10$  ppm over 1 hour or the interval between channel access monitoring, whichever is shorter. The frequency stability shall be maintained over a temperature variation of  $-20^{\circ}\text{C}$  to  $+50^{\circ}\text{C}$  at normal supply voltage, and over a variation in the primary supply voltage of 85 percent to 115 percent of the rated supply voltage at a temperature of  $20^{\circ}\text{C}$ . For equipment that is capable only of operating from a battery, the frequency stability tests shall be performed using a new battery without any further requirement to vary supply voltage

### Test Procedure

This procedure should be carried out for each of the following test cases:

Temperature	Supply Voltage
$20^{\circ}\text{C}$	85-115% or new batteries
$-20^{\circ}\text{C}$	Normal
$+50^{\circ}\text{C}$	Normal

<sup>a</sup> Use the lowest temperature at which the EUT is specified to operate if it is above  $-20^{\circ}\text{C}$ .

During test, the equipment shall be placed in the boxes and set the temperature to the specified requirement until the thermal balance has been reached.

Using the mean carrier frequency at  $20^{\circ}\text{C}$  and at nominal supply voltage as the reference, the mean carrier frequency shall be maintained within  $\pm 10$  ppm at the two extreme temperatures (or as declared by the manufacturer) and at normal temperature (typically  $20^{\circ}\text{C}$ ) at the two extreme supply voltages. This test does not apply to a EUT that is capable only of operating from a battery.

### Test Equipment List and Details

Manufacturer	Description	Model	Serial Number	Calibration Date	Calibration Due Date
ESPEC	Temperature & Humidity Chamber	EL-10KA	09107726	2012-11-02	2013-11-02

\* **Statement of Traceability:** Bay Area Compliance Laboratories Corp. (Shenzhen) attests that all calibrations have been performed in accordance to NVLAP requirements, traceable to National Primary Standards and International System of Units (SI).

**Test Data****Environmental Conditions**

<b>Temperature:</b>	25°C
<b>Relative Humidity:</b>	54%
<b>ATM Pressure:</b>	101.0 kPa

*The testing was performed by Sula Huang on 2013-07-13.*

*Test mode: Transmitting*

*Test Result: Compliance.*

<b>Temperature (°C)</b>	<b>Voltage (V<sub>DC</sub>)</b>	<b>Channel Frequency (MHz)</b>	<b>Measured Frequency Offset (kHz)</b>	<b>Measured Frequency Offset (ppm)</b>	<b>Limit (ppm)</b>
-20	2.4	1924.992	7	3.636	±10
20	2.4	1924.992	6	3.117	±10
50	2.4	1924.992	7	3.636	±10

## **FCC§15.323 (c) (e) & §15.319(f) – SPECIFIC REQUIREMENTS FOR UPCS DEVICE**

### **Automatic Discontinuation of Transmission, FCC Part 15.319(f)**

The device shall automatically discontinue transmission in case of either absence of information to transmit or operational failure. The provisions in this section are not intended to preclude transmission of control and signaling information or use of repetitive codes used by certain digital technologies to complete frame or burst intervals.

#### **Test Procedure:**

According to ANSI C63.17 Annex A

#### **Test result:**

Meet the requirement; please refer to the declaration provided by manufacturer.

### **Monitoring Time FCC Part 15.323 (c)(1)**

Immediately prior to initiating transmission, devices must monitor the combined time and spectrum window in which they intend to transmit. For a period of at least 10 milliseconds for systems designed to use a 10 milliseconds or shorter frame period or at least 20 milliseconds for systems designed to use a 20 milliseconds frame period

#### **Test procedure:**

Measurement method according to ANSI C63.17 2006 clause 7.3.4.

#### **Test result:**

EUT monitors the combined time and spectrum window prior to initiation of transmission. Test result is following

<b>Interference (Refer to ANSI C63.17 clause 7.3.4)</b>	<b>Reaction of EUT</b>	<b>Results</b>
1) Apply the interference on $f_1$ at level $T_U + U_M$ , and no interference on $f_2$ . Initiate transmission and verify the transmission on $f_2$ .	EUT transmits on $f_2$	Pass
2) Apply the interference on $f_2$ at level $T_U + U_M$ , at the same time, no interference on $f_1$ . After about 20ms, initiate transmission and verify the transmission on $f_1$ .	EUT transmits on $f_1$	Pass

### **Lower Monitoring Threshold Part 15.323 (c)(2)**

The monitoring threshold must not be more than 30 dB above the thermal noise power for a bandwidth equivalent to the emission bandwidth used by the device.

#### **Test procedure:**

Measurement method according to ANSI C63.17 2006 clause 7.3.1

#### **Test result:** Not Apply

Note: For the EUT which support LIC there is no need to measure lower threshold because it is automatically met by LIC procedure.

**Maximum Transmit Period FCC Part 15.323 (c)(3)**

If no signal above the threshold level is detected, transmission may commence and continue with the same emission bandwidth in the monitored time and spectrum windows without further monitoring. However, occupation of the same combined time and spectrum windows by a device or group of cooperating devices continuously over a period of time longer than 8 hours is not permitted without repeating the access criteria.

**Test procedure:**

Measurement method according to ANSI C63.17 2006 clause 8.2.2

**Test result:**

Repetition of Access Criteria	Measured Maximum Transmission Time (Second)	Limit (Second)	Results
First	16200	28,800	Pass
Second	16200	28,800	Pass

**System Acknowledgement, FCC Part 15.323 (c) (4)**

Once access to specific combined time and spectrum windows is obtained an acknowledgment from a system participant must be received by the initiating transmitter within one second or transmission must cease. Periodic acknowledgments must be received at least every 30 seconds or transmission must cease. Channels used exclusively for control and signaling information may transmit continuously for 30 seconds without receiving an acknowledgment, at which time the access criteria must be repeated.

**Test procedure:**

Measurement method according to ANSI C63.17 2006 clause 8.1.1, 8.2.1

**Test result:**

Test	Time taken(second)	Limit (second)	Result
Connection acknowledgement	0.01	1	Pass
Change of access criteria for control information	N/A	30	Pass
Transmission cease time	1.28	30	Pass
Pulse length	0.00044	0.01	Pass

Note: N/A=Not Applicable

**Least Interfered Channel (LIC) Selection, FCC Part 15.323 (c) (5)**

If access to spectrum is not available as determined by the above, and a minimum of 40 duplex system access channels are defined for the system, the time and spectrum windows with the lowest power level below a monitoring threshold of 50 dB above the thermal noise power determined for the emission bandwidth may be accessed.

Calculation of monitoring threshold limits for isochroous devices:

Lower threshold:  $T_L = -174 + 10\text{Log}_{10}B + M_u + P_{MAX} - P_{EUT}$  (dBm)

Upper threshold:  $T_U = -174 + 10\text{Log}_{10}B + M_u + P_{MAX} - P_{EUT}$  (dBm)

Where: B=Emission bandwidth (Hz)

$M_u$  =dB the threshold may exceed thermal noise (30 for  $T_L$  & 50 for  $T_U$ )

$P_{MAX} = 5\text{Log}_{10}B - 10$  (dBm)

$P_{EUT}$  =Transmitted power (dBm)

**Calculated thresholds:**

Monitor Threshold	B(MHz)	$M_u$ (dB)	$P_{MAX}$ (dBm)	$P_{EUT}$ (dBm)	Threshold (dBm)
$T_L$	1.467	30	20.83	18.98	-80.48
$T_U$	1.467	50	20.83	18.98	-60.48

**Limit:**

Limit (dBm)
$T_{LR} < T_L + U_M = -80.48 + 6 = -74.48$
$T_{UR} < T_U + U_M = -60.48 + 6 = -54.48$

Note: According to 47CFR 15.323(c) (5), the power measurement resolution for this comparison must be accurate to within 6 dB, the limit should be “Threshold+6(dB)”

**Test procedure:**

Measurement method according to ANSI C63.17 clause 7.3.2, 7.3.3, 7.3.4

**Test result:**

Monitor threshold	Measured Threshold Level	Limit (dBm)
Lower Threshold(dBm)	N/A	-74.48
Upper Threshold(dBm)	-66.21	-54.48

Note: The upper threshold is applicable as the EUT utilizes more than 40 duplex system channels.

**Random waiting FCC 15.323(c)(6)**

If the selected combined time and spectrum windows are unavailable, the device may either monitor and select different windows or seek to use the same window after waiting an amount of time, randomly chosen from a uniform random distribution between 10 and 150 milliseconds, commencing when the channel becomes available.

**Test procedure:**

Measurement method according to ANSI C63.17 2006 clause 8.1.3

**Test result:**

The manufacturer declares that this provision is not utilized by the EUT.



**Monitoring Bandwidth, FCC Part 15.323 (c) (7)**

The monitoring system bandwidth must be equal to or greater than the emission bandwidth of the intended transmission and have a maximum reaction time less than  $50 \times \text{SQRT}(1.25/\text{emission bandwidth in MHz})$  microseconds for signals at the applicable threshold level but shall not be required to be less than 50 microseconds

**Test procedure:**

Measurement method according to ANSI C63.17 2006 clause 7.5

**Test result:**

Test Equation ( $\mu\text{s}$ )	B(bandwidth)(MHz)	Pulse width( $\mu\text{s}$ )	Limit( $\mu\text{s}$ )	Result
$50 (1.25/B)^{1/2}$	1.467	46.15	50	Pass
$35 (1.25/B)^{1/2}$	1.467	32.31	35	Pass

**Monitoring Antenna, FCC Part 15.323 (c) (8)**

The monitoring system shall use the same antenna used for transmission, or an antenna that yields equivalent reception at that location.

**Test procedure:**

Measurement method according to ANSI C63.17 2006 paragraph 4.

**Test result:**

The antenna of the EUT used for transmission is the same interior antenna that used for monitoring.

**Monitoring threshold relation FCC Part 15.323(c)(9)**

Devices that have a power output lower than the maximum permitted under the rules can increase their monitoring detection threshold by one decibel for each one decibel that the transmitter power is below the maximum permitted.

**Test procedure:**

Measurement method according to ANSI C63.17 2006 paragraph 4.

**Test result:**

Not apply based on 15.323 (c)(5)

**Duplex Connections, FCC Part 15.323 (c) (10)**

An initiating device may attempt to establish a duplex connection by monitors both its intended transmit and receive time and spectrum windows. If both the intended transmit and receive time and spectrum windows meet the access criteria, then the initiating device can initiate a transmission in the intended transmit time and spectrum window. If the power detected by the responding device can be decoded as a duplex connection signal from the initiating device, then the responding device may immediately begin transmitting on the receive time and spectrum window monitored by the initiating device.

**Test procedure:**

Measurement method according to ANSI C63.17 clause 8.3

**Test result:**

The manufacturer declares that this provision is not utilized by the EUT.

**Alternative monitoring interval for co-located devices, FCC Part 15.323 (c) (11)**

An initiating device that is prevented from monitoring during its intended transmit window due to monitoring system blocking from the transmissions of a co-located (within one meter) transmitter of the same system, may monitor the portions of the time and spectrum windows in which they intend to receive over a period of at least 10 milliseconds. The monitored time and spectrum window must total at least 50 percent of the 10 millisecond frame interval and the monitored spectrum must be within 1.25 MHz of the center frequency of channel(s) already occupied by that device or co-located co-operating devices. If the access criteria is met for the intended receive time and spectrum window under the above conditions, then transmission in the intended transmit window by the initiating device may commence.

**Test procedure:**

Measurement method according to ANSI C63.17 2006 clause 8.4

**Test result:**

The manufacturer declares that this provision is not utilized by the EUT.

**Fair Access, FCC Part 15.323 (c)(12)**

The provisions of FCC Part 15.323(c)(10) or (c)(11) shall not be used to extend the range of spectrum occupied over space or time for the purpose of denying fair access to spectrum to other devices.

**Test result:**

The manufacturer declares that this device does not use any mechanisms as provided by Part 15.323 (c) (10) or (c) (11) to extend the range of spectrum occupied over space or time for the purpose of denying fair access to spectrum to other device.

**Frame Repetition Stability, Part 15.323 (e)**

The frame period (a set of consecutive time slots in which the position of each time slot can be identified by reference to a synchronizing source) of an intentional radiator operating in these sub-bands shall be 20 milliseconds or 10 milliseconds/X where X is a positive whole number.

**Test procedure:**

Measurement method according to ANSI C63.17 2006 clause 6.2.2, 6.2.3

**Test result:**

Frame Repetition Stability:

Frame Repetition Stability (ppm)	Limit (ppm)	Result (Pass/Fail)
0.46	10	Pass

Frame Period and Jitter:

Max. pos. Jitter (us)	Max. neg. Jitter (us)	Frame period (ms)	Limit	
			Frame Period (ms)	Jitter (µs)
0.24	-0.22	10.00000	20 or 10/X	0.24

Note: X is a positive whole number.

## PRODUCT SIMILARITY DECLARATION LETTER

**SAGEMCOM**

Rueil-Malmaison, on September 12, 2013

### Product Similarity Declaration Letter

To Whom It May Concern,

We, Sagemcom SAS, hereby declare that our product **DECT Phone**, the models **D680C**, **D680C Solo**, **D680C Duo** and **D680C handset** are electrically identical, they have same handset, charger and base on schematic, PCB layout and mechanical construction, their difference is only the quantity on handset, charger and base, the details as below :

**D680C** is same as **D680C Solo** : 1 handset+1 charger+1 base

**D680C Duo** : 2 handsets+2chargers+1 base

**D680C Handset** : 1 handset+1 charger, no base.

**D680C** was tested by BA CL.

Please contact me if you have any question.

Signature:



Jacques LE ROUX  
R&D General Methods Department Manager

Sagemcom SAS  
Siège social : 250, route de l'Empereur - 92848 RUEIL-MALMAISON CEDEX - FRANCE  
Tél. +33(0)1 57 61 10 00 - Fax : +33 (0)1 57 61 10 01  
S.A.S. au capital de 158 291 895 € - 440 294 510 RCS Nanterre  
[www.sagemcom.com](http://www.sagemcom.com)

\*\*\*\*\* END OF REPORT \*\*\*\*\*