

# HHR5000

by BioControl

For ISO11784 transponders and NFC option  
User Manual

Version 1.8



Scan this QR code to check  
out this user manual in  
other languages.

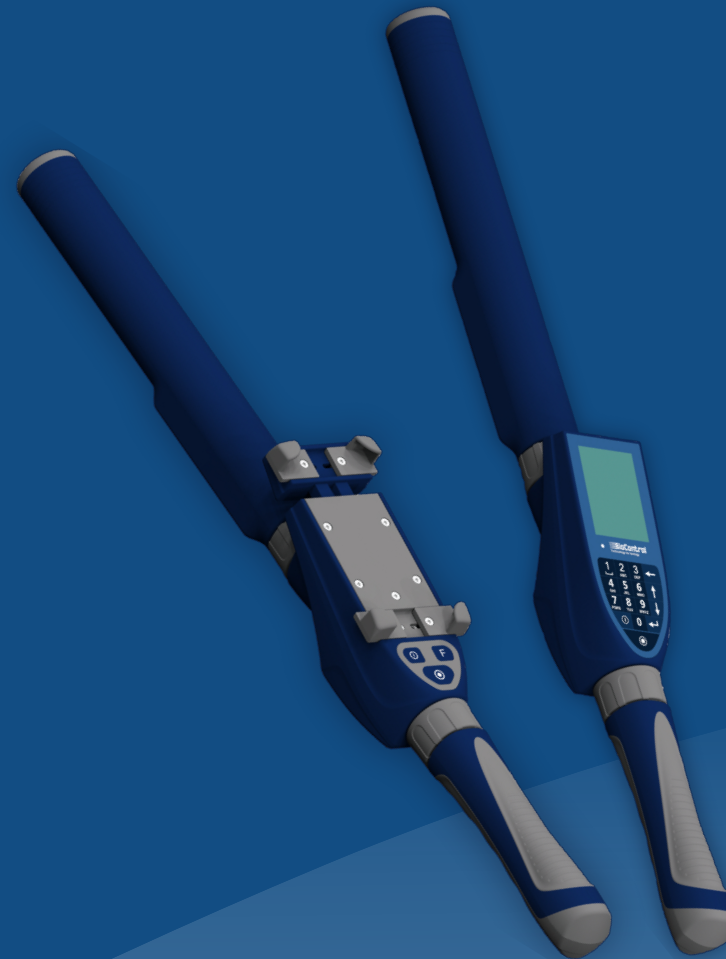



# Table of Contents

<b>General description</b>	<b>2</b>	<b>Demo Application</b>	<b>12</b>
		Main Menu	12
<b>HHR5000S for Smartphone</b>	<b>3</b>	ISO Reader Menu	13
Layout HHR5000S	3	NFC Reader Menu	14
Layout HHR5000SN	4	Test Menu	15
Keyboard navigation	5	Info Menu	16
<b>HHR5000L with LCD Display</b>	<b>6</b>	<b>HHR5000 Care</b>	<b>17</b>
Layout HHR5000L	6		
Layout HHR5000LN	7	<b>Specification</b>	<b>18</b>
Keyboard navigation	8		
<b>Charging the HHR5000</b>	<b>9</b>	<b>Compliance with national regulations</b>	<b>19</b>
Internal battery charger	9	FCC Compliance statement	19
External battery charger	9	ISED Compliance statement	20
Charging the battery handgrip	10	<b>Safety devices</b>	<b>21</b>
<b>Establishing Connection</b>	<b>11</b>	<b>Warranty</b>	<b>22</b>
USB connection	11		
Bluetooth connection	11		

# General description

HHR5000 is a dual RFID reader.

## Introduction

The HHR 5000 is an easy to operate Handheld Reader for ISO 11784/11785 transponders. It is designed to be used under 'real life' conditions and combines great reading performance, enhanced computer features with ease of operation.

The HHR5000 is a modular unit which consists of:

1. Handgrip with Lilon battery
2. Main unit with keyboard, touch LCD screen, or grips for smartphone attachment

Both versions communicate with smartphones, tablets or PC over BLE interface

3. Antenna with ISO Module that reads HDX, FDX and B-delaval transponder and NFC reader (optional)

# HHR5000S (Art. no. 107375)

## Layout

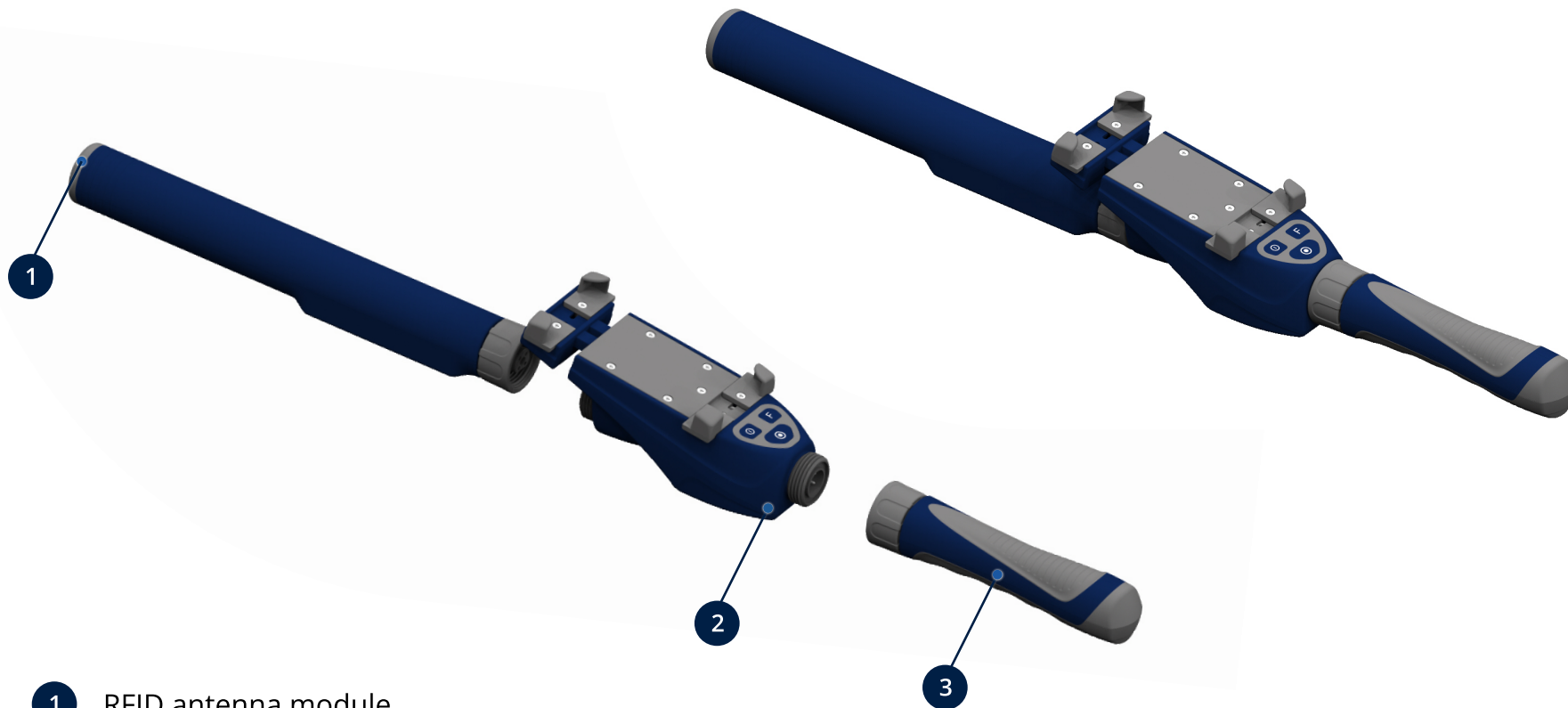

- 1 RFID antenna module
- 2 HHR5000S main module
- 3 Battery handgrip

# HHR5000SN (Art. no. 107337)

## Layout

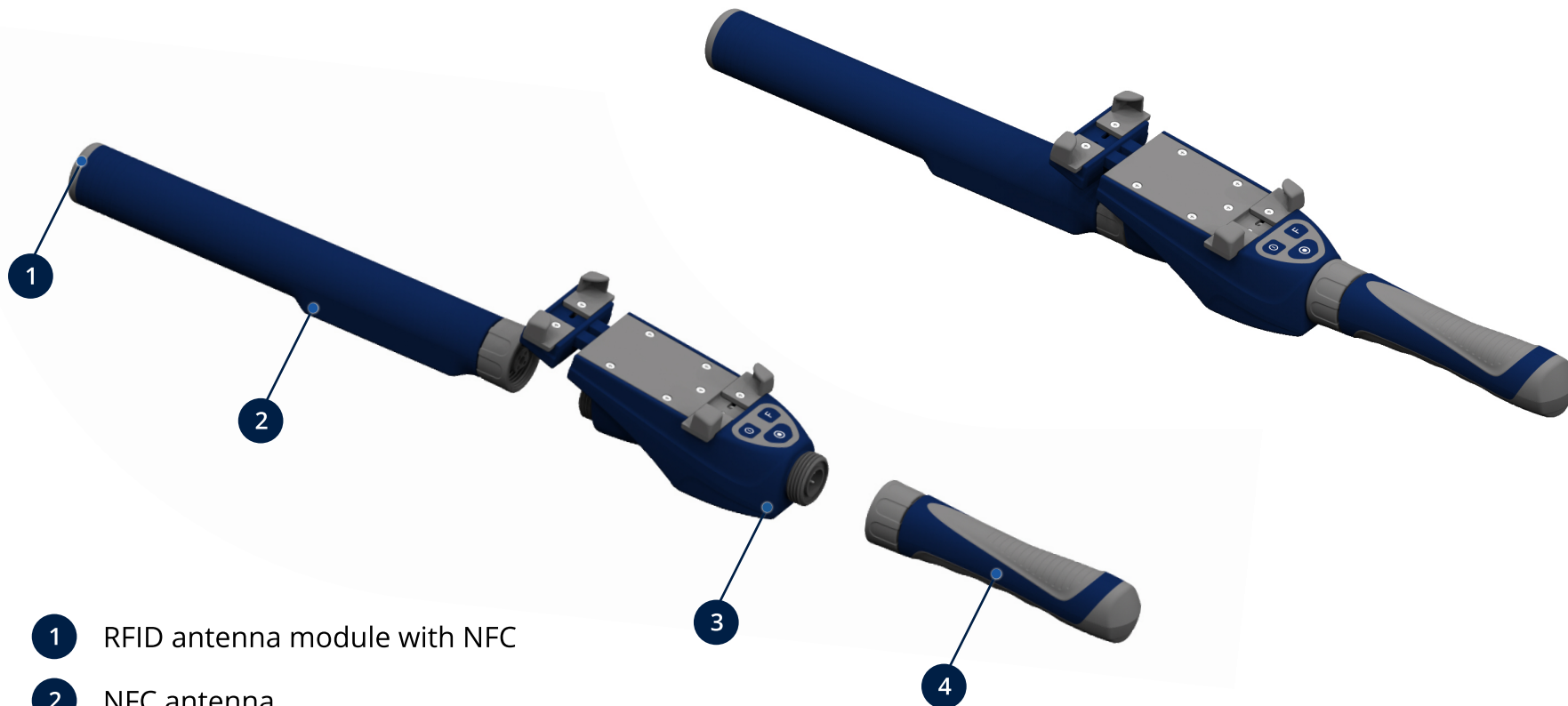



- 1 RFID antenna module with NFC
- 2 NFC antenna
- 3 HHR5000S main module
- 4 Battery handgrip

# HHR5000S for Smartphone

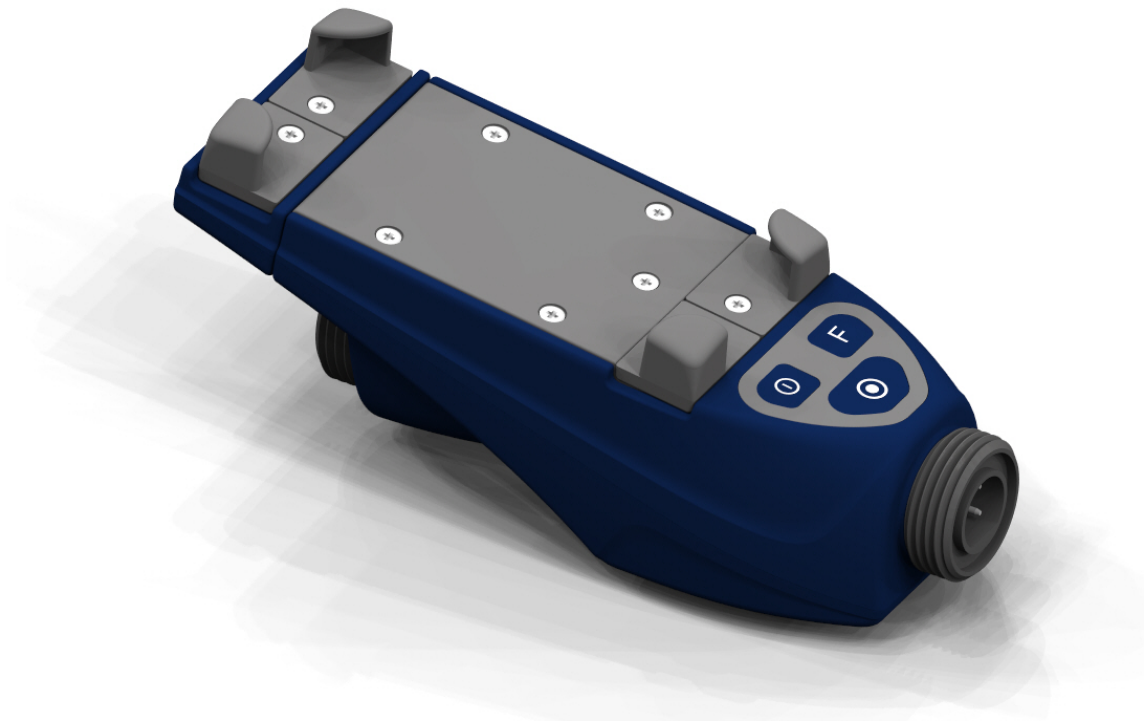
## Keyboard navigation



	Turn the unit on and off
	Functional button
	Read Tags

# HHR5000L (Art. no. 107311)

## Layout

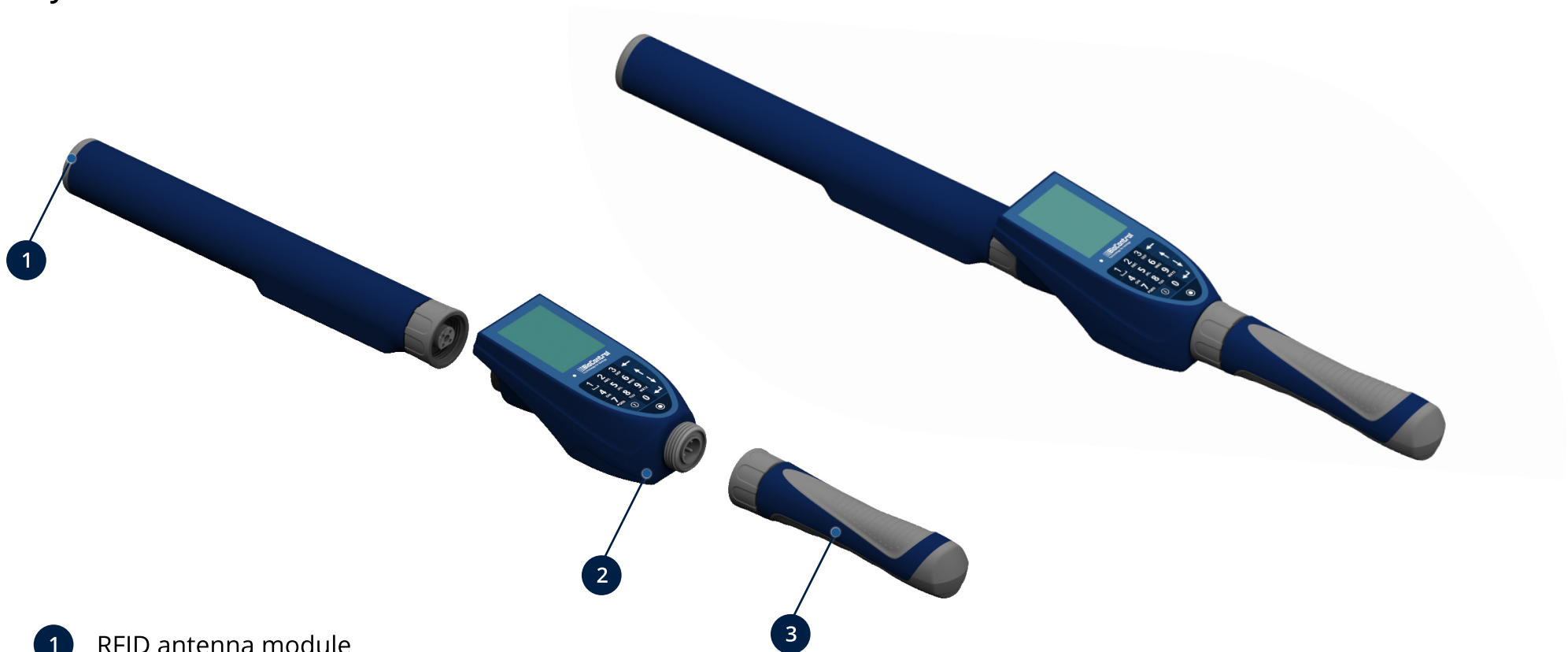

- 1 RFID antenna module
- 2 HHR5000L main module
- 3 Battery handgrip



# HHR5000LN (Art. no. 107374)



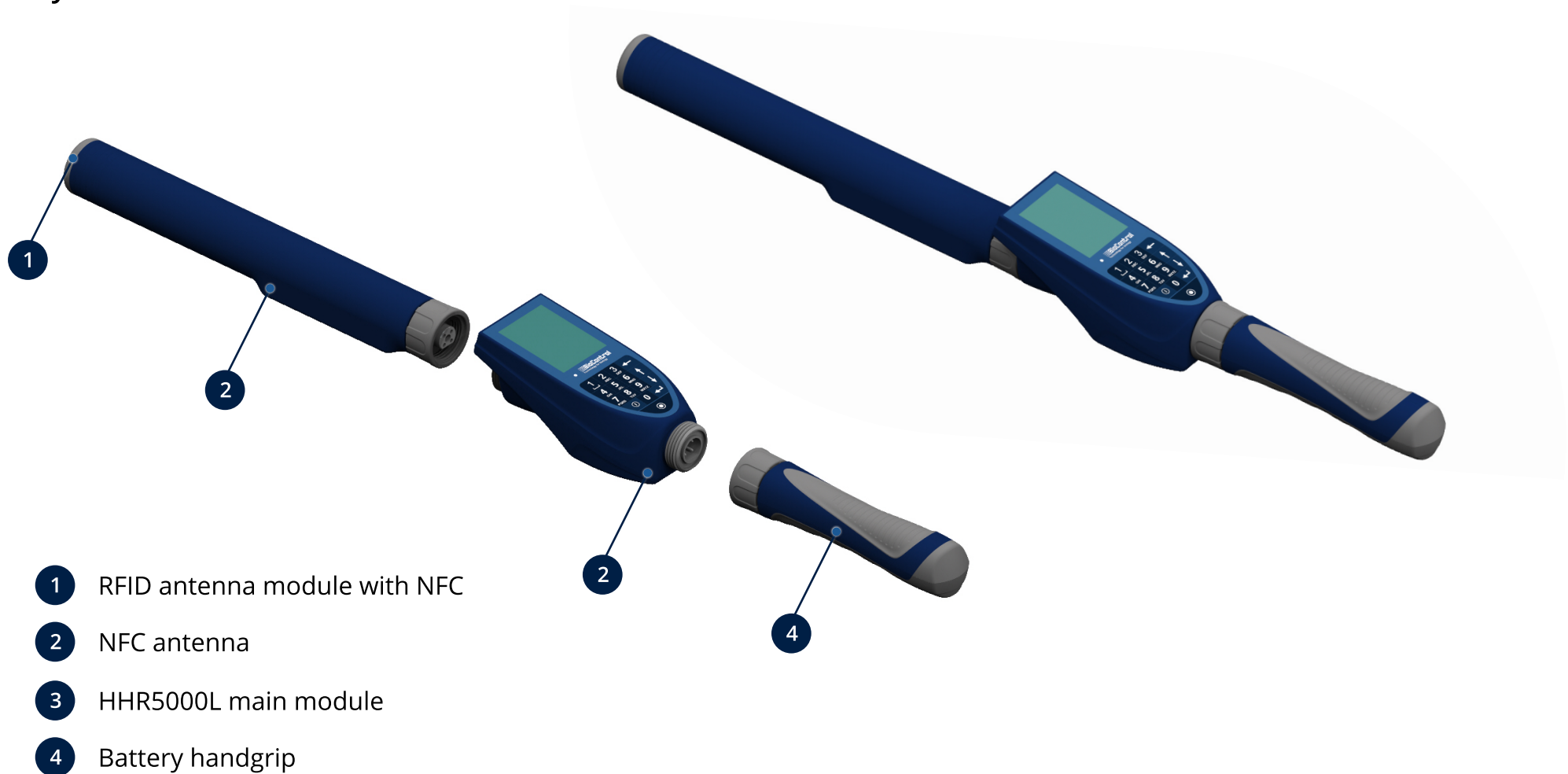



## Layout



# HHR5000L with LCD Display

## Keyboard navigation



	Switches the unit On and if held for more than 3 seconds, off. It is also used to move back to main menu when reading tags.		
	Escape, go to previous menu		Select
	Previous Menu item/field		The number 1 and special functions of space, (.), (\)
	Next Menu item/field		Read Tags