



LM Technologies Ltd

Quick Start Guide LM048 and LM058 Bluetooth Serial Adapters



LM048



LM058

1 Package Contents

Single Retail Pack

1x Bluetooth Serial Adapter
1 x DB9 male to female connector
1 x USB – mini USB cable for power
1 x User Manual (on the CD)
1 x Warranty Card
1 x All in One PSU (UK, EU, US)
1 x 2dBi Antenna (LM058 only)
1 x CD with LM149 Configuration
Software, User Manual
Optional:
1 x LM025 Slim Line 9 pin to 25 pin
converter

Twin Retail Pack

1x Bluetooth Serial Adapter
1 x DB9 male to female connector
1 x USB – mini USB cable for power
1 x User Manual (on the CD)
1 x Warranty Card
1 x All in One PSU (UK, EU, US)
2 x 2dBi Antenna (LM058 only)
1 x CD with LM149 Configuration
Software, User Manual
Optional:
1 x LM025 Slim Line 9 pin to 25 pin
converter

2 Setup

1. Connect LM048/LM058 to the serial port of the PC/Laptop. If the PC or Laptop does not have serial port, a USB to Serial Converter can be used.
2. Power the LM048/LM058 via the mini USB port using the mains power supply or USB port of the PC. The connection to PC is shown in diagram below

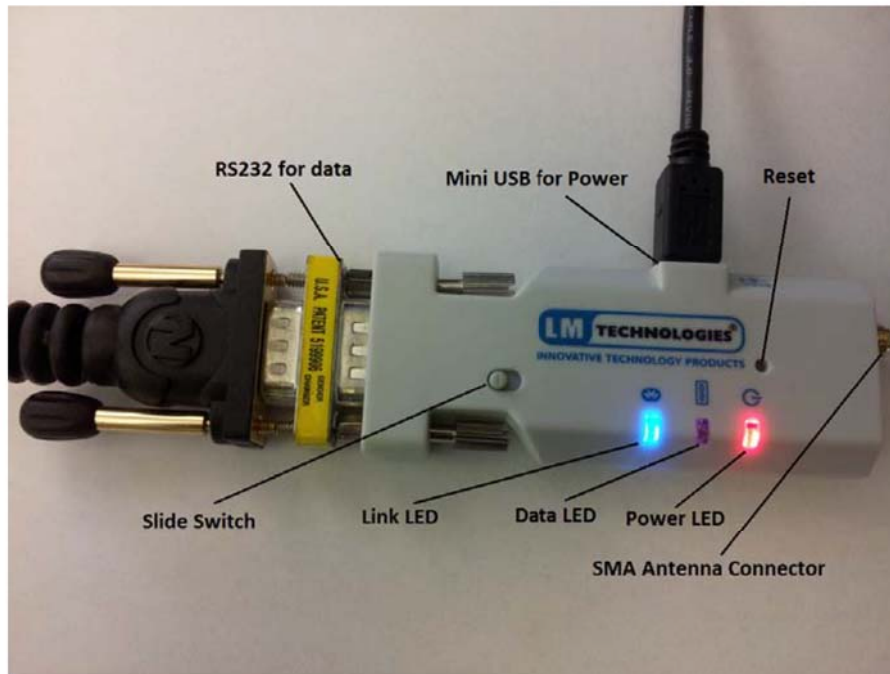

3. Make sure the LM149 Software is installed on the PC. Alternatively you can also use a serial terminal program like Hyperterminal, Putty or Teraterm to configure the adapter using AT Commands. For complete list of AT Command refer LM048&LM058 User Manual.

4. Launch the LM149 Software, select the correct COM Port and Serial Port Settings and press "Read Settings". **The default serial settings on LM048 and LM058 are 19200 8 N 1 Flow: None.**

For the old v4.5x series firmware, the default serial settings are 19200 8 N 1 Flow: Hardware.

5. If the user doesn't know the serial settings on the adapter, then LM149 Software will try all serial settings and find the correct settings. Once the communication with the adapter is established the LM149 Window will be populated with the settings as shown below

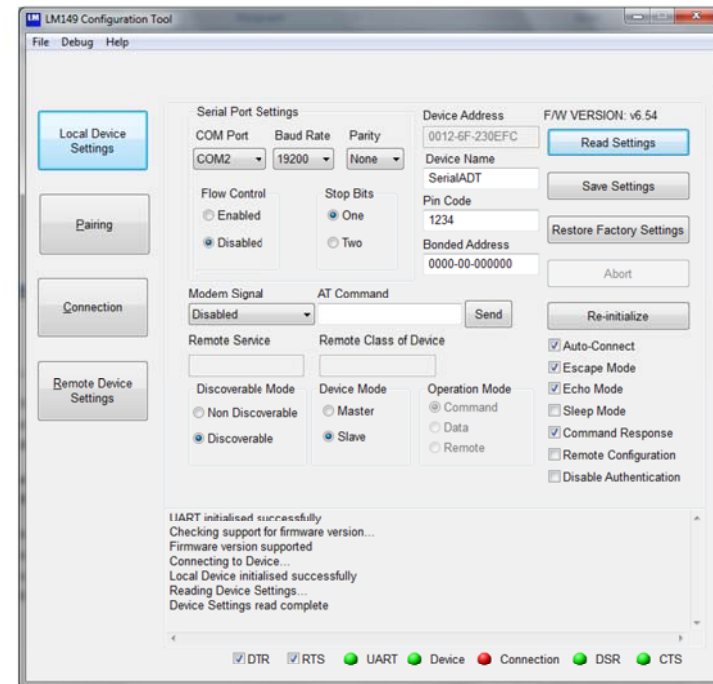

6. Once the communication has been established, user is free to change the settings on the window and press "Save Settings". This will save the modified settings to the adapter.

7. After the settings are saved, the adapter can be plugged to any serial device and will work as a standalone plug and play unit.

3 Cannot communicate with the adapter?

If for some reason, the communication with the adapter cannot be established, the LM149 software will give error "Initialization failed" as shown below.

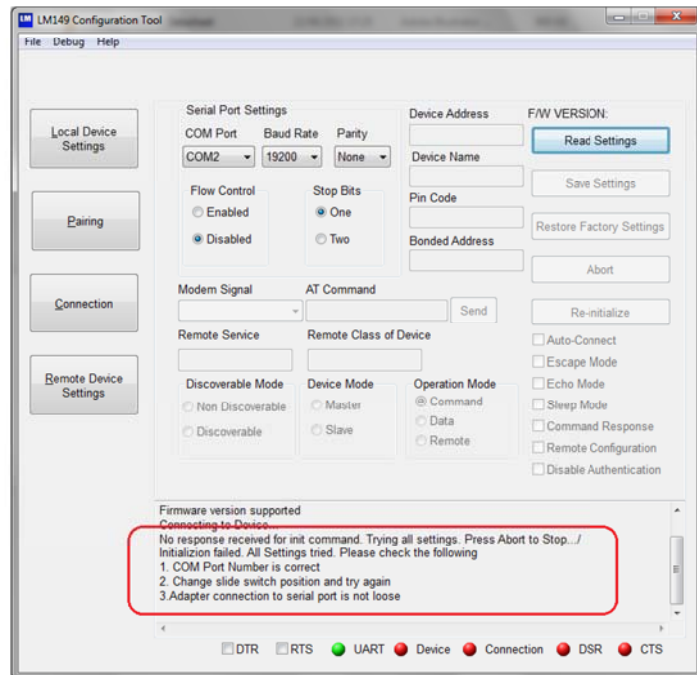

If this happens check the following

- The COM port number is correct.
- The connection between the serial cable and adapter is NOT loose.
- The serial cable is not faulty.
- **Slide Switch Setting:** The slide switch setting is dependent on the serial cable used. The different combinations are shown below

Serial Device/Cable Type	Adapter	Slide Switch Position
Straight	LM048	Towards RS232 connector
	LM058 v6.5x firmware	Away from RS232 connector
	LM058 v4.5x firmware	Towards RS232 connector
Twisted/NULL Modem	LM048	Away from RS232 connector
	LM058 v6.5x firmware	Towards RS232 connector
	LM058 v4.5x firmware	Away from RS232 connector
LM060 (LM Technologies USB-Serial Converter)	LM048	Towards RS232 connector
	LM058 v6.5x firmware	Away from RS232 connector
	LM058 v4.5x firmware	Towards RS232 connector

Note: To check firmware version on LM058, check the sticker on the back. For v6.5x firmware it will mention firmware v6.5x. Otherwise it is v4.5x firmware.

If you are unsure of the cable used, try both slide switch positions.

- **The LED Status** should be as below

POWER (RED)	DATA (AMBER/GREEN)	LINK (BLUE)
ON	OFF	BLINKING
OR		
ON	OFF	OFF

If the BLUE LED is solid, then power off and power ON the adapter or RESET the adapter by pressing RESET pin for 3 seconds. **The BLUE LED should be either blinking or switched off.**

- **Restore Factory Settings:** If the communication is not established even after checking the above points, then restore the factory settings by pressing the reset button with a sharp object for 3 seconds. The 3 LEDs on the adapter will blink 3 times after restore factory settings is successful. Try the LM149 Software after selecting the factory serial settings and communicate again.
- If none of the above work, then contact LM Technologies at support@lm-technologies.com

4 Pairing the Adapters

A pair of LM048 or LM058 adapters can be configured to connect to each other automatically when powered ON. In this mode, the adapters work as serial cable replacement solution. LM149 software can be used to pair 2 adapters with each other. The steps are described below.

1. Setup the 1st adapter with PC/Laptop as described in [Section 2](#)
2. Click the pairing button on LM149 Software to go to pairing window. Click “Pair Device” button. A message will pop up to connect Device 2 to the COM port. Plug out the 1st adapter and connect the 2nd adapter to the serial port and press OK.

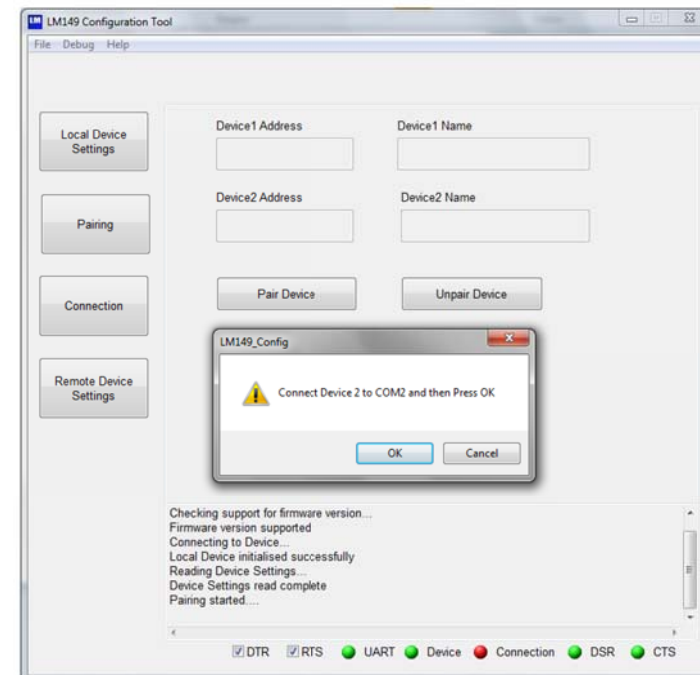

3. A window will pop up to connect the 1st adapter back to the COM port. Connect the 1st adapter back and press OK. The Device1 and Device 2 Name and address will be read as highlighted below.

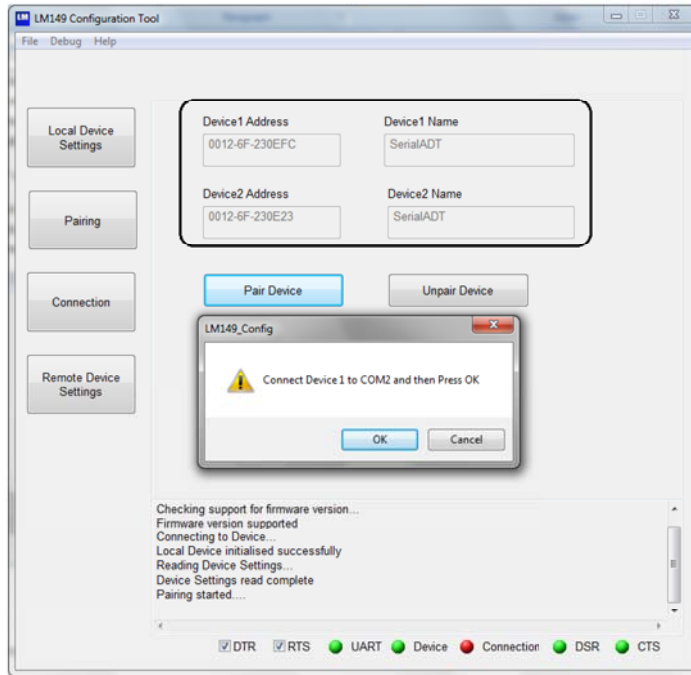

4. After you connect the Device 1 to COM port and press OK, a “pairing completed successfully” message will pop up.

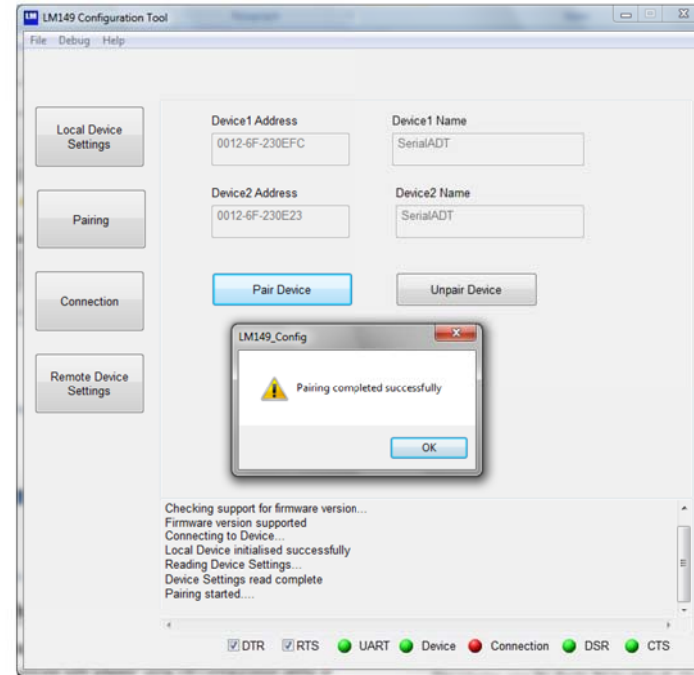

5. If pairing fails, reset both adapters and start pairing again. In case of further issues contact LM Technologies at support@lm-technologies.com

5 Application Setup

A pair of LM048 or LM058 adapters can be used as serial cable replacement solution. However these adapters can also be used with a Bluetooth enabled PC, Laptop, Smartphone, PDA or Tablet.

When used with a PC/Laptop, a virtual Bluetooth Serial Port will be created when service discovery is done on the adapter. Opening the virtual

serial port will create a Bluetooth connection and then communication can be done by sending and receiving data on the virtual serial port.

With a Smartphone, PDA or Tablets, the behavior varies from device to device. On a WinCE or Windows Mobile device, a virtual serial port may be created just like on Windows. On Android, Blackberry, JAVA devices, a customized application can be developed to communicate with the adapters. Communication with iPhone/iPad is not supported yet because a special chip called MFI chip is required on any accessory communicating with Apple devices. LM048/LM058 does not include the MFI chip at the moment. For further information on the roadmap to support Apple products, contact LM Technologies at development@lm-technologies.com

5.1 Serial Cable Replacement Solution Example

The illustration here describes a serial cable replacement solution between a serial printer and PC. However this example can be expanded to any 2 devices which have a serial port like a CNC Machine and CNC Controller or Data logger and PC etc.

The following steps describe setting up a pair of adapters as a serial cable replacement between a PC and Serial Printer.

1. Pair the adapters together as explained in [Section 4](#).
2. Make sure the printer has got a 9 pin serial port connector or a 25 pin to 9 pin converter.
3. Check the specification of the printer for the serial port settings. Most of the serial printers use 9600 8 N 1 flow: None.
4. Configure both adapters to the same serial settings as the printer using the LM149 Software. In this case the settings will be 9600:

baud rate, none: parity, 1: stop bit, none: flow control. Disable the command response on both adapters to avoid ASCII string "CONNECT"/"DISCONNECT" print during connection and disconnection.

5. On the PC install the printer driver on the Serial Port where the serial adapter will be connected.
6. One adapter is connected to the serial port of the PC and the other adapter is connected to the serial port of the printer. If the printer does not provide power on Pin 9, then an external power supply may be required.
7. When both adapters are powered, they should automatically establish Bluetooth connection to each other. Blue LEDs will turn solid ON.
8. After the adapters have established connection, send a test print from the PC. It should be printed on the printer.
9. If there is no print, try changing the slide switch on the adapter connected to printer and check if it resolves the problem?
10. If there is still no print, then there is a serial settings mismatch between the printer and adapter or the PC and adapter. Please recheck the settings or consult printer manual.
11. If still unable to communicate, contact LM Technologies at support@lm-technologies.com

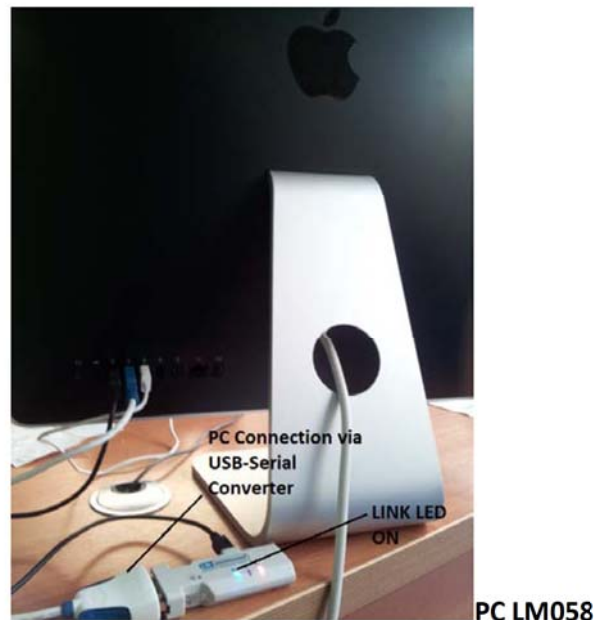
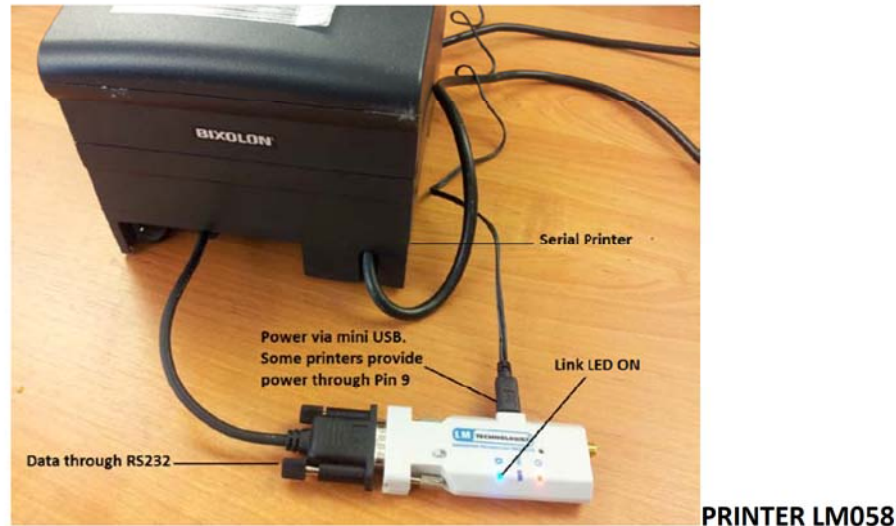

6 FCC Warning Statement

This device complies with Part 15 of the FCC Rules. Operation is subject to the following two conditions:

- 1) This device may not cause harmful interference, and
- 2) This device must accept any interference received, including interference that may cause undesired operation

This equipment has been tested and found to comply with the limits for a class B digital device, pursuant to part 15 of the FCC Rules. These limits are designed to provide reasonable protection against harmful interference in a residential installation. This equipment generates, uses and can radiate radio frequency energy and, if not installed and used in accordance with the instructions, may cause harmful interference to radio communications. However, there is no guarantee that interference will not occur in a particular installation. If this equipment does cause harmful interference to radio or television reception, which can be determined by turning the equipment off and on, the user is encouraged to try to correct the interference by one or more of the following measures:

- Reorient or relocate the receiving antenna.
- Increase the separation between the equipment and receiver.
- Connect the equipment into an outlet on a circuit different from that to which the receiver is connected.
- Consult the dealer or an experienced radio/TV technician for help.

Installation and use of this device must be in strict accordance with the instructions included in the user documentation provided with the product. Any changes or modifications (including the antennas) made to this device that are not expressly approved by the manufacturer may void the user's authority to operate the equipment. The manufacturer is not responsible for any radio or television interference caused by

unauthorized modification of this device, or the substitution of the connecting cables and equipment other than manufacturer specified. It is the responsibility of the user to correct any interference caused by such unauthorized modification, substitution or attachment. Manufacturer and its authorized resellers or distributors will assume no liability for any damage or violation of government regulations arising from failing to comply with these guidelines.

This equipment complies with FCC radiation exposure limits set forth for an uncontrolled environment. This transmitter must not be co-located or operating in conjunction with any other antenna or transmitter.

7 Revision History

Version	Date	Description
v1.0	22-03-2012	First Version
v1.1	30-03-2012	1. Updated slide switch settings point in Section 3 to include LM060 (USB-Serial Converter) 2. Added Revision History
v1.2	05-04-2012	1. Added slide switch setting for LM058 with v4.5x firmware in Section 3
v1.3	25-06-2012	1. Add FCC Warning Statement
v1.4	12-02-2014	1. Correct packaging information