



## FCC 47 CFR PART 15 SUBPART B

Product Type : Mobile Broadband Module  
Applicant : Ericsson AB  
Address : Lindholmspiren 11, 417 56 Gothenburg, Sweden  
Trade Name : Ericsson  
Model Number : N5321  
Type Number : KRD 131 30/1  
Other identification of the product : FCC ID : VV7-MBMN5321  
IC : 287AG-MBMN5321  
Final HW version : R1  
Final SW version : R3C11  
Test Specification : FCC 47 CFR PART 15 SUBPART B: Oct., 2011  
ANSI C63.4: 2009  
CISPR 22: 1997  
ICES-003: Issue 5  
Receive Date : Nov. 29, 2012  
Test Period : Dec. 01 ~ 05, 2012  
Issue Date : Dec. 21, 2012

### Issue by

A Test Lab Techno Corp.  
No. 140-1, Changan Street, Bade City,  
Taoyuan County 334, Taiwan R.O.C.  
Tel : +886-3-2710188 / Fax : +886-3-2710190



Taiwan Accreditation Foundation accreditation number: 1330

**Note:** This report shall not be reproduced except in full, without the written approval of A Test Lab Techno Corp. This document may be altered or revised by A Test Lab Techno Corp. personnel only, and shall be noted in the revision section of the document. The client should not use it to claim product endorsement by TAF, or any government agencies. The test results in the report only apply to the tested sample.

**Revision History**

Rev.	Issue Date	Revisions	Revised By
00	Dec. 12, 2012	Initial Issue	
01	Dec. 21, 2012	Add product information.	Joyce Liao

## Verification of Compliance

Issued Date: 12/21/2012



Product Type : Mobile Broadband Module  
Applicant : Ericsson AB  
Address : Lindholmspiren 11, 417 56 Gothenburg, Sweden  
Trade Name : Ericsson  
Model Number : N5321  
FCC ID : VV7-MBMN5321  
IC : 287AG-MBMN5321  
EUT Rated Voltage : DC 3.3V  
Test Voltage : 120 Vac / 60 Hz  
Applicable Standard : FCC 47 CFR PART 15 SUBPART B: Oct., 2011  
ANSI C63.4: 2009  
CISPR 22: 1997  
ICES-003: Issue 5

Test Result : Complied

Performing Lab. : A Test Lab Techno Corp.  
No. 140-1, Changan Street, Bade City,  
Taoyuan County 334, Taiwan R.O.C.  
Tel : +886-3-2710188 / Fax : +886-3-2710190  
Taiwan Accreditation Foundation accreditation number: 1330  
<http://www.atl-lab.com.tw/e-index.htm>



The above equipment has been tested by A Test Lab Techno Corp., and found compliance with the requirements set forth in the technical standards mentioned above. The results of testing in this report apply only to the product/system, which was tested. Other similar equipment will not necessarily produce the same results due to production tolerance and measurement uncertainties.

Approved By :  Reviewed By :   
(Manager) (Murphy Wang) (Testing Engineer) (Frank Lin)

## TABLE OF CONTENTS

<b>1</b>	<b>General Information .....</b>	<b>5</b>
<b>2</b>	<b>EUT Description.....</b>	<b>6</b>
<b>3</b>	<b>Test Methodology.....</b>	<b>7</b>
3.1.	Decision of Test Mode .....	7
3.2.	EUT Exercise Software.....	7
3.3.	Configuration of Test System Details .....	8
3.4.	Test Site Environment.....	9
<b>4</b>	<b>Emission Test .....</b>	<b>10</b>
4.1.	Conducted Emission Measurement .....	10
4.2.	Radiated Interference Measurement .....	22

## 1 General Information

### 1.1 Summary of Test Result

Emission			
Standard	Item	Result	Remark
FCC 47 CFR PART 15 SUBPART B ANSI C63.4 ICES-003	Conducted Emission	PASS	Meet Class B limit
FCC 47 CFR PART 15 SUBPART B ANSI C63.4 ICES-003	Radiated Emission	PASS	Meet Class B limit

The test results of this report relate only to the tested sample(s) identified in this report. Manufacturer or whom it may concern should recognize the pass or fail of the test result.

### 1.2 Measurement Uncertainty

#### Conducted Emission

The measurement uncertainty is evaluated as  $\pm 2.24$  dB.

#### Conducted Emissions (Telecommunication Ports)

The measurement uncertainty is evaluated as  $\pm 2.24$  dB.

#### Radiated Emission

The measurement uncertainty of 30 MHz - 1GHz is evaluated as  $\pm 3.072$ dB.

The measurement uncertainty of 1GHz - 40GHz is evaluated as  $\pm 3.072$ dB.

## 2 EUT Description

Product	Mobile Broadband Module
Trade Name	Ericsson
Model Number	N5321
FCC ID	VV7-MBMN5321
IC	287AG-MBMN5321
Applicant	Ericsson AB Lindholmospiren 11, 417 56 Gothenburg, Sweden
Manufacturer	Ericsson AB Lindholmospiren 11, 417 56 Gothenburg, Sweden

### I/O Port Description :

I/O Port Types	Q'TY	Test Description
1). Signal Port	1	Connected to Fixture

### 3 Test Methodology

#### 3.1. Decision of Test Mode

3.1.1. The following test mode(s) were scanned during the preliminary test:

Pre-Test Mode
Mode 1: GPRS 850 Link Mode
Mode 2: GPRS 1900 Link Mode
Mode 3: WCDMA Band II Link Mode
Mode 4: WCDMA Band V Link Mode
Mode 5: GPS Link Mode

3.1.2. After the preliminary scan, the following test mode was found to produce the highest emission level.

Final Test Mode			
Emission	Conducted Emission		Mode 1 / Mode 2 / Mode 3 / Mode 4 / Mode 5
	Radiated Emission	Below 1GHz	Mode 1 / Mode 2 / Mode 3 / Mode 4 / Mode 5
		Above 1GHz	Mode 1 / Mode 2 / Mode 3 / Mode 4 / Mode 5

Then, the above highest emission mode of the configuration of the EUT and cable was chosen for all final test items.

#### 3.2. EUT Exercise Software

1	Setup the EUT and simulators as shown on 3.3.
2	Turn on the power of all equipment.
3	EUT link to CMU200.
4	Turn on EUT's GPS function and Link Signal Generator.
5	The EUT will start to operate function.

### 3.3. Configuration of Test System Details

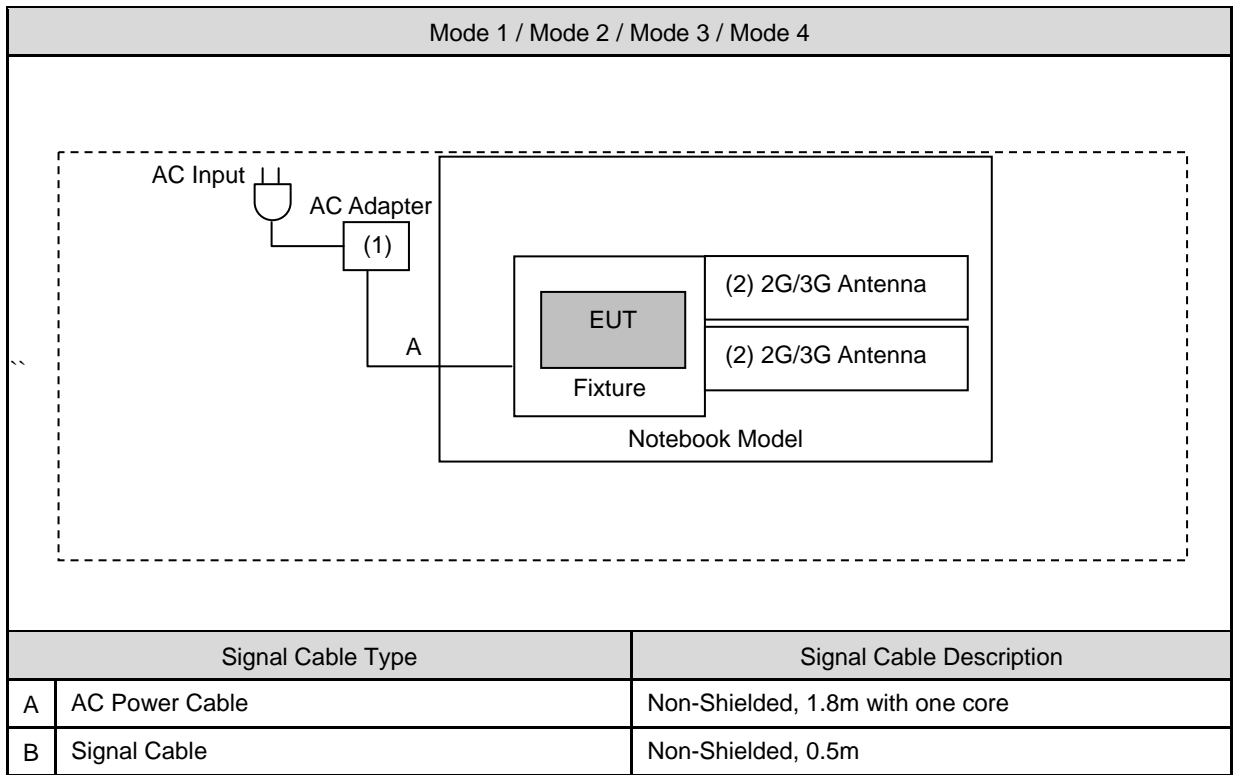

Devices Description					
Product	Manufacturer	Model Number	Serial Number	Power Cord	
(1)	AC Adapter	NORDIC	SA115C-05	N/A	Non-Shielded, 1.8m with one core
(2)	2G/3G Antenna	Ericsson	Laptop simulator antenna (Control number 31356/01)	N/A	N/A



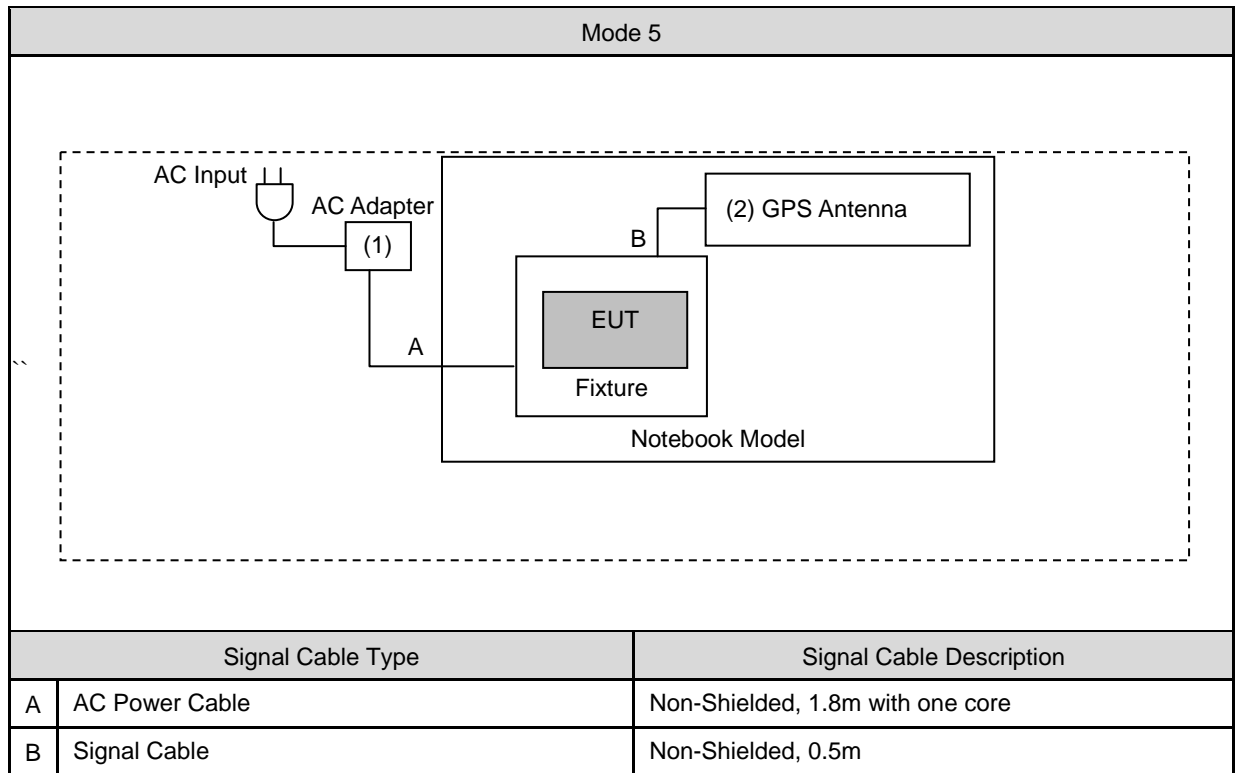

Devices Description					
	Product	Manufacturer	Model Number	Serial Number	Power Cord
(1)	AC Adapter	NORDIC	SA115C-05	N/A	Non-Shielded, 1.8m with one core
(2)	GPS Antenna	N/A	N/A	N/A	N/A

### 3.4. Test Site Environment

Items	Test Item	Required (IEC 68-1)	Actual
Temperature (°C)	FCC part 15: 15.107 Conducted Emission	15-35	26
Humidity (%RH)		25-75	60
Barometric pressure (mbar)		860-1060	950
Temperature (°C)	FCC part 15: 15.109 Radiated Emission	15-35	26
Humidity (%RH)		25-75	60
Barometric pressure (mbar)		860-1060	950

## 4 Emission Test

### 4.1. Conducted Emission Measurement

#### 4.1.1. Limit

A.C. Mains Conducted Interference Limit

Frequency (MHz)	Class A (dBuV)		Class B (dBuV)	
	Quasi-peak	Average	Quasi-peak	Average
0.15 - 0.5	79	66	66 - 56	56 - 46
0.50 - 5.0	73	60	56	46
5.0 - 30.0	73	60	60	50

Note: (1) The lower limit shall apply at the transition frequencies.

(2) The limit decreases in line with the logarithm of the frequency in the range 0.15 to 0.50 MHz.

#### 4.1.2. Test Instruments

Equipment	Manufacturer	Model Number	Serial Number	Cal. Date	Remark
Test Receiver	R&S	ESCI	100367	06/18/2012	(1)
LISN	R&S	ENV216	101040	03/07/2012	(1)
LISN	R&S	ENV216	101041	03/07/2012	(1)
Universal Radio Communication Tester	R&S	CMU200	109369	08/07/2012	(2)
Signal Generator	R&S	SMU200A	102598	02/23/2012	(1)
Test Site	ATL	TE02	TE02	N.C.R.	-----

Remark: (1) Calibration period 1 year. (2) Calibration period 2 years.

Note: N.C.R. = No Calibration Request.

#### 4.1.3. Test Setup

A.C. mains setup

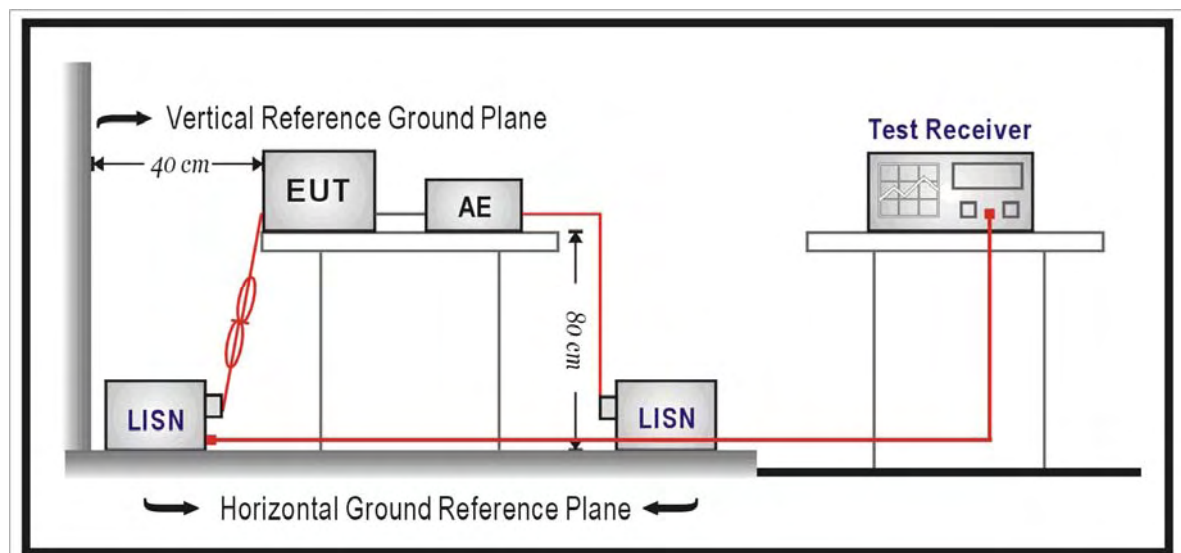

#### 4.1.4. Test Procedure

The EUT and simulators are connected to the main power through a line impedance stabilization network (L.I.S.N.). This provides a 50 ohm /50uH coupling impedance for the measuring equipment. The peripheral devices are also connected to the main power through a LISN that provides a 50ohm/50uH coupling impedance with 50ohm termination.

For A.C. mains conducted interference, measured both sides of A.C. lines and carried out using quasi-peak and average detector receivers of maximum conducted interference.

Conducted emissions were investigated over the frequency range from 0.15 MHz to 30 MHz using a receiver bandwidth of 9 kHz. The equipment under test (EUT) shall be meet the limits in section 4.1.1, as applicable, including the average limit and the quasi-peak limit when using respectively, an average detector and quasi-peak detector measured in accordance with the methods described of related standard. The voltage limits shall be met. If the average limit is met when using a quasi-peak detector receiver, the EUT shall be deemed to meet both limits and measurement with the average detector receiver is unnecessary.

If the reading of the measuring receiver shows fluctuations close to the limit, the reading shall be observed for at least 15 s at each measurement frequency; the higher reading shall be recorded with the exception of any brief isolated high reading which shall be ignored.

**4.1.5. Test Result**

Standard:	FCC Part 15B Class B	Line:	L1
Test item:	Conducted Emission	Power:	AC 120V/60Hz
Model Number:	N5321	Temp.(°C)/Hum.(%RH):	26(°C)/60%RH
Mode:	1	Date:	12/01/2012
		Test By:	Frank Lin
Description:			

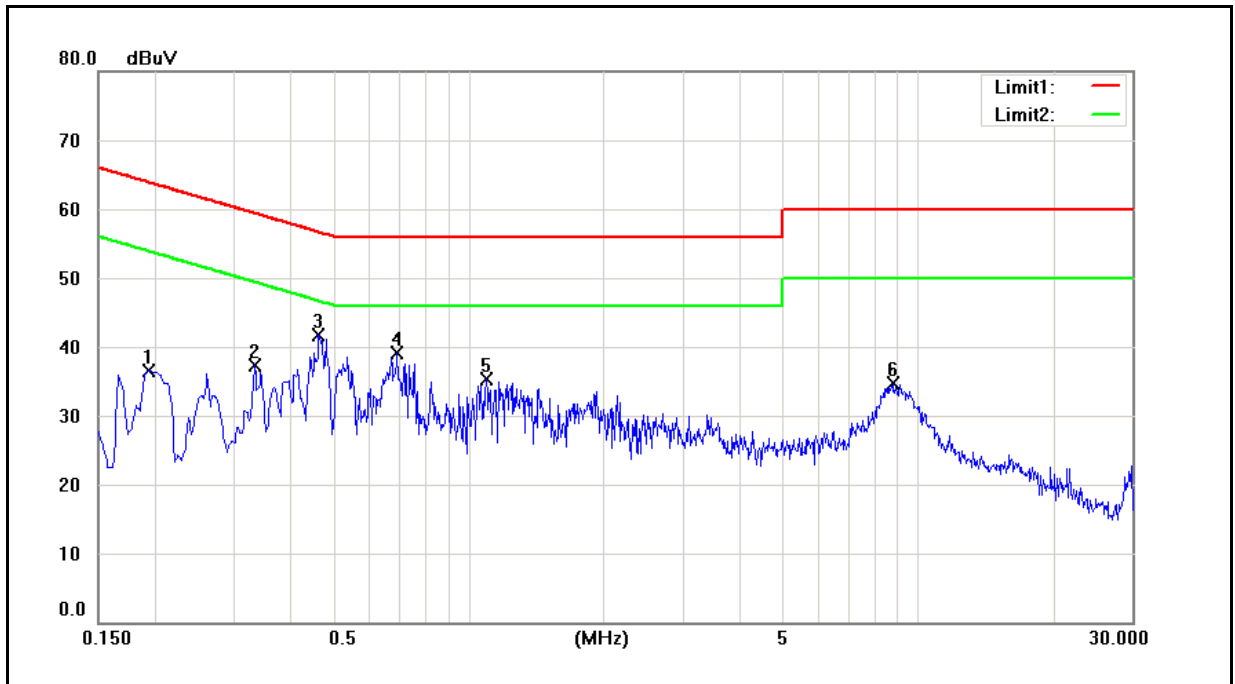

No.	Frequency (MHz)	QP reading (dBuV)	AVG reading (dBuV)	Correction factor (dB)	QP result (dBuV)	AVG result (dBuV)	QP limit (dBuV)	AVG limit (dBuV)	QP margin (dB)	AVG margin (dB)	Remark
1	0.1940	26.82	15.87	9.72	36.54	25.59	63.86	53.86	-27.32	-28.27	Pass
2	0.3340	21.13	11.27	9.72	30.85	20.99	59.35	49.35	-28.50	-28.36	Pass
3	0.4660	25.13	14.23	9.72	34.85	23.95	56.58	46.58	-21.73	-22.63	Pass
4	0.6940	24.58	12.13	9.72	34.30	21.85	56.00	46.00	-21.70	-24.15	Pass
5	1.0940	19.66	9.03	9.73	29.39	18.76	56.00	46.00	-26.61	-27.24	Pass
6	8.8180	19.65	9.46	10.17	29.82	19.63	60.00	50.00	-30.18	-30.37	Pass

Standard:	FCC Part 15B Class B	Line:	N
Test item:	Conducted Emission	Power:	AC 120V/60Hz
Model Number:	N5321	Temp.(°C)/Hum.(%RH):	26(°C)/60%RH
Mode:	1	Date:	12/01/2012
		Test By:	Frank Lin
Description:			

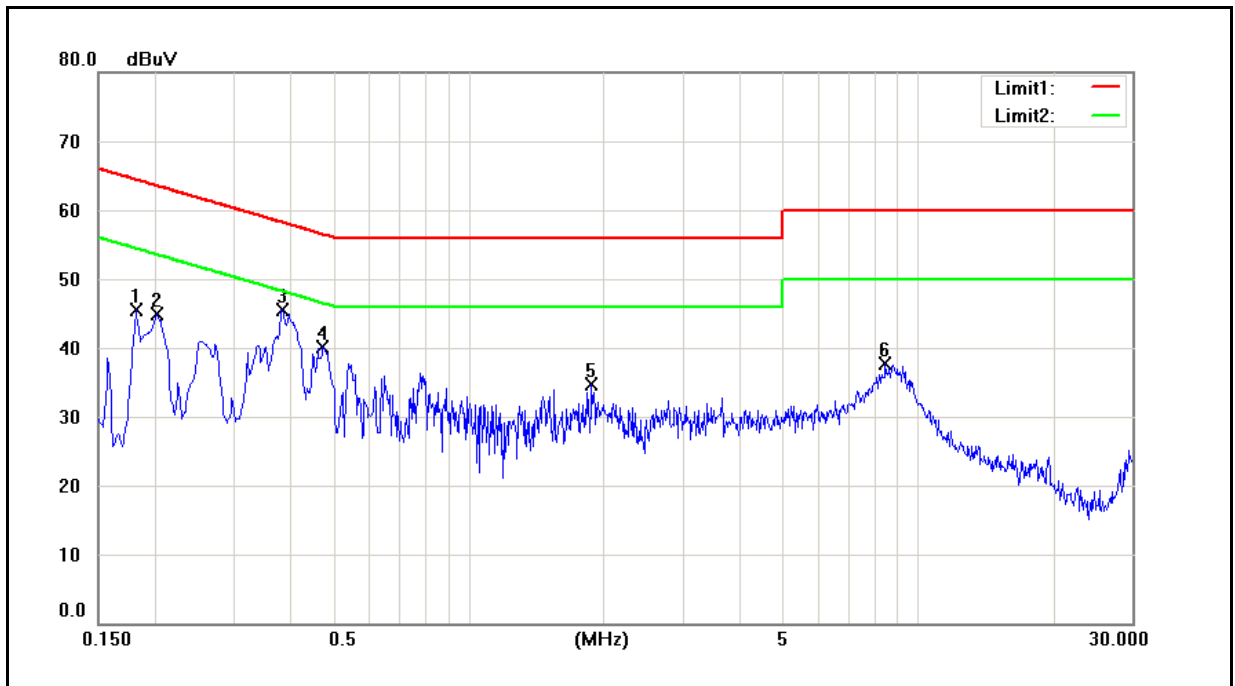

No.	Frequency (MHz)	QP reading (dBuV)	AVG reading (dBuV)	Correction factor (dB)	QP result (dBuV)	AVG result (dBuV)	QP limit (dBuV)	AVG limit (dBuV)	QP margin (dB)	AVG margin (dB)	Remark
1	0.1820	25.93	14.70	9.64	35.57	24.34	64.39	54.39	-28.82	-30.05	Pass
2	0.2020	32.60	22.04	9.64	42.24	31.68	63.53	53.53	-21.29	-21.85	Pass
3	0.3860	32.36	21.20	9.64	42.00	30.84	58.15	48.15	-16.15	-17.31	Pass
4	0.4740	28.05	17.24	9.64	37.69	26.88	56.44	46.44	-18.75	-19.56	Pass
5	1.8780	20.02	11.37	9.72	29.74	21.09	56.00	46.00	-26.26	-24.91	Pass
6	8.4580	22.40	12.15	10.12	32.52	22.27	60.00	50.00	-27.48	-27.73	Pass

Standard:	FCC Part 15B Class B	Line:	L1
Test item:	Conducted Emission	Power:	AC 120V/60Hz
Model Number:	N5321	Temp.(°C)/Hum.(%RH):	26(°C)/60%RH
Mode:	2	Date:	12/01/2012
		Test By:	Frank Lin
Description:			

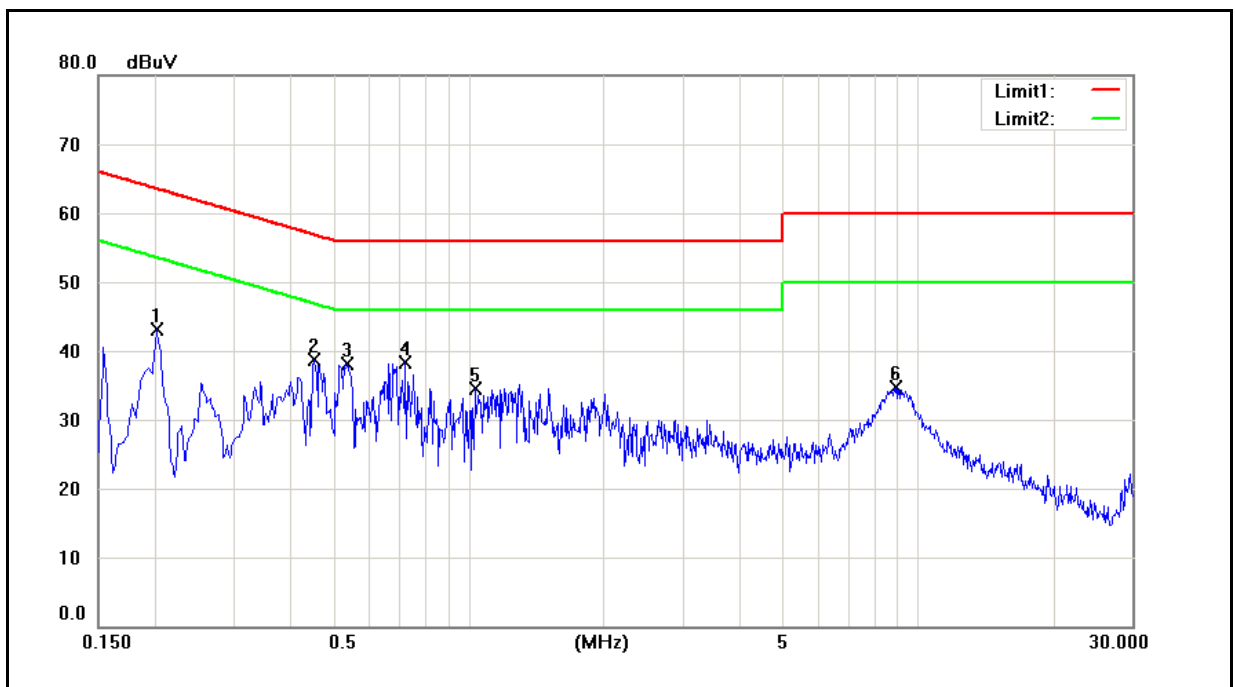

No.	Frequency (MHz)	QP reading (dBuV)	AVG reading (dBuV)	Correction factor (dB)	QP result (dBuV)	AVG result (dBuV)	QP limit (dBuV)	AVG limit (dBuV)	QP margin (dB)	AVG margin (dB)	Remark
1	0.2020	25.68	15.77	9.72	35.40	25.49	63.53	53.53	-28.13	-28.04	Pass
2	0.4540	25.83	13.77	9.72	35.55	23.49	56.80	46.80	-21.25	-23.31	Pass
3	0.5380	24.51	11.78	9.72	34.23	21.50	56.00	46.00	-21.77	-24.50	Pass
4	0.7260	23.15	12.51	9.72	32.87	22.23	56.00	46.00	-23.13	-23.77	Pass
5	1.0340	19.05	7.89	9.73	28.78	17.62	56.00	46.00	-27.22	-28.38	Pass
6	8.9460	19.75	9.79	10.17	29.92	19.96	60.00	50.00	-30.08	-30.04	Pass

Standard:	FCC Part 15B Class B	Line:	N
Test item:	Conducted Emission	Power:	AC 120V/60Hz
Model Number:	N5321	Temp.(°C)/Hum.(%RH):	26(°C)/60%RH
Mode:	2	Date:	12/01/2012
		Test By:	Frank Lin
Description:			

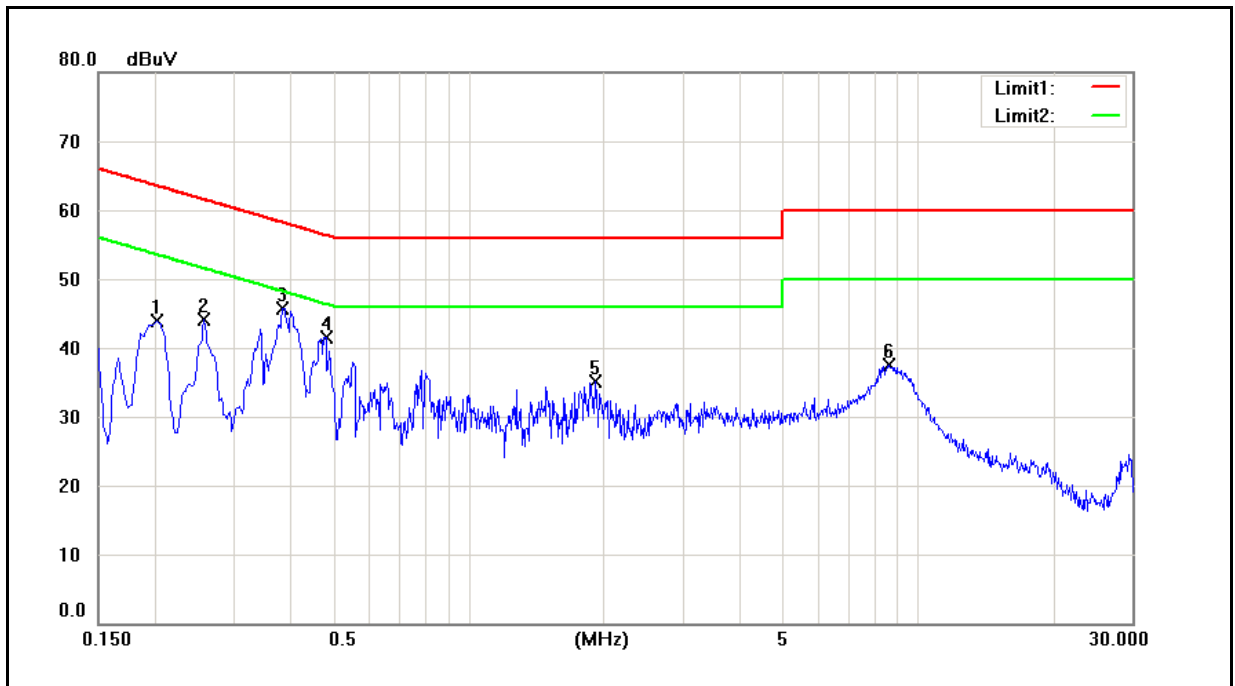

No.	Frequency (MHz)	QP reading (dBuV)	AVG reading (dBuV)	Correction factor (dB)	QP result (dBuV)	AVG result (dBuV)	QP limit (dBuV)	AVG limit (dBuV)	QP margin (dB)	AVG margin (dB)	Remark
1	0.2020	32.71	22.09	9.64	42.35	31.73	63.53	53.53	-21.18	-21.80	Pass
2	0.2580	29.05	18.81	9.64	38.69	28.45	61.50	51.50	-22.81	-23.05	Pass
3	0.3860	32.47	21.00	9.64	42.11	30.64	58.15	48.15	-16.04	-17.51	Pass
4	0.4820	28.53	17.89	9.64	38.17	27.53	56.30	46.30	-18.13	-18.77	Pass
5	1.9100	17.05	10.20	9.72	26.77	19.92	56.00	46.00	-29.23	-26.08	Pass
6	8.6620	22.48	12.18	10.12	32.60	22.30	60.00	50.00	-27.40	-27.70	Pass

Standard:	FCC Part 15B Class B	Line:	L1
Test item:	Conducted Emission	Power:	AC 120V/60Hz
Model Number:	N5321	Temp.(°C)/Hum.(%RH):	26(°C)/60%RH
Mode:	3	Date:	12/01/2012
		Test By:	Frank Lin
Description:			

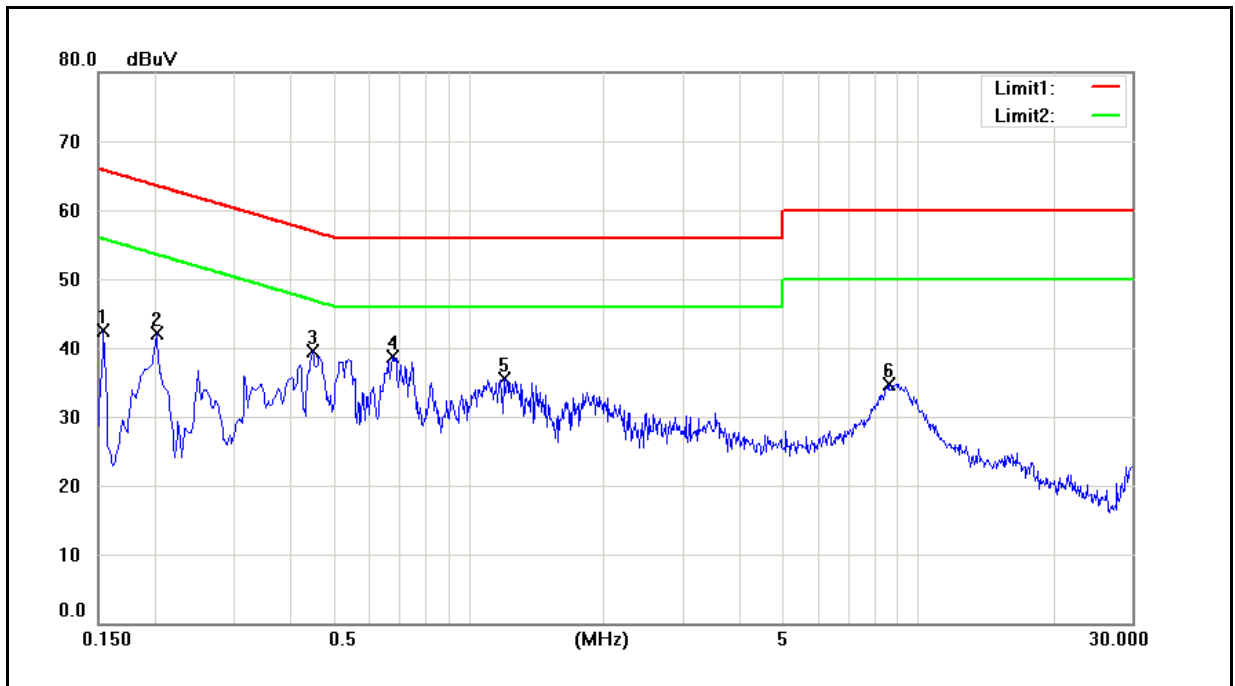

No.	Frequency (MHz)	QP reading (dBuV)	AVG reading (dBuV)	Correction factor (dB)	QP result (dBuV)	AVG result (dBuV)	QP limit (dBuV)	AVG limit (dBuV)	QP margin (dB)	AVG margin (dB)	Remark
1	0.1540	21.69	10.24	9.72	31.41	19.96	65.78	55.78	-34.37	-35.82	Pass
2	0.2020	25.63	15.91	9.72	35.35	25.63	63.53	53.53	-28.18	-27.90	Pass
3	0.4500	25.83	13.07	9.72	35.55	22.79	56.88	46.88	-21.33	-24.09	Pass
4	0.6820	24.56	11.06	9.72	34.28	20.78	56.00	46.00	-21.72	-25.22	Pass
5	1.2020	19.94	8.54	9.74	29.68	18.28	56.00	46.00	-26.32	-27.72	Pass
6	8.5940	19.32	9.48	10.16	29.48	19.64	60.00	50.00	-30.52	-30.36	Pass



Standard:	FCC Part 15B Class B	Line:	N
Test item:	Conducted Emission	Power:	AC 120V/60Hz
Model Number:	N5321	Temp.(°C)/Hum.(%RH):	26(°C)/60%RH
Mode:	3	Date:	12/01/2012
		Test By:	Frank Lin
Description:			

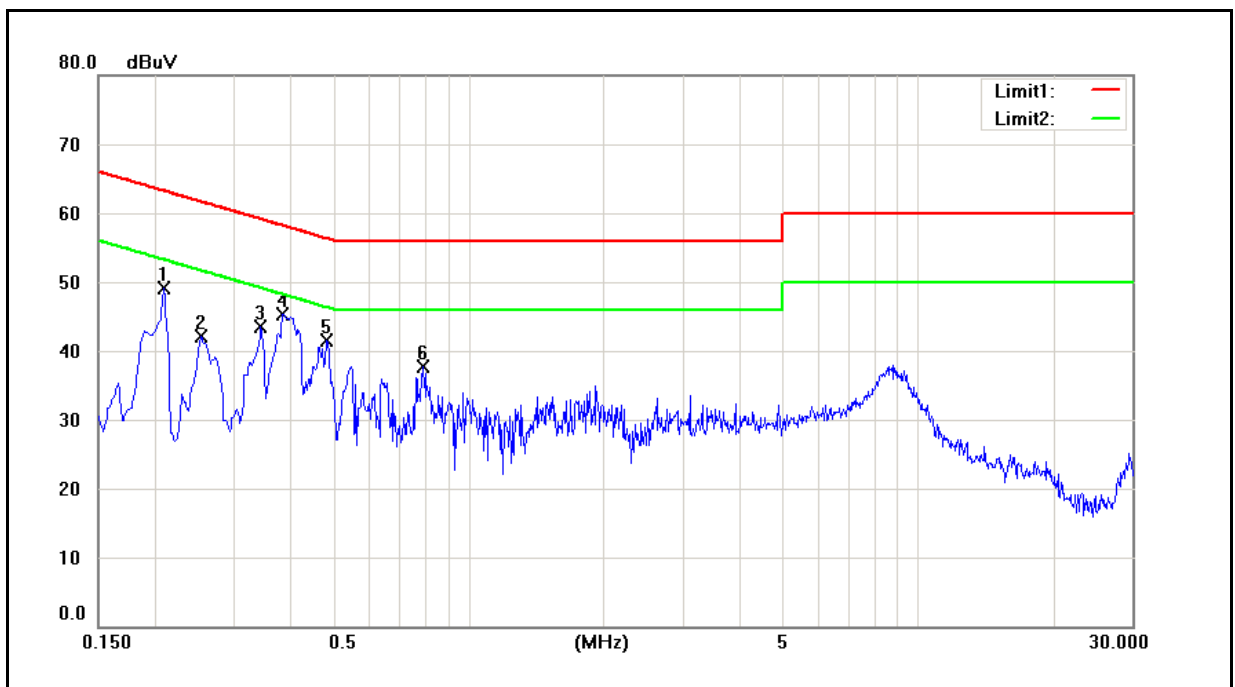

No.	Frequency (MHz)	QP reading (dBuV)	AVG reading (dBuV)	Correction factor (dB)	QP result (dBuV)	AVG result (dBuV)	QP limit (dBuV)	AVG limit (dBuV)	QP margin (dB)	AVG margin (dB)	Remark
1	0.2100	30.69	17.37	9.64	40.33	27.01	63.21	53.21	-22.88	-26.20	Pass
2	0.2540	29.06	17.88	9.64	38.70	27.52	61.63	51.63	-22.93	-24.11	Pass
3	0.3460	29.03	15.20	9.64	38.67	24.84	59.06	49.06	-20.39	-24.22	Pass
4	0.3860	32.41	21.06	9.64	42.05	30.70	58.15	48.15	-16.10	-17.45	Pass
5	0.4860	28.61	18.06	9.64	38.25	27.70	56.24	46.24	-17.99	-18.54	Pass
6	0.7940	22.59	10.41	9.67	32.26	20.08	56.00	46.00	-23.74	-25.92	Pass

Standard:	FCC Part 15B Class B	Line:	L1
Test item:	Conducted Emission	Power:	AC 120V/60Hz
Model Number:	N5321	Temp.(°C)/Hum.(%RH):	26(°C)/60%RH
Mode:	4	Date:	12/01/2012
		Test By:	Frank Lin
Description:			

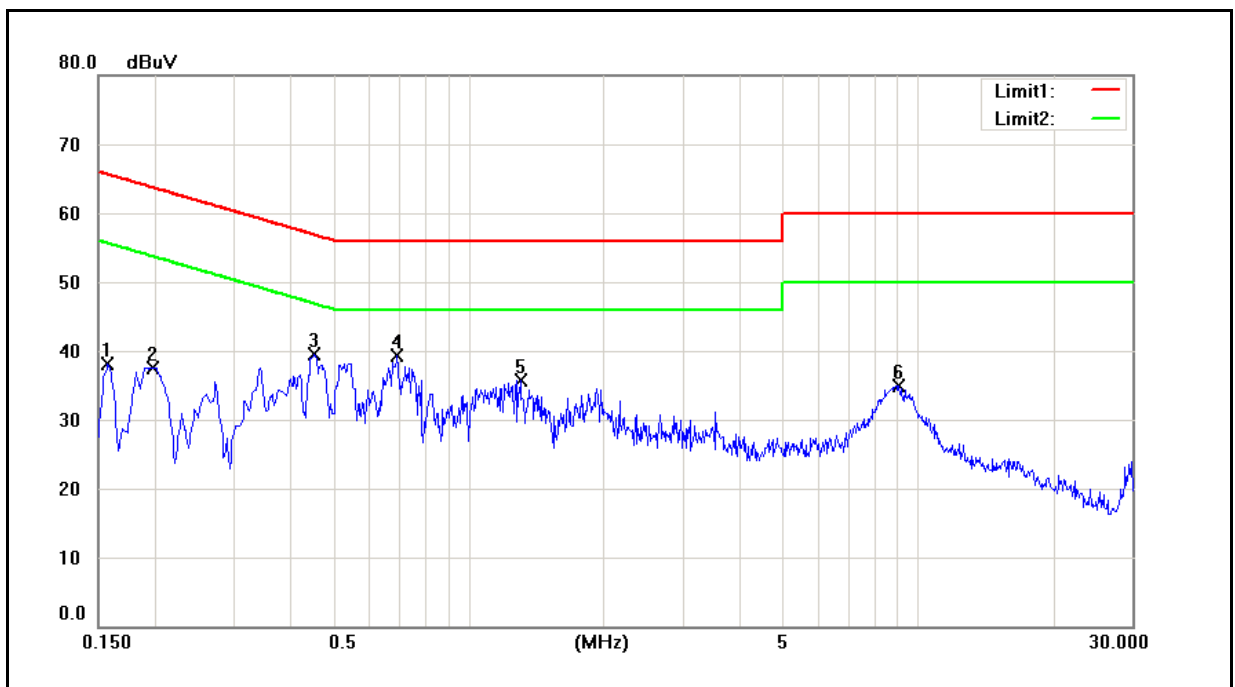

No.	Frequency (MHz)	QP reading (dBuV)	AVG reading (dBuV)	Correction factor (dB)	QP result (dBuV)	AVG result (dBuV)	QP limit (dBuV)	AVG limit (dBuV)	QP margin (dB)	AVG margin (dB)	Remark
1	0.1580	24.56	7.46	9.72	34.28	17.18	65.57	55.57	-31.29	-38.39	Pass
2	0.1980	26.05	16.89	9.72	35.77	26.61	63.69	53.69	-27.92	-27.08	Pass
3	0.4540	25.86	13.78	9.72	35.58	23.50	56.80	46.80	-21.22	-23.30	Pass
4	0.6940	24.73	12.23	9.72	34.45	21.95	56.00	46.00	-21.55	-24.05	Pass
5	1.3060	19.68	9.37	9.75	29.43	19.12	56.00	46.00	-26.57	-26.88	Pass
6	9.0860	19.53	9.56	10.17	29.70	19.73	60.00	50.00	-30.30	-30.27	Pass

Standard:	FCC Part 15B Class B	Line:	N
Test item:	Conducted Emission	Power:	AC 120V/60Hz
Model Number:	N5321	Temp.(°C)/Hum.(%RH):	26(°C)/60%RH
Mode:	4	Date:	12/01/2012
		Test By:	Frank Lin
Description:			

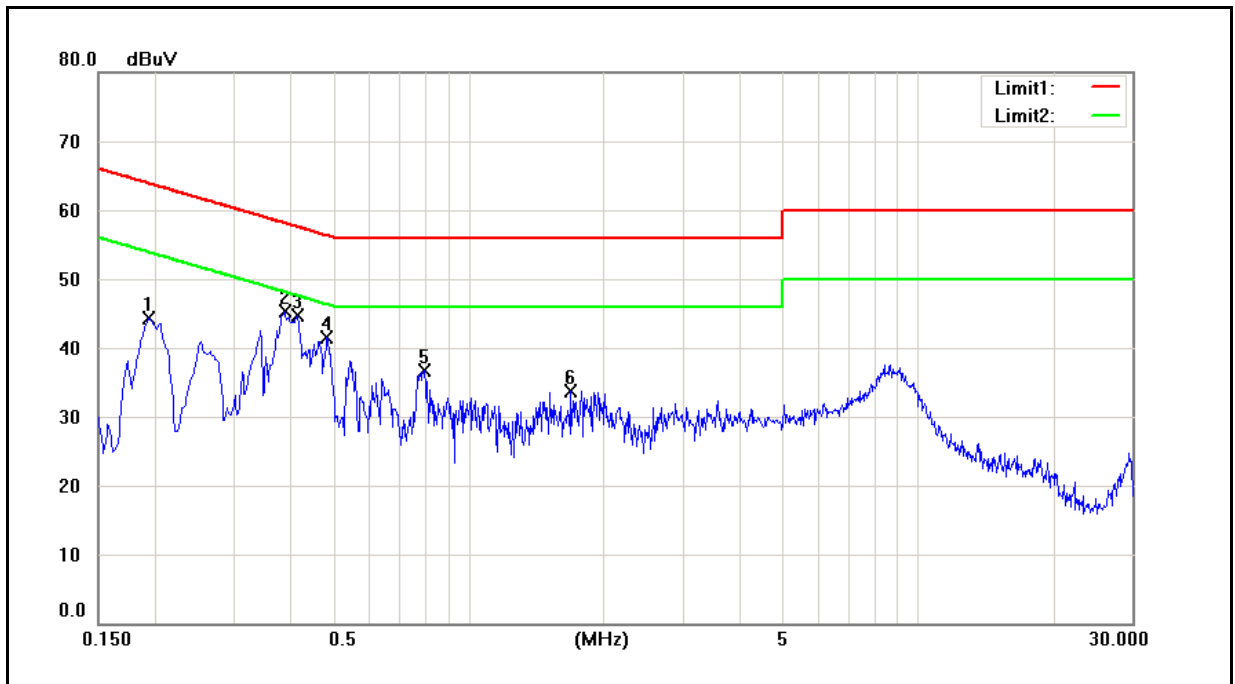

No.	Frequency (MHz)	QP reading (dBuV)	AVG reading (dBuV)	Correction factor (dB)	QP result (dBuV)	AVG result (dBuV)	QP limit (dBuV)	AVG limit (dBuV)	QP margin (dB)	AVG margin (dB)	Remark
1	0.1940	33.02	21.99	9.64	42.66	31.63	63.86	53.86	-21.20	-22.23	Pass
2	0.3900	32.53	21.65	9.64	42.17	31.29	58.06	48.06	-15.89	-16.77	Pass
3	0.4180	29.54	17.00	9.64	39.18	26.64	57.49	47.49	-18.31	-20.85	Pass
4	0.4860	28.58	18.31	9.64	38.22	27.95	56.24	46.24	-18.02	-18.29	Pass
5	0.7980	22.45	10.96	9.67	32.12	20.63	56.00	46.00	-23.88	-25.37	Pass
6	1.6980	18.74	9.98	9.71	28.45	19.69	56.00	46.00	-27.55	-26.31	Pass

Standard:	FCC Part 15B Class B	Line:	L1
Test item:	Conducted Emission	Power:	AC 120V/60Hz
Model Number:	N5321	Temp.(°C)/Hum.(%RH):	26(°C)/60%RH
Mode:	5	Date:	12/05/2012
		Test By:	Frank Lin
Description:			

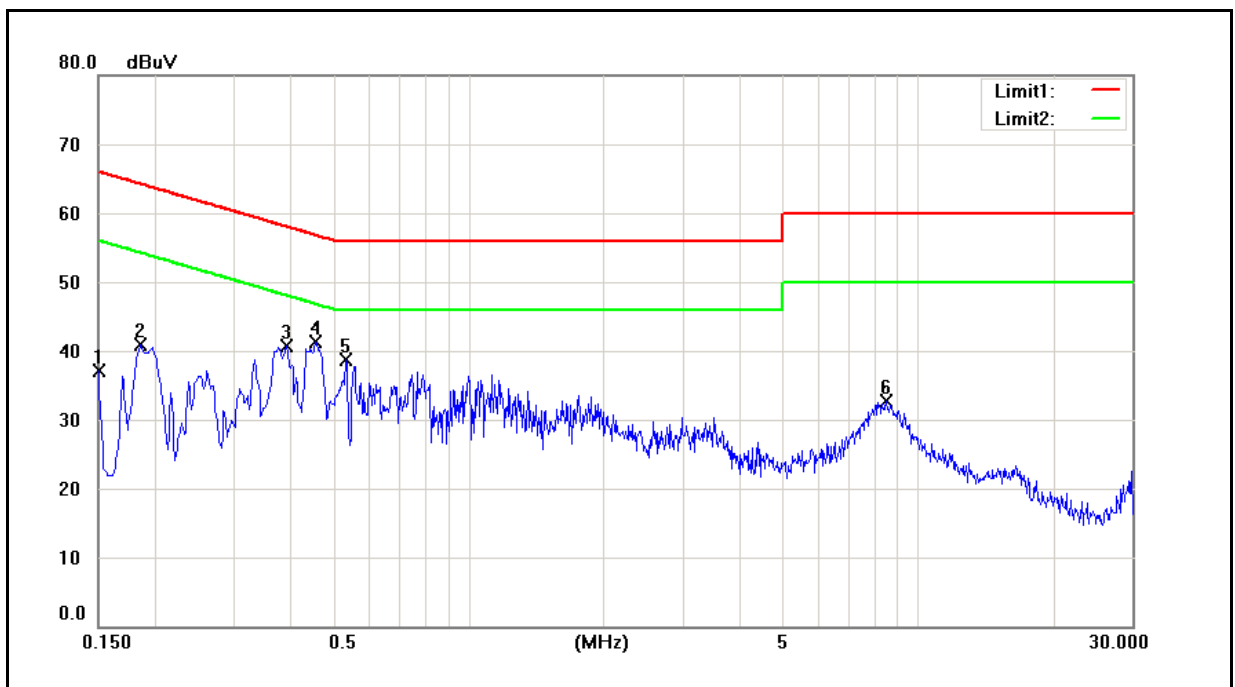

No.	Frequency (MHz)	QP reading (dBuV)	AVG reading (dBuV)	Correction factor (dB)	QP result (dBuV)	AVG result (dBuV)	QP limit (dBuV)	AVG limit (dBuV)	QP margin (dB)	AVG margin (dB)	Remark
1	0.1500	27.40	10.79	9.72	37.12	20.51	66.00	56.00	-28.88	-35.49	Pass
2	0.1860	29.59	18.74	9.72	39.31	28.46	64.21	54.21	-24.90	-25.75	Pass
3	0.3940	27.94	20.06	9.72	37.66	29.78	57.98	47.98	-20.32	-18.20	Pass
4	0.4580	27.56	17.86	9.72	37.28	27.58	56.73	46.73	-19.45	-19.15	Pass
5	0.5340	25.52	14.78	9.72	35.24	24.50	56.00	46.00	-20.76	-21.50	Pass
6	8.5020	18.49	8.63	10.16	28.65	18.79	60.00	50.00	-31.35	-31.21	Pass

Standard:	FCC Part 15B Class B	Line:	N
Test item:	Conducted Emission	Power:	AC 120V/60Hz
Model Number:	N5321	Temp.(°C)/Hum.(%RH):	26(°C)/60%RH
Mode:	5	Date:	12/05/2012
		Test By:	Frank Lin
Description:			

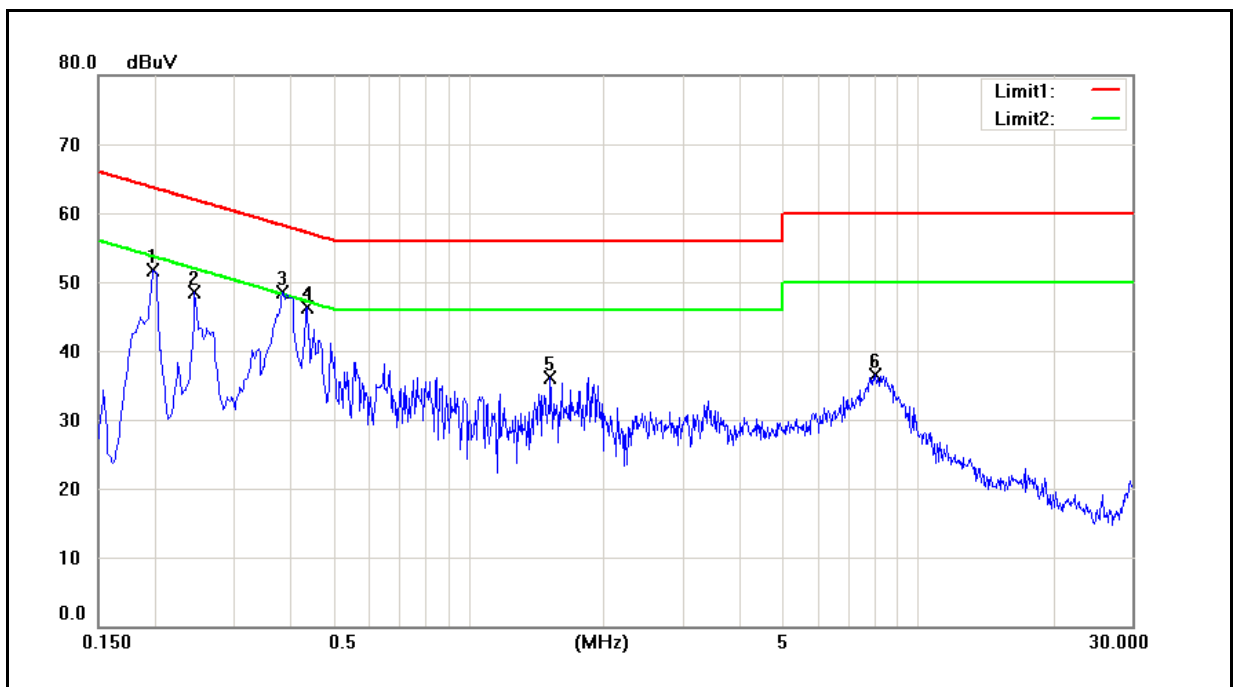

No.	Frequency (MHz)	QP reading (dBuV)	AVG reading (dBuV)	Correction factor (dB)	QP result (dBuV)	AVG result (dBuV)	QP limit (dBuV)	AVG limit (dBuV)	QP margin (dB)	AVG margin (dB)	Remark
1	0.1980	34.31	22.16	9.64	43.95	31.80	63.69	53.69	-19.74	0.1980	Pass
2	0.2460	32.93	24.47	9.64	42.57	34.11	61.89	51.89	-19.32	0.2460	Pass
3	0.3860	34.92	26.80	9.64	44.56	36.44	58.15	48.15	-13.59	0.3860	Pass
4	0.4380	32.25	20.98	9.64	41.89	30.62	57.10	47.10	-15.21	0.4380	Pass
5	1.5260	18.48	10.99	9.70	28.18	20.69	56.00	46.00	-27.82	1.5260	Pass
6	8.0500	21.79	11.49	10.07	31.86	21.56	60.00	50.00	-28.14	8.0500	Pass

## 4.2. Radiated Interference Measurement

### 4.2.1. Limit

Under 1GHz test shall not exceed following value

FCC 47 CFR PART 15 SUBPART B				
Frequency range (MHz)	Class A		Class B	
	Distance (m)	dBuV/m	Distance (m)	dBuV/m
30 to 88	10	39	3	40
88 to 216	10	43.5	3	43.5
216 to 960	10	46.4	3	46
Above 960	10	49.5	3	54

CISPR 22				
Frequency range (MHz)	Class A		Class B	
	Distance (m)	dBuV/m	Distance (m)	dBuV/m
30 to 230	10	40	10	30
230 to 1000	10	47	10	37

Above 1GHz test shall not exceed following value

Frequency (MHz)	dBuV/m (Distance 3m)			
	Class A		Class B	
	Average	Peak	Average	Peak
1000 ~ 40000	60	80	54	74

- Remark:
1. The tighter limit shall apply at the edge between two frequency bands.
  2. Distance refers to the distance in meters between the measuring instrument antenna and the closed point of any part of the device or system.
  3. RF Voltage (dBuV/m) = 20 log RF Voltage (uV/m)
  4. Peak detector limit is corresponding to 20 dB above the maximum permitted average limit.

**4.2.2. Test Instruments**

10 Meter Chamber					
Equipment	Manufacturer	Model Number	Serial Number	Cal. Date	Remark
Pre Amplifier	Agilent	8447D	2944A11120	01/10/2012	(1)
Pre Amplifier	Agilent	8447D	2944A11119	01/10/2012	(1)
Test Receiver	R&S	ESCI	100722	10/18/2012	(1)
Test Receiver	R&S	ESCI	101000	12/26/2011	(1)
Broadband Antenna	SCHWARZBECK MESS-ELEKTRONIK	VULB 9160	9160-3268	06/06/2012	(1)
Broadband Antenna	SCHWARZBECK MESS-ELEKTRONIK	VULB 9160	9160-3273	12/27/2011	(1)
Universal Radio Communication Tester	R&S	CMU200	109369	08/07/2012	(2)
Signal Generator	R&S	SMU200A	102598	02/23/2012	(1)
Test Site	ATL	TE06	TE06	08/13/2012	(1)

3 Meter Chamber					
Equipment	Manufacturer	Model Number	Serial Number	Cal. Date	Remark
Spectrum Analyzer	Agilent	E4445A	MY46181986	05/10/2012	(1)
Amplifier	Mini-Circuits	ZKL-1R5+	072010	05/29/2012	(1)
Amplifier	Mini-Circuits	ZVA-213-S+	467900926	05/29/2012	(1)
RF Pre-selector	Agilent	N9039A	MY46520255	05/10/2012	(1)
Horn Antenna (1~18GHz)	ETS-Lindgren	3117	00128055	08/09/2012	(1)
Horn Antenna (18~40GHz)	SCHWARZBECK MESS-ELEKTRONIK	BBHA9170	9170-320	06/21/2012	(1)
Universal Radio Communication Tester	R&S	CMU200	109369	08/07/2012	(2)
Signal Generator	R&S	SMU200A	102598	02/23/2012	(1)
Test Site	ATL	TE09	TE09	05/11/2012	(1)

Remark: <sup>(1)</sup> Calibration period 1 year. <sup>(2)</sup> Calibration period 2 years.

Note: N.C.R. = No Calibration Request.

**4.2.3. Setup**

Below 1GHz

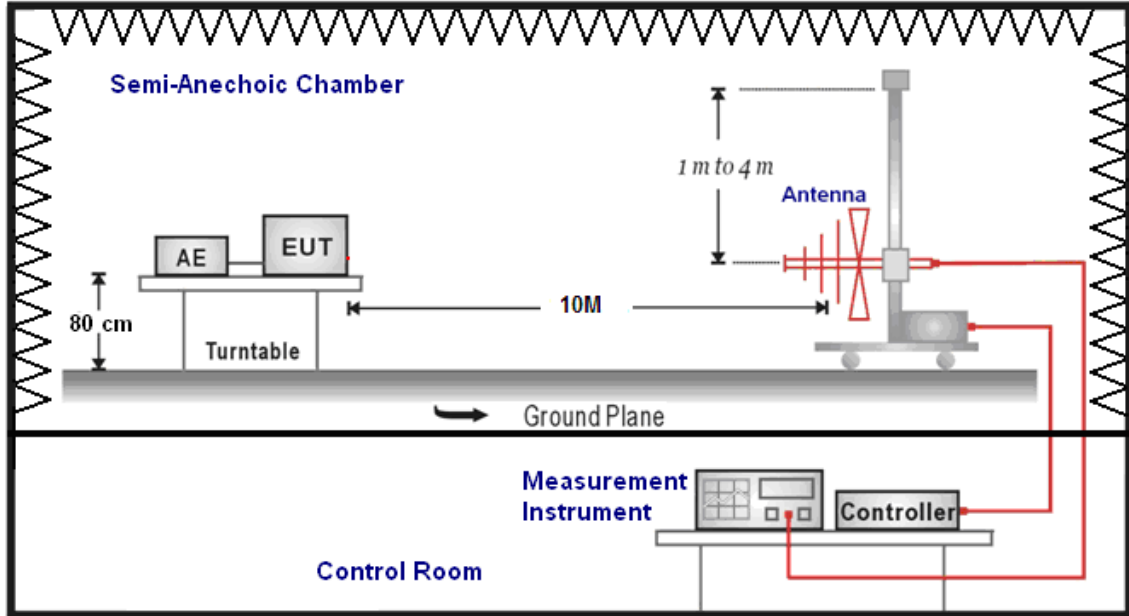

Above 1GHz

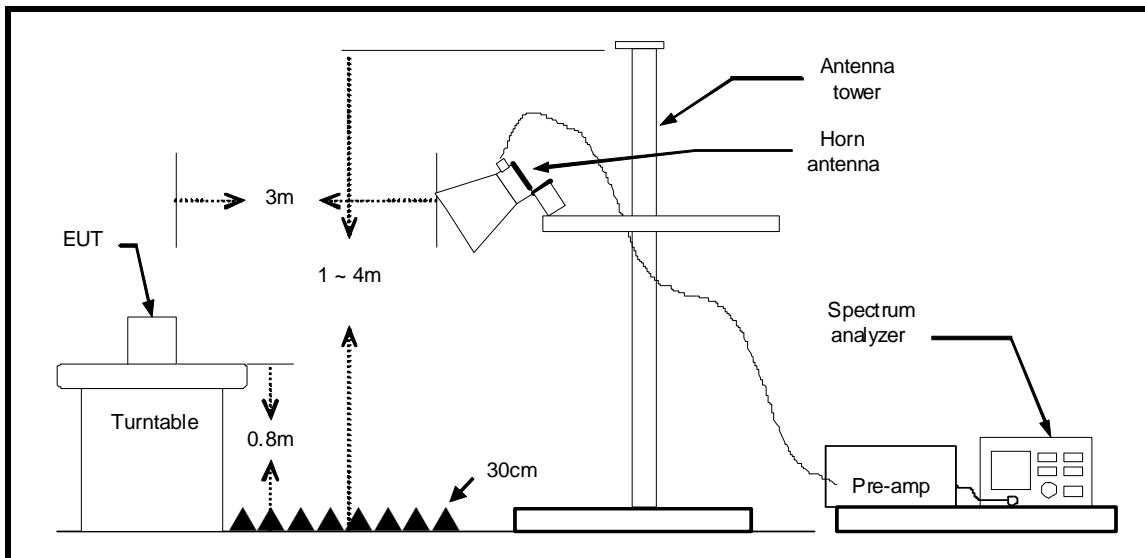



#### 4.2.4. Test Procedure

The EUT and its simulators are placed on a turn table which is 0.8 meter above ground. When the EUT is floor-standing equipment, it is placed on the ground plane which has a 3-12 mm non-conductive covering to insulate the EUT from the ground plane.

The turn table can rotate 360 degrees to determine the position of the maximum emission level. The EUT was positioned such that the distance from antenna to the EUT was 10 meters for under 1GHz, and 3 meter for above 1GHz, the highest frequency performed according to internal source frequency of the EUT, the specification was below:

Highest frequency generated or used in the device or on which the device operates or tunes (MHz)	Upper frequency of measurement range (MHz)
Below 1.705	30
1.705 - 108	1000
108 - 500	2000
500 - 1000	5000
Above 1000	5th harmonic of the highest frequency or 40 GHz, whichever is lower

According to this standard paragraph 15.109, as an alternative to the radiated emission limits, digital devices may be shown to comply with the standards contained in Third Edition of the International Special Committee on Radio Interference (CISPR), Pub. 22, "Information Technology Equipment - Radio Disturbance Characteristics - Limits and Methods of Measurement".

The antenna can move up and down between 1 meter and 4 meters to find out the maximum emission level. Both horizontal and vertical polarization of the antenna are set on measurement. In order to find the maximum emission, all of the interface cables must be manipulated on radiated measurement.

Radiated emissions were investigated over the frequency range from 30MHz to 1GHz using a receiver bandwidth of 120 kHz. Radiated was performed at an antenna to EUT distance of 10 meters.

**4.2.5. Test Result**

Standard:	CISPR 22 Class B	Test Distance:	10m
Test item:	Radiated Emission	Power:	AC 120V/60Hz
Model Number:	N5321	Temp.(°C)/Hum.(%RH):	26(°C)/60%RH
Mode:	1	Date:	12/01/2012
Ant.Polar.:	Horizontal	Test By:	Frank Lin

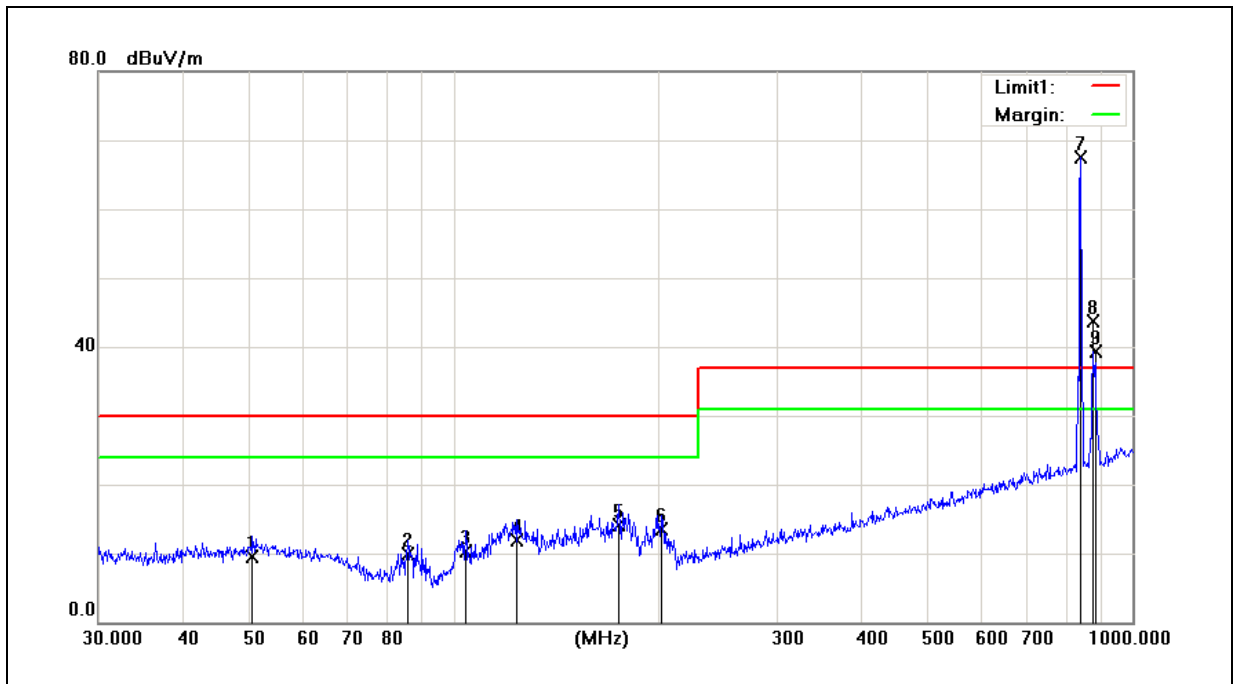

No.	Frequency (MHz)	Reading (dBuV)	Correct Factor (dB/m)	Result (dBuV/m)	Limit (dBuV/m)	Margin (dB)	Height (cm)	Degree (°)	Remark
1	50.5860	23.86	-14.33	9.53	30.00	-20.47	400	20	QP
2	85.5977	28.72	-18.75	9.97	30.00	-20.03	300	169	QP
3	104.1701	26.78	-16.47	10.31	30.00	-19.69	400	15	QP
4	123.6985	26.10	-14.27	11.83	30.00	-18.17	300	47	QP
5	175.0368	27.67	-13.62	14.05	30.00	-15.95	300	235	QP
6	202.8104	29.49	-15.96	13.53	30.00	-16.47	400	318	QP
7	839.1817	69.06	-1.53	67.53	N/A	N/A	400	0	TX
8	875.2470	44.54	-0.88	43.66	N/A	N/A	400	360	BS
9	884.5028	39.97	-0.73	39.24	N/A	N/A	400	330	RX

Note: TX: the transmitting signal of Universal Radio Communication Tester.

RX: the receiving signal of Universal Radio Communication Tester.

BS: the signal of Universal Radio Communication Tester.

Standard:	CISPR 22 Class B	Test Distance:	10m
Test item:	Radiated Emission	Power:	AC 120V/60Hz
Model Number:	N5321	Temp.(°C)/Hum.(%RH):	26(°C)/60%RH
Mode:	1	Date:	12/01/2012
Ant.Polar.:	Vertical	Test By:	Frank Lin

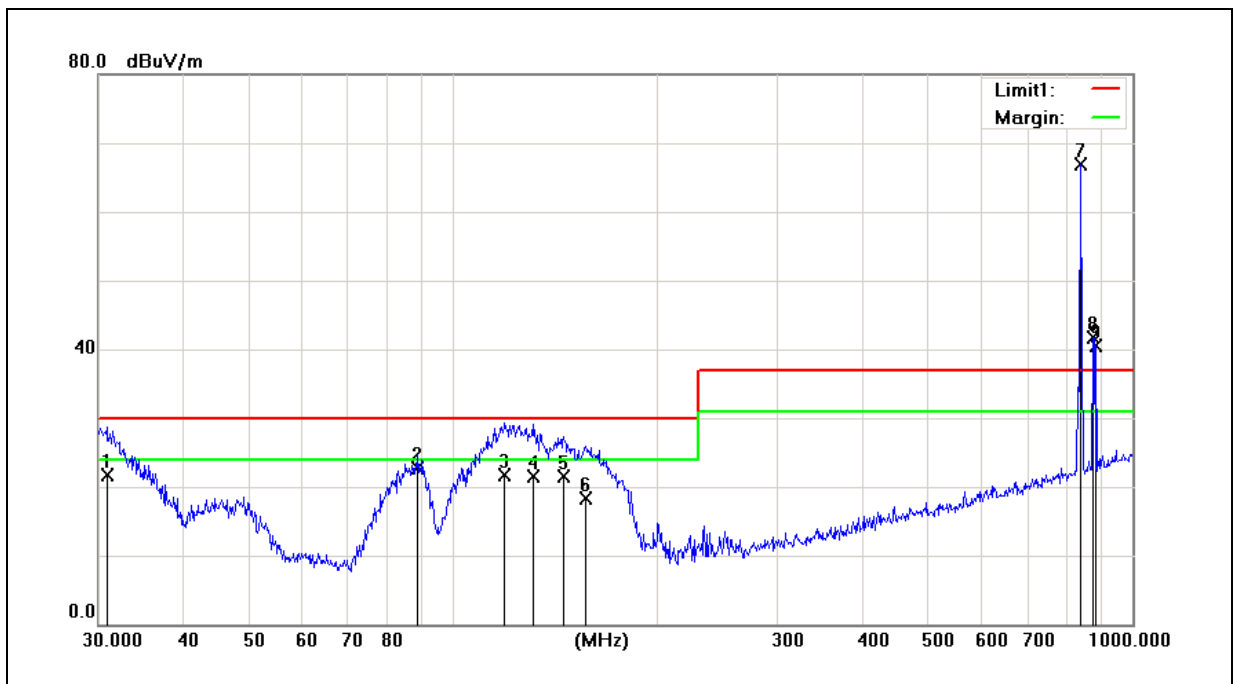

No.	Frequency (MHz)	Reading (dBuV)	Correct Factor (dB/m)	Result (dBuV/m)	Limit (dBuV/m)	Margin (dB)	Height (cm)	Degree (°)	Remark
1	30.8535	37.21	-15.41	21.80	30.00	-8.20	200	185	QP
2	88.6524	41.36	-18.69	22.67	30.00	-7.33	100	53	QP
3	119.0180	36.10	-14.30	21.80	30.00	-8.20	200	10	QP
4	130.8370	35.06	-13.47	21.59	30.00	-8.41	300	315	QP
5	145.3506	34.37	-12.88	21.49	30.00	-8.51	100	244	QP
6	156.4578	30.85	-12.55	18.30	30.00	-11.70	200	188	QP
7	839.1817	66.69	0.21	66.90	N/A	N/A	100	0	TX
8	875.2470	40.89	0.87	41.76	N/A	N/A	100	150	BS
9	884.5028	39.51	1.00	40.51	N/A	N/A	100	360	RX

Note: TX: the transmitting signal of Universal Radio Communication Tester.

RX: the receiving signal of Universal Radio Communication Tester.

BS: the signal of Universal Radio Communication Tester.

Standard:	FCC Part 15B Class B	Test Distance:	3m
Test item:	Radiated Emission	Power:	AC 120V/60Hz
Model Number:	N5321	Temp.(°C)/Hum.(%RH):	26(°C)/60%RH
Mode:	1 (1GHz~10GHz)	Date:	12/01/2012
Ant.Polar.:	Horizontal	Test By:	Frank Lin

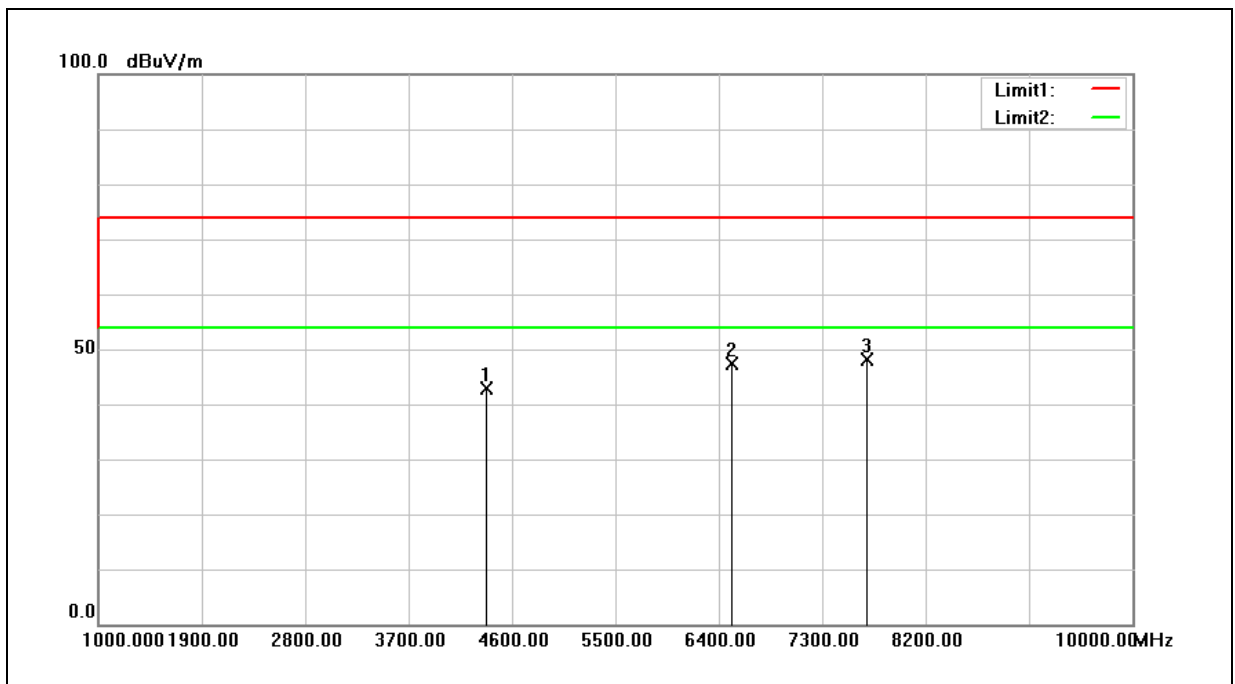

No.	Frequency (MHz)	Reading (dBuV)	Correct Factor (dB/m)	Result (dBuV/m)	Limit (dBuV/m)	Margin (dB)	Remark
1	4375.000	56.37	-13.49	42.88	74.00	-31.12	peak
2	6517.000	56.75	-9.33	47.42	74.00	-26.58	peak
3	7687.000	55.99	-7.98	48.01	74.00	-25.99	peak

Standard:	FCC Part 15B Class B	Test Distance:	3m
Test item:	Radiated Emission	Power:	AC 120V/60Hz
Model Number:	N5321	Temp.(°C)/Hum.(%RH):	26(°C)/60%RH
Mode:	1 (1GHz~10GHz)	Date:	12/01/2012
Ant.Polar.:	Vertical	Test By:	Frank Lin

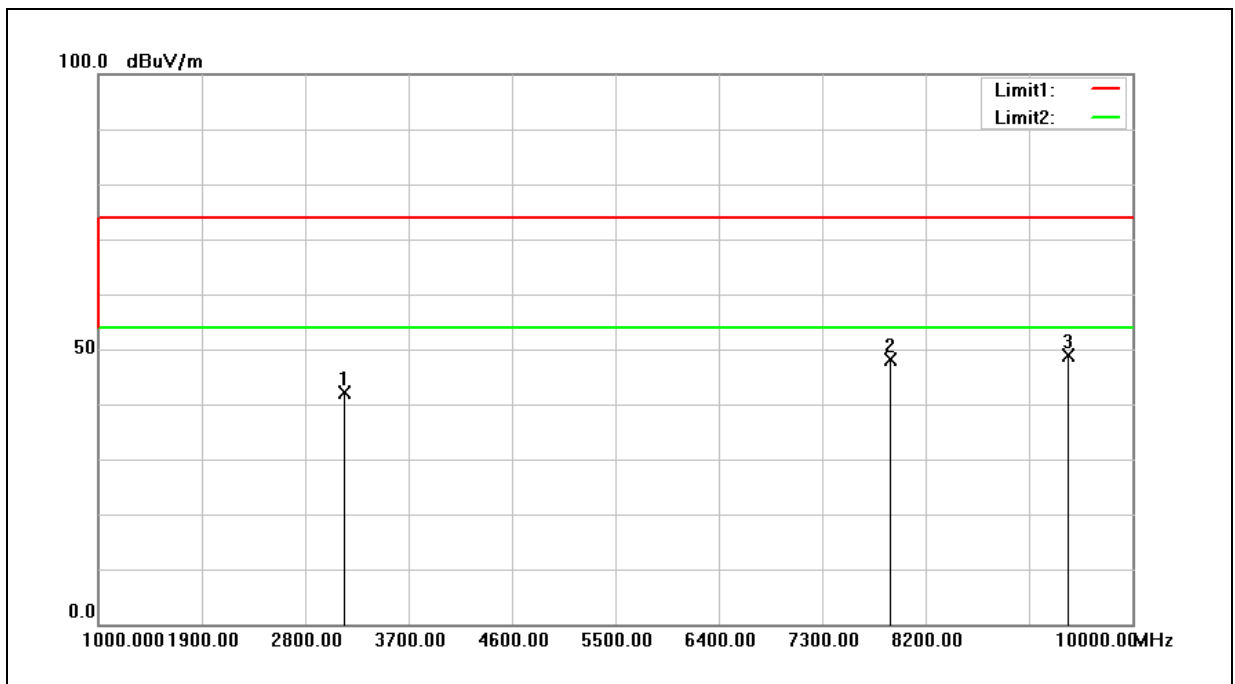

No.	Frequency (MHz)	Reading (dBuV)	Correct Factor (dB/m)	Result (dBuV/m)	Limit (dBuV/m)	Margin (dB)	Remark
1	3142.000	58.68	-16.52	42.16	74.00	-31.84	peak
2	7894.000	55.91	-7.75	48.16	74.00	-25.84	peak
3	9442.000	54.36	-5.42	48.94	74.00	-25.06	peak

Standard:	CISPR 22 Class B	Test Distance:	10m
Test item:	Radiated Emission	Power:	AC 120V/60Hz
Model Number:	N5321	Temp.(°C)/Hum.(%RH):	26(°C)/60%RH
Mode:	2	Date:	12/01/2012
Ant.Polar.:	Horizontal	Test By:	Frank Lin

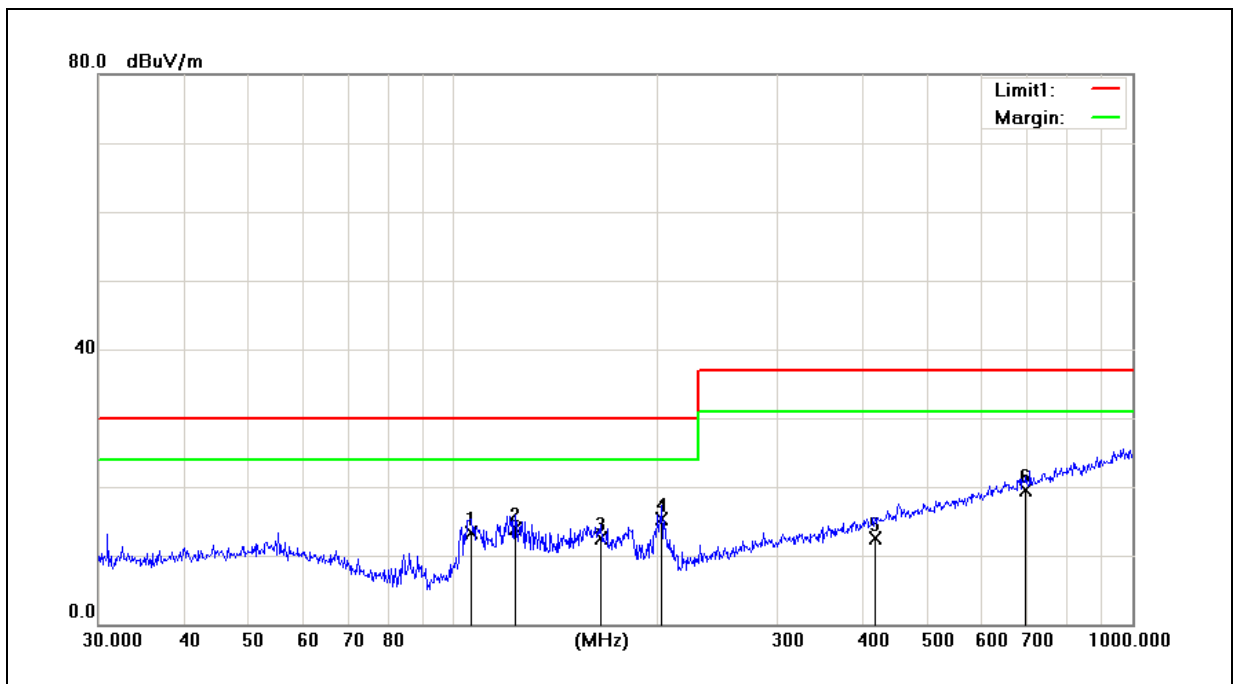

No.	Frequency (MHz)	Reading (dBuV)	Correct Factor (dB/m)	Result (dBuV/m)	Limit (dBuV/m)	Margin (dB)	Height (cm)	Degree (°)	Remark
1	106.3850	29.50	-16.13	13.37	30.00	-16.63	400	0	QP
2	123.2655	28.16	-14.28	13.88	30.00	-16.12	300	44	QP
3	164.9075	25.34	-12.93	12.41	30.00	-17.59	300	336	QP
4	202.8104	31.18	-15.96	15.22	30.00	-14.78	400	312	QP
5	417.6411	21.81	-9.24	12.57	37.00	-24.43	400	35	QP
6	696.8567	23.47	-3.95	19.52	37.00	-17.48	200	244	QP

Standard:	CISPR 22 Class B	Test Distance:	10m
Test item:	Radiated Emission	Power:	AC 120V/60Hz
Model Number:	N5321	Temp.(°C)/Hum.(%RH):	26(°C)/60%RH
Mode:	2	Date:	12/01/2012
Ant.Polar.:	Vertical	Test By:	Frank Lin

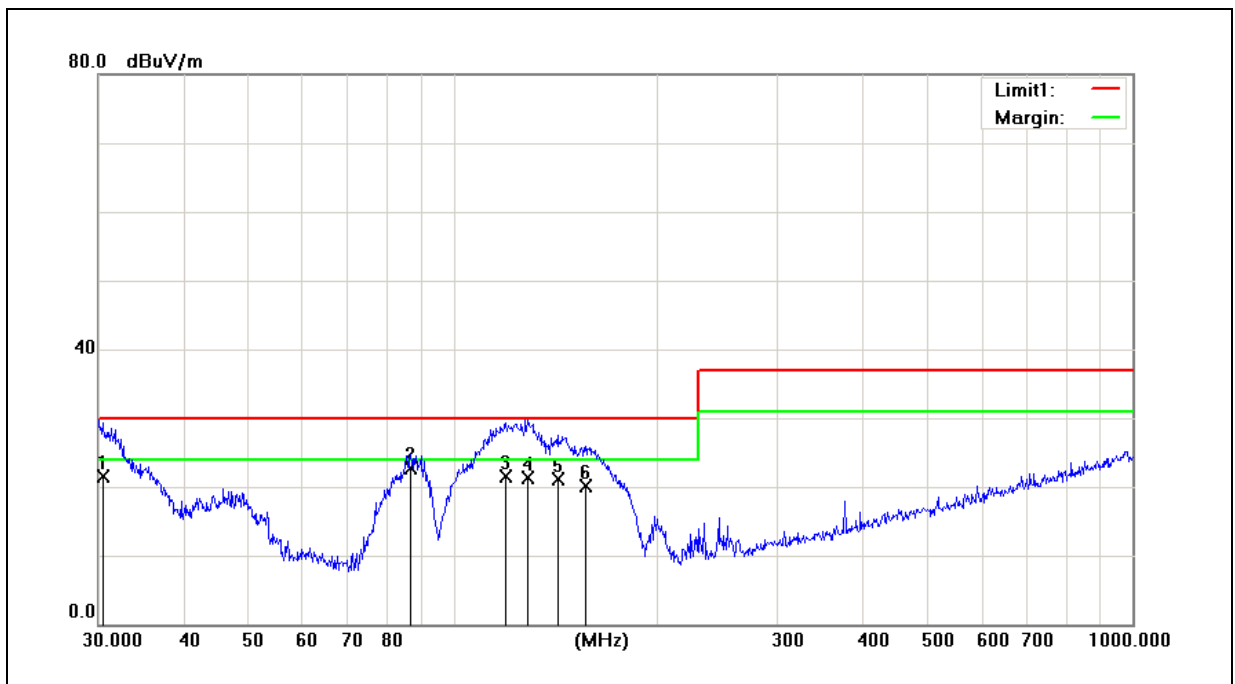

No.	Frequency (MHz)	Reading (dBuV)	Correct Factor (dB/m)	Result (dBuV/m)	Limit (dBuV/m)	Margin (dB)	Height (cm)	Degree (°)	Remark
1	30.4238	36.88	-15.43	21.45	30.00	-8.55	100	360	QP
2	86.5030	41.30	-18.55	22.75	30.00	-7.25	200	0	QP
3	119.4361	35.69	-14.26	21.43	30.00	-8.57	200	349	QP
4	128.5630	34.88	-13.60	21.28	30.00	-8.72	200	313	QP
5	142.3243	34.16	-13.05	21.11	30.00	-8.89	300	268	QP
6	156.4578	32.70	-12.55	20.15	30.00	-9.85	100	182	QP

Standard:	FCC Part 15B Class B	Test Distance:	3m
Test item:	Radiated Emission	Power:	AC 120V/60Hz
Model Number:	N5321	Temp.(°C)/Hum.(%RH):	26(°C)/60%RH
Mode:	2 (1GHz~10GHz)	Date:	12/01/2012
Ant.Polar.:	Horizontal	Test By:	Frank Lin

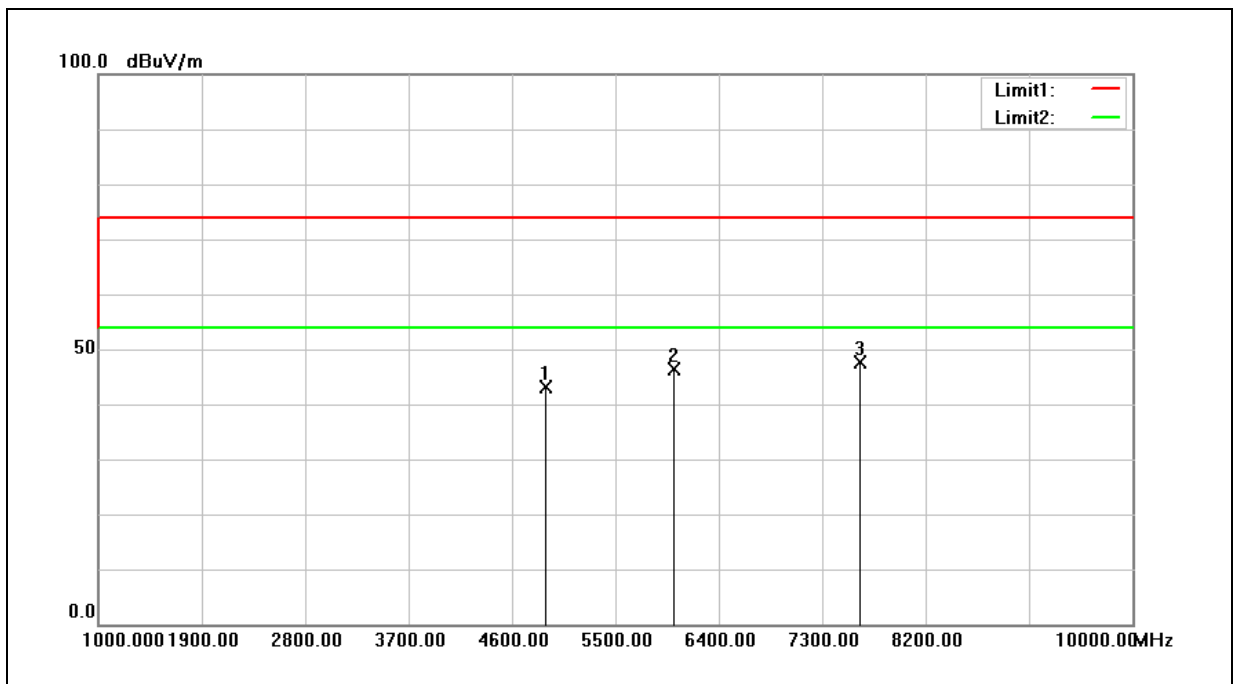

No.	Frequency (MHz)	Reading (dBuV)	Correct Factor (dB/m)	Result (dBuV/m)	Limit (dBuV/m)	Margin (dB)	Remark
1	4897.000	55.83	-12.73	43.10	74.00	-30.90	peak
2	6013.000	56.29	-9.97	46.32	74.00	-27.68	peak
3	7633.000	55.58	-8.02	47.56	74.00	-26.44	peak



Standard:	FCC Part 15B Class B	Test Distance:	3m
Test item:	Radiated Emission	Power:	AC 120V/60Hz
Model Number:	N5321	Temp.(°C)/Hum.(%RH):	26(°C)/60%RH
Mode:	2 (1GHz~10GHz)	Date:	12/01/2012
Ant.Polar.:	Vertical	Test By:	Frank Lin

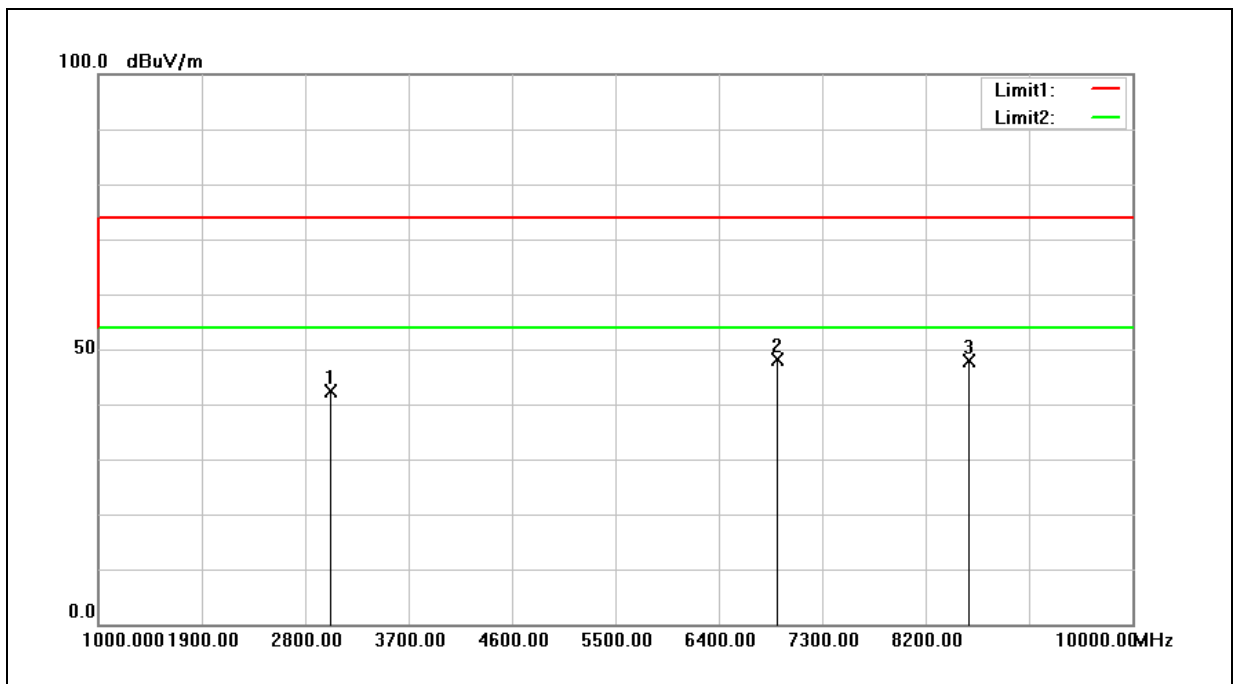

No.	Frequency (MHz)	Reading (dBuV)	Correct Factor (dB/m)	Result (dBuV/m)	Limit (dBuV/m)	Margin (dB)	Remark
1	3025.000	59.12	-16.64	42.48	74.00	-31.52	peak
2	6913.000	57.04	-8.83	48.21	74.00	-25.79	peak
3	8578.000	54.53	-6.73	47.80	74.00	-26.20	peak

Standard:	CISPR 22 Class B	Test Distance:	10m
Test item:	Radiated Emission	Power:	AC 120V/60Hz
Model Number:	N5321	Temp.(°C)/Hum.(%RH):	26(°C)/60%RH
Mode:	3	Date:	12/01/2012
Ant.Polar.:	Horizontal	Test By:	Frank Lin

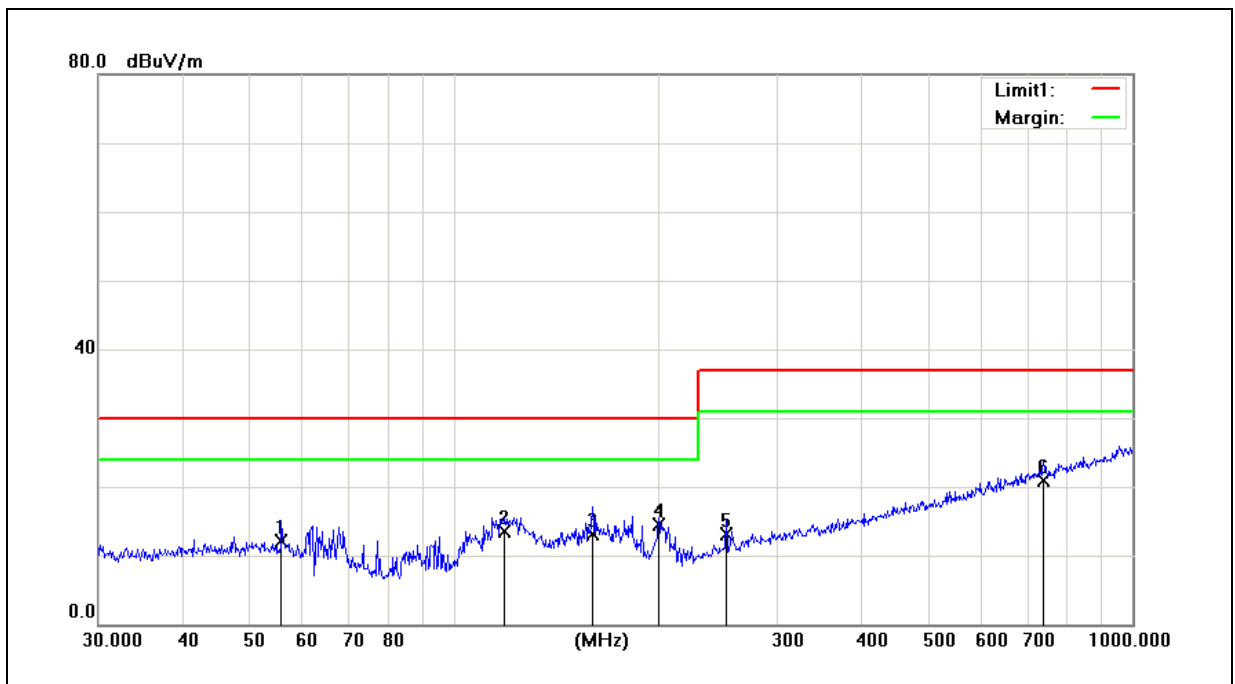

No.	Frequency (MHz)	Reading (dBuV)	Correct Factor (dB/m)	Result (dBuV/m)	Limit (dBuV/m)	Margin (dB)	Height (cm)	Degree (°)	Remark
1	55.8047	26.79	-14.61	12.18	30.00	-17.82	200	100	QP
2	119.0180	28.05	-14.47	13.58	30.00	-16.42	300	60	QP
3	160.3456	25.92	-12.75	13.17	30.00	-16.83	400	166	QP
4	200.6881	30.48	-15.94	14.54	30.00	-15.46	400	299	QP
5	252.0627	26.33	-13.24	13.09	37.00	-23.91	200	80	QP
6	739.6604	24.07	-3.08	20.99	37.00	-16.01	171	360	QP

Standard:	CISPR 22 Class B	Test Distance:	10m
Test item:	Radiated Emission	Power:	AC 120V/60Hz
Model Number:	N5321	Temp.(°C)/Hum.(%RH):	26(°C)/60%RH
Mode:	3	Date:	12/01/2012
Ant.Polar.:	Vertical	Test By:	Frank Lin

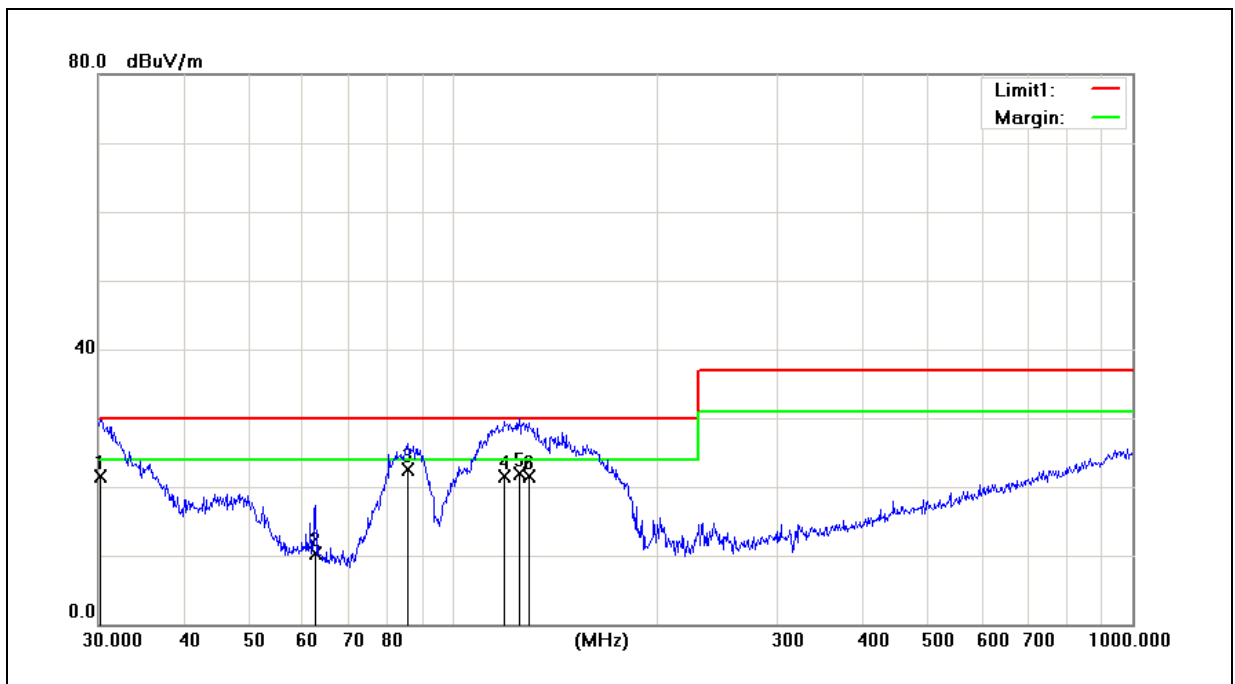

No.	Frequency (MHz)	Reading (dBuV)	Correct Factor (dB/m)	Result (dBuV/m)	Limit (dBuV/m)	Margin (dB)	Height (cm)	Degree (°)	Remark
1	30.2110	36.91	-15.43	21.48	30.00	-8.52	100	0	QP
2	62.6507	25.46	-15.07	10.39	30.00	-19.61	100	207	QP
3	85.5977	41.08	-18.50	22.58	30.00	-7.42	200	65	QP
4	118.6013	35.81	-14.33	21.48	30.00	-8.52	200	309	QP
5	125.0066	35.84	-13.85	21.99	30.00	-8.01	100	335	QP
6	129.4677	35.03	-13.54	21.49	30.00	-8.51	100	335	QP

Standard:	FCC Part 15B Class B	Test Distance:	3m
Test item:	Radiated Emission	Power:	AC 120V/60Hz
Model Number:	N5321	Temp.(°C)/Hum.(%RH):	26(°C)/60%RH
Mode:	3 (1GHz~10GHz)	Date:	12/01/2012
Ant.Polar.:	Horizontal	Test By:	Frank Lin

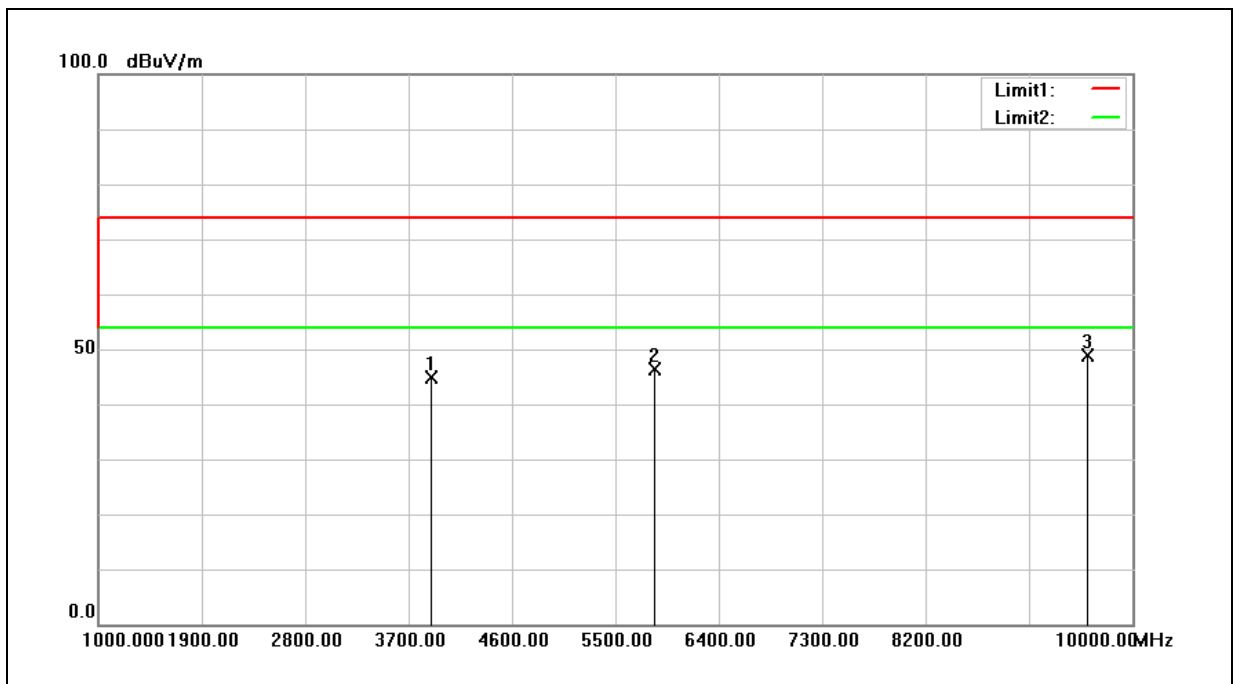

No.	Frequency (MHz)	Reading (dBuV)	Correct Factor (dB/m)	Result (dBuV/m)	Limit (dBuV/m)	Margin (dB)	Remark
1	3898.000	59.60	-14.83	44.77	74.00	-29.23	peak
2	5842.000	57.01	-10.53	46.48	74.00	-27.52	peak
3	9613.000	53.77	-5.01	48.76	74.00	-25.24	peak

Standard:	FCC Part 15B Class B	Test Distance:	3m
Test item:	Radiated Emission	Power:	AC 120V/60Hz
Model Number:	N5321	Temp.(°C)/Hum.(%RH):	26(°C)/60%RH
Mode:	3 (1GHz~10GHz)	Date:	12/01/2012
Ant.Polar.:	Vertical	Test By:	Frank Lin

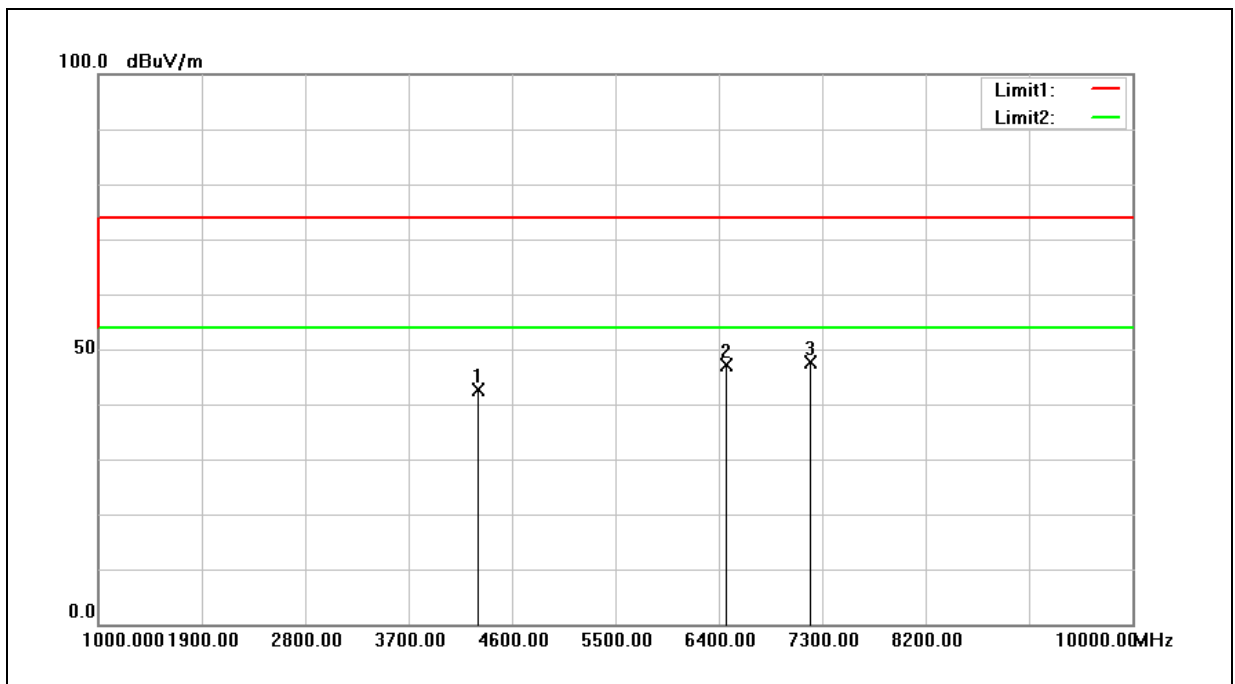

No.	Frequency (MHz)	Reading (dBuV)	Correct Factor (dB/m)	Result (dBuV/m)	Limit (dBuV/m)	Margin (dB)	Remark
1	4303.000	56.38	-13.68	42.70	74.00	-31.30	peak
2	6463.000	56.57	-9.41	47.16	74.00	-26.84	peak
3	7201.000	56.09	-8.50	47.59	74.00	-26.41	peak

Standard:	CISPR 22 Class B	Test Distance:	10m
Test item:	Radiated Emission	Power:	AC 120V/60Hz
Model Number:	N5321	Temp.(°C)/Hum.(%RH):	26(°C)/60%RH
Mode:	4	Date:	12/01/2012
Ant.Polar.:	Horizontal	Test By:	Frank Lin

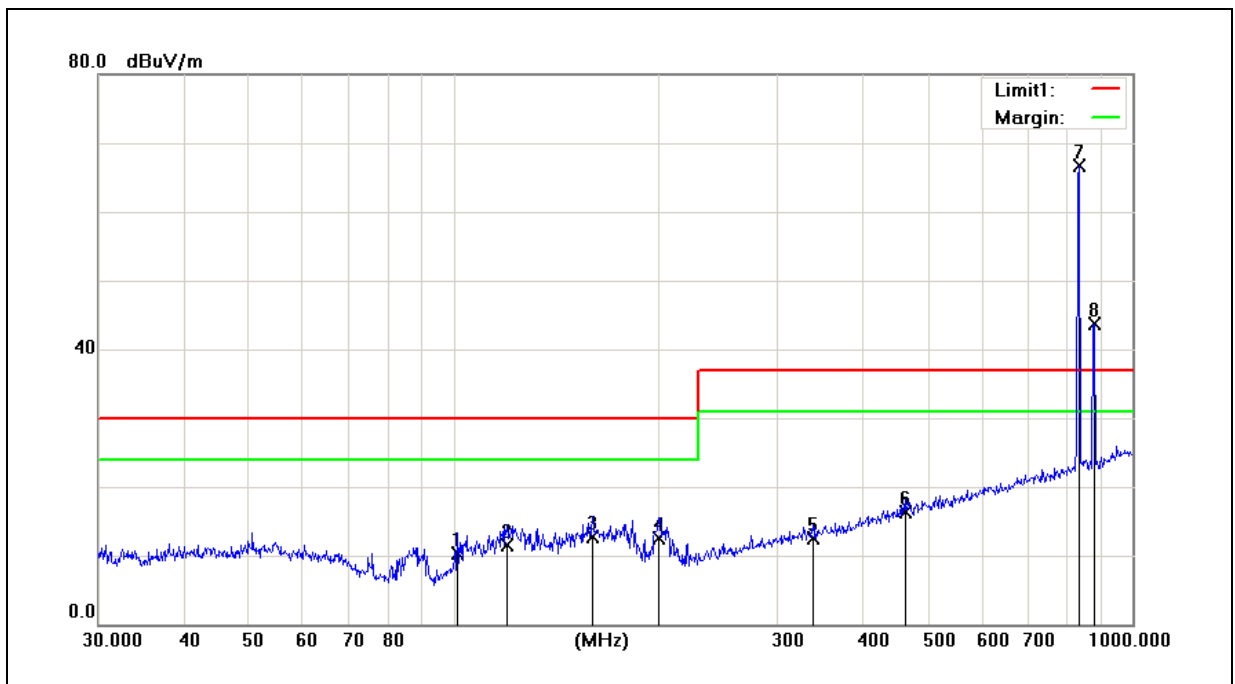

No.	Frequency (MHz)	Reading (dBuV)	Correct Factor (dB/m)	Result (dBuV/m)	Limit (dBuV/m)	Margin (dB)	Height (cm)	Degree (°)	Remark
1	101.2885	27.21	-16.94	10.27	30.00	-19.73	400	12	QP
2	119.8556	25.85	-14.39	11.46	30.00	-18.54	200	41	QP
3	160.3456	25.42	-12.75	12.67	30.00	-17.33	400	253	QP
4	200.6881	28.48	-15.94	12.54	30.00	-17.46	300	344	QP
5	338.4001	23.40	-10.87	12.53	37.00	-24.47	300	337	QP
6	462.3455	24.65	-8.25	16.40	37.00	-20.60	400	360	QP
7	836.2441	68.38	-1.59	66.79	N/A	N/A	400	0	TX
8	878.3214	44.60	-0.84	43.76	N/A	N/A	400	100	RX

Note: TX: the transmitting signal of Universal Radio Communication Tester.

RX: the receiving signal of Universal Radio Communication Tester.

Standard:	CISPR 22 Class B	Test Distance:	10m
Test item:	Radiated Emission	Power:	AC 120V/60Hz
Model Number:	N5321	Temp.(°C)/Hum. (%RH):	26(°C)/60%RH
Mode:	4	Date:	12/01/2012
Ant.Polar.:	Vertical	Test By:	Frank Lin

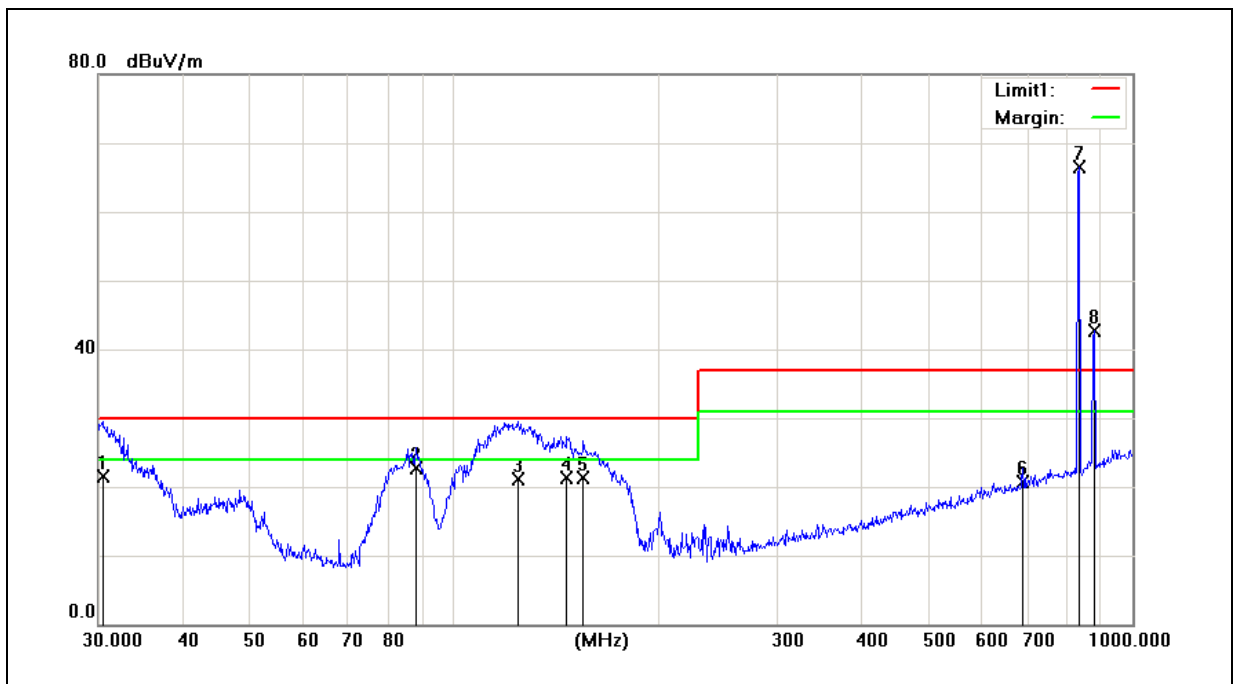

No.	Frequency (MHz)	Reading (dBuV)	Correct Factor (dB/m)	Result (dBuV/m)	Limit (dBuV/m)	Margin (dB)	Height (cm)	Degree (°)	Remark
1	30.4238	36.88	-15.43	21.45	30.00	-8.55	100	235	QP
2	88.0330	41.28	-18.64	22.64	30.00	-7.36	200	359	QP
3	124.5690	35.01	-13.89	21.12	30.00	-8.88	200	0	QP
4	146.8877	34.17	-12.80	21.37	30.00	-8.63	100	229	QP
5	155.3644	33.79	-12.57	21.22	30.00	-8.78	300	261	QP
6	689.5644	23.41	-2.69	20.72	37.00	-16.28	100	255	QP
7	836.2441	66.32	0.11	66.43	N/A	N/A	100	360	TX
8	878.3214	41.77	0.91	42.68	N/A	N/A	100	110	RX

Note: TX: the transmitting signal of Universal Radio Communication Tester.

RX: the receiving signal of Universal Radio Communication Tester.

Standard:	FCC Part 15B Class B	Test Distance:	3m
Test item:	Radiated Emission	Power:	AC 120V/60Hz
Model Number:	N5321	Temp.(°C)/Hum.(%RH):	26(°C)/60%RH
Mode:	4 (1GHz~10GHz)	Date:	12/01/2012
Ant.Polar.:	Horizontal	Test By:	Frank Lin

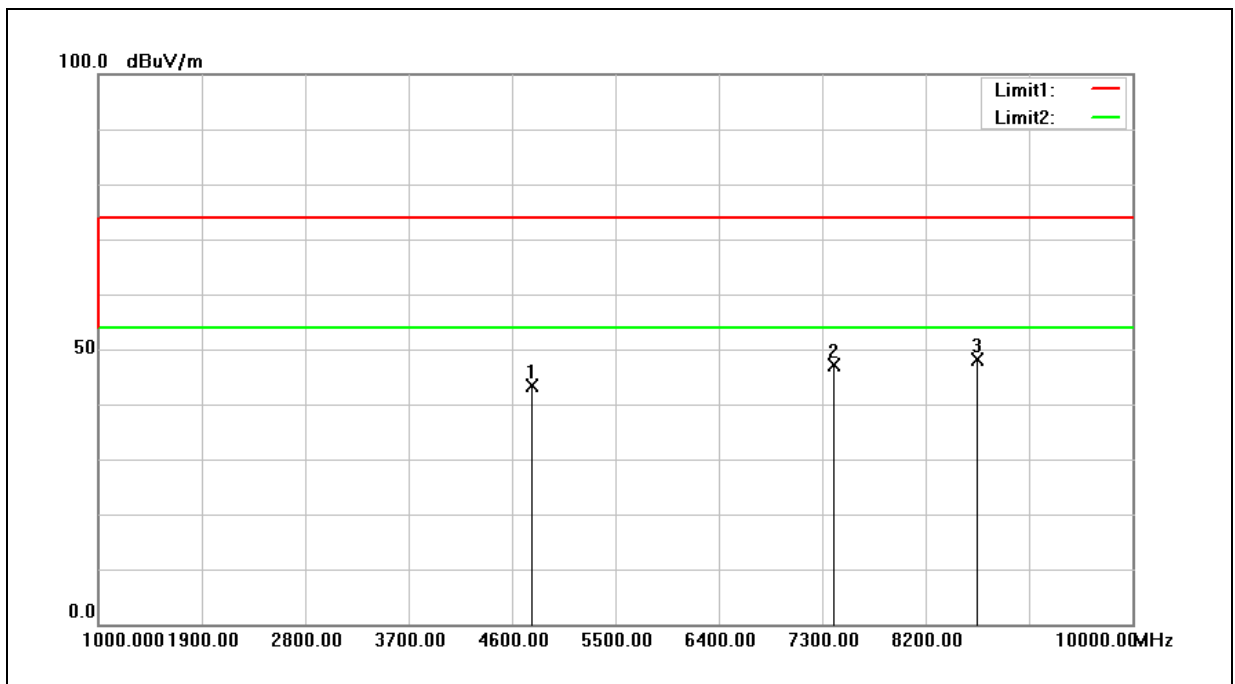

No.	Frequency (MHz)	Reading (dBuV)	Correct Factor (dB/m)	Result (dBuV/m)	Limit (dBuV/m)	Margin (dB)	Remark
1	4771.000	56.30	-12.86	43.44	74.00	-30.56	peak
2	7399.000	55.47	-8.28	47.19	74.00	-26.81	peak
3	8650.000	54.74	-6.63	48.11	74.00	-25.89	peak



Standard:	FCC Part 15B Class B	Test Distance:	3m
Test item:	Radiated Emission	Power:	AC 120V/60Hz
Model Number:	N5321	Temp.(°C)/Hum.(%RH):	26(°C)/60%RH
Mode:	4 (1GHz~10GHz)	Date:	12/01/2012
Ant.Polar.:	Vertical	Test By:	Frank Lin

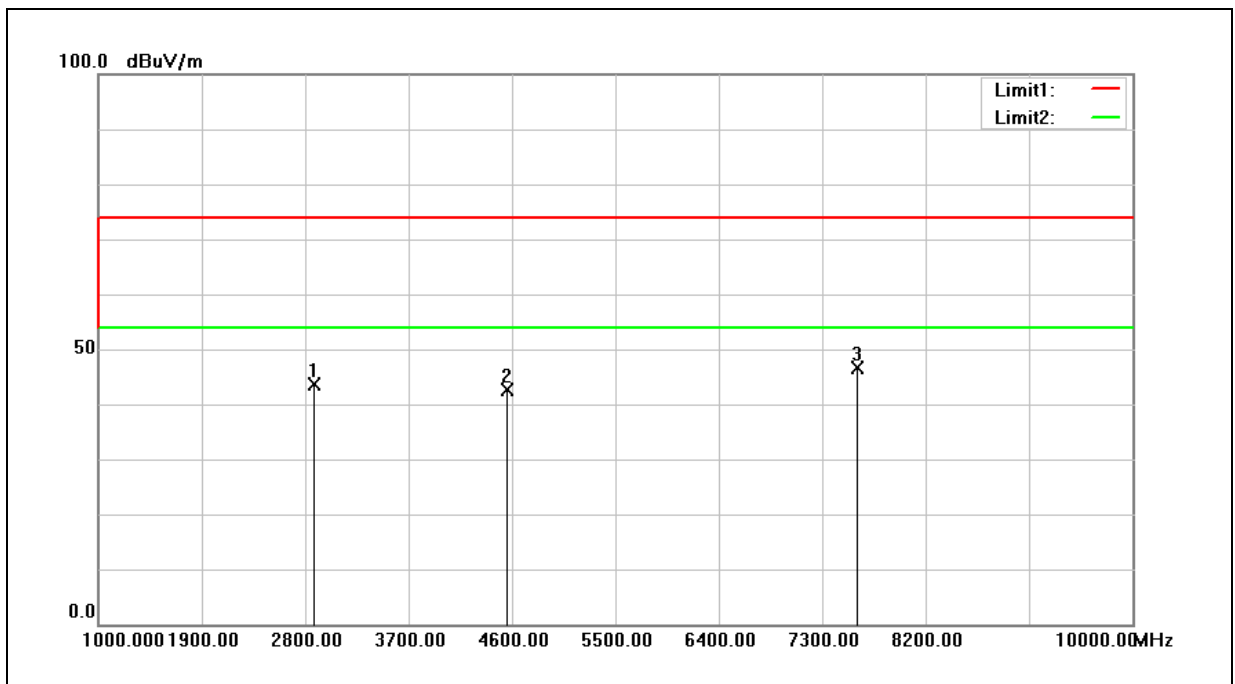

No.	Frequency (MHz)	Reading (dBuV)	Correct Factor (dB/m)	Result (dBuV/m)	Limit (dBuV/m)	Margin (dB)	Remark
1	2881.000	60.69	-17.02	43.67	74.00	-30.33	peak
2	4555.000	55.69	-13.09	42.60	74.00	-31.40	peak
3	7606.000	54.62	-8.06	46.56	74.00	-27.44	peak

Standard:	CISPR 22 Class B	Test Distance:	10m
Test item:	Radiated Emission	Power:	AC 120V/60Hz
Model Number:	N5321	Temp.(°C)/Hum.(%RH):	26(°C)/60%RH
Mode:	5	Date:	12/01/2012
Ant.Polar.:	Horizontal	Test By:	Frank Lin

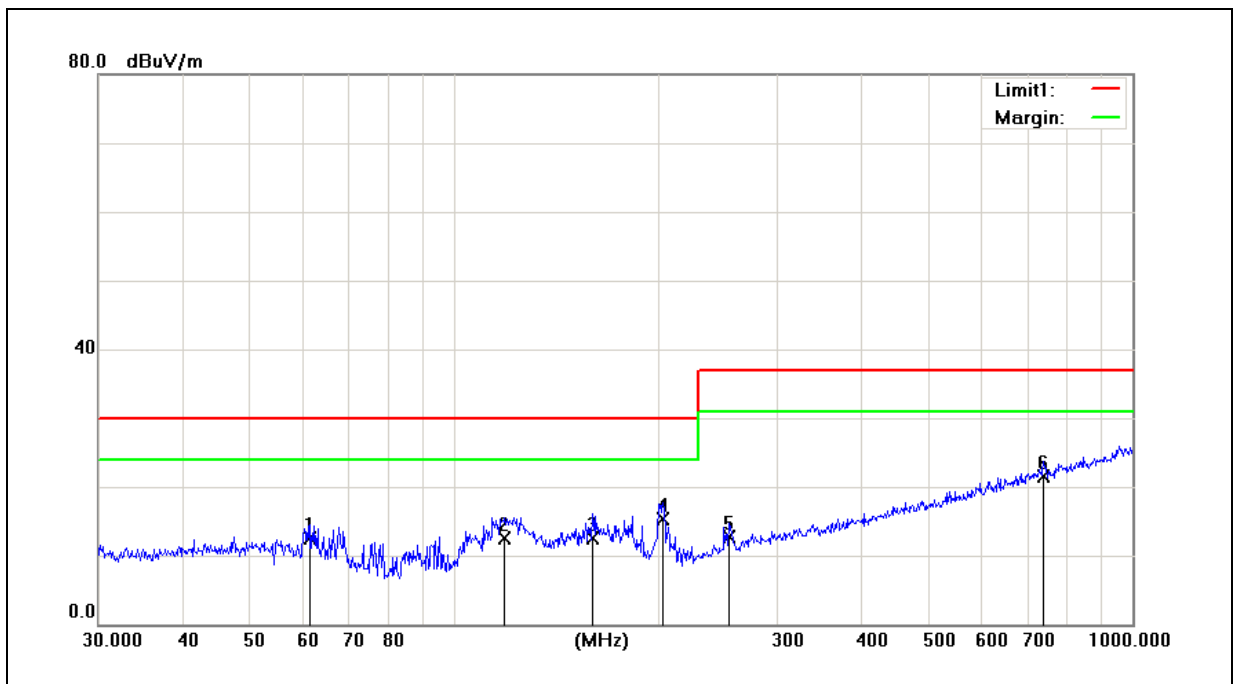

No.	Frequency (MHz)	Reading (dBuV)	Correct Factor (dB/m)	Result (dBuV/m)	Limit (dBuV/m)	Margin (dB)	Height (cm)	Degree (°)	Remark
1	61.5617	27.47	-14.97	12.50	30.00	-17.50	400	268	QP
2	119.0180	26.92	-14.47	12.45	30.00	-17.55	300	254	QP
3	160.3456	25.30	-12.75	12.55	30.00	-17.45	400	225	QP
4	203.5227	31.36	-15.96	15.40	30.00	-14.60	300	189	QP
5	254.7283	25.92	-13.16	12.76	37.00	-24.24	300	34	QP
6	739.6603	24.52	-3.08	21.44	37.00	-15.56	200	360	QP

Standard:	CISPR 22 Class B	Test Distance:	10m
Test item:	Radiated Emission	Power:	AC 120V/60Hz
Model Number:	N5321	Temp.(°C)/Hum.(%RH):	26(°C)/60%RH
Mode:	5	Date:	12/01/2012
Ant.Polar.:	Vertical	Test By:	Frank Lin

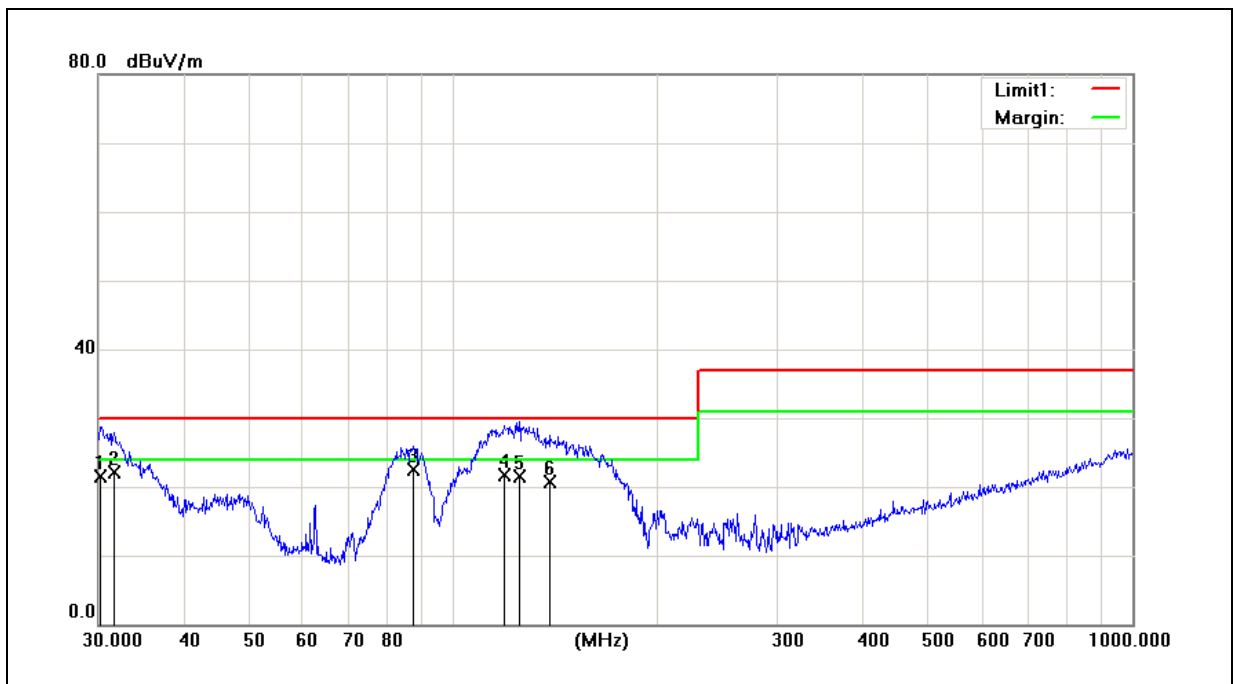

No.	Frequency (MHz)	Reading (dBuV)	Correct Factor (dB/m)	Result (dBuV/m)	Limit (dBuV/m)	Margin (dB)	Height (cm)	Degree (°)	Remark
1	30.2110	36.97	-15.43	21.54	30.00	-8.46	100	360	QP
2	31.6202	37.50	-15.39	22.11	30.00	-7.89	200	125	QP
3	87.4176	41.09	-18.61	22.48	30.00	-7.52	100	225	QP
4	118.6013	36.02	-14.33	21.69	30.00	-8.31	200	25	QP
5	125.0066	35.44	-13.85	21.59	30.00	-8.41	200	257	QP
6	138.8735	33.99	-13.19	20.80	30.00	-9.20	300	269	QP

Standard:	FCC Part 15B Class B	Test Distance:	3m
Test item:	Radiated Emission	Power:	AC 120V/60Hz
Model Number:	N5321	Temp.(°C)/Hum.(%RH):	26(°C)/60%RH
Mode:	5 (1GHz~10GHz)	Date:	12/05/2012
Ant.Polar.:	Horizontal	Test By:	Frank Lin

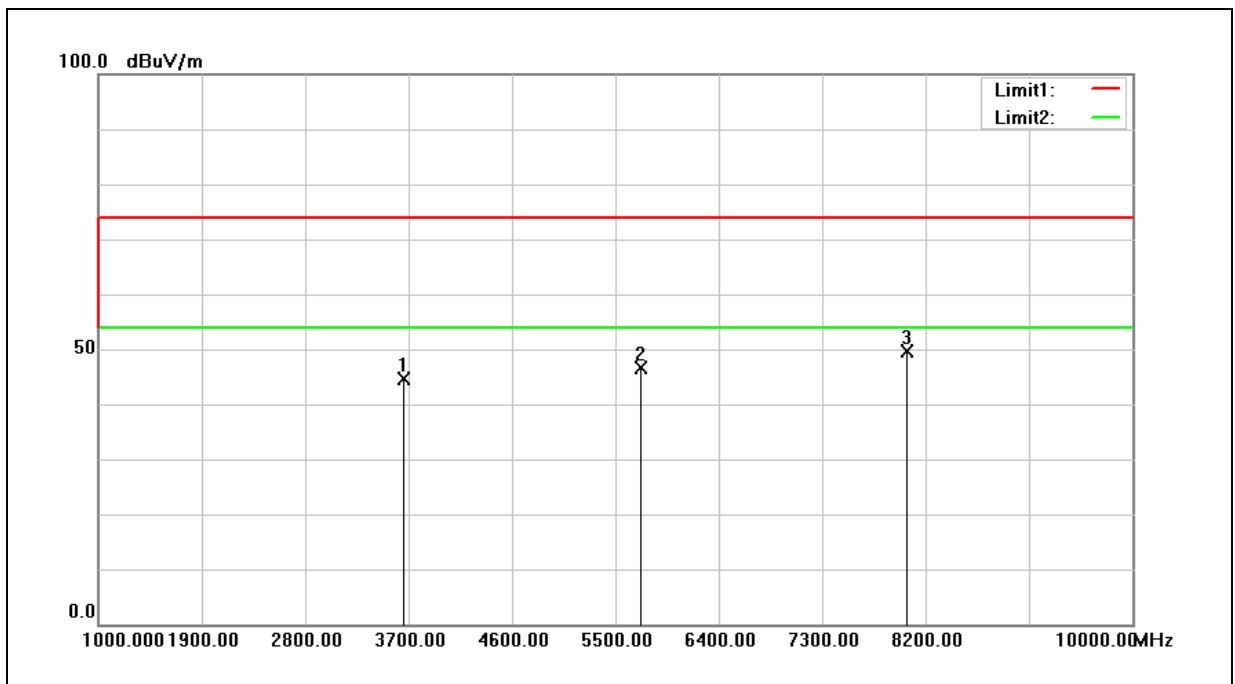

No.	Frequency (MHz)	Reading (dBuV)	Correct Factor (dB/m)	Result (dBuV/m)	Limit (dBuV/m)	Margin (dB)	Remark
1	3655.000	60.30	-15.63	44.67	74.00	-29.33	peak
2	5725.000	57.57	-10.95	46.62	74.00	-27.38	peak
3	8038.000	57.19	-7.58	49.61	74.00	-24.39	peak

Standard:	FCC Part 15B Class B	Test Distance:	3m
Test item:	Radiated Emission	Power:	AC 120V/60Hz
Model Number:	N5321	Temp.(°C)/Hum.(%RH):	26(°C)/60%RH
Mode:	5 (1GHz~10GHz)	Date:	12/05/2012
Ant.Polar.:	Vertical	Test By:	Frank Lin

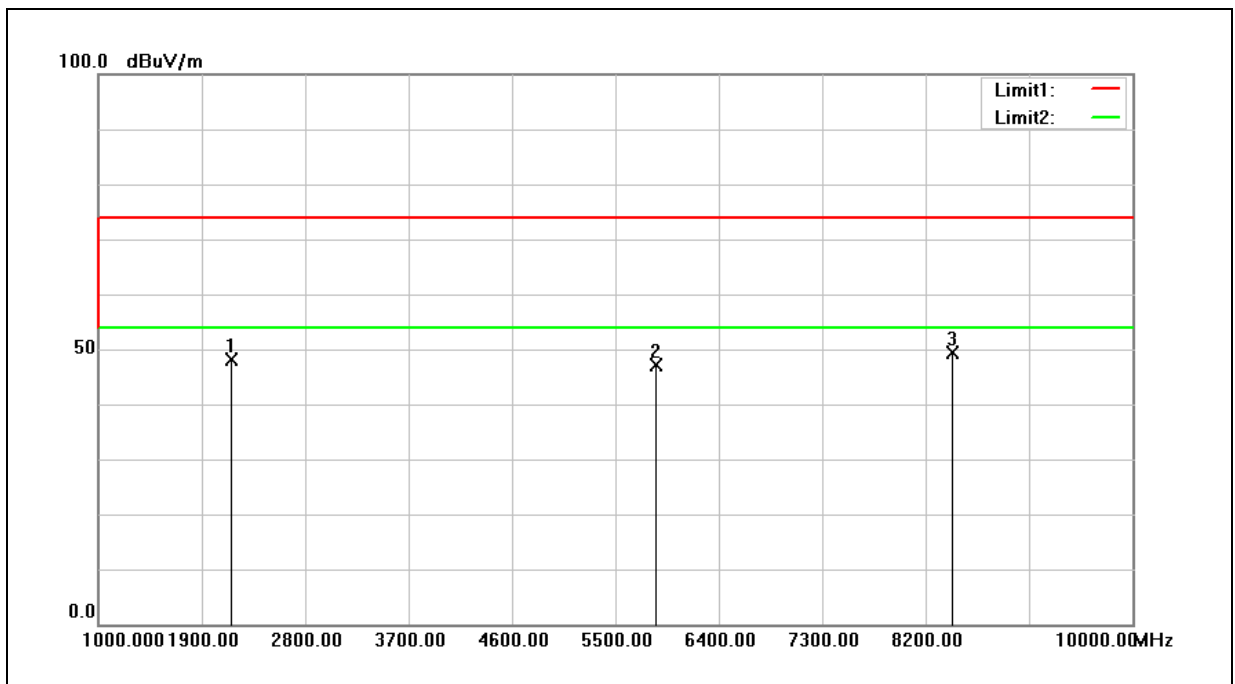

No.	Frequency (MHz)	Reading (dBuV)	Correct Factor (dB/m)	Result (dBuV/m)	Limit (dBuV/m)	Margin (dB)	Remark
1	2152.000	67.06	-19.02	48.04	74.00	-25.96	peak
2	5851.000	57.71	-10.51	47.20	74.00	-26.80	peak
3	8434.000	56.40	-6.96	49.44	74.00	-24.56	peak