

Lenovo □

Model: 2957XXXX(X=0~9, A~Z or blank), 20027 XXXX(X=0~9, A~Z or blank)

S10-2 User Guide V1.0 cover_1-4

Lenovo IdeaPad S10-2 User Guide v1.0

New World. New Thinking.[™]
www.lenovo.com

©Lenovo China 2009



P/N: 147002310
Printed in China

lenovo

lenovo

ideapad

Note

Before using this information and the product it supports, be sure to read the following:

- Important safety information on page iii.
- Chapter 6. Troubleshooting on page 64.
- Appendix E. Notices on page 108.
- *OneKey Rescue System User Guide* included in the package with this publication.

lenovo



**If your product is not working correctly,
DO NOT RETURN IT TO THE STORE.**

For technical assistance, contact a Lenovo support specialist 24 hours a day by calling toll free **1-877-4 LENOVO (1-877-453-6686)**.

Additionally, you can find support information and updates on the Lenovo Web site located at **<http://consumersupport.lenovo.com>**.

* Only for the users from the United States.

First Edition (April 2009)

© Copyright Lenovo 2009. All rights reserved.

U.S. GOVERNMENT USERS – RESTRICTED RIGHTS: Our products and/or services are provided with RESTRICTED RIGHTS. Use, duplication or disclosure by the Government is subject to the GSA ADP Schedule contract with Lenovo, if any, or the standard terms of this commercial license, or, if the agency is unable to accept this Program under these terms, then we provide this Program under the provisions set forth in Commercial Computer Software–Restricted Rights at FAR 52.227-19, when applicable, or under Rights in Data-General, FAR 52.227-14 (Alternate III).

Respective Users

Dear user,

Thanks for purchasing Lenovo notebook! Before using this product, please make sure to read this User Guide carefully.

We are most honored to have you as our customer. In order to make sure you master the usage of Lenovo notebook soon, we have prepared this User Guide for you. This manual has been made very simple and comprehensive. In this manual, you can get information on the system configuration, installation steps and the basic operating systems. We strongly recommend that in using this product, please be sure to carefully read the manual. It will actually help you make better use of the computer. **(If you did not operate the computer according to the requirements in the manual, Lenovo (Beijing) Co., Ltd. will not assume any responsibility for any losses caused there from.)**

We have done our best to avoid human errors in making sure that the information provided in the manual is accurate and reliable. On the other hand, we cannot completely guarantee that there will not be any mistakes that were not found and checked out before printing.

Please bear with us because there might also be some uncontrolled omissions while printing, binding or distributing.

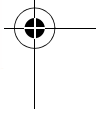
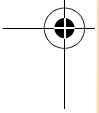

Because we are trying to improve the full performance and reliability of our equipment, the hardware and software components might need some little adjustment. In this case, this might lead to an inconsistency in the actual make up of the equipment to that of the information stated in the manual, but it will not substantially affect your use. Thanks for your understanding.

Thanks for your cooperation!

LENOVO (BEIJING) CO., LTD.

Address: NO.6, Shangdichuangye Road, Haidian District, Beijing, China

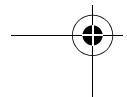
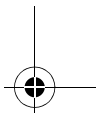
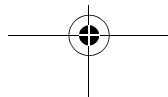
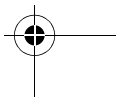
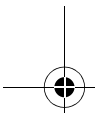
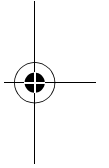
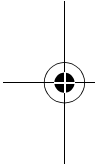

Explanation of hard disk capacity

Dear user,

While using your computer, you may find that the nominal hard disk capacity indicated is somewhat different from the disk capacity displayed by the operating system. For example, a nominal 40GB hard disk will appear as less than 40GB in the operating system. This discrepancy is not an error in hard disk installation nor any other problem, but a normal phenomenon of computers. This phenomenon is primarily due to the following reasons:

I. Different standards used by the manufacturer and operating system when calculating hard disk capacity

Hard disk manufacturers use a radix of 1000, i.e. 1G = 1,000MB, 1MB = 1,000KB, 1KB = 1,000 bytes. However, when identifying hard disk capacity, operating systems use a radix of 1024, i.e. 1GB = 1,024MB, 1MB = 1,024KB, 1KB = 1,024 bytes. The standard adopted by your computer is that of the hard disk manufacturers. Since the standards adopted by the hard disk manufacturer and operating system are different, the hard disk capacity displayed by the operating system will be different from the nominal hard disk capacity.

For example, if the hard disk is nominally X G, even when it is completely empty, the capacity displayed by the operating system will be:

$$X \times 1000 \times 1000 \times 1000 / (1024 \times 1024 \times 1024) \approx X \times 0.931 \text{ G}$$

If a portion of the hard disk space has been used for some specific purpose, then the capacity indicated by the operating system will be even less than $X \times 0.931$ G.

II. A portion of the hard disk space is used for specific purposes

Lenovo computers come with preinstalled OneKey Rescue System, so the hard disk has a special portion partitioned before delivery, which is used to store hard disk mirror and OneKey Rescue System program files. The size of the reserved space for this partition varies according to the model, operating system and software of the computer. For the sake of safety, this partition is not apparent, which is commonly referred to as a "hidden partition".

In addition, after the hard disk is partitioned or formatted, the system will assign a certain amount of hard disk space for the system files.

For the above reasons, the available hard disk space indicated by the operating system is always less than the computer's nominal hard disk capacity.

Contents

Important Safety Information	iii
Important safety information	iii
Chapter 1. Getting to Know Your Computer	1
Top view	1
Left-side view	3
Right-side view	5
Front view	6
Bottom view	7
Chapter 2. Learning the Basics... 9	9
First use.....	9
Putting your computer to standby or shutting it down	11
Using AC adapter and battery	13
Using the touch pad.....	16
Using the keyboard.....	17
Special button	20
System status indicators.....	22
Securing your computer.....	22
Using external devices.....	25
Using Lenovo Quick Start.....	29
Chapter 3. Upgrading and Replacing Devices	32
Replacing the battery	32
Upgrading the hard disk drive	34
Replacing memory	38
Chapter 4. Using the Computer Network	42
Ethernet connection	42
Wireless network connection ..	44
Chapter 5. OneKey Rescue System	50
OneKey Rescue System	50
Chapter 6. Troubleshooting	64
Frequently Asked Questions	64
Troubleshooting	66
Appendix A. Getting Help and Service	73
Getting help on the Web	74
Calling the customer support center	74
Getting help around the world	77
Lenovo warranty service telephone numbers.....	78

Contents

Appendix B. Use, and Care Information.....	80
Caring your computer.....	80
Accessibility and comfort	86
Maintenance	88
Appendix C. Lenovo Limited Warranty	93
Warranty information	102
Appendix D. Customer Replaceable Units (CRUs)	106
Appendix E. Notices.....	108
Notices	108
ENERGY STAR model information	111
Wireless related information..	113
Electronic emissions notices...	117
WEEE and recycling statements	123
EU WEEE Statements.....	124
Japan Recycling Statements....	125
Notice for Users in the U.S.A.....	127
Notice on deleting data from your hard disk	127
Trademarks.....	129
Appendix F. Features and Specifications.....	130
Index.....	127

Important Safety Information

■ Important safety information

This information can help you safely use your notebook personal computer. Follow and retain all information included with your computer. The information in this document does not alter the terms of your purchase agreement or the Lenovo Limited Warranty. For more information, see "Appendix C. Lenovo Limited Warranty" on page 93.

■ Read this first

Personal computers are electronic devices. Power cords, power adapters, and other features can create potential safety risks that can result in physical injury or property damage, especially if misused. The safety risks are categorized as follows:

*** Danger:**

Physical injury or even death may be caused.

⦿ Attention:

Property damage or even minor injury may be caused.

To protect yourself from hazards and create a safer computer work environment, follow the instructions hereafter.

Important Safety Information

Unpack



Inspect the cover of the computer and the AC adapter, especially the parts with the following label attached for any crack or damage.



*** Danger:**

- Hazardous voltage, current, and energy levels are present inside any component that has this label attached.

Important Safety Information

Working place



Do NOT use the computer in humid places such as a bathroom.
Keep the computer and other parts away from liquids.

*** Danger:**

- An electric shock may be caused by spilled liquid.



Do NOT use the computer during a lightning storm.

o Attention:

- Lightning storm may damage the computer and result in an electric shock.



Keep a good ventilation of the computer and other parts.

*** Danger:**

- Placing the working computer or other parts on a bed, sofa or other flexible surface may block the ventilation slots causing overheating of your computer or other parts to overheat or even catch a fire.



Turn off wireless devices where they may cause interference, such as in a hospital or airport.

Important Safety Information

On using



Use **ONLY** the power cord, power adapter and battery pack shipped with the computer and never use them with another product.

Be sure the power outlet is suitable for the plug and provides the correct voltage and current for the product you are installing.

*** Danger:**

- An Unsuitable power supply may damage your computer or cause an electric shock or fire.



Do **NOT** use a power outlet, power cord, power adapter or battery pack that appears to be damaged or corroded



Do **NOT** share an electrical outlet with other home or commercial appliances that draw large amounts of electricity.

If power strips are used, the load should **NOT** exceed the power strip. Unplug the power cord if there is a cracking, hissing, or a popping sound, or a strong odor comes from the computer.

*** Danger:**

- Overloading the power supply may cause unstable voltages which might damage the computer, data, or attached devices, or even cause a fire.

Important Safety Information



Do NOT wrap a power cord around a power adapter or other object.
Do NOT squeeze or pinch the cord, or place heavy objects on it.

⦿ **Attention:**

- Stressing the cord may cause the cord to fray, crack or crimp which may present a safety hazard.



Avoid keeping your hands, your lap, or any other part of your body in contact with a hot section of the working computer for any extended length of time.

⦿ **Attention:**

- Extended contact with your body, even through clothing, could cause discomfort or even a skin burn.



Do not drop, bump, scratch, hit or place heavy objects on the liquid crystal display (LCD) of your computer.

⦿ **Attention:**

- Direct contact of liquid crystal material from a broken LCD is hazardous; contact occurs, rinse with large amount of running water for more than 15 minutes.

Important Safety Information

Service and upgrades



Do NOT attempt to service a product yourself unless instructed to do so by the Customer Support Center or your documentation.

ⓘ **Attention:**

- DO NOT take risks or attempt to diagnose the situation yourself. Contact the Customer Support Center for further guidance. For a list of Service and Support phone numbers, see <http://consumersupport.lenovo.com>.

Lenovo provides documentation with instructions when it is appropriate for customers to install options or replace units (CRUs). Closely follow all instructions when installing or replacing parts.

Disconnect the attached power cords, battery pack, and all the cables before you open the device covers, unless instructed otherwise in the installation and configuration procedures.

Keep the cover closed whenever the computer is plugged in.



Do NOT remove the cover of CD/DVD drive, power adapter, battery pack or other unserviceable parts.

* **Danger:**

- Open the cover of CD/DVD drive or power adapter may result in an electric shock, laser radiation or even a explosion.

Chapter 1. Getting to Know Your Computer

■ Top view

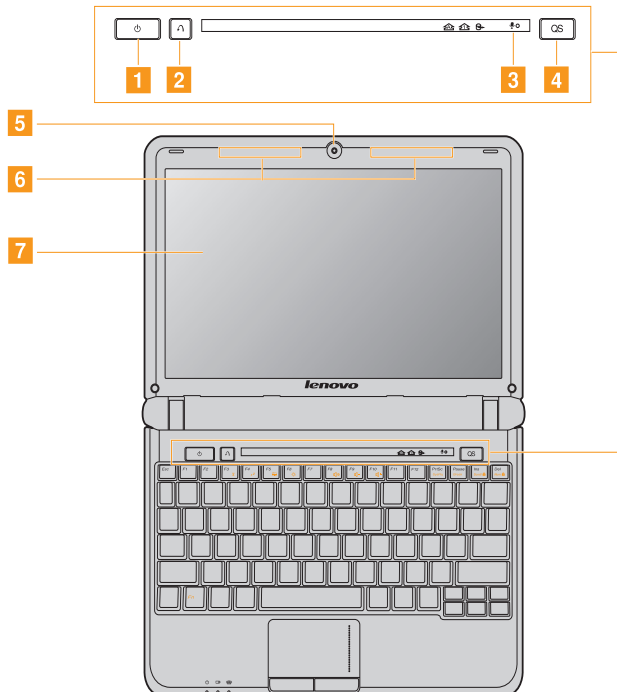

Note: The illustrations in this manual may differ from the actual product. Please refer to the actual product.

Chapter 1. Getting to Know Your Computer

- 1 Power button** Press this button to turn the computer on/off or to preset status.
 - 2 OneKey Rescue System button** Press this button to open **OneKey Rescue System**, which returns the computer to a backup-point.
- Note:** For details see “Chapter 5. OneKey Rescue System” on page 50.
- 3 Built-in array microphone** The built-in microphone (with noise reduction) can be used for video conferencing, voice narration, or simple audio recordings.
 - 4 Quick Start button** Press this button to enter the QS interface when the computer is powered-off.
 - 5 Integrated camera** Use the camera for video communication.
 - 6 Wireless LAN antennas** The built-in antennas ensures an optimal reception of wireless communication radio.
 - 7 Computer display** The LCD display screen provides a brilliance visual output.
 - 8 System status indicators** For details see “System status indicators” on page 22

Chapter 1. Getting to Know Your Computer

■ ■ Left-side view

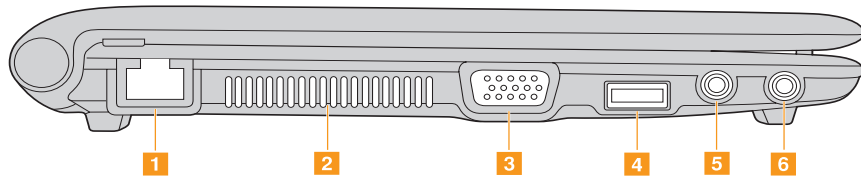

- 1 RJ-45 port** Connect the AC adapter to the computer here.

Note: For details see “Ethernet connection” on page 42.

- 2 Fan louvers** Ensure a straightway heat emanation.

Note: Make sure that none of the fan louvers are blocked, otherwise, overheating of the computer may occur.

- 3 VGA port** Connect with VGA port display.

- 4 USB port** Connect with USB port device.

Note: For details see “Connecting a Universal Serial Bus (USB) Device” on page 26.

- 5 Microphone jack (external)** Connect to external microphone devices.

Note: For details see “Using memory cards” on page 25.

Chapter 1. Getting to Know Your Computer

- 6 Headphone jack (external)** Connect to external headphone devices.

Note: Listening to music at high volume over extended periods of time may damage your hearing.

Chapter 1. Getting to Know Your Computer

Right-side view

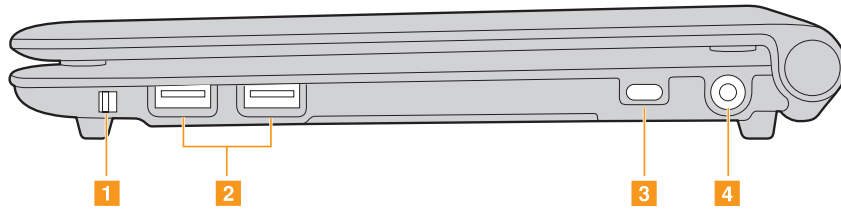

1 Integrated wireless device switch

Use this switch to turn on/off the wireless radio of all the wireless devices on your computer.

2 USB port

Connect with USB port device.

Note: For details see "Connecting a Universal Serial Bus (USB) Device" on page 26.

3 Security keyhole

Connect to a security lock (not supplied).

Note: For details see "Attaching a security lock (optional)" on page 22.

4 AC power adapter jack

Connect the AC adapter to the computer here.

Note: For details see "Using AC adapter and battery" on page 13.

Chapter 1. Getting to Know Your Computer

■ ■ Front view

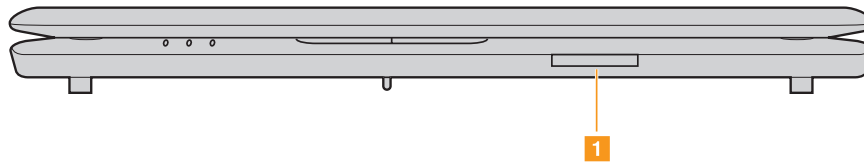

- 1** **Card reader slot** Insert memory cards here.

Note: For details see "Using memory cards" on page 25.

Chapter 1. Getting to Know Your Computer

Bottom view

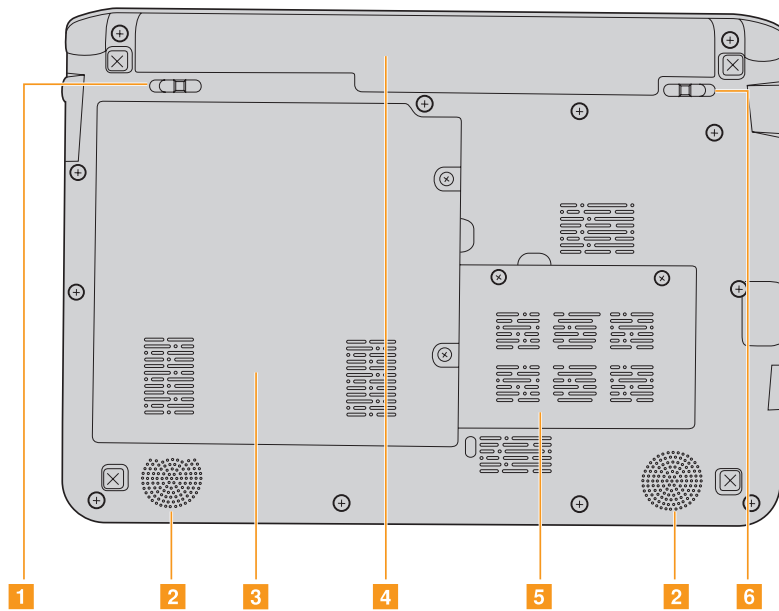

Chapter 1. Getting to Know Your Computer

- 1 Battery latch - manual** The manual battery latch is used to keep the battery pack secured in place.
- 2 Speakers** The stereo speakers provide rich and powerful sound.
- 3 Wireless LAN/ Hard Disk Drive(HDD)** Wireless LAN card and HDD are secured in the compartment.
- 4 Battery pack** For details see "Using AC adapter and battery" on page 13
- 5 Memory (RAM)** RAM is secured in the compartment.
- 6 Battery latch - spring loaded** The spring-loaded battery latch keeps the battery pack secured in place.

Chapter 2. Learning the Basics

■ ■ First use

■ Read the manuals

Read the supplied manuals before handling your computer.

■ Connect to the power

The power to run your computer comes either from the battery pack or from AC power through the AC adapter. When you cannot use the AC adapter to power your computer, you may use battery power to keep your computer running. Connect your computer with the supplied battery pack and AC adapter.

To install the battery pack

Refer the supplied Setup Poster to install the battery pack.

To connect the computer with AC adapter

- 1 Connect the power cord to the transformer pack.
- 2 Connect the AC adapter to the AC power adapter jack of the computer.
- 3 Plug the power cord into an electrical outlet.

Chapter 2. Learning the Basics

■ Turn on the computer

Press the  to turn on the computer.

■ Configure the operating system

You need to configure the operation system when it is first used. The configure process may including the steps below.

- Accept the End User License Agreement
- Enable/disable the update
- Enter the computer name and description
- Internet connection
- Register the Windows
- Configure the user's account

Chapter 2. Learning the Basics

■ Putting your computer to standby or shutting it down

When you finish working with your computer, you can put it to standby or shut it down.

■ Putting your computer to standby

If you will be away from your computer for only a short time, put the computer to standby.

When the computer is in standby state, you can quickly wake it to resume use, and bypass the startup process.

To put the computer to standby, do one of the following.

- Click **start** and select **Stand By** from the **Turn Off Computer**.
- Press **Fn + F4**.

➤ **Warning:**

Wait until the power indicator light starts blinking (indicating that the computer is in standby state) before you move your computer. Moving your computer while the hard disk is spinning can damage the hard disk, causing loss of data.

To wake the computer, do one of the following.

- Press the power button.
- Press any key.

Chapter 2. Learning the Basics

■ Putting your computer to hibernation

When putting your computer into hibernation mode, all the status information is written to the hibernation file which is saved to the hard disk before the computer is shut down.

When you turn your computer back on, the status, including running applications and memory contents are restored to RAM and you return to where you were before the computer was put into hibernation mode.

You may set the way to enter hibernation mode in the **Power Options** of **Control Panel**.

Notes:

- You must enable hibernation in **Power Options** before you use it.
- When Hibernation is enabled some hard disk space is used to save the hibernation file.
- The computer is powered-off in hibernation mode.

■ Shutting down your computer

If you are not going to use your computer for a day or two, shut it down. To shut down your computer, click **start** and select **Turn Off** from the **Turn Off Computer** menu.

Chapter 2. Learning the Basics

■ ■ Using AC adapter and battery

■ Checking battery status

You can determine the percentage of battery power remaining by using Windows **Power Options**.

Note: As each computer user has different habits and needs, it is difficult to predict how long a battery charge will last. There are two main factors:

- The amount of energy stored in the battery when you commence work.
- The way you use your computer: for example, how often you access the hard disk drive and how bright you make the computer display.

■ Charging the battery

When you check the battery status and find that the battery is low, you need to charge the battery or replace it with a charged battery.

The battery is charged when AC adapter is connected to the computer and the battery is installed.

Charging time will depend on the usage environment.

You need to charge the battery in any of the following situations:

- When you purchase a new battery
- If the battery status indicator starts blinking
- If the battery has not been used for a long time

Chapter 2. Learning the Basics

Note: Before you charge the battery, make sure that its temperature is at least 10°C (50°F).

■ Handling the battery

Notes:

- Do not disassemble or modify the battery pack, otherwise, it can cause an explosion or liquid leakage.
- A battery pack other than the one specified by Lenovo, or a disassembled or modified battery pack is not covered by the warranty.
- Do not put the battery pack in trash that is disposed of in landfills. When disposing of the battery, comply with local ordinances or regulations and your company's safety standards.

If the rechargeable battery pack is incorrectly replaced, there may be danger of an explosion. The battery pack contains a small amount of harmful substances. To avoid possible injury, to pay attention to the following points.

Notes:

- Replace only with a battery of the type recommended by Lenovo.
- Keep the battery pack away from fire.
- Do not expose the battery pack to water or rain.
- Do not attempt to disassemble the battery pack.
- Do not short-circuit the battery pack.
- Keep the battery pack away from children.

Chapter 2. Learning the Basics

■ Setting the Power Options

In order to have your computer working in an effective and power-saving way, you need to set the power options, especially when the computer is powered by the battery pack.

You can select a power schemes in the **Power Options** in **Control Panel**.

Chapter 2. Learning the Basics

■ ■ Using the touch pad

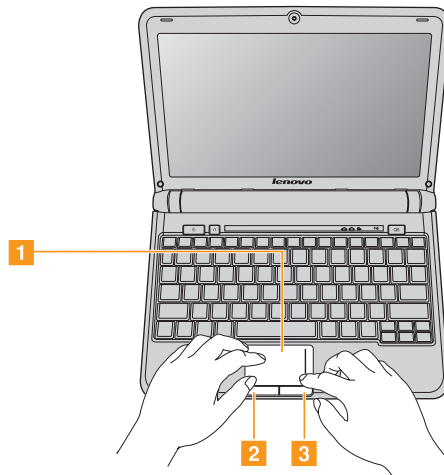

1 Touch pad

To move the cursor on the screen, slide your fingertip over the pad in the direction in which you want the cursor to move.

2 Left click button

The function corresponds to those of the left mouse button on a conventional mouse.

3 Right click button

The function corresponds to those of the right mouse button on a conventional mouse.

Note: You can enable/disable the touch pad using **Fn+F5**.

Chapter 2. Learning the Basics

■ ■ Using the keyboard

Your computer has a numeric keypad and function keys incorporated in the standard keyboard.

■ Numeric keypad

The keyboard has keys that, when enabled, work as a 10-key numeric keypad.

To enable or disable the numeric keypad, press **Fn+DEL**.



Note: The illustrations in this manual may differ from the actual product. Please refer to the actual product.

Chapter 2. Learning the Basics

■ Function key combinations

Through the use of the function keys, you can change operational features instantly. To use this function, press and hold **Fn** **1**; then press one of the function keys **2**.

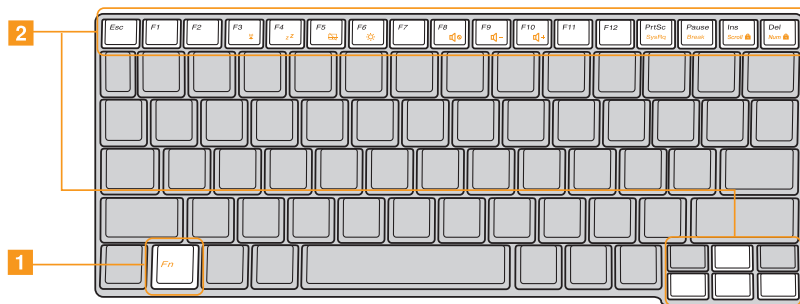

Chapter 2. Learning the Basics

The following describes the features of each function key.

Fn + F4:	Enter Stand by mode.
Fn + F6:	Decrease display brightness.
Fn + F3:	Open the interface for integrated wireless devices settings (enable/disable).
Fn + F5:	Enable/disable the touch pad.
Fn + F7:	Increase display brightness.
Fn + F8:	Enable/disable mute.
Fn + F9:	Decrease sound volume.
Fn + F10:	Increase display brightness.
Fn + F11:	Enter hibernation mode.
Fn + Ins	Enable/disable the Scroll Lock.
Fn + Del	Enable/disable the Numeric keypad.

Chapter 2. Learning the Basics

■ ■ Special button

■ Quick Start button

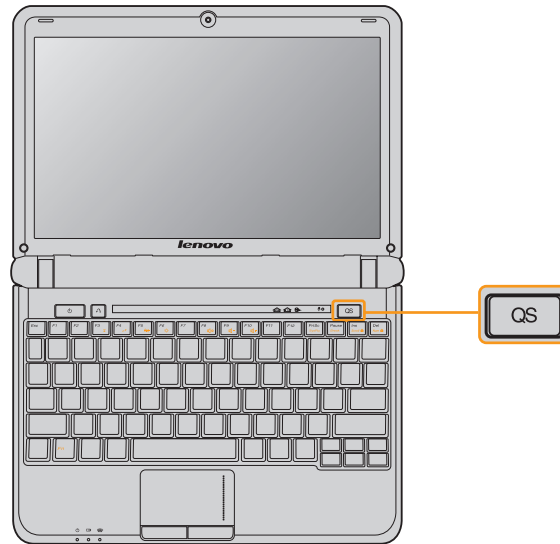

Chapter 2. Learning the Basics

Quick Start button

- When the computer is powered-off, press this button to open the QS interface.

Note: For details see “Using Lenovo Quick Start” on page 29.



- In Windows, press this button to launch a self-defined program, file or a Website.

Note: To re-define the Quick Start button select **Self-defined program setting in start- All Programs-Lenovo-Energy Management.**

Chapter 2. Learning the Basics

■ ■ System status indicators

These indicators inform you of the computer status.

- Power Indicator 
- Battery Status Indicator 
- Wireless/Bluetooth Indicator 

■ ■ Securing your computer

This section provides information about how to help protect your computer from theft and unauthorized use.

■ Attaching a security lock (optional)

You can attach a security lock to your computer to help prevent it from being removed without your permission.

Attach a security lock to the keyhole of the computer; then secure the chain on the lock to a stationary object. Refer to the instructions shipped with the security lock.

Refer to the “Right-side view” on page 5 for the location of the security keyhole.

Chapter 2. Learning the Basics

Notes:

- Before purchasing any security product, verify that it is compatible with this type of security keyhole.
- You are responsible for evaluating, selecting, and implementing the locking devices and security features. Lenovo makes no comments, judgements, or warranties about the function, quality, or performance of locking devices and security features.

■ Using VeriFace™

VeriFace is a face recognition software which takes a digital snapshot, extracts key features of your face, and creates a digital map that becomes the system's "password".

Note: The face registration and verification works best in an environment with steady and even light.

For more instructions on VeriFace, see the help file on your software.

■ Using passwords

Using passwords helps prevent your computer from being used by others. Once you set a password and enable it, a prompt appears on the screen each time you power on the computer. Enter your password at the prompt. The computer cannot be used unless you enter the correct password.

Make sure that only authorized individuals access your computer. Establishing different kinds of passwords requires that other possible users know the proper passwords in order to access your computer or your data.

Chapter 2. Learning the Basics

This password can be from one to seven alphanumeric characters in any combination.

For details about how to set the password, see the help to the right of the screen in BIOS setup utility.

Note: To enter BIOS setup utility, press **F2** when starting up your computer.

Chapter 2. Learning the Basics

■ Using external devices

Your computer has many built-in features and connection capabilities.

Note: Do not connect or disconnect any external device cables other than USB while the computer power is on; otherwise, you might damage your computer. To avoid possible damage to attached devices, wait at least five seconds after the computer is shut down to disconnect external devices.

■ Using memory cards

Use **ONLY** the following memory cards with the Multi media Card reader. For more information on usage, read the instructions shipped with the memory card.

- Secure Digital (SD)
- MultiMediaCard (MMC)
- Memory Stick (MS)
- Memory Stick PRO (MS PRO)

Notes:

- Insert **ONLY** one card in the slot at a time.
- This card reader does not support SDIO devices (e.g. SDIO Bluetooth, etc.).

Chapter 2. Learning the Basics

■ Connecting a Universal Serial Bus (USB) Device

Your computer comes with USB ports compatible with USB devices such as a keyboard, mouse, camera, hard disk drive, printer and scanner.

Notes:

- When you attach a USB cable to the port, make sure that the USB mark  is to the upper side, otherwise the port might be damaged.
- When using a high power consumption USB device such as USB ODD, use external device power adapter. Otherwise, the device may not be recognized, or system shut down may result.

■ Connecting a *Bluetooth* device (specific models only)

If your computer has an integrated *Bluetooth* adapter card, it can connect to and transfer data wirelessly to other *Bluetooth* enabled devices, such as laptop computers, PDAs and cell phones. You can transfer data between these devices without cables and up to 10 meters range in open space.

Enabling *Bluetooth* communications

- 1 Slide the integrated wireless device switch open.
- 2 Press **Fn + F3** to make configuration.

Note: When you do not need to use the *Bluetooth* function, turn it off to save battery power.

Chapter 2. Learning the Basics

Pairing wireless device

- 1 Enable the *Bluetooth* function of the wireless device that need to connect to the computer.
- 2 Open the **Bluetooth Devices** in the **Control Panel**, click **Add Wireless Device**, select the wireless device you need to connect and click **NEXT**.
- 3 Select a pairing option, and pairing the device with pairing code or without pairing code.
- 4 Pairing succeed. Files can be transferred between the device and computer.

Notes:

- If you pair the *Bluetooth* connection from the wireless device, Open **Bluetooth File Transfer Wizard** from **Accessories** of the **Start** menu and then click **Receive a file** to let other device searched the computer.
- For details on Pairing wireless device, please refer to the instructions shipped with the devices that you have purchased separately.

To send files from the computer to the paired wireless device

- 1 Open **Bluetooth File Transfer Wizard** from **Accessories** of the **Start** menu.
- 2 Click **Send a file**, select the wireless device where you want to save the file and click **NEXT**.
- 3 Select the file and send it.

Chapter 2. Learning the Basics

To receive files from the paired wireless device to the computer

Refer to the instructions shipped with the wireless devices to send files to the computer.

The files are saved in **Bluetooth Exchange Folder**.

Note: You can change the path of **Bluetooth Exchange Folder** in **Control Panel** → **Bluetooth Devices** → **Bluetooth Settings** → **Share**.

Chapter 2. Learning the Basics

■ ■ Using Lenovo Quick Start

With a fast boot in a few second, Lenovo Quick Start offers a handy environment that allows you to enjoy an instant access to functions like web browsing, instant messaging and other entertainment functions without entering the traditional OS.

■ To enter the QS interface

Press the QS button when the computer is powered-off.

Web

A full-featured World Wide Web browser, optimized to give you a great Internet experience instantly.

Chapter 2. Learning the Basics

Music

Allows you to play music in the MP3 format, using all of the standard playback and navigation controls, and create Playlists of your songs.

Online Games

Online Games provides a wide variety of games and amusements including a game search function.

Photo

An image viewer which lets you arrange your photos into albums and display them in different view modes.

Chat

Starts the Chat instant messaging tool, which lets you use your existing accounts in various IM programs such as AIM, Google Talk, MSN Messenger, Yahoo Messenger, and others, to chat with your friends and set a wide variety of preferences as desired.

Skype

Starts Skype, communicate free-of-charge with other Skype users. Also, offers affordable, high quality long-distance phone calls to land lines.

Chapter 2. Learning the Basics

Share Your Ideas

Use this function to access a list of shortcuts to some of the most popular “social network” on-line communities and services.

Note: If the applications above stops responding, right-click the icon and select close to stop it.

■ To exit the QS interface

- Click the ## to exit the QS interface to main operating system.
- Click the ## to turn off the computer.

Chapter 3. Upgrading and Replacing Devices

■ Replacing the battery

Note: Use only the battery specified in the parts list for your computer. Any other battery could ignite or explode.

■ To replace the battery

- 1 Turn off the computer, or enter hibernation mode. Then disconnect the AC adapter and all cables from the computer.

Note: If you are using a PC Card, the computer might not be able to enter hibernation mode. If this happens, turn off the computer.

- 2 Close the computer display, and turn the computer over.

Chapter 3. Upgrading and Replacing Devices

- 3 Unlock the manual battery latch **1**. Hold provides the spring-loaded battery latch in the unlocked position **2**, remove the battery pack in the direction shown by arrow **3**.

- 4 Install a fully charged battery.
- 5 Slide the manual battery latch to the locked position.
- 6 Turn the computer over again. Connect the AC adapter and the cables to the computer again.

Chapter 3. Upgrading and Replacing Devices

■ ■ Upgrading the hard disk drive

You can increase the storage capacity of your computer by replacing the hard disk drive with one of greater capacity. You can purchase a new hard disk drive from your reseller or Lenovo marketing representative.

Notes:

- Replace the hard disk drive only if you upgrade it or have it repaired. The connectors and bay of the hard disk drive were not designed for frequent changes, or drive swapping.
- The preinstalled softwares are not included on an optional hard disk drive.

Handling a hard disk drive

- Do not drop the drive or subject it to physical shocks. Put the drive on a material, such as soft cloth, that absorbs the physical shock.
- Do not apply pressure to the cover of the drive.
- Do not touch the connector.

The drive is very sensitive. Incorrect handling can cause damage and permanent loss of data on the hard disk. Before removing the hard disk drive, make a backup copy of all the information on the hard disk, and then turn the computer off. Never remove the drive while the system is operating, in sleep mode, or in hibernation mode.

Chapter 3. Upgrading and Replacing Devices

To replace the hard disk drive, do the following:

- ❶ Turn off the computer; then disconnect the AC adapter and all cables from the computer.
- ❷ Close the computer display, and then turn the computer over.
- ❸ Remove the battery pack.
- ❹ Remove the screws that secure the Wireless LAN/Hard Disk Drive(HDD) compartment cover **❶**.
- ❺ Remove the cover **❷**.

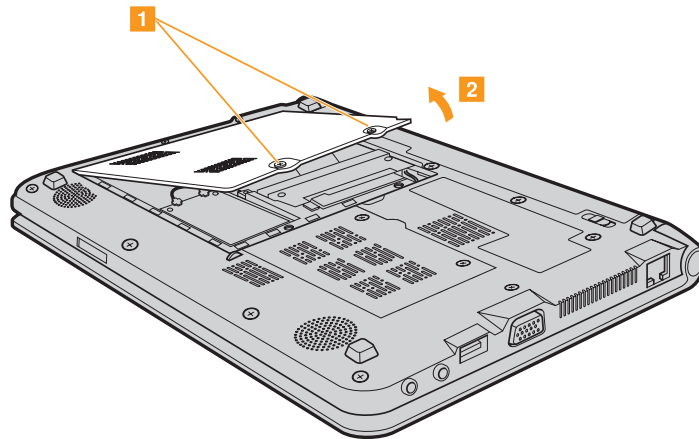

Chapter 3. Upgrading and Replacing Devices

- ⑥ Pull the tab in the direction shown by arrow ③.

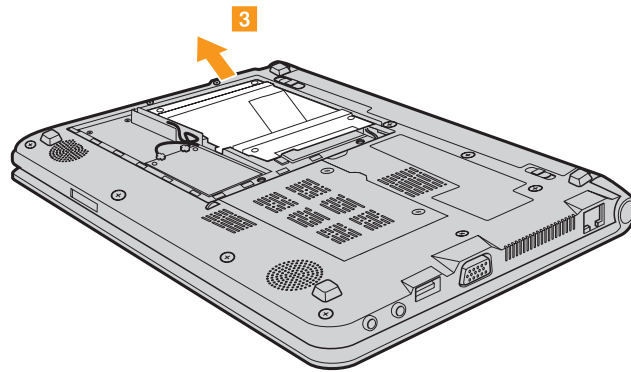

- ⑦ Take out the hard disk drive secured in a metal frame ④.

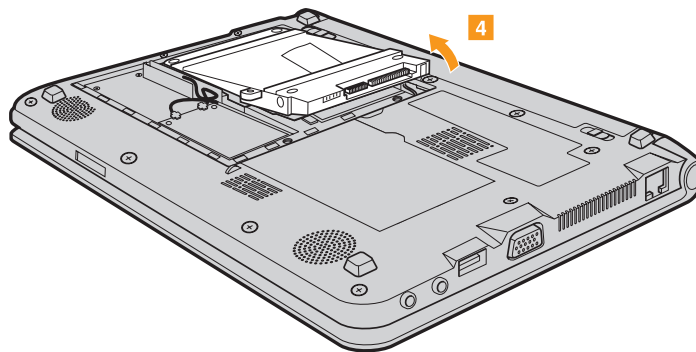

Chapter 3. Upgrading and Replacing Devices

- ⑧ Remove the screws and detach the metal frame from the hard disk drive.
- ⑨ Attach the metal frame to a new hard disk drive; then tighten the screws.
- ⑩ Put the hard disk drive gently into the hard disk drive bay with the tab facing upwards and the connectors facing each other; then push it firmly into space.
- ⑪ Reinstall the cover of Wireless LAN/Hard Disk Drive(HDD) compartment.
- ⑫ Reinstall the screws.
- ⑬ Reinstall the battery pack.
- ⑭ Turn the computer over again. Connect the AC adapter and the cables to the computer pack.

Chapter 3. Upgrading and Replacing Devices

■ ■ Replacing memory

Increasing memory capacity is an effective way to make programs run faster. You can increase the amount of memory in your computer by replacing a double data rate (DDR) 2 synchronous dynamic random access memory (DRAM) unbuffered small outline dual inline memory module (SO-DIMM), available as an option, in the memory slot of your computer. SO-DIMMs with different capacities are available.

Note: Use only the memory types supported by your computer. If you incorrectly install the optional memory or install an unsupported memory type, a warning beep will sound when you try to start the computer.

To install an SO-DIMM, do the following:

- 1 Touch a metal table or a grounded metal object to reduce any static electricity in your body, which could damage the SO-DIMM. Do not touch the contact edge of the SO-DIMM.
- 2 Turn off the computer; then disconnect the AC adapter and all cables from the computer.
- 3 Close the computer display, and turn the computer over.
- 4 Remove the battery pack.

Chapter 3. Upgrading and Replacing Devices

- 5 Remove the Memory (RAM) compartment cover.
 - a. Remove the screws that secure the compartment cover 1.
 - b. Remove the compartment cover 2.

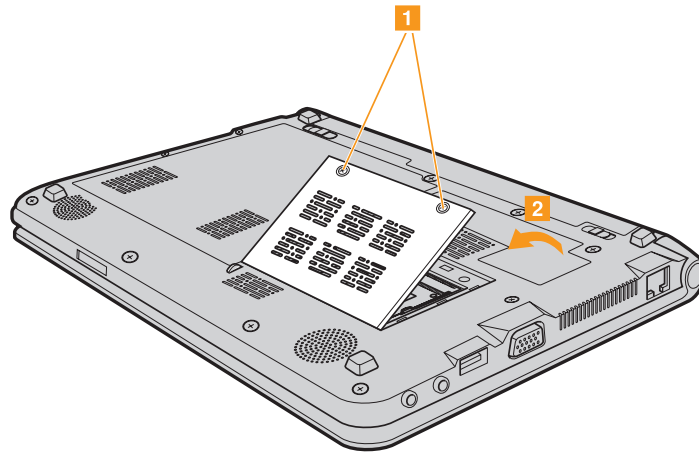

- 6 Pressing out on the latches on both edges of the socket at the same time and remove the SO-DIMM. Be sure to save the old SO-DIMM for future use.
- 7 Insert the notched end of the DIMM into the socket.

Chapter 3. Upgrading and Replacing Devices

Press the DIMM firmly, and pivot it until it snaps into the place. Make sure that it is firmly fixed in the slot and does not move easily.

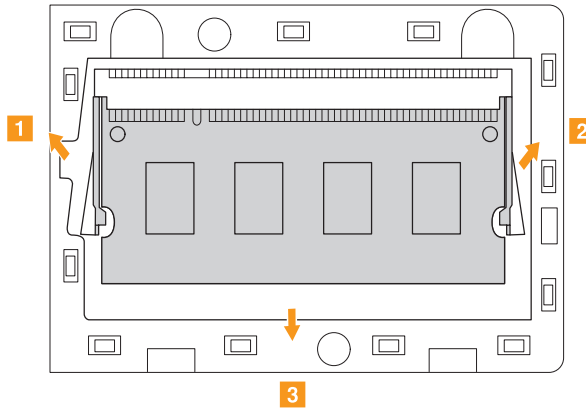

- ⑧ Reinstall the thermal slot cover.
- ⑨ Reinstall the battery.
- ⑩ Turn the computer over, and reconnect the AC adapter and the cables to the computer.

To make sure that the SO-DIMM is installed correctly, do as follows:

- ① Turn the computer on.
- ② Hold F2 during startup, and the **BIOS setup utility** screen opens. The **System Memory** item shows the total amount of memory installed in your computer.

Chapter 3. Upgrading and Replacing Devices

The following table provides a list of CRUs (Customer Replaceable Units) for your computer and tells where to find the replacement instructions.

	Setup Poster	Supplement	Online Hardware Maintenance Manual	Online Video
Self-service CRUs				
AC adapter	X			
Power cord for AC adapter	X			
Battery	X	X		X
Bottom access doors		X	X	X
Hard disk drive		X	X	X
Memory		X	X	X
Optical drive		X	X	X
Optional-service CRUs				
PCI Express Mini Card for wireless LAN			X	X

Chapter 4. Using the Computer Network

A computer network is a collection of interconnected computers and devices, which allows the connected computers to communicate with each other to share resources and information.

As a global network, the Internet connects computers worldwide providing service as E-mails, information search, electronic commerce, web browse and entertainment.

You can connect the computer to the Internet in the following ways:

Ethernet: uses physical wiring to connect.

Wireless network technology: connect without wiring.

■ Ethernet connection

Ethernet connection is a reliable and safe way to connect the computer to the Internet. Generally, these two accessing methods are widely used.

Cable	Cable Internet service uses a cable modem connected to the residential cable TV line.
DSL	DSL is a family of related technologies that bring high-speed network access to homes and small businesses over ordinary telephone lines.

Cable boasts faster speed than DSL in theory, while DSL is popular with a better reliability.

Chapter 4. Using the Computer Network

■ Hardware connection:

Cable

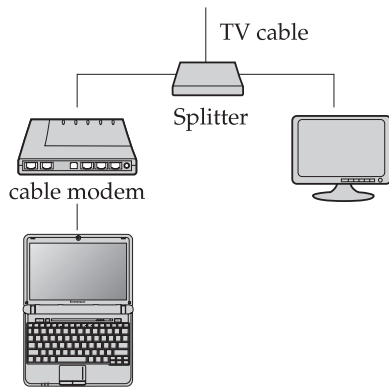

DSL

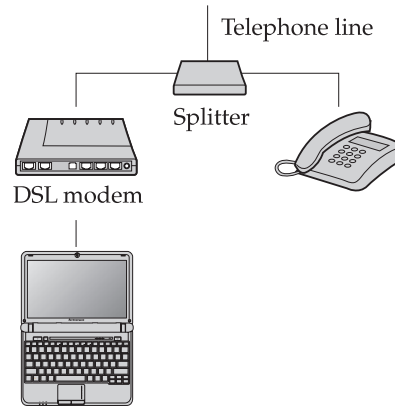

■ Software configuration

Ask your Internet Service Provider (ISP) to configure your computer.

Chapter 4. Using the Computer Network

■ ■ Wireless network connection

Wireless connection provides a mobile access to the Internet, allowing you to stay online anywhere the wireless signal covers.

Depending on the signal scale, you can connect your computer to the Internet wirelessly by the following two methods.

Wi-Fi WLAN	Wi-Fi WLAN covers a small physical area, like a home, office, or small group of buildings. An access point (ex. wireless router) is necessary for the connection.
3G WWAN	The 3G WWAN also known as a Mobile Broadband network provides Internet access to computers, cell phones and other devices over a large geographic area. Mobile networks are used for data transmission, and access is usually provided by a mobile network operator. A 3G WWAN SIM card is necessary for the connection.

Notes:

- Various standards are in use by mobile operators to provide Mobile Broadband service. Depending on the model, your Mobile Broadband module may support one or more of the following standards:
 - GSM (Global System for Mobile Communications)
 - TD-SCDMA (Time Division-Synchronous Code Division Multiple Access)
 - SCDMA (Synchronous Code Division Multiple Access)
 - EV-DO (Evolution Data Optimized)
 - HSPA (High Speed Packet Access)
- Mobile Broadband is a subscription service. Refer to your local mobile network operator for availability, cost and other information.

Chapter 4. Using the Computer Network

■ Getting started with Mobile Broadband

Before getting started with Mobile Broadband, you first need to choose a mobile network operator and make sure you are in the coverage area of the network. After that, you also need:

- To activate Mobile Broadband service through your local mobile network operator. You will get a Subscriber Identity Module (SIM) card after activation. For instructions on inserting the SIM card, refer to the "Inserting the SIM card" on page 46.

Note: A SIM card is a type of smart card used by mobile network operators to identify their service subscribers on the mobile network. You will get the SIM card from your mobile network operator after you have activated the Mobile Broadband service.

- A connection management utility to connect/disconnect to your Mobile Broadband network.

Note: In general, your mobile service provider provides this utility.

Chapter 4. Using the Computer Network

Inserting the SIM card

To insert the SIM card:

- 1 Turn off the computer; then disconnect the AC adapter and all cables from the computer.
- 2 Close the computer display and turn it over.
- 3 Remove the battery.
- 4 Insert the SIM card to the card slot until it clicks into place as shown in the drawing.

❖ **Note:**

Insert the SIM card in the direction shown below. Inserting the SIM card in the wrong direction may damage the SIM card slot.

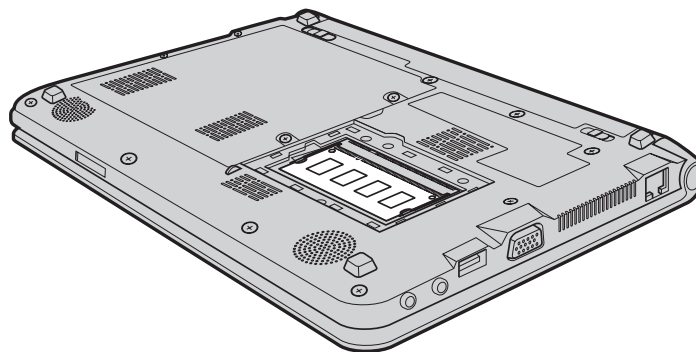

- 5 Put the battery back in place, turn the computer over again, and reconnect the cables.

Chapter 4. Using the Computer Network

Notes:

- Never insert or remove the SIM card while the computer is on. Doing so may cause permanent damage to the SIM card as well as the SIM card reader.
- Be sure to lock the card holder when the SIM card is inserted.

Removing the SIM card

To remove the SIM card:

- 1 Turn off the computer; then disconnect the AC adapter and all cables from the computer.
- 2 Close the computer display and turn it over.
- 3 Remove the battery.

Chapter 4. Using the Computer Network

- 4 Push the SIM card in until you hear a click, and then pull the SIM card out.

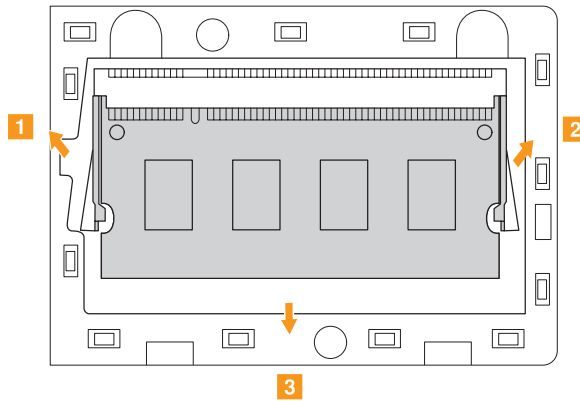

- 5 Put the battery back in place, turn the computer over again, and reconnect the cables.

Note: Be sure to lock the card holder when the SIM card is removed.

Chapter 4. Using the Computer Network

Hardware connection:

Wi-Fi WLAM



3G WWAN



■ Software configuration

Ask your Internet Service Provider (ISP) to configure your computer.

Chapter 5. OneKey Rescue System

■ OneKey Rescue System

■ Introduction

Lenovo OneKey Recovery is an easy-to-use application that can be used to back up the data on your system partition (C drive) and then easily restored when required. You can run Lenovo OneKey Recovery under both Windows and WinPE.

■ Important Notes

- In order to utilize the features of OneKey Recovery, your hard disk already includes a hidden partition by default to store a system mirror image file and OneKey Recovery program files. This default partition is hidden for security reasons and is the reason the available disk space is less than it claims. The exact available hard disk space depends on the file size of the mirror image file (based on the size of operating system and pre-installed software.)
- You can use Restore to Factory Default feature to restore the system partition (C drive) back to the factory default, i.e. the state your computer was when you purchased it. However, once you restore to this status, you will not be able to restore the system to another previously backed up state. Therefore, make sure you back up your critical data on the system partition (C drive) to other media, such as a another disk partition, CD/DVD discs or removable storage devices.

Chapter 5. OneKey Rescue System

■ Using Lenovo OneKey Recovery in Windows

In Windows, you can create a backup of an entire system partition, saving it to your local hard disk. You can back up your data to a CD, DVD, network drive or other removable disk. In addition, you can also create Windows recovery disc(s) to boot and recover your system.

Create Full Backup

There are two backup types that can be created: full backup and incremental backup. Selecting Full backup backs up your system partition to a folder on the hard disk in order to recover it in the future. The program will save the backed up data to the default location. For example to D:\Lenovo\OneKey App\OneKey Recovery. You may also select another destination, such as removable storage devices, network drives or a CD/DVD.

If you choose to back up system partition to a disc (CD/DVD), the created discs can be used to recover your system to the current status.

We suggest you do the following before you create recovery discs:

- Use the latest version of your system's anti-virus software to scan your computer and make sure it is virus-free.
- Optimize your system, including scanning and defragmenting your hard disk drive.

Chapter 5. OneKey Rescue System

Notes:

- For the computers without an optical drive, an external optical drive is needed to backup or to create a recovery disc.
- A full backup needs considerable storage space, be sure to have enough CDs/DVDs in hand.
- The backup process takes a long time, connect the AC adapter to your computer.

Create Incremental Backup

An incremental backup is a backup of your data based on previous backed up file located in the default path. This backup includes different data than the full backup, such as application variations and user data.

Incremental backup can only be saved to the default path; it cannot be backed up to another location.

Create Recovery Disc

You can burn the backup image to a CD/DVD as recovery discs. The recovery discs can be used to boot up your computer automatically and restore your system back to previously backed up status. If your hard disk fails and you are unable to use Lenovo OneKey Recovery on your computer, you can use these discs to recover your system on a reformatted hard drive.

Chapter 5. OneKey Rescue System

Notes:

- Please make sure to create recovery discs, so that you can recover your system, even when replacing the hard drive.
- After the recovery discs are burned, please number them so that you can use them in order.
- When burning the recovery discs, please use good quality discs with to ensure the burning process and backed up data is complete and correct.

■ Using Lenovo OneKey Recovery in WinPE

When the operating system can not be loaded, you need to recover your system with OneKey Rescue System, which includes several applications to help you detect and remove viruses, and recover Windows system and data. You can press OneKey Rescue System key  to activate Lenovo OneKey Rescue when your PC is turned off. Within the program, you can restore your system partition to the original factory status or to a previously generated backup. You may also transfer critical data or documents to other storage devices. All these features make Lenovo OneKey Recovery an important utility to secure your data.

Restore of Factory Default

In order to save application files and the initial backed up files of the system, the hard disk in a Lenovo PC includes a hidden partition when it is shipped. If you need to restore the system to the point of your first boot up, just enter Lenovo OneKey Rescue System and run Restore to Factory Default . This will delete all the new data on the system partition

Chapter 5. OneKey Rescue System

(C partition), which is not recoverable. Make sure to back up your critical data before you run this feature.

Restore from Backup

If you want to recover the system to a previous status, you just need to enter Lenovo OneKey Rescue, and select Restore from User's Backup. Select the appropriate image file or, if you have run incremental backup before, you can use the incremental file to restore your system.

The process above will remove all data on the current system partition (C partition), which is not recoverable. Please back up all important data before restoring to a previous backup.

Using Recovery Discs

When you replace a hard disk drive in your computer, you are unable to use the pre-installed Lenovo OneKey Recovery and OneKey Rescue. However, you can use the recovery discs that store your backed up data to restore your new hard drive to a previous backup status.

When you use the recovery discs to boot your computer, the system will enter system recovery user interface automatically. Please follow the prompt to insert the backup discs in order to complete the entire recovery process.

Chapter 5. OneKey Rescue System

Back Up My Data

Within the Lenovo OneKey Rescue System you can transfer your data from your computer's hard disk to other devices, so you may easily find it if your Windows system ever encountered a critical failure.

System Repair

When you use Lenovo OneKey Rescue System, the program detects whether Windows has been damaged. If the system kernel files are damaged, Lenovo OneKey Rescue System will prompt you to proceed with a system repair. The system will reboot after the repair process is complete. If there are no files damaged, Lenovo OneKey Rescue System starts normally.

- System repair only works for system data files. Using this feature will not affect your own data

Set and Manage User Password

You can set up your user password within Lenovo OneKey Rescue System to ensure other users cannot use the system recovery or Back Up My Data functions.

By default, the user password within the Lenovo OneKey Rescue System is blank and it is recommended that you immediately set a new password to ensure your system is protected.

Chapter 5. OneKey Rescue System

■ Frequently Asked Questions (on OneKey Recovery)

Glossary

<i>Term</i>	Definition
<i>Restore to factory default</i>	Restores the system partition (C drive) back to the factory initial status. However, once you do this, you will not be able to restore to a backed up state created after you began using your computer. Therefore, it is recommended that you back up your critical data on the system partition (C drive) before proceeding.
<i>Full backup</i>	A full backup is a backup of the entire system partition. You will need to perform a full back up before you can run incremental back up. The backed up data will be saved in the default location. You can also specify the location to another path.
<i>Incremental backup</i>	An incremental backup is a backup of your data based on previous backed up file, backing up only the new/different data. Incremental backup can save hard disk space and back up time. For ease of management, the incremental backup file can only be saved to the default location.
<i>Create recovery disc</i>	Burn the backed up system partition data to discs and create recoverable disc(s). This allows you to recover your current system status even if you replace your hard disk in the future.
<i>Back up my data</i>	Copies your data to other storage devices, such as a removable drive or a network server, so that you can retrieve the data easily under system failure.

Chapter 5. OneKey Rescue System

Backing Up Your Data

Why can't I run full back up?

The possible causes are:

- *Case 1* : you are not currently using a Windows operating system (XP/Vista) .
- *Case 2* : there is not enough space to store the backed up data. You will need to free more hard disk space on your system partition (C drive).
- *Case 3* : if you are backing up your data to a CD/DVD, make sure you are using compatible burning devices.
- *Case 4* : if you are burning backed up files to CD/DVD, make sure the burning devices are compatible with the CD/DVD discs.

Why can't I run incremental back up?

The possible causes are:

- *Case 1* : you didn't run full backup in the default path. Please make sure you ran full back up in this path before runing incremental backup.
- *Case 2* : you didn't select the default path for incremental back up. Incremental backed up files can be only saved to the default path. Please do not specify a different location.

Chapter 5. OneKey Rescue System

- *Case 3* : the free disk space for the default location is insufficient. Please free more space on that hard drive.

What can I do if the back up process fails?

If you can start the back up feature without a problem, but it fails during the back up process, please try the following steps:

- ❶ Close other applications, then restart the backup process.
- ❷ Check if the destination media is damaged, try to select another path and then try again.

Recovering Your Data

Why can't I run full back up?

The possible causes are:

- *Case 1* : you are not currently using a Windows operating system (XP/Vista).
- *Case 2* : there is not enough space to store the backed up data. You will need to free more hard disk space on your system partition (C drive).
- *Case 3* : if you are backing up your data to a CD/DVD, make sure you are using compatible burning devices.
- *Case 4* : if you are burning backed up files to CD/DVD, make sure the burning devices are compatible with the CD/DVD discs.

Chapter 5. OneKey Rescue System

Why can't I run incremental back up?

The possible causes are:

- *Case 1* : you didn't run full backup in the default path. Please make sure you ran full back up in this path before runing incremental backup.
- *Case 2* : you didn't select the default path for incremental back up. Incremental backed up files can be only saved to the default path. Please do not specify a different location.
- *Case 3* : the free disk space for the default location is insufficient. Please free more space on that hard drive.

What can I do if the back up process fails?

If you can start the back up feature without a problem, but it fails during the back up process, please try the following steps:

- ① Close other applications, then restart the backup process.
- ② Check if the destination media is damaged, try to select another path and then try again.

Chapter 5. OneKey Rescue System

Recovering Your Data

When do I need to use the Restore to Factory Default feature?

You can use this feature when your system fails or you need to re-install your operating system. This will restore your computer back to the initial status when you first booted up your computer after receiving it from the store. By doing this, the data on your system partition will be restored to the factory default. If there is critical data on your current partition, please back it up before you run this recovery feature.

Why can't I use the Restore to Factory Default feature?

If your system partition was modified, such as the partition size or the drive capacity of C was changed by another partition utility, you will not be able to use the Restore to Factory Default feature. Therefore, we suggest that you don't change the size of that partition to make sure the Restore to Factory Default feature is workable under any circumstance.

What can I do if the recovery process fails?

If you can start the recovery feature without a problem, but it fails during the recovery process, this may be caused by one of the following reasons:

- The backed up files were damaged
- The disc(s) were physically damaged
- Other unknown issues

Chapter 5. OneKey Rescue System

In this case, please select other backed up files and try to recover them. If it still doesn't work, you can use Restore to Factory Default feature to restore your system partition to factory default. Please note your data on system partition will be lost during this restore process.

Why can't I find the backed up files during recovery process?

In OneKey Rescue System, the disk partition structure is different from Windows system. Therefore you may not be able to find the backed up data in the Windows backup path. In this case, you can change to another disk partition and try to locate backed up data in the folders of other partitions, then continue to complete the recovery process.

Chapter 5. OneKey Rescue System

Using Recovery Disc(s)

How can I create the recovery discs for my current system?

You can use Create Full Backup feature in OneKey Recovery's Backup section, then choose back up to discs.

Why can't the recovery disc(s) recover the entire hard disk drive?

The recovery discs include the backed up files of the system partition (c partition), instead of the backed up files of entire hard disk drive. Therefore you can't recover the entire hard disk with the recovery discs you created.

Why can't I use the recovery disc(s)?

- When you create recovery discs, please use reliable discs, or the backed up data may be damaged.
- When you use the recovery discs, please follow the instructions to insert backup discs.

Back Up My Data Feature

When do I need to use the Back Up My Data feature?

When your system fails or is unable to boot up, you can use Back Up My Data feature to retrieve the data you need immediately from your PC.

Chapter 5. OneKey Rescue System

Others

How do I access the Lenovo OneKey Rescue System?

You can press OneKey Rescue System key  to activate Lenovo OneKey Rescue when your PC is turned off. You cannot only use system recovery features, but also use other applications like system recovery, virus detection and cleaning to protect your computer.

Why can't System Repair fix system partition data completely?

System Repair feature can only fix important system kernel files to ensure the system can boot up normally. It will not repair all data files.

Why does System Repair always prompt me that system kernel files need to be repaired when using OneKey Rescue System?

Please make sure you have installed Windows Vista SP1 or Windows XP SP2 on your system.

Chapter 6. Troubleshooting

■ ■ Frequently Asked Questions

This section lists frequently asked questions and tells where you can find detailed answers. For details about each publication included in the package with your computer, see Lenovo IdeaPad S10-2 Setup Poster.

What safety precautions should I follow when using my computer?

See "Appendix B. Use, and Care Information" for detailed information about safety.

How can I prevent problems with my computer?

See "Appendix B. Use, and Care Information" on page 80 of this guide. More tips can be found in Chapter 1 and 2.

What are the main hardware features of my new computer?

More information can be found in Chapter 1 and 2.

Where can I find the detailed specifications for my computer?

See <http://consumersupport.lenovo.com>.

I need to upgrade a device *or* I need to replace one of the following: the hard disk drive, memory, or the keyboard.

See "Appendix D. Customer Replaceable Units (CRUs)" on page 106 of this guide.

Chapter 6. Troubleshooting

My computer is not operating properly.

Study the relevant information in Chapter 2.

Where are the recovery discs?

Your computer did not come with a recovery disc. For an explanation of the alternative recovery methods offered by Lenovo, see “Chapter 5. OneKey Rescue System” on page 50.

How can I contact the Customer Support Center?

See “Appendix A. Getting Help and Service” on page 73 of this Guide.

Where can I find warranty information?

For the warranty applicable to your computer, including the warranty period and type of warranty service, see “Appendix C. Lenovo Limited Warranty” on page 93.

How can I install the device drivers?

A compatible device driver is a requirement to ensure correct operation and performance of each component in your computer. If your computer is pre-installed with an operating system, Lenovo provides all drivers that you need in your hard disk.

Chapter 6. Troubleshooting

■ ■ Troubleshooting

If you do not find your problem here, see Chapter 2. The following section only describes problems that might prevent you from accessing the comprehensive information in Chapter 2.

Display problems

When I turn on the computer, nothing appears on the screen.

- If the screen is blank, make sure that:
 - The battery is installed correctly.
 - The AC adapter is connected to the computer and the power cord is plugged into a working electrical outlet.
 - The computer power is on. (Press the **power** button again for confirmation.)
 - The memory is installed correctly.
- If these items are properly set, and the screen remains blank, have the computer serviced.

When I turn on the computer, only a white cursor appears on a blank screen.

- Restore backed-up files to your Windows environment or the entire contents of your hard disk to the original factory contents using OneKey Recovery. If you still see only the cursor on the screen, have the computer serviced.

Chapter 6. Troubleshooting

My screen goes blank while the computer is on.

- Your screen saver or power management may be enabled. Do one of the following to exit from the screen saver or to resume from standby or hibernation mode:
 - Touch the touch pad.
 - Press any key on the keyboard.
 - Press the **power** button.

Note: If you are using an external monitor, see "Computer screen problems" on page 37.

A Password problem

I forgot my password.

- If you forgot your user password, you must take your computer to a Lenovo authorized servicer or a marketing representative to have the password canceled.
- If you forgot your HDD password, a Lenovo authorized servicer cannot reset your password or recover data from the hard disk. You must take your computer to a Lenovo authorized servicer or a marketing representative to have the hard disk drive replaced. Proof of purchase is required, and a fee will be charged for parts and service.
- If you forget your supervisor password, a Lenovo authorized servicer cannot reset your password. You must take your computer to a Lenovo authorized servicer or a marketing representative to have the system board replaced. Proof of purchase is required, and a fee will be charged for parts and service.

Chapter 6. Troubleshooting

Keyboard problems

A number appears when you enter a letter.

- The numeric lock function is on. To disable it, press **Fn + Insert**.

All or some of the keys on the external numeric keypad do not work.

- Make sure that the external numeric keypad is correctly connected to the computer.

Standby or hibernation problems

The computer enters standby mode unexpectedly.

- If the processor overheats, the computer automatically enters standby mode to allow the computer to cool and to protect the processor and other internal components. Check the settings for standby mode.

The computer enters standby mode immediately after Power-on self-test (POST).

- Make sure that:
 - The battery is charged.
 - The operating temperature is within the acceptable range. See "Appendix B. Use, and Care Information" on page 80.

Note: If the battery is charged and the temperature is within range, have the computer serviced.

The critical low-battery error message appears, and the computer immediately turns off.

- The battery power is getting low. Connect the AC adapter to the computer, or replace the battery with a fully charged one.

Chapter 6. Troubleshooting

The computer does not return from standby mode and the computer does not work.

- If the computer does not return from standby mode, it may have entered hibernation mode automatically because the battery is depleted. Check the standby indicator.
- If your computer is in standby mode connect the AC adapter to the computer, then press any key or the **power** button.
- If your computer is in hibernation mode or power-off state. Connect the AC adapter to the computer, then press the **power** button to resume operation.

Note: If the system still does not return from standby mode, your system has stopped responding, and you cannot turn off the computer; reset the computer. Unsaved data may be lost. To reset the computer, press and hold the **power** button for 4 seconds or more. If the computer is still not reset, remove the AC adapter and the battery.

Chapter 6. Troubleshooting

Computer screen problems

The screen is blank.

- Do the following:
 - If you are using the AC adapter, or using the battery, and the battery status indicator is on, press **Fn + up arrow** to make the screen brighter.
 - If the Power indicator is in blinking, press the **power** button to resume from the standby mode.
 - If the problem persists, follow the Solution in the following problem "The screen is unreadable or distorted."
- Make sure that:
 - The display device driver is installed correctly.
 - The screen resolution and color quality are correctly set.
 - The monitor type is correct.

Incorrect characters appear on the screen.

- Did you install the operating system or application program correctly? If they are installed and configured correctly, have the computer serviced.

A message, "Unable to create overlay window," appears when you try to start DVD playback.

-or-
You get poor or no playback of video, DVD or game applications.

- Do either of the following:
 - If you are using 32-bit color mode, change the color depth to 16-bit mode.
 - If you are using a desktop resolution over the optimum, reduce the desktop size and the color depth.

Chapter 6. Troubleshooting

Sound problems

No sound can be heard from the speaker even when the volume is turned up.

- Make sure that:
 - The Mute function is off.
 - The headphone jack is not used.
 - Speakers is selected as a playback device.

Battery problems

Your computer shuts down before the battery status indicator shows empty.

-or-

Your computer operates after the battery status indicator shows empty.

The operating time for a fully charged battery is short.

The computer does not operate with a fully charged battery.

The battery does not charge.

- Discharge and recharge the battery.
- For details, see "Handling the battery" in Chapter 2.
- The surge protector in the battery might be active. Turn off the computer for one minute to reset the protector; then turn on the computer again.
- For details, see "Handling the battery" in Chapter 2.

A hard disk drive problem

The hard disk drive does not work.

- In the **Boot** menu in **BIOS Setup Utility**, make sure that the hard disk drive is included in the **Boot priority order** correctly.

Chapter 6. Troubleshooting

A startup problem

The Microsoft® Windows operating system does not start.

- Use the OneKey Recovery to help solve or identify your problem. For details about OneKey Recovery, see "Chapter 5. OneKey Rescue System" on page 50.

Other problems

Your computer does not respond.

- To turn off your computer, press and hold the **power** button for 4 seconds or more. If the computer still does not respond, remove the AC adapter and the battery.
- Your computer might lock when it enters standby mode during a communication operation. Disable the standby timer when you are working on the network.

The computer does not start from a device you want.

- See the **Boot** menu of the **BIOS Setup Utility**. Make sure that the **Boot priority order** in the **BIOS Setup Utility** is set so that the computer starts from the device you want.
- Also make sure that the device from which the computer starts is enabled. In the **Boot** menu in the **BIOS Setup Utility**, make sure that the device is included in the **Boot priority order** list.

The connected external device does not work.

- Do not connect or disconnect any external device cables other than USB while the computer power is on; otherwise, you might damage your computer.
- When using a high power consumption external devices such as USB ODD, use external device power adapter. Otherwise, the device may not be recognized, or system shut down may result.

Appendix A. Getting Help and Service

If you need help, service, technical assistance, or just want more information about Lenovo computers, you will find a wide variety of sources available from Lenovo to assist you. This section contains information about where to go for additional information about Lenovo computers, what to do if you experience a problem with your computer, and whom to call for service should it be necessary.

Microsoft Service Packs are the latest software source for Windows product updates. They are available by means of a Web download (connection charges may apply) or from a disc. For more specific information and links, go to the Microsoft Web site at <http://www.microsoft.com>. Lenovo offers Up and Running technical assistance with installation of, or questions related to, Service Packs for your Lenovo-preinstalled Microsoft Windows product.

Appendix A. Getting Help and Service

■ ■ Getting help on the Web

The Lenovo Web site on the World Wide Web has up-to-date information about Lenovo computers and support. The address for the Lenovo home page is <http://consumersupport.lenovo.com>.

You can find support information for your Lenovo IdeaPad™ computer at <http://consumersupport.lenovo.com>. Research this Web site to learn how to solve problems, find new ways to use your computer, and learn about options that can make working with your Lenovo computer even easier.

■ ■ Calling the customer support center

If you have tried to correct the problem yourself and still need help, during the warranty period, you can get help and information by telephone through the Customer Support Center. The following services are available during the warranty period:

- Problem determination - Trained personnel are available to assist you with determining if you have a hardware problem and deciding what action is necessary to fix the problem.
- Lenovo hardware repair - If the problem is determined to be caused by Lenovo hardware under warranty, trained service personnel are available to provide the applicable level of service.

Appendix A. Getting Help and Service

- Engineering change management - Occasionally, there might be changes that are required after a product has been sold. Lenovo or your reseller, if authorized by Lenovo, will make selected Engineering Changes (ECs) available that apply to your hardware.

The following items are not covered:

- Replacement or use of parts not manufactured for or by Lenovo or non warranted parts
- Identification of software problem sources
- Configuration of BIOS as part of an installation or upgrade
- Changes, modifications, or upgrades to device drivers
- Installation and maintenance of network operating systems (NOS)
- Installation and maintenance of application programs

To determine if your Lenovo hardware product is under warranty and when the warranty expires, go to <http://consumersupport.lenovo.com>, and click **Warranty**, then follow the instructions on the screen.

Refer to your Lenovo hardware warranty for a full explanation of Lenovo warranty terms. Be sure to retain your proof of purchase to obtain warranty service.

Appendix A. Getting Help and Service

If possible, be near your computer when you make your call in case the technical assistance representative needs to help you resolve a computer problem. Please ensure that you have downloaded the most current drivers and system updates, and recorded information before you call. When calling for technical assistance, please have the following information available:

- Machine Type and Model
- Serial numbers of your computer, monitor, and other components, or your proof of purchase
- Description of the problem
- Hardware and software configuration information for your system
- The telephone numbers for your Customer Support Center location are located in “Appendix A. Getting Help and Service” on page 73.

Note: Telephone numbers are subject to change without notice. For the latest list of Customer Support Center telephone numbers and hours of operation, visit the Support Web site at <http://consumersupport.lenovo.com>. If the number for your country or region is not listed, contact your Lenovo reseller or Lenovo marketing representative.

Appendix A. Getting Help and Service

■ ■ Getting help around the world

If you travel with your computer or relocate it to a country where your Lenovo machine type is sold, your computer might be eligible for International Warranty Service, which automatically entitles you to obtain warranty service throughout the warranty period. Service will be performed by service providers authorized to perform warranty service.

Service methods and procedures vary by country, and some services might not be available in all countries. Service centers in certain countries might not be able to service all models of a particular machine type. In some countries, fees and restrictions might apply at the time of service.

To determine whether your computer is eligible for International Warranty Service and to view a list of the countries where service is available, go to <http://consumersupport.lenovo.com>, click **Warranty**, and follow the instructions on the screen.

Appendix A. Getting Help and Service

■ ■ Lenovo warranty service telephone numbers

Warranty Service Telephone Numbers

The phone numbers provided below are correct as of the time of printing and are subject to change without notice. For the latest warranty service contact telephone number in a country please contact Lenovo, or your reseller in your country.

Singapore	800 6012 047
Malaysia	1800 18 2388
Thailand	1800 06 0087
Indonesia	001 803 0601 2003
Philippines	1800 111 00724
Vietnam	1800 1528
India Toll free	1800 113324
Alternate No.	011-26388288
SMS	9900173324
P.R.China	400-810-8888
Hong Kong	(852) 2516-3919
Taiwan	(886) 0800-000-702
Macau	0800-689
United States	1-877-453-6686

Appendix A. Getting Help and Service

Canada	1-877-453-6686
Mexico	1-800-92536686
France	0826-536-686
South Africa	0861-536-686
Australia	1300 557 073
New Zealand	0800 446 833
Russia Toll free	8-800-700-7888
Alternate No.	+7-(495) 662-7888
Ukraine	+38 044 458-38-70
the Republic of Kazakhstan	+7 (727) 2971150 +7 (727) 2971160
Poland	0800-702-062
Turkey	Refer to http://consumersupport.lenovo.com/tr

Additionally, you can find support information, and updates, including service phone numbers for unlisted countries on the Lenovo Web site located at: <http://consumersupport.lenovo.com>.

Appendix B. Use, and Care Information

■ Caring your computer

Though your computer is designed to function reliably in normal work environments, you need to use common sense in handling it. By following these important tips, you will get the most use and enjoyment out of your computer.

■ Be careful about where and how you work.

- Do not eat or smoke over your keyboard. Particles that fall into your keyboard can cause damage.
- Store packing materials safely out of the reach of children to prevent the risk of suffocation from plastic bags.
- Keep your computer away from magnets, activated cellular phones, electrical appliances, or speakers (within 13 cm or 5 in).
- Avoid subjecting your computer to extreme temperatures (below 5°C / 41°F or above 35°C / 95°F).
- Some appliances, such as certain portable desktop fans or air purifiers, can produce negative ions. If a computer is close to such an appliance, and is exposed for an extended time to air containing negative ions, it may become electrostatically charged. Such a charge may be discharged through your hands when you touch the keyboard or other parts of the computer, or through connectors on I/O devices connected to it. Even though this kind of electrostatic discharge (ESD) is the opposite of a

Appendix B. Use, and Care Information

discharge from your body or clothing to the computer, it poses the same risk of a computer malfunction.

Your computer is designed and manufactured to minimize any effects of electrostatic charge. An electrostatic charge above a certain limit, however, can increase the risk of ESD. Therefore, when using the computer close to an appliance that can produce negative ions, give special attention to the following:

- Avoid directly exposing your computer to the air from an appliance that can produce negative ions.
- Keep your computer and peripherals as far as possible from such an appliance.
- Wherever possible, ground your computer to facilitate safe electrostatic discharge.

■ Notice of static-electricity

When you handle options or CRUs, or perform any work inside the computer, take the following precautions to avoid static-electricity damage:

- Limit your movement. Movement can cause static electricity to build up around you.
- Always handle components carefully. Handle adapters, memory modules, and other circuit boards by the edges. Never touch exposed circuitry.
- Prevent others from touching components.

Appendix B. Use, and Care Information

- When you install a static-sensitive option or CRU, touch the static-protective package containing the part to a metal expansion-slot cover or other unpainted metal surface on the computer for at least two seconds. This reduces static electricity in the package and your body.
- Whenever possible, remove the static-sensitive part from the static-protective packaging and install the part without setting it down. When this is not possible, place the static-protective packaging on a smooth, level surface and place the part on it.
- Do not place the part on the computer cover or other metal surface.

■ Be gentle with your computer

- Avoid placing any objects (including paper) between the display and the keyboard or under the keyboard.
- Do not drop, bump, scratch, twist, hit, vibrate, push, or place heavy objects on your computer, display, or external devices.
- Avoid turning the display beyond 135°.

■ Carry your computer properly

- Before moving your computer, be sure to remove any media, turn off attached devices, and disconnect cords and cables.
- Be sure your computer is in standby or hibernation mode, or turned off, before moving it. This will prevent damage to the hard disk drive and data loss.

Appendix B. Use, and Care Information

- When picking up your open computer, hold it by the bottom. Do not pick up or hold your computer by the display.
- Use a quality carrying case that provides adequate cushion and protection. Do not pack your computer in a tightly packed suitcase or bag.

■ For outdoor use

- Backup your critical data before you take your computer outdoors.
- Ensure that the battery is full.
- Be sure to turn off the power and close the LCD well.
- When you leave the computer in your car, place it on the back seat to avoid being insulated.
- Carry the AC adapter and power cord with the computer.

■ Handle storage media and drives properly

- If your computer comes with an optical drive, do not touch the surface of a disc or the lens on the tray.
- Wait until you hear the CD or DVD click into the center pivot of an optical drive before closing the tray.
- When installing your hard disk, follow the instructions shipped with your hardware, and apply pressure only where needed on the device.

Appendix B. Use, and Care Information

■ Data safety

- Do not delete unknown files or change the name of files or directories that were not created by you; otherwise, your computer software might fail to work.
- Be aware that accessing network resources can leave your computer vulnerable to computer viruses, hackers, spyware, and other malicious activities that might damage your computer, software, or data.
- It is your responsibility to ensure that you have adequate protection in the form of firewalls, antivirus software, and anti-spyware software and keep this software up to date.

■ Take care in setting passwords

- Remember your passwords. If you forget a supervisor or hard disk password, Lenovo authorized service providers will not reset it, and you might have to replace your system board or hard disk drive.

■ Other important tips

- Do not put the battery pack in trash that is disposed of in landfills. When disposing of the battery, comply with local ordinances or regulations and your company's safety standards.
- Your computer might have both an Ethernet connector and a modem connector. If so, be sure to connect your communication cable to the correct one, so your connector is not damaged.

Appendix B. Use, and Care Information

- Register your Lenovo products with Lenovo (refer to the Web page: <http://consumersupport.lenovo.com>). This can help authorities return your computer to you if it is lost or stolen. Registering your computer also enables Lenovo to notify you about possible technical information and upgrades.
- Only an authorized Lenovo repair technician should disassemble and repair your computer.
- Do not modify or tape the latches to keep the display open or closed.
- Take care not to turn your computer over while the AC adapter is plugged in. This could break the adapter plug.
- Turn off your computer if you are replacing a device, or else verify that the device is warm- or hot-swappable.
- Before you install any of the following devices, touch a metal table or a grounded metal object. This action reduces any static electricity from your body. The static electricity could damage the device.
 - ExpressCard
 - Memory Card, such as SD Card, Memory Stick, MultiMediaCard, xD-Picture Card, and Memory Stick Pro card.
 - Memory module
- When transferring data to or from a Flash Media Card, such as an SD card, do not put your computer in standby or hibernation mode before the data transfer is complete. To do so might cause damage to your data.

Appendix B. Use, and Care Information

■ ■ Accessibility and comfort

■ Ergonomic information

Working in the virtual office may mean adapting to frequent changes in your environment. Following some simple rules will make things easier and bring you the maximum benefits of your computer. Keeping in mind such basics as good lighting and proper seating, for example, can help you improve your performance and achieve greater comfort.

Note: This example shows someone in a conventional setting. Even if you work in a casual, less conventional setting, many of the tips in this section still apply. Develop good habits, and they will serve you well.



Appendix B. Use, and Care Information

■ What if you are traveling?

It may not be possible to observe the best ergonomic practices when you are using your computer while on the move or in a casual setting. Regardless of the setting, try to observe as many of the tips as possible. Sitting properly and using adequate lighting, for example, will help you maintain desirable levels of comfort and performance.

■ Questions about vision?

Your computer's visual display screen is designed to meet the highest standards and to provide you with clear, crisp images and large, bright displays that are easy to see, yet easy on the eyes. Of course, any concentrated and sustained visual activity can be tiring. If you have questions on eye fatigue or visual discomfort, consult a vision care specialist for advice.

Appendix B. Use, and Care Information

■ Maintenance

An important part of owning your computer is maintenance. With proper care, you can avoid common problems. The following sections provide information that can help you to keep your computer running smoothly.

■ General tips for maintenance

- ❶ Check the capacity of your hard disk drive from time to time. If the hard disk drive gets too full, Windows® will slow down and might produce errors.
 - ❷ Empty your recycle bin on a regular basis.
 - ❸ Use Diskkeeper Lite or the Microsoft Disk Defragmenter on your hard disk drive on a regular basis to improve data seek and read time.
- To free up disk space, uninstall unused application programs.
 - Clean out your Inbox, Sent, and Trash folders from your e-mail client program.
 - At least once a week, make a point to back up your data. If critical data is present, it is a good idea to perform a daily backup. Lenovo has many backup options available for your computer. CD-RW drives and CD-RW/DVD drives are available for most computers and are easily installed.
 - Use or schedule System Restore to take a system snapshot periodically

Appendix B. Use, and Care Information

Note: Always take a system snapshot before installing new drivers, updating software, or installing new software.

- Update device drivers and BIOS when needed.
- Profile your machine at <http://consumersupport.lenovo.com> to keep up to date with current drivers and revisions.
- Keep up to date on device drivers on other non-Lenovo hardware. You might want to read the device driver information release notes prior to updating for compatibility or known issues.
- Keep a log book. Entries might include major hardware or software changes, driver updates, minor issues you have experienced and how you resolved them.
- If you ever need to run a recovery operation on your computer by Onekey Rescue System, see “Chapter 5. OneKey Rescue System” on page 50.
- If required, you can find your country's Customer Support Center at the following Web address: <http://consumersupport.lenovo.com>. When calling the Customer Support Center, please make sure you have your machine type, model, and serial number available and the computer is in front of you. Also, if the machine is producing error codes, it is helpful to have the error screen on or the message written down.

Appendix B. Use, and Care Information

■ Cleaning the cover of your computer

Occasionally clean your computer as follows:

- ① Prepare a mixture of a gentle kitchen-use detergent (one that does not contain abrasive powder or strong chemicals such as acid or alkaline). Use 5 parts water to 1 part detergent.
- ② Absorb the diluted detergent into a sponge.
- ③ Squeeze excess liquid from the sponge.
- ④ Wipe the cover with the sponge, using a circular motion and taking care not to let any excess liquid drip.
- ⑤ Wipe the surface to remove the detergent.
- ⑥ Rinse the sponge with clean running water.
- ⑦ Wipe the cover with the clean sponge.
- ⑧ Wipe the surface again with a dry, soft lint-free cloth.
- ⑨ Wait for the surface to dry completely and remove any cloth fibers from the computer surface.

Note: Shut down the computer and then disconnect the power cord before cleaning the computer.

Appendix B. Use, and Care Information

■ Cleaning your computer keyboard

- ➊ Absorb some isopropyl rubbing alcohol on a soft, dust-free cloth.
- ➋ Wipe each keytop surface with the cloth. Wipe the keys one by one; if you wipe several keys at a time, the cloth may hook onto an adjacent key and possibly damage it. Make sure that no liquid drips onto or between the keys.
- ➌ Allow to dry.
- ➍ To remove any crumbs and dust from beneath the keys, you can use a camera blower with a brush or cool air from a hair drier.

Note: Avoid spraying cleaner directly on the display or the keyboard.

Appendix B. Use, and Care Information

■ Cleaning your computer display

- ① Gently wipe the display with a dry, soft lint-free cloth. If you see a scratchlike mark on your display, it might be a stain transferred from the keyboard when the cover was pressed from the outside.
- ② Wipe or dust the stain gently with a soft, dry cloth.
- ③ If the stain remains, moisten a soft, lint-free cloth with water or a 50-50 mixture of isopropyl alcohol and water that does not contain impurities.
- ④ Wring out as much of the liquid as you can.
- ⑤ Wipe the display again; do not let any liquid drip into the computer.
- ⑥ Be sure to dry the display before closing it.

Appendix C. Lenovo Limited Warranty

This Lenovo Limited Warranty applies only to Lenovo branded hardware products you purchased for your own use and not for resale.

This Lenovo Limited Warranty is available in other languages at www.lenovo.com/warranty.

■ What this warranty covers

Lenovo warrants that each hardware product that you purchase is free from defects in materials and workmanship under normal use during the warranty period. The warranty period for the product starts on the original date of purchase specified on your sales receipt or invoice unless Lenovo informs you otherwise in writing. The warranty period and type of warranty service that apply to your product are designated below under the section titled **“Warranty Information.”**

THIS WARRANTY IS YOUR EXCLUSIVE WARRANTY AND REPLACES ALL OTHER WARRANTIES OR CONDITIONS, EXPRESS OR IMPLIED, INCLUDING, BUT NOT LIMITED TO, THE IMPLIED WARRANTIES OR CONDITIONS OF MERCHANTABILITY AND FITNESS FOR A PARTICULAR PURPOSE. SOME STATES OR JURISDICTIONS DO NOT ALLOW THE EXCLUSION OF EXPRESS OR IMPLIED WARRANTIES, SO THE ABOVE EXCLUSION MAY NOT APPLY TO YOU. IN THAT EVENT, SUCH WARRANTIES APPLY ONLY TO THE EXTENT REQUIRED BY LAW AND ARE LIMITED IN DURATION TO THE WARRANTY PERIOD. NO WARRANTIES APPLY AFTER THAT PERIOD. SOME STATES OR JURISDICTIONS DO NOT ALLOW LIMITATIONS

Appendix C. Lenovo Limited Warranty

ON HOW LONG AN IMPLIED WARRANTY LASTS, SO THE ABOVE LIMITATION ON DURATION MAY NOT APPLY TO YOU.

■ How to obtain warranty service

If the product does not function as warranted during the warranty period, you may obtain warranty service by contacting Lenovo or an approved service provider. Each of them is referred to as a "Service Provider." A list of Service Providers and their telephone numbers is available at www.lenovo.com/support/phone.

Warranty service may not be available in all locations and may differ from location to location. Charges may apply outside a Service Provider's normal service area. Contact a local Service Provider for location-specific information.

■ What your service provider will do to correct problems

When you contact a Service Provider, you must follow the problem determination and resolution procedures specified.

Your Service Provider will attempt to diagnose and resolve your problem over the telephone, e-mail or through remote assistance. Your Service Provider may direct you to download and install designated software updates.

Appendix C. Lenovo Limited Warranty

Some problems can be resolved with a replacement part that you can install yourself called a "Customer Replaceable Unit" or "CRU." If so, your Service Provider will ship the CRU to you to install.

If your problem cannot be resolved over the telephone or remotely, through your application of software updates or the installation of a CRU by you, your Service Provider will arrange for service under the type of warranty service designated for the product under the section titled "**Warranty Information.**"

If your Service Provider determines that it is unable to repair your product, your Service Provider will replace it with one that is at least functionally equivalent.

If your Service Provider determines that it is unable to either repair or replace your product, your sole remedy is to return the product to your place of purchase or to Lenovo for a refund of your purchase price.

Appendix C. Lenovo Limited Warranty

■ Replacement of a product or part

When the warranty service involves the replacement of a product or part, the replaced product or part becomes Lenovo's property and the replacement product or part becomes your property. Only unaltered Lenovo products and parts are eligible for replacement. The replacement product or part provided by Lenovo may not be new, but it will be in good working order and at least functionally equivalent to the original product or part. The replacement product or part shall be warranted for the balance of the period remaining on the original product.

Before your Service Provider replaces a product or part, you agree to:

- 1 remove all features, parts, options, alterations, and attachments not under warranty service;
- 2 ensure that the product or part is free of any legal obligations or restrictions that prevent its replacement; and
- 3 obtain authorization from the owner to have your Service Provider service a product or part if you do not own it.

Appendix C. Lenovo Limited Warranty

■ Your additional responsibilities

Where applicable, before service is provided, you agree to:

- ① follow the service request procedures that your Service Provider specifies;
- ② backup or secure all programs and data contained in the product;
- ③ provide your Service Provider with all system keys or passwords and sufficient, free, and safe access to your facilities to perform service; and
- ④ ensure that all information about identified or identifiable individuals ("Personal Data") is deleted from the product or that, with respect to any Personal Data that you did not delete, you are in compliance with all applicable laws.

■ Use of personal information

If you obtain service under this warranty, Lenovo will store, use and process information about your warranty service and your contact information, including name, phone numbers, address, and e-mail address. Lenovo will use this information to perform service under this warranty and to improve our business relationship with you. We may contact you to inquire about your satisfaction regarding our warranty service or to notify you about any product recalls or safety issues. In accomplishing these purposes, we may transfer your information to any country where we do business and may provide it to entities acting on our behalf. We may also disclose it where required by law.

Appendix C. Lenovo Limited Warranty

■ What this warranty does not cover

This warranty does not cover the following:

- uninterrupted or error-free operation of a product;
- loss of, or damage to, your data;
- any software programs, whether provided with the product or installed subsequently;
- failure or damage resulting from misuse, accident, modification, unsuitable physical or operating environment, natural disasters, power surges, or improper maintenance by you;
- damage caused by a non-authorized service provider;
- failure of, or damage caused by, any third party products, including those that Lenovo may provide or integrate into the Lenovo product at your request; and
- any technical or other support, such as assistance with “how-to” questions and those regarding product set-up and installation.

This warranty is voided by removal or alteration of identification labels on the product or its parts.

Appendix C. Lenovo Limited Warranty

■ Limitation of liability

Lenovo is responsible for loss or damage to your product only while it is: 1) in your Service Provider's possession; or 2) in transit in those cases where the Service Provider is responsible for the transportation.

Neither Lenovo nor your Service Provider is responsible for any of your data including confidential, proprietary, or personal data contained in a product. You should remove and/or backup all such information from the product prior to its service or return.

Circumstances may arise where, because of a default on Lenovo's part or other liability, you may be entitled to recover damages from Lenovo. In each such instance, regardless of the basis of your claim against Lenovo (including breach, negligence, misrepresentation, or other contract or tort claim), except and to the extent that liability cannot be waived or limited by applicable laws, Lenovo shall not be liable for more than the amount of actual direct damages suffered by you, up to the amount you paid for the product. This limit does not apply to damages for bodily injury (including death) and damage to real property or tangible personal property for which Lenovo is liable under law.

This limit also applies to Lenovo's suppliers, resellers, and your Service Provider. It is the maximum amount for which Lenovo, its suppliers, resellers, and your Service Provider are collectively responsible.

Appendix C. Lenovo Limited Warranty

UNDER NO CIRCUMSTANCES SHALL LENOVO, ITS SUPPLIERS, RESELLERS, OR SERVICE PROVIDERS BE LIABLE FOR ANY OF THE FOLLOWING EVEN IF INFORMED OF THEIR POSSIBILITY: 1) THIRD PARTY CLAIMS AGAINST YOU FOR DAMAGES; 2) LOSS OR DAMAGE TO YOUR DATA; OR 3) SPECIAL, INCIDENTAL, INDIRECT OR CONSEQUENTIAL DAMAGES, INCLUDING LOST PROFITS, BUSINESS REVENUE, GOODWILL OR ANTICIPATED SAVINGS. AS SOME STATES OR JURISDICTIONS DO NOT ALLOW THE EXCLUSION OR LIMITATION OF INCIDENTAL OR CONSEQUENTIAL DAMAGES, THE ABOVE LIMITATION OR EXCLUSION MAY NOT APPLY TO YOU.

■ Dispute resolution

If you acquired the product in **Cambodia, Indonesia, Philippines, Vietnam or Sri Lanka**, disputes arising out of or in connection with this warranty shall be finally settled by arbitration held in Singapore and this warranty shall be governed, construed and enforced in accordance with the laws of Singapore, without regard to conflict of laws. If you acquired the product in **India**, disputes arising out of or in connection with this warranty shall be finally settled by arbitration held in Bangalore, India. Arbitration in Singapore shall be held in accordance with the Arbitration Rules of Singapore International Arbitration Center (“SIAC Rules”) then in effect. Arbitration in India shall be held in accordance with the laws of India then in effect. The arbitration award shall be final and binding on the parties without appeal. Any award shall be in writing and set forth the findings of fact and the conclusions of law. All

Appendix C. Lenovo Limited Warranty

arbitration proceedings, including all documents presented in such proceedings, shall be conducted in the English language, and the English language version of this warranty prevails over any other language version in such proceedings.

■ Other rights

THIS WARRANTY GIVES YOU SPECIFIC LEGAL RIGHTS AND YOU MAY HAVE OTHER RIGHTS WHICH VARY FROM STATE TO STATE OR JURISDICTION TO JURISDICTION. YOU MAY ALSO HAVE OTHER RIGHTS UNDER APPLICABLE LAW OR WRITTEN AGREEMENT WITH LENOVO. NOTHING IN THIS WARRANTY AFFECTS STATUTORY RIGHTS, INCLUDING RIGHTS OF CONSUMERS UNDER NATIONAL LEGISLATION GOVERNING THE SALE OF CONSUMER GOODS THAT CANNOT BE WAIVED OR LIMITED BY CONTRACT.

■ European Economic Area (EEA)

Customers in the EEA may contact Lenovo at the following address: EMEA Service Organisation, Lenovo (International) B.V., Floor 2, Einsteinova 21, 851 01, Bratislava, Slovakia. Service under this warranty for Lenovo hardware products purchased in EEA countries may be obtained in any EEA country in which the product has been announced and made available by Lenovo.

Appendix C. Lenovo Limited Warranty

■ ■ Warranty information

Product or Machine Type	Country or Region of Purchase	Warranty Period	Type of Warranty Service
Notebook: 20027, 2957	Taiwan	Parts and Labor - 1 year Battery pack - 1 year	3, 4
	India, China (Hong Kong S.A.R.), China (Macau S.A.R.)		1, 4
	United States of America, Canada		1, 3
	Indonesia, Malaysia, Singapore, Thailand, Philippines, Vietnam, South Africa, Australia, New Zealand, France, Mexico		1, 3 or 4
	Russia, Ukraine, the Republic of Kazakhstan		4
	Poland, Turkey		1, 3 or 4

Appendix C. Lenovo Limited Warranty

If required, your Service Provider will provide repair or exchange service depending on the type of warranty service specified for your product and the available service. Scheduling of service will depend upon the time of your call, parts availability, and other factors.

A warranty period of three (3) years on parts and one (1) year on labor means that Lenovo will provide warranty service without charge for:

- a. parts and labor during the first year of the warranty period (or a longer period as required by law); and
- b. parts only, on an exchange basis, in the second and third years of the warranty period. Your Service Provider will charge you for any labor provided in performance of the repair or replacement in the second and third years of the warranty period.

■ Types of warranty service

① Customer Replaceable Unit (“CRU”) Service

Under CRU Service, your Service Provider will ship CRUs to you for installation by you. CRU information and replacement instructions are shipped with your product and are available from Lenovo at any time upon request. CRUs that are easily installed by you are called Self-service CRUs, while Optional-service CRUs may require some technical skill and tools. Installation of Self-service CRUs is your responsibility. You may request that a Service Provider install Optional-service CRUs under one of the other types of warranty service designated for your product. An optional service offering may be available for purchase from Lenovo to

Appendix C. Lenovo Limited Warranty

have Lenovo install Self-service CRUs for you. You may find a list of CRUs and their designation in the publication that ships with your product or at www.lenovo.com/CRUs. The requirement to return a defective CRU, if any, will be specified in the materials shipped with a replacement CRU. When return is required: 1) return instructions, a prepaid return shipping label, and a container will be included with the replacement CRU; and 2) you may be charged for the replacement CRU if your Service Provider does not receive the defective CRU within thirty (30) days of your receipt of the replacement.

2 On-site Service

Under On-Site Service, your Service Provider will either repair or exchange the product at your location. You must provide a suitable working area to allow disassembly and reassembly of the Lenovo product. For some products, certain repairs may require your Service Provider to send the product to a designated service center.

3 Courier or Depot Service

Under Courier or Depot Service, your product will be repaired or exchanged at a designated service center, with shipping arranged by your Service Provider. You are responsible for disconnecting the product. A shipping container will be provided to you for you to return your product to a designated service center. A courier will pick up your product and deliver it to the designated service center. Following its repair or exchange, the service center will arrange the return delivery of the product to you.

Appendix C. Lenovo Limited Warranty

4 Customer Carry-In or Mail-In Service

Under Customer Carry-In or Mail-In Service, your product will be repaired or exchanged at a designated service center, with delivery or shipping arranged by you. You are responsible to deliver or mail, as your Service Provider specifies, (prepaid by you unless specified otherwise) the product, suitably packaged to a designated location. After the product has been repaired or exchanged, it will be made available for your collection. Failure to collect the product may result in your Service Provider disposing of the product as it sees fit. For Mail-in Service, the product will be returned to you at Lenovo's expense, unless your Service Provider specifies otherwise.

5 Product Exchange Service

Under Product Exchange Service, Lenovo will ship a replacement product to your location. You are responsible for its installation and verification of its operation. The replacement product becomes your property in exchange for the failed product, which becomes the property of Lenovo. You must pack the failed product in the shipping carton used to ship the replacement product and return it to Lenovo. Transportation charges, both ways, are paid by Lenovo. Failure to use the carton in which the replacement product was received may result in your responsibility for damage to the failed product during shipment. You may be charged for the replacement product if Lenovo does not receive the failed product within thirty (30) days of your receipt of the replacement product.

Appendix D. Customer Replaceable Units (CRUs)

Customer Replaceable Units (CRUs) are computer parts that can be upgraded or replaced by the customer. There are two types of CRUs: *internal* and *external*. External CRUs are easy to install, whereas internal CRUs require some technical skills and in some cases might require tools such as a screwdriver. However, both internal and external CRUs are safe for removal by the customer.

Customers are responsible for replacing all external CRUs. Internal CRUs can be removed and installed by customers or by a Lenovo service technician during the warranty period.

Your computer contains the following types of external CRUs:

- **External CRUs (pluggable):** These CRUs unplug from the computer. Examples of these types of CRUs include the AC adapter and power cord.
- **External CRUs with latches:** These CRUs include a latch to help you remove and replace the part. Examples of these types of CRUs include the notebook main battery, an optical drive, a hard-disk drive, and an extended battery.

Appendix D. Customer Replaceable Units (CRUs)

Your computer contains the following types of internal CRUs:

- **Internal CRUs (located behind an access panel):** These CRUs are isolated parts within the computer that are concealed by an access panel that is typically secured by either one or two screws. Once the access panel is removed, only the specific CRU is visible. Examples of these types of CRUs include memory modules and hard disk drives.
- **Internal CRUs (located within the product):** These CRUs are accessible only by opening the computer's outer case. Examples of these CRUs include PCI Express Mini Cards and the integrated keyboard.

Appendix E. Notices

■ ■ Notices

Lenovo may not offer the products, services, or features discussed in this document in all countries. Consult your local Lenovo representative for information on the products and services currently available in your area. Any reference to a Lenovo product, program, or service is not intended to state or imply that only that Lenovo product, program, or service may be used. Any functionally equivalent product, program, or service that does not infringe any Lenovo intellectual property right may be used instead. However, it is the user's responsibility to evaluate and verify the operation of any other product, program, or service.

Lenovo may have patents or pending patent applications covering subject matter described in this document. The furnishing of this document does not give you any license to these patents. You can send license inquiries, in writing, to:

*Lenovo (United States), Inc.
1009 Think Place - Building One
Morrisville, NC 27560
U.S.A.
Attention: Lenovo Director of Licensing*

LENOVO PROVIDES THIS PUBLICATION "AS IS" WITHOUT WARRANTY OF ANY KIND, EITHER EXPRESS OR IMPLIED, INCLUDING, BUT NOT LIMITED TO, THE IMPLIED WARRANTIES OF NON-INFRINGEMENT, MERCHANTABILITY OR FITNESS FOR A PARTICULAR PURPOSE. Some jurisdictions do not allow disclaimer of

Appendix E. Notices

express or implied warranties in certain transactions, therefore, this statement may not apply to you.

This information could include technical inaccuracies or typographical errors. Changes are periodically made to the information herein; these changes will be incorporated in new editions of the publication. Lenovo may make improvements and/or changes in the product(s) and/or the program(s) described in this publication at any time without notice.

The products described in this document are not intended for use in implantation or other life support applications where malfunction may result in injury or death to persons. The information contained in this document does not affect or change Lenovo product specifications or warranties. Nothing in this document shall operate as an express or implied license or indemnity under the intellectual property rights of Lenovo or third parties. All information contained in this document was obtained in specific environments and is presented as an illustration. The result obtained in other operating environments may vary.

Lenovo may use or distribute any of the information you supply in any way it believes appropriate without incurring any obligation to you.

Any references in this publication to non-Lenovo Web sites are provided for convenience only and do not in any manner serve as an endorsement of those Web sites. The materials at those Web sites are not part of the materials for this Lenovo product, and use of those Web sites is at your own risk.

Any performance data contained herein was determined in a controlled environment. Therefore, the result obtained in other operating environments may vary significantly. Some measurements may have been

Appendix E. Notices

made on development-level systems and there is no guarantee that these measurements will be the same on generally available systems.

Furthermore, some measurements may have been estimated through extrapolation. Actual results may vary. Users of this document should verify the applicable data for their specific environment.

The software interface and hardware configuration described in all the manuals included with your computer may not match the actual configuration of the computer you purchased.

■ Export classification notice

This product is subject to the United States Export Administration Regulations (EAR) and has an Export Classification Control Number (ECCN) of 4A994.b. It can be re-exported except to any of the embargoed countries in the EAR E1 country list.

ENERGY STAR model information



ENERGY STAR[®] is a joint program of the U.S. Environmental Protection Agency and the U.S. Department of Energy aimed at saving money and protecting the environment through energy efficient products and practices.

Lenovo[®] is proud to offer our customers products with an ENERGY STAR compliant designation. Lenovo computers of the following machine types, if the ENERGY STAR mark is affixed, have been designed and tested to conform to the ENERGY STAR 4.0 program requirements for computers.

- 20027
- 2957

By using ENERGY STAR compliant products and taking advantage of the power-management features of your computer, you reduce the consumption of electricity. Reduced electrical consumption contributes to potential financial savings, a cleaner environment, and the reduction of greenhouse gas emissions.

For more information about ENERGY STAR, visit

<http://www.energystar.gov>.

Appendix E. Notices

Lenovo encourages you to make efficient use of energy an integral part of your day-to-day operations. To help in this endeavor, Lenovo has preset the following power-management features to take effect when your computer has been inactive for a specified duration:

Table 1. ENERGY STAR power-management features, by operating system

Windows XP

- Turn off monitor: After 10 minutes
- Turn off hard disks: After 30 minutes
- System standby: After 20 minutes
- System hibernates: After 2 hours

To awaken your computer from a System Standby mode, press any key on your keyboard. For more information about these settings, refer to your Windows Help and Support information system.

■ Wireless related information

■ Wireless interoperability

Wireless LAN PCI Express Mini Card is designed to be interoperable with any wireless LAN product that is based on Direct Sequence Spread Spectrum (DSSS), Complementary Code Keying (CCK), and/or Orthogonal Frequency Division Multiplexing (OFDM) radio technology, and is compliant to:

- The IEEE 802.11a/b/g/n Standard on Wireless LANs, as defined and approved by the Institute of Electrical and Electronics Engineers.
- The Wireless Fidelity (WiFi) certification as defined by the Wi-Fi Alliance.

Bluetooth Daughter Card is designed to be interoperable with any *Bluetooth* product that is compliant to *Bluetooth* Specification 2.0 + EDR as defined by the *Bluetooth* SIG. Following profiles are supported by *Bluetooth* Daughter Card:

- Generic Access
- Service Discovery
- Serial Port
- Dial-up Networking
- FAX
- LAN Access using PPP
- Personal Area Network

Appendix E. Notices

- Generic Object Exchange
- Generic Object Push
- File Transfer
- Synchronization
- Audio Gateway
- Headset
- Printer
- Human Interface Devices (Keyboard/Mouse)
- Basic Image
- Handsfree
- AV

■ Usage environment and your health

Wireless LAN PCI Express Mini Card and *Bluetooth* Daughter Card emit radio frequency electromagnetic energy like other radio devices. However, the level of energy emitted is far much less than the electromagnetic energy emitted by wireless devices like for example mobile phones.

Due to the fact that wireless LAN PCI Express Mini Card and *Bluetooth* Daughter Card operate within the guidelines found in radio frequency safety standards and recommendations, Lenovo believes the integrated wireless cards are safe for use by consumers. These standards and recommendations reflect the consensus of the scientific community and

Appendix E. Notices

result from deliberations of panels and committees of scientists who continually review and interpret the extensive research literature.

In some situation or environment, the use of wireless LAN PCI Express Mini Card or *Bluetooth* Daughter Card may be restricted by the proprietor of the building or responsible representatives of the organization. These situations may for example include:

- Using the integrated wireless cards on board of airplanes, or in hospitals
- In any other environment where the risk of interference to other devices or services is perceived or identified as harmful.

If you are uncertain of the policy that applies on the use of wireless devices in a specific organization (e.g., airport or hospital), you are encouraged to ask for authorization to use wireless LAN PCI Express Mini Card or *Bluetooth* Daughter Card prior to turning on the computer.

■ Safety information related to Mobile Broadband

- 1 Do not use the Mobile Broadband feature on your computer in highly flammable areas (e.g. gas station) or near blasting. Though it is rare, the Mobile Broadband module, like other cellular network devices, could generate a spark.
- 2 Avoid using Mobile Broadband feature outdoors during a thunderstorm.

Appendix E. Notices

- ③ Use of mobile devices on board aircraft is explicitly prohibited by many airlines companies, especially during take-off and landing. The built-in Mobile Broadband module on your computer is a low-power radio transceiver. When it is turned on, it intermittently receives and transmits radio frequency (RF) energy which could cause interference with the operation of the airplane communication or navigation system. Refer to rules or regulations of your airline company for Mobile Broadband use. Never enable Mobile Broadband feature on your computer unless you are explicitly permitted to do so.
- ④ Follow restrictions when using your computer in hospitals. Some equipments in hospitals are sophisticated and are susceptible to electromagnetic interference. Do not enable Mobile Broadband feature near medical equipment without requesting permission.
- ⑤ The Mobile Broadband communication may affect the operation of implanted cardiac pacemakers and other medically implanted equipment. Patients with cardiac pacemakers should be well aware that use of Mobile Broadband feature on this computer may cause the implanted device to malfunction. If patients have any doubt that there is interference taking place, immediately disable the wireless radio on the computer and contact the doctor for more information.
- ⑥ The Mobile Broadband module embedded in your computer does not support voice calls, hence their use for essential communications is not possible. Therefore you should never rely upon the device for essential communications.

Appendix E. Notices

■ ■ Electronic emissions notices

The following information refers to Lenovo IdeaPad S10-2, machine type 20027 2957.

■ Federal Communications Commission (FCC) Statement

This equipment has been tested and found to comply with the limits for a Class B digital device, pursuant to Part 15 of the FCC Rules. These limits are designed to provide reasonable protection against harmful interference in a residential installation. This equipment generates, uses, and can radiate radio frequency energy and, if not installed and used in accordance with the instructions, may cause harmful interference to radio communications. However, there is no guarantee the interference will not occur in a particular installation. If this equipment does cause harmful interference to radio or television reception, which can be determined by turning the equipment off and on, the user is encouraged to try to correct the interference by one or more of the following measures:

- Reorient or relocate the receiving antenna.
- Increase the separation between the equipment and receiver.
- Connect the equipment into an outlet on a circuit different from that to which the receiver is connected.
- Consult an authorized dealer or service representative for help.

Properly shielded and grounded cables and connectors must be used in order to meet FCC emission limits. Proper cables and connectors are

Appendix E. Notices

available from Lenovo authorized dealers. Lenovo is not responsible for any radio or television interference caused by using other than recommended cables or connectors or by unauthorized changes or modifications to this equipment. Unauthorized changes or modifications could void the user's authority to operate the equipment.

This device complies with Part 15 of the FCC Rules. Operation is subject to the following two conditions: (1) this device may not cause harmful interference, and (2) this device must accept any interference received, including interference that may cause undesired operation.

Responsible party:

Lenovo (United States) Incorporated
1009 Think Place - Building One
Morrisville, NC 27650
U.S.A.
Telephone: (919) 294-5900



■ Industry Canada Class B Emission Compliance Statement

This Class B digital apparatus complies with Canadian ICES-003.

Appendix E. Notices

■ Avis de conformité à la réglementation d'Industrie Canada

Cet appareil numérique de la classe B est conforme à la norme NMB-003 du Canada.

■ German Class B Compliance Statement

Deutschsprachiger EU Hinweis:

Hinweis für Geräte der Klasse B EU-Richtlinie zur Elektromagnetischen Verträglichkeit

Dieses Produkt entspricht den Schutzanforderungen der EU-Richtlinie 2004/108/EG (früher 89/336/EWG) zur Angleichung der Rechtsvorschriften über die elektromagnetische Verträglichkeit in den EU-Mitgliedsstaaten und hält die Grenzwerte der EN 55022 Klasse B ein.

Um dieses sicherzustellen, sind die Geräte wie in den Handbüchern beschrieben zu installieren und zu betreiben. Des Weiteren dürfen auch nur von der Lenovo empfohlene Kabel angeschlossen werden. Lenovo übernimmt keine Verantwortung für die Einhaltung der Schutzanforderungen, wenn das Produkt ohne Zustimmung der Lenovo verändert bzw. wenn Erweiterungskomponenten von Fremdherstellern ohne Empfehlung der Lenovo gesteckt/eingebaut werden.

Appendix E. Notices

Deutschland:

Einhaltung des Gesetzes über die elektromagnetische Verträglichkeit von Betriebsmitteln

Dieses Produkt entspricht dem "Gesetz über die elektromagnetische Verträglichkeit von Betriebsmitteln" EMVG (früher "Gesetz über die elektromagnetische Verträglichkeit von Geräten"). Dies ist die Umsetzung der EU-Richtlinie 2004/108/EG (früher 89/336/EWG) in der Bundesrepublik Deutschland.

Zulassungsbescheinigung laut dem Deutschen Gesetz über die elektromagnetische Verträglichkeit von Betriebsmitteln, EMVG vom 20. Juli 2007 (früher Gesetz über die elektromagnetische Verträglichkeit von Geräten), bzw. der EMV EG Richtlinie 2004/108/EC (früher 89/336/EWG), für Geräte der Klasse B.

Dieses Gerät ist berechtigt, in Übereinstimmung mit dem Deutschen EMVG das EG-Konformitätszeichen - CE - zu führen. Verantwortlich für die Konformitätserklärung nach Paragraf 5 des EMVG ist die Lenovo (Deutschland) GmbH, Gropiusplatz 10, D-70563 Stuttgart.

Informationen in Hinsicht EMVG Paragraf 4 Abs. (1) 4:

Das Gerät erfüllt die Schutzanforderungen nach EN 55024 und EN 55022 Klasse B.

Appendix E. Notices

■ European Union Compliance Statement Class B Compliance

European Union - Compliance to the Electromagnetic Compatibility Directive

This product is in conformity with the protection requirements of EU Council Directive 2004/108/EC on the approximation of the laws of the Member States relating to electromagnetic compatibility. Lenovo cannot accept responsibility for any failure to satisfy the protection requirements resulting from a non-recommended modification of the product, including the installation of option cards from other manufacturers.

This product has been tested and found to comply with the limits for Class B Information Technology Equipment according to European Standard EN 55022. The limits for Class B equipment were derived for typical residential environments to provide reasonable protection against interference with licensed communication devices.

Properly shielded and grounded cables and connectors must be used in order to reduce the potential for causing interference to radio and TV communications and to other electrical or electronic equipment. Such cables and connectors are available from Lenovo authorized dealers. Lenovo cannot accept responsibility for any interference caused by using other than recommended cables and connectors.

Appendix E. Notices

■ Japanese VCCI Class B Statement

この装置は、情報処理装置等電波障害自主規制協議会（VCCI）の基準に基づくクラスB情報技術装置です。この装置は、家庭環境で使用することを目的としていますが、この装置がラジオやテレビジョン受信機に近接して使用されると、受信障害を引き起こすことがあります。

取扱説明書に従って、正しい取り扱いをして下さい。

■ Japan Compliance Statement for Power line Harmonics

A statement of compliance to the IEC 61000-3-2 harmonics standard is required for all products connecting to the power mains and rated less than 20A per phase.

日本の定格電流が 20A/相 以下の機器に対する高調波電流規制

高調波電流規格 JIS C 61000-3-2 適合品

■ Korea Class B

이 기기는 가정용으로 전자파적합등록을 한 기기로서 주거 지역에서는 물론 모든 지역에서 사용할 수 있습니다.

Appendix E. Notices

■ WEEE and recycling statements

■ General recycling statement

Lenovo encourages owners of information technology (IT) equipment to responsibly recycle their equipment when it is no longer needed. Lenovo offers a variety of programs and services to assist equipment owners in recycling their IT products. Information on product recycling offerings can be found on Lenovo's Internet site at <http://www.pc.ibm.com/ww/lenovo/about/environment>

Appendix E. Notices

■ ■ EU WEEE Statements

The Waste Electrical and Electronic Equipment (WEEE) mark applies only to countries within the European Union (EU) and Norway. Appliances are labeled in accordance with European Directive 2002/96/EC concerning waste electrical and electronic equipment (WEEE). The Directive determines the framework for the return and recycling of used appliances as applicable throughout the European Union. This label is applied to various products to indicate that the product is not to be thrown away, but rather reclaimed upon end of life per this Directive.

Users of electrical and electronic equipment (EEE) with the WEEE marking per Annex IV of the WEEE Directive must not dispose of end of life EEE as unsorted municipal waste, but use the collection framework available to them for the return, recycle, recovery of WEEE and minimize any potential effects of EEE on the environment and human health due to the presence of hazardous substances. For additional WEEE information go to:

<http://consumersupport.lenovo.com>.

■ Japan Recycling Statements

■ Collecting and Recycling a Disused Lenovo Computer or Monitor

If you are a company employee and need to dispose of a Lenovo computer or monitor that is the property of the company, you must do so in accordance with the Law for Promotion of Effective Utilization of Resources. Computers and monitors are categorized as industrial waste and should be properly disposed of by an industrial waste disposal contractor certified by a local government. In accordance with the Law for Promotion of Effective Utilization of Resources, Lenovo Japan provides, through its PC Collecting and Recycling Services, for the collecting, reuse, and recycling of disused computers and monitors. For details, visit the Lenovo Web site at

www.ibm.com/jp/pc/service/recycle/pcrecycle

<http://www.ibm.com/jp/pc/service/recycle/pcrecycle>

Pursuant to the Law for Promotion of Effective Utilization of Resources, the collecting and recycling of home-used computers and monitors by the manufacturer was begun on October 1, 2003. This service is provided free of charge for home-used computers sold after October 1, 2003. For details, visit the Lenovo Web site at

www.ibm.com/jp/pc/service/recycle/personal

<http://www.ibm.com/jp/pc/service/recycle/personal>

Appendix E. Notices

■ Disposing of a Lenovo Computer Components

Some Lenovo computer products sold in Japan may have components that contain heavy metals or other environmental sensitive substances. To properly dispose of disused components, such as a printed circuit board or drive, use the methods described above for collecting and recycling a disused computer or monitor.

■ Disposing a Disused Battery Pack from Lenovo Notebook Computers

Your Lenovo notebook computer has a lithium ion battery pack or a nickel metal hydride battery pack. If you are a company employee who uses a Lenovo notebook computer and need to dispose of a battery pack, contact the proper person in Lenovo sales, service, or marketing, and follow that person's instructions. You also can refer to the instructions at

www.ibm.com/jp/pc/environment/recycle/battery

<http://www.ibm.com/jp/pc/environment/recycle/battery>

If you use a Lenovo notebook computer at home and need to dispose of a battery pack, you must comply with local ordinances and regulations. You also can refer to the instructions at

www.ibm.com/jp/pc/environment/recycle/battery

<http://www.ibm.com/jp/pc/environment/recycle/battery>

Appendix E. Notices

■ ■ Notice for Users in the U.S.A. —————

California Perchlorate Information:

Products containing CR (manganese dioxide) lithium coin cell batteries may contain perchlorate.

Perchlorate Material — special handling may apply.

See <http://www.dtsc.ca.gov/hazardouswaste/perchlorate>.

■ ■ Notice on deleting data from your hard disk —————

As computers spread into every corner of life, they process more and more information. The data on your computer, some of it sensitive, is stored on a storage device called the hard disk. Before you dispose of, sell, or hand over your computer, you need to delete that data.

Handing your computer over to someone else without deleting the loaded software, such as operating systems and application software, may even violate License Agreements. You are advised to check the terms and conditions of those Agreements.

Deleting the data from the hard disk is not easy.

There are methods that seem to delete the data:

- Move the data to the recycle bin, and then choose the Empty recycle bin command.
- Use the Delete command.

Appendix E. Notices

- Format your hard disk, using the software for initializing it.
- Using the preinstalled recovery program, bring the hard disk back to factory-ship state.

These operations, however, only change the file allocation of the data; they do not delete the data itself. In other words, the data retrieval processing is disabled under an operating system such as Windows. The data is still there, even though it seems to be lost. Thus, it is sometimes possible to read the data by use of special software for data recovery. There is a risk that people of bad faith may read and misuse the critical data on hard disks for unexpected purposes.

To prevent the leakage of data, it becomes very important that you take responsibility for deleting all the data from the hard disk when you dispose of, sell, or hand over your computer. You can destroy the data physically by smashing the hard disk with a hammer, or magnetically by means of strong magnetic power, thus making the data unreadable. But we recommend that you make use of the software (payware) or service (pay service) specifically developed for the purpose.

Appendix E. Notices

■ ■ Trademarks

Lenovo, lenovo logo, IdeaPad, VeriFace, OneKey Rescue (OneKey Recovery, OneKey AntiVirus), APS, Power Express, Energy Management and ReadyComm are either registered trademarks or trademarks of Lenovo in the United States and/or other countries.

Microsoft, Windows and Windows Vista are trademarks of Microsoft Corporation in the United States, other countries, or both.

Other company, product, or service names may be trademarks or service marks of others.

All other trademarks and registered trademarks are trademarks or registered trademarks of their respective holders. In this manual, TM and ® marks are not specified.

Appendix F. Features and Specifications

Model Name: IdeaPad S10-2

Machine Type 2957/20027

Note: Information of the specifications may contain technical inaccuracies or typographical errors. Lenovo reserved the right to improvements and/or changes at this specifications at any time without notice.

Form Factor

Size 258 x 183 x 18.0 ~ 23.0mm

Weight <1.1Kg

Planar

CPU	Intel Atom N270 (1.6GHz (2.5W) / FSB 533MHz / L2 512KB)/	Intel Atom N280 (1.66 GHz (2.5W) / FSB 667MHz / L2 512KB)
-----	--	---

Memory	DDR II 533 DIMM socket x 1	ma x 2 GB
--------	----------------------------	-----------

Sub System

LCD 10.1WXGA LED Backlight

HDD 2.5" SATA 160/250/360G (5400rpm)

Keyboard 6 row Lenovo Keyboard 6 row Lenovo Keyboard

Integrated Camera 1.3M 1.3M

Battery 2.2Ah, 3 cell Li-ion Battery

Appendix F. Features and Specifications

AC Adapter 40W / 20V 40W / 20V

I/O Ports

USB/E-SATA	USB 2.0 x 3 ports
Communication	RJ45
Audio	Headphone/Mic-In
Video	CRT
Express Card Slot	34mm width x 1
Media Slot	4 in 1 slot x 1 (MMC / SD / MS / MS PRO)
Kensington Lock	Yes

Index

A

AC adapter
Using 13

B

Battery
Charging 13
Bluetooth
Connecting 26
Interoperability 113
Usage environment 114

C

Camera 2
Card reader 25
Caring your computer 80
Cleaning
Computer cover 90
Computer display 92
Computer keyboard 91

Customer Replaceable Unit (CRU) parts
list 106
Customer support center 74

D

Display
Cleaning 92

F

FCC Statement 117
Frequently Asked Questions 64
Function key combinations 18

H

Hard disk drive
Problems 71
Help
Customer support center 74
Help and service 73
on the Web 74
Hibernation mode problems 68

K

Keyboard
 Cleaning 90
 Problems..... 68
 Using 17

L

Lenovo Limited Warranty 93

M

Maintenance 88
Microphone
 Built-in..... 2

N

network 42
Notice
 Electronic emissions 117
 for US users 127
Numeric Keypad..... 17

O

OneKey Rescue System button 2

P

Password
 Problems..... 67
 Using 23
Power button..... 2
Problems
 Battery 71
 Computer screen 70
 Display 66
 Hard disk drive 71
 Hibernation mode 68
 Keyboard 68
 Password 67
 Sound..... 71
 Standby mode 68
 Startup 72

Index

S

Security	22
Security keyhole	5
Storage media	
Handling	83

T

Touch pad	16
Trademarks	129
Troubleshooting	66

U

USB port	3
----------------	---

V

VeriFace	23
----------------	----

W

Warranty information	102
Web	
Help	74
Wireless LAN	
Antennas	2
Interoperability	113
Usage environment	114

FCC RF Radiation Exposure Statement:

1. This Transmitter must not be co-located or operating in conjunction with any other antenna or transmitter.
2. This equipment complies with FCC RF radiation exposure limits set forth for an uncontrolled environment. This device was tested for typical lap held operations with the device contacted directly to the human body to the backside of the notebook computer. To maintain compliance with FCC RF exposure compliance requirements, avoid direct contact to the transmitting antenna during transmitting.

Changes or modifications not expressly approved by the party responsible for compliance could void the user's authority to operate the equipment.

CE Declaration of Conformity

For the following equipment:

Is herewith confirmed to comply with the requirements set out in the Council Directive on the Approximation of the Laws of the Member States relating to Electromagnetic Compatibility (2004/108/EC), Low-voltage Directive (2006/95/EC), the procedures given in European Council Directive (1999/5/EC).

The equipment was passed. The test was performed according to the following European standards:

- EN 55022: 2006
- EN 61000-3-2: 2006
- EN 61000-3-3: 1995 + A1: 2001 +A2:2005
- EN 55024: 1998+A1:2001+A2:2003
- IEC 61000-4-2: 2001
- IEC 61000-4-3: 2006
- IEC 61000-4-4: 2004
- IEC 61000-4-5: 2005
- IEC 61000-4-6: 2003+A1: 2004+A2: 2006
- IEC 61000-4-8: 2001
- IEC 61000-4-11: 2004
- EN301489-1 V1.6.1:2005
- EN301489-17 V1.2.1:2002
- EN 60950-1 : 2001 + A11:2004
- EN62311: 2008
- EN 300 328 V1.7.1 : 2006

2.4G warning statement

European standards dictate maximum radiated transmit power of 100mW EIRP and frequency range

2.400-2.4835GHz

In France, the equipment must be restricted to the 2.4465-2.4835GHz frequency range and must be restricted to indoor use.

D=0.2m is the minimum distance between the EUT and human body to meet the E-field strength of 7.63 V/m.