



Product Service

---

**Choose certainty.  
Add value.**

# Report On

Specific Absorption Rate Testing of the  
F3507g Ericsson Mobile Broadband Module and  
Intel WiFi 5300 Module  
Installed in DELL Latitude E4200 Laptop Computer

FCC ID: VV7-MBMF3507G-D

Document 75903561 Report 18 Issue 1

September 2008



Product Service

TÜV Product Service Ltd, Octagon House, Concorde Way, Segensworth North,  
Fareham, Hampshire, United Kingdom, PO15 5RL  
Tel: +44 (0) 1489 558100. Website: [www.tuvps.co.uk](http://www.tuvps.co.uk)

**REPORT ON**

Specific Absorption Rate Testing of the  
F3507g Ericsson Mobile Broadband Module  
and Intel WiFi 5300 Module  
Installed in DELL Latitude E4200 Laptop Computer

Document 75903561 Report 18 Issue 1

September 2008

**PREPARED FOR**

Ericsson AB  
Lindholmospiren 11  
417 56 Goteborg  
Sweden

**PREPARED BY**

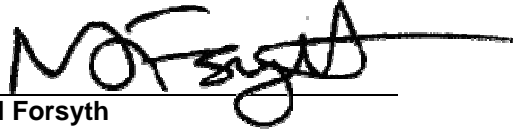
  
\_\_\_\_\_  
**N Forsyth**  
Test Engineer

**APPROVED BY**

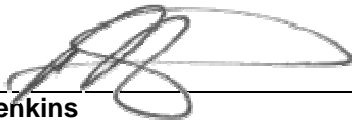
  
\_\_\_\_\_  
**M Jenkins**  
Authorised Signatory

**DATED**

\_\_\_\_\_  
03 September 2008



## CONTENTS

Section	Page No
<b>1</b>	<b>REPORT SUMMARY ..... 3</b>
1.1	Introduction ..... 4
1.2	Brief Summary of Results ..... 5
1.3	Test Results Summary ..... 5
1.4	Product Information ..... 11
1.5	RF Power Output – Conducted ..... 14
<b>2</b>	<b>TEST DETAILS ..... 16</b>
2.1	SAR Measurement System ..... 17
2.2	EUT Positioning Description ..... 22
2.3	GSM 850 Body SAR Test Results and Course Area Scans – 2D ..... 23
2.4	GSM 900 Body SAR Test Results and Course Area Scans – 2D ..... 31
2.5	GSM 1800 Body SAR Test Results and Course Area Scans – 2D ..... 38
2.6	GSM 1900 Body SAR Test Results and Course Area Scans – 2D ..... 45
2.7	WCDMA FDDI Body SAR Test Results and Course Area Scans – 2D ..... 52
2.8	WCDMA FDDII Body SAR Test Results and Course Area Scans – 2D ..... 60
2.9	WCDMA FDDV Body SAR Test Results and Course Area Scans – 2D ..... 68
2.10	WLAN 802.11b Body SAR Test Results and Course Area Scans – 2D ..... 76
2.11	WLAN 802.11g Body SAR Test Results and Course Area Scans – 2D ..... 95
2.12	WLAN 802.11a Body SAR Test Results and Course Area Scans – 2D ..... 98
<b>3</b>	<b>TEST EQUIPMENT USED ..... 116</b>
3.1	Test Equipment Used ..... 117
3.2	Test Software ..... 118
3.3	Dielectric Properties of Simulant Liquids ..... 119
3.4	Test Conditions ..... 120
3.5	Measurement Uncertainty ..... 121
<b>4</b>	<b>PHOTOGRAPHS ..... 122</b>
4.1	Test Positional Photographs ..... 123
4.2	Photographs of Equipment Under Test (EUT) ..... 125
<b>5</b>	<b>ACCREDITATION, DISCLAIMERS AND COPYRIGHT ..... 129</b>
5.1	Accreditation, Disclaimers and Copyright ..... 130
<b>ANNEX A</b>	<b>Probe Calibration Information ..... A.2</b>



Product Service

## **SECTION 1**

### **REPORT SUMMARY**

Specific Absorption Rate Testing of the  
F3507g Ericsson Mobile Broadband Module and Intel WiFi 5300 Module  
Installed in DELL Latitude E4200 Laptop Computer



## 1.1 INTRODUCTION

The information contained in this report is intended to show verification of the Specific Absorption Rate Testing of the F3507g Ericsson Mobile Broadband Module and Intel WiFi 5300 Module Installed in DELL Latitude E4200 Laptop Computer to the requirements of FCC OET Bulletin 65 (Edition 97-01), Evaluating Compliance with FCC Guidelines for Human Exposure to Radiofrequency Electromagnetic Fields for Body SAR assessment.

Objective	To perform Specific Absorption Rate Testing to determine the Equipment Under Test's (EUT's) compliance with the specification, for the series of tests carried out.
Applicant	Ericsson AB
Type of Product	Ericsson Mobile Broadband Module
Manufacturer	Ericsson AB
Model Number	F3507g
Power Class	GSM 850/900 MHz Class 4 DCS 1800/PCS 1900 MHz Class 1
GPRS Class	Class B
GPRS Multi-slot Class	10(4Dn; 2Up; Sum5)
WCDMA Frequency Band	FDD I FDD V
WCDMA Power Class	FDD I Class 3 (+24dBm) FDD V Class 3 (+24dBm)
IMEI Number(s)	004401700146653
Hardware Version	R1C026
Test Specification/Issue/Date	EN 50360: 2001
Type of Product	Intel WiFi Module
Manufacturer	Intel
Model Number	533AN_HMW
Power Output	802.11a +13.9dBm 802.11b +12.9 dBm 802.11g +13.8 dBm
Serial Number	0016EA03703A
Hardware Version	R1
Software Version	R1B
Test Specification/Issue/Date	FCC OET Bulletin 65 (Edition 97-01)
Start of Test	28 July 2008
Finish of Test	20 August 2008
Related Document(s)	Supplement C (Edition 01-01) FCC SAR Measurement Procedures for 802.11a/b/g transmitters document (May 2007) FCC SAR measurement requirements for 3-6GHz - Oct 2006 FCC SAR Measurement Procedures for 3G Devices FCC Interim SAR Procedures for Release 6 HSDPA Devices



## 1.2 BRIEF SUMMARY OF RESULTS

The measurements shown in this report were made in accordance with the procedures specified in Supplement C (Edition 01-01) to OET Bulletin 65 (Edition 97-01)

All reported testing was carried out on a sample of equipment to demonstrate compliance with the above standards. The sample tested was found to comply with the requirements in the applied rules.

### The maximum 1g volume averaged SAR found during this Assessment

Max 1g SAR (W/kg)	0.284
The maximum 1g volume averaged SAR level measured for all the tests performed did not exceed the limits for General Population/Uncontrolled Exposure (W/kg) Partial Body of 1.6 W/kg. level defined in Supplement C (Edition 01-01) to OET Bulletin 65 (97-01)	

## 1.3 TEST RESULTS SUMMARY

### 1.3.1 System Performance / Validation Check Results

Prior to formal testing being performed a System Check was performed in accordance with EN 62209-1:2006. The following results were obtained: -

#### System performance / Validation results

Date	Dipole Used	Frequency (MHz)	Max 1g SAR (W/kg)	Percentage Drift on Reference	Max 10g SAR (W/kg)	Percentage Drift on Reference
28/07/2008	900 MHz	907.5	10.72	-0.73%	6.90	0.68%
08/04/2008	1800 MHz	1812	37.58	-1.37%	19.80	1.15%
30/07/2008	1900 MHz	1883.6	40.82	7.14%	19.80	8.77%
14/08/2008	2450 MHz	2450	48.03	-8.35%	24.00	-6.70%

\*Normalised to a forward power of 1W



### 1.3.2 Results Summary Tables

GSM 850MHz BODY Specific Absorption Rate (Maximum SAR) 1g & 10g Results for the F3507g Ericsson Mobile Broadband Module in GPRS Mode.

Position		Channel Number	Frequency (MHz)	Max Spot SAR (W/kg)	Max 1g SAR (W/kg)	Max 10g SAR (W/kg)	SAR Drift (%)	Area scan (Figure number)
Spacing From Phantom	Laptop Position							
2mm	Screen 90°-Area 1	189	836.4	0.050	0.053	0.036	2.280	Figure12
Limit for General Population (Uncontrolled Exposure) 1.6 W/kg (1g) & 2.0 W/kg (10g)								

GSM 850MHz BODY Specific Absorption Rate (Maximum SAR) 1g & 10g Results for the F3507g Ericsson Mobile Broadband Module in EGPRS Mode.

Position		Channel Number	Frequency (MHz)	Max Spot SAR (W/kg)	Max 1g SAR (W/kg)	Max 10g SAR (W/kg)	SAR Drift (%)	Area scan (Figure number)
Spacing From Phantom	Laptop Position							
2mm	Screen 90°-Area 1	189	836.4	0.020	0.029	0.016	-1.930	Figure 13
Limit for General Population (Uncontrolled Exposure) 1.6 W/kg (1g) & 2.0 W/kg (10g)								

GSM 900MHz BODY Specific Absorption Rate (Maximum SAR) 1g & 10g Results for the F3507g Ericsson Mobile Broadband Module in GPRS Mode.

Position		Channel Number	Frequency (MHz)	Max Spot SAR (W/kg)	Max 1g SAR (W/kg)	Max 10g SAR (W/kg)	SAR Drift (%)	Area scan (Figure number)
Spacing From Phantom	Laptop Position							
2mm	Screen 90°-Area 1	37	897.4	0.050	0.062	0.043	0.630	Figure 14
Limit for General Population (Uncontrolled Exposure) 1.6 W/kg (1g) & 2.0 W/kg (10g)								

GSM 900MHz BODY Specific Absorption Rate (Maximum SAR) 1g & 10g Results for the F3507g Ericsson Mobile Broadband Module in EGPRS Mode.

Position		Channel Number	Frequency (MHz)	Max Spot SAR (W/kg)	Max 1g SAR (W/kg)	Max 10g SAR (W/kg)	SAR Drift (%)	Area scan (Figure number)
Spacing From Phantom	Laptop Position							
2mm	Screen 90°-Area 1	37	897.4	0.020	0.028	0.019	0.000	Figure 20
Limit for General Population (Uncontrolled Exposure) 1.6 W/kg (1g) & 2.0 W/kg (10g)								



Product Service

GSM 1800MHz BODY Specific Absorption Rate (Maximum SAR) 1g & 10g Results for the F3507g Ericsson Mobile Broadband Module in GPRS Mode.

Position		Channel Number	Frequency (MHz)	Max Spot SAR (W/kg)	Max 1g SAR (W/kg)	Max 10g SAR (W/kg)	SAR Drift (%)	Area scan (Figure number)
Spacing From Phantom	Laptop Position							
2mm	Screen 90°-Area 1	698	1747.4	0.100	0.106	0.069	-1.630	Figure 21
Limit for General Population (Uncontrolled Exposure) 1.6 W/kg (1g) & 2.0 W/kg (10g)								

GSM 1800MHz BODY Specific Absorption Rate (Maximum SAR) 1g & 10g Results for the F3507g Ericsson Mobile Broadband Module in EGPRS Mode.

Position		Channel Number	Frequency (MHz)	Max Spot SAR (W/kg)	Max 1g SAR (W/kg)	Max 10g SAR (W/kg)	SAR Drift (%)	Area scan (Figure number)
Spacing From Phantom	Laptop Position							
2mm	Screen 90°-Area 1	698	1747.4	0.060	0.061	0.040	-4.420	Figure 27
Limit for General Population (Uncontrolled Exposure) 1.6 W/kg (1g) & 2.0 W/kg (10g)								

GSM 1900MHz BODY Specific Absorption Rate (Maximum SAR) 1g & 10g Results for the F3507g Ericsson Mobile Broadband Module in GPRS Mode.

Position		Channel Number	Frequency (MHz)	Max Spot SAR (W/kg)	Max 1g SAR (W/kg)	Max 10g SAR (W/kg)	SAR Drift (%)	Area scan (Figure number)
Spacing From Phantom	Laptop Position							
2mm	Screen 90°-Area 1	661	1880.0	0.170	0.201	0.124	2.530	Figure 28
Limit for General Population (Uncontrolled Exposure) 1.6 W/kg (1g) & 2.0 W/kg (10g)								

GSM 1900MHz BODY Specific Absorption Rate (Maximum SAR) 1g & 10g Results for the F3507g Ericsson Mobile Broadband Module in EGPRS Mode.

Position		Channel Number	Frequency (MHz)	Max Spot SAR (W/kg)	Max 1g SAR (W/kg)	Max 10g SAR (W/kg)	SAR Drift (%)	Area scan (Figure number)
Spacing From Phantom	Laptop Position							
2mm	Screen 90°-Area 1	661	1880.0	0.100	0.110	0.071	0.000	Figure 34
Limit for General Population (Uncontrolled Exposure) 1.6 W/kg (1g) & 2.0 W/kg (10g)								





Product Service

WCDMA FDDI BODY Specific Absorption Rate (Maximum SAR) 1g & 10g Results for the F3507g Ericsson Mobile Broadband Module in QPSK Mode.

Position		Channel Number	Frequency (MHz)	Max Spot SAR (W/kg)	Max 1g SAR (W/kg)	Max 10g SAR (W/kg)	SAR Drift (%)	Area scan (Figure number)
Spacing From Phantom	Laptop Position							
2mm	Screen 90°-Area 1	9613	1922.6	0.100	0.112	0.072	0.000	Figure 35
Limit for General Population (Uncontrolled Exposure) 1.6 W/kg (1g) & 2.0 W/kg (10g)								

WCDMA FDDI BODY Specific Absorption Rate (Maximum SAR) 1g & 10g Results for the F3507g Ericsson Mobile Broadband Module in HSDPA, Sub – Test 4 Mode.

Position		Channel Number	Frequency (MHz)	Max Spot SAR (W/kg)	Max 1g SAR (W/kg)	Max 10g SAR (W/kg)	SAR Drift (%)	Area scan (Figure number)
Spacing From Phantom	Laptop Position							
2mm	Screen 90°-Area 1	9613	1922.6	0.070	0.076	0.047	0.000	Figure 41
Limit for General Population (Uncontrolled Exposure) 1.6 W/kg (1g) & 2.0 W/kg (10g)								

WCDMA FDDI BODY Specific Absorption Rate (Maximum SAR) 1g & 10g Results for the F3507g Ericsson Mobile Broadband Module in HSUPA, Sub – Test 5 Mode.

Position		Channel Number	Frequency (MHz)	Max Spot SAR (W/kg)	Max 1g SAR (W/kg)	Max 10g SAR (W/kg)	SAR Drift (%)	Area scan (Figure number)
Spacing From Phantom	Laptop Position							
2mm	Screen 90°-Area 1	9613	1922.6	0.080	0.089	0.057	0.930	Figure 42
Limit for General Population (Uncontrolled Exposure) 1.6 W/kg (1g) & 2.0 W/kg (10g)								

WCDMA FDDII BODY Specific Absorption Rate (Maximum SAR) 1g & 10g Results for the F3507g Ericsson Mobile Broadband Module in QPSK Mode.

Position		Channel Number	Frequency (MHz)	Max Spot SAR (W/kg)	Max 1g SAR (W/kg)	Max 10g SAR (W/kg)	SAR Drift (%)	Area scan (Figure number)
Spacing From Phantom	Laptop Position							
2mm	Screen 90°-Area 1	9400	1880.0	0.140	0.153	0.096	0.000	Figure 43
Limit for General Population (Uncontrolled Exposure) 1.6 W/kg (1g) & 2.0 W/kg (10g)								



Product Service

WCDMA FDDII BODY Specific Absorption Rate (Maximum SAR) 1g & 10g Results for the F3507g Ericsson Mobile Broadband Module in HSDPA, Sub – Test 4 Mode.

Position		Channel Number	Frequency (MHz)	Max Spot SAR (W/kg)	Max 1g SAR (W/kg)	Max 10g SAR (W/kg)	SAR Drift (%)	Area scan (Figure number)
Spacing From Phantom	Laptop Position							
2mm	Screen 90°-Area 1	9400	1880.0	0.070	0.084	0.053	0.000	Figure 49
Limit for General Population (Uncontrolled Exposure) 1.6 W/kg (1g) & 2.0 W/kg (10g)								

WCDMA FDDII BODY Specific Absorption Rate (Maximum SAR) 1g & 10g Results for the F3507g Ericsson Mobile Broadband Module in HSUPA, Sub – Test 5 Mode.

Position		Channel Number	Frequency (MHz)	Max Spot SAR (W/kg)	Max 1g SAR (W/kg)	Max 10g SAR (W/kg)	SAR Drift (%)	Area scan (Figure number)
Spacing From Phantom	Laptop Position							
2mm	Screen 90°-Area 1	9400	1880.0	0.090	0.105	0.063	2.010	Figure 50
Limit for General Population (Uncontrolled Exposure) 1.6 W/kg (1g) & 2.0 W/kg (10g)								

WCDMA FDDV BODY Specific Absorption Rate (Maximum SAR) 1g & 10g Results for the F3507g Ericsson Mobile Broadband Module in QPSK Mode.

Position		Channel Number	Frequency (MHz)	Max Spot SAR (W/kg)	Max 1g SAR (W/kg)	Max 10g SAR (W/kg)	SAR Drift (%)	Area scan (Figure number)
Spacing From Phantom	Laptop Position							
2mm	Screen 90°-Area 1	4175	835.0	0.030	0.038	0.026	-1.140	Figure 57
Limit for General Population (Uncontrolled Exposure) 1.6 W/kg (1g) & 2.0 W/kg (10g)								

WCDMA FDDV BODY Specific Absorption Rate (Maximum SAR) 1g & 10g Results for the F3507g Ericsson Mobile Broadband Module in HSDPA, Sub – Test 4 Mode.

Position		Channel Number	Frequency (MHz)	Max Spot SAR (W/kg)	Max 1g SAR (W/kg)	Max 10g SAR (W/kg)	SAR Drift (%)	Area scan (Figure number)
Spacing From Phantom	Laptop Position							
2mm	Screen 90°-Area 1	4175	835.0	0.020	0.030	0.017	0.000	Figure 58
Limit for General Population (Uncontrolled Exposure) 1.6 W/kg (1g) & 2.0 W/kg (10g)								



Product Service

2450MHz BODY Specific Absorption Rate (Maximum SAR) 1g & 10g Results for the Intel WiFi 5300 Module in 802.11b Mode.

Position		Channel Number	Frequency (MHz)	Max Spot SAR (W/kg)	Max 1g SAR (W/kg)	Max 10g SAR (W/kg)	SAR Drift (%)	Area scan (Figure number)
Spacing From Phantom	Laptop Position							
2mm	Screen 90°-Area 3	1	2412.0	0.100	0.119	0.072	0.430	Figure 77
Limit for General Population (Uncontrolled Exposure) 1.6 W/kg (1g) & 2.0 W/kg (10g)								

2450MHz BODY Specific Absorption Rate (Maximum SAR) 1g & 10g Results for the Intel WiFi 5300 Module in 802.11g Mode.

Position		Channel Number	Frequency (MHz)	Max Spot SAR (W/kg)	Max 1g SAR (W/kg)	Max 10g SAR (W/kg)	SAR Drift (%)	Area scan (Figure number)
Spacing From Phantom	Laptop Position							
2mm	Screen 90°-Area 1	6	2437.0	0.170	0.182	0.113	-1.380	Figure 80
Limit for General Population (Uncontrolled Exposure) 1.6 W/kg (1g) & 2.0 W/kg (10g)								

5800MHz BODY Specific Absorption Rate (Maximum SAR) 1g & 10g Results for the Intel WiFi 5300 Module in 802.11g Mode.

Position		Channel Number	Frequency (MHz)	Max Spot SAR (W/kg)	Max 1g SAR (W/kg)	Max 10g SAR (W/kg)	SAR Drift (%)	Area scan (Figure number)
Spacing From Phantom	Laptop Position							
2mm	Screen 90°-Area 3	157	5785.0	0.330	0.255	0.205	-1.290	Figure 83
2mm	Screen 90°-Area 3	157	5785.0	0.350	0.196	0.174	0.000	Figure 89
2mm	Screen 90°-Area 1	157	5785.0	0.370	0.284	0.212	0.000	Figure 93
Limit for General Population (Uncontrolled Exposure) 1.6 W/kg (1g) & 2.0 W/kg (10g)								



Product Service

## 1.4 PRODUCT INFORMATION

### 1.4.1 Technical Description

The equipment under test (EUT) was an F3507g Ericsson Mobile Broadband Module installed in DELL Latitude E4200 Laptop Computer. A full technical description can be found in the manufacturer's documentation.

### 1.4.2 Test Configuration and Modes of Operation

The F3507g Ericsson Mobile Broadband Module supplied for Specific Absorption Rate (SAR) testing was a GSM and UMTS mobile broadband module, supporting GSM850/900/1800/1900 MHz with GPRS and EGPRS Class 10 functionality. The device also supports WCDMA Bands I, II and V with HSDPA and HSUPA functionality. The testing was performed with the device installed in a DELL Latitude E4200 Laptop computer.

Testing was also carried out on the Intel WiFi 5300 Module installed in the DELL Latitude E4200 Laptop computer. The Intel WiFi 5300 supports WLAN 802.11a, 802.11b and 802.11g.

For body SAR assessment, the device was tested for typical body use in accordance with the requirements of the applied standard. Flat phantom dimensions 200mmx200mmx200mm and with a sidewall thickness of 2.0mm. The phantom was filled to a depth of 150mm with the appropriate body simulant liquid. The dielectric properties were in accordance with the requirements for the dielectric properties specified in Supplement C (Edition 01-01) to OET Bulletin 65 (Edition 97-01). SAR testing was performed with the antenna of the device placed at 2.0mm separation from the phantom.

Testing was performed at the middle frequency of each band in GPRS mode for GSM 850MHz, GSM 900 MHz, GSM 1800 MHz, and GSM 1900 MHz and RMC Test Mode for WCDMA Band I, II and V. For the GSM bands conducted output power measurements were made in accordance with the 3GPP TS 51.010-1 standard. Testing was performed at the maximum power for the appropriate modulation scheme for GSM 850MHz, GSM 900 MHz, GSM 1800 MHz, GSM 1900 MHz WCDMA FDD I, WCDMA FDD II and WCDMA FDD V. For GSM 850 MHz, GSM 900 MHz, GSM 1800 MHz and GSM 1900 MHz, the Network settings were Circuit Switched; Traffic Mode: Full Rate Version 1 and Bit Stream: 2E16-PSR bit pattern. For WCDMA FDD I, WCDMA FDD II and WCDMA FDD V assessment, SAR was measured with the device using 12.2 kbps Reference Measurement channel (RMC) configured in Test Loop Mode 2, with Transmit Power Control (TPC) bits configured to all "1's" using a Universal Radio Communications test set.

Testing was repeated at the frequency yielding the worst case SAR measurement in EGPRS mode for GSM 850 MHz, GSM 900 MHz, GSM 1800 MHz and GSM 1900 MHz.

Conducted output power measurements were made in accordance to the 3GPP 34.121 standard. The highest output power reading for HSDPA and HSUPA for FDD I, FDD II and FDD V bands were identified so that two sub-tests were run in each of the bands. The Rhode & Schwarz CMU200 Radio Communications Test Set was used to establish the required test configuration for the F3507g Ericsson Mobile Broadband Module as per the FCC OET SAR Measurement Procedures for 3G Devices [6]. The body SAR measurements were made using an FRC with H-set 1 and a 12.2kbps RMC configured in test loop mode 1.

Testing was repeated for FDD I, FDD II and FDD V bands with HSDPA and HSUPA for the subset and channel which had the highest conducted output power measurement.

Testing was also carried out on the Intel WiFi 5300 Module at 2450 MHz for 802.11b and 802.11g and at 5800 MHz for 802.11a in accordance with the FCC SAR Measurement Procedures for 802.11a/b/g transmitters document (May 2007). Testing was performed with the module in continuous transmit with three alternative antennas, A, B and C.



Product Service

The DELL Latitude E4200 laptop computer can be fitted with two bluetooth modules, Dell Wireless 365 (FCC ID: QDS-BRCM1033) and Dell Wireless 410 (Bluetooth + UWB) (FCC ID: QDS-BRCM1035). No testing was performed with these modules as the maximum output power is 1.2 mW, which is less than the 60/f threshold for unlicensed transmitters.

The DELL Latitude E4200 laptop computer antennas are located in and around the edges of the laptop screen. The position and areas scanned of the laptop during the SAR measurements is detailed in section 2.2.

The maximum 1g volume averaged SAR level measured for all the tests performed did not exceed the limits for General Population/Uncontrolled Exposure (W/kg) Partial Body of 1.6 W/kg, level defined in Supplement C (Edition 01-01) to OET Bulletin 65 (97-01).

Included in this report are descriptions of the test method; the equipment used and an analysis of the test uncertainties applicable and diagrams indicating the locations of maximum SAR for each test position along with photographs indicating the positioning of the handset against the body as appropriate.

#### **1.4.3 Co-Location Configurations**

According to FCC requirements for SAR testing of laptop computers co-located transmitters must be considered.

Below is the list of co-located transmitters for the DELL Latitude E4200.

Dell Wireless 1397  
(Gershwin)  
802.11bg  
BCM94312HMG  
FCC ID: QDS-BRCM1030

Dell Wireless 1510  
(Broadway)  
802.11b  
Broadcom  
BCM94322HMG  
FCC ID: QDS-BRCM1031

Intel WiFi 5100  
(Imperial)  
802.11abgn  
FCC ID: E2K512ANHMW

Intel WiFi 5300  
(ThirtyThirty)  
802.11abgn  
FCC ID: E2K533ANH

Dell Wireless 365  
Bluetooth  
(Little Stone)  
FCC ID: QDS-BRCM1033



Product Service

Dell 410 Bluetooth + UWB  
(Hard Rock)  
Broadcom  
BCM92046mP Cle\_UWB  
FCC ID: QDS-BRCM1035

Dell Wireless 5530 HSPA  
(Helmsley)  
Ericsson F3507g  
FCC ID: VV7-MBMF3507G-D

The only transmitter requiring co-transmission testing is the Intel WiFi 5300. The other WLAN transmitters use the Main and Aux antennas for transmission which are located 27.59 cm from the F3507g transmit antennas.

Simultaneous transmission of the F3507g module and WiFi 5300 WLAN module was not required as the sum of the maximum 1-g SAR values ( $0.124 + 0.284 = 0.408$ ) was less than 1.6 W/kg.

Simultaneous transmission of the Bluetooth modules Dell Wireless 365 and Dell 510 Bluetooth + UWB was not required. The antenna separation is 23.1 cm from the F3507g transmit antennas and the maximum output power is 1.2mW, which is less than the  $2 \cdot P_{Ref}$  (24mW) threshold for unlicensed transmitters in the 2.4 GHz band.



## 1.5 RF POWER OUTPUT – CONDUCTED

### SPECIFICATIONS

3GPP TS 51.010-1 V7.8.0, Digital cellular telecommunications system (Phase 2+); Mobile Station (MS) conformance specification; Part 1: Conformance specification (Release 7)

ETSI TS 134 121-1 V7.4.0, Universal Mobile Telecommunications System (UMTS); User Equipment (UE) conformance specification; Radio transmission and reception (FDD).

### METHOD

The conducted RF output power measurements were made at the RF output terminal of the EUT. The EUT was controlled via the Rhode & Schwarz Universal Radio Communication Tester selecting the required modes of modulation and sub-sets. The power measurements below were taken via a spectrum analyzer incorporate the path loss that was measured on the day of testing.

### RESULTS

Maximum Transmit Power Measurements.

Band	Frequency (MHz)	Conducted Transmit Power (dBm)		
		GSM	GPRS	EGPRS
850	824.2	32.30	32.51	30.68
850	836.4	32.17	32.33	30.34
850	848.8	32.15	31.75	30.58
900	880.2	31.59	31.89	29.93
900	897.4	31.72	32.44	30.21
900	914.8	31.91	32.03	30.20
1800	1710.2	29.75	28.91	29.82
1800	1747.4	29.23	28.88	29.25
1800	1784.8	28.64	28.72	28.64
1900	1850.2	29.65	30.02	29.63
1900	1880.0	29.43	30.10	29.45
1900	1909.8	28.83	29.33	28.87



FDD Band I		Conducted Transmit Power (dBm)		
3GPP 34.121 Mode	HSPA Sub-test	1922.6 MHz	1950.0 MHz	1977.4 MHz
Rel99	12.2kbps RMC	24.15	24.25	24.01
Rel6 HSDPA	1	24.37	24.42	24.18
Rel6 HSDPA	2	25.15	25.35	25.01
Rel6 HSDPA	3	25.35	25.54	25.02
Rel6 HSDPA	4	25.63	25.62	25.11
Rel6 HSUPA	1	25.92	25.9	25.5
Rel6 HSUPA	2	25.73	25.67	25.33
Rel6 HSUPA	3	25.59	24.71	25.32
Rel6 HSUPA	4	25.77	25.74	25.42
Rel6 HSUPA	5	25.97	25.97	25.44

FDD Band II		Conducted Transmit Power (dBm)		
3GPP 34.121 Mode	HSPA Sub-test	1852.4 MHz	1880 MHz	1907.6 MHz
Rel99	12.2kbps RMC	24.27	24.08	23.92
Rel6 HSDPA	1	24.59	24.41	24.27
Rel6 HSDPA	2	25.38	25.18	25.09
Rel6 HSDPA	3	25.56	25.39	25.16
Rel6 HSDPA	4	25.88	25.62	25.41
Rel6 HSUPA	1	25.77	25.72	25.35
Rel6 HSUPA	2	25.64	25.51	25.48
Rel6 HSUPA	3	25.89	25.7	25.39
Rel6 HSUPA	4	25.7	25.71	25.41
Rel6 HSUPA	5	25.9	25.86	25.54

FDD Band V		Conducted Transmit Power (dBm)		
3GPP 34.121 Mode	HSPA Sub-test	826.4 MHz	836.4 MHz	846.6 MHz
Rel99	12.2kbps RMC	24.09	24.04	23.91
Rel6 HSDPA	1	24.22	24.46	24.37
Rel6 HSDPA	2	25.12	25.39	25.02
Rel6 HSDPA	3	25.28	25.43	25.21
Rel6 HSDPA	4	25.39	25.66	25.5
Rel6 HSUPA	1	25.28	25.56	25.23
Rel6 HSUPA	2	25.24	25.59	25.11
Rel6 HSUPA	3	25.36	25.37	25.45
Rel6 HSUPA	4	25.06	25.54	25.26
Rel6 HSUPA	5	25.55	25.64	25.47





Product Service

## **SECTION 2**

### **TEST DETAILS**

Specific Absorption Rate Testing of the  
F3507g Ericsson Mobile Broadband Module and Intel WiFi 5300 Module  
Installed in DELL Latitude E4200 Laptop Computer

## 2.1 SAR MEASUREMENT SYSTEM

### 2.1.1 Robot System Specification

The SAR measurement system being used is the IndexSAR SARA2 system, which consists of a Mitsubishi RV-E2 6-axis robot arm and controller, IndexSAR probe and amplifier and SAM phantom Head Shape. The robot is used to articulate the probe to programmed positions inside the phantom head to obtain the SAR readings from the DUT.

Schematic diagram of the SAR measurement system

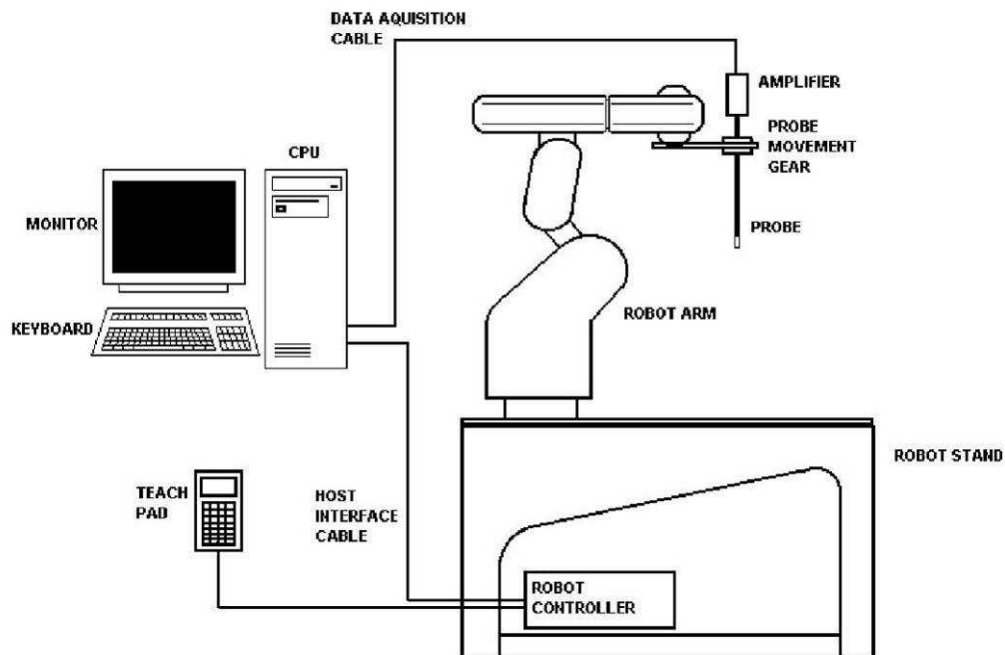

Figure 1

The system is controlled remotely from a PC, which contains the software to control the robot and data acquisition equipment. The software also displays the data obtained from test scans.

The position and digitised shape of the phantom heads are made available to the software for accurate positioning of the probe and reduction of set-up time.

The SAM phantom heads are individually digitised using a Mitutoyo CMM machine to a precision of 0.001mm. The data is then converted into a shape format for the software, providing an accurate description of the phantom shell.

In operation, the system first does an area (2D) scan at a fixed depth within the liquid from the inside wall of the phantom. When the maximum SAR point has been found, the system will then carry out a 3D scan centred at that point to determine volume averaged SAR level.

## 2.1.2 Probe and Amplifier Specification

### IXP-050 IndexSAR isotropic immersible SAR probe

The probes are constructed using three orthogonal dipole sensors arranged on an interlocking, triangular prism core. The probes have built-in shielding against static charges and are contained within a PEEK cylindrical enclosure material at the tip. Probe calibration is described in the following section.

### IFA-010 Fast Amplifier

Technical description of IndexSAR IFA-010 Fast probe amplifier

A block diagram of the fast probe amplifier electronics is shown below.

### Block diagram of the fast probe amplifier electronic

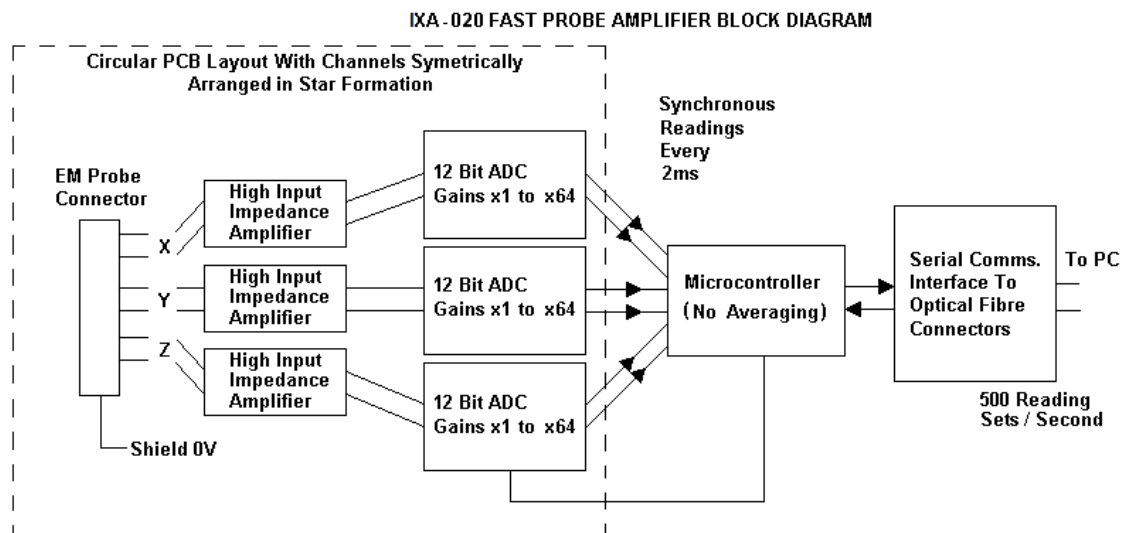

Figure 2

This amplifier has a time constant of approx.  $50\mu\text{s}$ , which is much faster than the SAR probe response time. The overall system time constant is therefore that of the probe ( $<1\text{ms}$ ) and reading sets for all three channels (simultaneously) are returned every 2ms to the PC. The conversion period is approx.  $1\mu\text{s}$  at the start of each 2ms period. This enables the probe to follow pulse modulated signals of periods  $\gg 2\text{ms}$ . The PC software applies the linearisation procedure separately to each reading, so no linearisation corrections for the averaging of modulated signals are needed in this case. It is important to ensure that the probe reading frequency and the pulse period are not synchronised and the behaviour with pulses of short duration in comparison with the measurement interval need additional consideration.

### Phantoms

The Flat phantom used is a rectangular Perspex Box IndexSAR item IXB-070. Dimensions 210w 210d 210h (mm). This phantom is used with IndexSAR side bench IXM-030.

The Specific Anthropomorphic Mannequin (SAM) Upright Phantom is fabricated using moulds generated from the CAD files as specified by CENELEC EN 62209-1:2006. It is mounted via a rotation base to a supporting table, which also holds the robotic positioner. The phantom and robot alignment is assured by both mechanical and laser registration systems.

### 2.1.3 SAR Measurement Procedure

Principal components of the SAR measurement test bench

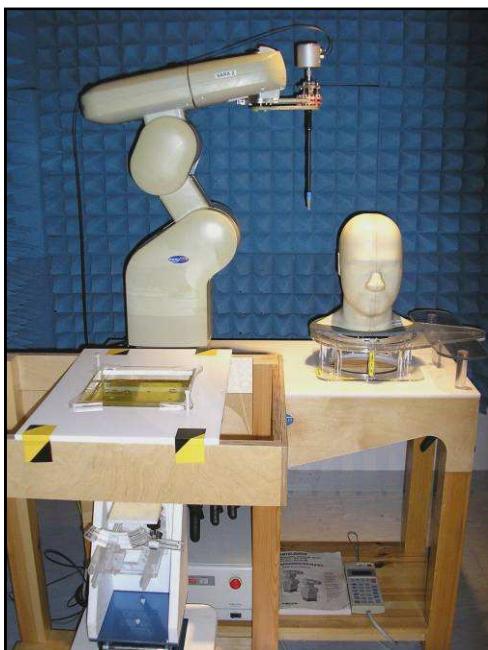

Figure 3

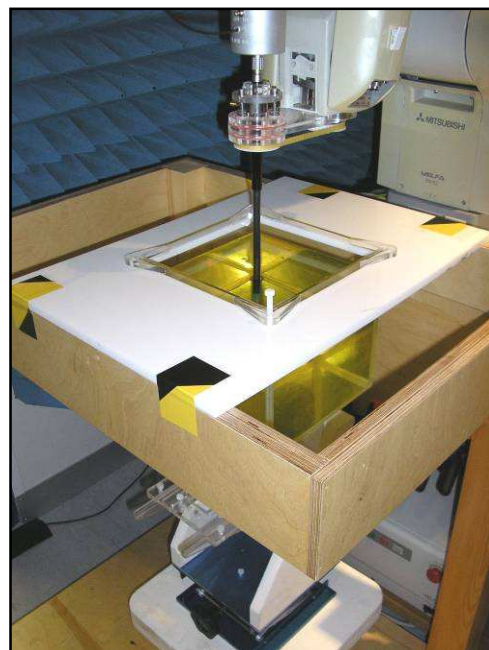

Figure 4

The major components of the test bench are shown in the picture above. A test set and dipole antenna control the handset via an air link and a low-mass phone holder can position the phone at either ear. Graduated scales are provided to set the phone in the 15 degree position. The upright phantom head holds approx. 7 litres of simulant liquid. The phantom is filled and emptied through a 45mm diameter penetration hole in the top of the head.

After an area scan has been done at a fixed distance of 8mm from the surface of the phantom on the source side, a 3D scan is set up around the location of the maximum spot SAR. First, a point within the scan area is visited by the probe and a SAR reading taken at the start of testing. At the end of testing, the probe is returned to the same point and a second reading is taken. Comparison between these start and end readings enables the power drift during measurement to be assessed.

#### SARA2 Interpolation and Extrapolation schemes

SARA2 software contains support for both 2D cubic B-spline interpolation as well as 3D cubic B-spline interpolation. In addition, for extrapolation purposes, a general  $n^{\text{th}}$  order polynomial fitting routine is implemented following a singular value decomposition algorithm presented in [4]. A 4<sup>th</sup> order polynomial fit is used by default for data extrapolation, but a linear-logarithmic fitting function can be selected as an option. The polynomial fitting procedures have been tested by comparing the fitting coefficients generated by the SARA2 procedures with those obtained using the polynomial fit functions of Microsoft Excel when applied to the same test input data.



### Interpolation of 2D area scan

The 2D cubic B-spline interpolation is used after the initial area scan at fixed distance from the phantom shell wall. The initial scan data are collected with approx. 115mm spatial resolution and spline interpolation is used to find the location of the local maximum to within a 1mm resolution for positioning the subsequent 3D scanning.

### Extrapolation of 3D scan

For the 3D scan, data are collected on a spatially regular 3D grid having (by default) 6.4 mm steps in the lateral dimensions and 3.5 mm steps in the depth direction (away from the source). SARA2 enables full control over the selection of alternative step sizes in all directions.

The digitised shape of the head is available to the SARA2 software, which decides which points in the 3D array are sufficiently well within the shell wall to be 'visited' by the SAR probe. After the data collection, the data are extrapolated in the depth direction to assign values to points in the 3D array closer to the shell wall. A notional extrapolation value is also assigned to the first point outside the shell wall so that subsequent interpolation schemes will be applicable right up to the shell wall boundary.

### Interpolation of 3D scan and volume averaging

The procedure used for defining the shape of the volumes used for SAR averaging in the SARA2 software follow the method of adapting the surface of the 'cube' to conform with the curved inner surface of the phantom (see Appendix C.2.2.1 in EN 62209-1:2006). This is called, here, the conformal scheme.

For each row of data in the depth direction, the data are extrapolated and interpolated to less than 1mm spacing and average values are calculated from the phantom surface for the row of data over distances corresponding to the requisite depth for 10g and 1g cubes. This results in two 2D arrays of data, which are then cubic B-spline interpolated to sub mm lateral resolution. A search routine then moves an averaging square around through the 2D array and records the maximum value of the corresponding 1g and 10g volume averages. For the definition of the surface in this procedure, the digitised position of the headshell surface is used for measurement in head-shaped phantoms. For measurements in rectangular, box phantoms, the distance between the phantom wall and the closest set of gridded data points is entered into the software.

For measurements in box-shaped phantoms, this distance is under the control of the user. The effective distance must be greater than 2.5mm as this is the tip-sensor distance and to avoid interface proximity effects, it should be at least 5mm. A value of 6 or 8mm is recommended. This distance is called **dbe** in EN 62209-1:2006.

For automated measurements inside the head, the distance cannot be less than 2.5mm, which is the radius of the probe tip and to avoid interface proximity effects, a minimum clearance distance of  $x$  mm is retained. The actual value of **dbe** will vary from point to point depending upon how the spatially-regular 3D grid points fit within the shell. The greatest separation is when a grid point is just not visited due to the probe tip dimensions. In this case the distance could be as large as the step-size plus the minimum clearance distance (i.e with  $x=5$  and a step size of 3.5, **dbe** will be between 3.5 and 8.5mm).

The default step size (**dstep** in EN 62209-1:2006) used is 3.5mm, but this is under user-control. The compromise is with time of scan, so it is not practical to make it much smaller or scan times become long and power-drop influences become larger.



Product Service

The robot positioning system specification for the repeatability of the positioning (**dss** in EN 62209-1:2006) is +/- 0.04mm.

The phantom shell is made by an industrial moulding process from the CAD files of the SAM shape, with both internal and external moulds. For the upright phantoms, the external shape is subsequently digitised on a Mitutoyo CMM machine (Euro C574) to a precision of 0.001mm. Wall thickness measurements made non-destructively with an ultrasonic sensor indicate that the shell thickness (**dph**) away from the ear is 2.0 +/- 0.1mm. The ultrasonic measurements were calibrated using additional mechanical measurements on available cut surfaces of the phantom shells.

For the upright phantom, the alignment is based upon registration of the rotation axis of the phantom on its 253mm-diameter baseplate bearing and the position of the probe axis when commanded to go to the axial position. A laser alignment tool is provided (procedure detailed elsewhere). This enables the registration of the phantom tip (**dmis**) to be assured to within approx. 0.2mm. This alignment is done with reference to the actual probe tip after installation and probe alignment. The rotational positioning of the phantom is variable – offering advantages for special studies, but locating pins ensure accurate repositioning at the principal positions (LH and RH ears).

## 2.2 EUT POSITIONING DESCRIPTION

The laptop base was divided into sections due to the limited scanning area of the flat phantom. This resulted in 6 sections as illustrated in Figure 5.



Figure 5

Initial area scans were performed in order to identify the worst-case position. Then full SAR evaluation was performed with the device in the worst-case position with all frequencies and modes being evaluated as applicable.

### 2.3 GSM 850 BODY SAR TEST RESULTS AND COURSE AREA SCANS – 2D

SYSTEM / SOFTWARE:	SARA2 / 2.53 VPM	INPUT POWER DRIFT:	0.0 dB
DATE / TIME:	28/07/2008 13:56:54	DUT BATTERY MODEL/NO:	N/A
FILENAME:	75903561-01a.txt	PROBE SERIAL NUMBER:	0171
AMBIENT TEMPERATURE:	23.50°C	LIQUID SIMULANT:	850Body
DEVICE UNDER TEST:	Ericsson Module	RELATIVE PERMITTIVITY:	58.20
RELATIVE HUMIDITY:	51.00%	CONDUCTIVITY:	0.998
PHANTOM S/NO:	HeadBox.csv	LIQUID TEMPERATURE:	22.70°C
PHANTOM ROTATION:	0°	MAX SAR X-AXIS LOCATION:	-29.00mm
DUT POSITION:	Screen 90° - Area 1	MAX SAR Y-AXIS LOCATION:	12.00mm
ANTENNA CONFIGURATION:	N/A	MAX E FIELD:	6.54 V/m
TEST FREQUENCY:	836.4MHz	SAR 1g:	N/A
AIR FACTORS:	421 / 374 / 405	SAR 10g:	N/A
CONVERSION FACTORS:	0.278 / 0.278 / 0.278	SAR START:	N/A
TYPE OF MODULATION:	GMSK (GPRS Mode)	SAR END:	N/A
MODN. DUTY CYCLE:	25.0 %	SAR DRIFT DURING SCAN:	0.00 %
DIODE COMPRESSION FACTORS (V*200):	20 / 20 / 20	PROBE BATTERY LAST CHANGED:	28/07/2008
INPUT POWER LEVEL:	33 dBm	EXTRAPOLATION:	poly4

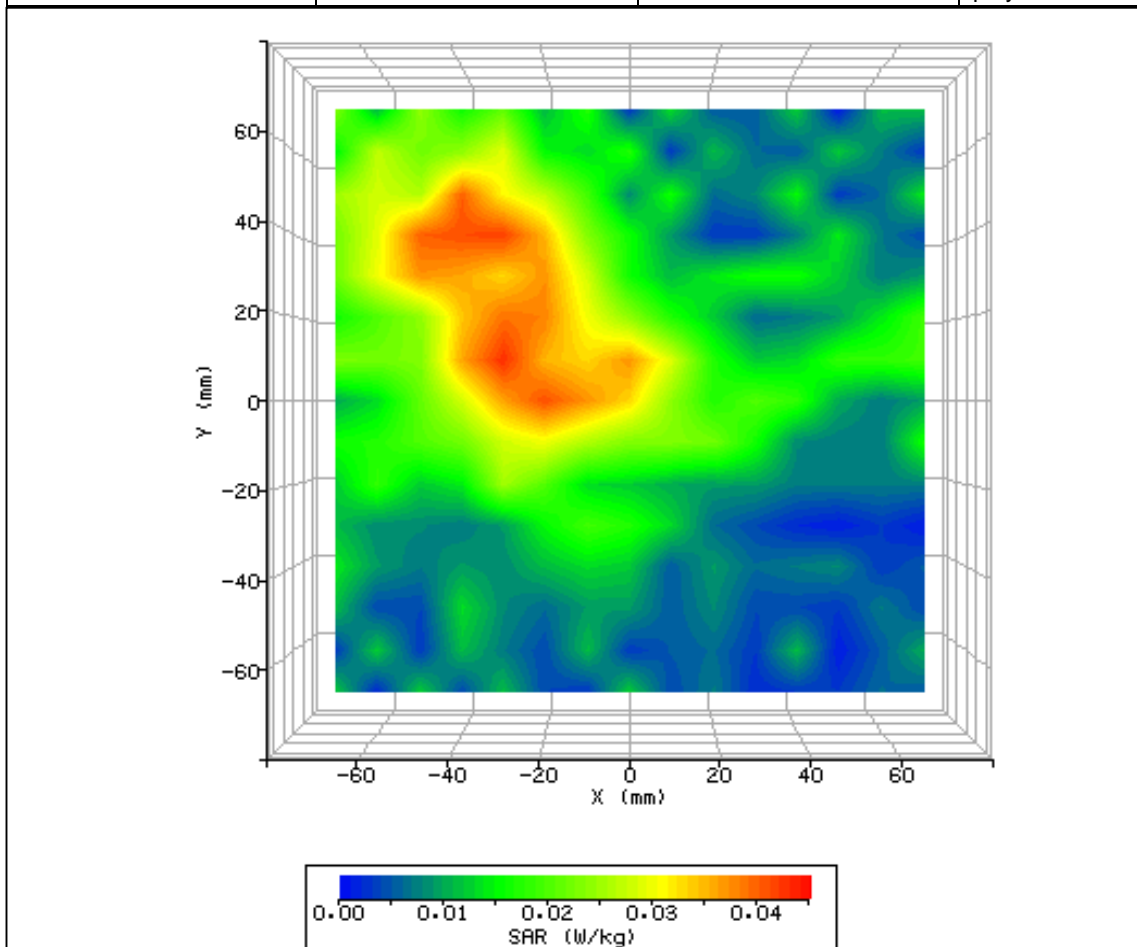

Figure 6: SAR Body Testing Results for the Ericsson Mobile Broadband Module in Screen 90° - Area 1 Phantom Position; Tested at 836.4MHz (GSM 850 Mid Channel) with 2mm Separation Distance to the Phantom (NUA).



SYSTEM / SOFTWARE:	SARA2 / 2.53 VPM	INPUT POWER DRIFT:	0.0 dB
DATE / TIME:	28/07/2008 14:23:57	DUT BATTERY MODEL/NO:	N/A
FILENAME:	75903561-02a.txt	PROBE SERIAL NUMBER:	0171
AMBIENT TEMPERATURE:	23.60°C	LIQUID SIMULANT:	850Body
DEVICE UNDER TEST:	Ericsson Module	RELATIVE PERMITTIVITY:	58.20
RELATIVE HUMIDITY:	50.70%	CONDUCTIVITY:	0.998
PHANTOM S/NO:	HeadBox.csv	LIQUID TEMPERATURE:	22.70°C
PHANTOM ROTATION:	0°	MAX SAR X-AXIS LOCATION:	Off Edge
DUT POSITION:	Screen 90° - Area 2	MAX SAR Y-AXIS LOCATION:	Off Edge
ANTENNA CONFIGURATION:	N/A	MAX E FIELD:	5.27 V/m
TEST FREQUENCY:	836.4MHz	SAR 1g:	N/A
AIR FACTORS:	421 / 374 / 405	SAR 10g:	N/A
CONVERSION FACTORS:	0.278 / 0.278 / 0.278	SAR START:	N/A
TYPE OF MODULATION:	GMSK (GPRS Mode)	SAR END:	N/A
MODN. DUTY CYCLE:	25.0 %	SAR DRIFT DURING SCAN:	0.00 %
DIODE COMPRESSION FACTORS (V*200):	20 / 20 / 20	PROBE BATTERY LAST CHANGED:	28/07/2008
INPUT POWER LEVEL:	33 dBm	EXTRAPOLATION:	poly4

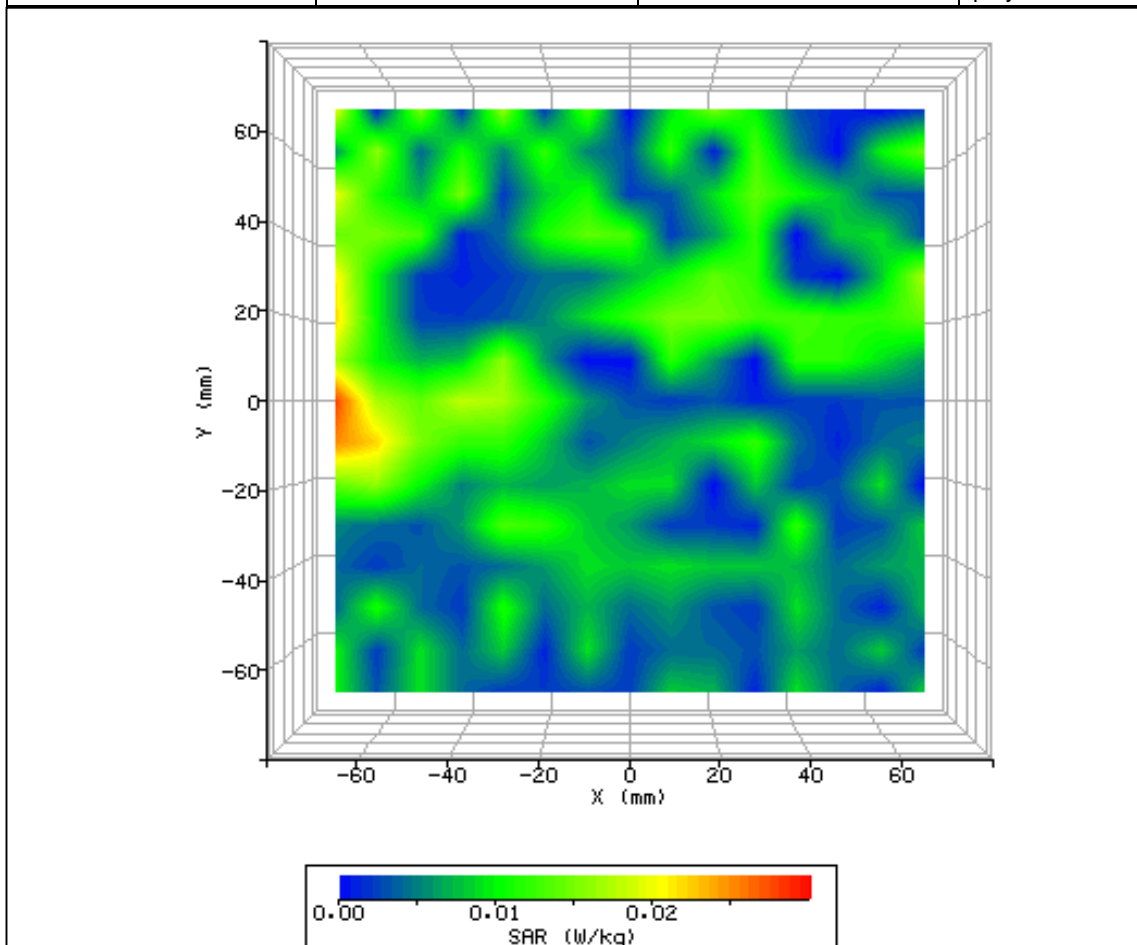

Figure 7: SAR Body Testing Results for the Ericsson Mobile Broadband Module in Screen 90° - Area 2 Phantom Position; Tested at 836.4MHz (GSM 850 Mid Channel) with 2mm Separation Distance to the Phantom (NUA).

SYSTEM / SOFTWARE:	SARA2 / 2.53 VPM	INPUT POWER DRIFT:	0.0 dB
DATE / TIME:	28/07/2008 14:34:53	DUT BATTERY MODEL/NO:	N/A
FILENAME:	75903561-03a.txt	PROBE SERIAL NUMBER:	0171
AMBIENT TEMPERATURE:	24.00°C	LIQUID SIMULANT:	850Body
DEVICE UNDER TEST:	Ericsson Module	RELATIVE PERMITTIVITY:	58.20
RELATIVE HUMIDITY:	50.10%	CONDUCTIVITY:	0.998
PHANTOM S/NO:	HeadBox.csv	LIQUID TEMPERATURE:	22.80°C
PHANTOM ROTATION:	0°	MAX SAR X-AXIS LOCATION:	Off Edge
DUT POSITION:	Screen 90° - Area 3	MAX SAR Y-AXIS LOCATION:	Off Edge
ANTENNA CONFIGURATION:	N/A	MAX E FIELD:	3.93 V/m
TEST FREQUENCY:	836.4MHz	SAR 1g:	N/A
AIR FACTORS:	421 / 374 / 405	SAR 10g:	N/A
CONVERSION FACTORS:	0.278 / 0.278 / 0.278	SAR START:	N/A
TYPE OF MODULATION:	GMSK (GPRS Mode)	SAR END:	N/A
MODN. DUTY CYCLE:	25.0 %	SAR DRIFT DURING SCAN:	0.00 %
DIODE COMPRESSION FACTORS (V*200):	20 / 20 / 20	PROBE BATTERY LAST CHANGED:	28/07/2008
INPUT POWER LEVEL:	33 dBm	EXTRAPOLATION:	poly4

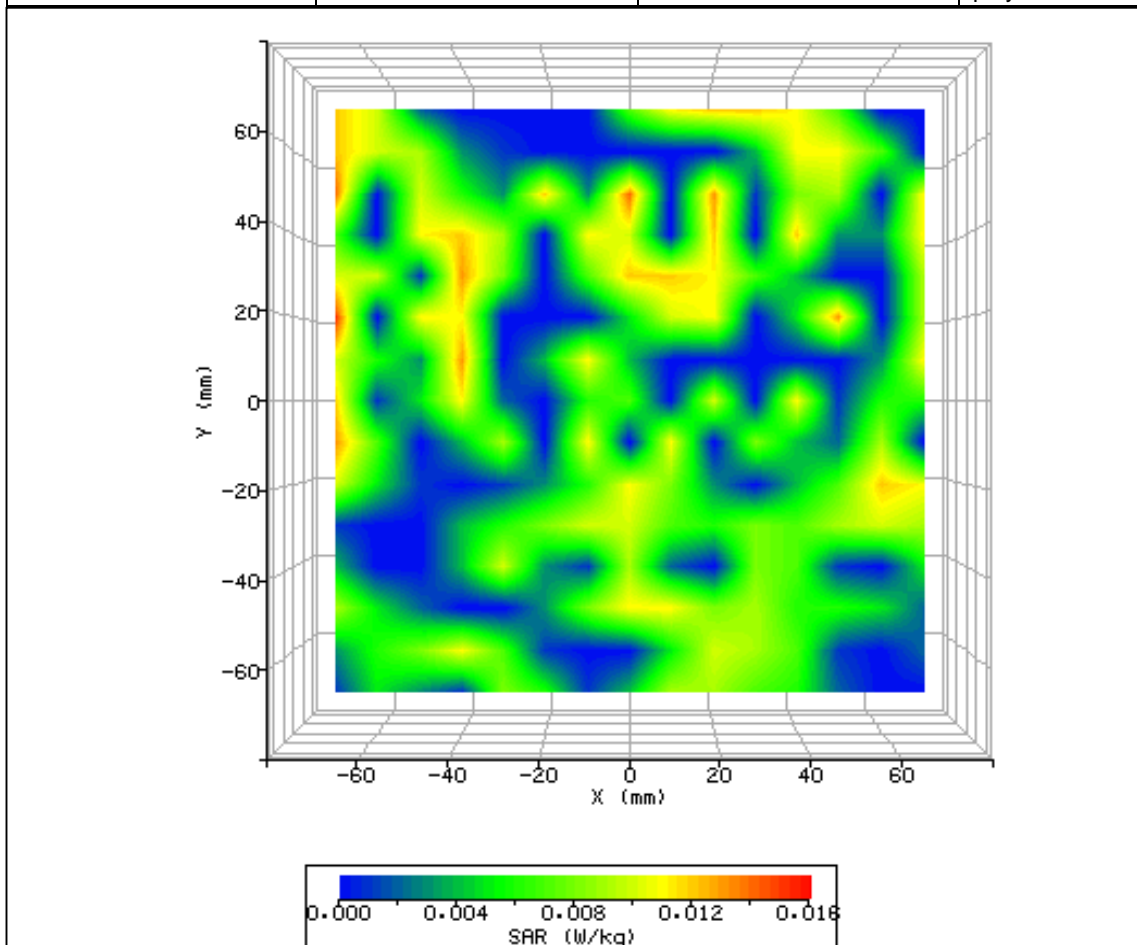

Figure 8: SAR Body Testing Results for the Ericsson Mobile Broadband Module in Screen 90° - Area 3 Phantom Position; Tested at 836.4MHz (GSM 850 Mid Channel) with 2mm Separation Distance to the Phantom (NUA).

SYSTEM / SOFTWARE:	SARA2 / 2.53 VPM	INPUT POWER DRIFT:	0.0 dB
DATE / TIME:	28/07/2008 14:45:26	DUT BATTERY MODEL/NO:	N/A
FILENAME:	75903561-04a.txt	PROBE SERIAL NUMBER:	0171
AMBIENT TEMPERATURE:	24.00°C	LIQUID SIMULANT:	850Body
DEVICE UNDER TEST:	Ericsson Module	RELATIVE PERMITTIVITY:	58.20
RELATIVE HUMIDITY:	49.70%	CONDUCTIVITY:	0.998
PHANTOM S/NO:	HeadBox.csv	LIQUID TEMPERATURE:	22.80°C
PHANTOM ROTATION:	0°	MAX SAR X-AXIS LOCATION:	Off Edge
DUT POSITION:	Screen 90° - Area 4	MAX SAR Y-AXIS LOCATION:	Off Edge
ANTENNA CONFIGURATION:	N/A	MAX E FIELD:	5.12 V/m
TEST FREQUENCY:	836.4MHz	SAR 1g:	N/A
AIR FACTORS:	421 / 374 / 405	SAR 10g:	N/A
CONVERSION FACTORS:	0.278 / 0.278 / 0.278	SAR START:	N/A
TYPE OF MODULATION:	GMSK (GPRS Mode)	SAR END:	N/A
MODN. DUTY CYCLE:	25.0 %	SAR DRIFT DURING SCAN:	0.00 %
DIODE COMPRESSION FACTORS (V*200):	20 / 20 / 20	PROBE BATTERY LAST CHANGED:	28/07/2008
INPUT POWER LEVEL:	33 dBm	EXTRAPOLATION:	poly4

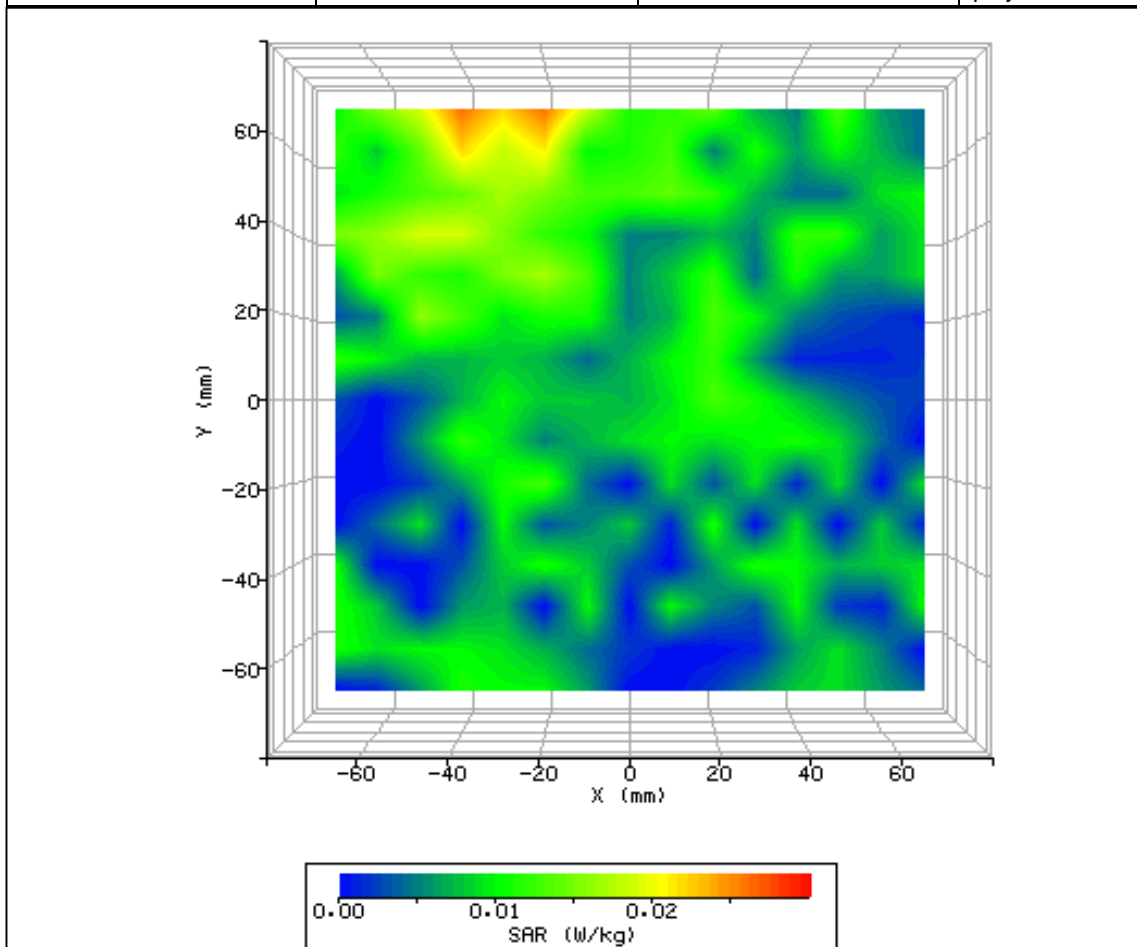

Figure 9: SAR Body Testing Results for the Ericsson Mobile Broadband Module in Screen 90° - Area 4 Phantom Position; Tested at 836.4MHz (GSM 850 Mid Channel) with 2mm Separation Distance to the Phantom (NUA).

SYSTEM / SOFTWARE:	SARA2 / 2.53 VPM	INPUT POWER DRIFT:	0.0 dB
DATE / TIME:	28/07/2008 15:20:02	DUT BATTERY MODEL/NO:	N/A
FILENAME:	75903561-05a.txt	PROBE SERIAL NUMBER:	0171
AMBIENT TEMPERATURE:	24.00°C	LIQUID SIMULANT:	850Body
DEVICE UNDER TEST:	Ericsson Module	RELATIVE PERMITTIVITY:	58.20
RELATIVE HUMIDITY:	48.50%	CONDUCTIVITY:	0.998
PHANTOM S/NO:	HeadBox.csv	LIQUID TEMPERATURE:	22.90°C
PHANTOM ROTATION:	0°	MAX SAR X-AXIS LOCATION:	Off Edge
DUT POSITION:	Screen 90° - Area 5	MAX SAR Y-AXIS LOCATION:	Off Edge
ANTENNA CONFIGURATION:	N/A	MAX E FIELD:	4.58 V/m
TEST FREQUENCY:	836.4MHz	SAR 1g:	N/A
AIR FACTORS:	421 / 374 / 405	SAR 10g:	N/A
CONVERSION FACTORS:	0.278 / 0.278 / 0.278	SAR START:	N/A
TYPE OF MODULATION:	GMSK (GPRS Mode)	SAR END:	N/A
MODN. DUTY CYCLE:	25.0 %	SAR DRIFT DURING SCAN:	0.00 %
DIODE COMPRESSION FACTORS (V*200):	20 / 20 / 20	PROBE BATTERY LAST CHANGED:	28/07/2008
INPUT POWER LEVEL:	33 dBm	EXTRAPOLATION:	poly4

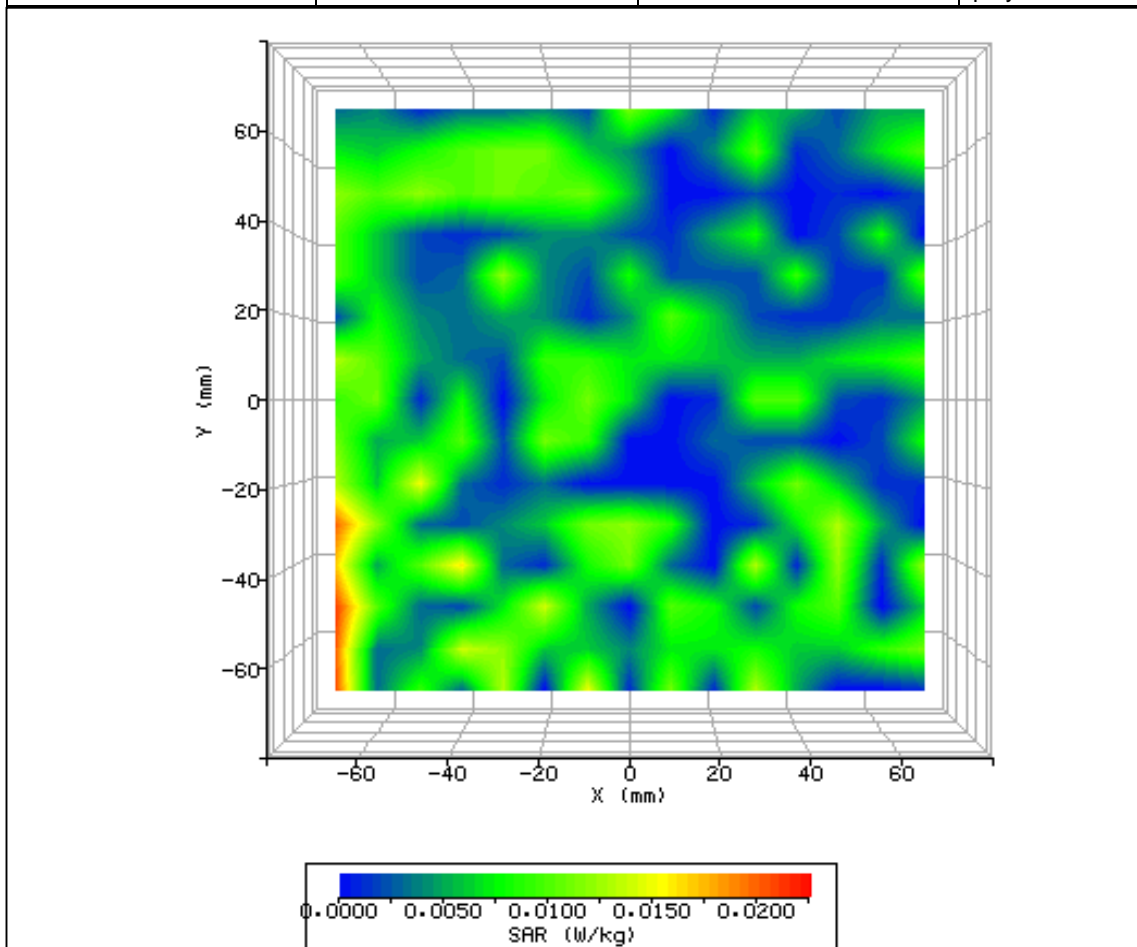

Figure 10: SAR Body Testing Results for the Ericsson Mobile Broadband Module in Screen 90° - Area 5 Phantom Position; Tested at 836.4MHz (GSM 850 Mid Channel) with 2mm Separation Distance to the Phantom (NUA).

SYSTEM / SOFTWARE:	SARA2 / 2.53 VPM	INPUT POWER DRIFT:	0.0 dB
DATE / TIME:	28/07/2008 15:43:01	DUT BATTERY MODEL/NO:	N/A
FILENAME:	75903561-06a.txt	PROBE SERIAL NUMBER:	0171
AMBIENT TEMPERATURE:	24.20°C	LIQUID SIMULANT:	850Body
DEVICE UNDER TEST:	Ericsson Module	RELATIVE PERMITTIVITY:	58.20
RELATIVE HUMIDITY:	48.10%	CONDUCTIVITY:	0.998
PHANTOM S/NO:	HeadBox.csv	LIQUID TEMPERATURE:	22.90°C
PHANTOM ROTATION:	0°	MAX SAR X-AXIS LOCATION:	Off Edge
DUT POSITION:	Screen 90° - Area 6	MAX SAR Y-AXIS LOCATION:	Off Edge
ANTENNA CONFIGURATION:	N/A	MAX E FIELD:	3.55 V/m
TEST FREQUENCY:	836.4MHz	SAR 1g:	N/A
AIR FACTORS:	421 / 374 / 405	SAR 10g:	N/A
CONVERSION FACTORS:	0.278 / 0.278 / 0.278	SAR START:	N/A
TYPE OF MODULATION:	GMSK (GPRS Mode)	SAR END:	N/A
MODN. DUTY CYCLE:	25.0 %	SAR DRIFT DURING SCAN:	0.00 %
DIODE COMPRESSION FACTORS (V*200):	20 / 20 / 20	PROBE BATTERY LAST CHANGED:	28/07/2008
INPUT POWER LEVEL:	33 dBm	EXTRAPOLATION:	poly4

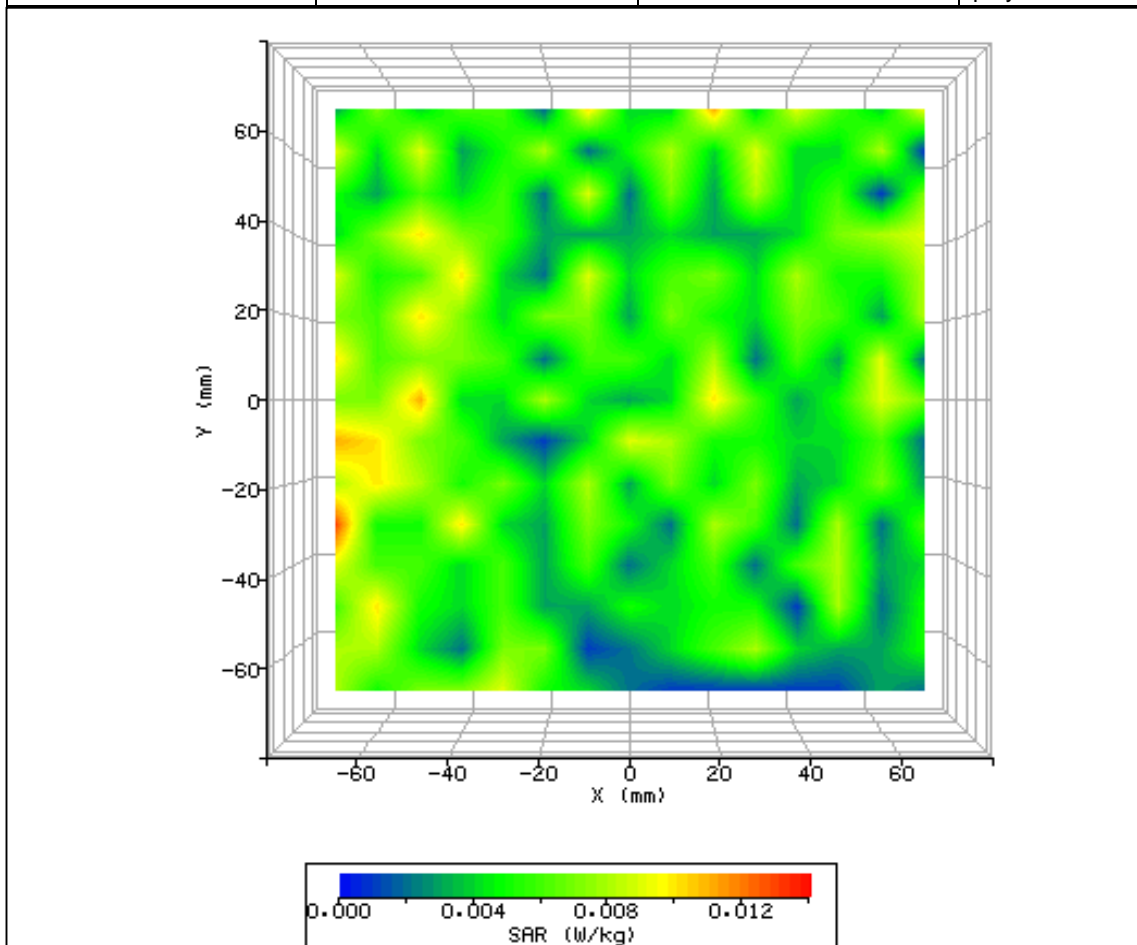

Figure 11: SAR Body Testing Results for the Ericsson Mobile Broadband Module in Screen 90° - Area 6 Phantom Position; Tested at 836.4MHz (GSM 850 Mid Channel) with 2mm Separation Distance to the Phantom (NUA).

SYSTEM / SOFTWARE:	SARA2 / 2.53 VPM	INPUT POWER DRIFT:	0.0 dB
DATE / TIME:	28/07/2008 16:28:47	DUT BATTERY MODEL/NO:	N/A
FILENAME:	75903561-07.txt	PROBE SERIAL NUMBER:	0171
AMBIENT TEMPERATURE:	24.50°C	LIQUID SIMULANT:	850Body
DEVICE UNDER TEST:	Ericsson Module	RELATIVE PERMITTIVITY:	58.20
RELATIVE HUMIDITY:	47.30%	CONDUCTIVITY:	0.998
PHANTOM S/NO:	HeadBox.csv	LIQUID TEMPERATURE:	22.90°C
PHANTOM ROTATION:	0°	MAX SAR X-AXIS LOCATION:	-30.000mm
DUT POSITION:	Screen 90° - Area 1	MAX SAR Y-AXIS LOCATION:	28.00mm
ANTENNA CONFIGURATION:	N/A	MAX E FIELD:	7.08 V/m
TEST FREQUENCY:	836.4MHz	SAR 1g:	0.053 W/kg
AIR FACTORS:	421 / 374 / 405	SAR 10g:	0.036 W/kg
CONVERSION FACTORS:	0.278 / 0.278 / 0.278	SAR START:	0.019 W/kg
TYPE OF MODULATION:	GMSK (GPRS Mode)	SAR END:	0.019 W/kg
MODN. DUTY CYCLE:	25.0 %	SAR DRIFT DURING SCAN:	2.28 %
DIODE COMPRESSION FACTORS (V*200):	20 / 20 / 20	PROBE BATTERY LAST CHANGED:	28/07/2008
INPUT POWER LEVEL:	33 dBm	EXTRAPOLATION:	poly4

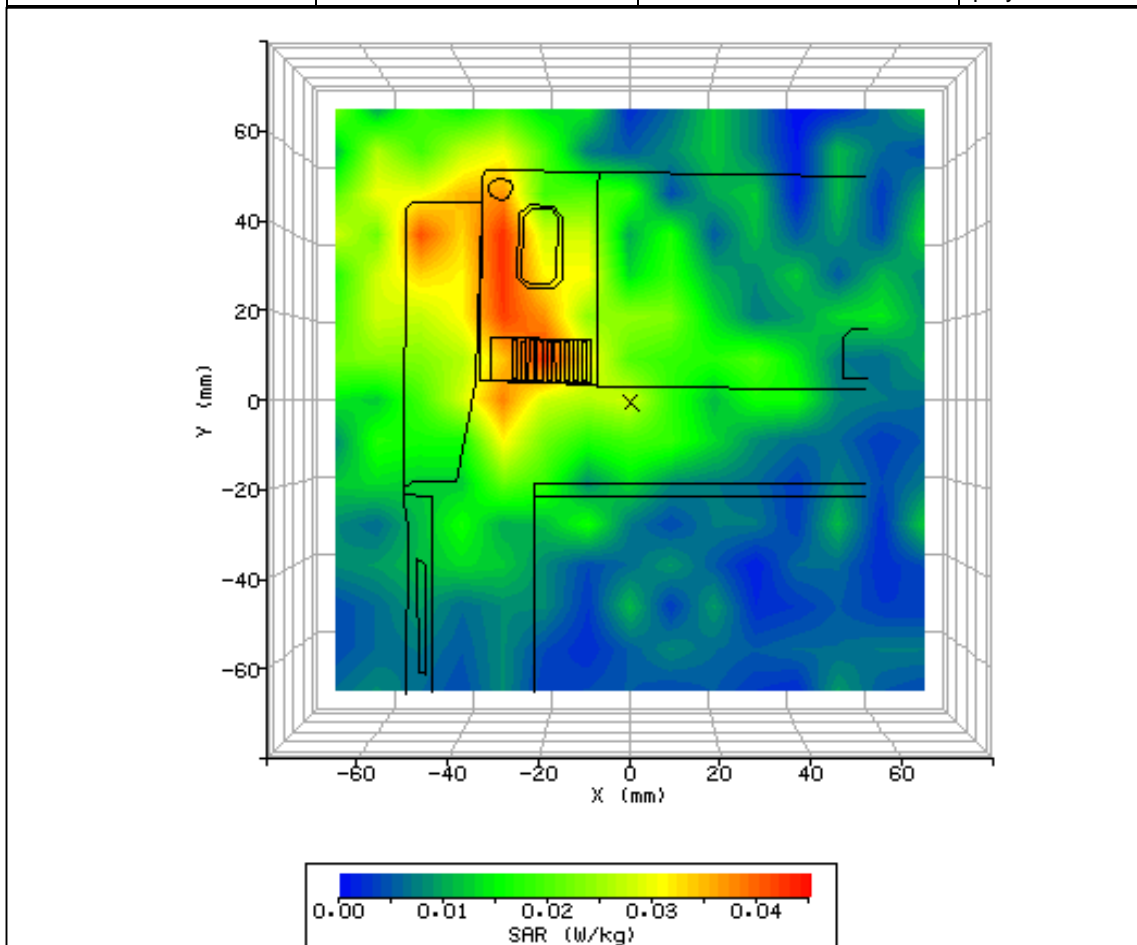

Figure 12: SAR Body Testing Results for the Ericsson Mobile Broadband Module in Screen 90° - Area 1 Phantom Position; Tested at 836.4MHz (GSM 850 Mid Channel) with 2mm Separation Distance to the Phantom (NUA).

SYSTEM / SOFTWARE:	SARA2 / 2.53 VPM	INPUT POWER DRIFT:	0.0 dB
DATE / TIME:	30/07/2008 11:31:13	DUT BATTERY MODEL/NO:	N/A
FILENAME:	75903561-08.txt	PROBE SERIAL NUMBER:	0171
AMBIENT TEMPERATURE:	24.50°C	LIQUID SIMULANT:	850Body
DEVICE UNDER TEST:	Ericsson Module	RELATIVE PERMITTIVITY:	58.20
RELATIVE HUMIDITY:	47.80%	CONDUCTIVITY:	0.998
PHANTOM S/NO:	HeadBox.csv	LIQUID TEMPERATURE:	23.00°C
PHANTOM ROTATION:	0°	MAX SAR X-AXIS LOCATION:	-38.00mm
DUT POSITION:	Screen 90° - Area 1	MAX SAR Y-AXIS LOCATION:	47.00mm
ANTENNA CONFIGURATION:	N/A	MAX E FIELD:	4.61 V/m
TEST FREQUENCY:	836.4MHz	SAR 1g:	0.029 W/kg
AIR FACTORS:	421 / 374 / 405	SAR 10g:	0.016 W/kg
CONVERSION FACTORS:	0.278 / 0.278 / 0.278	SAR START:	0.008 W/kg
TYPE OF MODULATION:	8-PSK (EGPRS Mode)	SAR END:	0.008 W/kg
MODN. DUTY CYCLE:	25.0 %	SAR DRIFT DURING SCAN:	-1.93 %
DIODE COMPRESSION FACTORS (V*200):	20 / 20 / 20	PROBE BATTERY LAST CHANGED:	29/07/2008
INPUT POWER LEVEL:	27 dBm	EXTRAPOLATION:	poly4

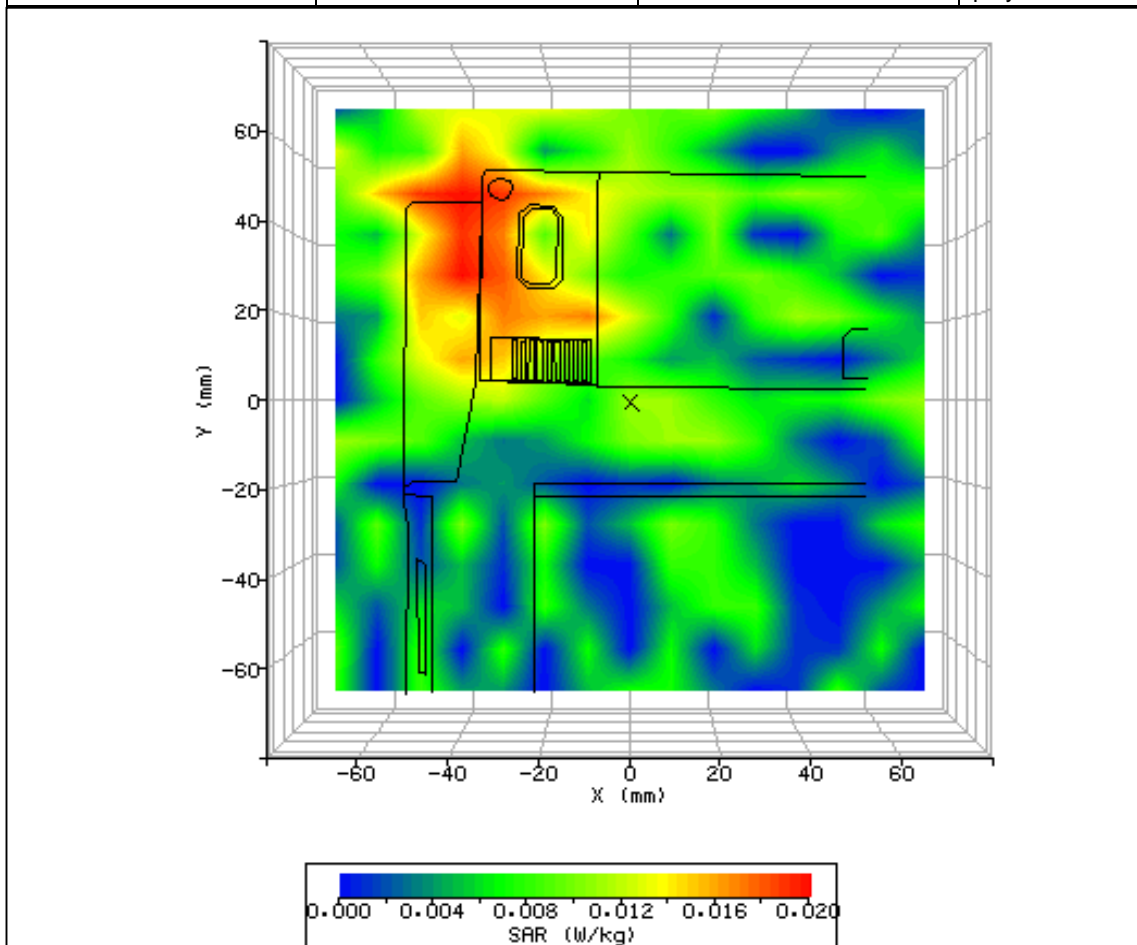

Figure 13: SAR Body Testing Results for the Ericsson Mobile Broadband Module in Screen 90° - Area 1 Phantom Position; Tested at 836.4MHz (GSM 850 Mid Channel) with 2mm Separation Distance to the Phantom (NUA).

## 2.4 GSM 900 BODY SAR TEST RESULTS AND COURSE AREA SCANS – 2D

SYSTEM / SOFTWARE:	SARA2 / 2.53 VPM	INPUT POWER DRIFT:	0.0 dB
DATE / TIME:	29/07/2008 11:51:42	DUT BATTERY MODEL/NO:	N/A
FILENAME:	75903561-09.txt	PROBE SERIAL NUMBER:	0171
AMBIENT TEMPERATURE:	22.60°C	LIQUID SIMULANT:	900Body
DEVICE UNDER TEST:	Ericsson Module	RELATIVE PERMITTIVITY:	57.63
RELATIVE HUMIDITY:	57.30%	CONDUCTIVITY:	1.062
PHANTOM S/NO:	HeadBox.csv	LIQUID TEMPERATURE:	22.50°C
PHANTOM ROTATION:	0°	MAX SAR X-AXIS LOCATION:	-39.00mm
DUT POSITION:	Screen 90° - Area 1	MAX SAR Y-AXIS LOCATION:	44.00mm
ANTENNA CONFIGURATION:	N/A	MAX E FIELD:	7.19 V/m
TEST FREQUENCY:	897.4MHz	SAR 1g:	0.062 W/kg
AIR FACTORS:	421 / 374 / 405	SAR 10g:	0.043 W/kg
CONVERSION FACTORS:	0.278 / 0.278 / 0.278	SAR START:	0.018 W/kg
TYPE OF MODULATION:	GMSK (GPRS Mode)	SAR END:	0.018 W/kg
MODN. DUTY CYCLE:	25.0 %	SAR DRIFT DURING SCAN:	0.63 %
DIODE COMPRESSION FACTORS (V*200):	20 / 20 / 20	PROBE BATTERY LAST CHANGED:	29/07/2008
INPUT POWER LEVEL:	33 dBm	EXTRAPOLATION:	poly4

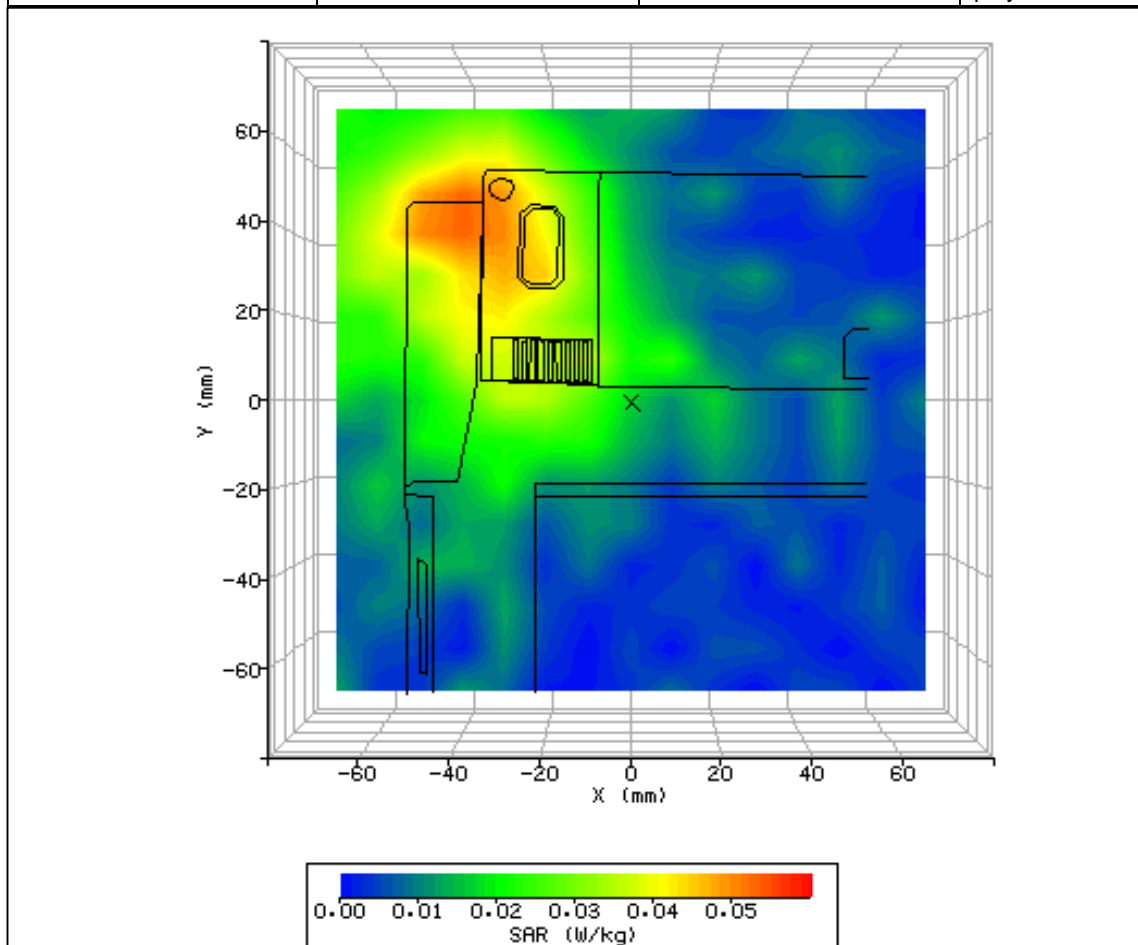

Figure 14: SAR Body Testing Results for the Ericsson Mobile Broadband Module in Screen 90° - Area 1 Phantom Position; Tested at 897.4MHz (GSM 900 Mid Channel) with 2mm Separation Distance to the Phantom (NUA).



SYSTEM / SOFTWARE:	SARA2 / 2.53 VPM	INPUT POWER DRIFT:	0.0 dB
DATE / TIME:	29/07/2008 12:03:30	DUT BATTERY MODEL/NO:	N/A
FILENAME:	75903561-10a.txt	PROBE SERIAL NUMBER:	0171
AMBIENT TEMPERATURE:	22.50°C	LIQUID SIMULANT:	900Body
DEVICE UNDER TEST:	Ericsson Module	RELATIVE PERMITTIVITY:	57.63
RELATIVE HUMIDITY:	57.60%	CONDUCTIVITY:	1.062
PHANTOM S/NO:	HeadBox.csv	LIQUID TEMPERATURE:	22.50°C
PHANTOM ROTATION:	0°	MAX SAR X-AXIS LOCATION:	Off Edge
DUT POSITION:	Screen 90° - Area 2	MAX SAR Y-AXIS LOCATION:	Off Edge
ANTENNA CONFIGURATION:	N/A	MAX E FIELD:	5.14 V/m
TEST FREQUENCY:	897.4MHz	SAR 1g:	N/A
AIR FACTORS:	421 / 374 / 405	SAR 10g:	N/A
CONVERSION FACTORS:	0.278 / 0.278 / 0.278	SAR START:	N/A
TYPE OF MODULATION:	GMSK (GPRS Mode)	SAR END:	N/A
MODN. DUTY CYCLE:	25.0 %	SAR DRIFT DURING SCAN:	0.00 %
DIODE COMPRESSION FACTORS (V*200):	20 / 20 / 20	PROBE BATTERY LAST CHANGED:	29/07/2008
INPUT POWER LEVEL:	33 dBm	EXTRAPOLATION:	poly4

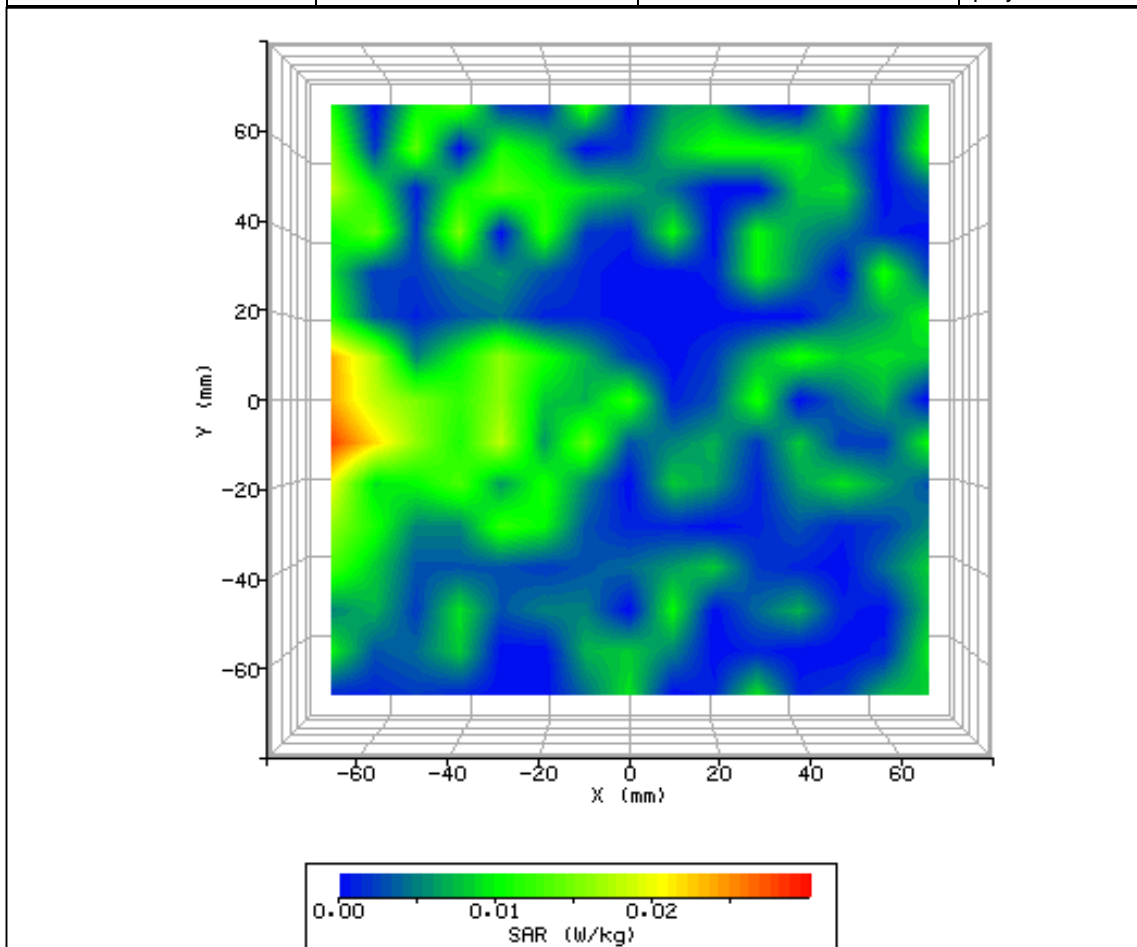

Figure 15: SAR Body Testing Results for the Ericsson Mobile Broadband Module in Screen 90° - Area 2 Phantom Position; Tested at 897.4MHz (GSM 900 Mid Channel) with 2mm Separation Distance to the Phantom (NUA).

SYSTEM / SOFTWARE:	SARA2 / 2.53 VPM	INPUT POWER DRIFT:	0.0 dB
DATE / TIME:	29/07/2008 12:22:24	DUT BATTERY MODEL/NO:	N/A
FILENAME:	75903561-11a.txt	PROBE SERIAL NUMBER:	0171
AMBIENT TEMPERATURE:	22.30°C	LIQUID SIMULANT:	900Body
DEVICE UNDER TEST:	Ericsson Module	RELATIVE PERMITTIVITY:	57.63
RELATIVE HUMIDITY:	55.20%	CONDUCTIVITY:	1.062
PHANTOM S/NO:	HeadBox.csv	LIQUID TEMPERATURE:	22.50°C
PHANTOM ROTATION:	0°	MAX SAR X-AXIS LOCATION:	4.00mm
DUT POSITION:	Screen 90° - Area 3	MAX SAR Y-AXIS LOCATION:	70.00mm
ANTENNA CONFIGURATION:	N/A	MAX E FIELD:	3.41 V/m
TEST FREQUENCY:	897.4MHz	SAR 1g:	N/A
AIR FACTORS:	421 / 374 / 405	SAR 10g:	N/A
CONVERSION FACTORS:	0.278 / 0.278 / 0.278	SAR START:	N/A
TYPE OF MODULATION:	GMSK (GPRS Mode)	SAR END:	N/A
MODN. DUTY CYCLE:	25.0 %	SAR DRIFT DURING SCAN:	0.00 %
DIODE COMPRESSION FACTORS (V*200):	20 / 20 / 20	PROBE BATTERY LAST CHANGED:	29/07/2008
INPUT POWER LEVEL:	33 dBm	EXTRAPOLATION:	poly4

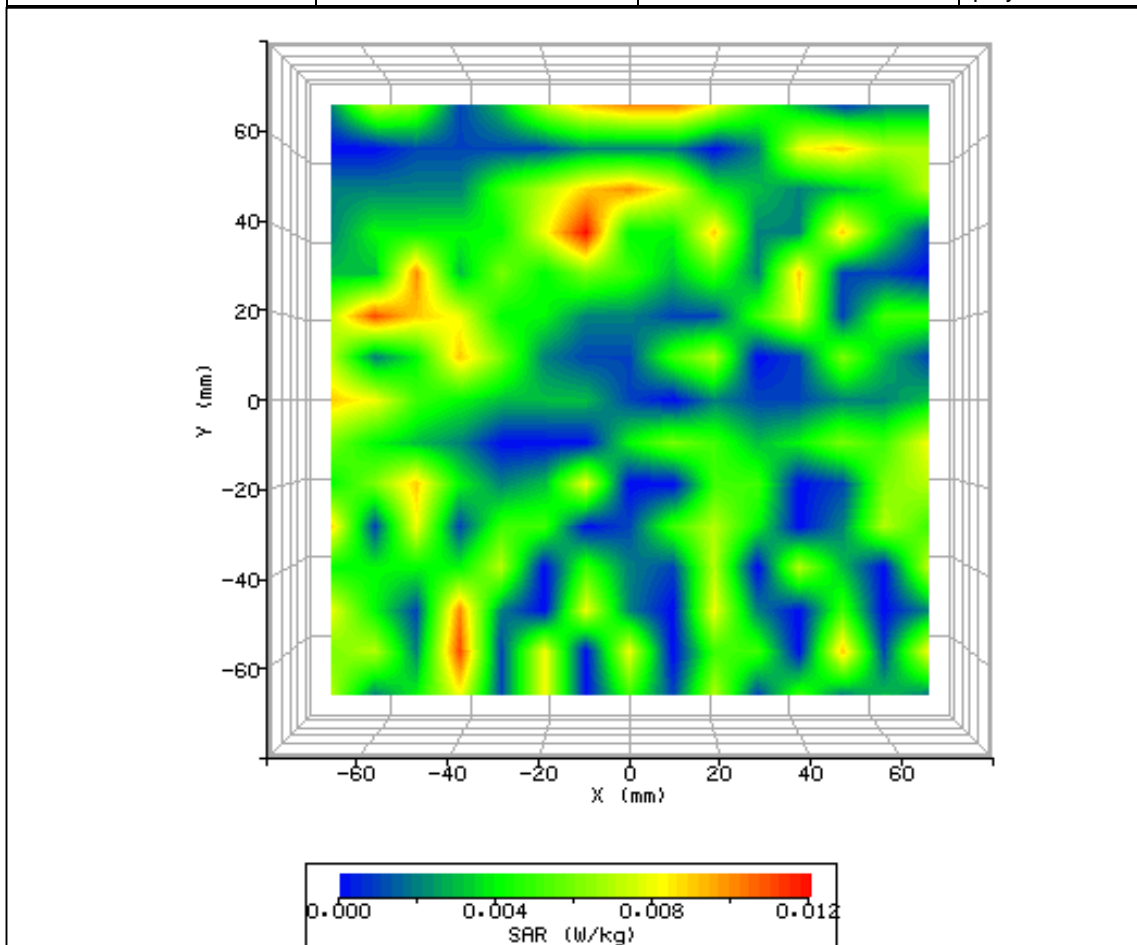

Figure 16: SAR Body Testing Results for the Ericsson Mobile Broadband Module in Screen 90° - Area 3 Phantom Position; Tested at 897.4MHz (GSM 900 Mid Channel) with 2mm Separation Distance to the Phantom (NUA).

SYSTEM / SOFTWARE:	SARA2 / 2.53 VPM	INPUT POWER DRIFT:	0.0 dB
DATE / TIME:	29/07/2008 12:37:58	DUT BATTERY MODEL/NO:	N/A
FILENAME:	75903561-12a.txt	PROBE SERIAL NUMBER:	0171
AMBIENT TEMPERATURE:	22.30°C	LIQUID SIMULANT:	900Body
DEVICE UNDER TEST:	Ericsson Module	RELATIVE PERMITTIVITY:	57.63
RELATIVE HUMIDITY:	54.80%	CONDUCTIVITY:	1.062
PHANTOM S/NO:	HeadBox.csv	LIQUID TEMPERATURE:	22.50°C
PHANTOM ROTATION:	0°	MAX SAR X-AXIS LOCATION:	Off Edge
DUT POSITION:	Screen 90° - Area 4	MAX SAR Y-AXIS LOCATION:	Off Edge
ANTENNA CONFIGURATION:	N/A	MAX E FIELD:	4.67 V/m
TEST FREQUENCY:	897.4MHz	SAR 1g:	N/A
AIR FACTORS:	421 / 374 / 405	SAR 10g:	N/A
CONVERSION FACTORS:	0.278 / 0.278 / 0.278	SAR START:	N/A
TYPE OF MODULATION:	GMSK (GPRS Mode)	SAR END:	N/A
MODN. DUTY CYCLE:	25.0 %	SAR DRIFT DURING SCAN:	0.00 %
DIODE COMPRESSION FACTORS (V*200):	20 / 20 / 20	PROBE BATTERY LAST CHANGED:	29/07/2008
INPUT POWER LEVEL:	33 dBm	EXTRAPOLATION:	poly4

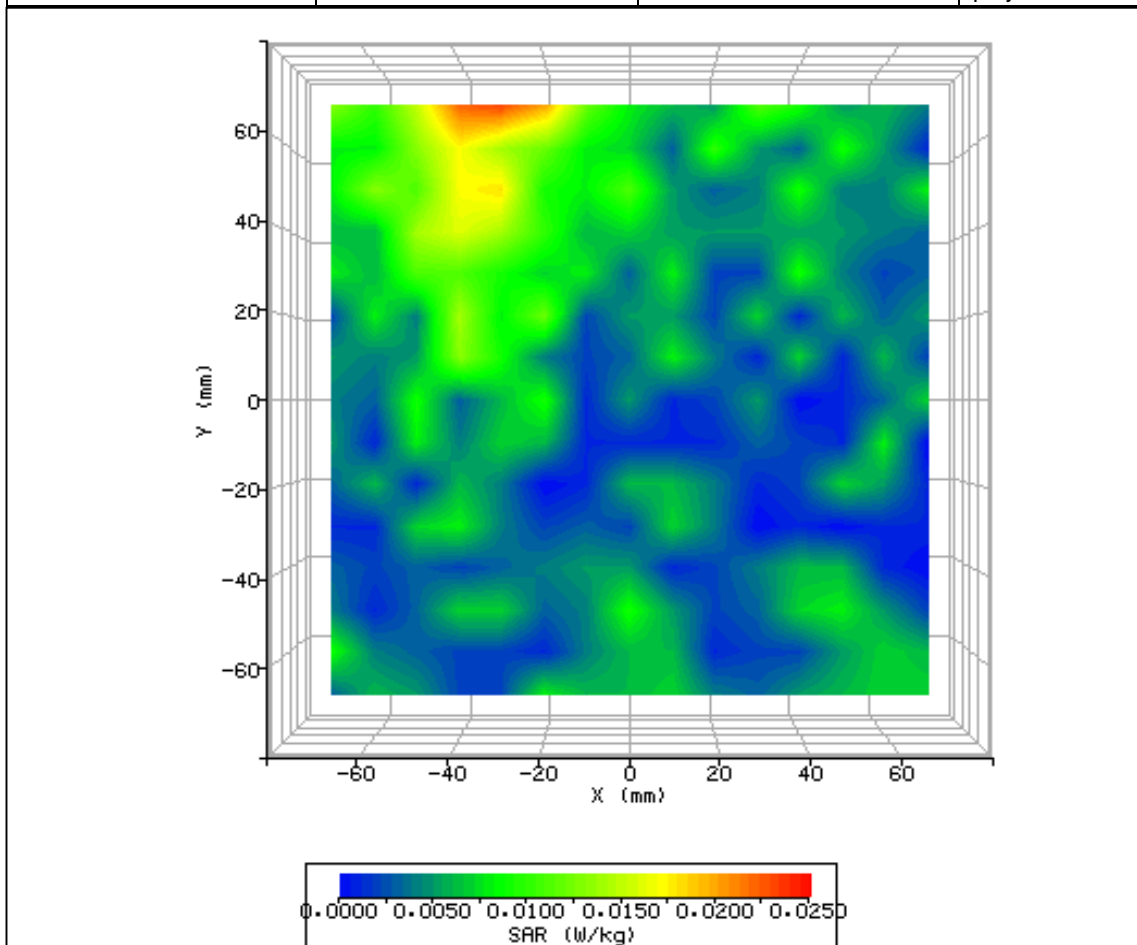

Figure 17: SAR Body Testing Results for the Ericsson Mobile Broadband Module in Screen 90° - Area 4 Phantom Position; Tested at 897.4MHz (GSM 900 Mid Channel) with 2mm Separation Distance to the Phantom (NUA).

SYSTEM / SOFTWARE:	SARA2 / 2.53 VPM	INPUT POWER DRIFT:	0.0 dB
DATE / TIME:	29/07/2008 14:26:01	DUT BATTERY MODEL/NO:	N/A
FILENAME:	75903561-13a.txt	PROBE SERIAL NUMBER:	0171
AMBIENT TEMPERATURE:	22.40°C	LIQUID SIMULANT:	900Body
DEVICE UNDER TEST:	Ericsson Module	RELATIVE PERMITTIVITY:	57.63
RELATIVE HUMIDITY:	53.70%	CONDUCTIVITY:	1.062
PHANTOM S/NO:	HeadBox.csv	LIQUID TEMPERATURE:	22.50°C
PHANTOM ROTATION:	0°	MAX SAR X-AXIS LOCATION:	Off Edge
DUT POSITION:	Screen 90° - Area 5	MAX SAR Y-AXIS LOCATION:	Off Edge
ANTENNA CONFIGURATION:	N/A	MAX E FIELD:	3.98 V/m
TEST FREQUENCY:	897.4MHz	SAR 1g:	N/A
AIR FACTORS:	421 / 374 / 405	SAR 10g:	N/A
CONVERSION FACTORS:	0.278 / 0.278 / 0.278	SAR START:	N/A
TYPE OF MODULATION:	GMSK (GPRS Mode)	SAR END:	N/A
MODN. DUTY CYCLE:	25.0 %	SAR DRIFT DURING SCAN:	0.00 %
DIODE COMPRESSION FACTORS (V*200):	20 / 20 / 20	PROBE BATTERY LAST CHANGED:	29/07/2008
INPUT POWER LEVEL:	33 dBm	EXTRAPOLATION:	poly4

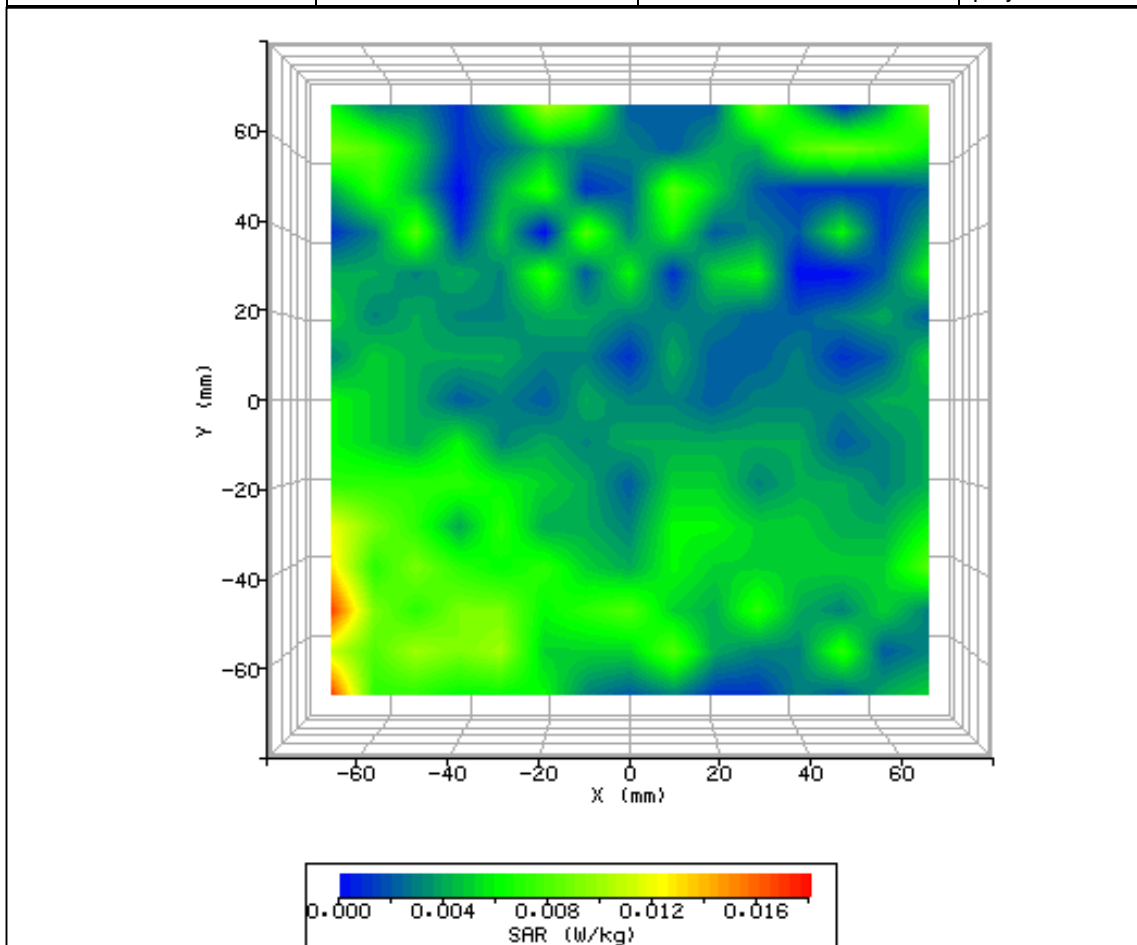

Figure 18: SAR Body Testing Results for the Ericsson Mobile Broadband Module in Screen 90° - Area 5 Phantom Position; Tested at 897.4MHz (GSM 900 Mid Channel) with 2mm Separation Distance to the Phantom (NUA).

SYSTEM / SOFTWARE:	SARA2 / 2.53 VPM	INPUT POWER DRIFT:	0.0 dB
DATE / TIME:	29/07/2008 14:16:07	DUT BATTERY MODEL/NO:	N/A
FILENAME:	75903561-14a.txt	PROBE SERIAL NUMBER:	0171
AMBIENT TEMPERATURE:	22.40°C	LIQUID SIMULANT:	900Body
DEVICE UNDER TEST:	Ericsson Module	RELATIVE PERMITTIVITY:	57.63
RELATIVE HUMIDITY:	53.00%	CONDUCTIVITY:	1.062
PHANTOM S/NO:	HeadBox.csv	LIQUID TEMPERATURE:	22.50°C
PHANTOM ROTATION:	0°	MAX SAR X-AXIS LOCATION:	Off Edge
DUT POSITION:	Screen 90° - Area 6	MAX SAR Y-AXIS LOCATION:	Off Edge
ANTENNA CONFIGURATION:	N/A	MAX E FIELD:	2.42 V/m
TEST FREQUENCY:	897.4MHz	SAR 1g:	N/A
AIR FACTORS:	421 / 374 / 405	SAR 10g:	N/A
CONVERSION FACTORS:	0.278 / 0.278 / 0.278	SAR START:	N/A
TYPE OF MODULATION:	GMSK (GPRS Mode)	SAR END:	N/A
MODN. DUTY CYCLE:	25.0 %	SAR DRIFT DURING SCAN:	0.00 %
DIODE COMPRESSION FACTORS (V*200):	20 / 20 / 20	PROBE BATTERY LAST CHANGED:	29/07/2008
INPUT POWER LEVEL:	33 dBm	EXTRAPOLATION:	poly4

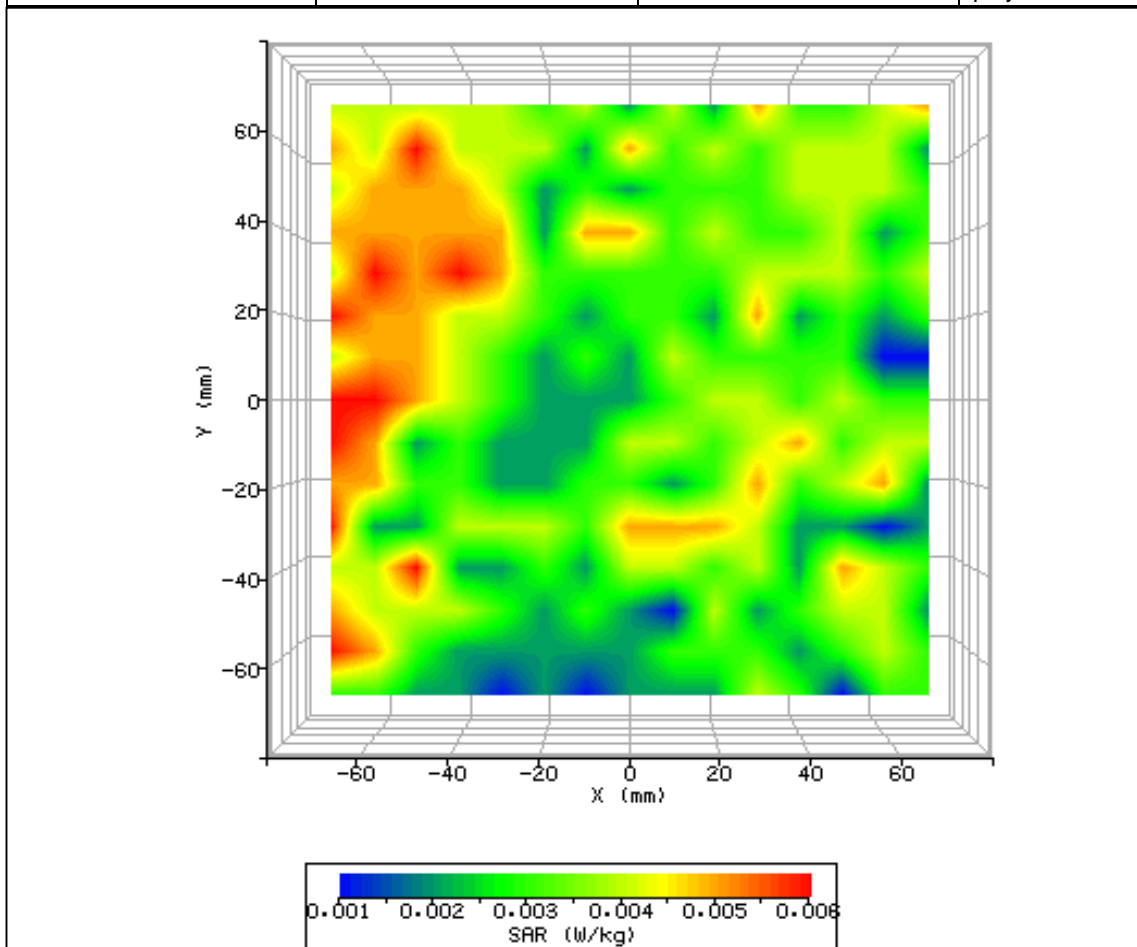

Figure 19: SAR Body Testing Results for the Ericsson Mobile Broadband Module in Screen 90° - Area 6 Phantom Position; Tested at 897.4MHz (GSM 900 Mid Channel) with 2mm Separation Distance to the Phantom (NUA).

SYSTEM / SOFTWARE:	SARA2 / 2.53 VPM	INPUT POWER DRIFT:	0.0 dB
DATE / TIME:	29/07/2008 15:06:06	DUT BATTERY MODEL/NO:	N/A
FILENAME:	75903561-15.txt	PROBE SERIAL NUMBER:	0171
AMBIENT TEMPERATURE:	22.50°C	LIQUID SIMULANT:	900Body
DEVICE UNDER TEST:	Ericsson Module	RELATIVE PERMITTIVITY:	57.63
RELATIVE HUMIDITY:	52.50%	CONDUCTIVITY:	1.062
PHANTOM S/NO:	HeadBox.csv	LIQUID TEMPERATURE:	22.50°C
PHANTOM ROTATION:	0°	MAX SAR X-AXIS LOCATION:	-29.00mm
DUT POSITION:	Screen 90° - Area 1	MAX SAR Y-AXIS LOCATION:	14.00mm
ANTENNA CONFIGURATION:	N/A	MAX E FIELD:	4.56 V/m
TEST FREQUENCY:	897.4MHz	SAR 1g:	0.028 W/kg
AIR FACTORS:	421 / 374 / 405	SAR 10g:	0.019 W/kg
CONVERSION FACTORS:	0.278 / 0.278 / 0.278	SAR START:	0.009 W/kg
TYPE OF MODULATION:	8-PSK (EGPRS Mode)	SAR END:	0.008 W/kg
MODN. DUTY CYCLE:	25.0 %	SAR DRIFT DURING SCAN:	0.00 %
DIODE COMPRESSION FACTORS (V*200):	20 / 20 / 20	PROBE BATTERY LAST CHANGED:	29/07/2008
INPUT POWER LEVEL:	27 dBm	EXTRAPOLATION:	poly4

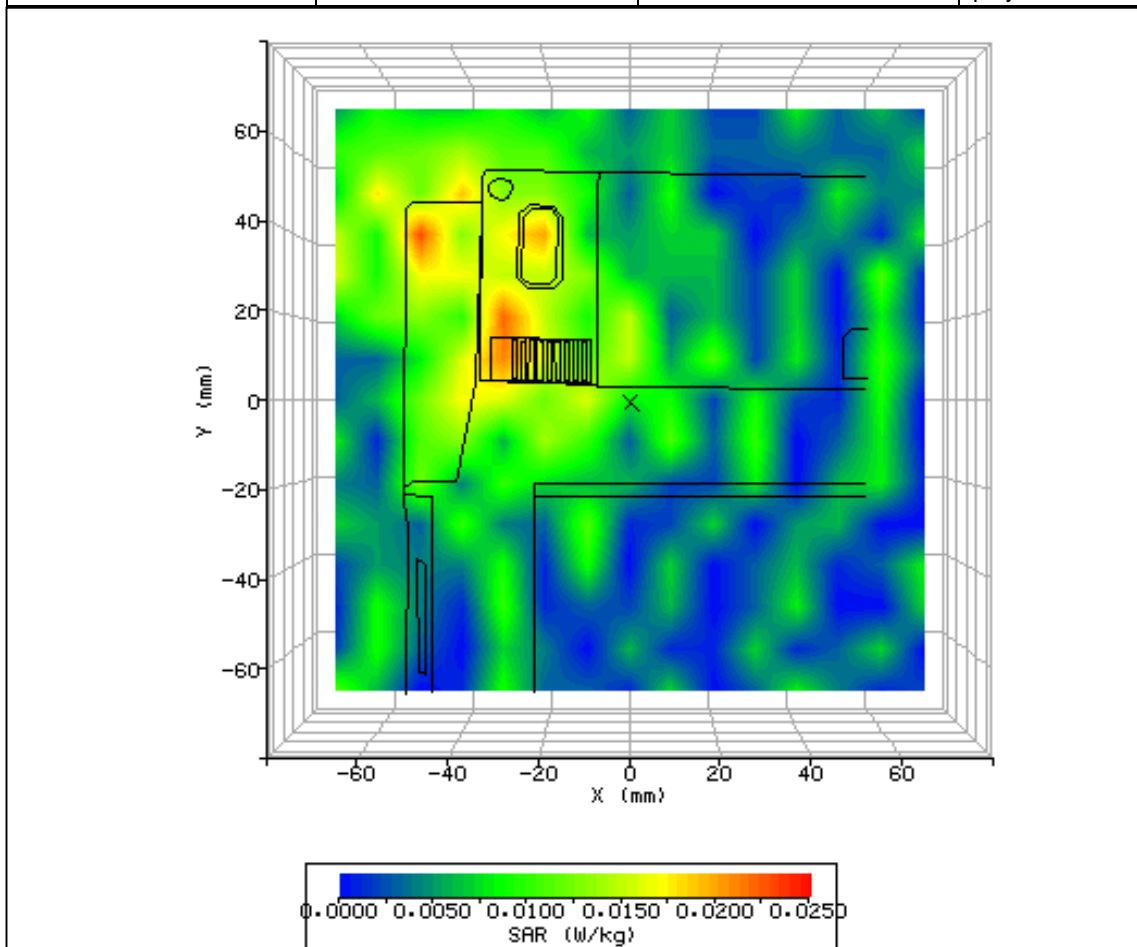

Figure 20: SAR Body Testing Results for the Ericsson Mobile Broadband Module in Screen 90° - Area 1 Phantom Position; Tested at 897.4MHz (GSM 900 Mid Channel) with 2mm Separation Distance to the Phantom (NUA).

2.5 GSM 1800 BODY SAR TEST RESULTS AND COURSE AREA SCANS – 2D

SYSTEM / SOFTWARE:	SARA2 / 2.53 VPM	INPUT POWER DRIFT:	0.0 dB
DATE / TIME:	04/08/2008 14:46:34	DUT BATTERY MODEL/NO:	N/A
FILENAME:	75903561-16.txt	PROBE SERIAL NUMBER:	0171
AMBIENT TEMPERATURE:	21.50°C	LIQUID SIMULANT:	1800Body
DEVICE UNDER TEST:	Ericsson Module	RELATIVE PERMITTIVITY:	54.07
RELATIVE HUMIDITY:	57.20%	CONDUCTIVITY:	1.576
PHANTOM S/NO:	HeadBox.csv	LIQUID TEMPERATURE:	21.50°C
PHANTOM ROTATION:	0°	MAX SAR X-AXIS LOCATION:	-40.00mm
DUT POSITION:	Screen 90° - Area 1	MAX SAR Y-AXIS LOCATION:	37.00mm
ANTENNA CONFIGURATION:	N/A	MAX E FIELD:	8.13 V/m
TEST FREQUENCY:	1747.4MHz	SAR 1g:	0.106 W/kg
AIR FACTORS:	421 / 374 / 405	SAR 10g:	0.069 W/kg
CONVERSION FACTORS:	0.278 / 0.278 / 0.278	SAR START:	0.026 W/kg
TYPE OF MODULATION:	GMSK (GPRS Mode)	SAR END:	0.026 W/kg
MODN. DUTY CYCLE:	25.0 %	SAR DRIFT DURING SCAN:	-1.63 %
DIODE COMPRESSION FACTORS (V*200):	20 / 20 / 20	PROBE BATTERY LAST CHANGED:	04/08/2008
INPUT POWER LEVEL:	30 dBm	EXTRAPOLATION:	poly4

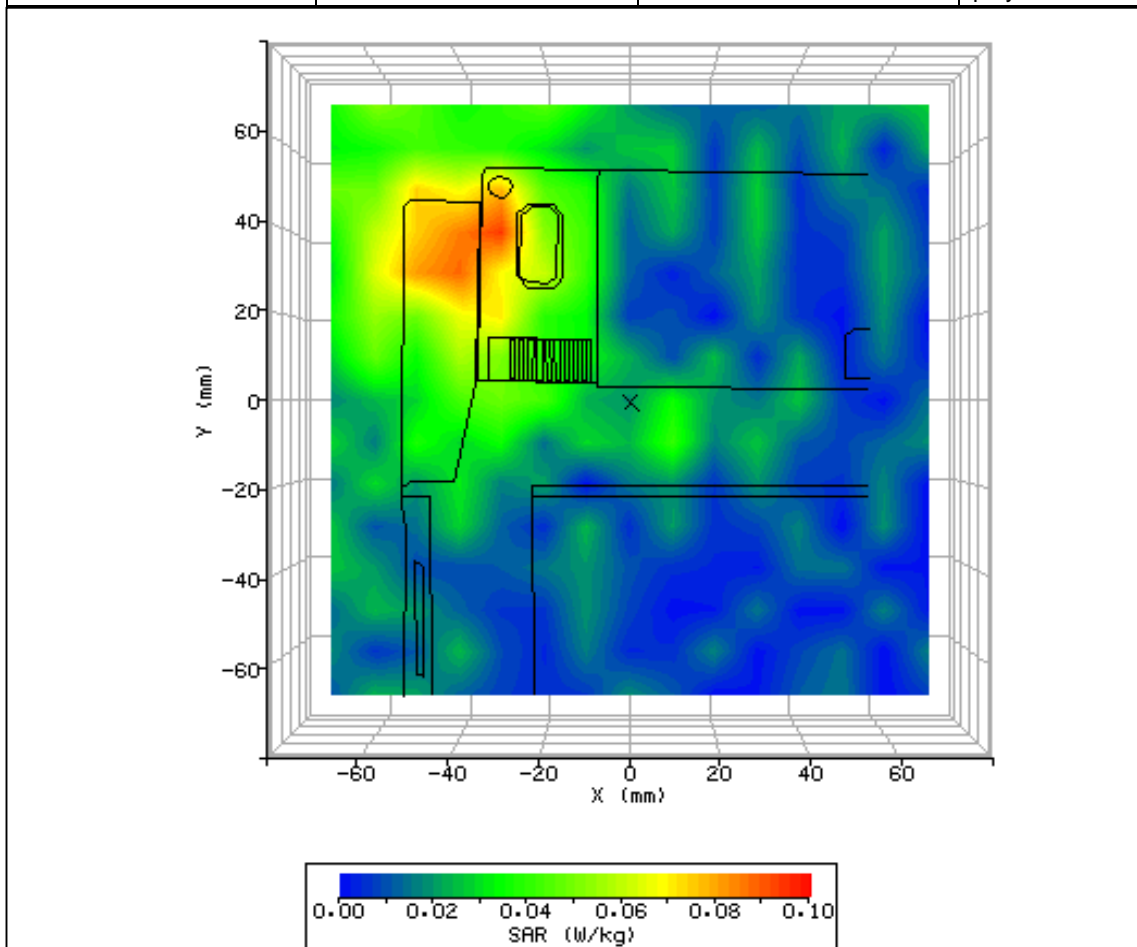

Figure 21: SAR Body Testing Results for the Ericsson Mobile Broadband Module in Screen 90° - Area 1 Phantom Position; Tested at 1747.4MHz (GSM 1800 Mid Channel) with 2mm Separation Distance to the Phantom (NUA).

SYSTEM / SOFTWARE:	SARA2 / 2.53 VPM	INPUT POWER DRIFT:	0.0 dB
DATE / TIME:	04/08/2008 15:15:23	DUT BATTERY MODEL/NO:	N/A
FILENAME:	75903561-17a.txt	PROBE SERIAL NUMBER:	0171
AMBIENT TEMPERATURE:	21.40°C	LIQUID SIMULANT:	1800Body
DEVICE UNDER TEST:	Ericsson Module	RELATIVE PERMITTIVITY:	54.07
RELATIVE HUMIDITY:	56.80%	CONDUCTIVITY:	1.576
PHANTOM S/NO:	HeadBox.csv	LIQUID TEMPERATURE:	21.50°C
PHANTOM ROTATION:	0°	MAX SAR X-AXIS LOCATION:	Off Edge
DUT POSITION:	Screen 90° - Area 2	MAX SAR Y-AXIS LOCATION:	Off Edge
ANTENNA CONFIGURATION:	N/A	MAX E FIELD:	4.36 V/m
TEST FREQUENCY:	1747.4MHz	SAR 1g:	N/A
AIR FACTORS:	421 / 374 / 405	SAR 10g:	N/A
CONVERSION FACTORS:	0.278 / 0.278 / 0.278	SAR START:	N/A
TYPE OF MODULATION:	GMSK (GPRS Mode)	SAR END:	N/A
MODN. DUTY CYCLE:	25.0 %	SAR DRIFT DURING SCAN:	0.00 %
DIODE COMPRESSION FACTORS (V*200):	20 / 20 / 20	PROBE BATTERY LAST CHANGED:	04/08/2008
INPUT POWER LEVEL:	30 dBm	EXTRAPOLATION:	poly4

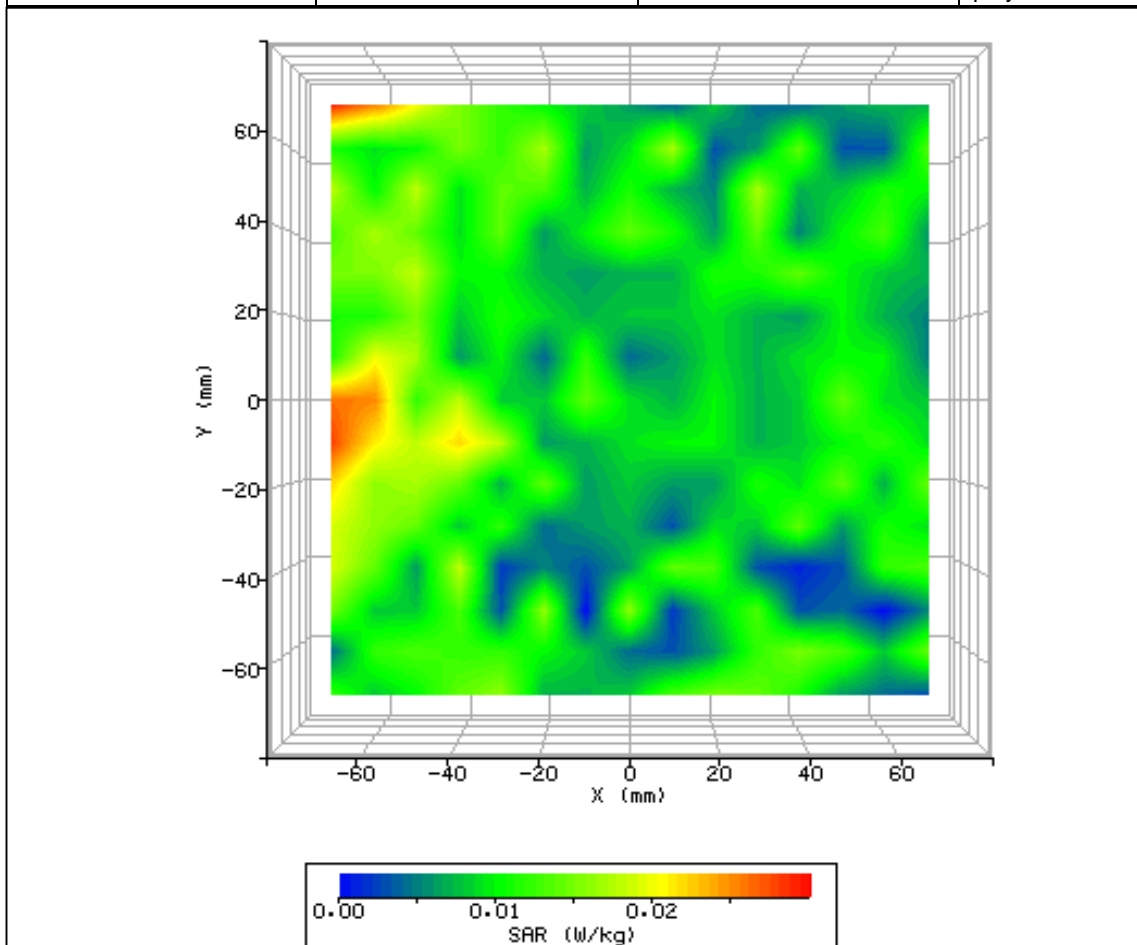

Figure 22: SAR Body Testing Results for the Ericsson Mobile Broadband Module in Screen 90° - Area 2 Phantom Position; Tested at 1747.4MHz (GSM 1800 Mid Channel) with 2mm Separation Distance to the Phantom (NUA).



SYSTEM / SOFTWARE:	SARA2 / 2.53 VPM	INPUT POWER DRIFT:	0.0 dB
DATE / TIME:	04/08/2008 15:28:14	DUT BATTERY MODEL/NO:	N/A
FILENAME:	75903561-18a.txt	PROBE SERIAL NUMBER:	0171
AMBIENT TEMPERATURE:	21.50°C	LIQUID SIMULANT:	1800Body
DEVICE UNDER TEST:	Ericsson Module	RELATIVE PERMITTIVITY:	54.07
RELATIVE HUMIDITY:	56.10%	CONDUCTIVITY:	1.576
PHANTOM S/NO:	HeadBox.csv	LIQUID TEMPERATURE:	21.50°C
PHANTOM ROTATION:	0°	MAX SAR X-AXIS LOCATION:	-70.000mm
DUT POSITION:	Screen 90° - Area 3	MAX SAR Y-AXIS LOCATION:	-70.000mm
ANTENNA CONFIGURATION:	N/A	MAX E FIELD:	3.61 V/m
TEST FREQUENCY:	1747.4MHz	SAR 1g:	N/A
AIR FACTORS:	421 / 374 / 405	SAR 10g:	N/A
CONVERSION FACTORS:	0.278 / 0.278 / 0.278	SAR START:	N/A
TYPE OF MODULATION:	GMSK (GPRS Mode)	SAR END:	N/A
MODN. DUTY CYCLE:	25.0 %	SAR DRIFT DURING SCAN:	0.00 %
DIODE COMPRESSION FACTORS (V*200):	20 / 20 / 20	PROBE BATTERY LAST CHANGED:	04/08/2008
INPUT POWER LEVEL:	30 dBm	EXTRAPOLATION:	poly4

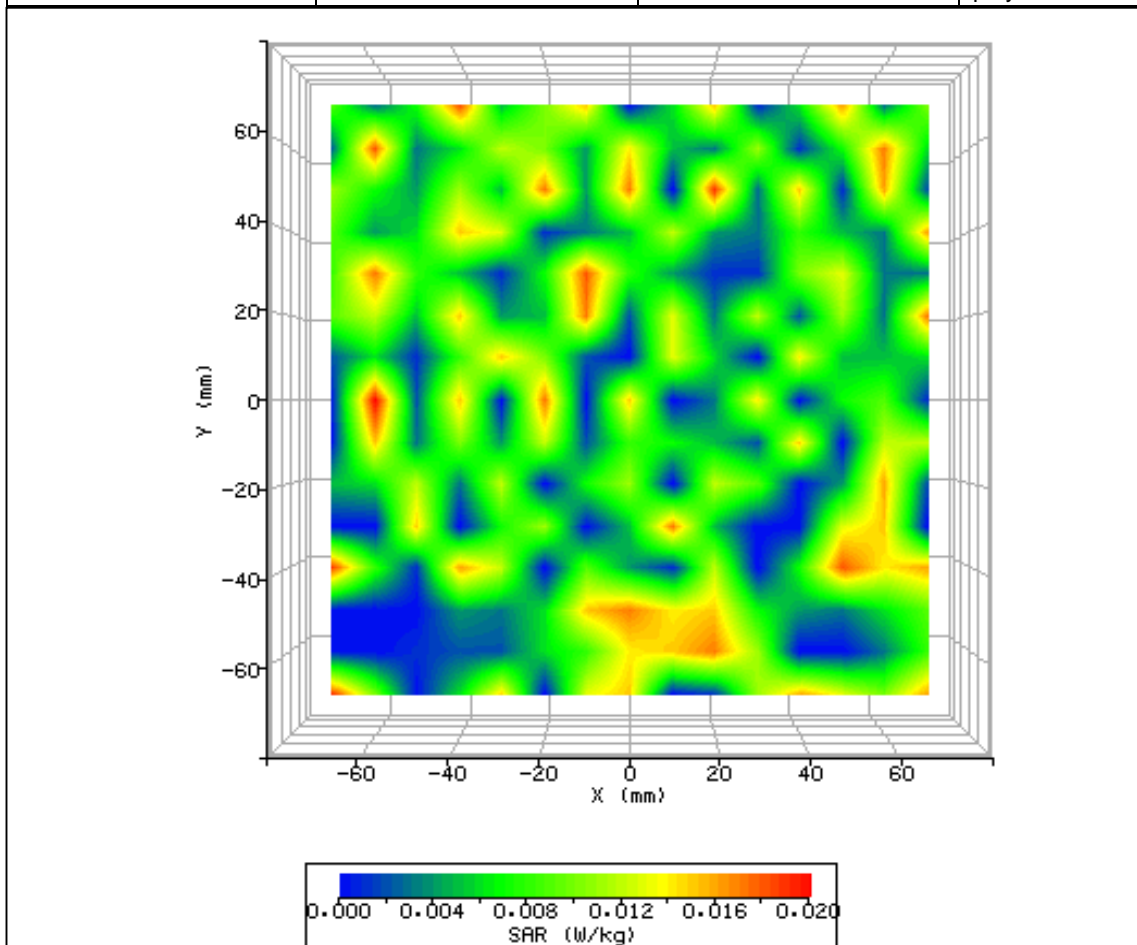

Figure 23: SAR Body Testing Results for the Ericsson Mobile Broadband Module in Screen 90° - Area 3 Phantom Position; Tested at 1747.4MHz (GSM 1800 Mid Channel) with 2mm Separation Distance to the Phantom (NUA).

SYSTEM / SOFTWARE:	SARA2 / 2.53 VPM	INPUT POWER DRIFT:	0.0 dB
DATE / TIME:	04/08/2008 15:38:49	DUT BATTERY MODEL/NO:	N/A
FILENAME:	75903561-19a.txt	PROBE SERIAL NUMBER:	0171
AMBIENT TEMPERATURE:	21.50°C	LIQUID SIMULANT:	1800Body
DEVICE UNDER TEST:	Ericsson Module	RELATIVE PERMITTIVITY:	54.07
RELATIVE HUMIDITY:	55.20%	CONDUCTIVITY:	1.576
PHANTOM S/NO:	HeadBox.csv	LIQUID TEMPERATURE:	21.50°C
PHANTOM ROTATION:	0°	MAX SAR X-AXIS LOCATION:	-33.00mm
DUT POSITION:	Screen 90° - Area 4	MAX SAR Y-AXIS LOCATION:	44.00mm
ANTENNA CONFIGURATION:	N/A	MAX E FIELD:	4.62 V/m
TEST FREQUENCY:	1747.4MHz	SAR 1g:	N/A
AIR FACTORS:	421 / 374 / 405	SAR 10g:	N/A
CONVERSION FACTORS:	0.278 / 0.278 / 0.278	SAR START:	N/A
TYPE OF MODULATION:	GMSK (GPRS Mode)	SAR END:	N/A
MODN. DUTY CYCLE:	25.0 %	SAR DRIFT DURING SCAN:	0.00 %
DIODE COMPRESSION FACTORS (V*200):	20 / 20 / 20	PROBE BATTERY LAST CHANGED:	04/08/2008
INPUT POWER LEVEL:	30 dBm	EXTRAPOLATION:	poly4

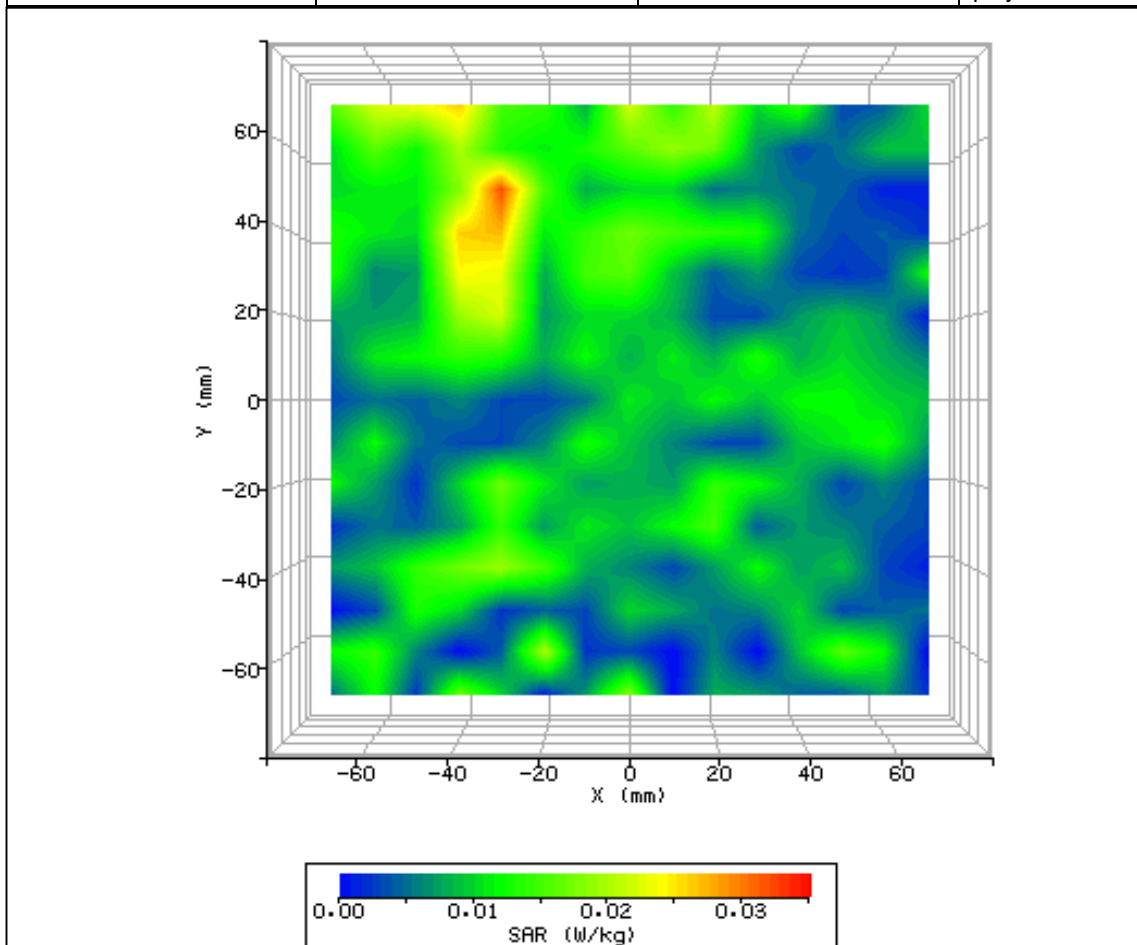

Figure 24: SAR Body Testing Results for the Ericsson Mobile Broadband Module in Screen 90° - Area 4 Phantom Position; Tested at 1747.4MHz (GSM 1800 Mid Channel) with 2mm Separation Distance to the Phantom (NUA).

SYSTEM / SOFTWARE:	SARA2 / 2.53 VPM	INPUT POWER DRIFT:	0.0 dB
DATE / TIME:	04/08/2008 15:51:33	DUT BATTERY MODEL/NO:	N/A
FILENAME:	75903561-20a.txt	PROBE SERIAL NUMBER:	0171
AMBIENT TEMPERATURE:	21.60°C	LIQUID SIMULANT:	1800Body
DEVICE UNDER TEST:	Ericsson Module	RELATIVE PERMITTIVITY:	54.07
RELATIVE HUMIDITY:	55.40%	CONDUCTIVITY:	1.576
PHANTOM S/NO:	HeadBox.csv	LIQUID TEMPERATURE:	21.50°C
PHANTOM ROTATION:	0°	MAX SAR X-AXIS LOCATION:	70.00mm
DUT POSITION:	Screen 90° - Area 5	MAX SAR Y-AXIS LOCATION:	70.00mm
ANTENNA CONFIGURATION:	N/A	MAX E FIELD:	3.58 V/m
TEST FREQUENCY:	1747.4MHz	SAR 1g:	N/A
AIR FACTORS:	421 / 374 / 405	SAR 10g:	N/A
CONVERSION FACTORS:	0.278 / 0.278 / 0.278	SAR START:	N/A
TYPE OF MODULATION:	GMSK (GPRS Mode)	SAR END:	N/A
MODN. DUTY CYCLE:	25.0 %	SAR DRIFT DURING SCAN:	0.00 %
DIODE COMPRESSION FACTORS (V*200):	20 / 20 / 20	PROBE BATTERY LAST CHANGED:	04/08/2008
INPUT POWER LEVEL:	30 dBm	EXTRAPOLATION:	poly4

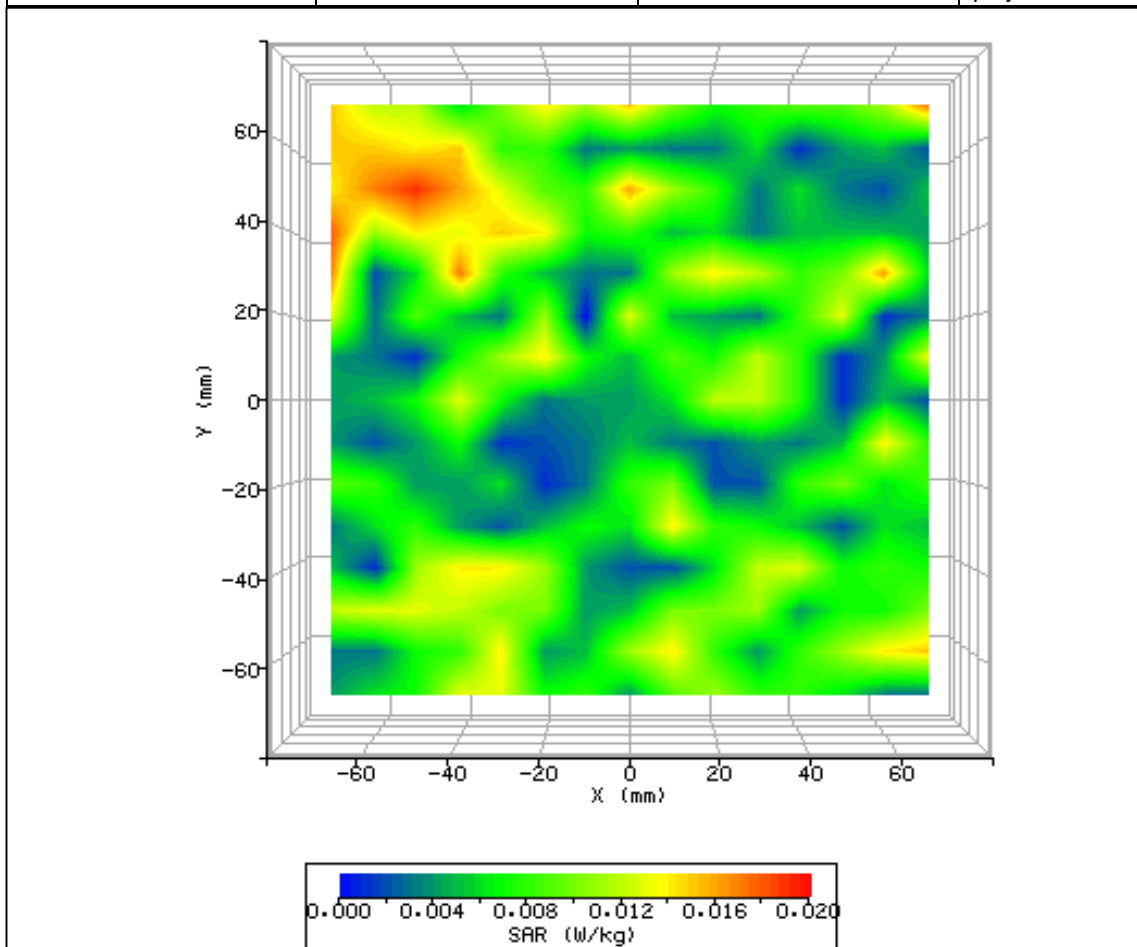

Figure 25: SAR Body Testing Results for the Ericsson Mobile Broadband Module in Screen 90° - Area 5 Phantom Position; Tested at 1747.4MHz (GSM 1800 Mid Channel) with 2mm Separation Distance to the Phantom (NUA).

SYSTEM / SOFTWARE:	SARA2 / 2.53 VPM	INPUT POWER DRIFT:	0.0 dB
DATE / TIME:	04/08/2008 16:01:07	DUT BATTERY MODEL/NO:	N/A
FILENAME:	75903561-21a.txt	PROBE SERIAL NUMBER:	0171
AMBIENT TEMPERATURE:	21.60°C	LIQUID SIMULANT:	1800Body
DEVICE UNDER TEST:	Ericsson Module	RELATIVE PERMITTIVITY:	54.07
RELATIVE HUMIDITY:	55.80%	CONDUCTIVITY:	1.576
PHANTOM S/NO:	HeadBox.csv	LIQUID TEMPERATURE:	21.50°C
PHANTOM ROTATION:	0°	MAX SAR X-AXIS LOCATION:	70.00mm
DUT POSITION:	Screen 90° - Area 6	MAX SAR Y-AXIS LOCATION:	70.00mm
ANTENNA CONFIGURATION:	N/A	MAX E FIELD:	3.10 V/m
TEST FREQUENCY:	1747.4MHz	SAR 1g:	N/A
AIR FACTORS:	421 / 374 / 405	SAR 10g:	N/A
CONVERSION FACTORS:	0.278 / 0.278 / 0.278	SAR START:	N/A
TYPE OF MODULATION:	GMSK (GPRS Mode)	SAR END:	N/A
MODN. DUTY CYCLE:	25.0 %	SAR DRIFT DURING SCAN:	0.00 %
DIODE COMPRESSION FACTORS (V*200):	20 / 20 / 20	PROBE BATTERY LAST CHANGED:	04/08/2008
INPUT POWER LEVEL:	30 dBm	EXTRAPOLATION:	poly4

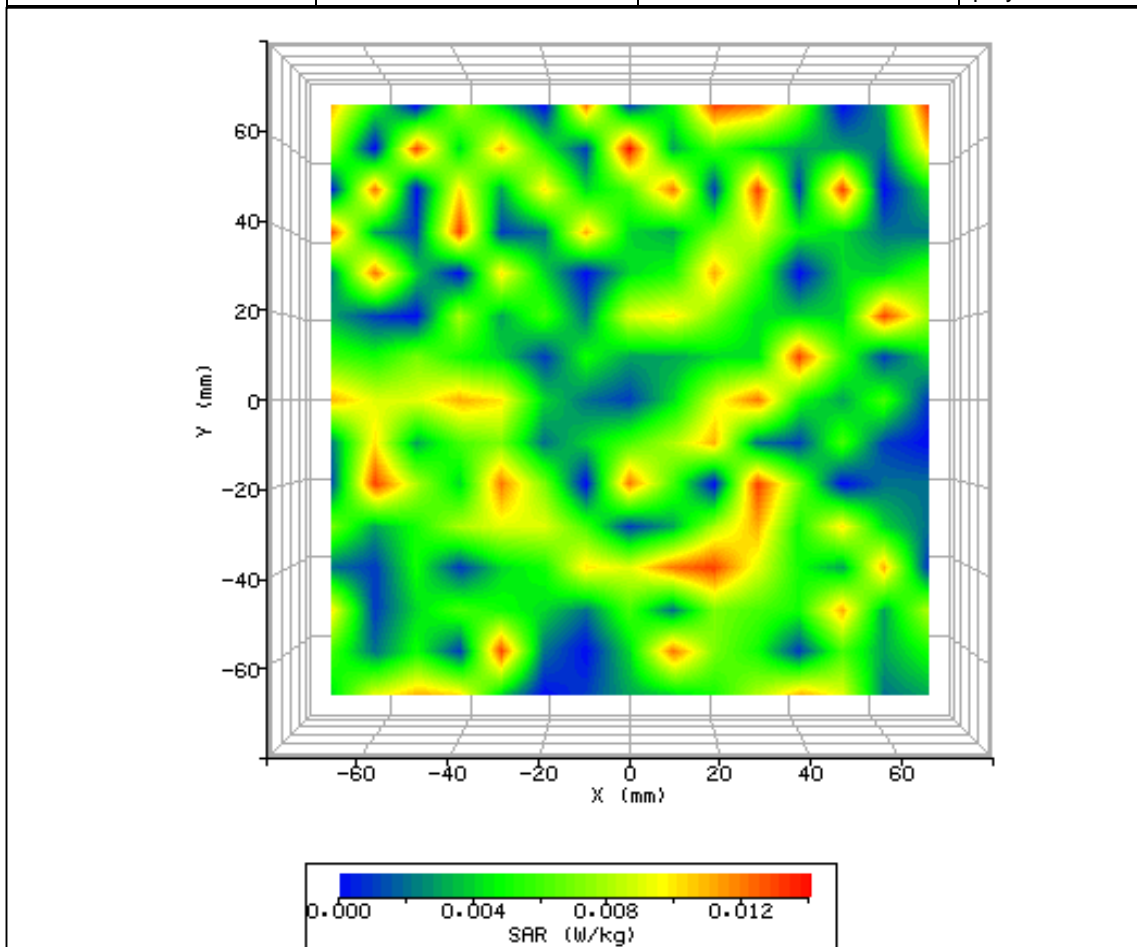

Figure 26: SAR Body Testing Results for the Ericsson Mobile Broadband Module in Screen 90° - Area 6 Phantom Position; Tested at 1747.4MHz (GSM 1800 Mid Channel) with 2mm Separation Distance to the Phantom (NUA).

SYSTEM / SOFTWARE:	SARA2 / 2.53 VPM	INPUT POWER DRIFT:	0.0 dB
DATE / TIME:	04/08/2008 16:31:12	DUT BATTERY MODEL/NO:	N/A
FILENAME:	75903561-22.txt	PROBE SERIAL NUMBER:	0171
AMBIENT TEMPERATURE:	21.60°C	LIQUID SIMULANT:	1800Body
DEVICE UNDER TEST:	Ericsson Module	RELATIVE PERMITTIVITY:	54.07
RELATIVE HUMIDITY:	55.70%	CONDUCTIVITY:	1.576
PHANTOM S/NO:	HeadBox.csv	LIQUID TEMPERATURE:	21.50°C
PHANTOM ROTATION:	0°	MAX SAR X-AXIS LOCATION:	-36.00mm
DUT POSITION:	Screen 90° - Area 1	MAX SAR Y-AXIS LOCATION:	33.00mm
ANTENNA CONFIGURATION:	N/A	MAX E FIELD:	6.11 V/m
TEST FREQUENCY:	1747.4MHz	SAR 1g:	0.061 W/kg
AIR FACTORS:	421 / 374 / 405	SAR 10g:	0.040 W/kg
CONVERSION FACTORS:	0.278 / 0.278 / 0.278	SAR START:	0.017 W/kg
TYPE OF MODULATION:	8-PSK (EGPRS Mode)	SAR END:	0.016 W/kg
MODN. DUTY CYCLE:	25.0 %	SAR DRIFT DURING SCAN:	-4.42 %
DIODE COMPRESSION FACTORS (V*200):	20 / 20 / 20	PROBE BATTERY LAST CHANGED:	04/08/2008
INPUT POWER LEVEL:	30 dBm	EXTRAPOLATION:	poly4

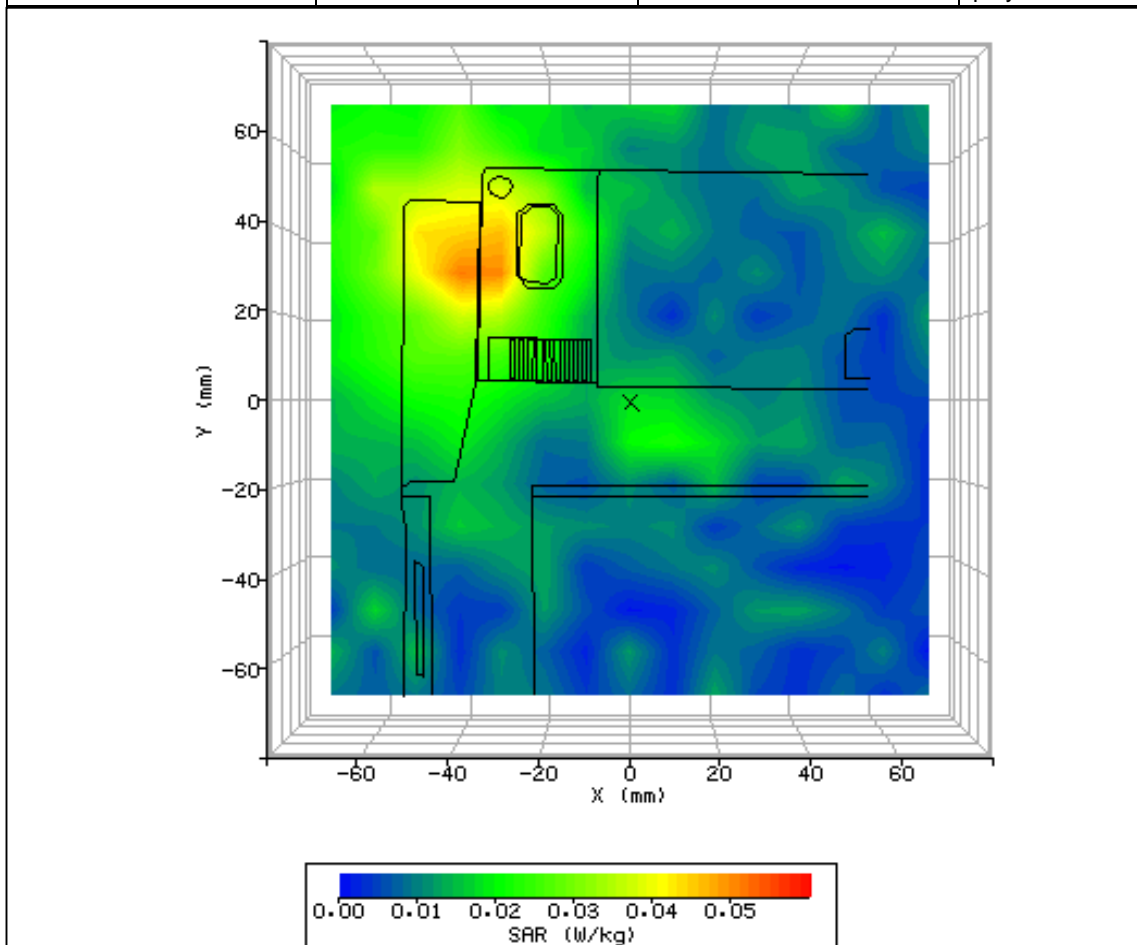

Figure 27: SAR Body Testing Results for the Ericsson Mobile Broadband Module in Screen 90° - Area 1 Phantom Position; Tested at 1747.4MHz (GSM 1800 Mid Channel) with 2mm Separation Distance to the Phantom (NUA).

2.6 GSM 1900 BODY SAR TEST RESULTS AND COURSE AREA SCANS – 2D

SYSTEM / SOFTWARE:	SARA2 / 2.53 VPM	INPUT POWER DRIFT:	0.0 dB
DATE / TIME:	30/07/2008 15:57:03	DUT BATTERY MODEL/NO:	N/A
FILENAME:	75903561-23.txt	PROBE SERIAL NUMBER:	0171
AMBIENT TEMPERATURE:	23.20°C	LIQUID SIMULANT:	1900Body
DEVICE UNDER TEST:	Ericsson Module	RELATIVE PERMITTIVITY:	52.83
RELATIVE HUMIDITY:	42.80%	CONDUCTIVITY:	1.562
PHANTOM S/NO:	HeadBox.csv	LIQUID TEMPERATURE:	22.90°C
PHANTOM ROTATION:	0°	MAX SAR X-AXIS LOCATION:	-36.00mm
DUT POSITION:	Screen 90° - Area 1	MAX SAR Y-AXIS LOCATION:	36.00mm
ANTENNA CONFIGURATION:	N/A	MAX E FIELD:	10.46 V/m
TEST FREQUENCY:	1880MHz	SAR 1g:	0.201 W/kg
AIR FACTORS:	421 / 374 / 405	SAR 10g:	0.124 W/kg
CONVERSION FACTORS:	0.278 / 0.278 / 0.278	SAR START:	0.039 W/kg
TYPE OF MODULATION:	GMSK (GPRS Mode)	SAR END:	0.040 W/kg
MODN. DUTY CYCLE:	25.0 %	SAR DRIFT DURING SCAN:	2.53 %
DIODE COMPRESSION FACTORS (V*200):	20 / 20 / 20	PROBE BATTERY LAST CHANGED:	30/07/2008
INPUT POWER LEVEL:	30 dBm	EXTRAPOLATION:	poly4

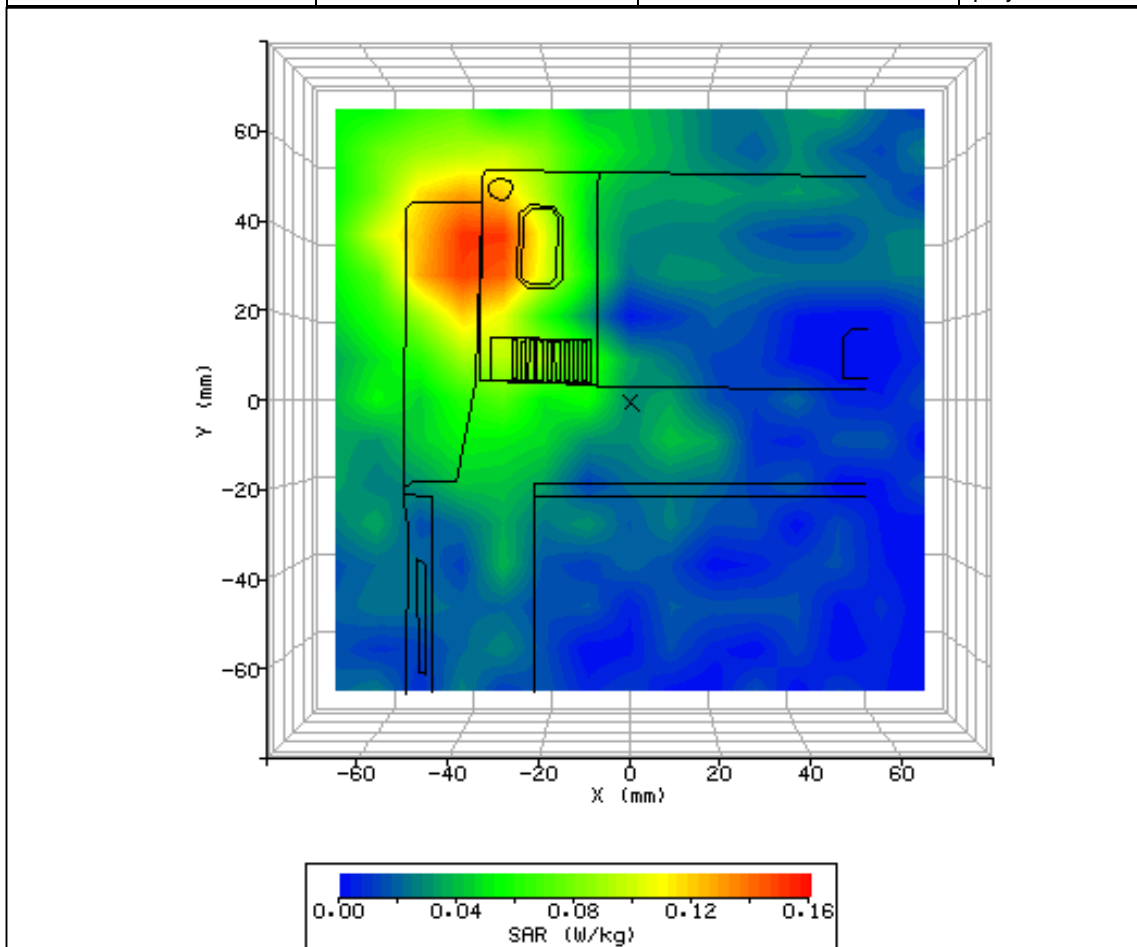

Figure 28: SAR Body Testing Results for the Ericsson Mobile Broadband Module in Screen 90° - Area 1 Phantom Position; Tested at 1880MHz (GSM 1900 Mid Channel) with 2mm Separation Distance to the Phantom (NUA).

SYSTEM / SOFTWARE:	SARA2 / 2.53 VPM	INPUT POWER DRIFT:	0.0 dB
DATE / TIME:	30/07/2008 16:09:16	DUT BATTERY MODEL/NO:	N/A
FILENAME:	75903561-24a.txt	PROBE SERIAL NUMBER:	0171
AMBIENT TEMPERATURE:	23.30°C	LIQUID SIMULANT:	1900Body
DEVICE UNDER TEST:	Ericsson Module	RELATIVE PERMITTIVITY:	52.83
RELATIVE HUMIDITY:	42.50%	CONDUCTIVITY:	1.562
PHANTOM S/NO:	HeadBox.csv	LIQUID TEMPERATURE:	22.90°C
PHANTOM ROTATION:	0°	MAX SAR X-AXIS LOCATION:	Off Edge
DUT POSITION:	Screen 90° - Area 2	MAX SAR Y-AXIS LOCATION:	Off Edge
ANTENNA CONFIGURATION:	N/A	MAX E FIELD:	5.48 V/m
TEST FREQUENCY:	1880MHz	SAR 1g:	N/A
AIR FACTORS:	421 / 374 / 405	SAR 10g:	N/A
CONVERSION FACTORS:	0.278 / 0.278 / 0.278	SAR START:	N/A
TYPE OF MODULATION:	GMSK (GPRS Mode)	SAR END:	N/A
MODN. DUTY CYCLE:	25.0 %	SAR DRIFT DURING SCAN:	0.00 %
DIODE COMPRESSION FACTORS (V*200):	20 / 20 / 20	PROBE BATTERY LAST CHANGED:	30/07/2008
INPUT POWER LEVEL:	30 dBm	EXTRAPOLATION:	poly4

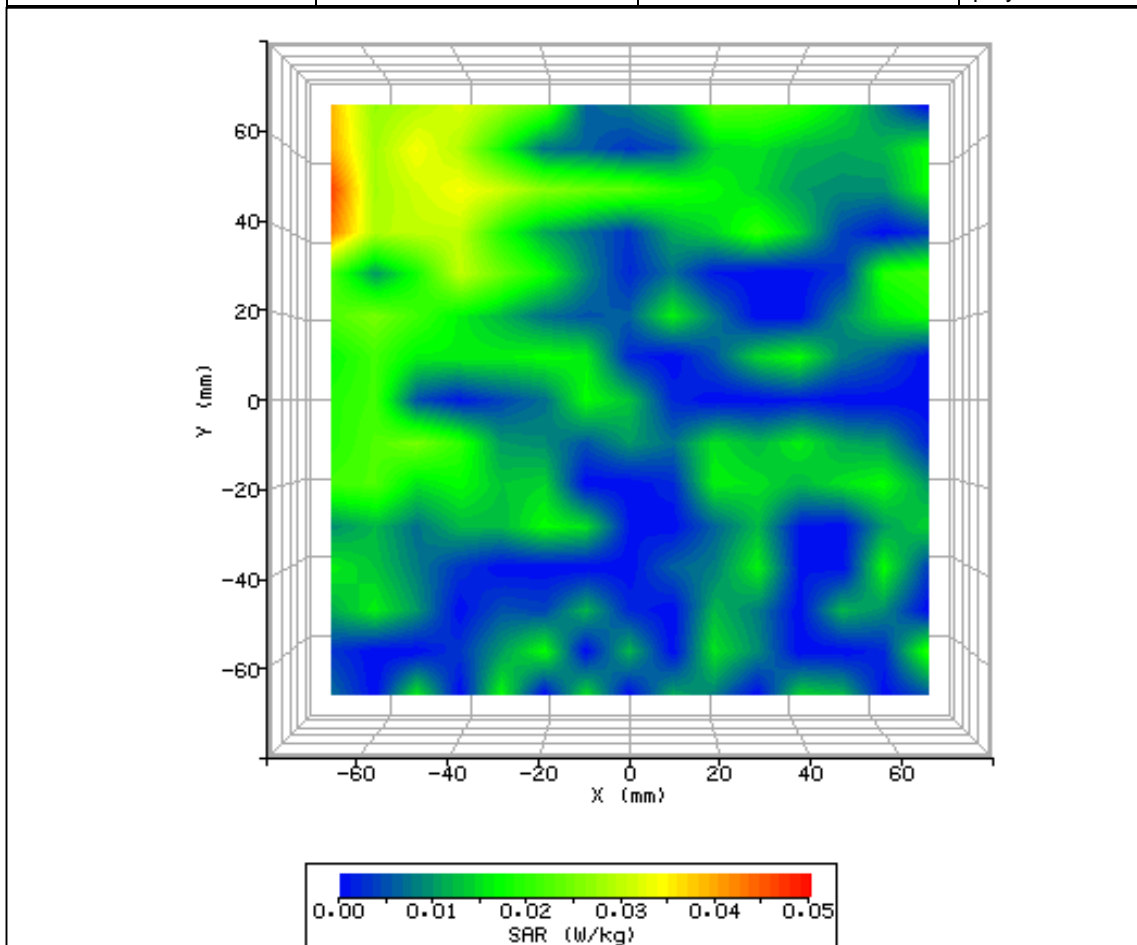

Figure 29: SAR Body Testing Results for the Ericsson Mobile Broadband Module in Screen 90° - Area 2 Phantom Position; Tested at 1880MHz (GSM 1900 Mid Channel) with 2mm Separation Distance to the Phantom (NUA).

SYSTEM / SOFTWARE:	SARA2 / 2.53 VPM	INPUT POWER DRIFT:	0.0 dB
DATE / TIME:	30/07/2008 16:23:43	DUT BATTERY MODEL/NO:	N/A
FILENAME:	75903561-25a.txt	PROBE SERIAL NUMBER:	0171
AMBIENT TEMPERATURE:	23.30°C	LIQUID SIMULANT:	1900Body
DEVICE UNDER TEST:	Ericsson Module	RELATIVE PERMITTIVITY:	52.83
RELATIVE HUMIDITY:	42.00%	CONDUCTIVITY:	1.562
PHANTOM S/NO:	HeadBox.csv	LIQUID TEMPERATURE:	23.00°C
PHANTOM ROTATION:	0°	MAX SAR X-AXIS LOCATION:	Off Edge
DUT POSITION:	Screen 90° - Area 3	MAX SAR Y-AXIS LOCATION:	Off Edge
ANTENNA CONFIGURATION:	N/A	MAX E FIELD:	3.44 V/m
TEST FREQUENCY:	1880MHz	SAR 1g:	N/A
AIR FACTORS:	421 / 374 / 405	SAR 10g:	N/A
CONVERSION FACTORS:	0.278 / 0.278 / 0.278	SAR START:	N/A
TYPE OF MODULATION:	GMSK (GPRS Mode)	SAR END:	N/A
MODN. DUTY CYCLE:	25.0 %	SAR DRIFT DURING SCAN:	0.00 %
DIODE COMPRESSION FACTORS (V*200):	20 / 20 / 20	PROBE BATTERY LAST CHANGED:	30/07/2008
INPUT POWER LEVEL:	30 dBm	EXTRAPOLATION:	poly4

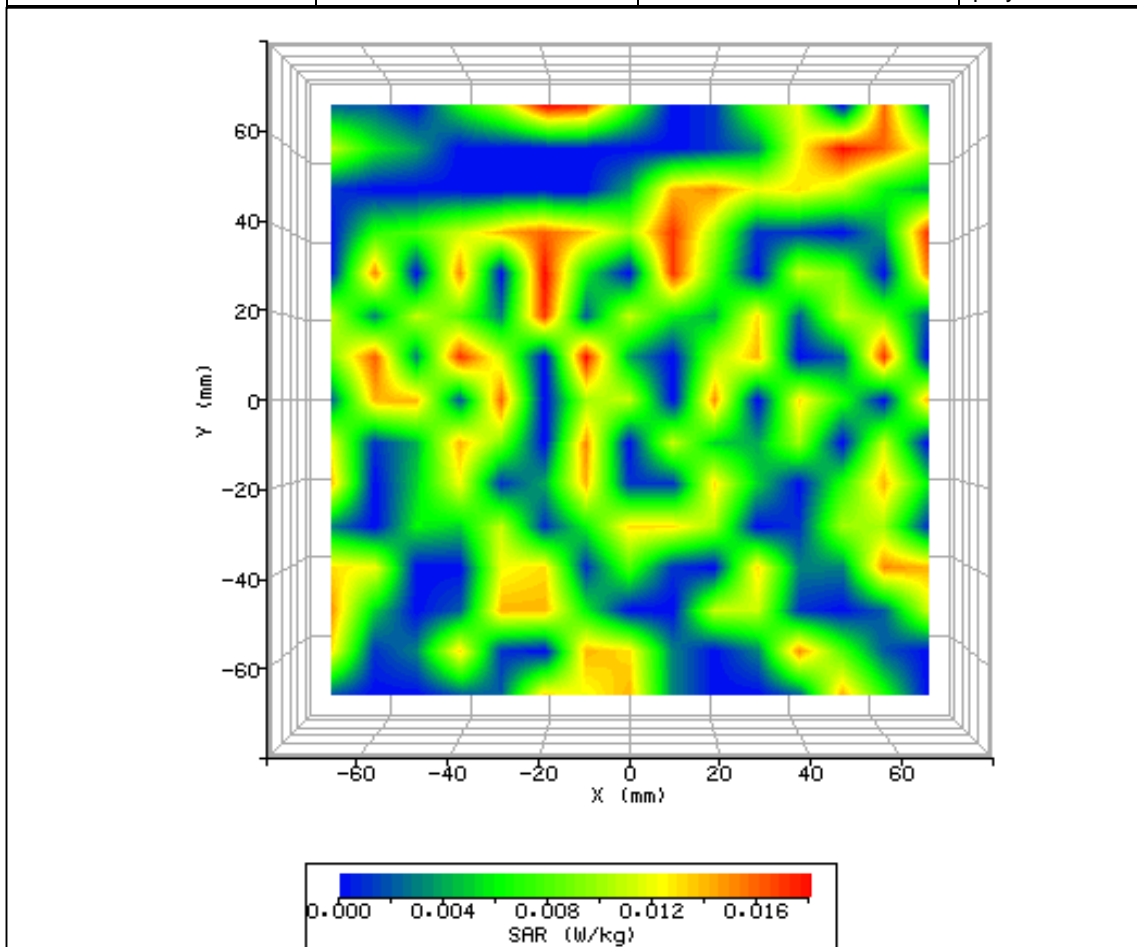

Figure 30: SAR Body Testing Results for the Ericsson Mobile Broadband Module in Screen 90° - Area 3 Phantom Position; Tested at 1880MHz (GSM 1900 Mid Channel) with 2mm Separation Distance to the Phantom (NUA).



SYSTEM / SOFTWARE:	SARA2 / 2.53 VPM	INPUT POWER DRIFT:	0.0 dB
DATE / TIME:	30/07/2008 16:34:01	DUT BATTERY MODEL/NO:	N/A
FILENAME:	75903561-26a.txt	PROBE SERIAL NUMBER:	0171
AMBIENT TEMPERATURE:	23.30°C	LIQUID SIMULANT:	1900Body
DEVICE UNDER TEST:	Ericsson Module	RELATIVE PERMITTIVITY:	52.83
RELATIVE HUMIDITY:	41.30%	CONDUCTIVITY:	1.562
PHANTOM S/NO:	HeadBox.csv	LIQUID TEMPERATURE:	23.00°C
PHANTOM ROTATION:	0°	MAX SAR X-AXIS LOCATION:	Off Edge
DUT POSITION:	Screen 90° - Area 4	MAX SAR Y-AXIS LOCATION:	Off Edge
ANTENNA CONFIGURATION:	N/A	MAX E FIELD:	5.75 V/m
TEST FREQUENCY:	1880MHz	SAR 1g:	N/A
AIR FACTORS:	421 / 374 / 405	SAR 10g:	N/A
CONVERSION FACTORS:	0.278 / 0.278 / 0.278	SAR START:	N/A
TYPE OF MODULATION:	GMSK (GPRS Mode)	SAR END:	N/A
MODN. DUTY CYCLE:	25.0 %	SAR DRIFT DURING SCAN:	0.00 %
DIODE COMPRESSION FACTORS (V*200):	20 / 20 / 20	PROBE BATTERY LAST CHANGED:	30/07/2008
INPUT POWER LEVEL:	30 dBm	EXTRAPOLATION:	poly4

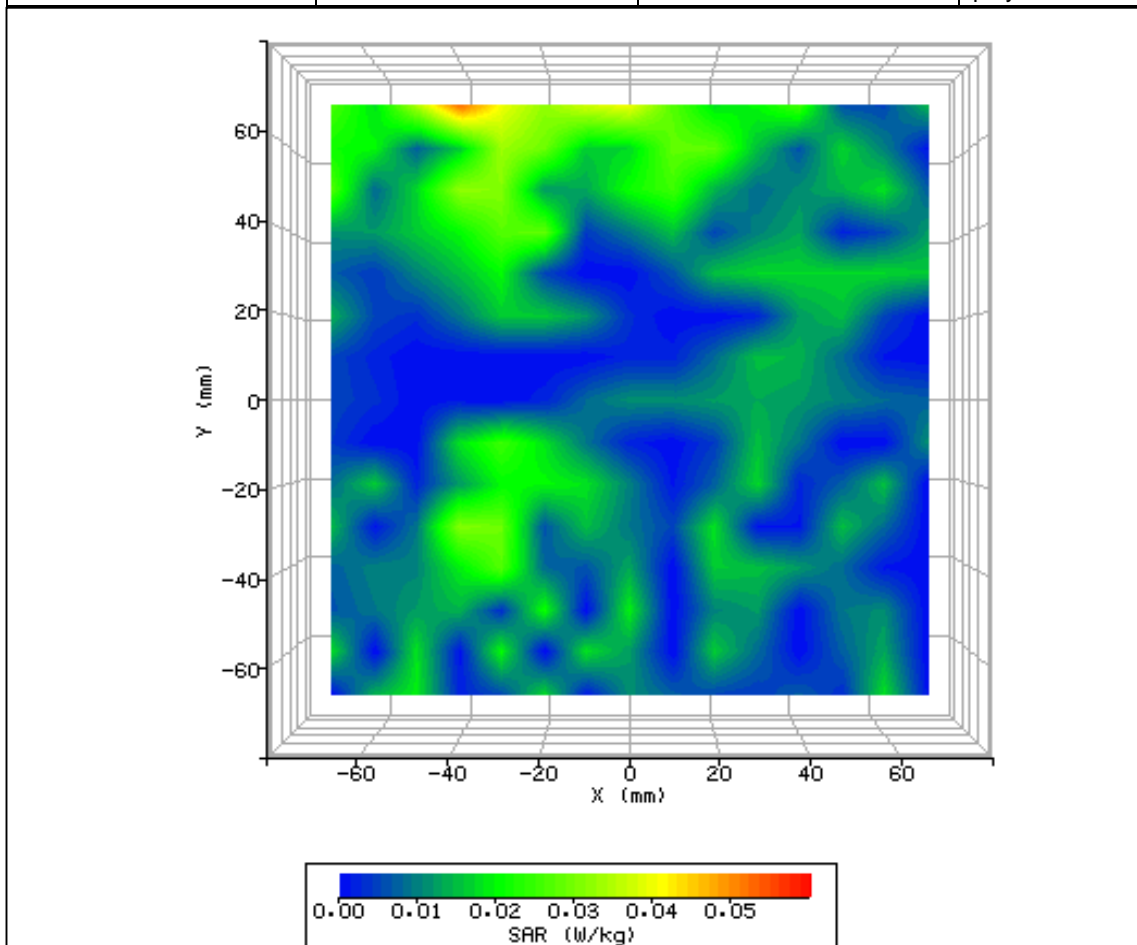

Figure 31: SAR Body Testing Results for the Ericsson Mobile Broadband Module in Screen 90° - Area 4 Phantom Position; Tested at 1880MHz (GSM 1900 Mid Channel) with 2mm Separation Distance to the Phantom (NUA).

SYSTEM / SOFTWARE:	SARA2 / 2.53 VPM	INPUT POWER DRIFT:	0.0 dB
DATE / TIME:	30/07/2008 16:47:15	DUT BATTERY MODEL/NO:	N/A
FILENAME:	75903561-27a.txt	PROBE SERIAL NUMBER:	0171
AMBIENT TEMPERATURE:	23.60°C	LIQUID SIMULANT:	1900Body
DEVICE UNDER TEST:	Ericsson Module	RELATIVE PERMITTIVITY:	52.83
RELATIVE HUMIDITY:	41.70%	CONDUCTIVITY:	1.562
PHANTOM S/NO:	HeadBox.csv	LIQUID TEMPERATURE:	23.10°C
PHANTOM ROTATION:	0°	MAX SAR X-AXIS LOCATION:	Off Edge
DUT POSITION:	Screen 90° - Area 5	MAX SAR Y-AXIS LOCATION:	Off Edge
ANTENNA CONFIGURATION:	N/A	MAX E FIELD:	4.20 V/m
TEST FREQUENCY:	1880MHz	SAR 1g:	N/A
AIR FACTORS:	421 / 374 / 405	SAR 10g:	N/A
CONVERSION FACTORS:	0.278 / 0.278 / 0.278	SAR START:	N/A
TYPE OF MODULATION:	GMSK (GPRS Mode)	SAR END:	N/A
MODN. DUTY CYCLE:	25.0 %	SAR DRIFT DURING SCAN:	0.00 %
DIODE COMPRESSION FACTORS (V*200):	20 / 20 / 20	PROBE BATTERY LAST CHANGED:	30/07/2008
INPUT POWER LEVEL:	30 dBm	EXTRAPOLATION:	poly4

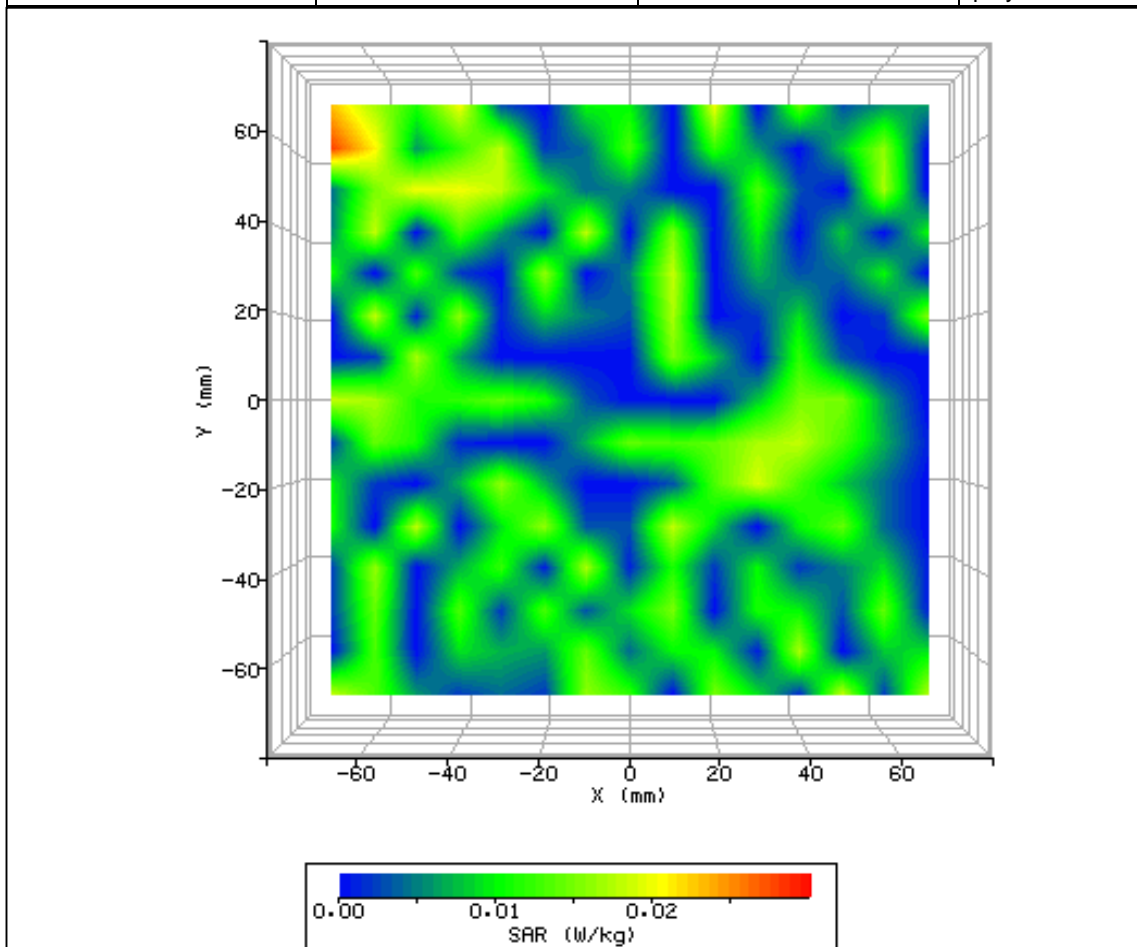

Figure 32: SAR Body Testing Results for the Ericsson Mobile Broadband Module in Screen 90° - Area 5 Phantom Position; Tested at 1880MHz (GSM 1900 Mid Channel) with 2mm Separation Distance to the Phantom (NUA).

SYSTEM / SOFTWARE:	SARA2 / 2.53 VPM	INPUT POWER DRIFT:	0.0 dB
DATE / TIME:	30/07/2008 16:58:28	DUT BATTERY MODEL/NO:	N/A
FILENAME:	75903561-28a.txt	PROBE SERIAL NUMBER:	0171
AMBIENT TEMPERATURE:	23.60°C	LIQUID SIMULANT:	1900Body
DEVICE UNDER TEST:	Ericsson Module	RELATIVE PERMITTIVITY:	52.83
RELATIVE HUMIDITY:	41.40%	CONDUCTIVITY:	1.562
PHANTOM S/NO:	HeadBox.csv	LIQUID TEMPERATURE:	23.10°C
PHANTOM ROTATION:	0°	MAX SAR X-AXIS LOCATION:	-67.00mm
DUT POSITION:	Screen 90° - Area 6	MAX SAR Y-AXIS LOCATION:	43.00mm
ANTENNA CONFIGURATION:	N/A	MAX E FIELD:	3.19 V/m
TEST FREQUENCY:	1880MHz	SAR 1g:	N/A
AIR FACTORS:	421 / 374 / 405	SAR 10g:	N/A
CONVERSION FACTORS:	0.278 / 0.278 / 0.278	SAR START:	N/A
TYPE OF MODULATION:	GMSK (GPRS Mode)	SAR END:	N/A
MODN. DUTY CYCLE:	25.0 %	SAR DRIFT DURING SCAN:	0.00 %
DIODE COMPRESSION FACTORS (V*200):	20 / 20 / 20	PROBE BATTERY LAST CHANGED:	30/07/2008
INPUT POWER LEVEL:	30 dBm	EXTRAPOLATION:	poly4

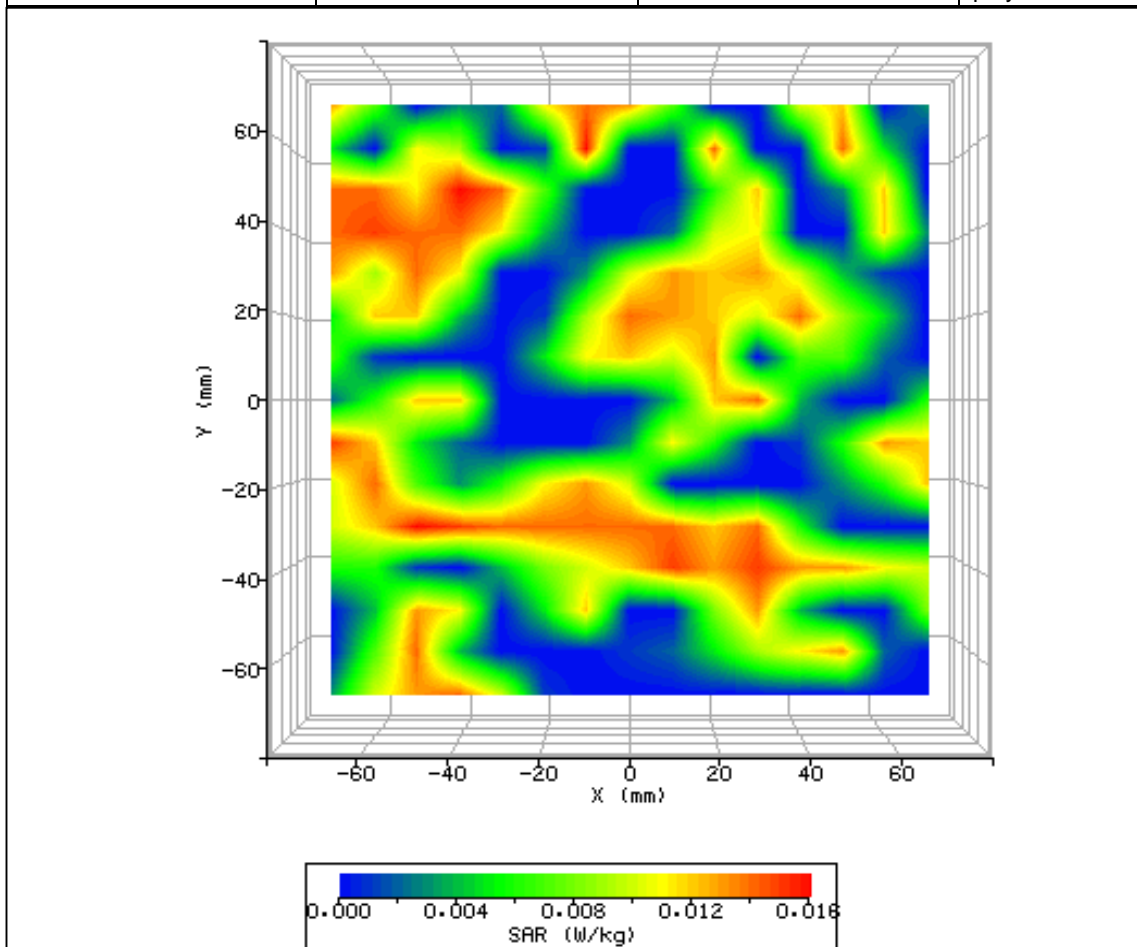

Figure 33: SAR Body Testing Results for the Ericsson Mobile Broadband Module in Screen 90° - Area 6 Phantom Position; Tested at 1880MHz (GSM 1900 Mid Channel) with 2mm Separation Distance to the Phantom (NUA).

SYSTEM / SOFTWARE:	SARA2 / 2.53 VPM	INPUT POWER DRIFT:	0.0 dB
DATE / TIME:	30/07/2008 17:30:04	DUT BATTERY MODEL/NO:	N/A
FILENAME:	75903561-29.txt	PROBE SERIAL NUMBER:	0171
AMBIENT TEMPERATURE:	23.60°C	LIQUID SIMULANT:	1900Body
DEVICE UNDER TEST:	Ericsson Module	RELATIVE PERMITTIVITY:	52.83
RELATIVE HUMIDITY:	41.10%	CONDUCTIVITY:	1.562
PHANTOM S/NO:	HeadBox.csv	LIQUID TEMPERATURE:	23.10°C
PHANTOM ROTATION:	0°	MAX SAR X-AXIS LOCATION:	-39.00mm
DUT POSITION:	Screen 90° - Area 1	MAX SAR Y-AXIS LOCATION:	35.00mm
ANTENNA CONFIGURATION:	N/A	MAX E FIELD:	8.08 V/m
TEST FREQUENCY:	1880MHz	SAR 1g:	0.110 W/kg
AIR FACTORS:	421 / 374 / 405	SAR 10g:	0.071 W/kg
CONVERSION FACTORS:	0.278 / 0.278 / 0.278	SAR START:	0.022 W/kg
TYPE OF MODULATION:	8-PSK (EGPRS Mode)	SAR END:	0.024 W/kg
MODN. DUTY CYCLE:	25.0 %	SAR DRIFT DURING SCAN:	0.00 %
DIODE COMPRESSION FACTORS (V*200):	20 / 20 / 20	PROBE BATTERY LAST CHANGED:	30/07/2008
INPUT POWER LEVEL:	30 dBm	EXTRAPOLATION:	poly4

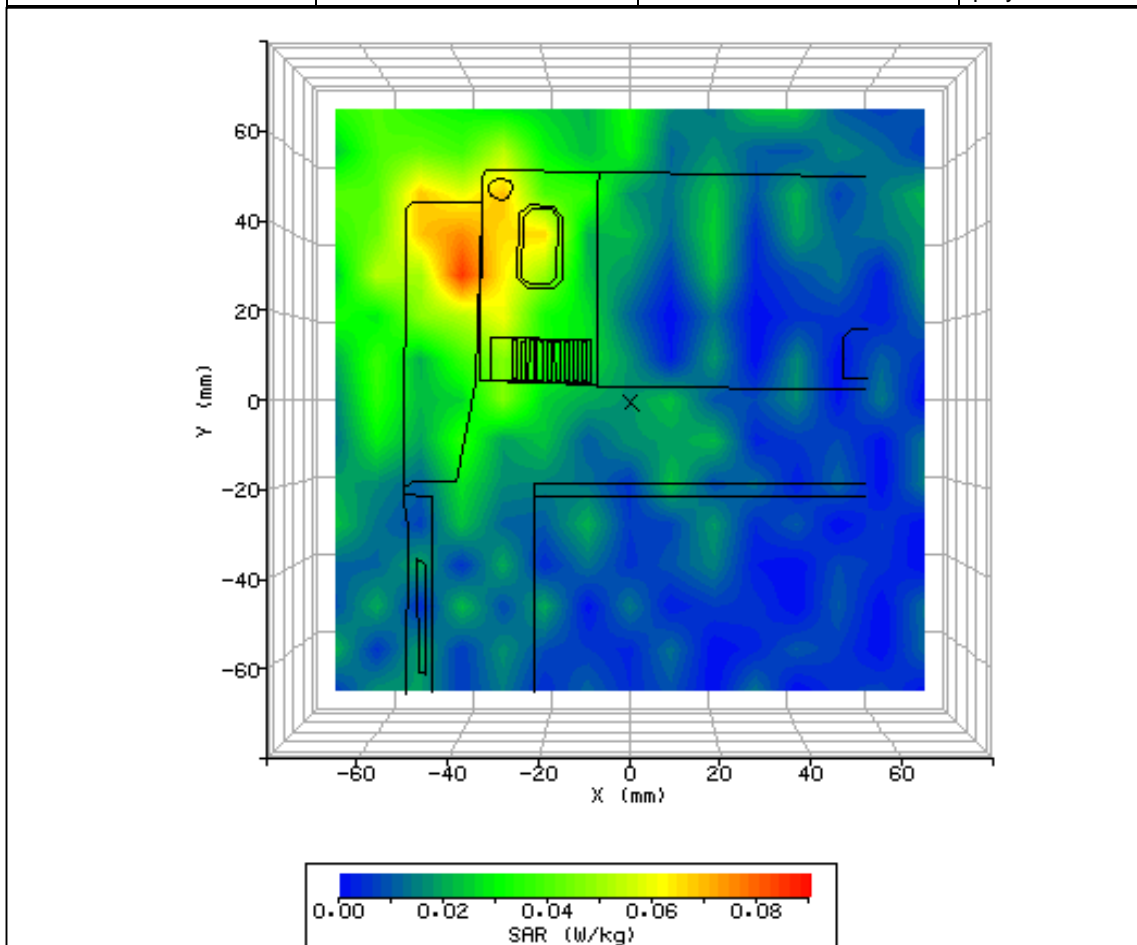

Figure 34: SAR Body Testing Results for the Ericsson Mobile Broadband Module in Screen 90° - Area 1 Phantom Position; Tested at 1880MHz (GSM 1900 Mid Channel) with 2mm Separation Distance to the Phantom (NUA).

2.7 WCDMA FDDI BODY SAR TEST RESULTS AND COURSE AREA SCANS – 2D

SYSTEM / SOFTWARE:	SARA2 / 2.53 VPM	INPUT POWER DRIFT:	0.0 dB
DATE / TIME:	31/07/2008 09:08:59	DUT BATTERY MODEL/NO:	N/A
FILENAME:	75903561-30.txt	PROBE SERIAL NUMBER:	0171
AMBIENT TEMPERATURE:	22.50°C	LIQUID SIMULANT:	1900Body
DEVICE UNDER TEST:	Ericsson Module	RELATIVE PERMITTIVITY:	52.83
RELATIVE HUMIDITY:	56.90%	CONDUCTIVITY:	1.562
PHANTOM S/NO:	HeadBox.csv	LIQUID TEMPERATURE:	22.60°C
PHANTOM ROTATION:	0°	MAX SAR X-AXIS LOCATION:	-37.00mm
DUT POSITION:	Screen 90° - Area 1	MAX SAR Y-AXIS LOCATION:	38.00mm
ANTENNA CONFIGURATION:	N/A	MAX E FIELD:	7.90 V/m
TEST FREQUENCY:	1922.6MHz	SAR 1g:	0.112 W/kg
AIR FACTORS:	421 / 374 / 405	SAR 10g:	0.072 W/kg
CONVERSION FACTORS:	0.278 / 0.278 / 0.278	SAR START:	0.023 W/kg
TYPE OF MODULATION:	QPSK (RMC Mode)	SAR END:	0.023 W/kg
MODN. DUTY CYCLE:	100.0 %	SAR DRIFT DURING SCAN:	0.00 %
DIODE COMPRESSION FACTORS (V*200):	20 / 20 / 20	PROBE BATTERY LAST CHANGED:	31/07/2008
INPUT POWER LEVEL:	24 dBm	EXTRAPOLATION:	poly4

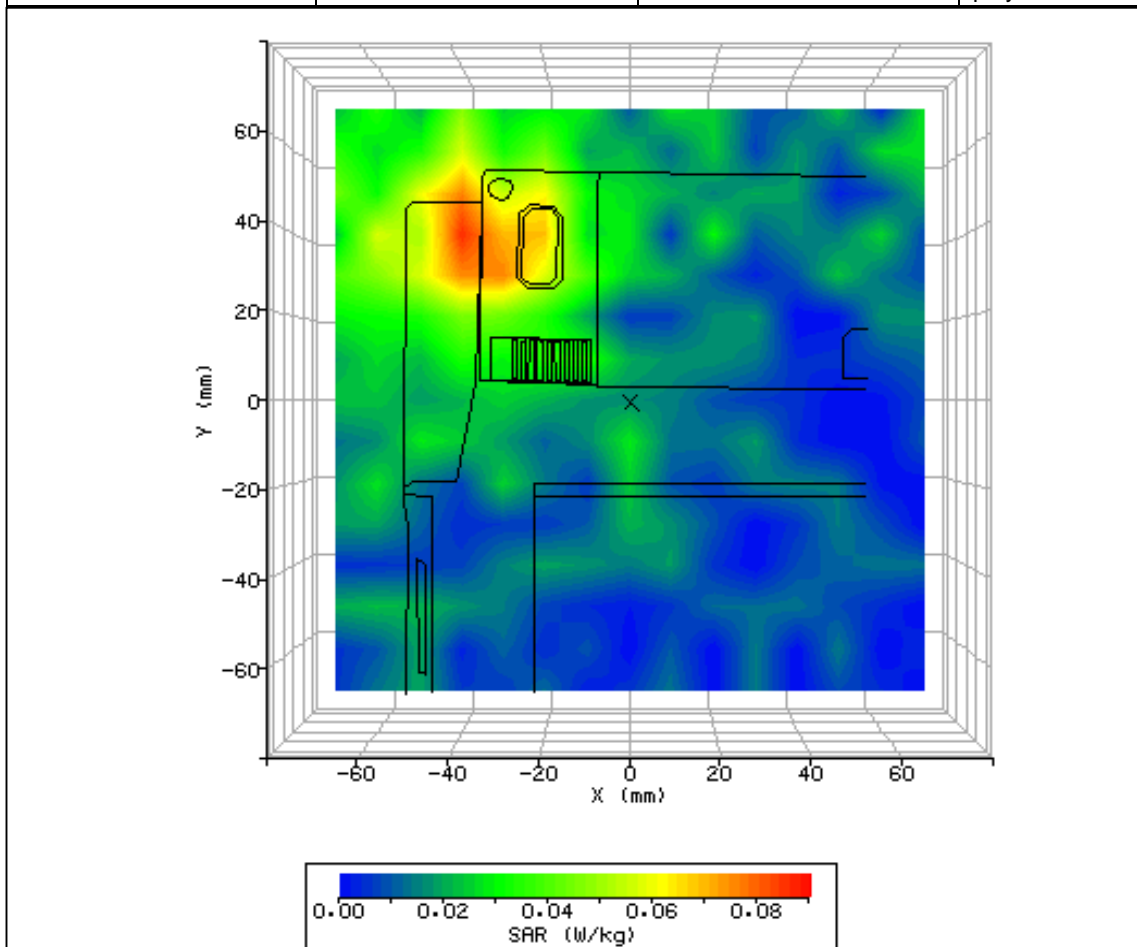

Figure 35: SAR Body Testing Results for the Ericsson Mobile Broadband Module in Screen 90° - Area 1 Phantom Position; Tested at 1922.6MHz (FDD I Low Channel) with 2mm Separation Distance to the Phantom (NUA).

SYSTEM / SOFTWARE:	SARA2 / 2.53 VPM	INPUT POWER DRIFT:	0.0 dB
DATE / TIME:	31/07/2008 09:28:24	DUT BATTERY MODEL/NO:	N/A
FILENAME:	75903561-31a.txt	PROBE SERIAL NUMBER:	0171
AMBIENT TEMPERATURE:	22.50°C	LIQUID SIMULANT:	1900Body
DEVICE UNDER TEST:	Ericsson Module	RELATIVE PERMITTIVITY:	52.83
RELATIVE HUMIDITY:	55.50%	CONDUCTIVITY:	1.562
PHANTOM S/NO:	HeadBox.csv	LIQUID TEMPERATURE:	22.60°C
PHANTOM ROTATION:	0°	MAX SAR X-AXIS LOCATION:	Off Edge
DUT POSITION:	Screen 90° - Area 2	MAX SAR Y-AXIS LOCATION:	Off Edge
ANTENNA CONFIGURATION:	N/A	MAX E FIELD:	4.32 V/m
TEST FREQUENCY:	1922.6MHz	SAR 1g:	N/A
AIR FACTORS:	421 / 374 / 405	SAR 10g:	N/A
CONVERSION FACTORS:	0.278 / 0.278 / 0.278	SAR START:	N/A
TYPE OF MODULATION:	QPSK (RMC Mode)	SAR END:	N/A
MODN. DUTY CYCLE:	100.0 %	SAR DRIFT DURING SCAN:	0.00 %
DIODE COMPRESSION FACTORS (V*200):	20 / 20 / 20	PROBE BATTERY LAST CHANGED:	31/07/2008
INPUT POWER LEVEL:	24 dBm	EXTRAPOLATION:	poly4

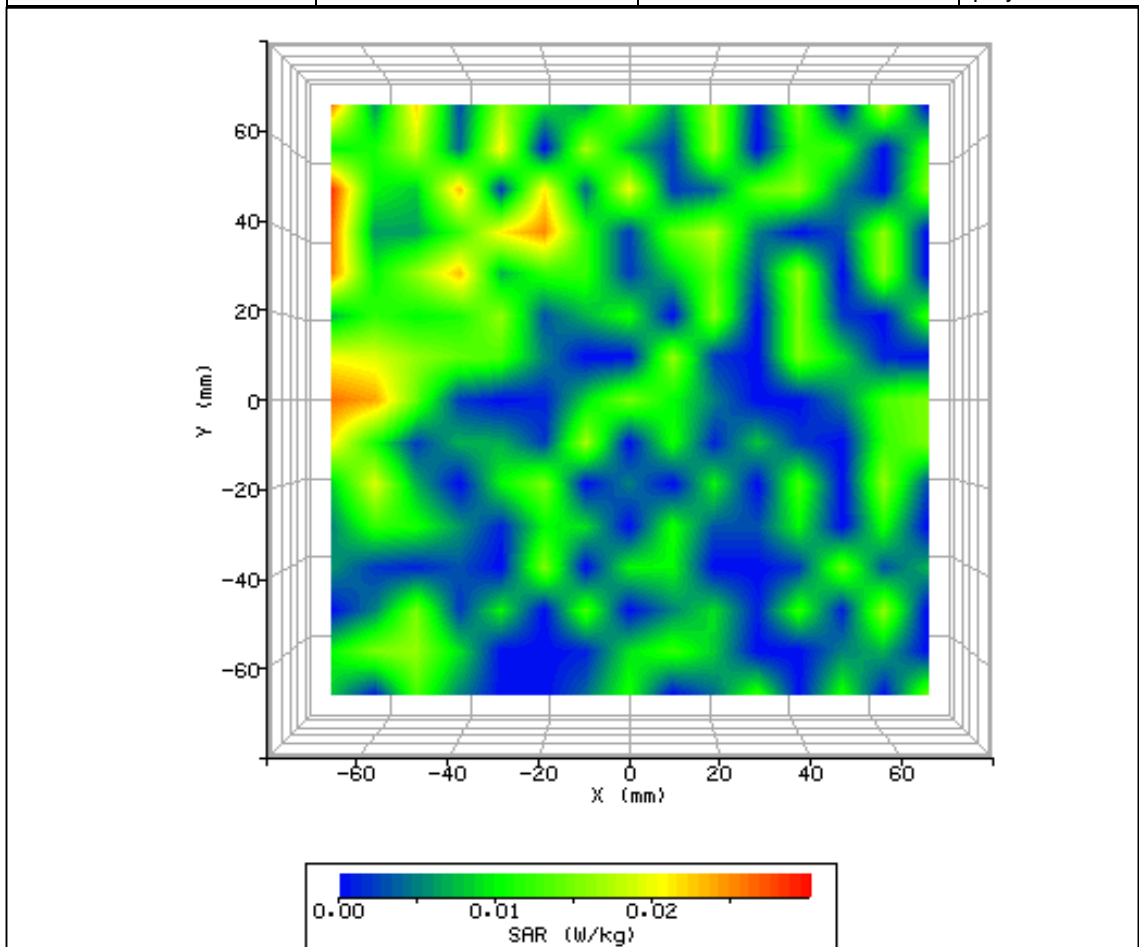

Figure 36: SAR Body Testing Results for the Ericsson Mobile Broadband Module in Screen 90° - Area 2 Phantom Position; Tested at 1922.6MHz (FDD I Low Channel) with 2mm Separation Distance to the Phantom (NUA).

SYSTEM / SOFTWARE:	SARA2 / 2.53 VPM	INPUT POWER DRIFT:	0.0 dB
DATE / TIME:	31/07/2008 09:37:06	DUT BATTERY MODEL/NO:	N/A
FILENAME:	75903561-32a.txt	PROBE SERIAL NUMBER:	0171
AMBIENT TEMPERATURE:	22.80°C	LIQUID SIMULANT:	1900Body
DEVICE UNDER TEST:	Ericsson Module	RELATIVE PERMITTIVITY:	52.83
RELATIVE HUMIDITY:	54.90%	CONDUCTIVITY:	1.562
PHANTOM S/NO:	HeadBox.csv	LIQUID TEMPERATURE:	22.60°C
PHANTOM ROTATION:	0°	MAX SAR X-AXIS LOCATION:	Off Edge
DUT POSITION:	Screen 90° - Area 3	MAX SAR Y-AXIS LOCATION:	Off Edge
ANTENNA CONFIGURATION:	N/A	MAX E FIELD:	3.49 V/m
TEST FREQUENCY:	1922.6MHz	SAR 1g:	N/A
AIR FACTORS:	421 / 374 / 405	SAR 10g:	N/A
CONVERSION FACTORS:	0.278 / 0.278 / 0.278	SAR START:	N/A
TYPE OF MODULATION:	QPSK (RMC Mode)	SAR END:	N/A
MODN. DUTY CYCLE:	100.0 %	SAR DRIFT DURING SCAN:	0.00 %
DIODE COMPRESSION FACTORS (V*200):	20 / 20 / 20	PROBE BATTERY LAST CHANGED:	31/07/2008
INPUT POWER LEVEL:	24 dBm	EXTRAPOLATION:	poly4

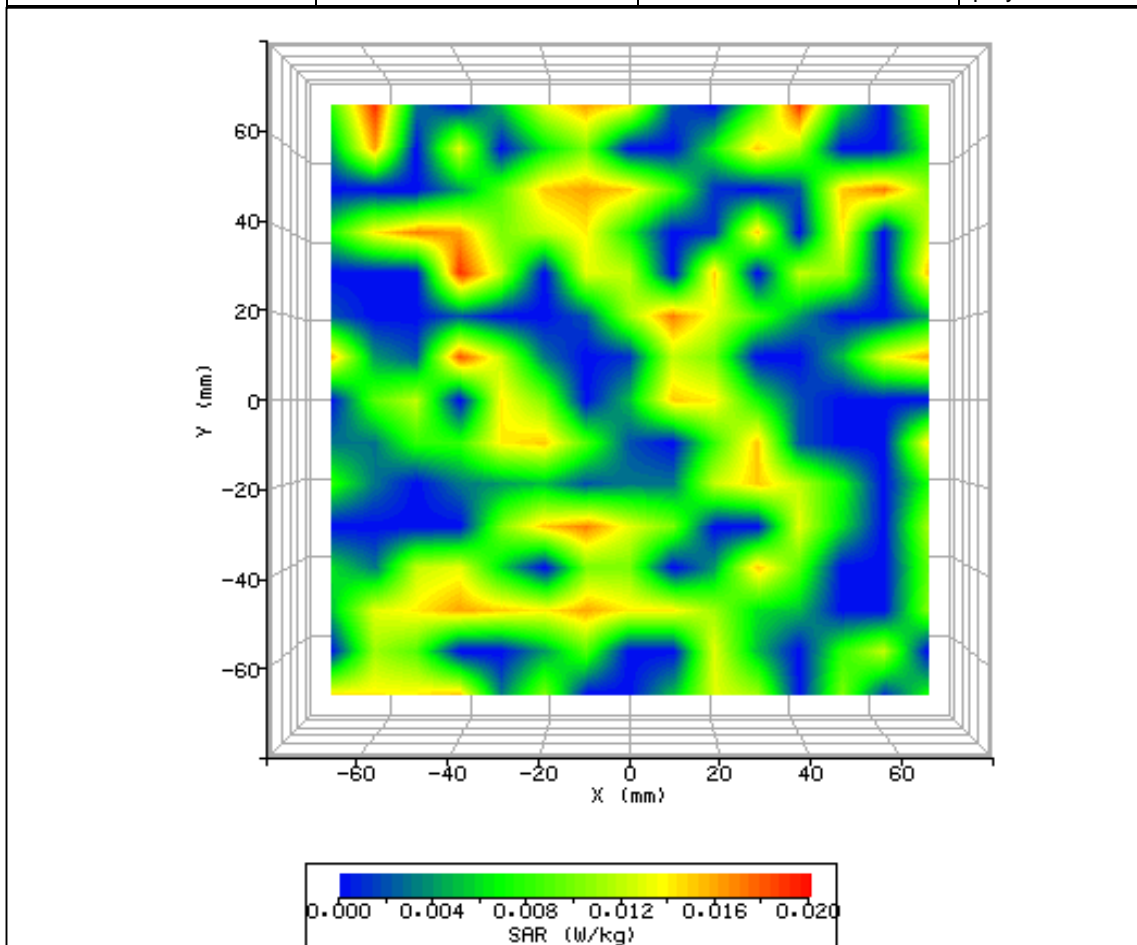

Figure 37: SAR Body Testing Results for the Ericsson Mobile Broadband Module in Screen 90° - Area 3 Phantom Position; Tested at 1922.6MHz (FDD I Low Channel) with 2mm Separation Distance to the Phantom (NUA).

SYSTEM / SOFTWARE:	SARA2 / 2.53 VPM	INPUT POWER DRIFT:	0.0 dB
DATE / TIME:	31/07/2008 09:46:29	DUT BATTERY MODEL/NO:	N/A
FILENAME:	75903561-33a.txt	PROBE SERIAL NUMBER:	0171
AMBIENT TEMPERATURE:	22.90°C	LIQUID SIMULANT:	1900Body
DEVICE UNDER TEST:	Ericsson Module	RELATIVE PERMITTIVITY:	52.83
RELATIVE HUMIDITY:	54.40%	CONDUCTIVITY:	1.562
PHANTOM S/NO:	HeadBox.csv	LIQUID TEMPERATURE:	22.70°C
PHANTOM ROTATION:	0°	MAX SAR X-AXIS LOCATION:	Off Edge
DUT POSITION:	Screen 90° - Area 4	MAX SAR Y-AXIS LOCATION:	Off Edge
ANTENNA CONFIGURATION:	N/A	MAX E FIELD:	4.22 V/m
TEST FREQUENCY:	1922.6MHz	SAR 1g:	N/A
AIR FACTORS:	421 / 374 / 405	SAR 10g:	N/A
CONVERSION FACTORS:	0.278 / 0.278 / 0.278	SAR START:	N/A
TYPE OF MODULATION:	QPSK (RMC Mode)	SAR END:	N/A
MODN. DUTY CYCLE:	100.0 %	SAR DRIFT DURING SCAN:	0.00 %
DIODE COMPRESSION FACTORS (V*200):	20 / 20 / 20	PROBE BATTERY LAST CHANGED:	31/07/2008
INPUT POWER LEVEL:	24 dBm	EXTRAPOLATION:	poly4

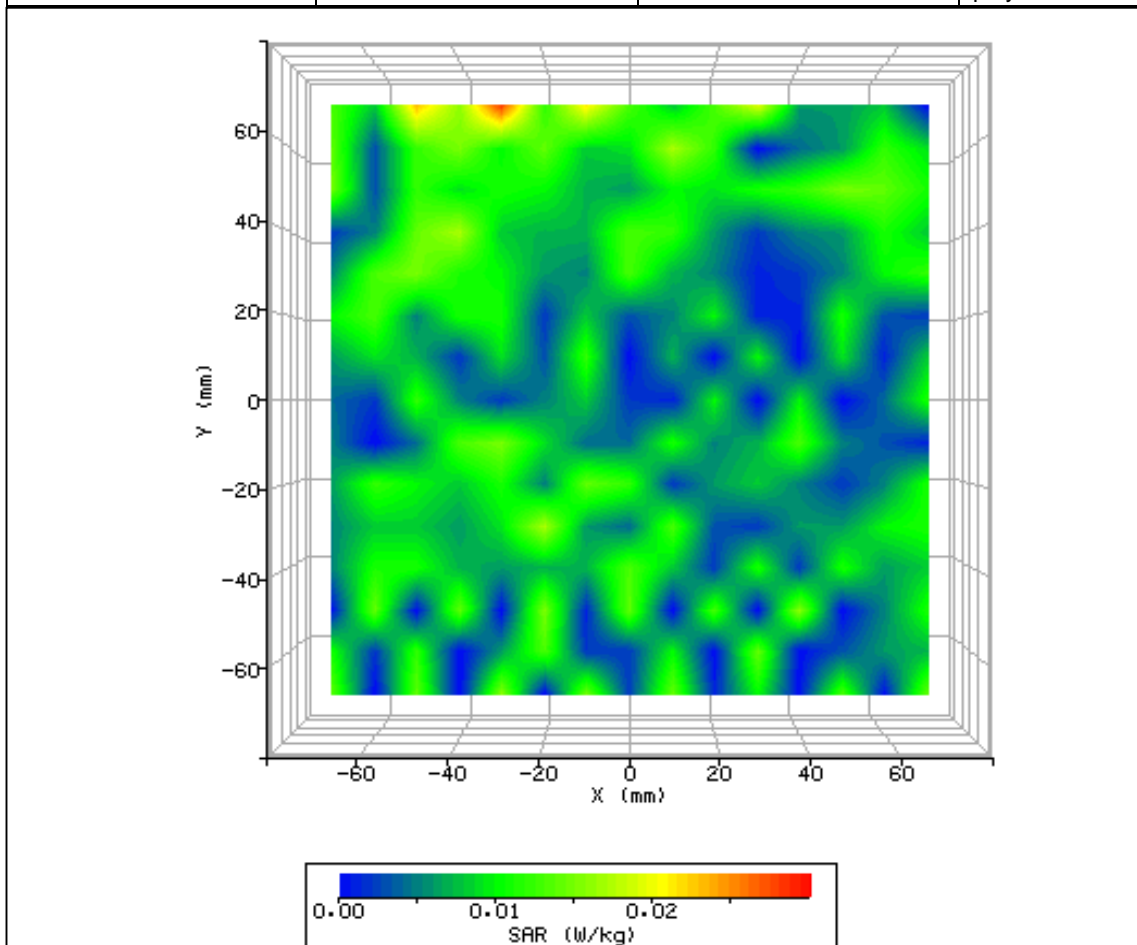

Figure 38: SAR Body Testing Results for the Ericsson Mobile Broadband Module in Screen 90° - Area 4 Phantom Position; Tested at 1922.6MHz (FDD I Low Channel) with 2mm Separation Distance to the Phantom (NUA).



SYSTEM / SOFTWARE:	SARA2 / 2.53 VPM	INPUT POWER DRIFT:	0.0 dB
DATE / TIME:	31/07/2008 09:56:10	DUT BATTERY MODEL/NO:	N/A
FILENAME:	75903561-34a.txt	PROBE SERIAL NUMBER:	0171
AMBIENT TEMPERATURE:	23.00°C	LIQUID SIMULANT:	1900Body
DEVICE UNDER TEST:	Ericsson Module	RELATIVE PERMITTIVITY:	52.83
RELATIVE HUMIDITY:	52.90%	CONDUCTIVITY:	1.562
PHANTOM S/NO:	HeadBox.csv	LIQUID TEMPERATURE:	22.70°C
PHANTOM ROTATION:	0°	MAX SAR X-AXIS LOCATION:	Off Edge
DUT POSITION:	Screen 90° - Area 5	MAX SAR Y-AXIS LOCATION:	Off Edge
ANTENNA CONFIGURATION:	N/A	MAX E FIELD:	4.09 V/m
TEST FREQUENCY:	1922.6MHz	SAR 1g:	N/A
AIR FACTORS:	421 / 374 / 405	SAR 10g:	N/A
CONVERSION FACTORS:	0.278 / 0.278 / 0.278	SAR START:	N/A
TYPE OF MODULATION:	QPSK (RMC Mode)	SAR END:	N/A
MODN. DUTY CYCLE:	100.0 %	SAR DRIFT DURING SCAN:	0.00 %
DIODE COMPRESSION FACTORS (V*200):	20 / 20 / 20	PROBE BATTERY LAST CHANGED:	31/07/2008
INPUT POWER LEVEL:	24 dBm	EXTRAPOLATION:	poly4

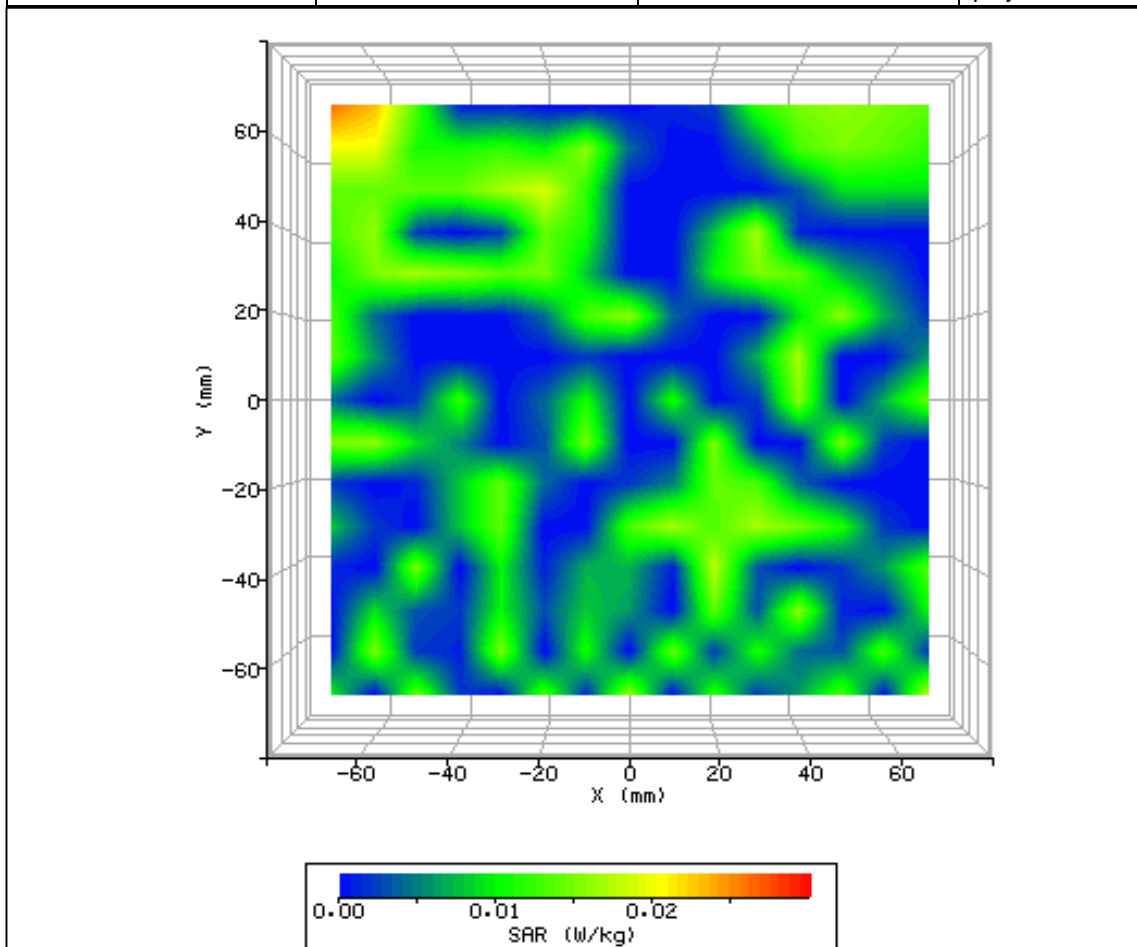

Figure 39: SAR Body Testing Results for the Ericsson Mobile Broadband Module in Screen 90° - Area 5 Phantom Position; Tested at 1922.6MHz (FDD I Low Channel) with 2mm Separation Distance to the Phantom (NUA).

SYSTEM / SOFTWARE:	SARA2 / 2.53 VPM	INPUT POWER DRIFT:	0.0 dB
DATE / TIME:	31/07/2008 10:58:57	DUT BATTERY MODEL/NO:	N/A
FILENAME:	75903561-35a.txt	PROBE SERIAL NUMBER:	0171
AMBIENT TEMPERATURE:	23.40°C	LIQUID SIMULANT:	1900Body
DEVICE UNDER TEST:	Ericsson Module	RELATIVE PERMITTIVITY:	52.83
RELATIVE HUMIDITY:	51.60%	CONDUCTIVITY:	1.562
PHANTOM S/NO:	HeadBox.csv	LIQUID TEMPERATURE:	22.80°C
PHANTOM ROTATION:	0°	MAX SAR X-AXIS LOCATION:	-70.00mm
DUT POSITION:	Screen 90° - Area 6	MAX SAR Y-AXIS LOCATION:	-26.00mm
ANTENNA CONFIGURATION:	N/A	MAX E FIELD:	3.09 V/m
TEST FREQUENCY:	1922.6MHz	SAR 1g:	N/A
AIR FACTORS:	421 / 374 / 405	SAR 10g:	N/A
CONVERSION FACTORS:	0.278 / 0.278 / 0.278	SAR START:	N/A
TYPE OF MODULATION:	QPSK (RMC Mode)	SAR END:	N/A
MODN. DUTY CYCLE:	100.0 %	SAR DRIFT DURING SCAN:	0.00 %
DIODE COMPRESSION FACTORS (V*200):	20 / 20 / 20	PROBE BATTERY LAST CHANGED:	31/07/2008
INPUT POWER LEVEL:	24 dBm	EXTRAPOLATION:	poly4

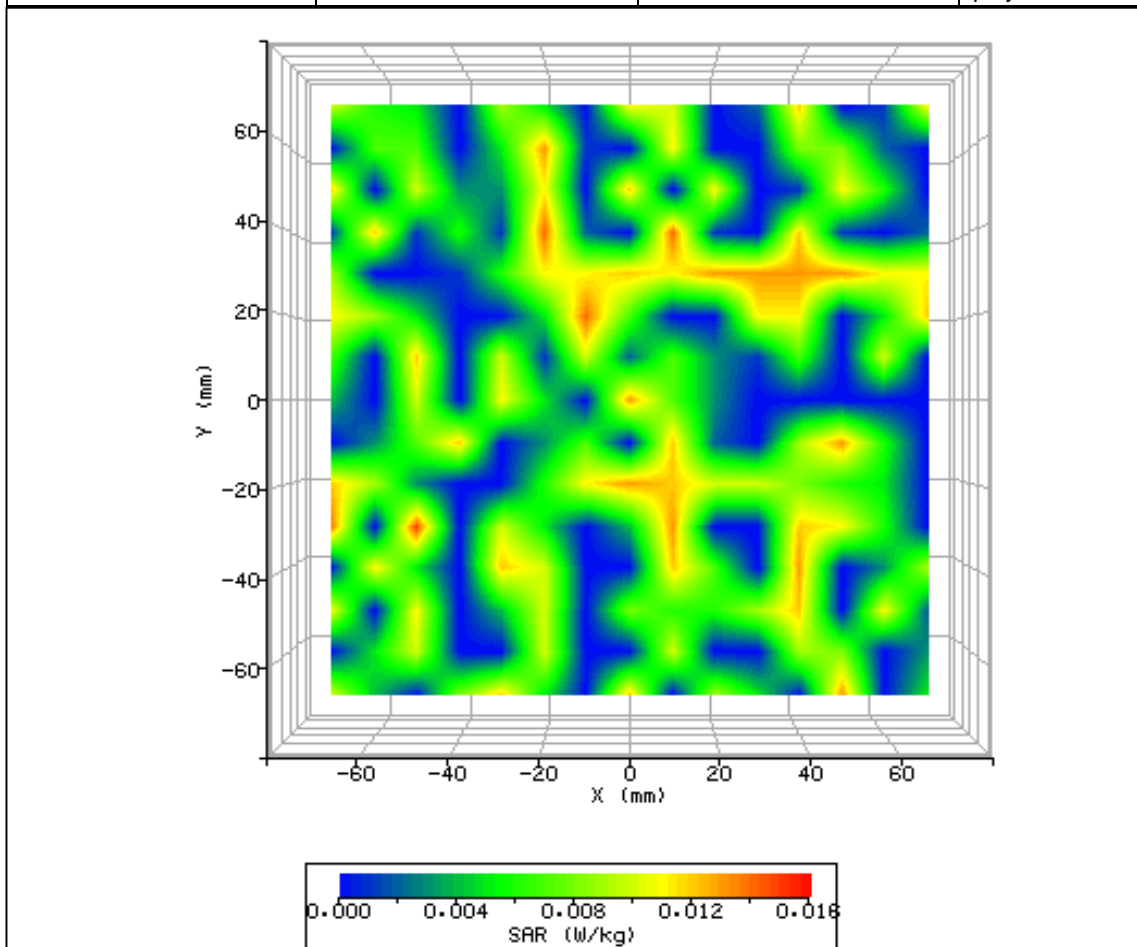

Figure 40: SAR Body Testing Results for the Ericsson Mobile Broadband Module in Screen 90° - Area 6 Phantom Position; Tested at 1922.6MHz (FDD I Low Channel) with 2mm Separation Distance to the Phantom (NUA).

SYSTEM / SOFTWARE:	SARA2 / 2.53 VPM	INPUT POWER DRIFT:	0.0 dB
DATE / TIME:	31/07/2008 11:31:08	DUT BATTERY MODEL/NO:	N/A
FILENAME:	75903561-36.txt	PROBE SERIAL NUMBER:	0171
AMBIENT TEMPERATURE:	23.30°C	LIQUID SIMULANT:	1900Body
DEVICE UNDER TEST:	Ericsson Module	RELATIVE PERMITTIVITY:	52.83
RELATIVE HUMIDITY:	55.10%	CONDUCTIVITY:	1.562
PHANTOM S/NO:	HeadBox.csv	LIQUID TEMPERATURE:	22.80°C
PHANTOM ROTATION:	0°	MAX SAR X-AXIS LOCATION:	-30.00mm
DUT POSITION:	Screen 90° - Area 1	MAX SAR Y-AXIS LOCATION:	34.00mm
ANTENNA CONFIGURATION:	N/A	MAX E FIELD:	6.59 V/m
TEST FREQUENCY:	1922.6MHz	SAR 1g:	0.076 W/kg
AIR FACTORS:	421 / 374 / 405	SAR 10g:	0.047 W/kg
CONVERSION FACTORS:	0.278 / 0.278 / 0.278	SAR START:	0.016 W/kg
TYPE OF MODULATION:	QPSK (RMC+HSDPA Mode)	SAR END:	0.015 W/kg
MODN. DUTY CYCLE:	100.0 %	SAR DRIFT DURING SCAN:	0.00 %
DIODE COMPRESSION FACTORS (V*200):	20 / 20 / 20	PROBE BATTERY LAST CHANGED:	31/07/2008
INPUT POWER LEVEL:	24 dBm	EXTRAPOLATION:	poly4

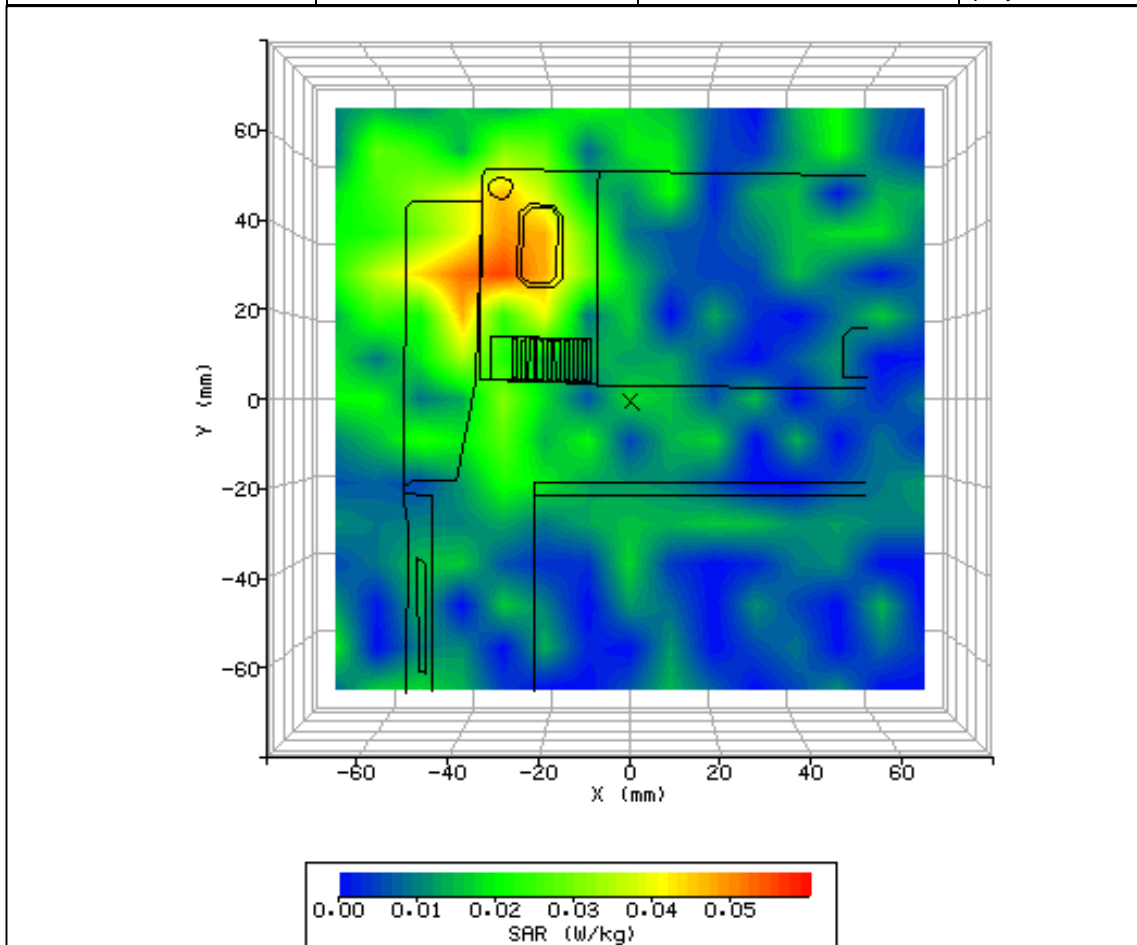

Figure 41: SAR Body Testing Results for the Ericsson Mobile Broadband Module in Screen 90° - Area 1 Phantom Position; Tested at 1922.6MHz (FDD I Low Channel) with 2mm Separation Distance to the Phantom (NUA).

SYSTEM / SOFTWARE:	SARA2 / 2.53 VPM	INPUT POWER DRIFT:	0.0 dB
DATE / TIME:	31/07/2008 12:12:48	DUT BATTERY MODEL/NO:	N/A
FILENAME:	75903561-37.txt	PROBE SERIAL NUMBER:	0171
AMBIENT TEMPERATURE:	23.20°C	LIQUID SIMULANT:	1900Body
DEVICE UNDER TEST:	Ericsson Module	RELATIVE PERMITTIVITY:	52.83
RELATIVE HUMIDITY:	55.90%	CONDUCTIVITY:	1.562
PHANTOM S/NO:	HeadBox.csv	LIQUID TEMPERATURE:	22.80°C
PHANTOM ROTATION:	0°	MAX SAR X-AXIS LOCATION:	-39.00mm
DUT POSITION:	Screen 90° - Area 1	MAX SAR Y-AXIS LOCATION:	37.00mm
ANTENNA CONFIGURATION:	N/A	MAX E FIELD:	7.01 V/m
TEST FREQUENCY:	1922.6MHz	SAR 1g:	0.089 W/kg
AIR FACTORS:	421 / 374 / 405	SAR 10g:	0.057 W/kg
CONVERSION FACTORS:	0.278 / 0.278 / 0.278	SAR START:	0.016 W/kg
TYPE OF MODULATION:	QPSK (RMC+HSUPA Mode)	SAR END:	0.016 W/kg
MODN. DUTY CYCLE:	100.0 %	SAR DRIFT DURING SCAN:	0.93 %
DIODE COMPRESSION FACTORS (V*200):	20 / 20 / 20	PROBE BATTERY LAST CHANGED:	31/07/2008
INPUT POWER LEVEL:	24 dBm	EXTRAPOLATION:	poly4

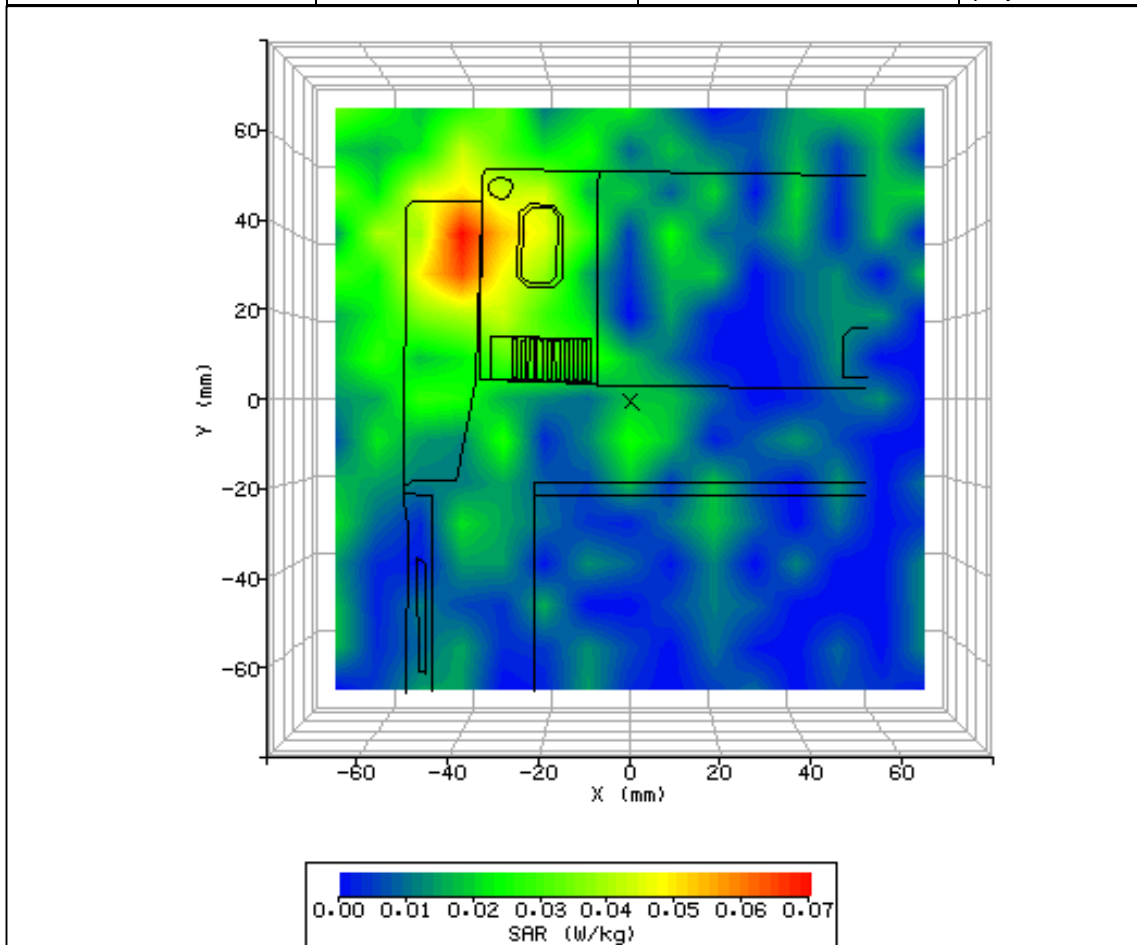

Figure 42: SAR Body Testing Results for the Ericsson Mobile Broadband Module in Screen 90° - Area 1 Phantom Position; Tested at 1922.6MHz (FDD I Low Channel) with 2mm Separation Distance to the Phantom (NUA).

2.8 WCDMA FDDII BODY SAR TEST RESULTS AND COURSE AREA SCANS – 2D

SYSTEM / SOFTWARE:	SARA2 / 2.53 VPM	INPUT POWER DRIFT:	0.0 dB
DATE / TIME:	31/07/2008 12:44:03	DUT BATTERY MODEL/NO:	N/A
FILENAME:	75903561-38.txt	PROBE SERIAL NUMBER:	0171
AMBIENT TEMPERATURE:	24.20°C	LIQUID SIMULANT:	1900Body
DEVICE UNDER TEST:	Ericsson Module	RELATIVE PERMITTIVITY:	52.83
RELATIVE HUMIDITY:	55.10%	CONDUCTIVITY:	1.562
PHANTOM S/NO:	HeadBox.csv	LIQUID TEMPERATURE:	22.90°C
PHANTOM ROTATION:	0°	MAX SAR X-AXIS LOCATION:	-37.00mm
DUT POSITION:	Screen 90° - Area 1	MAX SAR Y-AXIS LOCATION:	38.00mm
ANTENNA CONFIGURATION:	N/A	MAX E FIELD:	9.39 V/m
TEST FREQUENCY:	1880MHz	SAR 1g:	0.153 W/kg
AIR FACTORS:	421 / 374 / 405	SAR 10g:	0.096 W/kg
CONVERSION FACTORS:	0.278 / 0.278 / 0.278	SAR START:	0.034 W/kg
TYPE OF MODULATION:	QPSK (RMC Mode)	SAR END:	0.034 W/kg
MODN. DUTY CYCLE:	100.0 %	SAR DRIFT DURING SCAN:	0.00 %
DIODE COMPRESSION FACTORS (V*200):	20 / 20 / 20	PROBE BATTERY LAST CHANGED:	31/07/2008
INPUT POWER LEVEL:	24 dBm	EXTRAPOLATION:	poly4

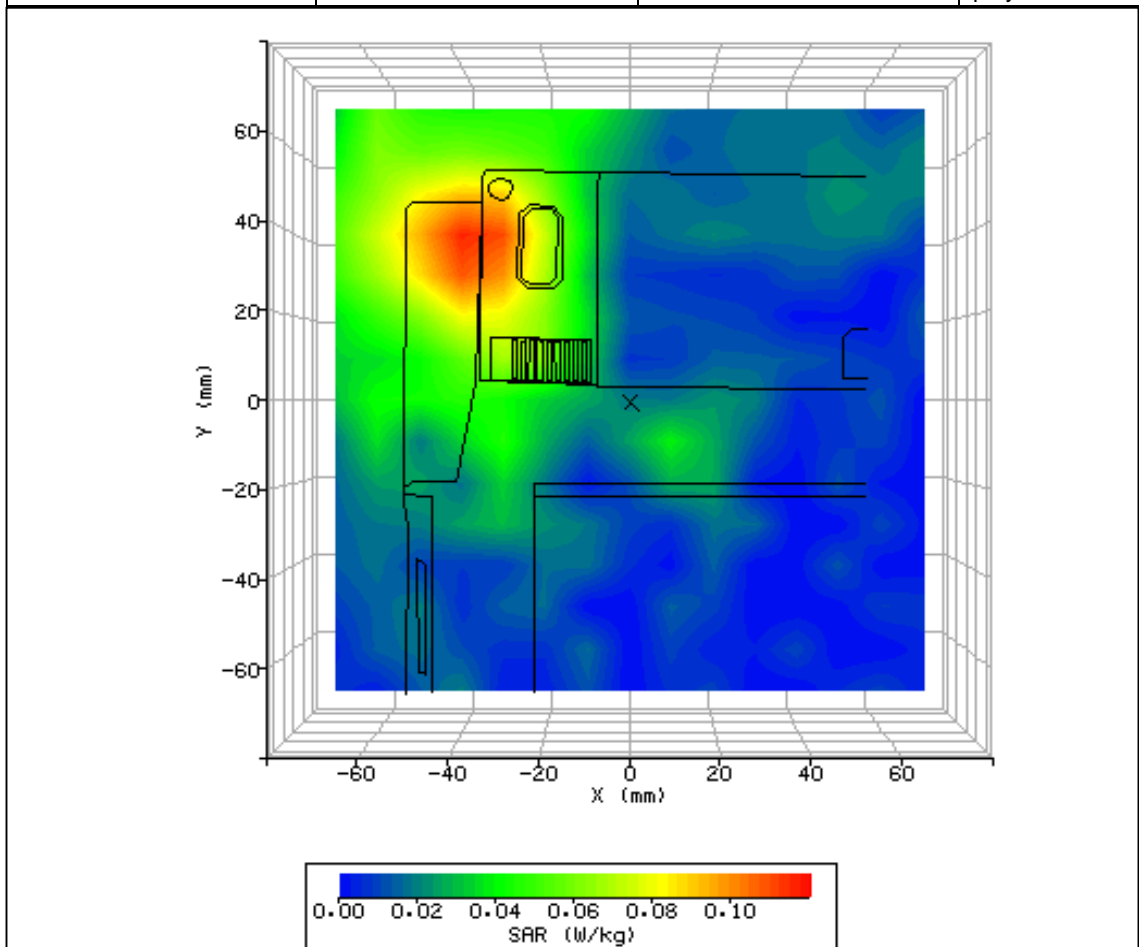

Figure 43: SAR Body Testing Results for the Ericsson Mobile Broadband Module in Screen 90° - Area 1 Phantom Position; Tested at 1880MHz (FDD II Mid Channel) with 2mm Separation Distance to the Phantom (NUA).

SYSTEM / SOFTWARE:	SARA2 / 2.53 VPM	INPUT POWER DRIFT:	0.0 dB
DATE / TIME:	31/07/2008 14:39:17	DUT BATTERY MODEL/NO:	N/A
FILENAME:	75903561-39a.txt	PROBE SERIAL NUMBER:	0171
AMBIENT TEMPERATURE:	24.00°C	LIQUID SIMULANT:	1900Body
DEVICE UNDER TEST:	Ericsson Module	RELATIVE PERMITTIVITY:	52.83
RELATIVE HUMIDITY:	54.20%	CONDUCTIVITY:	1.562
PHANTOM S/NO:	HeadBox.csv	LIQUID TEMPERATURE:	23.00°C
PHANTOM ROTATION:	0°	MAX SAR X-AXIS LOCATION:	Off Edge
DUT POSITION:	Screen 90° - Area 2	MAX SAR Y-AXIS LOCATION:	Off Edge
ANTENNA CONFIGURATION:	N/A	MAX E FIELD:	4.42 V/m
TEST FREQUENCY:	1880MHz	SAR 1g:	N/A
AIR FACTORS:	421 / 374 / 405	SAR 10g:	N/A
CONVERSION FACTORS:	0.278 / 0.278 / 0.278	SAR START:	N/A
TYPE OF MODULATION:	QPSK (RMC Mode)	SAR END:	N/A
MODN. DUTY CYCLE:	100.0 %	SAR DRIFT DURING SCAN:	0.00 %
DIODE COMPRESSION FACTORS (V*200):	20 / 20 / 20	PROBE BATTERY LAST CHANGED:	31/07/2008
INPUT POWER LEVEL:	24 dBm	EXTRAPOLATION:	poly4

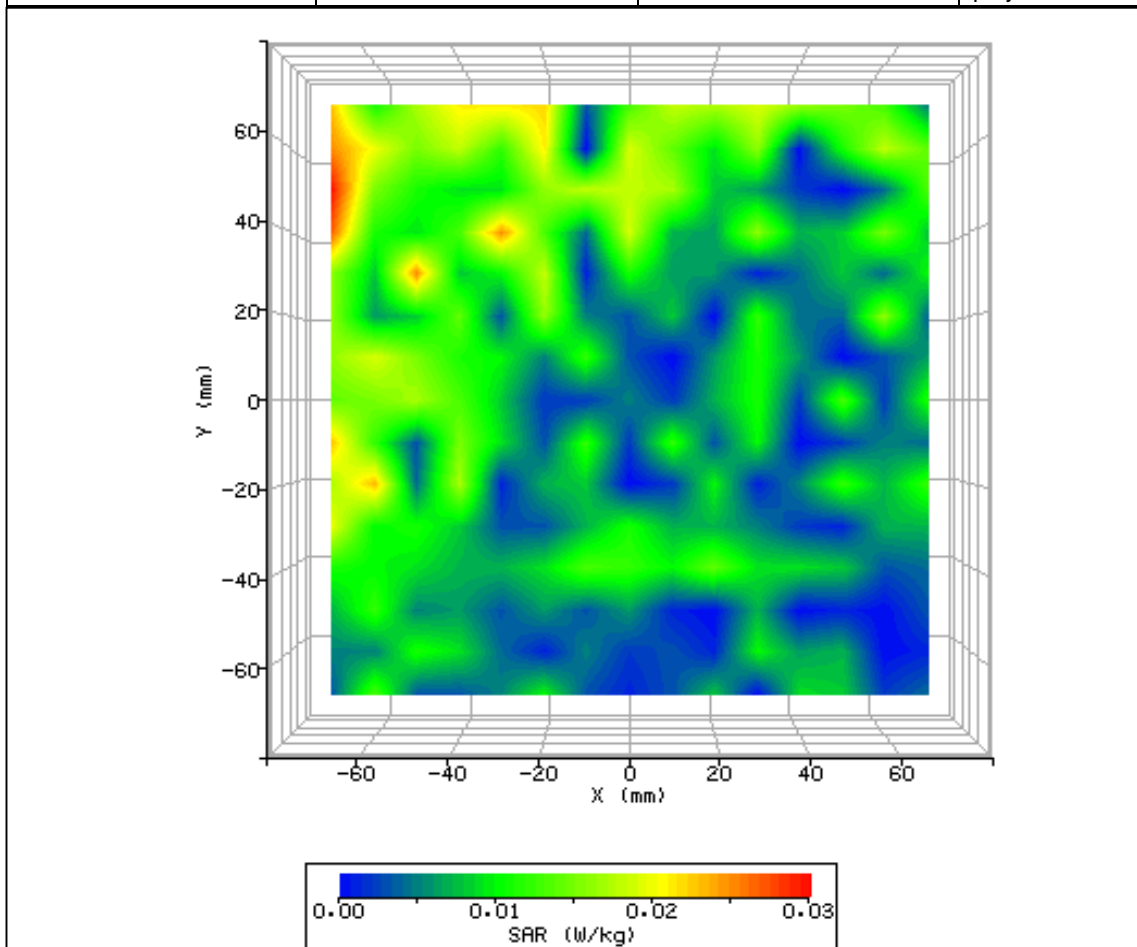

Figure 44: SAR Body Testing Results for the Ericsson Mobile Broadband Module in Screen 90° - Area 2 Phantom Position; Tested at 1880MHz (FDD II Mid Channel) with 2mm Separation Distance to the Phantom (NUA).

SYSTEM / SOFTWARE:	SARA2 / 2.53 VPM	INPUT POWER DRIFT:	0.0 dB
DATE / TIME:	31/07/2008 15:43:55	DUT BATTERY MODEL/NO:	N/A
FILENAME:	75903561-40a.txt	PROBE SERIAL NUMBER:	0171
AMBIENT TEMPERATURE:	23.80°C	LIQUID SIMULANT:	1900Body
DEVICE UNDER TEST:	Ericsson Module	RELATIVE PERMITTIVITY:	52.83
RELATIVE HUMIDITY:	52.10%	CONDUCTIVITY:	1.562
PHANTOM S/NO:	HeadBox.csv	LIQUID TEMPERATURE:	23.00°C
PHANTOM ROTATION:	0°	MAX SAR X-AXIS LOCATION:	-70.00mm
DUT POSITION:	Screen 90° - Area 3	MAX SAR Y-AXIS LOCATION:	70.00mm
ANTENNA CONFIGURATION:	N/A	MAX E FIELD:	3.11 V/m
TEST FREQUENCY:	1880MHz	SAR 1g:	N/A
AIR FACTORS:	421 / 374 / 405	SAR 10g:	N/A
CONVERSION FACTORS:	0.278 / 0.278 / 0.278	SAR START:	N/A
TYPE OF MODULATION:	QPSK (RMC Mode)	SAR END:	N/A
MODN. DUTY CYCLE:	100.0 %	SAR DRIFT DURING SCAN:	0.00 %
DIODE COMPRESSION FACTORS (V*200):	20 / 20 / 20	PROBE BATTERY LAST CHANGED:	31/07/2008
INPUT POWER LEVEL:	24 dBm	EXTRAPOLATION:	poly4

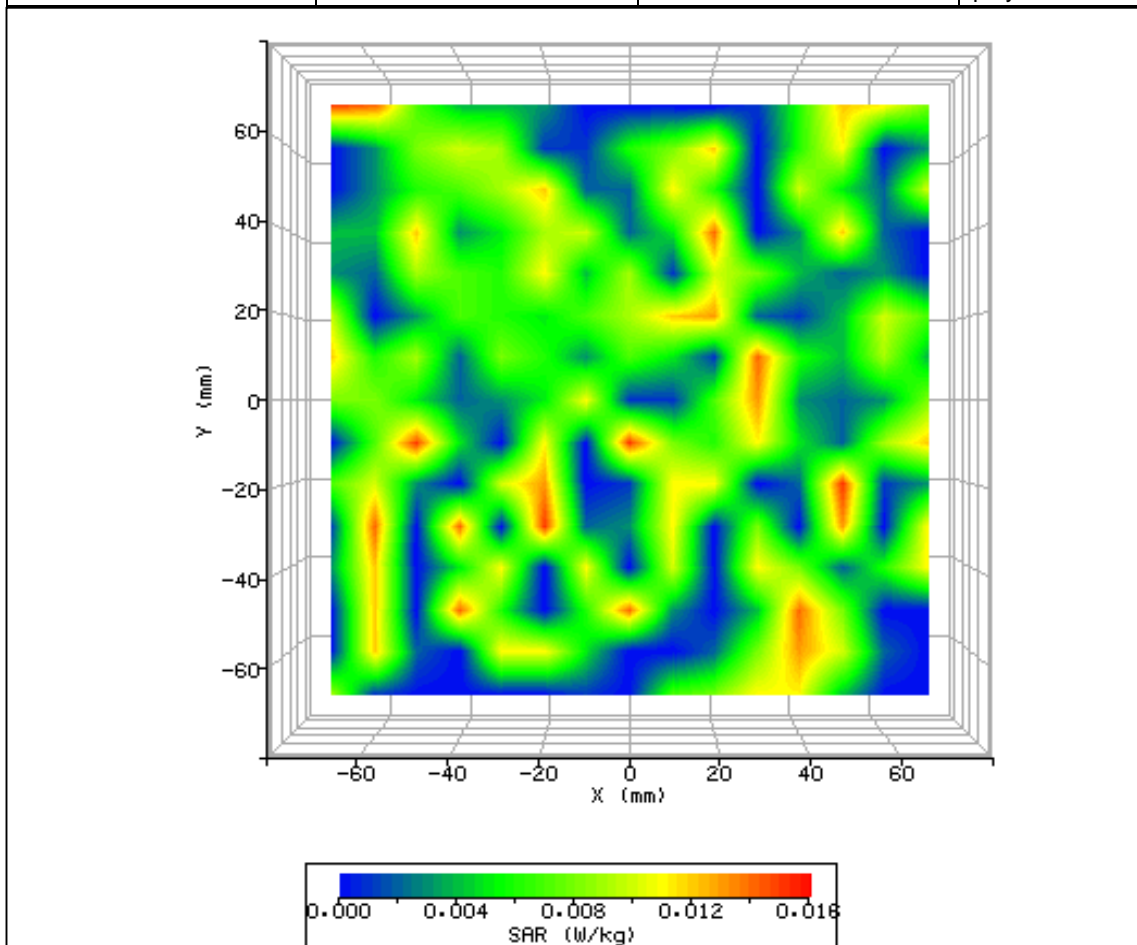

Figure 45: SAR Body Testing Results for the Ericsson Mobile Broadband Module in Screen 90° - Area 3 Phantom Position; Tested at 1880MHz (FDD II Mid Channel) with 2mm Separation Distance to the Phantom (NUA).

SYSTEM / SOFTWARE:	SARA2 / 2.53 VPM	INPUT POWER DRIFT:	0.0 dB
DATE / TIME:	31/07/2008 15:55:16	DUT BATTERY MODEL/NO:	N/A
FILENAME:	75903561-41a.txt	PROBE SERIAL NUMBER:	0171
AMBIENT TEMPERATURE:	23.80°C	LIQUID SIMULANT:	1900Body
DEVICE UNDER TEST:	Ericsson Module	RELATIVE PERMITTIVITY:	52.83
RELATIVE HUMIDITY:	53.20%	CONDUCTIVITY:	1.562
PHANTOM S/NO:	HeadBox.csv	LIQUID TEMPERATURE:	23.10°C
PHANTOM ROTATION:	0°	MAX SAR X-AXIS LOCATION:	Off Edge
DUT POSITION:	Screen 90° - Area 4	MAX SAR Y-AXIS LOCATION:	Off Edge
ANTENNA CONFIGURATION:	N/A	MAX E FIELD:	4.48 V/m
TEST FREQUENCY:	1880MHz	SAR 1g:	N/A
AIR FACTORS:	421 / 374 / 405	SAR 10g:	N/A
CONVERSION FACTORS:	0.278 / 0.278 / 0.278	SAR START:	N/A
TYPE OF MODULATION:	QPSK (RMC Mode)	SAR END:	N/A
MODN. DUTY CYCLE:	100.0 %	SAR DRIFT DURING SCAN:	0.00 %
DIODE COMPRESSION FACTORS (V*200):	20 / 20 / 20	PROBE BATTERY LAST CHANGED:	31/07/2008
INPUT POWER LEVEL:	24 dBm	EXTRAPOLATION:	poly4

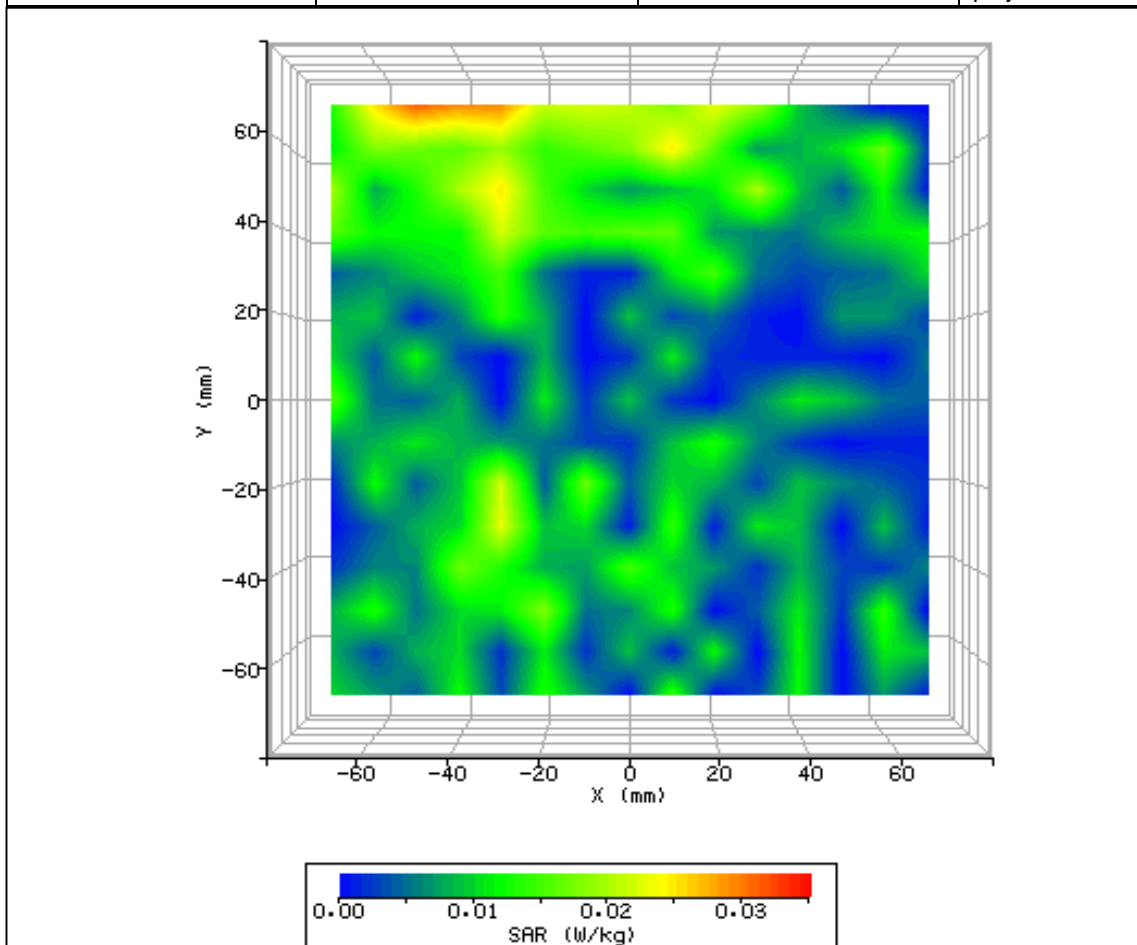

Figure 46: SAR Body Testing Results for the Ericsson Mobile Broadband Module in Screen 90° - Area 4 Phantom Position; Tested at 1880MHz (FDD II Mid Channel) with 2mm Separation Distance to the Phantom (NUA).



SYSTEM / SOFTWARE:	SARA2 / 2.53 VPM	INPUT POWER DRIFT:	0.0 dB
DATE / TIME:	31/07/2008 16:05:22	DUT BATTERY MODEL/NO:	N/A
FILENAME:	75903561-42a.txt	PROBE SERIAL NUMBER:	0171
AMBIENT TEMPERATURE:	23.50°C	LIQUID SIMULANT:	1900Body
DEVICE UNDER TEST:	Ericsson Module	RELATIVE PERMITTIVITY:	52.83
RELATIVE HUMIDITY:	53.90%	CONDUCTIVITY:	1.562
PHANTOM S/NO:	HeadBox.csv	LIQUID TEMPERATURE:	23.20°C
PHANTOM ROTATION:	0°	MAX SAR X-AXIS LOCATION:	-52.00mm
DUT POSITION:	Screen 90° - Area 5	MAX SAR Y-AXIS LOCATION:	70.00mm
ANTENNA CONFIGURATION:	N/A	MAX E FIELD:	3.36 V/m
TEST FREQUENCY:	1880MHz	SAR 1g:	N/A
AIR FACTORS:	421 / 374 / 405	SAR 10g:	N/A
CONVERSION FACTORS:	0.278 / 0.278 / 0.278	SAR START:	N/A
TYPE OF MODULATION:	QPSK (RMC Mode)	SAR END:	N/A
MODN. DUTY CYCLE:	100.0 %	SAR DRIFT DURING SCAN:	0.00 %
DIODE COMPRESSION FACTORS (V*200):	20 / 20 / 20	PROBE BATTERY LAST CHANGED:	31/07/2008
INPUT POWER LEVEL:	24 dBm	EXTRAPOLATION:	poly4

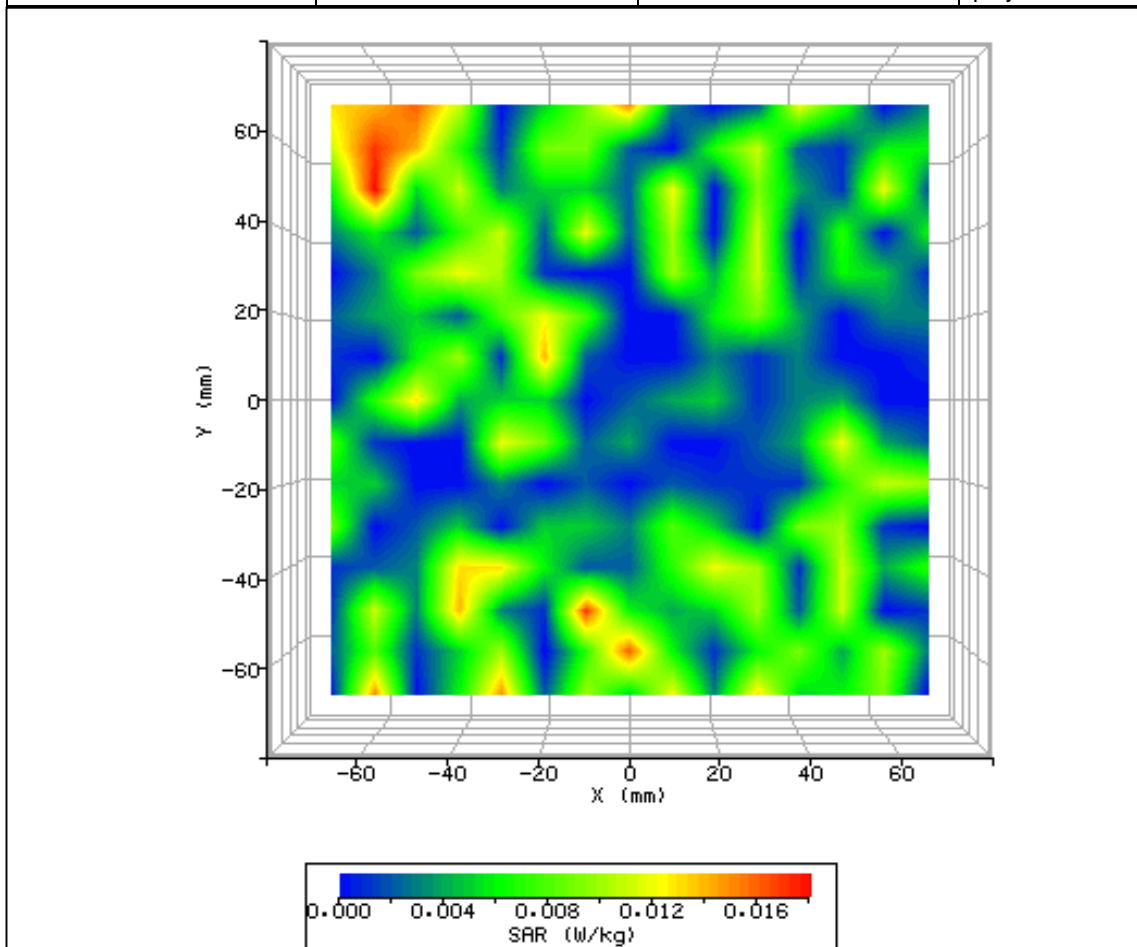

Figure 47: SAR Body Testing Results for the Ericsson Mobile Broadband Module in Screen 90° - Area 5 Phantom Position; Tested at 1880MHz (FDD II Mid Channel) with 2mm Separation Distance to the Phantom (NUA).

SYSTEM / SOFTWARE:	SARA2 / 2.53 VPM	INPUT POWER DRIFT:	0.0 dB
DATE / TIME:	31/07/2008 16:14:56	DUT BATTERY MODEL/NO:	N/A
FILENAME:	75903561-43a.txt	PROBE SERIAL NUMBER:	0171
AMBIENT TEMPERATURE:	23.40°C	LIQUID SIMULANT:	1900Body
DEVICE UNDER TEST:	Ericsson Module	RELATIVE PERMITTIVITY:	52.83
RELATIVE HUMIDITY:	55.60%	CONDUCTIVITY:	1.562
PHANTOM S/NO:	HeadBox.csv	LIQUID TEMPERATURE:	23.20°C
PHANTOM ROTATION:	0°	MAX SAR X-AXIS LOCATION:	Off Edge
DUT POSITION:	Screen 90° - Area 6	MAX SAR Y-AXIS LOCATION:	Off Edge
ANTENNA CONFIGURATION:	N/A	MAX E FIELD:	2.95 V/m
TEST FREQUENCY:	1880MHz	SAR 1g:	N/A
AIR FACTORS:	421 / 374 / 405	SAR 10g:	N/A
CONVERSION FACTORS:	0.278 / 0.278 / 0.278	SAR START:	N/A
TYPE OF MODULATION:	QPSK (RMC Mode)	SAR END:	N/A
MODN. DUTY CYCLE:	100.0 %	SAR DRIFT DURING SCAN:	0.00 %
DIODE COMPRESSION FACTORS (V*200):	20 / 20 / 20	PROBE BATTERY LAST CHANGED:	31/07/2008
INPUT POWER LEVEL:	24 dBm	EXTRAPOLATION:	poly4

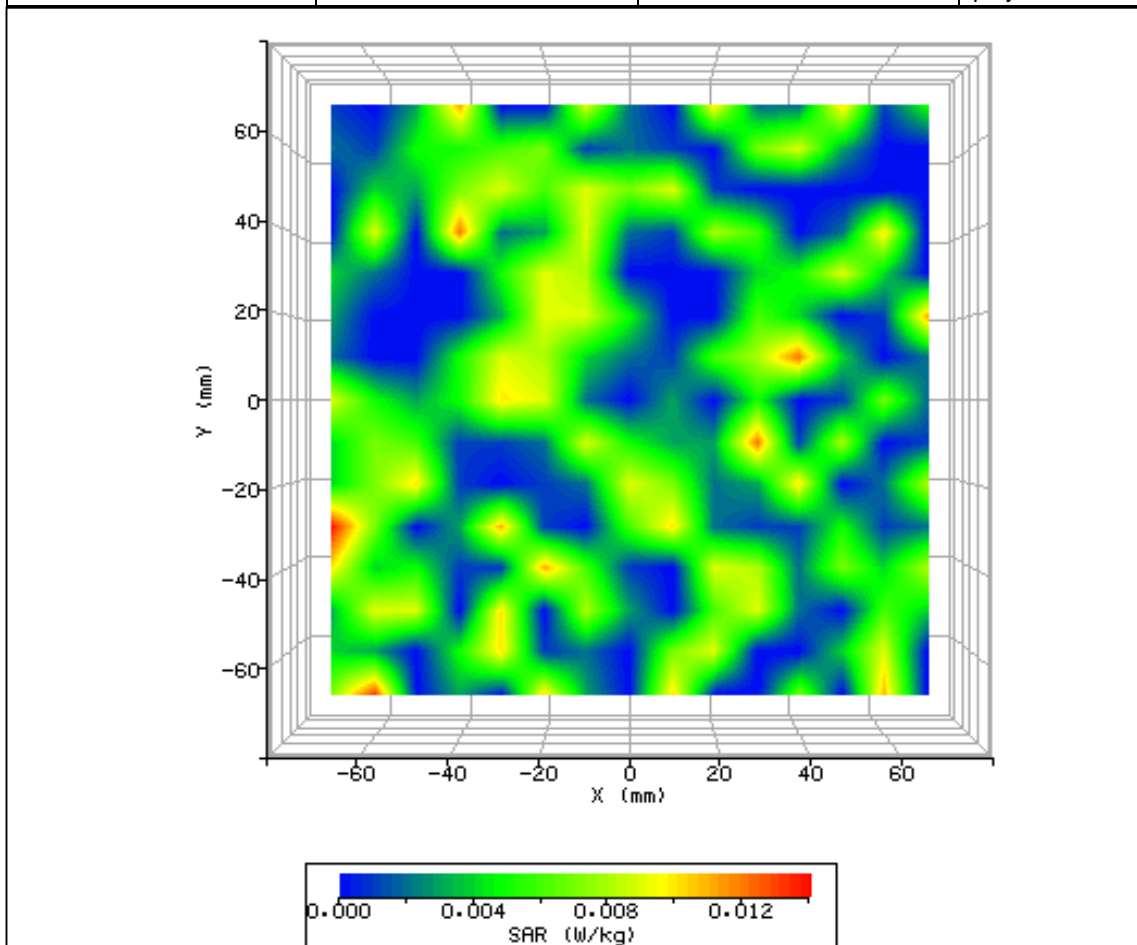

Figure 48: SAR Body Testing Results for the Ericsson Mobile Broadband Module in Screen 90° - Area 6 Phantom Position; Tested at 1880MHz (FDD II Mid Channel) with 2mm Separation Distance to the Phantom (NUA).

SYSTEM / SOFTWARE:	SARA2 / 2.53 VPM	INPUT POWER DRIFT:	0.0 dB
DATE / TIME:	31/07/2008 16:45:46	DUT BATTERY MODEL/NO:	N/A
FILENAME:	75903561-44.txt	PROBE SERIAL NUMBER:	0171
AMBIENT TEMPERATURE:	23.50°C	LIQUID SIMULANT:	1900Body
DEVICE UNDER TEST:	Ericsson Module	RELATIVE PERMITTIVITY:	52.83
RELATIVE HUMIDITY:	56.10%	CONDUCTIVITY:	1.562
PHANTOM S/NO:	HeadBox.csv	LIQUID TEMPERATURE:	23.30°C
PHANTOM ROTATION:	0°	MAX SAR X-AXIS LOCATION:	-34.00mm
DUT POSITION:	Screen 90° - Area 1	MAX SAR Y-AXIS LOCATION:	37.00mm
ANTENNA CONFIGURATION:	N/A	MAX E FIELD:	6.74 V/m
TEST FREQUENCY:	1880MHz	SAR 1g:	0.084 W/kg
AIR FACTORS:	421 / 374 / 405	SAR 10g:	0.053 W/kg
CONVERSION FACTORS:	0.278 / 0.278 / 0.278	SAR START:	0.018 W/kg
TYPE OF MODULATION:	QPSK (RMC+HSDPA Mode)	SAR END:	0.018 W/kg
MODN. DUTY CYCLE:	100.0 %	SAR DRIFT DURING SCAN:	0.00 %
DIODE COMPRESSION FACTORS (V*200):	20 / 20 / 20	PROBE BATTERY LAST CHANGED:	31/07/2008
INPUT POWER LEVEL:	24 dBm	EXTRAPOLATION:	poly4

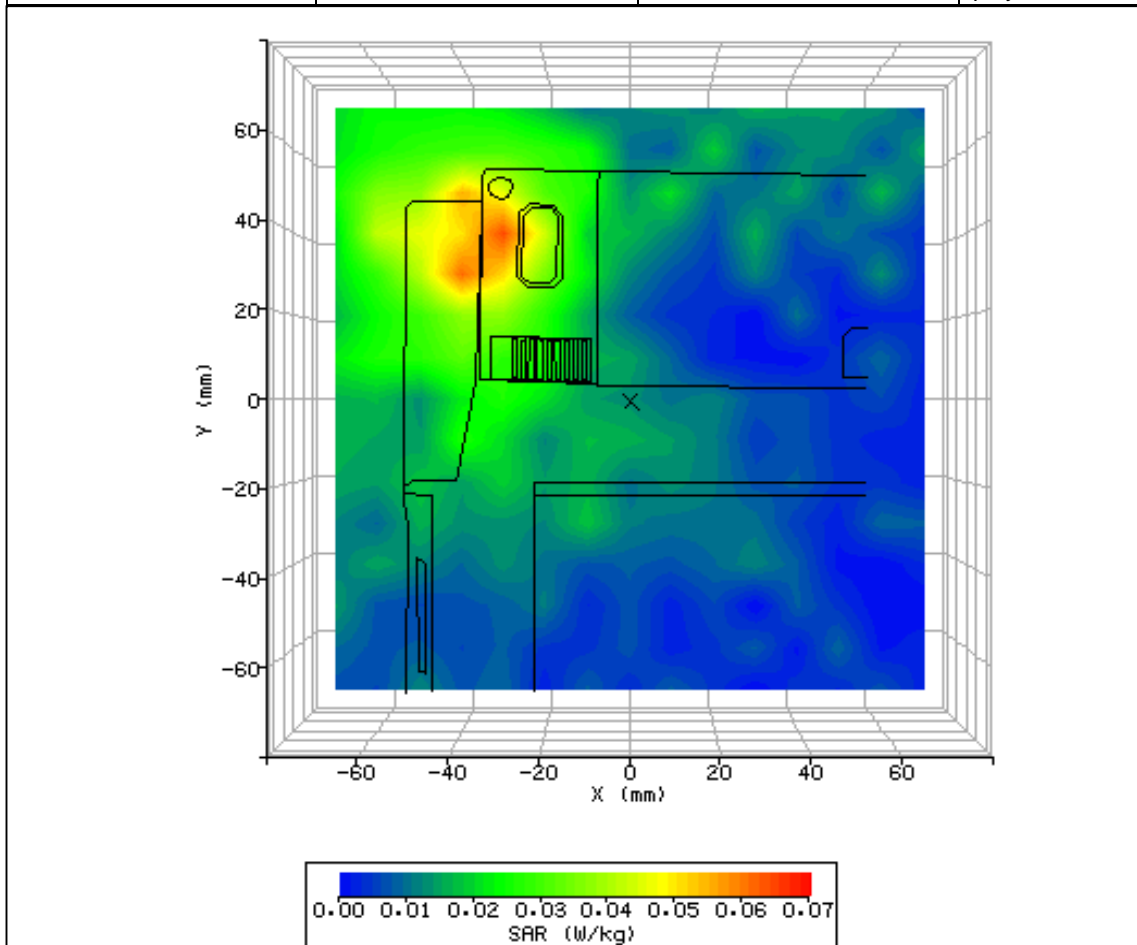

Figure 49: SAR Body Testing Results for the Ericsson Mobile Broadband Module in Screen 90° - Area 1 Phantom Position; Tested at 1880MHz (FDD II Mid Channel) with 2mm Separation Distance to the Phantom (NUA).

SYSTEM / SOFTWARE:	SARA2 / 2.53 VPM	INPUT POWER DRIFT:	0.0 dB
DATE / TIME:	01/08/2008 11:18:13	DUT BATTERY MODEL/NO:	N/A
FILENAME:	75903561-45.txt	PROBE SERIAL NUMBER:	0171
AMBIENT TEMPERATURE:	22.20°C	LIQUID SIMULANT:	1900Body
DEVICE UNDER TEST:	Ericsson Module	RELATIVE PERMITTIVITY:	52.83
RELATIVE HUMIDITY:	49.70%	CONDUCTIVITY:	1.562
PHANTOM S/NO:	HeadBox.csv	LIQUID TEMPERATURE:	23.00°C
PHANTOM ROTATION:	0°	MAX SAR X-AXIS LOCATION:	-39.00mm
DUT POSITION:	Screen 90° - Area 1	MAX SAR Y-AXIS LOCATION:	-34.00mm
ANTENNA CONFIGURATION:	N/A	MAX E FIELD:	7.52 V/m
TEST FREQUENCY:	1880MHz	SAR 1g:	0.105 W/kg
AIR FACTORS:	421 / 374 / 405	SAR 10g:	0.063 W/kg
CONVERSION FACTORS:	0.278 / 0.278 / 0.278	SAR START:	0.021 W/kg
TYPE OF MODULATION:	QPSK (RMC+HSUPA Mode)	SAR END:	0.022 W/kg
MODN. DUTY CYCLE:	100.0 %	SAR DRIFT DURING SCAN:	2.01 %
DIODE COMPRESSION FACTORS (V*200):	20 / 20 / 20	PROBE BATTERY LAST CHANGED:	01/08/2008
INPUT POWER LEVEL:	24 dBm	EXTRAPOLATION:	poly4

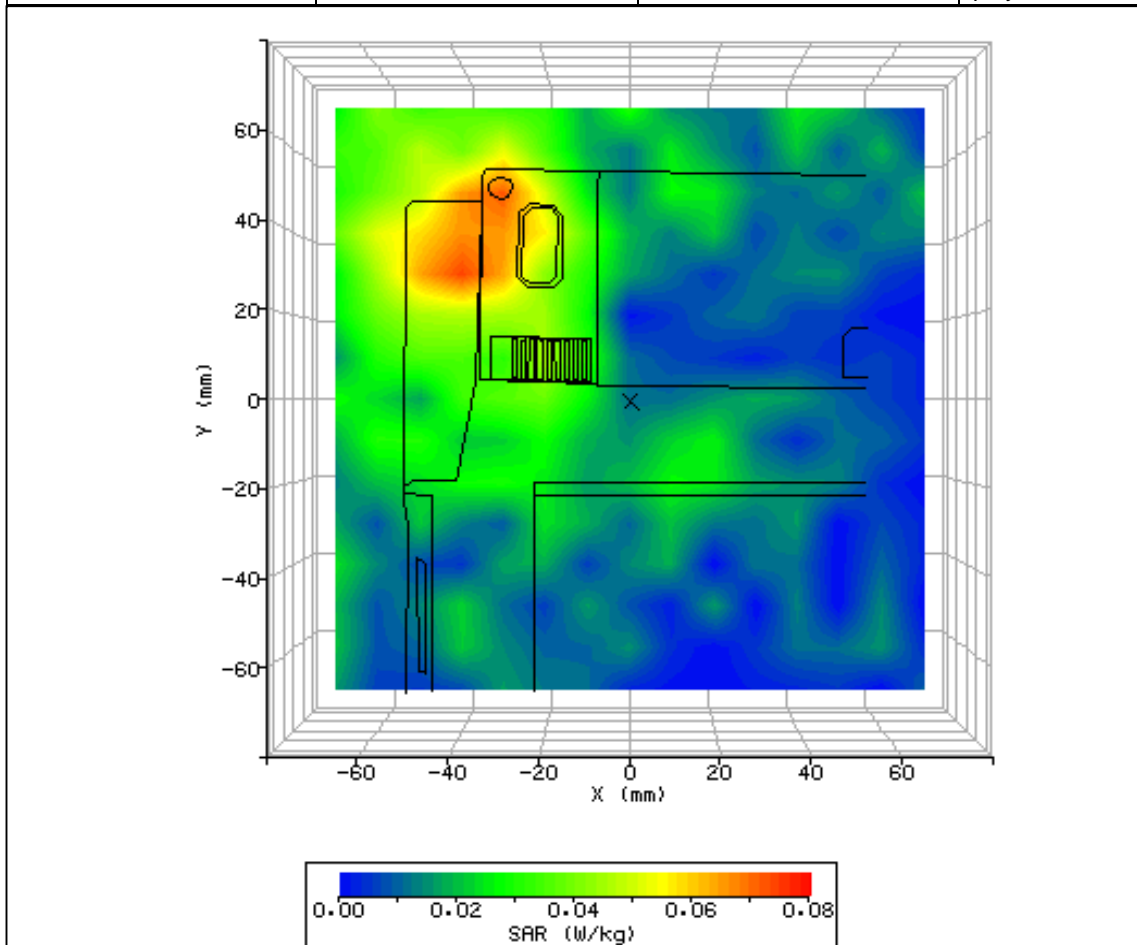

Figure 50: SAR Body Testing Results for the Ericsson Mobile Broadband Module in Screen 90° - Area 1 Phantom Position; Tested at 1880MHz (FDD II Mid Channel) with 2mm Separation Distance to the Phantom (NUA).

2.9 WCDMA FDDV BODY SAR TEST RESULTS AND COURSE AREA SCANS – 2D

SYSTEM / SOFTWARE:	SARA2 / 2.53 VPM	INPUT POWER DRIFT:	0.0 dB
DATE / TIME:	29/07/2008 15:43:05	DUT BATTERY MODEL/NO:	N/A
FILENAME:	75903561-46a.txt	PROBE SERIAL NUMBER:	0171
AMBIENT TEMPERATURE:	22.60°C	LIQUID SIMULANT:	850Body
DEVICE UNDER TEST:	Ericsson Module	RELATIVE PERMITTIVITY:	58.20
RELATIVE HUMIDITY:	51.50%	CONDUCTIVITY:	0.998
PHANTOM S/NO:	HeadBox.csv	LIQUID TEMPERATURE:	22.50°C
PHANTOM ROTATION:	0°	MAX SAR X-AXIS LOCATION:	-35.00mm
DUT POSITION:	Screen 90° - Area 1	MAX SAR Y-AXIS LOCATION:	37.00mm
ANTENNA CONFIGURATION:	N/A	MAX E FIELD:	4.86 V/m
TEST FREQUENCY:	835MHz	SAR 1g:	N/A
AIR FACTORS:	421 / 374 / 405	SAR 10g:	N/A
CONVERSION FACTORS:	0.278 / 0.278 / 0.278	SAR START:	N/A
TYPE OF MODULATION:	QPSK (RMC Mode)	SAR END:	N/A
MODN. DUTY CYCLE:	100.0 %	SAR DRIFT DURING SCAN:	0.00 %
DIODE COMPRESSION FACTORS (V*200):	20 / 20 / 20	PROBE BATTERY LAST CHANGED:	29/07/2008
INPUT POWER LEVEL:	24 dBm	EXTRAPOLATION:	poly4

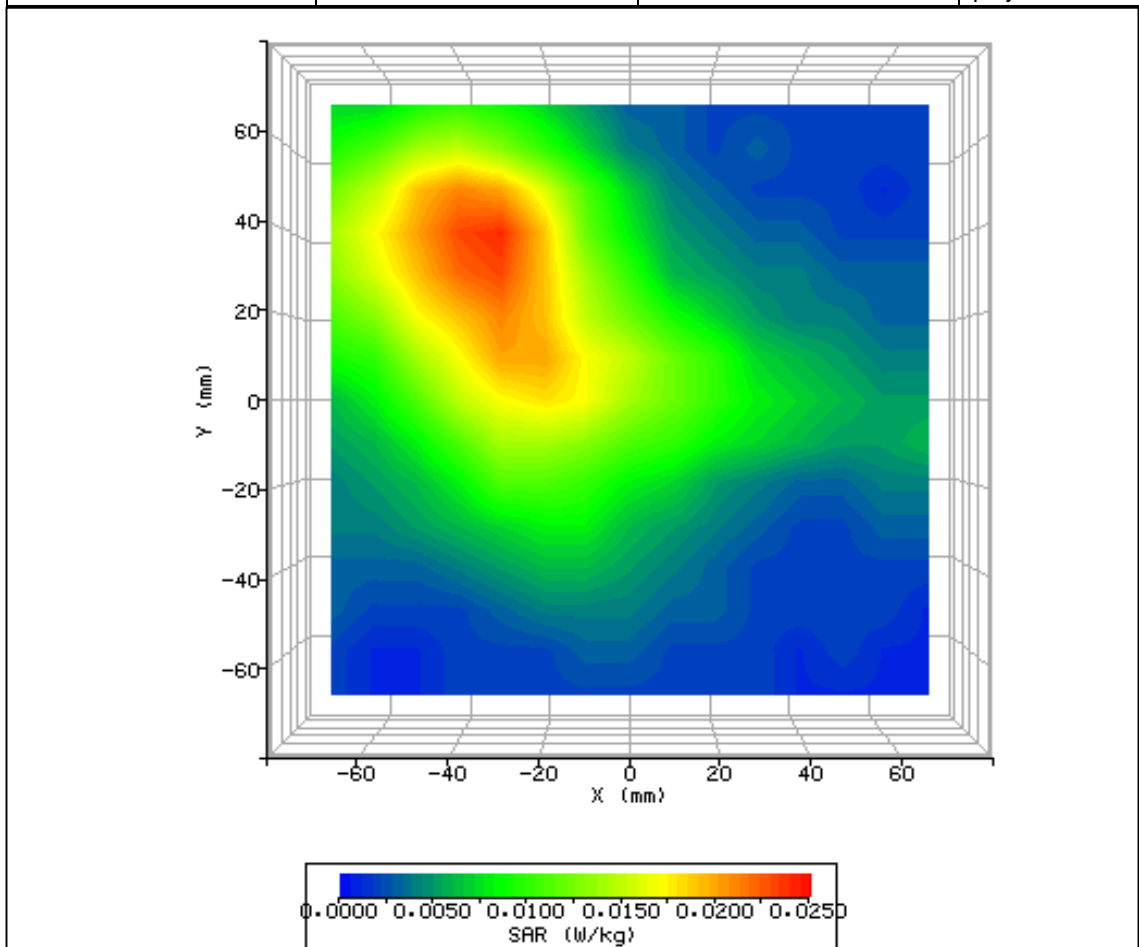

Figure 51: SAR Body Testing Results for the Ericsson Mobile Broadband Module in Screen 90° - Area 1 Phantom Position; Tested at 835MHz (FDDV Mid Channel) with 2mm Separation Distance to the Phantom (NUA).

SYSTEM / SOFTWARE:	SARA2 / 2.53 VPM	INPUT POWER DRIFT:	0.0 dB
DATE / TIME:	29/07/2008 15:53:34	DUT BATTERY MODEL/NO:	N/A
FILENAME:	75903561-47a.txt	PROBE SERIAL NUMBER:	0171
AMBIENT TEMPERATURE:	22.60°C	LIQUID SIMULANT:	850Body
DEVICE UNDER TEST:	Ericsson Module	RELATIVE PERMITTIVITY:	58.20
RELATIVE HUMIDITY:	50.50%	CONDUCTIVITY:	0.998
PHANTOM S/NO:	HeadBox.csv	LIQUID TEMPERATURE:	22.50°C
PHANTOM ROTATION:	0°	MAX SAR X-AXIS LOCATION:	Off Edge
DUT POSITION:	Screen 90° - Area 2	MAX SAR Y-AXIS LOCATION:	Off Edge
ANTENNA CONFIGURATION:	N/A	MAX E FIELD:	3.65 V/m
TEST FREQUENCY:	835MHz	SAR 1g:	N/A
AIR FACTORS:	421 / 374 / 405	SAR 10g:	N/A
CONVERSION FACTORS:	0.278 / 0.278 / 0.278	SAR START:	N/A
TYPE OF MODULATION:	QPSK (RMC Mode)	SAR END:	N/A
MODN. DUTY CYCLE:	100.0 %	SAR DRIFT DURING SCAN:	0.00 %
DIODE COMPRESSION FACTORS (V*200):	20 / 20 / 20	PROBE BATTERY LAST CHANGED:	29/07/2008
INPUT POWER LEVEL:	24 dBm	EXTRAPOLATION:	poly4

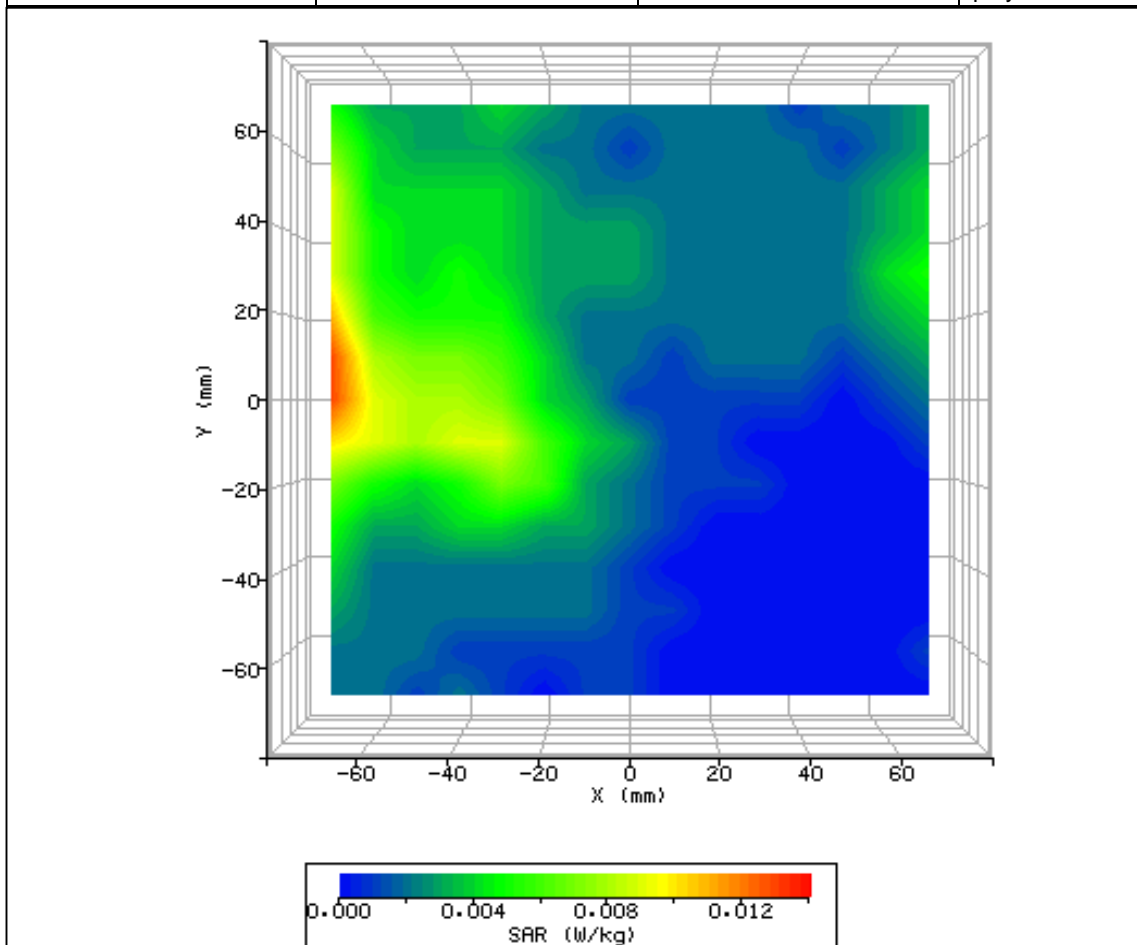

Figure 52: SAR Body Testing Results for the Ericsson Mobile Broadband Module in Screen 90° - Area 2 Phantom Position; Tested at 835MHz (FDDV Middle Channel) with 2mm Separation Distance to the Phantom (NUA).

SYSTEM / SOFTWARE:	SARA2 / 2.53 VPM	INPUT POWER DRIFT:	0.0 dB
DATE / TIME:	29/07/2008 16:07:10	DUT BATTERY MODEL/NO:	N/A
FILENAME:	75903561-48a.txt	PROBE SERIAL NUMBER:	0171
AMBIENT TEMPERATURE:	22.50°C	LIQUID SIMULANT:	850Body
DEVICE UNDER TEST:	Ericsson Module	RELATIVE PERMITTIVITY:	58.20
RELATIVE HUMIDITY:	52.70%	CONDUCTIVITY:	0.998
PHANTOM S/NO:	HeadBox.csv	LIQUID TEMPERATURE:	22.50°C
PHANTOM ROTATION:	0°	MAX SAR X-AXIS LOCATION:	13.00mm
DUT POSITION:	Screen 90° - Area 3	MAX SAR Y-AXIS LOCATION:	35.00mm
ANTENNA CONFIGURATION:	N/A	MAX E FIELD:	2.28 V/m
TEST FREQUENCY:	835MHz	SAR 1g:	N/A
AIR FACTORS:	421 / 374 / 405	SAR 10g:	N/A
CONVERSION FACTORS:	0.278 / 0.278 / 0.278	SAR START:	N/A
TYPE OF MODULATION:	QPSK (RMC Mode)	SAR END:	N/A
MODN. DUTY CYCLE:	100.0 %	SAR DRIFT DURING SCAN:	0.00 %
DIODE COMPRESSION FACTORS (V*200):	20 / 20 / 20	PROBE BATTERY LAST CHANGED:	29/07/2008
INPUT POWER LEVEL:	24 dBm	EXTRAPOLATION:	poly4

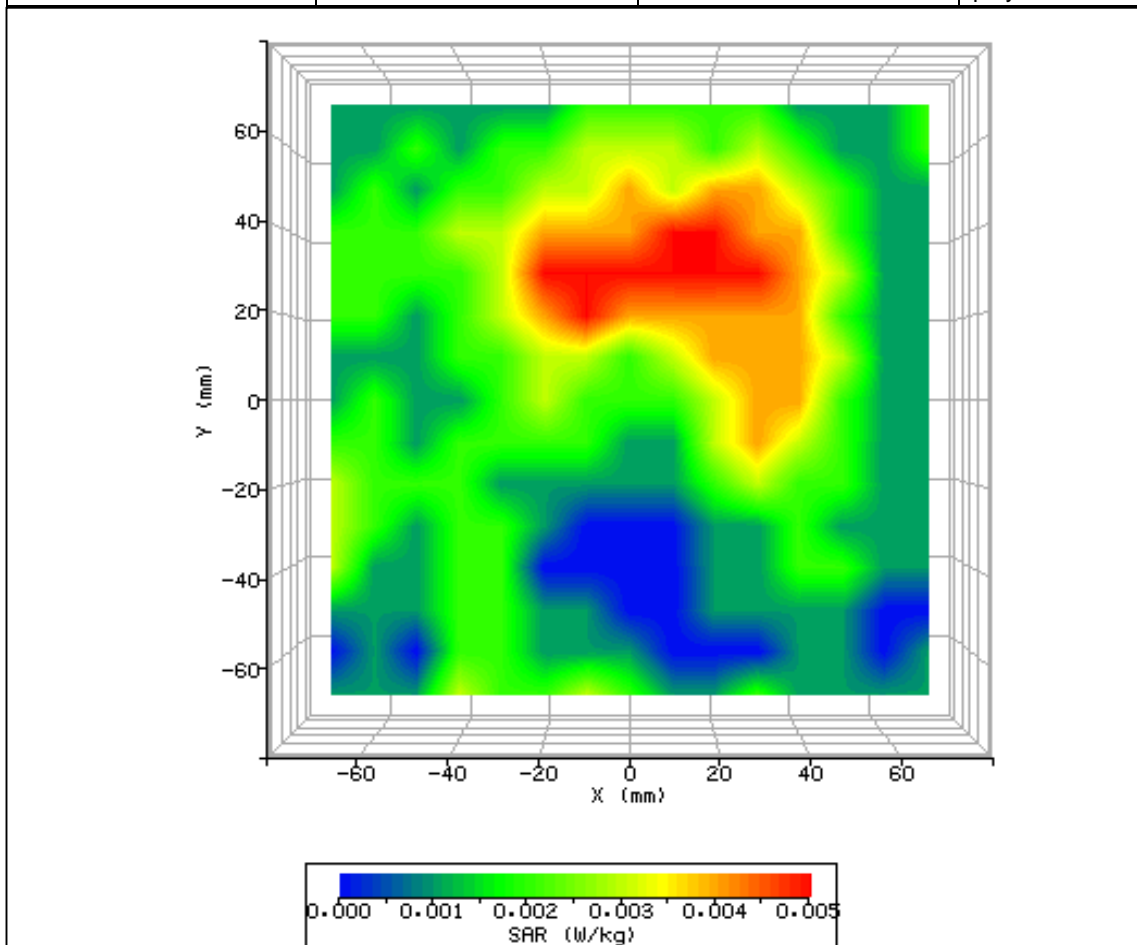

Figure 53: SAR Body Testing Results for the Ericsson Mobile Broadband Module in Screen 90° - Area 3 Phantom Position; Tested at 835MHz (FDDV Middle Channel) with 2mm Separation Distance to the Phantom (NUA).



Product Service

SYSTEM / SOFTWARE:	SARA2 / 2.53 VPM	INPUT POWER DRIFT:	0.0 dB
DATE / TIME:	29/07/2008 16:34:52	DUT BATTERY MODEL/NO:	N/A
FILENAME:	75903561-49a.txt	PROBE SERIAL NUMBER:	0171
AMBIENT TEMPERATURE:	22.50°C	LIQUID SIMULANT:	850Body
DEVICE UNDER TEST:	Ericsson Module	RELATIVE PERMITTIVITY:	58.20
RELATIVE HUMIDITY:	53.10%	CONDUCTIVITY:	0.998
PHANTOM S/NO:	HeadBox.csv	LIQUID TEMPERATURE:	22.50°C
PHANTOM ROTATION:	0°	MAX SAR X-AXIS LOCATION:	Off Edge
DUT POSITION:	Screen 90° - Area 4	MAX SAR Y-AXIS LOCATION:	Off Edge
ANTENNA CONFIGURATION:	N/A	MAX E FIELD:	4.32 V/m
TEST FREQUENCY:	835MHz	SAR 1g:	N/A
AIR FACTORS:	421 / 374 / 405	SAR 10g:	N/A
CONVERSION FACTORS:	0.278 / 0.278 / 0.278	SAR START:	N/A
TYPE OF MODULATION:	QPSK (RMC Mode)	SAR END:	N/A
MODN. DUTY CYCLE:	100.0 %	SAR DRIFT DURING SCAN:	0.00 %
DIODE COMPRESSION FACTORS (V*200):	20 / 20 / 20	PROBE BATTERY LAST CHANGED:	29/07/2008
INPUT POWER LEVEL:	24 dBm	EXTRAPOLATION:	poly4

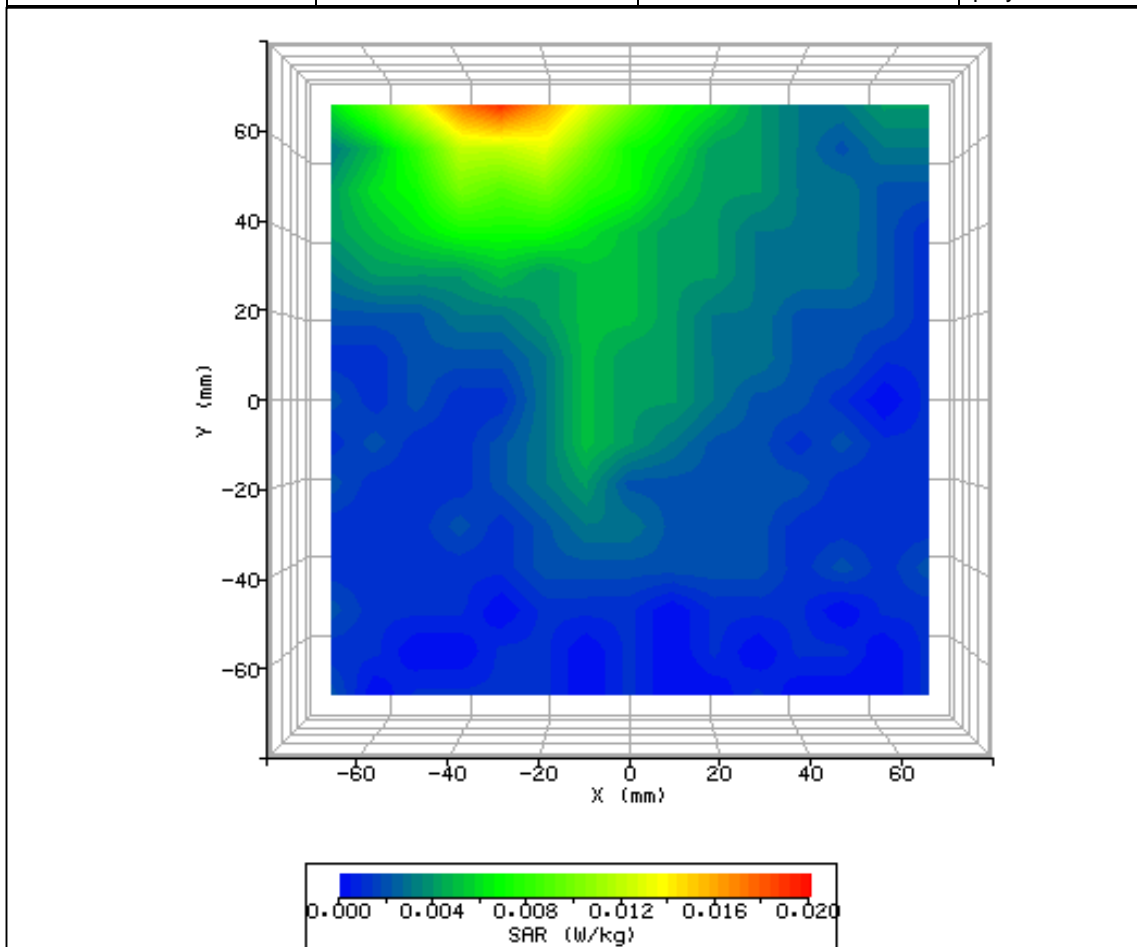

Figure 54: SAR Body Testing Results for the Ericsson Mobile Broadband Module in Screen 90° - Area 4 Phantom Position; Tested at 835MHz (FDDV Middle Channel) with 2mm Separation Distance to the Phantom (NUA).



SYSTEM / SOFTWARE:	SARA2 / 2.53 VPM	INPUT POWER DRIFT:	0.0 dB
DATE / TIME:	29/07/2008 16:44:27	DUT BATTERY MODEL/NO:	N/A
FILENAME:	75903561-50a.txt	PROBE SERIAL NUMBER:	0171
AMBIENT TEMPERATURE:	22.40°C	LIQUID SIMULANT:	850Body
DEVICE UNDER TEST:	Ericsson Module	RELATIVE PERMITTIVITY:	58.20
RELATIVE HUMIDITY:	53.00%	CONDUCTIVITY:	0.998
PHANTOM S/NO:	HeadBox.csv	LIQUID TEMPERATURE:	22.50°C
PHANTOM ROTATION:	0°	MAX SAR X-AXIS LOCATION:	Off Edge
DUT POSITION:	Screen 90° - Area 5	MAX SAR Y-AXIS LOCATION:	Off Edge
ANTENNA CONFIGURATION:	N/A	MAX E FIELD:	2.59 V/m
TEST FREQUENCY:	835MHz	SAR 1g:	N/A
AIR FACTORS:	421 / 374 / 405	SAR 10g:	N/A
CONVERSION FACTORS:	0.278 / 0.278 / 0.278	SAR START:	N/A
TYPE OF MODULATION:	QPSK (RMC Mode)	SAR END:	N/A
MODN. DUTY CYCLE:	100.0 %	SAR DRIFT DURING SCAN:	0.00 %
DIODE COMPRESSION FACTORS (V*200):	20 / 20 / 20	PROBE BATTERY LAST CHANGED:	29/07/2008
INPUT POWER LEVEL:	24 dBm	EXTRAPOLATION:	poly4

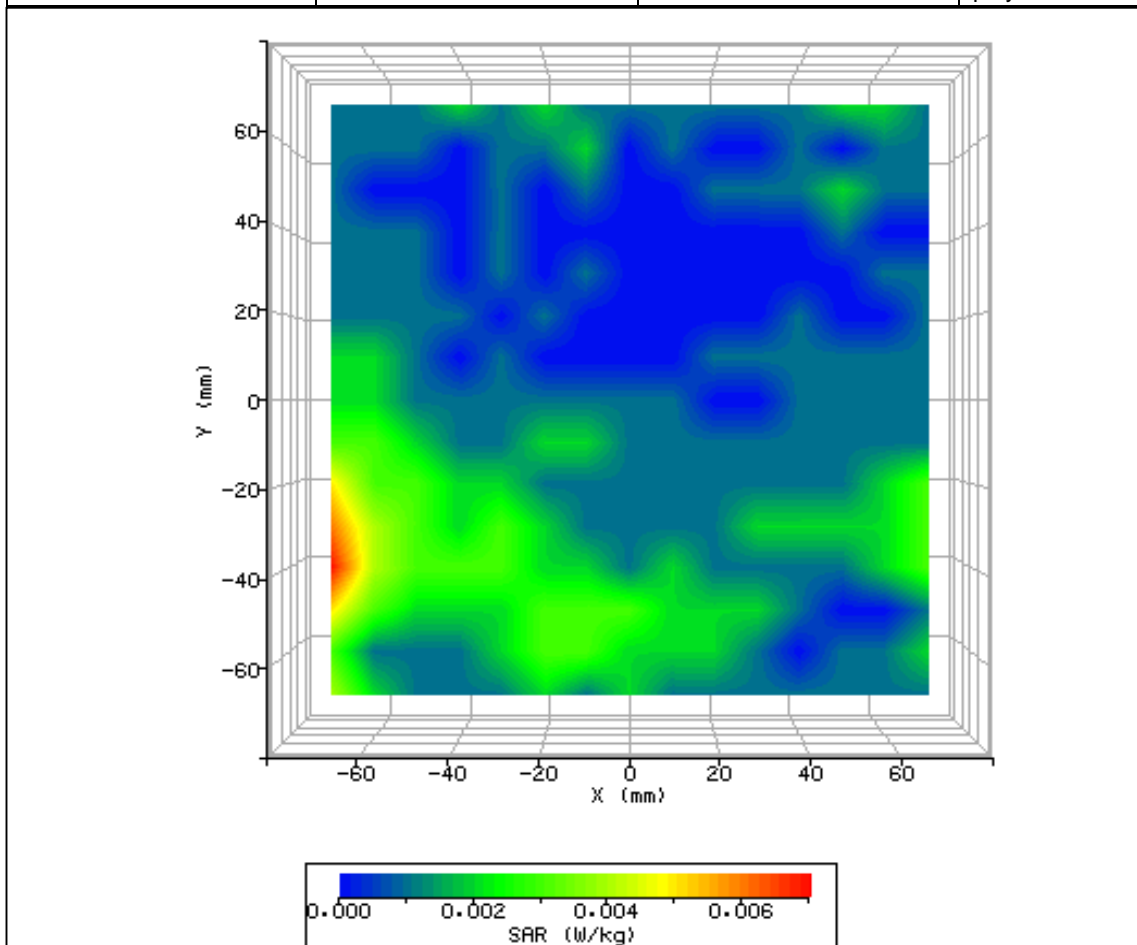

Figure 55: SAR Body Testing Results for the Ericsson Mobile Broadband Module in Screen 90° - Area 5 Phantom Position; Tested at 835MHz (FDDV Middle Channel) with 2mm Separation Distance to the Phantom (NUA).

SYSTEM / SOFTWARE:	SARA2 / 2.53 VPM	INPUT POWER DRIFT:	0.0 dB
DATE / TIME:	29/07/2008 16:55:37	DUT BATTERY MODEL/NO:	N/A
FILENAME:	75903561-51a.txt	PROBE SERIAL NUMBER:	0171
AMBIENT TEMPERATURE:	22.50°C	LIQUID SIMULANT:	850Body
DEVICE UNDER TEST:	Ericsson Module	RELATIVE PERMITTIVITY:	58.20
RELATIVE HUMIDITY:	51.70%	CONDUCTIVITY:	0.998
PHANTOM S/NO:	HeadBox.csv	LIQUID TEMPERATURE:	22.50°C
PHANTOM ROTATION:	0°	MAX SAR X-AXIS LOCATION:	Off Edge
DUT POSITION:	Screen 90° - Area 6	MAX SAR Y-AXIS LOCATION:	Off Edge
ANTENNA CONFIGURATION:	N/A	MAX E FIELD:	2.52 V/m
TEST FREQUENCY:	835MHz	SAR 1g:	N/A
AIR FACTORS:	421 / 374 / 405	SAR 10g:	N/A
CONVERSION FACTORS:	0.278 / 0.278 / 0.278	SAR START:	N/A
TYPE OF MODULATION:	QPSK (RMC Mode)	SAR END:	N/A
MODN. DUTY CYCLE:	100.0 %	SAR DRIFT DURING SCAN:	0.00 %
DIODE COMPRESSION FACTORS (V*200):	20 / 20 / 20	PROBE BATTERY LAST CHANGED:	29/07/2008
INPUT POWER LEVEL:	24 dBm	EXTRAPOLATION:	poly4

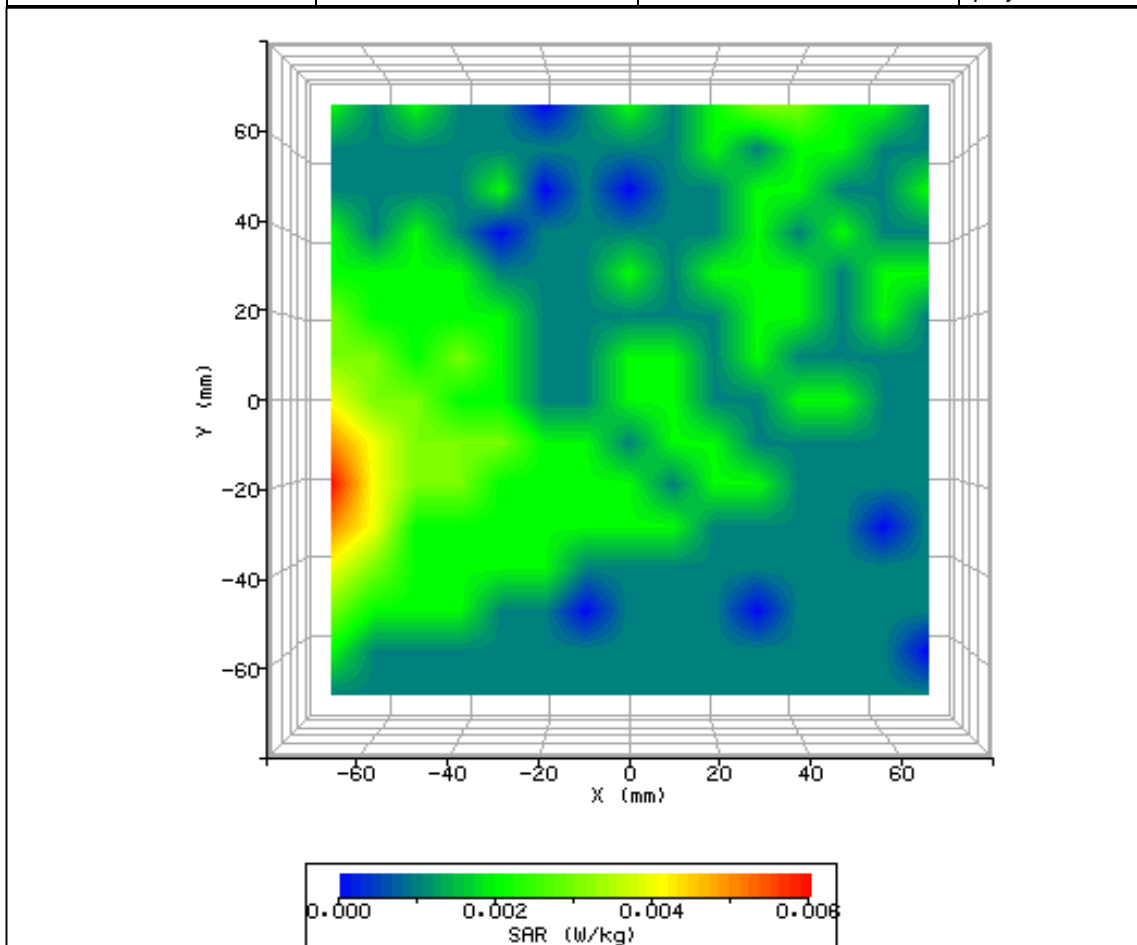

Figure 56: SAR Body Testing Results for the Ericsson Mobile Broadband Module in Screen 90° - Area 6 Phantom Position; Tested at 835MHz (FDDV Middle Channel) with 2mm Separation Distance to the Phantom (NUA).

SYSTEM / SOFTWARE:	SARA2 / 2.53 VPM	INPUT POWER DRIFT:	0.0 dB
DATE / TIME:	30/07/2008 10:06:36	DUT BATTERY MODEL/NO:	N/A
FILENAME:	75903561-52.txt	PROBE SERIAL NUMBER:	0171
AMBIENT TEMPERATURE:	22.90°C	LIQUID SIMULANT:	850Body
DEVICE UNDER TEST:	Ericsson Module	RELATIVE PERMITTIVITY:	58.20
RELATIVE HUMIDITY:	48.90%	CONDUCTIVITY:	0.998
PHANTOM S/NO:	HeadBox.csv	LIQUID TEMPERATURE:	22.70°C
PHANTOM ROTATION:	0°	MAX SAR X-AXIS LOCATION:	-34.000mm
DUT POSITION:	Screen 90° - Area 1	MAX SAR Y-AXIS LOCATION:	48.000mm
ANTENNA CONFIGURATION:	N/A	MAX E FIELD:	5.71 V/m
TEST FREQUENCY:	835MHz	SAR 1g:	0.038 W/kg
AIR FACTORS:	421 / 374 / 405	SAR 10g:	0.026 W/kg
CONVERSION FACTORS:	0.278 / 0.278 / 0.278	SAR START:	0.012 W/kg
TYPE OF MODULATION:	QPSK (RMC Mode)	SAR END:	0.011 W/kg
MODN. DUTY CYCLE:	100.0 %	SAR DRIFT DURING SCAN:	-1.14 %
DIODE COMPRESSION FACTORS (V*200):	20 / 20 / 20	PROBE BATTERY LAST CHANGED:	29/07/2008
INPUT POWER LEVEL:	24 dBm	EXTRAPOLATION:	poly4

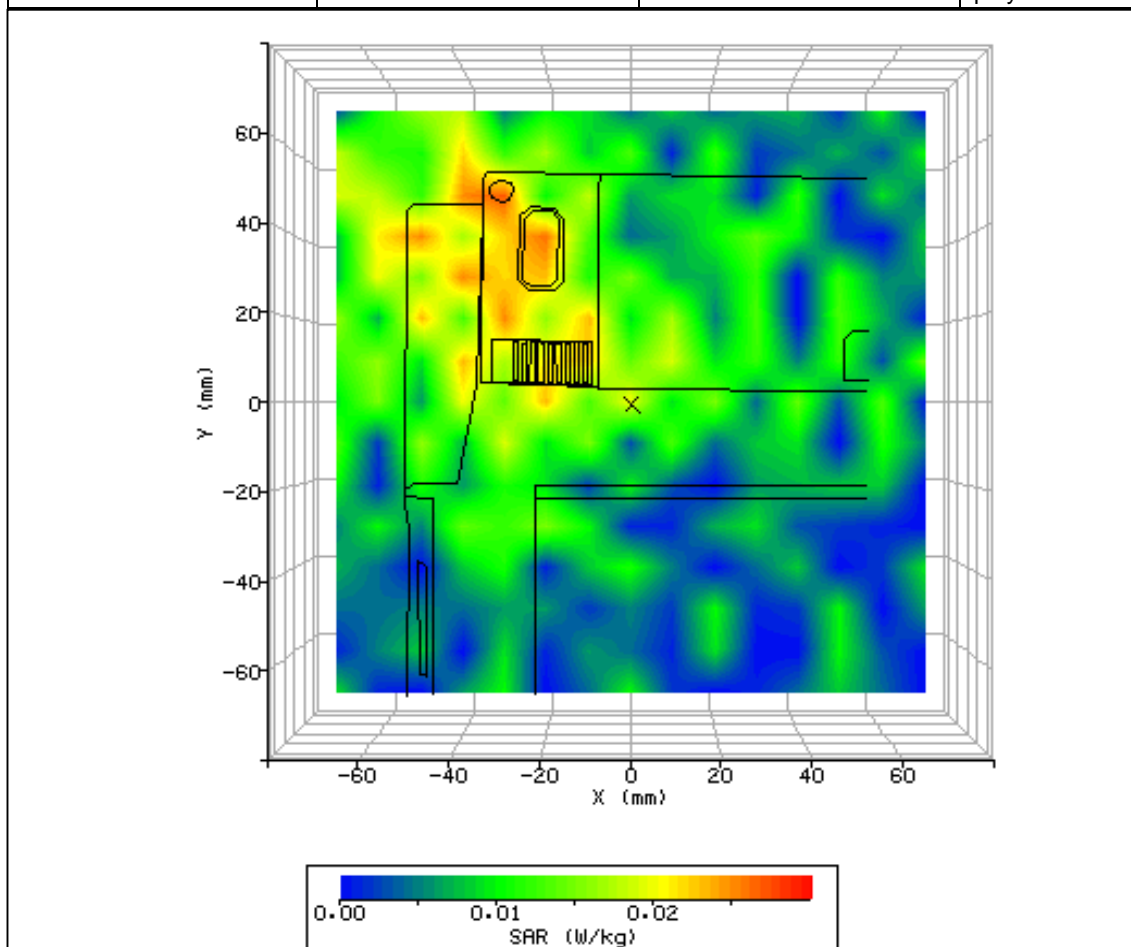

Figure 57: SAR Body Testing Results for the Ericsson Mobile Broadband Module in Screen 90° - Area 1 Phantom Position; Tested at 835MHz (FDDV Middle Channel) with 2mm Separation Distance to the Phantom (NUA).

SYSTEM / SOFTWARE:	SARA2 / 2.53 VPM	INPUT POWER DRIFT:	0.0 dB
DATE / TIME:	30/07/2008 10:55:58	DUT BATTERY MODEL/NO:	N/A
FILENAME:	75903561-53.txt	PROBE SERIAL NUMBER:	0171
AMBIENT TEMPERATURE:	22.80°C	LIQUID SIMULANT:	850Body
DEVICE UNDER TEST:	Ericsson Module	RELATIVE PERMITTIVITY:	58.20
RELATIVE HUMIDITY:	49.40%	CONDUCTIVITY:	0.998
PHANTOM S/NO:	HeadBox.csv	LIQUID TEMPERATURE:	22.70°C
PHANTOM ROTATION:	0°	MAX SAR X-AXIS LOCATION:	-19.00mm
DUT POSITION:	Screen 90° - Area 1	MAX SAR Y-AXIS LOCATION:	24.00mm
ANTENNA CONFIGURATION:	N/A	MAX E FIELD:	4.74 V/m
TEST FREQUENCY:	835MHz	SAR 1g:	0.030 W/kg
AIR FACTORS:	421 / 374 / 405	SAR 10g:	0.017 W/kg
CONVERSION FACTORS:	0.278 / 0.278 / 0.278	SAR START:	0.010 W/kg
TYPE OF MODULATION:	QPSK (RMC+HSDPA Mode)	SAR END:	0.010 W/kg
MODN. DUTY CYCLE:	100.0 %	SAR DRIFT DURING SCAN:	0.00 %
DIODE COMPRESSION FACTORS (V*200):	20 / 20 / 20	PROBE BATTERY LAST CHANGED:	30/07/2008
INPUT POWER LEVEL:	24 dBm	EXTRAPOLATION:	poly4

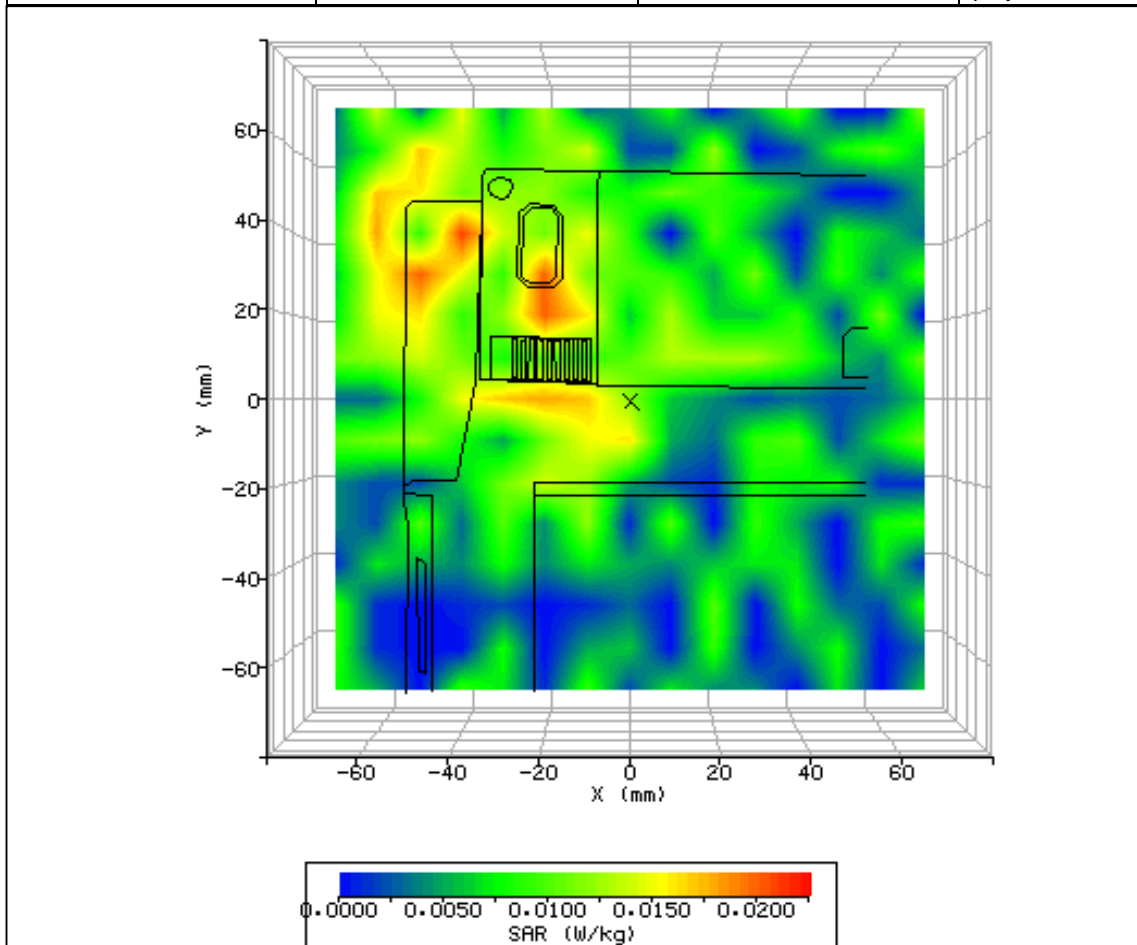

Figure 58: SAR Body Testing Results for the Ericsson Mobile Broadband Module in Screen 90° - Area 1 Phantom Position; Tested at 835MHz (FDDV Middle Channel) with 2mm Separation Distance to the Phantom (NUA).

2.10 WLAN 802.11b BODY SAR TEST RESULTS AND COURSE AREA SCANS – 2D

SYSTEM / SOFTWARE:	SARA2 / 2.53 VPM	INPUT POWER DRIFT:	0.0 dB
DATE / TIME:	14/08/2008 14:23:42	DUT BATTERY MODEL/NO:	N/A
FILENAME:	75903561-54a.txt	PROBE SERIAL NUMBER:	0171
AMBIENT TEMPERATURE:	21.40°C	LIQUID SIMULANT:	2450Body
DEVICE UNDER TEST:	Intel Module	RELATIVE PERMITTIVITY:	52.97
RELATIVE HUMIDITY:	44.10%	CONDUCTIVITY:	1.990
PHANTOM S/NO:	HeadBox1.csv	LIQUID TEMPERATURE:	20.50°C
PHANTOM ROTATION:	0°	MAX SAR X-AXIS LOCATION:	Off Edge
DUT POSITION:	Screen 90° - Area 1	MAX SAR Y-AXIS LOCATION:	Off Edge
ANTENNA CONFIGURATION:	A	MAX E FIELD:	3.36 V/m
TEST FREQUENCY:	2412MHz	SAR 1g:	N/A
AIR FACTORS:	368 / 390 / 442	SAR 10g:	N/A
CONVERSION FACTORS:	.276 / .276 / .276	SAR START:	N/A
TYPE OF MODULATION:	CW	SAR END:	N/A
MODN. DUTY CYCLE:	100.0 %	SAR DRIFT DURING SCAN:	0.00 %
DIODE COMPRESSION FACTORS (V*200):	20 / 20 / 20	PROBE BATTERY LAST CHANGED:	14/08/2008
INPUT POWER LEVEL:	12.9 dBm	EXTRAPOLATION:	poly4

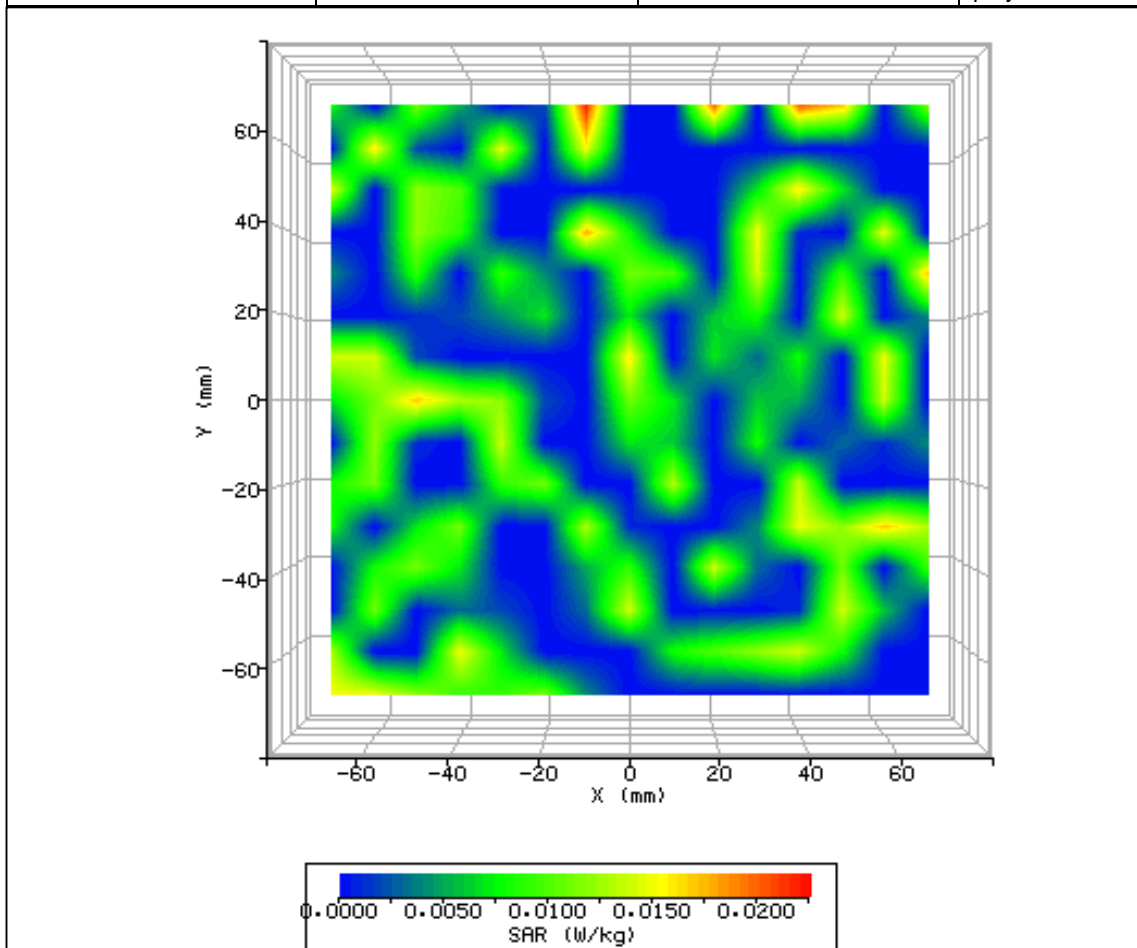

Figure 59: SAR Body Testing Results for the Intel WiFi Module in Screen 90° - Area 1 Phantom Position; Tested at 2412MHz (WLAN Low Channel) with 2mm Separation Distance to the Phantom (NUA).

SYSTEM / SOFTWARE:	SARA2 / 2.53 VPM	INPUT POWER DRIFT:	0.0 dB
DATE / TIME:	14/08/2008 14:32:02	DUT BATTERY MODEL/NO:	N/A
FILENAME:	75903561-55a.txt	PROBE SERIAL NUMBER:	0171
AMBIENT TEMPERATURE:	21.50°C	LIQUID SIMULANT:	2450Body
DEVICE UNDER TEST:	Intel Module	RELATIVE PERMITTIVITY:	52.97
RELATIVE HUMIDITY:	45.60%	CONDUCTIVITY:	1.990
PHANTOM S/NO:	HeadBox1.csv	LIQUID TEMPERATURE:	20.50°C
PHANTOM ROTATION:	0°	MAX SAR X-AXIS LOCATION:	Off Edge
DUT POSITION:	Screen 90° - Area 2	MAX SAR Y-AXIS LOCATION:	Off Edge
ANTENNA CONFIGURATION:	A	MAX E FIELD:	3.71 V/m
TEST FREQUENCY:	2412MHz	SAR 1g:	N/A
AIR FACTORS:	368 / 390 / 442	SAR 10g:	N/A
CONVERSION FACTORS:	.276 / .276 / .276	SAR START:	N/A
TYPE OF MODULATION:	CW	SAR END:	N/A
MODN. DUTY CYCLE:	100.0 %	SAR DRIFT DURING SCAN:	0.00 %
DIODE COMPRESSION FACTORS (V*200):	20 / 20 / 20	PROBE BATTERY LAST CHANGED:	14/08/2008
INPUT POWER LEVEL:	12.9 dBm	EXTRAPOLATION:	poly4

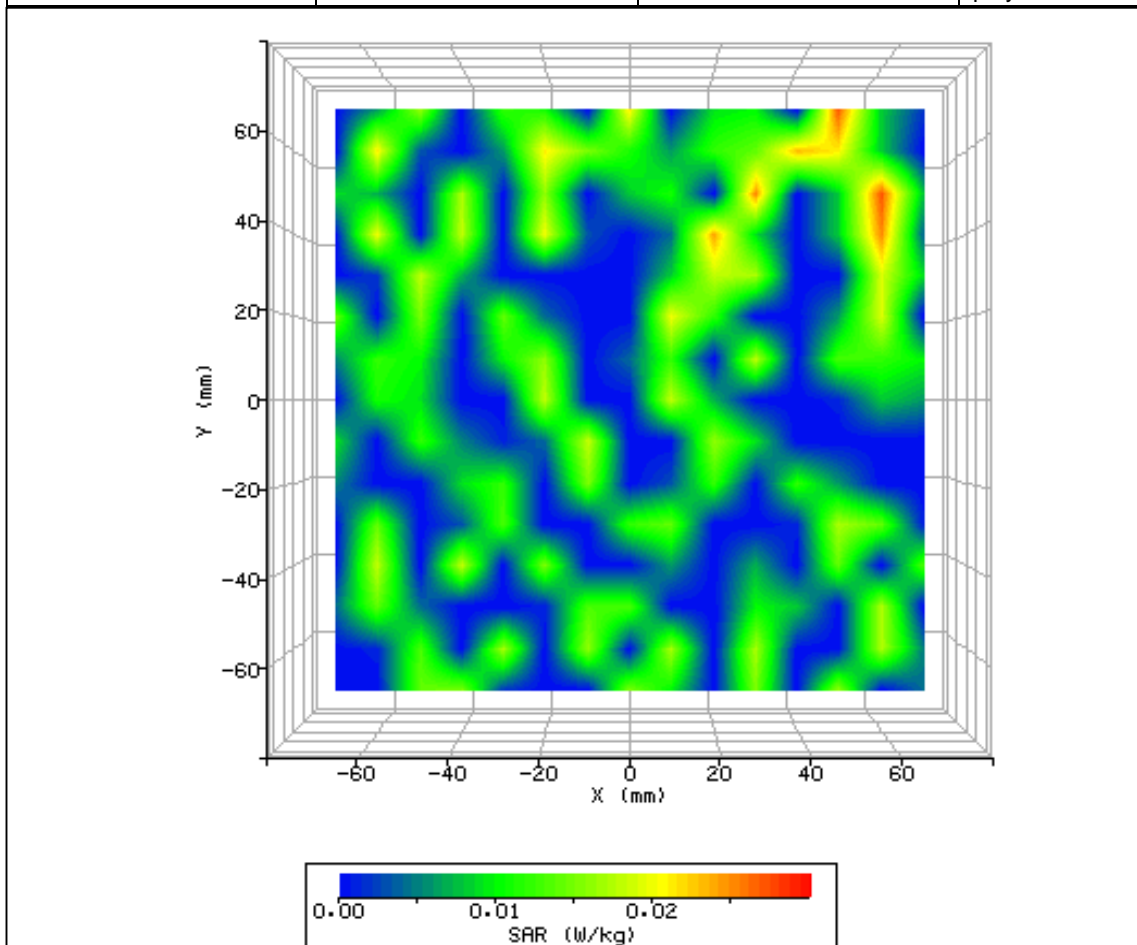

Figure 60: SAR Body Testing Results for the Intel WiFi Module in Screen 90° - Area 2 Phantom Position; Tested at 2412MHz (WLAN Low Channel) with 2mm Separation Distance to the Phantom (NUA).

SYSTEM / SOFTWARE:	SARA2 / 2.53 VPM	INPUT POWER DRIFT:	0.0 dB
DATE / TIME:	14/08/2008 14:51:22	DUT BATTERY MODEL/NO:	N/A
FILENAME:	75903561-56a.txt	PROBE SERIAL NUMBER:	0171
AMBIENT TEMPERATURE:	21.50°C	LIQUID SIMULANT:	2450Body
DEVICE UNDER TEST:	Intel Module	RELATIVE PERMITTIVITY:	52.97
RELATIVE HUMIDITY:	46.60%	CONDUCTIVITY:	1.990
PHANTOM S/NO:	HeadBox1.csv	LIQUID TEMPERATURE:	20.50°C
PHANTOM ROTATION:	0°	MAX SAR X-AXIS LOCATION:	44.00mm
DUT POSITION:	Screen 90° - Area 3	MAX SAR Y-AXIS LOCATION:	42.00mm
ANTENNA CONFIGURATION:	A	MAX E FIELD:	4.79 V/m
TEST FREQUENCY:	2412MHz	SAR 1g:	N/A
AIR FACTORS:	368 / 390 / 442	SAR 10g:	N/A
CONVERSION FACTORS:	.276 / .276 / .276	SAR START:	N/A
TYPE OF MODULATION:	CW	SAR END:	N/A
MODN. DUTY CYCLE:	100.0 %	SAR DRIFT DURING SCAN:	0.00 %
DIODE COMPRESSION FACTORS (V*200):	20 / 20 / 20	PROBE BATTERY LAST CHANGED:	14/08/2008
INPUT POWER LEVEL:	12.9 dBm	EXTRAPOLATION:	poly4

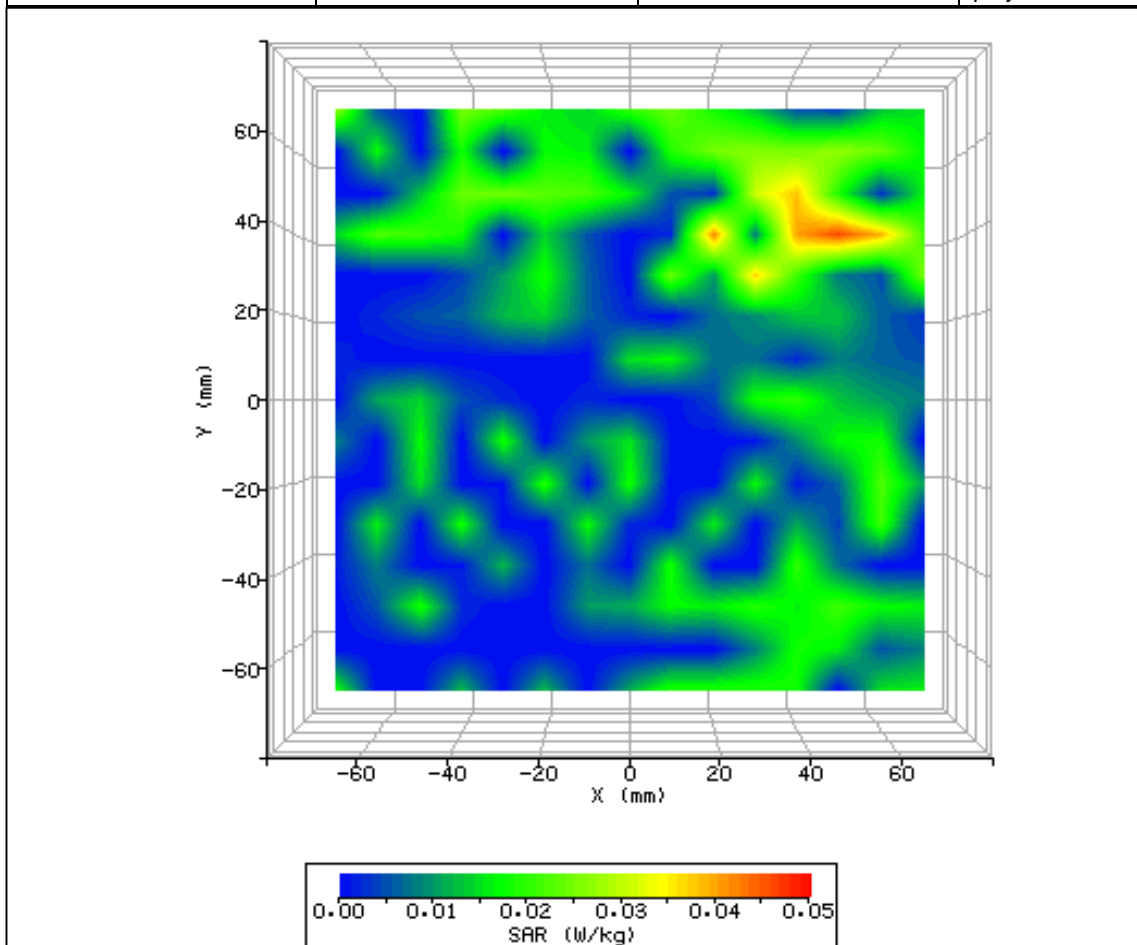

Figure 61: SAR Body Testing Results for the Intel WiFi Module in Screen 90° - Area 3 Phantom Position; Tested at 2412MHz (WLAN Low Channel) with 2mm Separation Distance to the Phantom (NUA).

SYSTEM / SOFTWARE:	SARA2 / 2.53 VPM	INPUT POWER DRIFT:	0.0 dB
DATE / TIME:	14/08/2008 15:06:19	DUT BATTERY MODEL/NO:	N/A
FILENAME:	75903561-57a.txt	PROBE SERIAL NUMBER:	0171
AMBIENT TEMPERATURE:	21.50°C	LIQUID SIMULANT:	2450Body
DEVICE UNDER TEST:	Intel Module	RELATIVE PERMITTIVITY:	52.97
RELATIVE HUMIDITY:	42.50%	CONDUCTIVITY:	1.990
PHANTOM S/NO:	HeadBox1.csv	LIQUID TEMPERATURE:	20.50°C
PHANTOM ROTATION:	0°	MAX SAR X-AXIS LOCATION:	-59.000mm
DUT POSITION:	Screen 90° - Area 4	MAX SAR Y-AXIS LOCATION:	-36.000mm
ANTENNA CONFIGURATION:	A	MAX E FIELD:	3.12 V/m
TEST FREQUENCY:	2412MHz	SAR 1g:	N/A
AIR FACTORS:	368 / 390 / 442	SAR 10g:	N/A
CONVERSION FACTORS:	.276 / .276 / .276	SAR START:	N/A
TYPE OF MODULATION:	CW	SAR END:	N/A
MODN. DUTY CYCLE:	100.0 %	SAR DRIFT DURING SCAN:	0.00 %
DIODE COMPRESSION FACTORS (V*200):	20 / 20 / 20	PROBE BATTERY LAST CHANGED:	14/08/2008
INPUT POWER LEVEL:	12.9 dBm	EXTRAPOLATION:	poly4

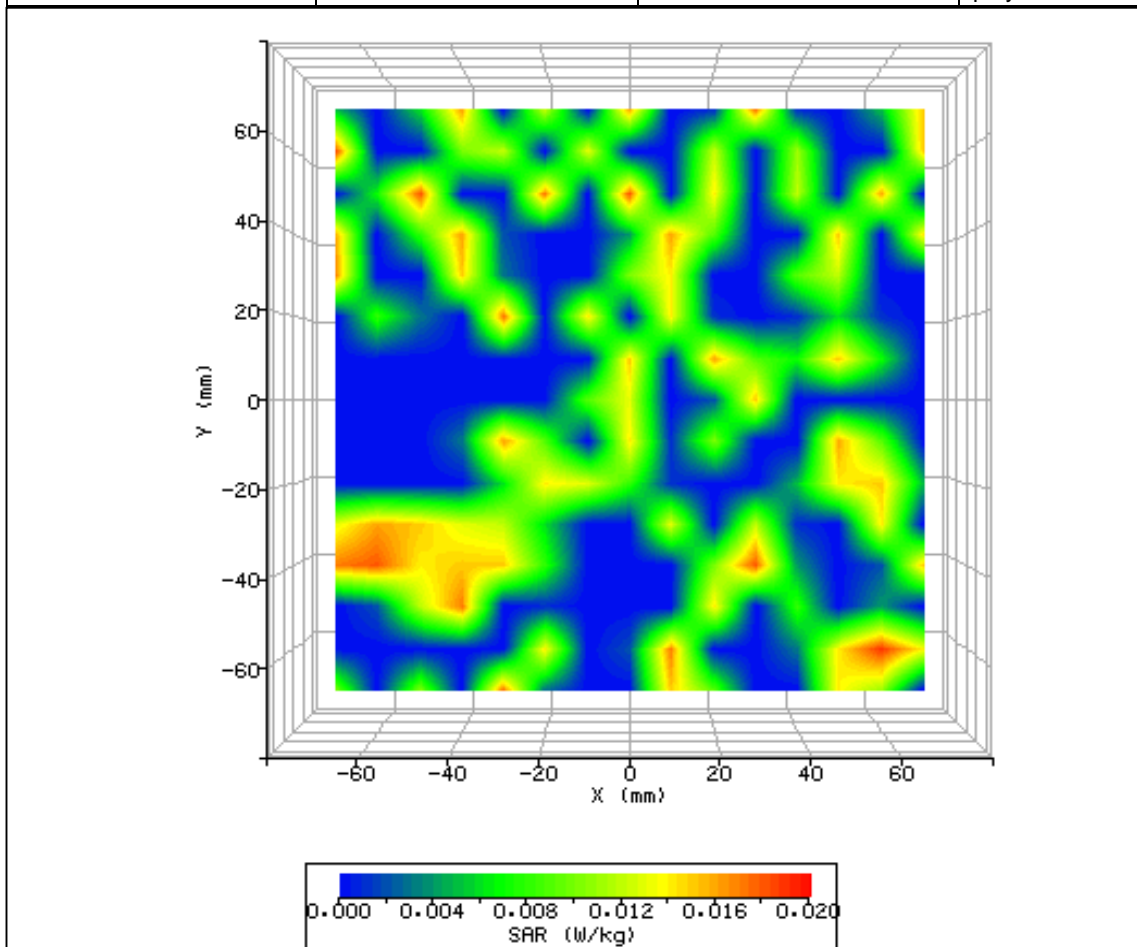

Figure 62: SAR Body Testing Results for the Intel WiFi Module in Screen 90° - Area 4 Phantom Position; Tested at 2412MHz (WLAN Low Channel) with 2mm Separation Distance to the Phantom (NUA).



SYSTEM / SOFTWARE:	SARA2 / 2.53 VPM	INPUT POWER DRIFT:	0.0 dB
DATE / TIME:	14/08/2008 15:15:36	DUT BATTERY MODEL/NO:	N/A
FILENAME:	75903561-58a.txt	PROBE SERIAL NUMBER:	0171
AMBIENT TEMPERATURE:	21.60°C	LIQUID SIMULANT:	2450Body
DEVICE UNDER TEST:	Intel Module	RELATIVE PERMITTIVITY:	52.97
RELATIVE HUMIDITY:	43.60%	CONDUCTIVITY:	1.990
PHANTOM S/NO:	HeadBox1.csv	LIQUID TEMPERATURE:	20.60°C
PHANTOM ROTATION:	0°	MAX SAR X-AXIS LOCATION:	70.000mm
DUT POSITION:	Screen 90° - Area 5	MAX SAR Y-AXIS LOCATION:	-70.000mm
ANTENNA CONFIGURATION:	A	MAX E FIELD:	3.40 V/m
TEST FREQUENCY:	2412MHz	SAR 1g:	N/A
AIR FACTORS:	368 / 390 / 442	SAR 10g:	N/A
CONVERSION FACTORS:	.276 / .276 / .276	SAR START:	N/A
TYPE OF MODULATION:	CW	SAR END:	N/A
MODN. DUTY CYCLE:	100.0 %	SAR DRIFT DURING SCAN:	0.00 %
DIODE COMPRESSION FACTORS (V*200):	20 / 20 / 20	PROBE BATTERY LAST CHANGED:	14/08/2008
INPUT POWER LEVEL:	12.9 dBm	EXTRAPOLATION:	poly4

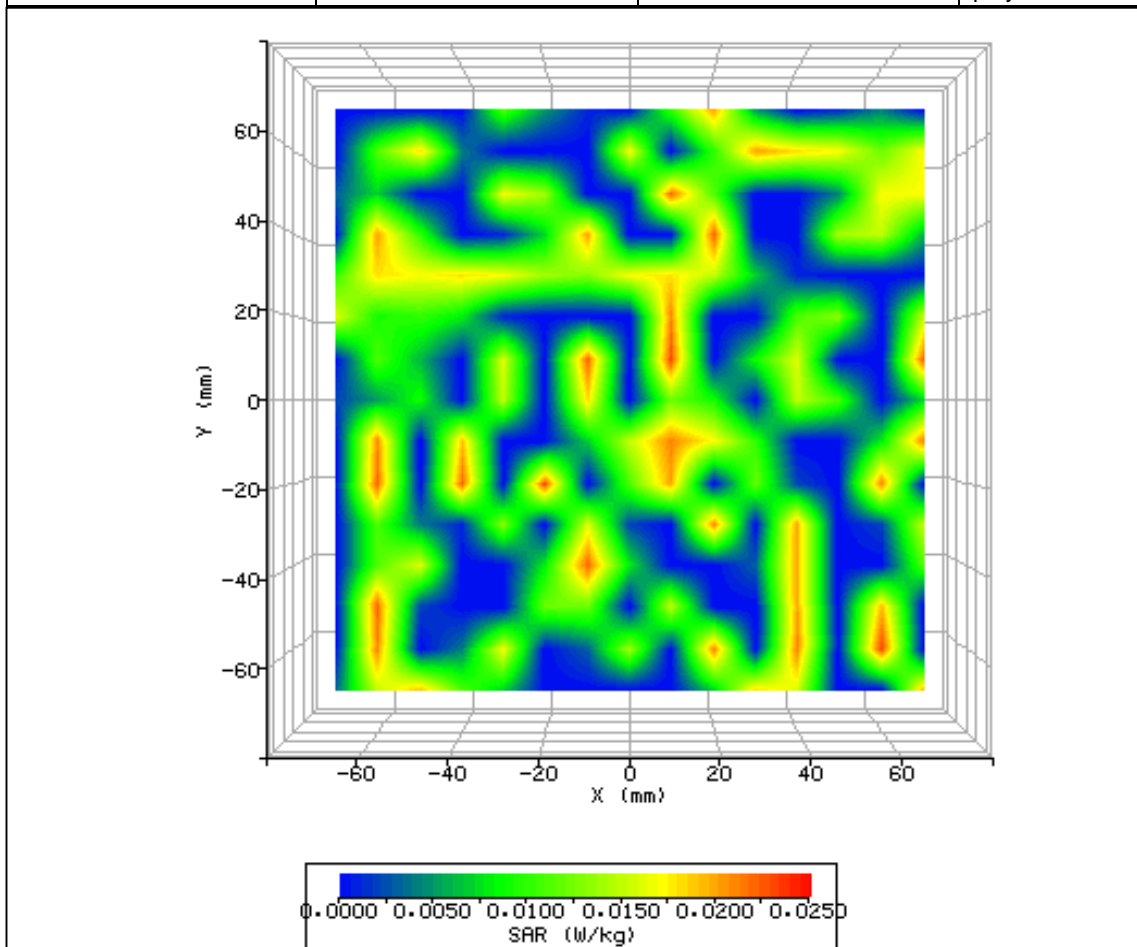

Figure 63: SAR Body Testing Results for the Intel WiFi Module in Screen 90° - Area 5 Phantom Position; Tested at 2412MHz (WLAN Low Channel) with 2mm Separation Distance to the Phantom (NUA).

SYSTEM / SOFTWARE:	SARA2 / 2.53 VPM	INPUT POWER DRIFT:	0.0 dB
DATE / TIME:	14/08/2008 15:26:28	DUT BATTERY MODEL/NO:	N/A
FILENAME:	75903561-59a.txt	PROBE SERIAL NUMBER:	0171
AMBIENT TEMPERATURE:	22.00°C	LIQUID SIMULANT:	2450Body
DEVICE UNDER TEST:	Intel Module	RELATIVE PERMITTIVITY:	52.97
RELATIVE HUMIDITY:	49.90%	CONDUCTIVITY:	1.990
PHANTOM S/NO:	HeadBox1.csv	LIQUID TEMPERATURE:	20.70°C
PHANTOM ROTATION:	0°	MAX SAR X-AXIS LOCATION:	Off Edge
DUT POSITION:	Screen 90° - Area 6	MAX SAR Y-AXIS LOCATION:	Off Edge
ANTENNA CONFIGURATION:	A	MAX E FIELD:	3.34 V/m
TEST FREQUENCY:	2412MHz	SAR 1g:	N/A
AIR FACTORS:	368 / 390 / 442	SAR 10g:	N/A
CONVERSION FACTORS:	.276 / .276 / .276	SAR START:	N/A
TYPE OF MODULATION:	CW	SAR END:	N/A
MODN. DUTY CYCLE:	100.0 %	SAR DRIFT DURING SCAN:	0.00 %
DIODE COMPRESSION FACTORS (V*200):	20 / 20 / 20	PROBE BATTERY LAST CHANGED:	14/08/2008
INPUT POWER LEVEL:	12.9 dBm	EXTRAPOLATION:	poly4

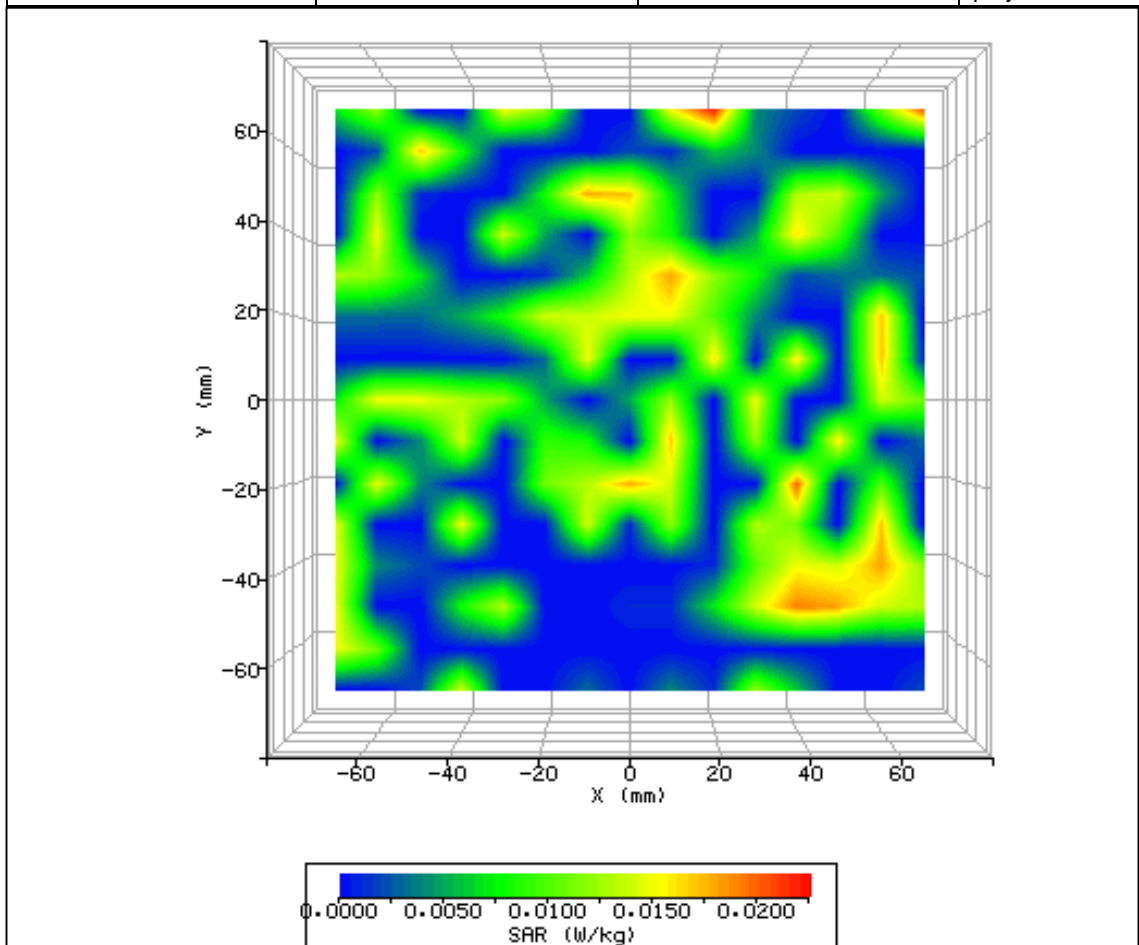

Figure 64: SAR Body Testing Results for the Intel WiFi Module in Screen 90° - Area 6 Phantom Position; Tested at 2412MHz (WLAN Low Channel) with 2mm Separation Distance to the Phantom (NUA).

SYSTEM / SOFTWARE:	SARA2 / 2.53 VPM	INPUT POWER DRIFT:	0.0 dB
DATE / TIME:	14/08/2008 15:50:11	DUT BATTERY MODEL/NO:	N/A
FILENAME:	75903561-60a.txt	PROBE SERIAL NUMBER:	0171
AMBIENT TEMPERATURE:	22.00°C	LIQUID SIMULANT:	2450Body
DEVICE UNDER TEST:	Intel Module	RELATIVE PERMITTIVITY:	52.97
RELATIVE HUMIDITY:	47.60%	CONDUCTIVITY:	1.990
PHANTOM S/NO:	HeadBox1.csv	LIQUID TEMPERATURE:	20.70°C
PHANTOM ROTATION:	0°	MAX SAR X-AXIS LOCATION:	70.00mm
DUT POSITION:	Screen 90° - Area 1	MAX SAR Y-AXIS LOCATION:	-17.00mm
ANTENNA CONFIGURATION:	B	MAX E FIELD:	2.86 V/m
TEST FREQUENCY:	2412MHz	SAR 1g:	N/A
AIR FACTORS:	368 / 390 / 442	SAR 10g:	N/A
CONVERSION FACTORS:	.276 / .276 / .276	SAR START:	N/A
TYPE OF MODULATION:	CW	SAR END:	N/A
MODN. DUTY CYCLE:	100.0 %	SAR DRIFT DURING SCAN:	0.00 %
DIODE COMPRESSION FACTORS (V*200):	20 / 20 / 20	PROBE BATTERY LAST CHANGED:	14/08/2008
INPUT POWER LEVEL:	12.9 dBm	EXTRAPOLATION:	poly4

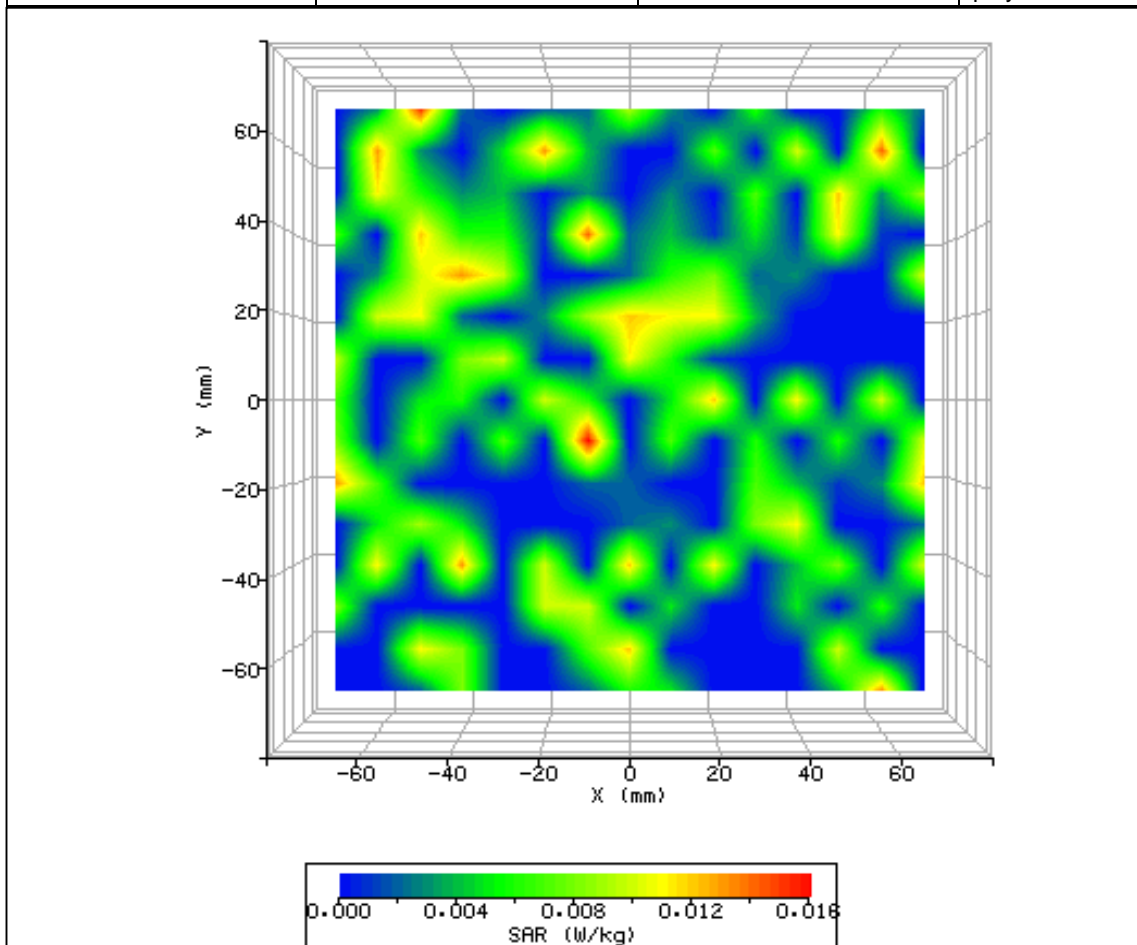

Figure 65: SAR Body Testing Results for the Intel WiFi Module in Screen 90° - Area 1 Phantom Position; Tested at 2412MHz (WLAN Low Channel) with 2mm Separation Distance to the Phantom (NUA).

SYSTEM / SOFTWARE:	SARA2 / 2.53 VPM	INPUT POWER DRIFT:	0.0 dB
DATE / TIME:	14/08/2008 15:59:12	DUT BATTERY MODEL/NO:	N/A
FILENAME:	75903561-61a.txt	PROBE SERIAL NUMBER:	0171
AMBIENT TEMPERATURE:	22.00°C	LIQUID SIMULANT:	2450Body
DEVICE UNDER TEST:	Intel Module	RELATIVE PERMITTIVITY:	52.97
RELATIVE HUMIDITY:	46.90%	CONDUCTIVITY:	1.990
PHANTOM S/NO:	HeadBox1.csv	LIQUID TEMPERATURE:	20.70°C
PHANTOM ROTATION:	0°	MAX SAR X-AXIS LOCATION:	Off Edge
DUT POSITION:	Screen 90° - Area 2	MAX SAR Y-AXIS LOCATION:	Off Edge
ANTENNA CONFIGURATION:	B	MAX E FIELD:	3.34 V/m
TEST FREQUENCY:	2412MHz	SAR 1g:	N/A
AIR FACTORS:	368 / 390 / 442	SAR 10g:	N/A
CONVERSION FACTORS:	.276 / .276 / .276	SAR START:	N/A
TYPE OF MODULATION:	CW	SAR END:	N/A
MODN. DUTY CYCLE:	100.0 %	SAR DRIFT DURING SCAN:	0.00 %
DIODE COMPRESSION FACTORS (V*200):	20 / 20 / 20	PROBE BATTERY LAST CHANGED:	14/08/2008
INPUT POWER LEVEL:	12.9 dBm	EXTRAPOLATION:	poly4

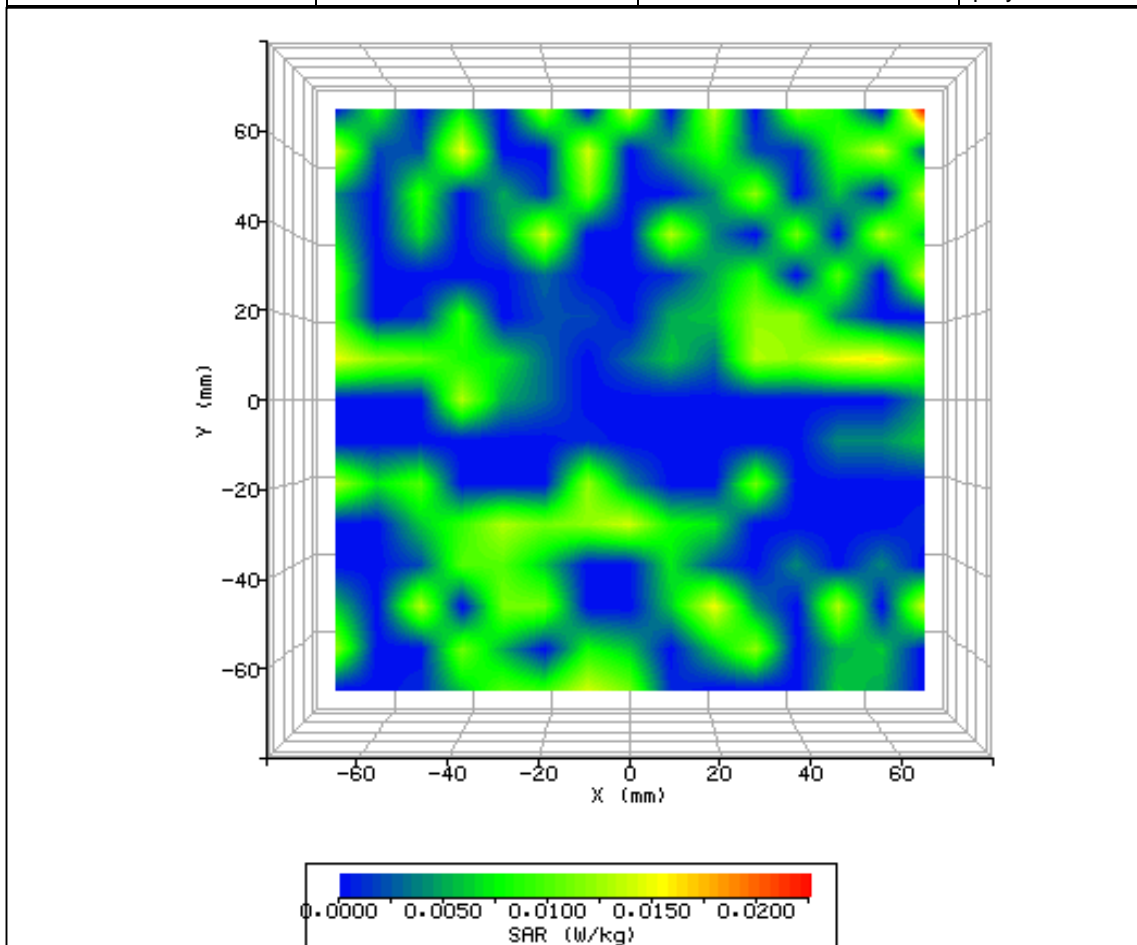

Figure 66: SAR Body Testing Results for the Intel WiFi Module in Screen 90° - Area 2 Phantom Position; Tested at 2412MHz (WLAN Low Channel) with 2mm Separation Distance to the Phantom (NUA).

SYSTEM / SOFTWARE:	SARA2 / 2.53 VPM	INPUT POWER DRIFT:	0.0 dB
DATE / TIME:	14/08/2008 16:08:18	DUT BATTERY MODEL/NO:	N/A
FILENAME:	75903561-62a.txt	PROBE SERIAL NUMBER:	0171
AMBIENT TEMPERATURE:	22.00°C	LIQUID SIMULANT:	2450Body
DEVICE UNDER TEST:	Intel Module	RELATIVE PERMITTIVITY:	52.97
RELATIVE HUMIDITY:	45.90%	CONDUCTIVITY:	1.990
PHANTOM S/NO:	HeadBox1.csv	LIQUID TEMPERATURE:	20.80°C
PHANTOM ROTATION:	0°	MAX SAR X-AXIS LOCATION:	35.00mm
DUT POSITION:	Screen 90° - Area 3	MAX SAR Y-AXIS LOCATION:	41.00mm
ANTENNA CONFIGURATION:	B	MAX E FIELD:	6.42 V/m
TEST FREQUENCY:	2412MHz	SAR 1g:	N/A
AIR FACTORS:	368 / 390 / 442	SAR 10g:	N/A
CONVERSION FACTORS:	.276 / .276 / .276	SAR START:	N/A
TYPE OF MODULATION:	CW	SAR END:	N/A
MODN. DUTY CYCLE:	100.0 %	SAR DRIFT DURING SCAN:	0.00 %
DIODE COMPRESSION FACTORS (V*200):	20 / 20 / 20	PROBE BATTERY LAST CHANGED:	14/08/2008
INPUT POWER LEVEL:	12.9 dBm	EXTRAPOLATION:	poly4

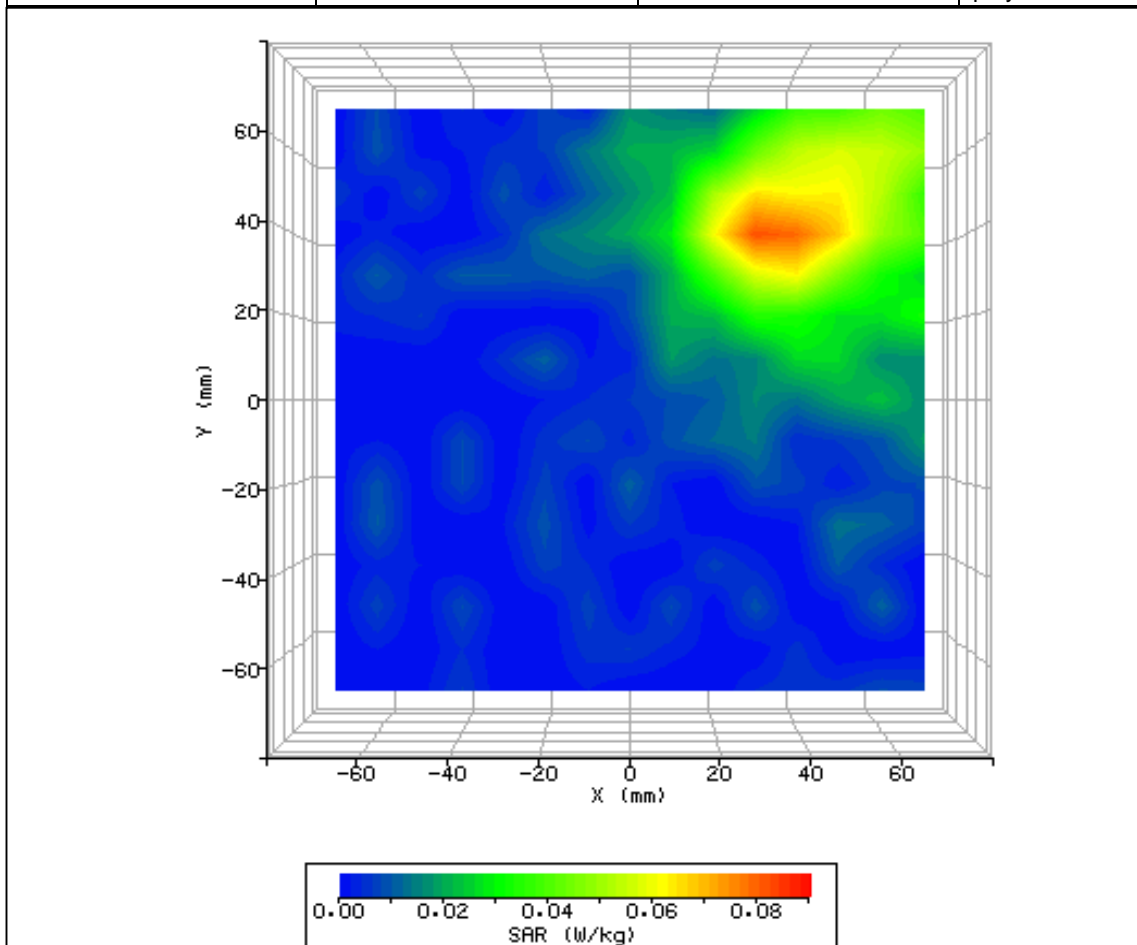

Figure 67: SAR Body Testing Results for the Intel WiFi Module in Screen 90° - Area 3 Phantom Position; Tested at 2412MHz (WLAN Low Channel) with 2mm Separation Distance to the Phantom (NUA).

SYSTEM / SOFTWARE:	SARA2 / 2.53 VPM	INPUT POWER DRIFT:	0.0 dB
DATE / TIME:	14/08/2008 16:18:21	DUT BATTERY MODEL/NO:	N/A
FILENAME:	75903561-63a.txt	PROBE SERIAL NUMBER:	0171
AMBIENT TEMPERATURE:	22.10°C	LIQUID SIMULANT:	2450Body
DEVICE UNDER TEST:	Intel Module	RELATIVE PERMITTIVITY:	52.97
RELATIVE HUMIDITY:	45.50%	CONDUCTIVITY:	1.990
PHANTOM S/NO:	HeadBox1.csv	LIQUID TEMPERATURE:	20.80°C
PHANTOM ROTATION:	0°	MAX SAR X-AXIS LOCATION:	-70.000mm
DUT POSITION:	Screen 90° - Area 4	MAX SAR Y-AXIS LOCATION:	-70.000mm
ANTENNA CONFIGURATION:	B	MAX E FIELD:	2.76 V/m
TEST FREQUENCY:	2412MHz	SAR 1g:	N/A
AIR FACTORS:	368 / 390 / 442	SAR 10g:	N/A
CONVERSION FACTORS:	.276 / .276 / .276	SAR START:	0.004 W/kg
TYPE OF MODULATION:	CW	SAR END:	N/A
MODN. DUTY CYCLE:	100.0 %	SAR DRIFT DURING SCAN:	0.00 %
DIODE COMPRESSION FACTORS (V*200):	20 / 20 / 20	PROBE BATTERY LAST CHANGED:	14/08/2008
INPUT POWER LEVEL:	12.9 dBm	EXTRAPOLATION:	poly4

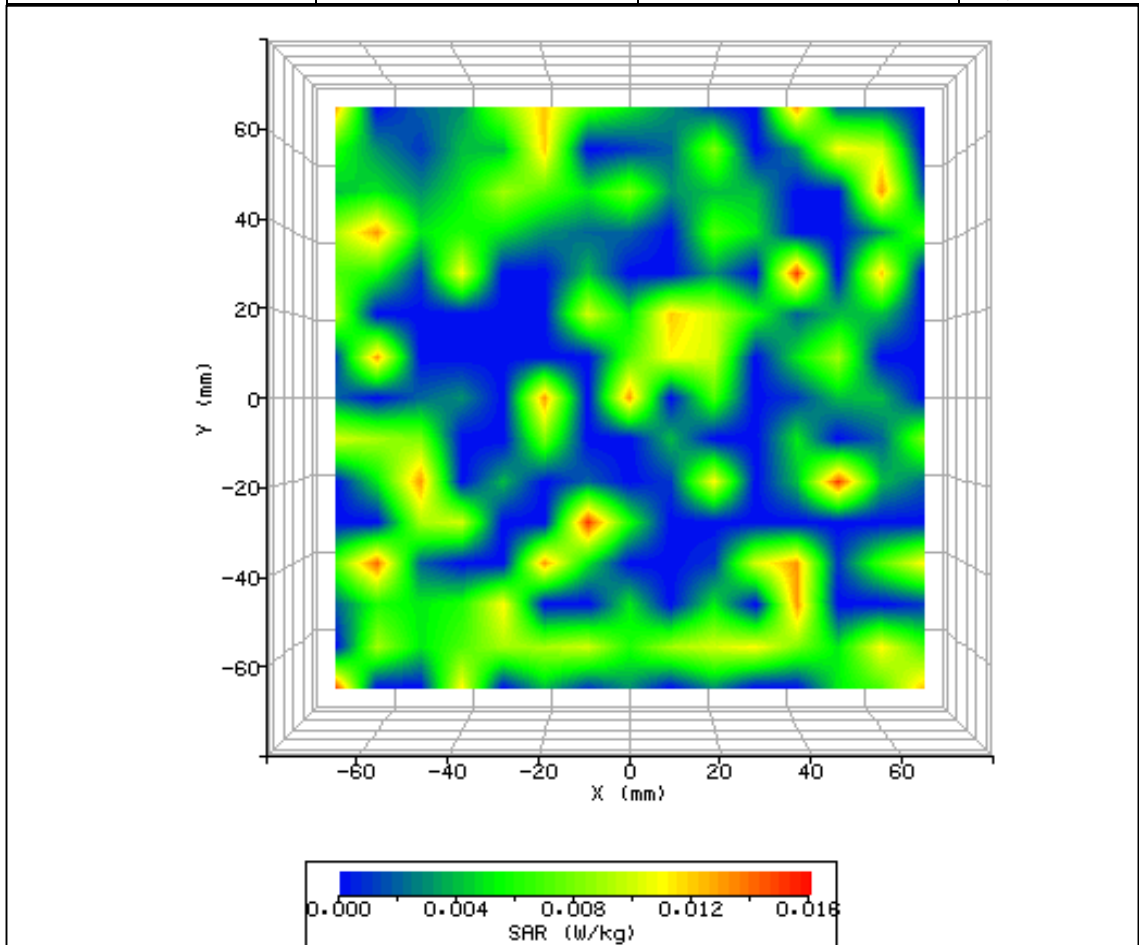

Figure 68: SAR Body Testing Results for the Intel WiFi Module in Screen 90° - Area 4 Phantom Position; Tested at 2412MHz (WLAN Low Channel) with 2mm Separation Distance to the Phantom (NUA).

SYSTEM / SOFTWARE:	SARA2 / 2.53 VPM	INPUT POWER DRIFT:	0.0 dB
DATE / TIME:	14/08/2008 16:29:24	DUT BATTERY MODEL/NO:	N/A
FILENAME:	75903561-64a.txt	PROBE SERIAL NUMBER:	0171
AMBIENT TEMPERATURE:	22.10°C	LIQUID SIMULANT:	2450Body
DEVICE UNDER TEST:	Intel Module	RELATIVE PERMITTIVITY:	52.97
RELATIVE HUMIDITY:	45.30%	CONDUCTIVITY:	1.990
PHANTOM S/NO:	HeadBox1.csv	LIQUID TEMPERATURE:	20.80°C
PHANTOM ROTATION:	0°	MAX SAR X-AXIS LOCATION:	-70.000mm
DUT POSITION:	Screen 90° - Area 5	MAX SAR Y-AXIS LOCATION:	54.000mm
ANTENNA CONFIGURATION:	B	MAX E FIELD:	2.90 V/m
TEST FREQUENCY:	2412MHz	SAR 1g:	N/A
AIR FACTORS:	368 / 390 / 442	SAR 10g:	N/A
CONVERSION FACTORS:	.276 / .276 / .276	SAR START:	N/A
TYPE OF MODULATION:	CW	SAR END:	N/A
MODN. DUTY CYCLE:	100.0 %	SAR DRIFT DURING SCAN:	0.00 %
DIODE COMPRESSION FACTORS (V*200):	20 / 20 / 20	PROBE BATTERY LAST CHANGED:	14/08/2008
INPUT POWER LEVEL:	12.9 dBm	EXTRAPOLATION:	poly4

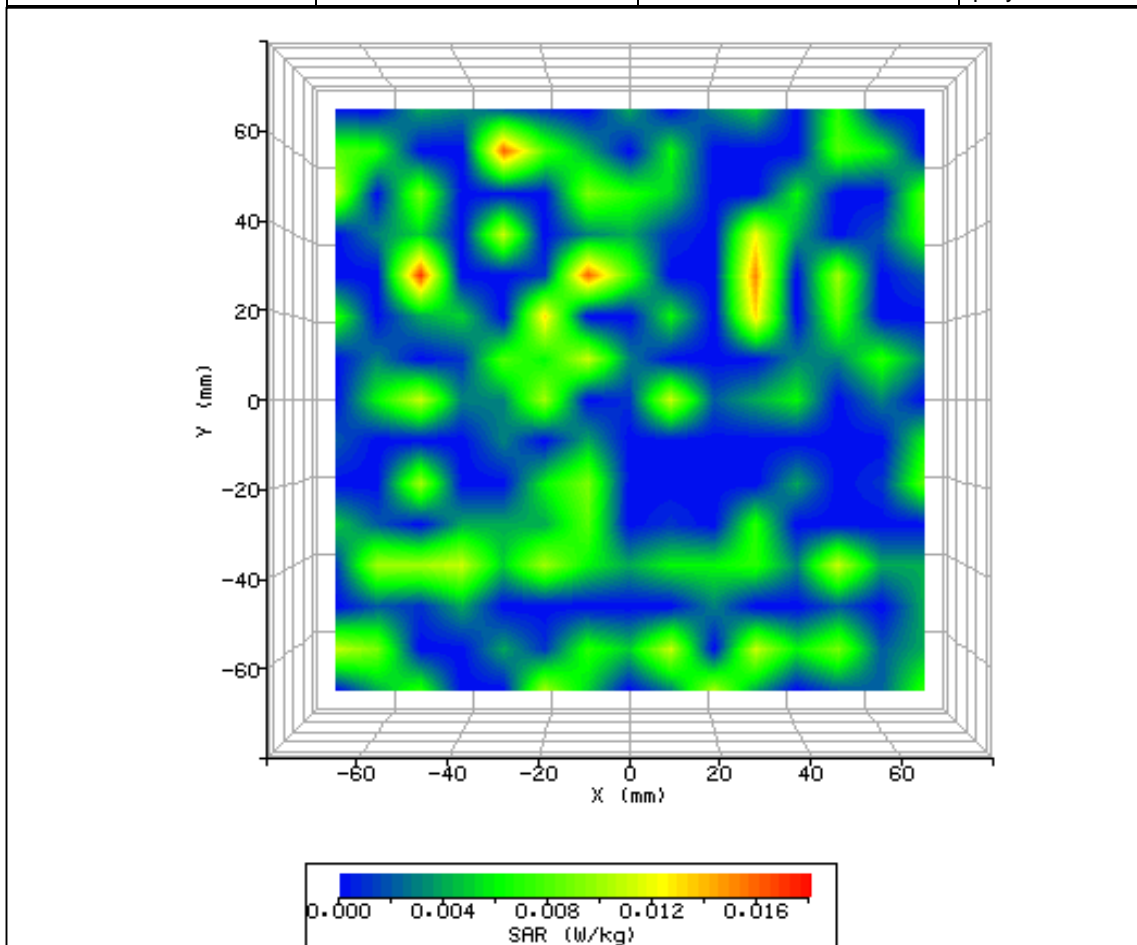

Figure 69: SAR Body Testing Results for the Intel WiFi Module in Screen 90° - Area 5 Phantom Position; Tested at 2412MHz (WLAN Low Channel) with 2mm Separation Distance to the Phantom (NUA).

SYSTEM / SOFTWARE:	SARA2 / 2.53 VPM	INPUT POWER DRIFT:	0.0 dB
DATE / TIME:	14/08/2008 16:40:18	DUT BATTERY MODEL/NO:	N/A
FILENAME:	75903561-65a.txt	PROBE SERIAL NUMBER:	0171
AMBIENT TEMPERATURE:	22.10°C	LIQUID SIMULANT:	2450Body
DEVICE UNDER TEST:	Intel Module	RELATIVE PERMITTIVITY:	52.97
RELATIVE HUMIDITY:	45.10%	CONDUCTIVITY:	1.990
PHANTOM S/NO:	HeadBox1.csv	LIQUID TEMPERATURE:	20.80°C
PHANTOM ROTATION:	0°	MAX SAR X-AXIS LOCATION:	Off Edge
DUT POSITION:	Screen 90° - Area 6	MAX SAR Y-AXIS LOCATION:	Off Edge
ANTENNA CONFIGURATION:	B	MAX E FIELD:	2.93 V/m
TEST FREQUENCY:	2412MHz	SAR 1g:	N/A
AIR FACTORS:	368 / 390 / 442	SAR 10g:	N/A
CONVERSION FACTORS:	.276 / .276 / .276	SAR START:	N/A
TYPE OF MODULATION:	CW	SAR END:	N/A
MODN. DUTY CYCLE:	100.0 %	SAR DRIFT DURING SCAN:	0.00 %
DIODE COMPRESSION FACTORS (V*200):	20 / 20 / 20	PROBE BATTERY LAST CHANGED:	14/08/2008
INPUT POWER LEVEL:	12.9 dBm	EXTRAPOLATION:	poly4

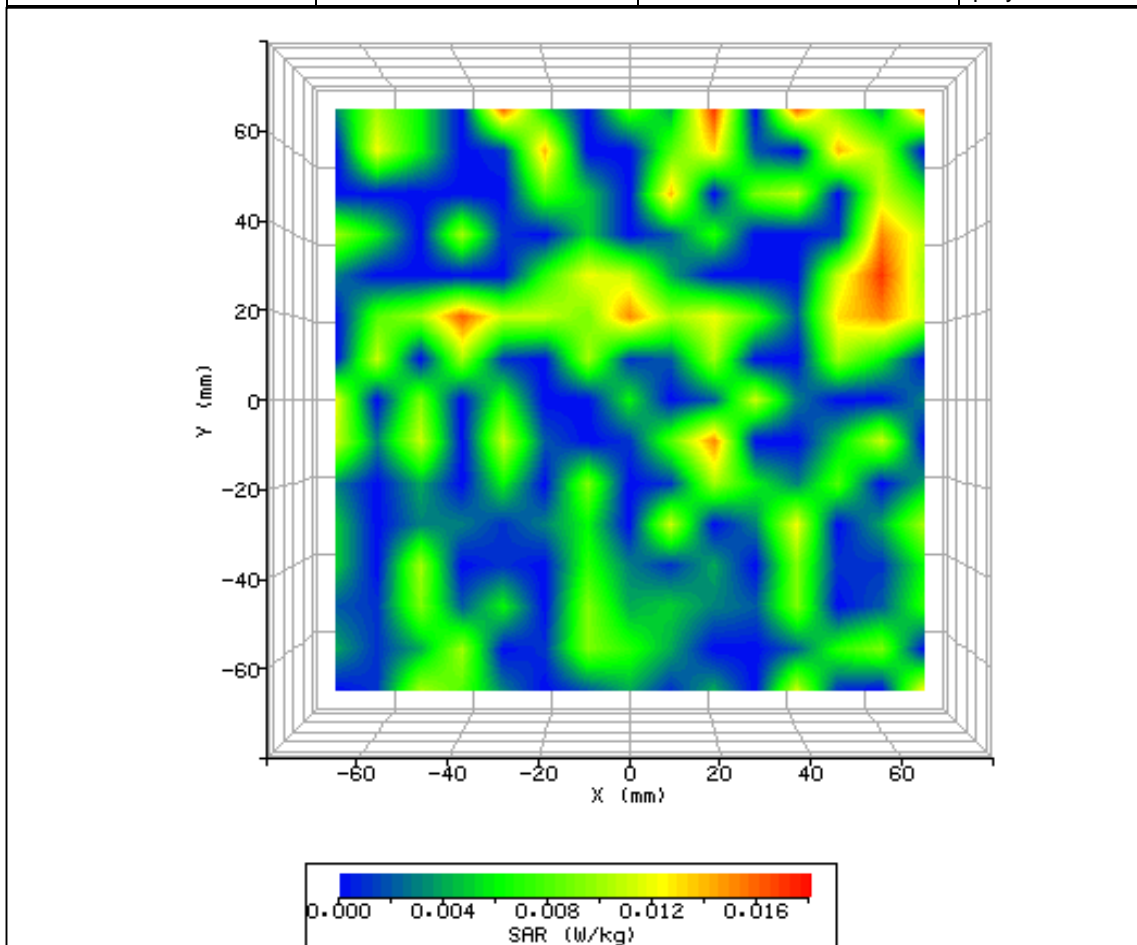

Figure 70: SAR Body Testing Results for the Intel WiFi Module in Screen 90° - Area 6 Phantom Position; Tested at 2412MHz (WLAN Low Channel) with 2mm Separation Distance to the Phantom (NUA).



SYSTEM / SOFTWARE:	SARA2 / 2.53 VPM	INPUT POWER DRIFT:	0.0 dB
DATE / TIME:	14/08/2008 16:49:22	DUT BATTERY MODEL/NO:	N/A
FILENAME:	75903561-66a.txt	PROBE SERIAL NUMBER:	0171
AMBIENT TEMPERATURE:	22.00°C	LIQUID SIMULANT:	2450Body
DEVICE UNDER TEST:	Intel Module	RELATIVE PERMITTIVITY:	52.97
RELATIVE HUMIDITY:	45.20%	CONDUCTIVITY:	1.990
PHANTOM S/NO:	HeadBox1.csv	LIQUID TEMPERATURE:	20.80°C
PHANTOM ROTATION:	0°	MAX SAR X-AXIS LOCATION:	-40.00mm
DUT POSITION:	Screen 90° - Area 1	MAX SAR Y-AXIS LOCATION:	42.00mm
ANTENNA CONFIGURATION:	C	MAX E FIELD:	6.23 V/m
TEST FREQUENCY:	2412MHz	SAR 1g:	N/A
AIR FACTORS:	368 / 390 / 442	SAR 10g:	N/A
CONVERSION FACTORS:	.276 / .276 / .276	SAR START:	N/A
TYPE OF MODULATION:	CW	SAR END:	N/A
MODN. DUTY CYCLE:	100.0 %	SAR DRIFT DURING SCAN:	0.00 %
DIODE COMPRESSION FACTORS (V*200):	20 / 20 / 20	PROBE BATTERY LAST CHANGED:	14/08/2008
INPUT POWER LEVEL:	12.9 dBm	EXTRAPOLATION:	poly4

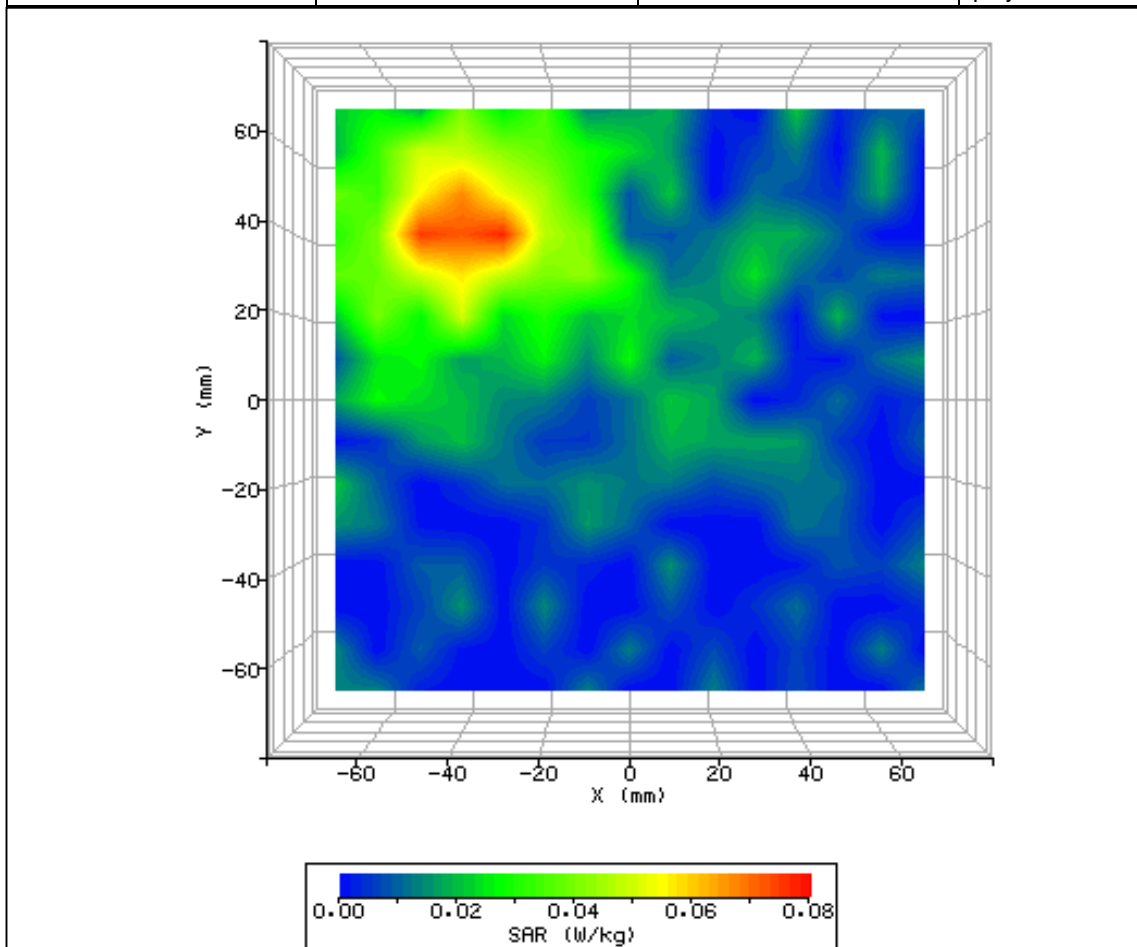

Figure 71: SAR Body Testing Results for the Intel WiFi Module in Screen 90° - Area 1 Phantom Position; Tested at 2412MHz (WLAN Low Channel) with 2mm Separation Distance to the Phantom (NUA).

SYSTEM / SOFTWARE:	SARA2 / 2.53 VPM	INPUT POWER DRIFT:	0.0 dB
DATE / TIME:	14/08/2008 16:57:48	DUT BATTERY MODEL/NO:	N/A
FILENAME:	75903561-67a.txt	PROBE SERIAL NUMBER:	0171
AMBIENT TEMPERATURE:	21.80°C	LIQUID SIMULANT:	2450Body
DEVICE UNDER TEST:	Intel Module	RELATIVE PERMITTIVITY:	52.97
RELATIVE HUMIDITY:	44.50%	CONDUCTIVITY:	1.990
PHANTOM S/NO:	HeadBox1.csv	LIQUID TEMPERATURE:	20.70°C
PHANTOM ROTATION:	0°	MAX SAR X-AXIS LOCATION:	Off Edge
DUT POSITION:	Screen 90° - Area 2	MAX SAR Y-AXIS LOCATION:	Off Edge
ANTENNA CONFIGURATION:	C	MAX E FIELD:	3.63 V/m
TEST FREQUENCY:	2412MHz	SAR 1g:	N/A
AIR FACTORS:	368 / 390 / 442	SAR 10g:	N/A
CONVERSION FACTORS:	.276 / .276 / .276	SAR START:	N/A
TYPE OF MODULATION:	CW	SAR END:	N/A
MODN. DUTY CYCLE:	100.0 %	SAR DRIFT DURING SCAN:	0.00 %
DIODE COMPRESSION FACTORS (V*200):	20 / 20 / 20	PROBE BATTERY LAST CHANGED:	14/08/2008
INPUT POWER LEVEL:	12.9 dBm	EXTRAPOLATION:	poly4

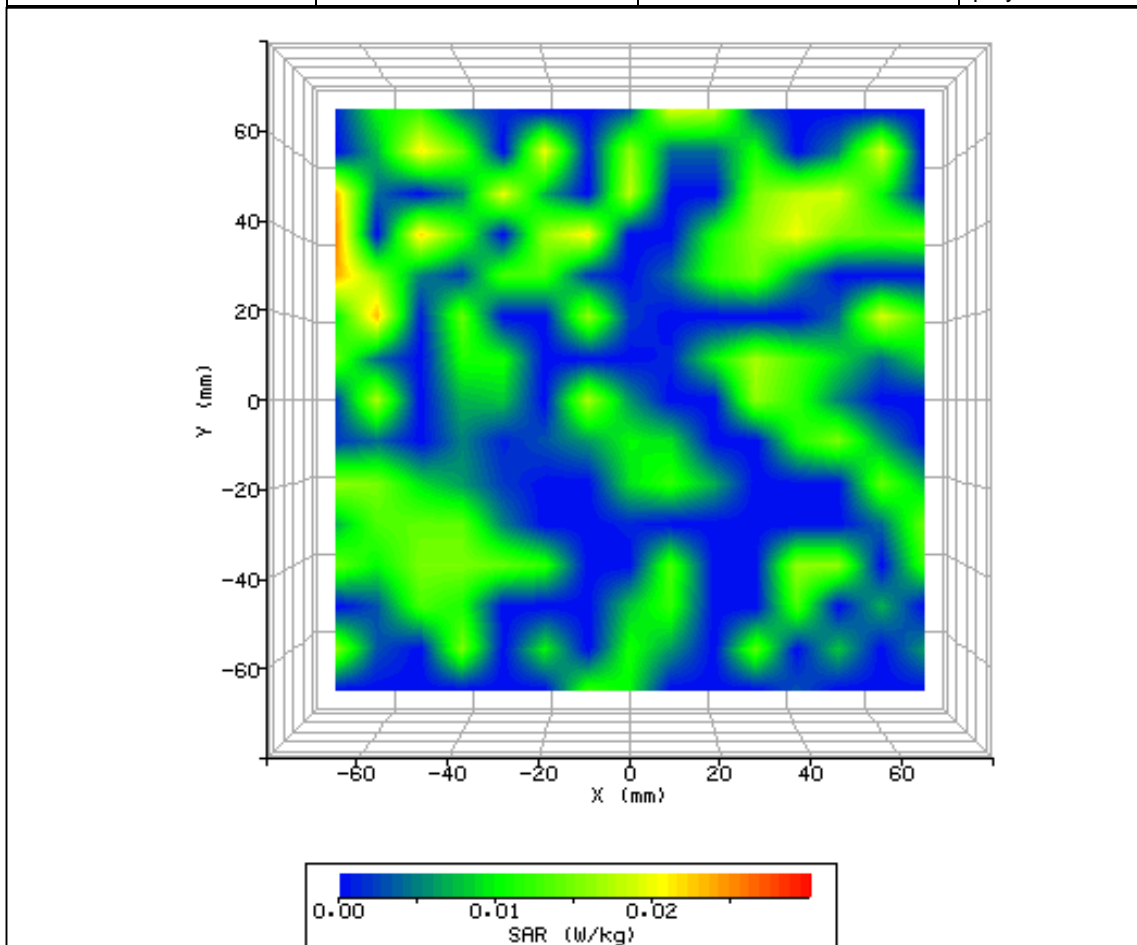

Figure 72: SAR Body Testing Results for the Intel WiFi Module in Screen 90° - Area 2 Phantom Position; Tested at 2412MHz (WLAN Low Channel) with 2mm Separation Distance to the Phantom (NUA).

SYSTEM / SOFTWARE:	SARA2 / 2.53 VPM	INPUT POWER DRIFT:	0.0 dB
DATE / TIME:	14/08/2008 17:06:12	DUT BATTERY MODEL/NO:	N/A
FILENAME:	75903561-68a.txt	PROBE SERIAL NUMBER:	0171
AMBIENT TEMPERATURE:	21.70°C	LIQUID SIMULANT:	2450Body
DEVICE UNDER TEST:	Intel Module	RELATIVE PERMITTIVITY:	52.97
RELATIVE HUMIDITY:	44.10%	CONDUCTIVITY:	1.990
PHANTOM S/NO:	HeadBox1.csv	LIQUID TEMPERATURE:	20.70°C
PHANTOM ROTATION:	0°	MAX SAR X-AXIS LOCATION:	-70.00mm
DUT POSITION:	Screen 90° - Area 3	MAX SAR Y-AXIS LOCATION:	70.00mm
ANTENNA CONFIGURATION:	C	MAX E FIELD:	3.15 V/m
TEST FREQUENCY:	2412MHz	SAR 1g:	N/A
AIR FACTORS:	368 / 390 / 442	SAR 10g:	N/A
CONVERSION FACTORS:	.276 / .276 / .276	SAR START:	N/A
TYPE OF MODULATION:	CW	SAR END:	N/A
MODN. DUTY CYCLE:	100.0 %	SAR DRIFT DURING SCAN:	0.00 %
DIODE COMPRESSION FACTORS (V*200):	20 / 20 / 20	PROBE BATTERY LAST CHANGED:	14/08/2008
INPUT POWER LEVEL:	12.9 dBm	EXTRAPOLATION:	poly4

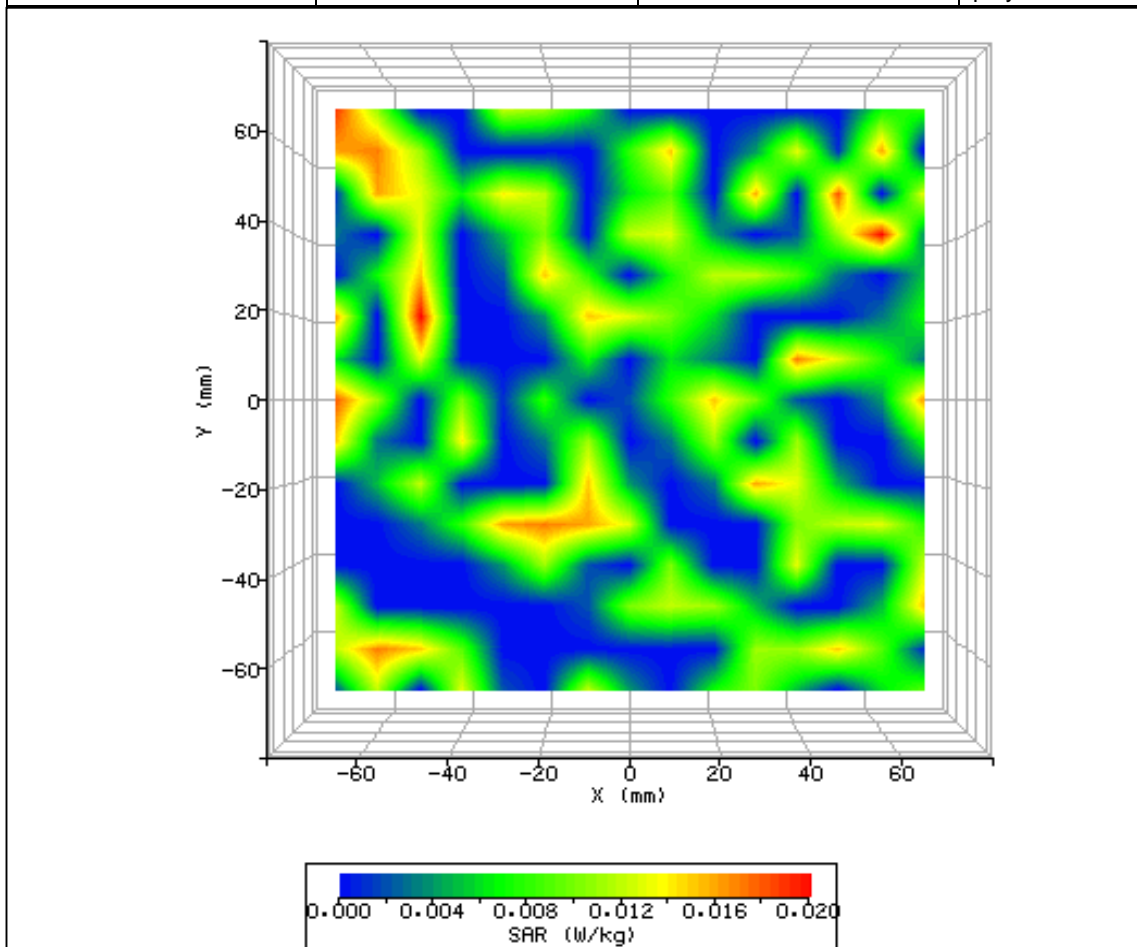

Figure 73: SAR Body Testing Results for the Intel WiFi Module in Screen 90° - Area 3 Phantom Position; Tested at 2412MHz (WLAN Low Channel) with 2mm Separation Distance to the Phantom (NUA).

SYSTEM / SOFTWARE:	SARA2 / 2.53 VPM	INPUT POWER DRIFT:	0.0 dB
DATE / TIME:	14/08/2008 17:19:13	DUT BATTERY MODEL/NO:	N/A
FILENAME:	75903561-69a.txt	PROBE SERIAL NUMBER:	0171
AMBIENT TEMPERATURE:	21.80°C	LIQUID SIMULANT:	2450Body
DEVICE UNDER TEST:	Intel Module	RELATIVE PERMITTIVITY:	52.97
RELATIVE HUMIDITY:	43.30%	CONDUCTIVITY:	1.990
PHANTOM S/NO:	HeadBox1.csv	LIQUID TEMPERATURE:	20.70°C
PHANTOM ROTATION:	0°	MAX SAR X-AXIS LOCATION:	Off Edge
DUT POSITION:	Screen 90° - Area 4	MAX SAR Y-AXIS LOCATION:	Off Edge
ANTENNA CONFIGURATION:	C	MAX E FIELD:	3.61 V/m
TEST FREQUENCY:	2412MHz	SAR 1g:	N/A
AIR FACTORS:	368 / 390 / 442	SAR 10g:	N/A
CONVERSION FACTORS:	.276 / .276 / .276	SAR START:	N/A
TYPE OF MODULATION:	CW	SAR END:	N/A
MODN. DUTY CYCLE:	100.0 %	SAR DRIFT DURING SCAN:	0.00 %
DIODE COMPRESSION FACTORS (V*200):	20 / 20 / 20	PROBE BATTERY LAST CHANGED:	14/08/2008
INPUT POWER LEVEL:	12.9 dBm	EXTRAPOLATION:	poly4

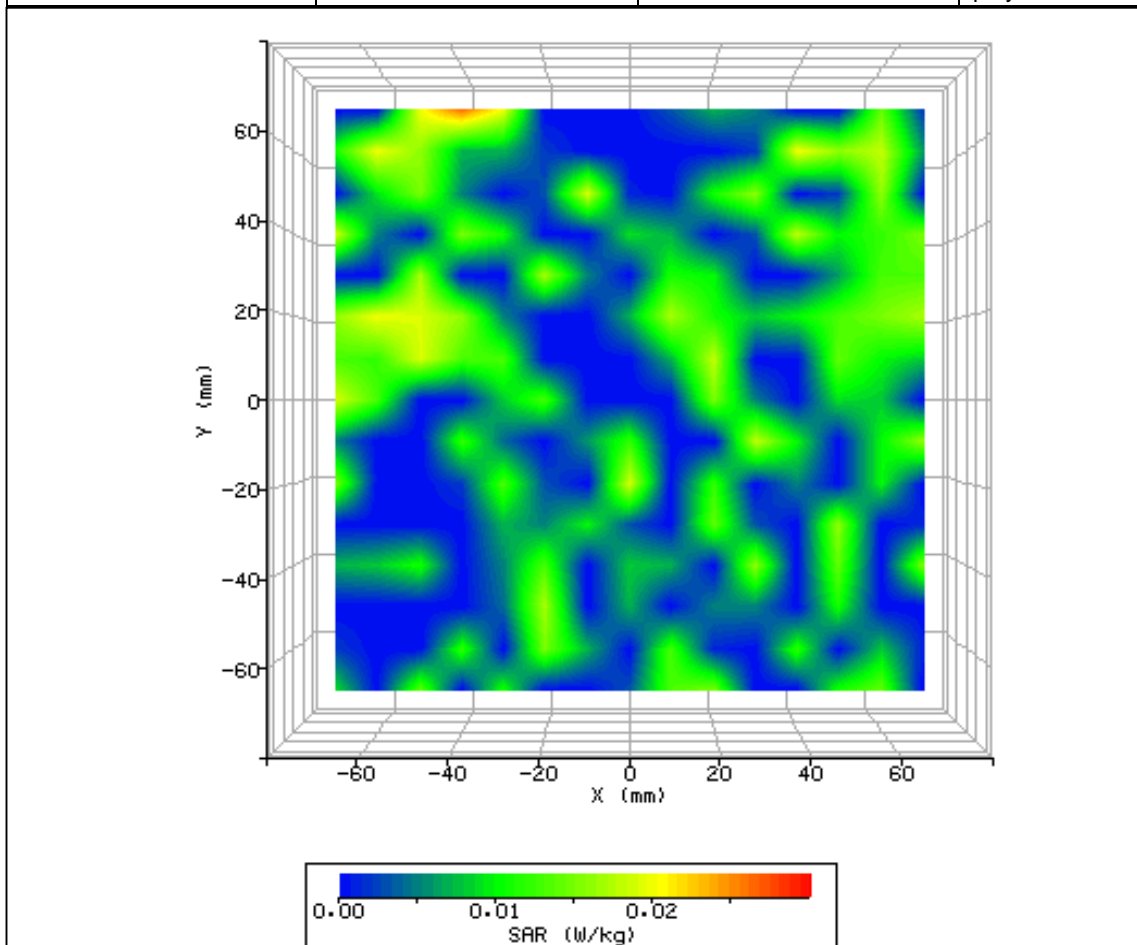

Figure 74: SAR Body Testing Results for the Intel WiFi Module in Screen 90° - Area 4 Phantom Position; Tested at 2412MHz (WLAN Low Channel) with 2mm Separation Distance to the Phantom (NUA).

SYSTEM / SOFTWARE:	SARA2 / 2.53 VPM	INPUT POWER DRIFT:	0.0 dB
DATE / TIME:	14/08/2008 17:27:38	DUT BATTERY MODEL/NO:	N/A
FILENAME:	75903561-70a.txt	PROBE SERIAL NUMBER:	0171
AMBIENT TEMPERATURE:	21.90°C	LIQUID SIMULANT:	2450Body
DEVICE UNDER TEST:	Intel Module	RELATIVE PERMITTIVITY:	52.97
RELATIVE HUMIDITY:	43.00%	CONDUCTIVITY:	1.990
PHANTOM S/NO:	HeadBox1.csv	LIQUID TEMPERATURE:	20.70°C
PHANTOM ROTATION:	0°	MAX SAR X-AXIS LOCATION:	-22.000mm
DUT POSITION:	Screen 90° - Area 5	MAX SAR Y-AXIS LOCATION:	70.000mm
ANTENNA CONFIGURATION:	C	MAX E FIELD:	3.22 V/m
TEST FREQUENCY:	2412MHz	SAR 1g:	N/A
AIR FACTORS:	368 / 390 / 442	SAR 10g:	N/A
CONVERSION FACTORS:	.276 / .276 / .276	SAR START:	N/A
TYPE OF MODULATION:	CW	SAR END:	N/A
MODN. DUTY CYCLE:	100.0 %	SAR DRIFT DURING SCAN:	0.00 %
DIODE COMPRESSION FACTORS (V*200):	20 / 20 / 20	PROBE BATTERY LAST CHANGED:	14/08/2008
INPUT POWER LEVEL:	12.9 dBm	EXTRAPOLATION:	poly4

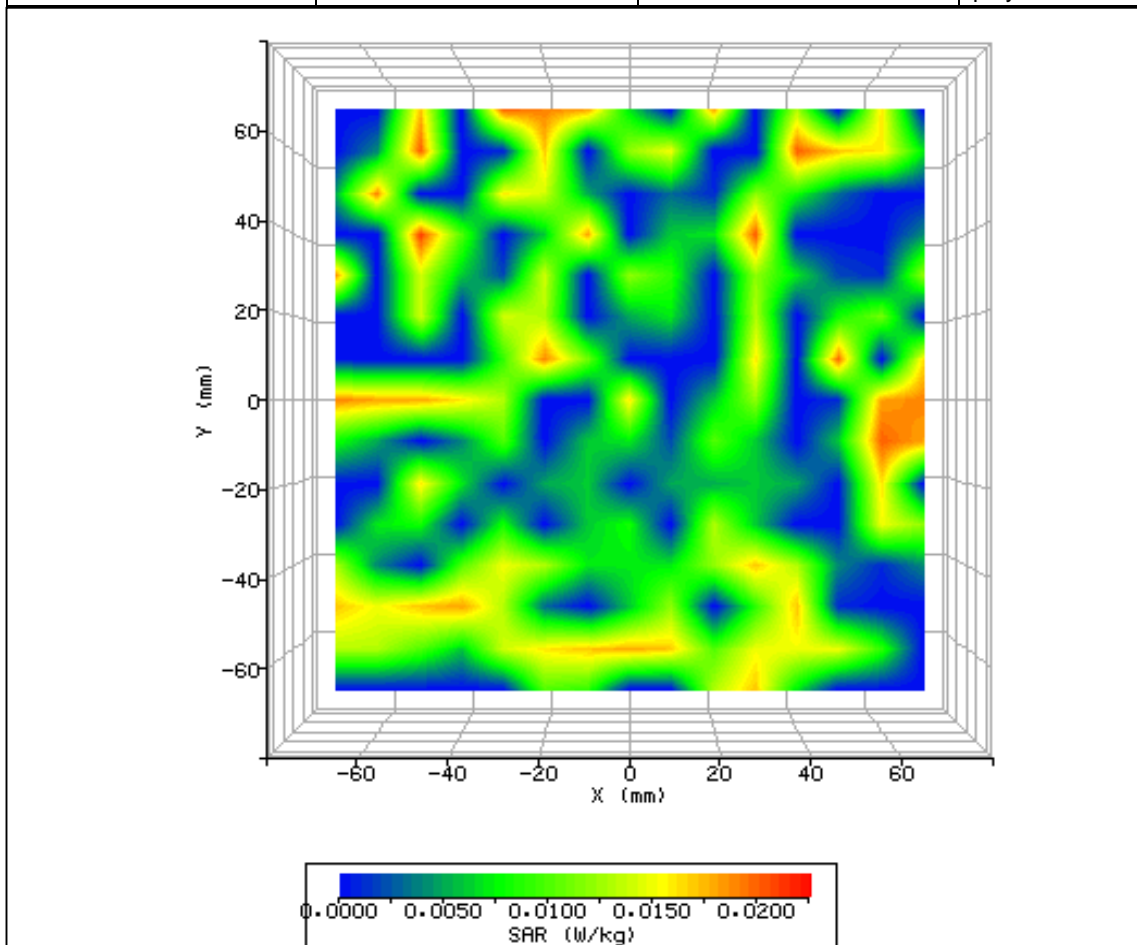

Figure 75: SAR Body Testing Results for the Intel WiFi Module in Screen 90° - Area 5 Phantom Position; Tested at 2412MHz (WLAN Low Channel) with 2mm Separation Distance to the Phantom (NUA).

SYSTEM / SOFTWARE:	SARA2 / 2.53 VPM	INPUT POWER DRIFT:	0.0 dB
DATE / TIME:	14/08/2008 18:12:19	DUT BATTERY MODEL/NO:	N/A
FILENAME:	75903561-71a.txt	PROBE SERIAL NUMBER:	0171
AMBIENT TEMPERATURE:	21.80°C	LIQUID SIMULANT:	2450Body
DEVICE UNDER TEST:	Intel Module	RELATIVE PERMITTIVITY:	52.97
RELATIVE HUMIDITY:	43.10%	CONDUCTIVITY:	1.990
PHANTOM S/NO:	HeadBox1.csv	LIQUID TEMPERATURE:	20.70°C
PHANTOM ROTATION:	0°	MAX SAR X-AXIS LOCATION:	Off Edge
DUT POSITION:	Screen 90° - Area 6	MAX SAR Y-AXIS LOCATION:	Off Edge
ANTENNA CONFIGURATION:	C	MAX E FIELD:	3.28 V/m
TEST FREQUENCY:	2412MHz	SAR 1g:	N/A
AIR FACTORS:	368 / 390 / 442	SAR 10g:	N/A
CONVERSION FACTORS:	.276 / .276 / .276	SAR START:	N/A
TYPE OF MODULATION:	CW	SAR END:	N/A
MODN. DUTY CYCLE:	100.0 %	SAR DRIFT DURING SCAN:	0.00 %
DIODE COMPRESSION FACTORS (V*200):	20 / 20 / 20	PROBE BATTERY LAST CHANGED:	14/08/2008
INPUT POWER LEVEL:	12.9 dBm	EXTRAPOLATION:	poly4

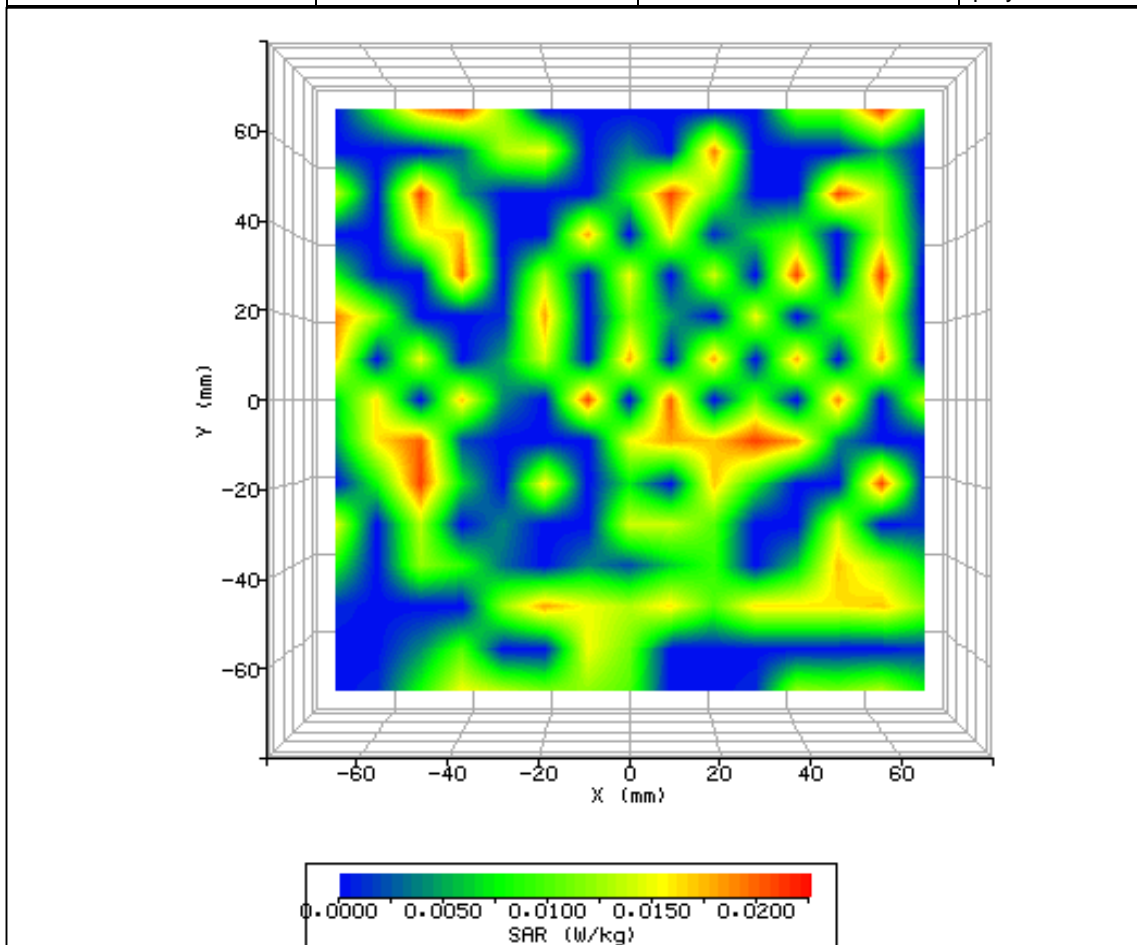

Figure 76: SAR Body Testing Results for the Intel WiFi Module in Screen 90° - Area 6 Phantom Position; Tested at 2412MHz (WLAN Low Channel) with 2mm Separation Distance to the Phantom (NUA).

SYSTEM / SOFTWARE:	SARA2 / 2.53 VPM	INPUT POWER DRIFT:	0.0 dB
DATE / TIME:	14/08/2008 18:03:08	DUT BATTERY MODEL/NO:	N/A
FILENAME:	75903561-72a.txt	PROBE SERIAL NUMBER:	0171
AMBIENT TEMPERATURE:	21.90°C	LIQUID SIMULANT:	2450Body
DEVICE UNDER TEST:	Intel Module	RELATIVE PERMITTIVITY:	52.97
RELATIVE HUMIDITY:	42.10%	CONDUCTIVITY:	1.990
PHANTOM S/NO:	HeadBox1.csv	LIQUID TEMPERATURE:	20.70°C
PHANTOM ROTATION:	0°	MAX SAR X-AXIS LOCATION:	42.000mm
DUT POSITION:	Screen 90° - Area 3	MAX SAR Y-AXIS LOCATION:	37.000mm
ANTENNA CONFIGURATION:	B	MAX E FIELD:	6.60 V/m
TEST FREQUENCY:	2412MHz	SAR 1g:	0.119 W/kg
AIR FACTORS:	368 / 390 / 442	SAR 10g:	0.072 W/kg
CONVERSION FACTORS:	.276 / .276 / .276	SAR START:	0.015 W/kg
TYPE OF MODULATION:	CW	SAR END:	0.016 W/kg
MODN. DUTY CYCLE:	100.0 %	SAR DRIFT DURING SCAN:	0.43 %
DIODE COMPRESSION FACTORS (V*200):	20 / 20 / 20	PROBE BATTERY LAST CHANGED:	14/08/2008
INPUT POWER LEVEL:	12.9 dBm	EXTRAPOLATION:	poly4

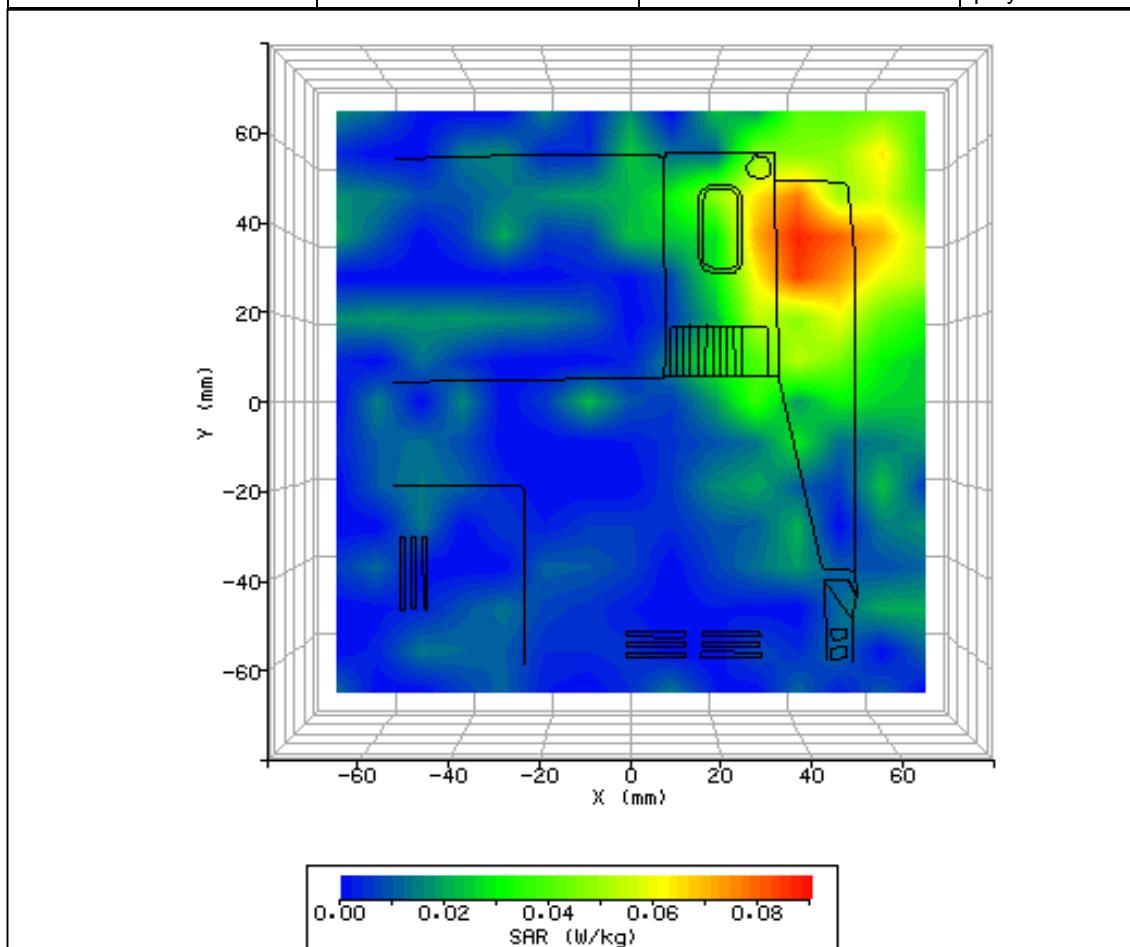

Figure 77: SAR Body Testing Results for the Intel WiFi Module in Screen 90° - Area 3 Phantom Position; Tested at 2412MHz (WLAN Low Channel) with 2mm Separation Distance to the Phantom (NUA).

2.11 WLAN 802.11g BODY SAR TEST RESULTS AND COURSE AREA SCANS – 2D

SYSTEM / SOFTWARE:	SARA2 / 2.53 VPM	INPUT POWER DRIFT:	0.0 dB
DATE / TIME:	19/08/2008 11:31:43	DUT BATTERY MODEL/NO:	N/A
FILENAME:	75903561-73a.txt	PROBE SERIAL NUMBER:	0171
AMBIENT TEMPERATURE:	22.10°C	LIQUID SIMULANT:	2450Body
DEVICE UNDER TEST:	Intel Module	RELATIVE PERMITTIVITY:	52.97
RELATIVE HUMIDITY:	42.60%	CONDUCTIVITY:	1.990
PHANTOM S/NO:	HeadBox1.csv	LIQUID TEMPERATURE:	20.80°C
PHANTOM ROTATION:	0°	MAX SAR X-AXIS LOCATION:	38.00mm
DUT POSITION:	Screen 90° - Area 3	MAX SAR Y-AXIS LOCATION:	42.00mm
ANTENNA CONFIGURATION:	A	MAX E FIELD:	5.79 V/m
TEST FREQUENCY:	2437MHz	SAR 1g:	N/A
AIR FACTORS:	368 / 390 / 442	SAR 10g:	N/A
CONVERSION FACTORS:	.276 / .276 / .276	SAR START:	N/A
TYPE OF MODULATION:	CW	SAR END:	N/A
MODN. DUTY CYCLE:	100.0 %	SAR DRIFT DURING SCAN:	0.00 %
DIODE COMPRESSION FACTORS (V*200):	20 / 20 / 20	PROBE BATTERY LAST CHANGED:	19/08/2008
INPUT POWER LEVEL:	13.8 dBm	EXTRAPOLATION:	poly4

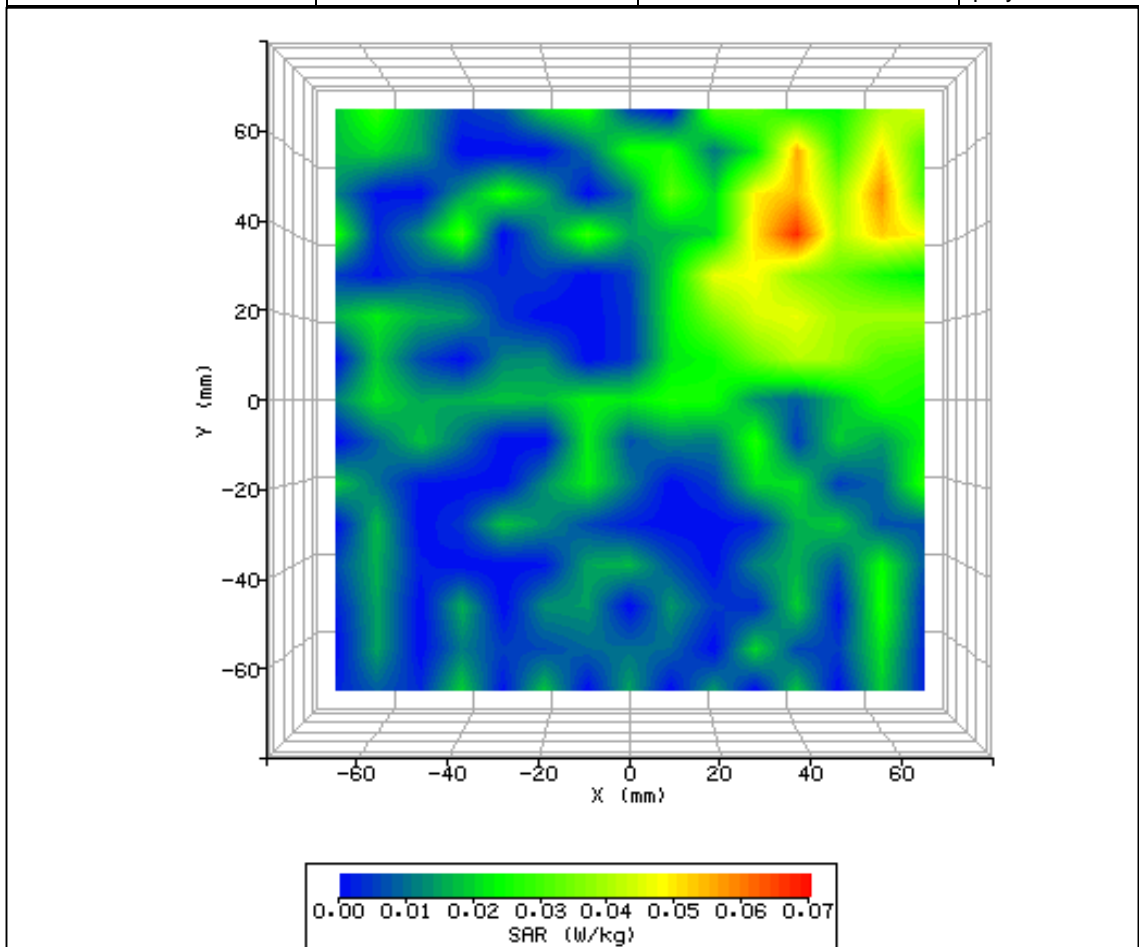

Figure 78: SAR Body Testing Results for the Intel WiFi Module in Screen 90° - Area 3 Phantom Position; Tested at 2437MHz (WLAN Mid Channel) with 2mm Separation Distance to the Phantom (NUA).



SYSTEM / SOFTWARE:	SARA2 / 2.53 VPM	INPUT POWER DRIFT:	0.0 dB
DATE / TIME:	19/08/2008 11:47:50	DUT BATTERY MODEL/NO:	N/A
FILENAME:	75903561-74a.txt	PROBE SERIAL NUMBER:	0171
AMBIENT TEMPERATURE:	22.30°C	LIQUID SIMULANT:	2450Body
DEVICE UNDER TEST:	Intel Module	RELATIVE PERMITTIVITY:	52.97
RELATIVE HUMIDITY:	42.70%	CONDUCTIVITY:	1.990
PHANTOM S/NO:	HeadBox1.csv	LIQUID TEMPERATURE:	20.80°C
PHANTOM ROTATION:	0°	MAX SAR X-AXIS LOCATION:	48.00mm
DUT POSITION:	Screen 90° - Area 3	MAX SAR Y-AXIS LOCATION:	41.00mm
ANTENNA CONFIGURATION:	B	MAX E FIELD:	6.48 V/m
TEST FREQUENCY:	2437MHz	SAR 1g:	N/A
AIR FACTORS:	368 / 390 / 442	SAR 10g:	N/A
CONVERSION FACTORS:	.276 / .276 / .276	SAR START:	N/A
TYPE OF MODULATION:	CW	SAR END:	N/A
MODN. DUTY CYCLE:	100.0 %	SAR DRIFT DURING SCAN:	0.00 %
DIODE COMPRESSION FACTORS (V*200):	20 / 20 / 20	PROBE BATTERY LAST CHANGED:	19/08/2008
INPUT POWER LEVEL:	13.8 dBm	EXTRAPOLATION:	poly4

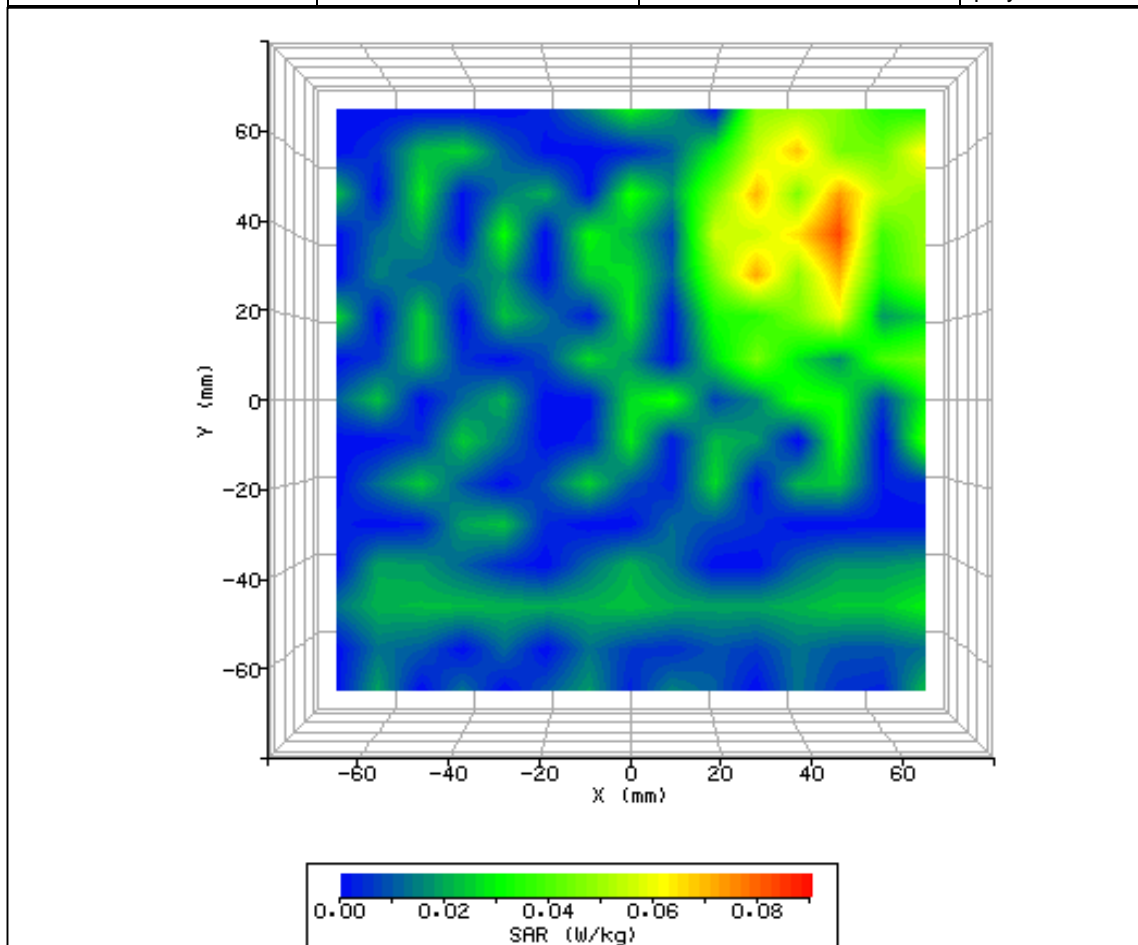

Figure 79: SAR Body Testing Results for the Intel WiFi Module in Screen 90° - Area 3 Phantom Position; Tested at 2437MHz (WLAN Mid Channel) with 2mm Separation Distance to the Phantom (NUA).

SYSTEM / SOFTWARE:	SARA2 / 2.53 VPM	INPUT POWER DRIFT:	0.0 dB
DATE / TIME:	19/08/2008 12:15:32	DUT BATTERY MODEL/NO:	N/A
FILENAME:	75903561-75a.txt	PROBE SERIAL NUMBER:	0171
AMBIENT TEMPERATURE:	22.40°C	LIQUID SIMULANT:	2450Body
DEVICE UNDER TEST:	Intel Module	RELATIVE PERMITTIVITY:	52.97
RELATIVE HUMIDITY:	43.60%	CONDUCTIVITY:	1.990
PHANTOM S/NO:	HeadBox1.csv	LIQUID TEMPERATURE:	20.80°C
PHANTOM ROTATION:	0°	MAX SAR X-AXIS LOCATION:	-39.00mm
DUT POSITION:	Screen 90° - Area 1	MAX SAR Y-AXIS LOCATION:	41.00mm
ANTENNA CONFIGURATION:	C	MAX E FIELD:	8.61 V/m
TEST FREQUENCY:	2437MHz	SAR 1g:	0.182 W/kg
AIR FACTORS:	368 / 390 / 442	SAR 10g:	0.113 W/kg
CONVERSION FACTORS:	.276 / .276 / .276	SAR START:	0.029 W/kg
TYPE OF MODULATION:	CW	SAR END:	0.029 W/kg
MODN. DUTY CYCLE:	100.0 %	SAR DRIFT DURING SCAN:	-1.38 %
DIODE COMPRESSION FACTORS (V*200):	20 / 20 / 20	PROBE BATTERY LAST CHANGED:	19/08/2008
INPUT POWER LEVEL:	13.8 dBm	EXTRAPOLATION:	poly4

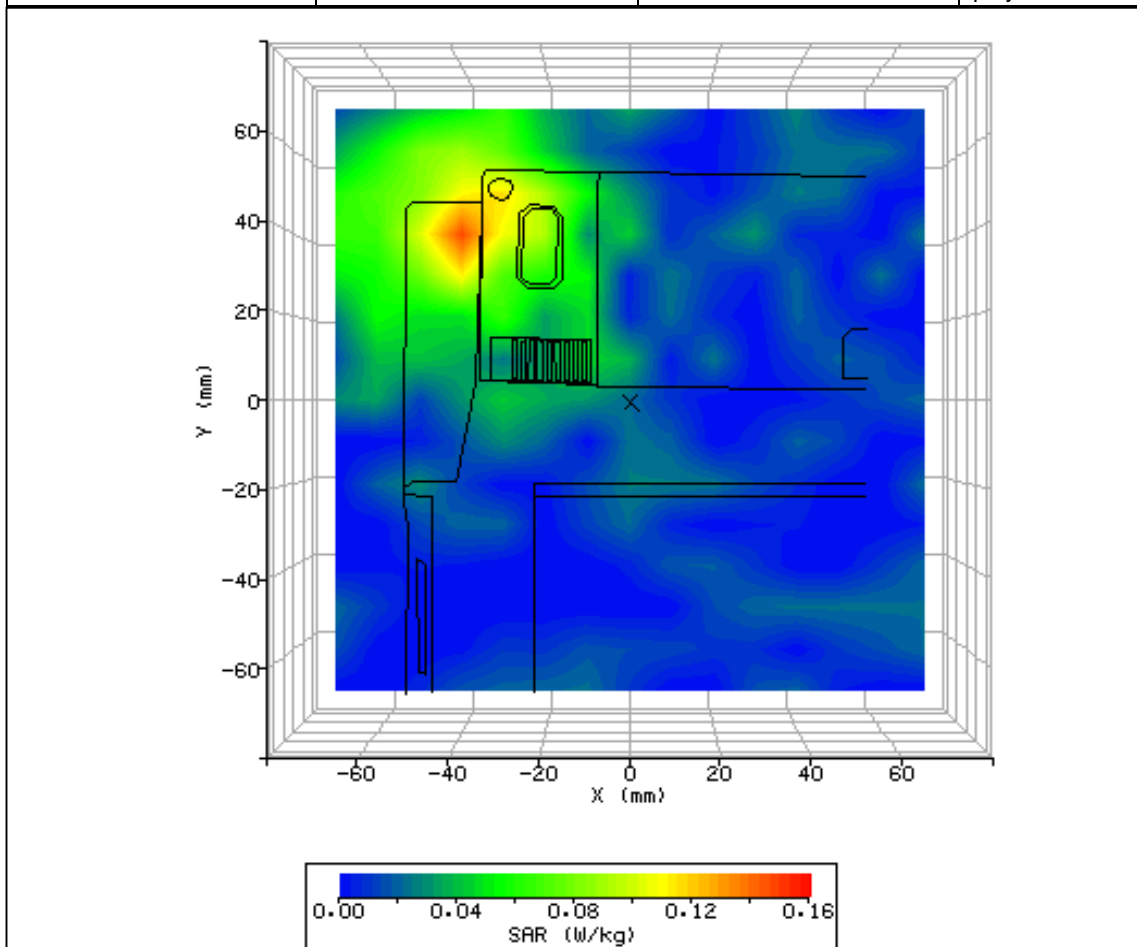

Figure 80: SAR Body Testing Results for the Intel WiFi Module in Screen 90° - Area 1 Phantom Position; Tested at 2437MHz (WLAN Mid Channel) with 2mm Separation Distance to the Phantom (NUA).

2.12 WLAN 802.11a BODY SAR TEST RESULTS AND COURSE AREA SCANS – 2D

SYSTEM / SOFTWARE:	SARA2 / 2.53 VPM	INPUT POWER DRIFT:	0.0 dB
DATE / TIME:	20/08/2008 17:18:42	DUT BATTERY MODEL/NO:	N/A
FILENAME:	75903561-76a.txt	PROBE SERIAL NUMBER:	0171
AMBIENT TEMPERATURE:	23.00°C	LIQUID SIMULANT:	5800Body
DEVICE UNDER TEST:	Intel Module	RELATIVE PERMITTIVITY:	50.02
RELATIVE HUMIDITY:	58.60%	CONDUCTIVITY:	6.773
PHANTOM S/NO:	HeadBox1.csv	LIQUID TEMPERATURE:	22.30°C
PHANTOM ROTATION:	0°	MAX SAR X-AXIS LOCATION:	Off Edge
DUT POSITION:	Screen 90° - Area 1	MAX SAR Y-AXIS LOCATION:	Off Edge
ANTENNA CONFIGURATION:	A	MAX E FIELD:	5.20 V/m
TEST FREQUENCY:	5785MHz	SAR 1g:	N/A
AIR FACTORS:	368 / 390 / 442	SAR 10g:	N/A
CONVERSION FACTORS:	.276 / .276 / .276	SAR START:	N/A
TYPE OF MODULATION:	CW	SAR END:	N/A
MODN. DUTY CYCLE:	100.0 %	SAR DRIFT DURING SCAN:	0.00 %
DIODE COMPRESSION FACTORS (V*200):	20 / 20 / 20	PROBE BATTERY LAST CHANGED:	20/08/2008
INPUT POWER LEVEL:	13.9 dBm	EXTRAPOLATION:	poly4

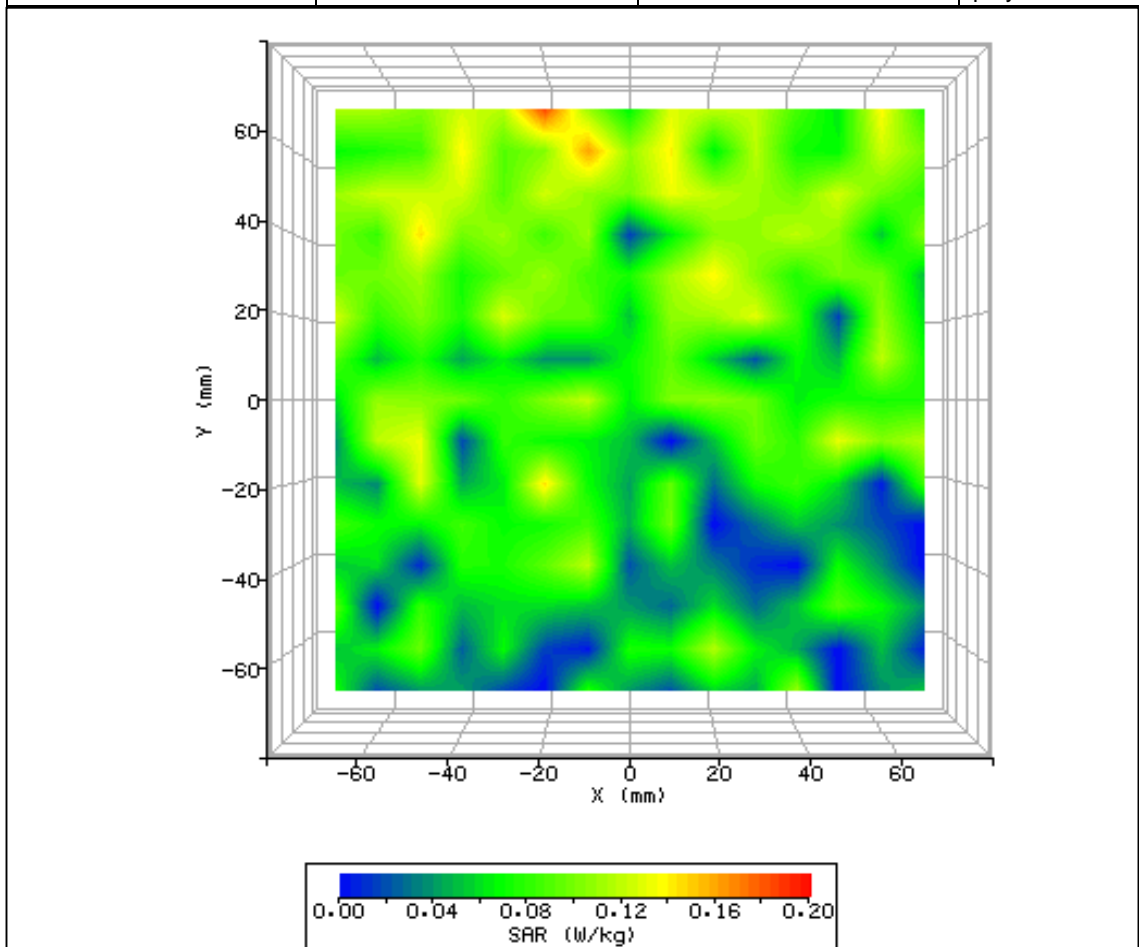

Figure 81: SAR Body Testing Results for the Intel WiFi Module in Screen 90° - Area 1 Phantom Position; Tested at 5785MHz (WLAN Mid Channel) with 2mm Separation Distance to the Phantom (NUA).

SYSTEM / SOFTWARE:	SARA2 / 2.53 VPM	INPUT POWER DRIFT:	0.0 dB
DATE / TIME:	20/08/2008 17:30:06	DUT BATTERY MODEL/NO:	N/A
FILENAME:	75903561-77a.txt	PROBE SERIAL NUMBER:	0171
AMBIENT TEMPERATURE:	23.00°C	LIQUID SIMULANT:	5800Body
DEVICE UNDER TEST:	Intel Module	RELATIVE PERMITTIVITY:	50.02
RELATIVE HUMIDITY:	57.60%	CONDUCTIVITY:	6.773
PHANTOM S/NO:	HeadBox1.csv	LIQUID TEMPERATURE:	22.30°C
PHANTOM ROTATION:	0°	MAX SAR X-AXIS LOCATION:	Off Edge
DUT POSITION:	Screen 90° - Area 2	MAX SAR Y-AXIS LOCATION:	Off Edge
ANTENNA CONFIGURATION:	A	MAX E FIELD:	5.42 V/m
TEST FREQUENCY:	5785MHz	SAR 1g:	N/A
AIR FACTORS:	368 / 390 / 442	SAR 10g:	N/A
CONVERSION FACTORS:	.276 / .276 / .276	SAR START:	N/A
TYPE OF MODULATION:	CW	SAR END:	N/A
MODN. DUTY CYCLE:	100.0 %	SAR DRIFT DURING SCAN:	0.00 %
DIODE COMPRESSION FACTORS (V*200):	20 / 20 / 20	PROBE BATTERY LAST CHANGED:	20/08/2008
INPUT POWER LEVEL:	13.9 dBm	EXTRAPOLATION:	poly4

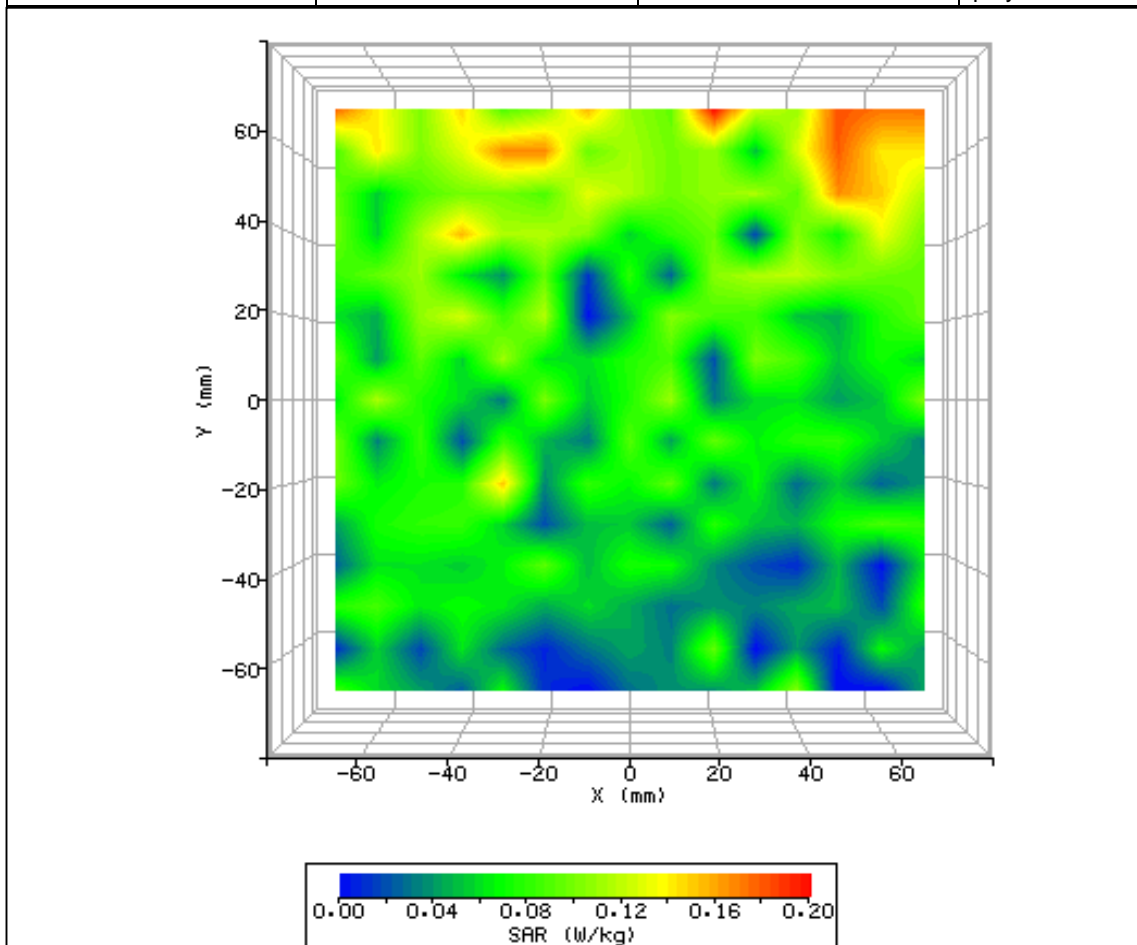

Figure 82: SAR Body Testing Results for the Intel WiFi Module in Screen 90° - Area 2 Phantom Position; Tested at 5785MHz (WLAN Mid Channel) with 2mm Separation Distance to the Phantom (NUA).

SYSTEM / SOFTWARE:	SARA2 / 2.53 VPM	INPUT POWER DRIFT:	0.0 dB
DATE / TIME:	21/08/2008 10:18:28	DUT BATTERY MODEL/NO:	N/A
FILENAME:	75903561-78a.txt	PROBE SERIAL NUMBER:	0171
AMBIENT TEMPERATURE:	23.10°C	LIQUID SIMULANT:	5800Body
DEVICE UNDER TEST:	Intel Module	RELATIVE PERMITTIVITY:	50.02
RELATIVE HUMIDITY:	59.50%	CONDUCTIVITY:	6.773
PHANTOM S/NO:	HeadBox1.csv	LIQUID TEMPERATURE:	22.30°C
PHANTOM ROTATION:	0°	MAX SAR X-AXIS LOCATION:	31.000mm
DUT POSITION:	Screen 90° - Area 3	MAX SAR Y-AXIS LOCATION:	20.000mm
ANTENNA CONFIGURATION:	A	MAX E FIELD:	5.94 V/m
TEST FREQUENCY:	5785MHz	SAR 1g:	0.255 W/kg
AIR FACTORS:	368 / 390 / 442	SAR 10g:	0.205 W/kg
CONVERSION FACTORS:	.276 / .276 / .276	SAR START:	0.100 W/kg
TYPE OF MODULATION:	CW	SAR END:	0.099 W/kg
MODN. DUTY CYCLE:	100.0 %	SAR DRIFT DURING SCAN:	-1.29 %
DIODE COMPRESSION FACTORS (V*200):	20 / 20 / 20	PROBE BATTERY LAST CHANGED:	20/08/2008
INPUT POWER LEVEL:	13.9 dBm	EXTRAPOLATION:	poly4

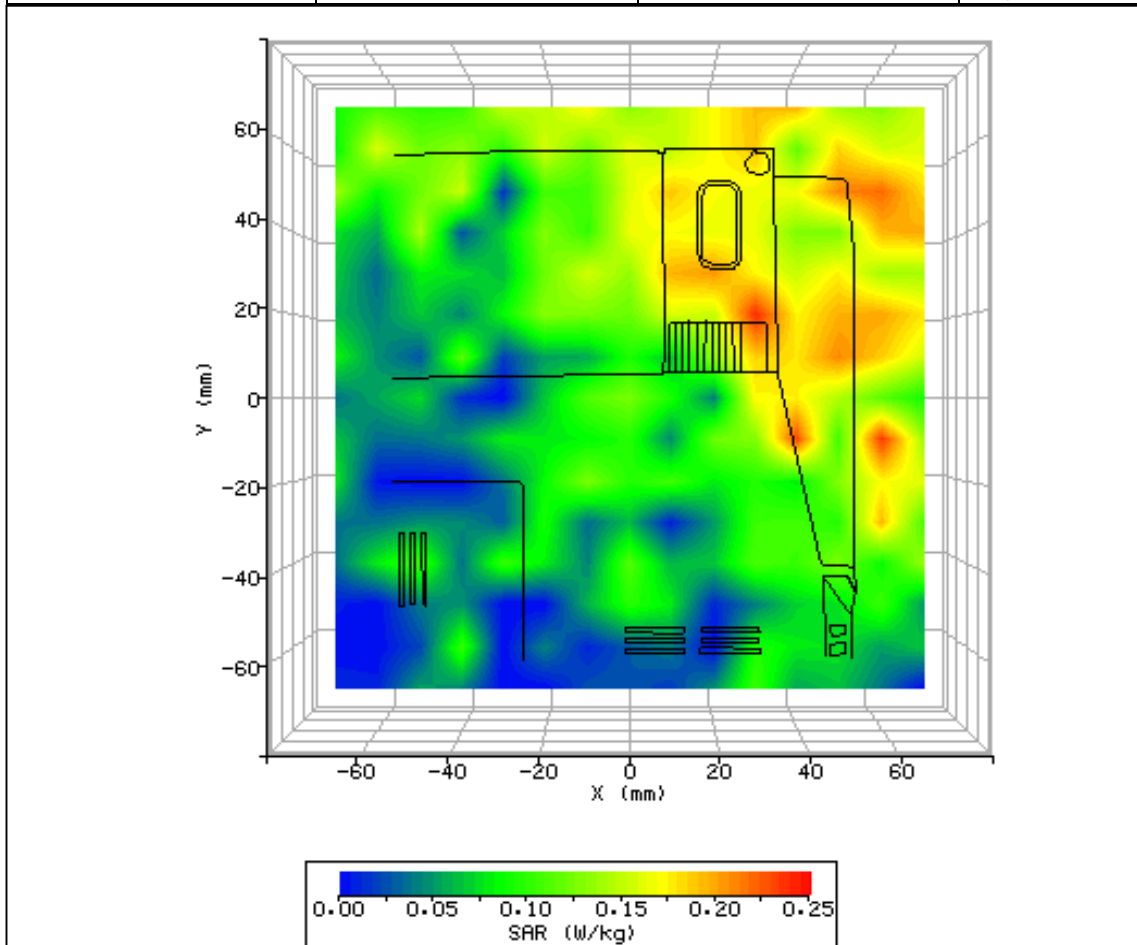

Figure 83: SAR Body Testing Results for the Intel WiFi Module in Screen 90° - Area 3 Phantom Position; Tested at 5785MHz (WLAN Mid Channel) with 2mm Separation Distance to the Phantom (NUA).



SYSTEM / SOFTWARE:	SARA2 / 2.53 VPM	INPUT POWER DRIFT:	0.0 dB
DATE / TIME:	21/08/2008 10:29:46	DUT BATTERY MODEL/NO:	N/A
FILENAME:	75903561-79a.txt	PROBE SERIAL NUMBER:	0171
AMBIENT TEMPERATURE:	22.80°C	LIQUID SIMULANT:	5800Body
DEVICE UNDER TEST:	Intel Module	RELATIVE PERMITTIVITY:	50.02
RELATIVE HUMIDITY:	55..9%	CONDUCTIVITY:	6.773
PHANTOM S/NO:	HeadBox1.csv	LIQUID TEMPERATURE:	22.30°C
PHANTOM ROTATION:	0°	MAX SAR X-AXIS LOCATION:	Off Edge
DUT POSITION:	Screen 90° - Area 4	MAX SAR Y-AXIS LOCATION:	Off Edge
ANTENNA CONFIGURATION:	A	MAX E FIELD:	4.17 V/m
TEST FREQUENCY:	5785MHz	SAR 1g:	N/A
AIR FACTORS:	368 / 390 / 442	SAR 10g:	N/A
CONVERSION FACTORS:	.276 / .276 / .276	SAR START:	N/A
TYPE OF MODULATION:	CW	SAR END:	N/A
MODN. DUTY CYCLE:	100.0 %	SAR DRIFT DURING SCAN:	0.00 %
DIODE COMPRESSION FACTORS (V*200):	20 / 20 / 20	PROBE BATTERY LAST CHANGED:	20/08/2008
INPUT POWER LEVEL:	13.9 dBm	EXTRAPOLATION:	poly4

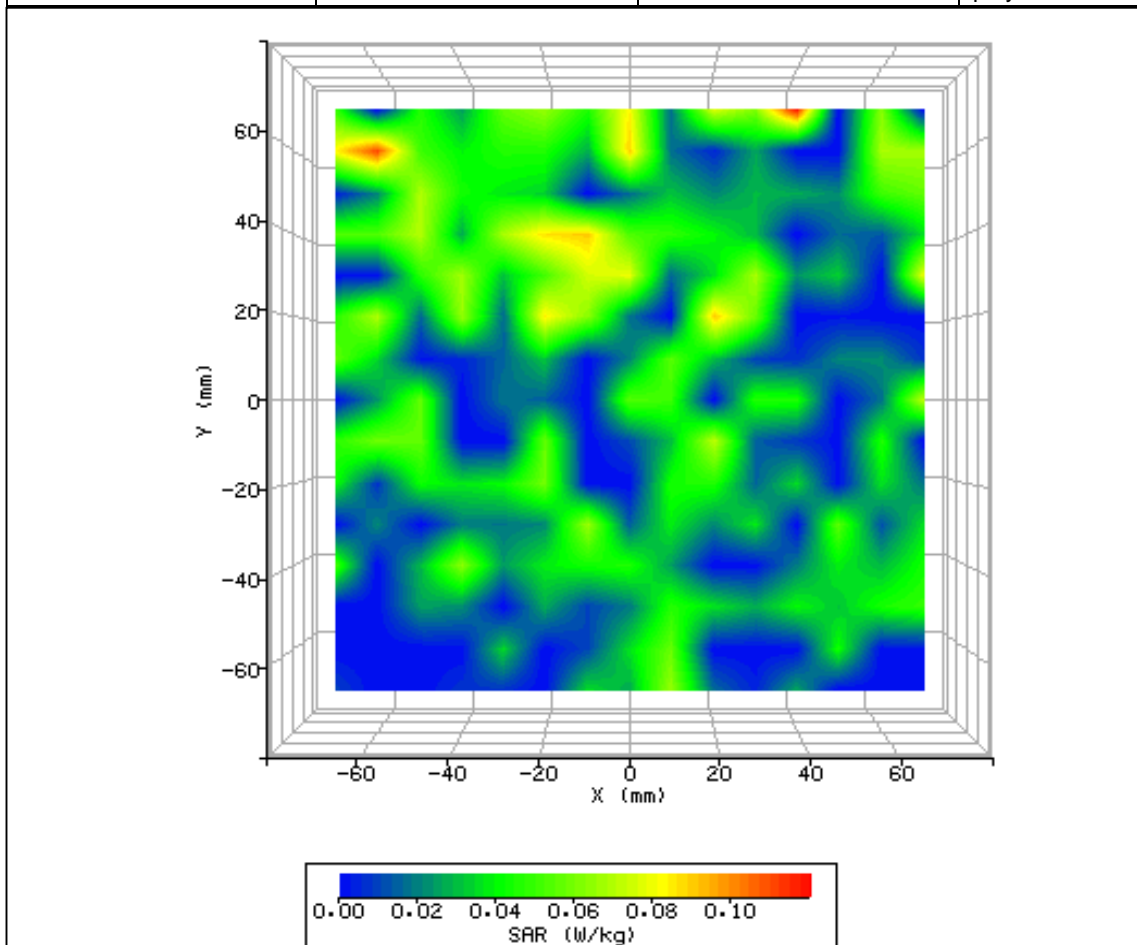

Figure 84: SAR Body Testing Results for the Intel WiFi Module in Screen 90° - Area 4 Phantom Position; Tested at 5785MHz (WLAN Mid Channel) with 2mm Separation Distance to the Phantom (NUA).



SYSTEM / SOFTWARE:	SARA2 / 2.53 VPM	INPUT POWER DRIFT:	0.0 dB
DATE / TIME:	21/08/2008 10:41:52	DUT BATTERY MODEL/NO:	N/A
FILENAME:	75903561-80a.txt	PROBE SERIAL NUMBER:	0171
AMBIENT TEMPERATURE:	22.50°C	LIQUID SIMULANT:	5800Body
DEVICE UNDER TEST:	Intel Module	RELATIVE PERMITTIVITY:	50.02
RELATIVE HUMIDITY:	53.70%	CONDUCTIVITY:	6.773
PHANTOM S/NO:	HeadBox1.csv	LIQUID TEMPERATURE:	22.30°C
PHANTOM ROTATION:	0°	MAX SAR X-AXIS LOCATION:	Off Edge
DUT POSITION:	Screen 90° - Area 5	MAX SAR Y-AXIS LOCATION:	Off Edge
ANTENNA CONFIGURATION:	A	MAX E FIELD:	3.89 V/m
TEST FREQUENCY:	5785MHz	SAR 1g:	N/A
AIR FACTORS:	368 / 390 / 442	SAR 10g:	N/A
CONVERSION FACTORS:	.276 / .276 / .276	SAR START:	N/A
TYPE OF MODULATION:	CW	SAR END:	N/A
MODN. DUTY CYCLE:	100.0 %	SAR DRIFT DURING SCAN:	0.00 %
DIODE COMPRESSION FACTORS (V*200):	20 / 20 / 20	PROBE BATTERY LAST CHANGED:	20/08/2008
INPUT POWER LEVEL:	13.9 dBm	EXTRAPOLATION:	poly4

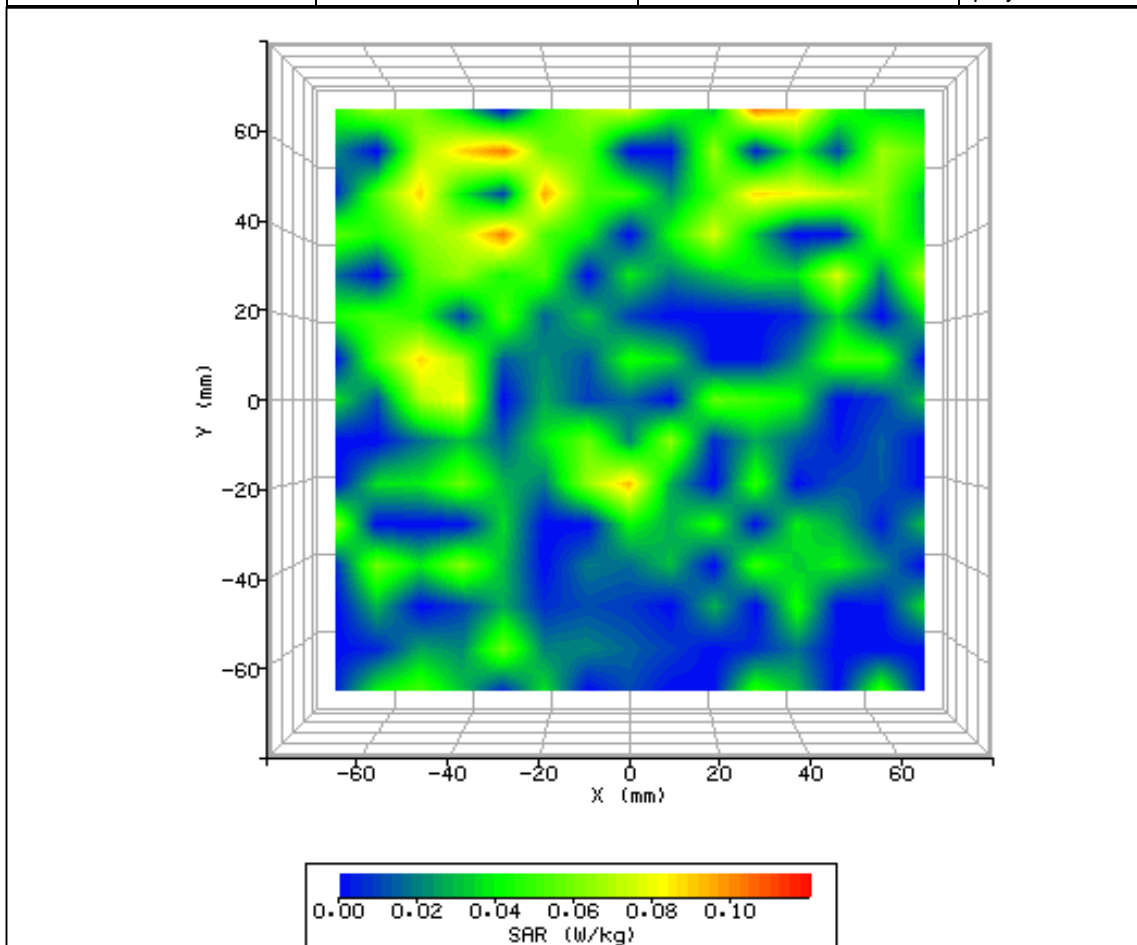

Figure 85: SAR Body Testing Results for the Intel WiFi Module in Screen 90° - Area 5 Phantom Position; Tested at 5785MHz (WLAN Mid Channel) with 2mm Separation Distance to the Phantom (NUA).

SYSTEM / SOFTWARE:	SARA2 / 2.53 VPM	INPUT POWER DRIFT:	0.0 dB
DATE / TIME:	21/08/2008 10:54:52	DUT BATTERY MODEL/NO:	N/A
FILENAME:	75903561-81a.txt	PROBE SERIAL NUMBER:	0171
AMBIENT TEMPERATURE:	22.10°C	LIQUID SIMULANT:	5800Body
DEVICE UNDER TEST:	Intel Module	RELATIVE PERMITTIVITY:	50.02
RELATIVE HUMIDITY:	52.50%	CONDUCTIVITY:	6.773
PHANTOM S/NO:	HeadBox1.csv	LIQUID TEMPERATURE:	22.30°C
PHANTOM ROTATION:	0°	MAX SAR X-AXIS LOCATION:	Off Edge
DUT POSITION:	Screen 90° - Area 6	MAX SAR Y-AXIS LOCATION:	Off Edge
ANTENNA CONFIGURATION:	A	MAX E FIELD:	4.20 V/m
TEST FREQUENCY:	5785MHz	SAR 1g:	N/A
AIR FACTORS:	368 / 390 / 442	SAR 10g:	N/A
CONVERSION FACTORS:	.276 / .276 / .276	SAR START:	N/A
TYPE OF MODULATION:	CW	SAR END:	N/A
MODN. DUTY CYCLE:	100.0 %	SAR DRIFT DURING SCAN:	0.00 %
DIODE COMPRESSION FACTORS (V*200):	20 / 20 / 20	PROBE BATTERY LAST CHANGED:	20/08/2008
INPUT POWER LEVEL:	13.9 dBm	EXTRAPOLATION:	poly4

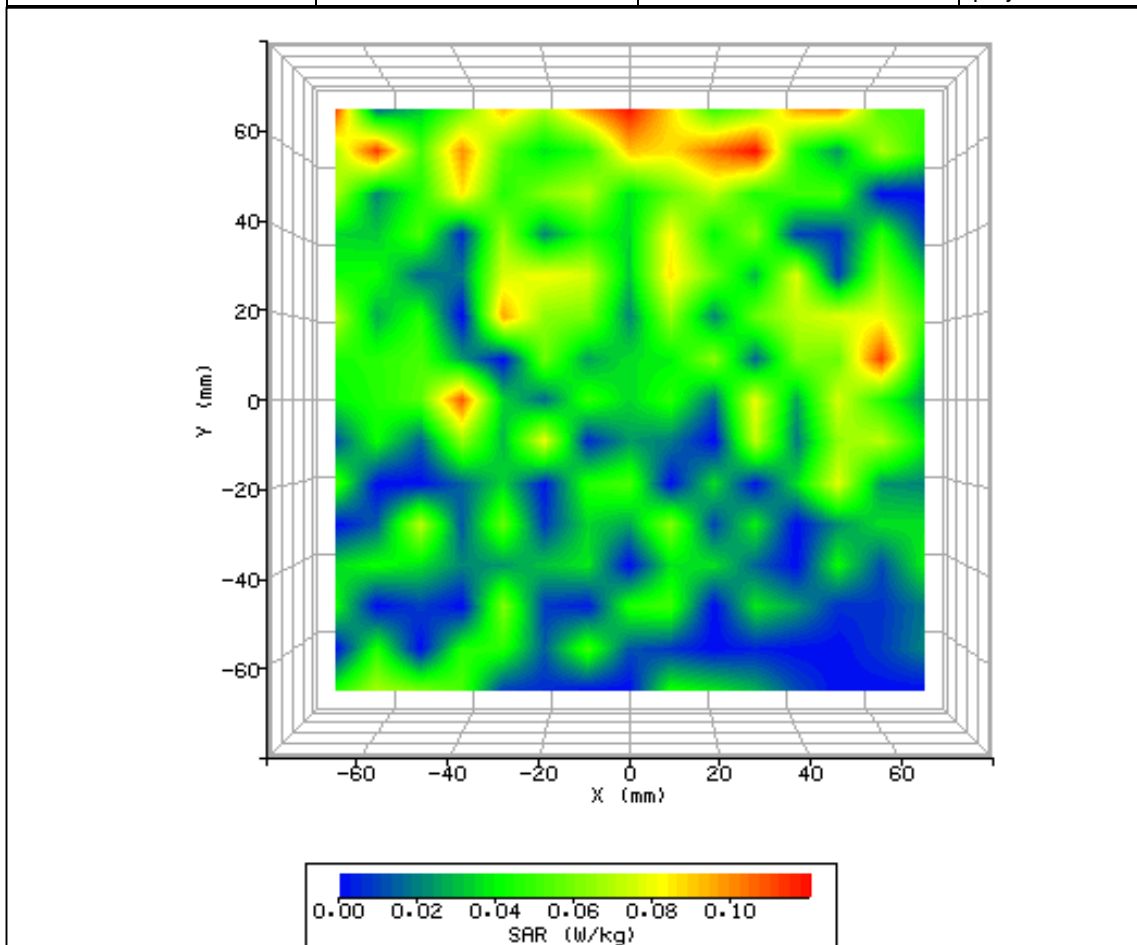

Figure 86: SAR Body Testing Results for the Intel WiFi Module in Screen 90° - Area 6 Phantom Position; Tested at 5785MHz (WLAN Mid Channel) with 2mm Separation Distance to the Phantom (NUA).



SYSTEM / SOFTWARE:	SARA2 / 2.53 VPM	INPUT POWER DRIFT:	0.0 dB
DATE / TIME:	21/08/2008 11:06:33	DUT BATTERY MODEL/NO:	N/A
FILENAME:	75903561-82a.txt	PROBE SERIAL NUMBER:	0171
AMBIENT TEMPERATURE:	22.00°C	LIQUID SIMULANT:	5800Body
DEVICE UNDER TEST:	Intel Module	RELATIVE PERMITTIVITY:	50.02
RELATIVE HUMIDITY:	52.40%	CONDUCTIVITY:	6.773
PHANTOM S/NO:	HeadBox1.csv	LIQUID TEMPERATURE:	22.30°C
PHANTOM ROTATION:	0°	MAX SAR X-AXIS LOCATION:	-70.00mm
DUT POSITION:	Screen 90° - Area 1	MAX SAR Y-AXIS LOCATION:	70.00mm
ANTENNA CONFIGURATION:	B	MAX E FIELD:	4.81 V/m
TEST FREQUENCY:	5785MHz	SAR 1g:	N/A
AIR FACTORS:	368 / 390 / 442	SAR 10g:	N/A
CONVERSION FACTORS:	.276 / .276 / .276	SAR START:	N/A
TYPE OF MODULATION:	CW	SAR END:	N/A
MODN. DUTY CYCLE:	100.0 %	SAR DRIFT DURING SCAN:	0.00 %
DIODE COMPRESSION FACTORS (V*200):	20 / 20 / 20	PROBE BATTERY LAST CHANGED:	20/08/2008
INPUT POWER LEVEL:	13.9 dBm	EXTRAPOLATION:	poly4

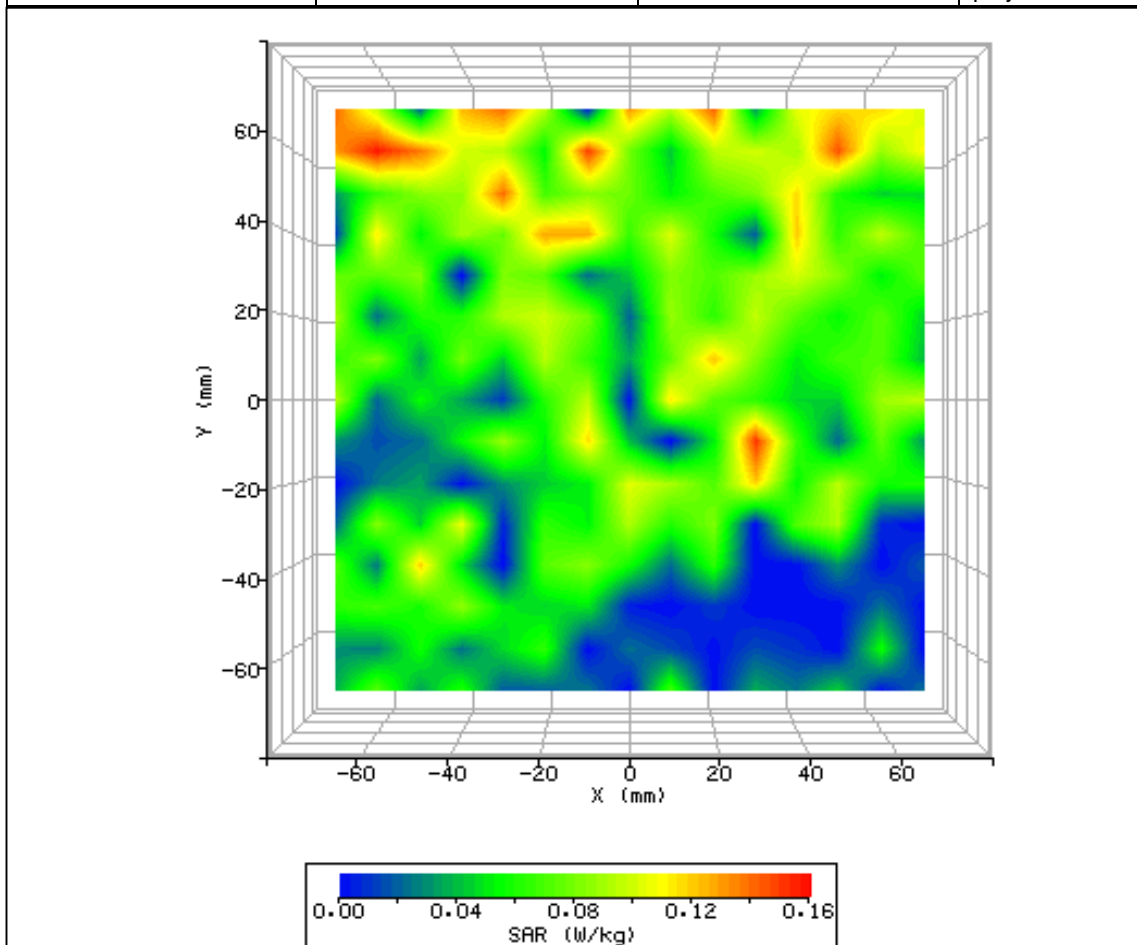

Figure 87: SAR Body Testing Results for the Intel WiFi Module in Screen 90° - Area 1 Phantom Position; Tested at 5785MHz (WLAN Mid Channel) with 2mm Separation Distance to the Phantom (NUA).

SYSTEM / SOFTWARE:	SARA2 / 2.53 VPM	INPUT POWER DRIFT:	0.0 dB
DATE / TIME:	21/08/2008 11:17:11	DUT BATTERY MODEL/NO:	N/A
FILENAME:	75903561-83a.txt	PROBE SERIAL NUMBER:	0171
AMBIENT TEMPERATURE:	21.90°C	LIQUID SIMULANT:	5800Body
DEVICE UNDER TEST:	Intel Module	RELATIVE PERMITTIVITY:	50.02
RELATIVE HUMIDITY:	53.20%	CONDUCTIVITY:	6.773
PHANTOM S/NO:	HeadBox1.csv	LIQUID TEMPERATURE:	22.30°C
PHANTOM ROTATION:	0°	MAX SAR X-AXIS LOCATION:	17.000mm
DUT POSITION:	Screen 90° - Area 2	MAX SAR Y-AXIS LOCATION:	70.000mm
ANTENNA CONFIGURATION:	B	MAX E FIELD:	4.80 V/m
TEST FREQUENCY:	5785MHz	SAR 1g:	N/A
AIR FACTORS:	368 / 390 / 442	SAR 10g:	N/A
CONVERSION FACTORS:	.276 / .276 / .276	SAR START:	N/A
TYPE OF MODULATION:	CW	SAR END:	N/A
MODN. DUTY CYCLE:	100.0 %	SAR DRIFT DURING SCAN:	0.00 %
DIODE COMPRESSION FACTORS (V*200):	20 / 20 / 20	PROBE BATTERY LAST CHANGED:	20/08/2008
INPUT POWER LEVEL:	13.9 dBm	EXTRAPOLATION:	poly4

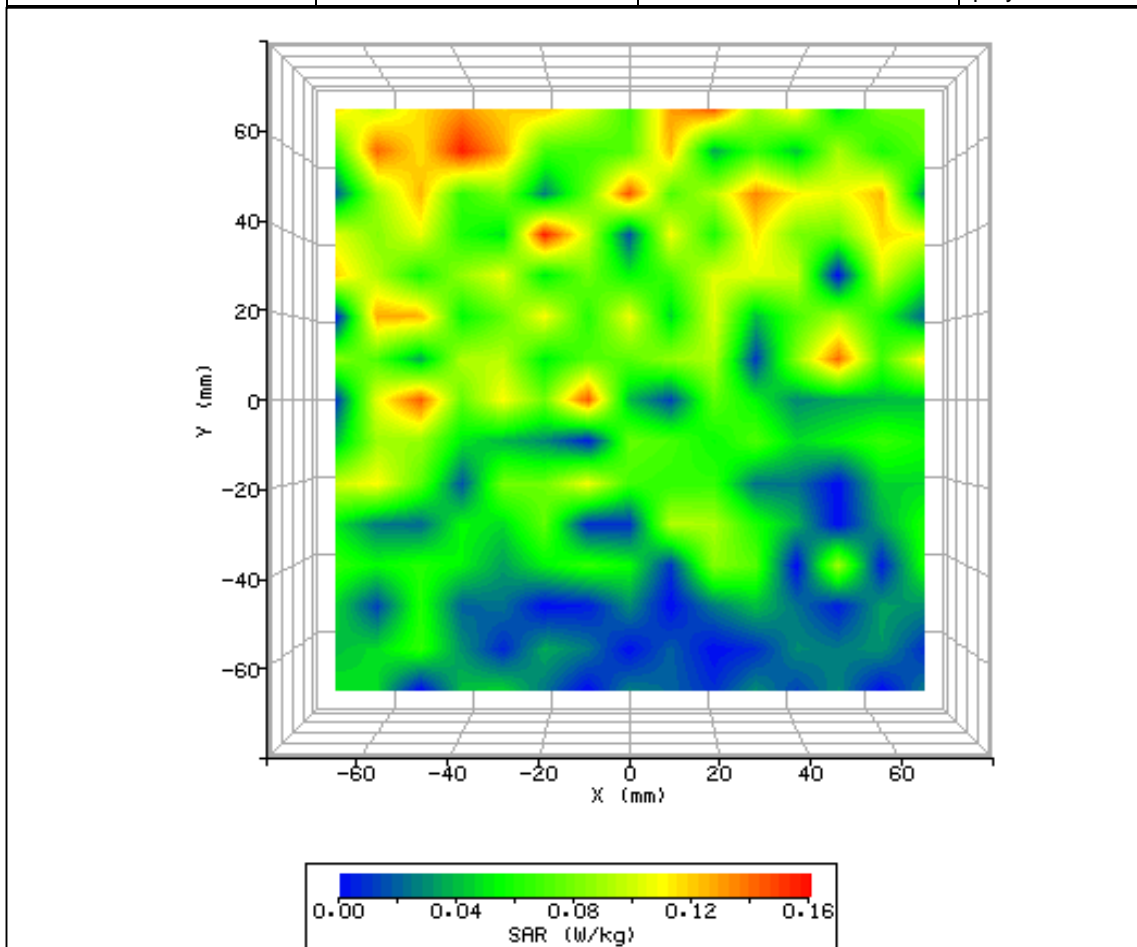

Figure 88: SAR Body Testing Results for the Intel WiFi Module in Screen 90° - Area 2 Phantom Position; Tested at 5785MHz (WLAN Mid Channel) with 2mm Separation Distance to the Phantom (NUA).

SYSTEM / SOFTWARE:	SARA2 / 2.53 VPM	INPUT POWER DRIFT:	0.0 dB
DATE / TIME:	21/08/2008 14:16:55	DUT BATTERY MODEL/NO:	N/A
FILENAME:	75903561-84a.txt	PROBE SERIAL NUMBER:	0171
AMBIENT TEMPERATURE:	22.40°C	LIQUID SIMULANT:	5800Body
DEVICE UNDER TEST:	Intel Module	RELATIVE PERMITTIVITY:	50.02
RELATIVE HUMIDITY:	53.10%	CONDUCTIVITY:	6.773
PHANTOM S/NO:	HeadBox1.csv	LIQUID TEMPERATURE:	22.40°C
PHANTOM ROTATION:	0°	MAX SAR X-AXIS LOCATION:	34.00mm
DUT POSITION:	Screen 90° - Area 3	MAX SAR Y-AXIS LOCATION:	70.00mm
ANTENNA CONFIGURATION:	B	MAX E FIELD:	5.74 V/m
TEST FREQUENCY:	5785MHz	SAR 1g:	0.196 W/kg
AIR FACTORS:	368 / 390 / 442	SAR 10g:	0.174 W/kg
CONVERSION FACTORS:	.276 / .276 / .276	SAR START:	0.184 W/kg
TYPE OF MODULATION:	CW	SAR END:	0.184 W/kg
MODN. DUTY CYCLE:	100.0 %	SAR DRIFT DURING SCAN:	0.00 %
DIODE COMPRESSION FACTORS (V*200):	20 / 20 / 20	PROBE BATTERY LAST CHANGED:	20/08/2008
INPUT POWER LEVEL:	13.9 dBm	EXTRAPOLATION:	poly4

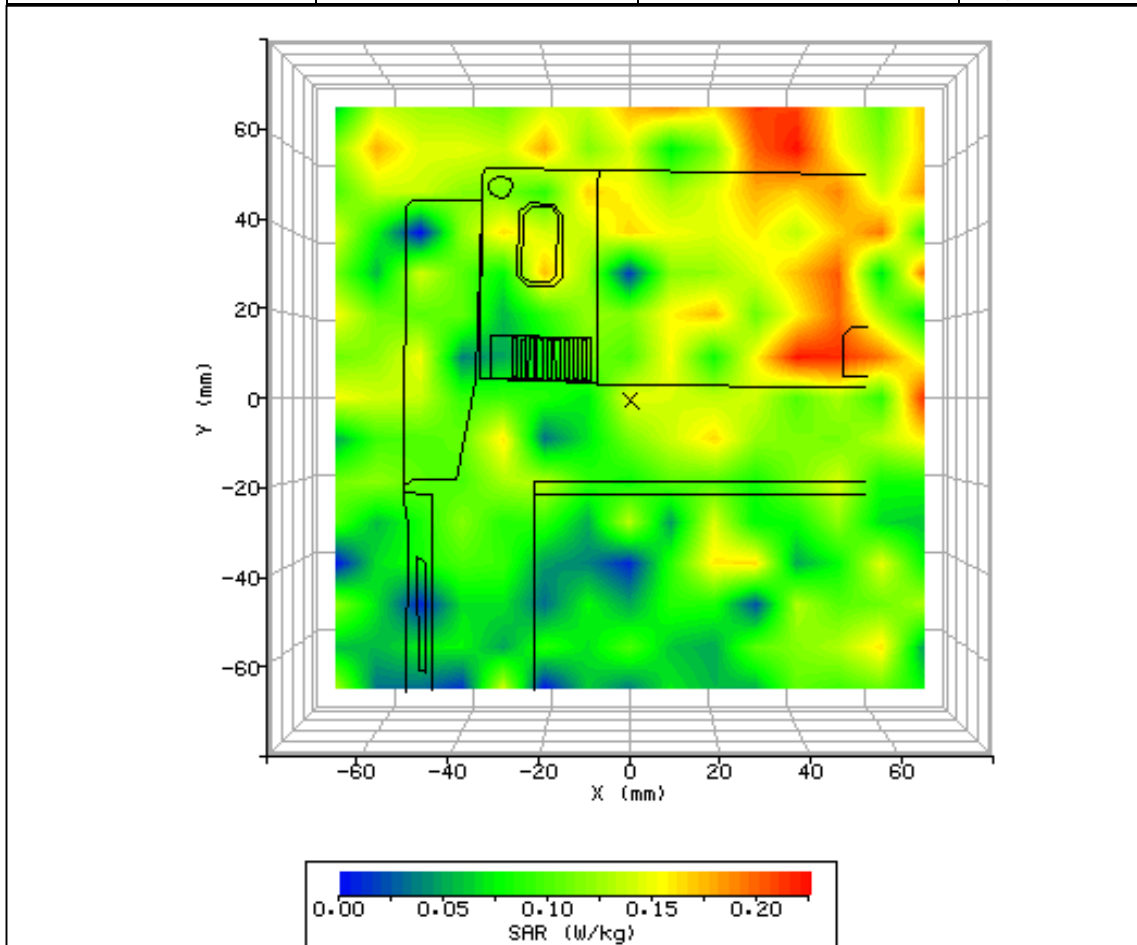

Figure 89: SAR Body Testing Results for the Intel WiFi Module in Screen 90° - Area 3 Phantom Position; Tested at 5785MHz (WLAN Mid Channel) with 2mm Separation Distance to the Phantom (NUA).

SYSTEM / SOFTWARE:	SARA2 / 2.53 VPM	INPUT POWER DRIFT:	0.0 dB
DATE / TIME:	21/08/2008 14:27:07	DUT BATTERY MODEL/NO:	N/A
FILENAME:	75903561-85a.txt	PROBE SERIAL NUMBER:	0171
AMBIENT TEMPERATURE:	22.80°C	LIQUID SIMULANT:	5800Body
DEVICE UNDER TEST:	Intel Module	RELATIVE PERMITTIVITY:	50.02
RELATIVE HUMIDITY:	53.00%	CONDUCTIVITY:	6.773
PHANTOM S/NO:	HeadBox1.csv	LIQUID TEMPERATURE:	22.40°C
PHANTOM ROTATION:	0°	MAX SAR X-AXIS LOCATION:	Off Edge
DUT POSITION:	Screen 90° - Area 4	MAX SAR Y-AXIS LOCATION:	Off Edge
ANTENNA CONFIGURATION:	B	MAX E FIELD:	5.14 V/m
TEST FREQUENCY:	5785MHz	SAR 1g:	N/A
AIR FACTORS:	368 / 390 / 442	SAR 10g:	N/A
CONVERSION FACTORS:	.276 / .276 / .276	SAR START:	N/A
TYPE OF MODULATION:	CW	SAR END:	N/A
MODN. DUTY CYCLE:	100.0 %	SAR DRIFT DURING SCAN:	0.00 %
DIODE COMPRESSION FACTORS (V*200):	20 / 20 / 20	PROBE BATTERY LAST CHANGED:	20/08/2008
INPUT POWER LEVEL:	13.9 dBm	EXTRAPOLATION:	poly4

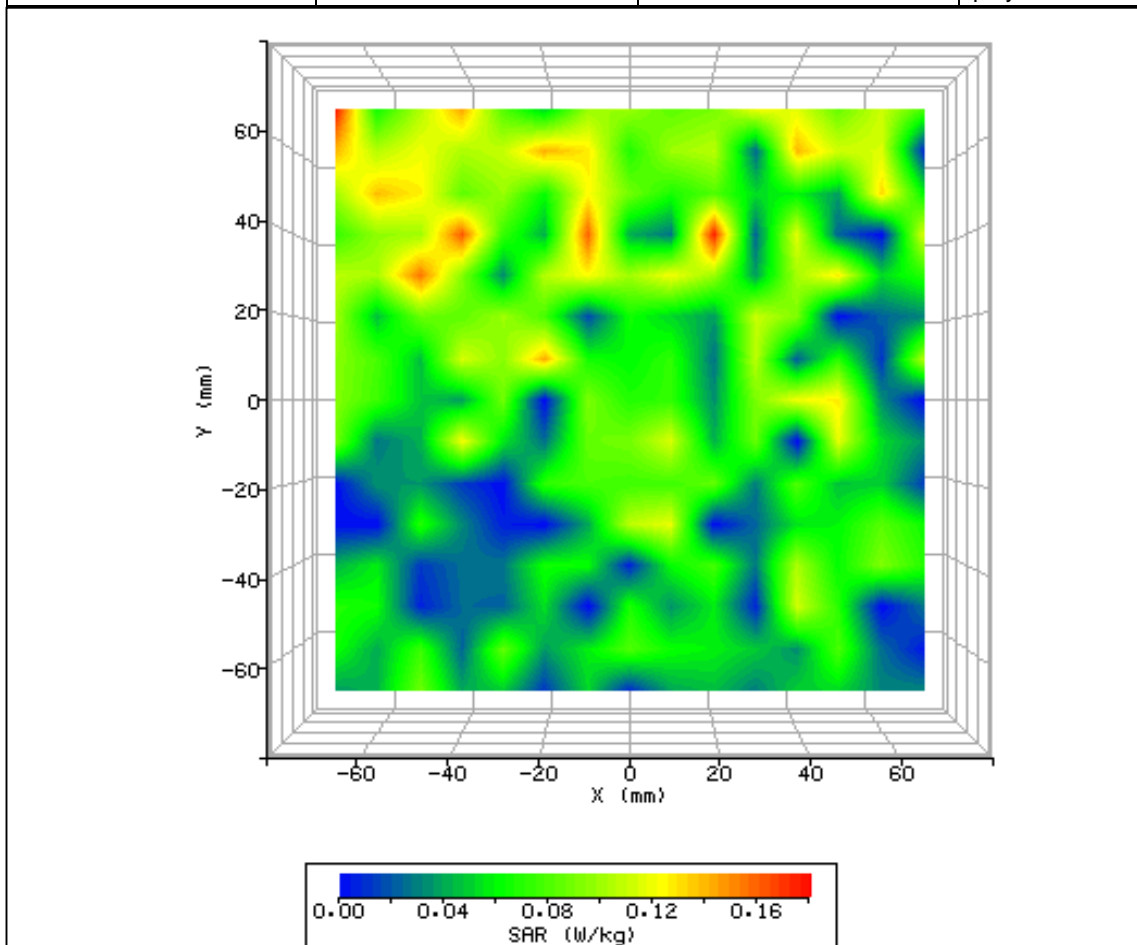

Figure 90: SAR Body Testing Results for the Intel WiFi Module in Screen 90° - Area 4 Phantom Position; Tested at 5785MHz (WLAN Mid Channel) with 2mm Separation Distance to the Phantom (NUA).



SYSTEM / SOFTWARE:	SARA2 / 2.53 VPM	INPUT POWER DRIFT:	0.0 dB
DATE / TIME:	21/08/2008 14:43:24	DUT BATTERY MODEL/NO:	N/A
FILENAME:	75903561-86a.txt	PROBE SERIAL NUMBER:	0171
AMBIENT TEMPERATURE:	22.50°C	LIQUID SIMULANT:	5800Body
DEVICE UNDER TEST:	Intel Module	RELATIVE PERMITTIVITY:	50.02
RELATIVE HUMIDITY:	52.10%	CONDUCTIVITY:	6.773
PHANTOM S/NO:	HeadBox1.csv	LIQUID TEMPERATURE:	22.40°C
PHANTOM ROTATION:	0°	MAX SAR X-AXIS LOCATION:	70.000mm
DUT POSITION:	Screen 90° - Area 5	MAX SAR Y-AXIS LOCATION:	666.000mm
ANTENNA CONFIGURATION:	B	MAX E FIELD:	4.94 V/m
TEST FREQUENCY:	5785MHz	SAR 1g:	N/A
AIR FACTORS:	368 / 390 / 442	SAR 10g:	N/A
CONVERSION FACTORS:	.276 / .276 / .276	SAR START:	N/A
TYPE OF MODULATION:	CW	SAR END:	N/A
MODN. DUTY CYCLE:	100.0 %	SAR DRIFT DURING SCAN:	0.00 %
DIODE COMPRESSION FACTORS (V*200):	20 / 20 / 20	PROBE BATTERY LAST CHANGED:	20/08/2008
INPUT POWER LEVEL:	13.9 dBm	EXTRAPOLATION:	poly4

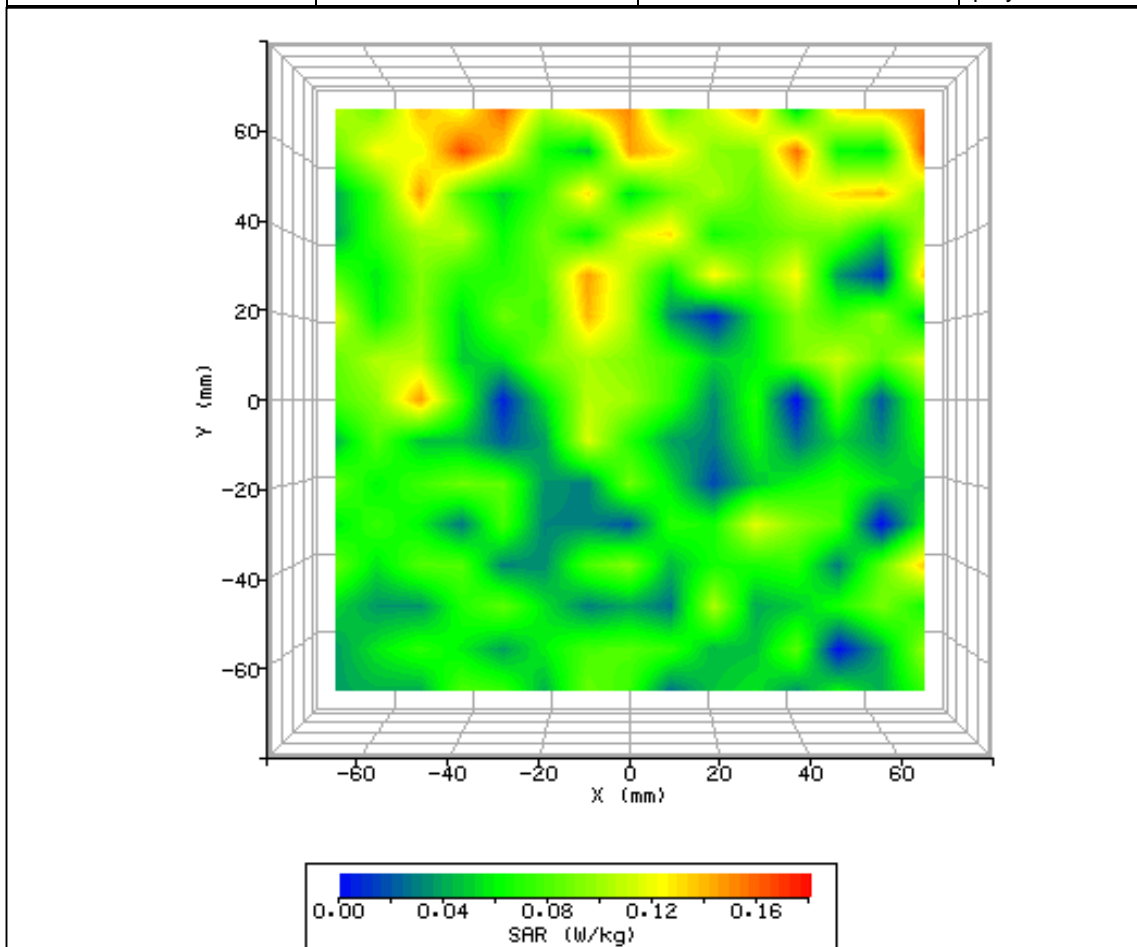

Figure 91: SAR Body Testing Results for the Intel WiFi Module in Screen 90° - Area 5 Phantom Position; Tested at 5785MHz (WLAN Mid Channel) with 2mm Separation Distance to the Phantom (NUA).

SYSTEM / SOFTWARE:	SARA2 / 2.53 VPM	INPUT POWER DRIFT:	0.0 dB
DATE / TIME:	21/08/2008 14:52:18	DUT BATTERY MODEL/NO:	N/A
FILENAME:	75903561-87a.txt	PROBE SERIAL NUMBER:	0171
AMBIENT TEMPERATURE:	22.20°C	LIQUID SIMULANT:	5800Body
DEVICE UNDER TEST:	Intel Module	RELATIVE PERMITTIVITY:	50.02
RELATIVE HUMIDITY:	50.90%	CONDUCTIVITY:	6.773
PHANTOM S/NO:	HeadBox1.csv	LIQUID TEMPERATURE:	22.40°C
PHANTOM ROTATION:	0°	MAX SAR X-AXIS LOCATION:	Off Edge
DUT POSITION:	Screen 90° - Area 6	MAX SAR Y-AXIS LOCATION:	Off Edge
ANTENNA CONFIGURATION:	B	MAX E FIELD:	5.49 V/m
TEST FREQUENCY:	5785MHz	SAR 1g:	N/A
AIR FACTORS:	368 / 390 / 442	SAR 10g:	N/A
CONVERSION FACTORS:	.276 / .276 / .276	SAR START:	N/A
TYPE OF MODULATION:	CW	SAR END:	N/A
MODN. DUTY CYCLE:	100.0 %	SAR DRIFT DURING SCAN:	0.00 %
DIODE COMPRESSION FACTORS (V*200):	20 / 20 / 20	PROBE BATTERY LAST CHANGED:	20/08/2008
INPUT POWER LEVEL:	13.9 dBm	EXTRAPOLATION:	poly4

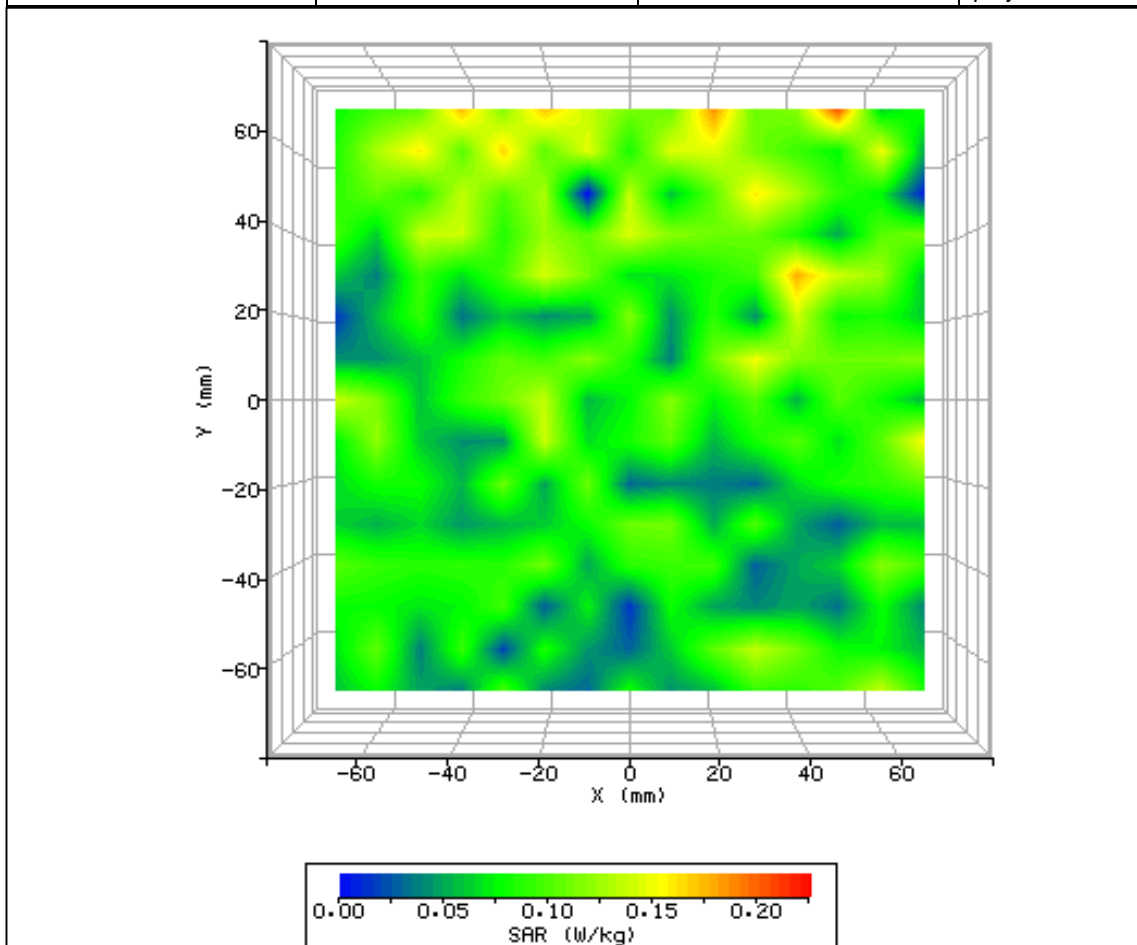

Figure 92: SAR Body Testing Results for the Intel WiFi Module in Screen 90° - Area 6 Phantom Position; Tested at 5785MHz (WLAN Mid Channel) with 2mm Separation Distance to the Phantom (NUA).

SYSTEM / SOFTWARE:	SARA2 / 2.53 VPM	INPUT POWER DRIFT:	0.0 dB
DATE / TIME:	21/08/2008 16:27:40	DUT BATTERY MODEL/NO:	N/A
FILENAME:	75903561-88a.txt	PROBE SERIAL NUMBER:	0171
AMBIENT TEMPERATURE:	22.30°C	LIQUID SIMULANT:	5800Body
DEVICE UNDER TEST:	Intel Module	RELATIVE PERMITTIVITY:	50.02
RELATIVE HUMIDITY:	50.70%	CONDUCTIVITY:	6.773
PHANTOM S/NO:	HeadBox1.csv	LIQUID TEMPERATURE:	22.40°C
PHANTOM ROTATION:	0°	MAX SAR X-AXIS LOCATION:	-16.00mm
DUT POSITION:	Screen 90° - Area 1	MAX SAR Y-AXIS LOCATION:	60.00mm
ANTENNA CONFIGURATION:	C	MAX E FIELD:	6.92 V/m
TEST FREQUENCY:	5785MHz	SAR 1g:	0.284 W/kg
AIR FACTORS:	368 / 390 / 442	SAR 10g:	0.212 W/kg
CONVERSION FACTORS:	.276 / .276 / .276	SAR START:	0.127 W/kg
TYPE OF MODULATION:	CW	SAR END:	0.127 W/kg
MODN. DUTY CYCLE:	100.0 %	SAR DRIFT DURING SCAN:	0.00 %
DIODE COMPRESSION FACTORS (V*200):	20 / 20 / 20	PROBE BATTERY LAST CHANGED:	20/08/2008
INPUT POWER LEVEL:	13.9 dBm	EXTRAPOLATION:	poly4

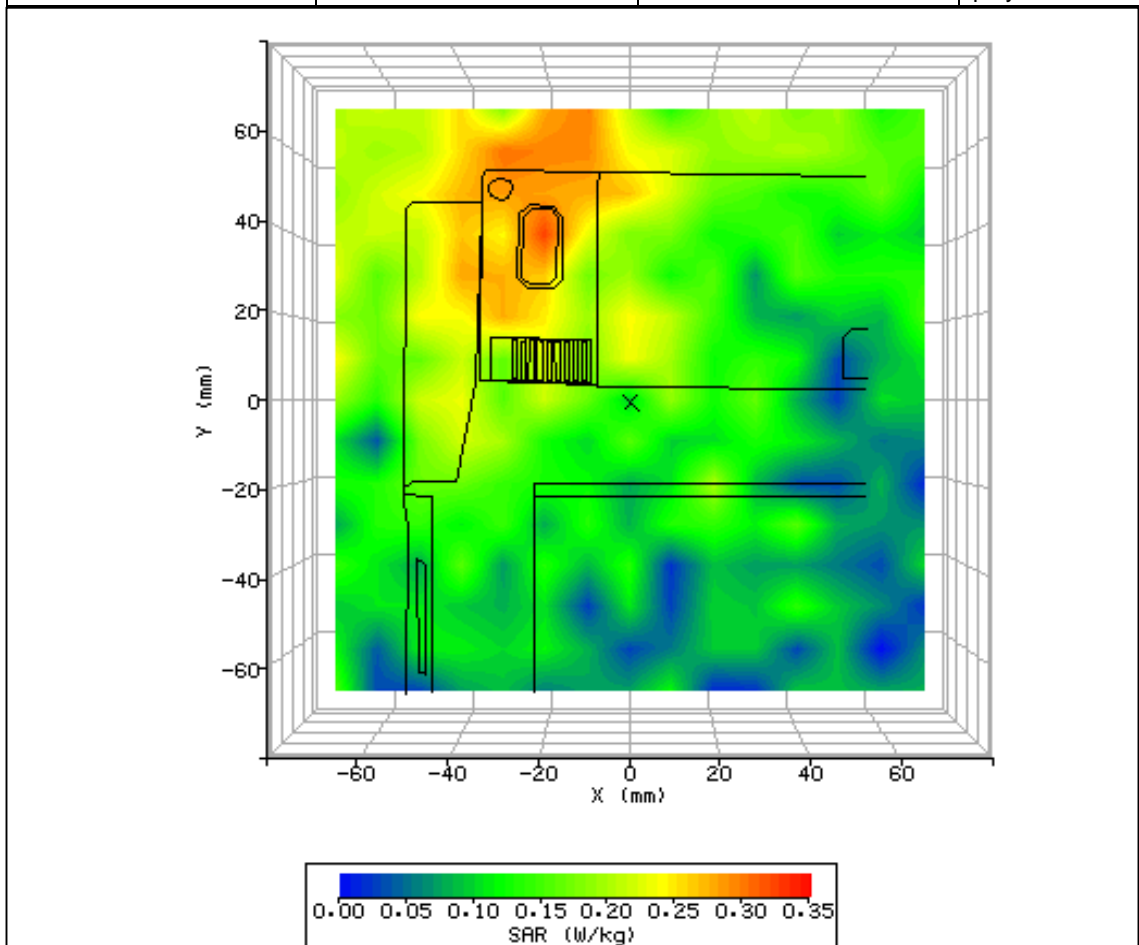

Figure 93: SAR Body Testing Results for the Intel WiFi Module in Screen 90° - Area 1 Phantom Position; Tested at 5785MHz (WLAN Mid Channel) with 2mm Separation Distance to the Phantom (NUA).

SYSTEM / SOFTWARE:	SARA2 / 2.53 VPM	INPUT POWER DRIFT:	0.0 dB
DATE / TIME:	21/08/2008 16:51:28	DUT BATTERY MODEL/NO:	N/A
FILENAME:	75903561-89a.txt	PROBE SERIAL NUMBER:	0171
AMBIENT TEMPERATURE:	22.40°C	LIQUID SIMULANT:	5800Body
DEVICE UNDER TEST:	Intel Module	RELATIVE PERMITTIVITY:	50.02
RELATIVE HUMIDITY:	52.90%	CONDUCTIVITY:	6.773
PHANTOM S/NO:	HeadBox1.csv	LIQUID TEMPERATURE:	22.30°C
PHANTOM ROTATION:	0°	MAX SAR X-AXIS LOCATION:	Off Edge
DUT POSITION:	Screen 90° - Area 2	MAX SAR Y-AXIS LOCATION:	Off Edge
ANTENNA CONFIGURATION:	C	MAX E FIELD:	5.60 V/m
TEST FREQUENCY:	5785MHz	SAR 1g:	N/A
AIR FACTORS:	368 / 390 / 442	SAR 10g:	N/A
CONVERSION FACTORS:	.276 / .276 / .276	SAR START:	N/A
TYPE OF MODULATION:	CW	SAR END:	N/A
MODN. DUTY CYCLE:	100.0 %	SAR DRIFT DURING SCAN:	0.00 %
DIODE COMPRESSION FACTORS (V*200):	20 / 20 / 20	PROBE BATTERY LAST CHANGED:	20/08/2008
INPUT POWER LEVEL:	13.9 dBm	EXTRAPOLATION:	poly4

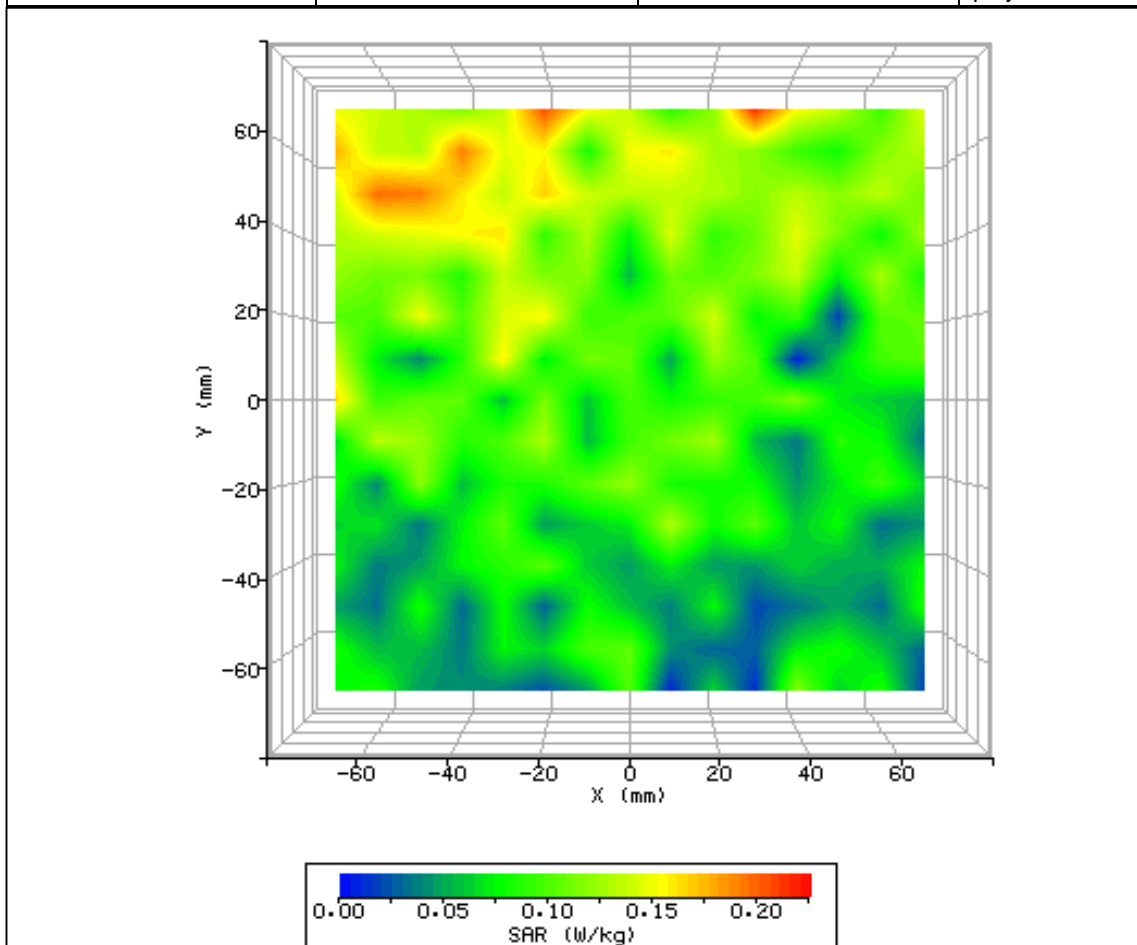

Figure 94: SAR Body Testing Results for the Intel WiFi Module in Screen 90° - Area 2 Phantom Position; Tested at 5785MHz (WLAN Mid Channel) with 2mm Separation Distance to the Phantom (NUA).



SYSTEM / SOFTWARE:	SARA2 / 2.53 VPM	INPUT POWER DRIFT:	0.0 dB
DATE / TIME:	21/08/2008 17:02:26	DUT BATTERY MODEL/NO:	N/A
FILENAME:	75903561-90a.txt	PROBE SERIAL NUMBER:	0171
AMBIENT TEMPERATURE:	22.20°C	LIQUID SIMULANT:	5800Body
DEVICE UNDER TEST:	Intel Module	RELATIVE PERMITTIVITY:	50.02
RELATIVE HUMIDITY:	53.40%	CONDUCTIVITY:	6.773
PHANTOM S/NO:	HeadBox1.csv	LIQUID TEMPERATURE:	22.30°C
PHANTOM ROTATION:	0°	MAX SAR X-AXIS LOCATION:	Off Edge
DUT POSITION:	Screen 90° - Area 3	MAX SAR Y-AXIS LOCATION:	Off Edge
ANTENNA CONFIGURATION:	C	MAX E FIELD:	5.32 V/m
TEST FREQUENCY:	5785MHz	SAR 1g:	N/A
AIR FACTORS:	368 / 390 / 442	SAR 10g:	N/A
CONVERSION FACTORS:	.276 / .276 / .276	SAR START:	N/A
TYPE OF MODULATION:	CW	SAR END:	N/A
MODN. DUTY CYCLE:	100.0 %	SAR DRIFT DURING SCAN:	0.00 %
DIODE COMPRESSION FACTORS (V*200):	20 / 20 / 20	PROBE BATTERY LAST CHANGED:	20/08/2008
INPUT POWER LEVEL:	13.9 dBm	EXTRAPOLATION:	poly4

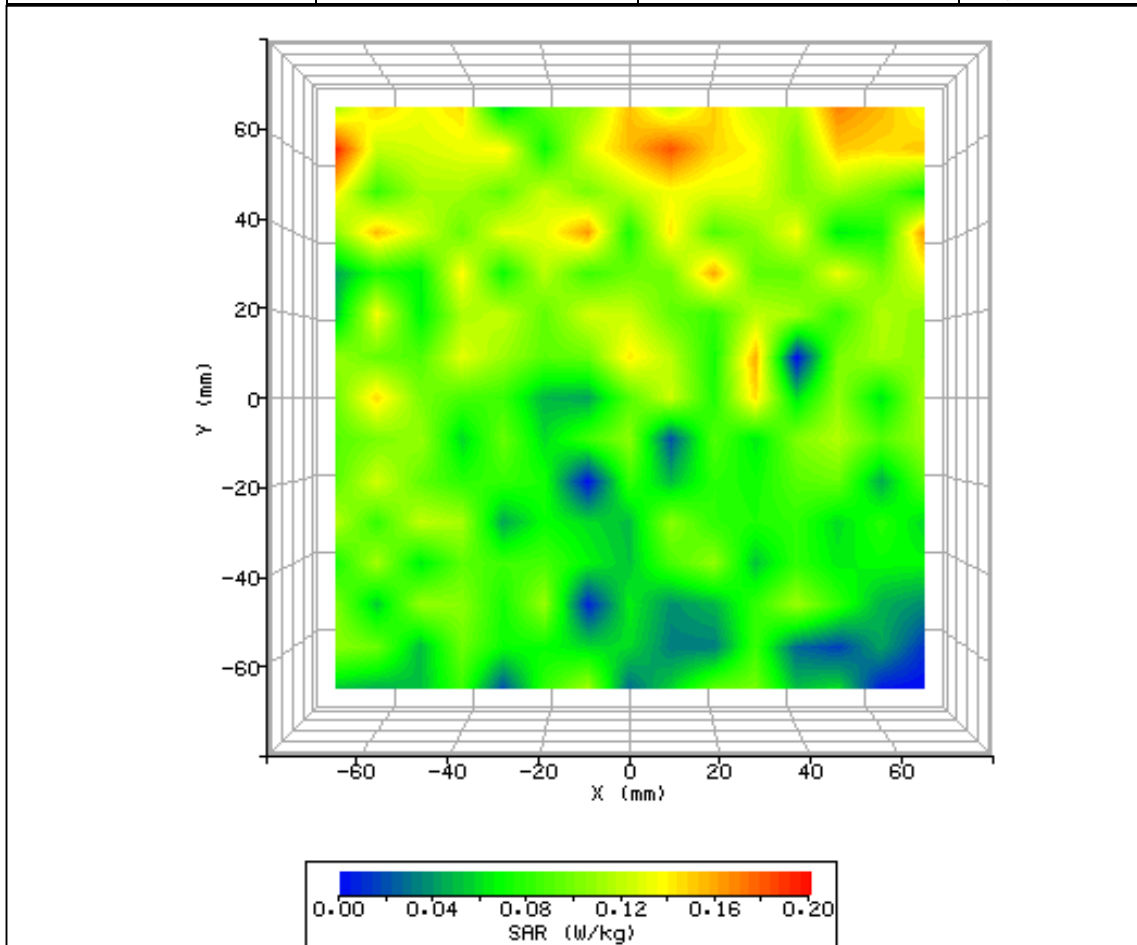

Figure 95: SAR Body Testing Results for the Intel WiFi Module in Screen 90° - Area 3 Phantom Position; Tested at 5785MHz (WLAN Mid Channel) with 2mm Separation Distance to the Phantom (NUA).



SYSTEM / SOFTWARE:	SARA2 / 2.53 VPM	INPUT POWER DRIFT:	0.0 dB
DATE / TIME:	21/08/2008 17:14:55	DUT BATTERY MODEL/NO:	N/A
FILENAME:	75903561-91a.txt	PROBE SERIAL NUMBER:	0171
AMBIENT TEMPERATURE:	22.10°C	LIQUID SIMULANT:	5800Body
DEVICE UNDER TEST:	Intel Module	RELATIVE PERMITTIVITY:	50.02
RELATIVE HUMIDITY:	54.00%	CONDUCTIVITY:	6.773
PHANTOM S/NO:	HeadBox1.csv	LIQUID TEMPERATURE:	22.30°C
PHANTOM ROTATION:	0°	MAX SAR X-AXIS LOCATION:	Off Edge
DUT POSITION:	Screen 90° - Area 4	MAX SAR Y-AXIS LOCATION:	Off Edge
ANTENNA CONFIGURATION:	C	MAX E FIELD:	5.73 V/m
TEST FREQUENCY:	5785MHz	SAR 1g:	N/A
AIR FACTORS:	368 / 390 / 442	SAR 10g:	N/A
CONVERSION FACTORS:	.276 / .276 / .276	SAR START:	N/A
TYPE OF MODULATION:	CW	SAR END:	N/A
MODN. DUTY CYCLE:	100.0 %	SAR DRIFT DURING SCAN:	0.00 %
DIODE COMPRESSION FACTORS (V*200):	20 / 20 / 20	PROBE BATTERY LAST CHANGED:	20/08/2008
INPUT POWER LEVEL:	13.9 dBm	EXTRAPOLATION:	poly4

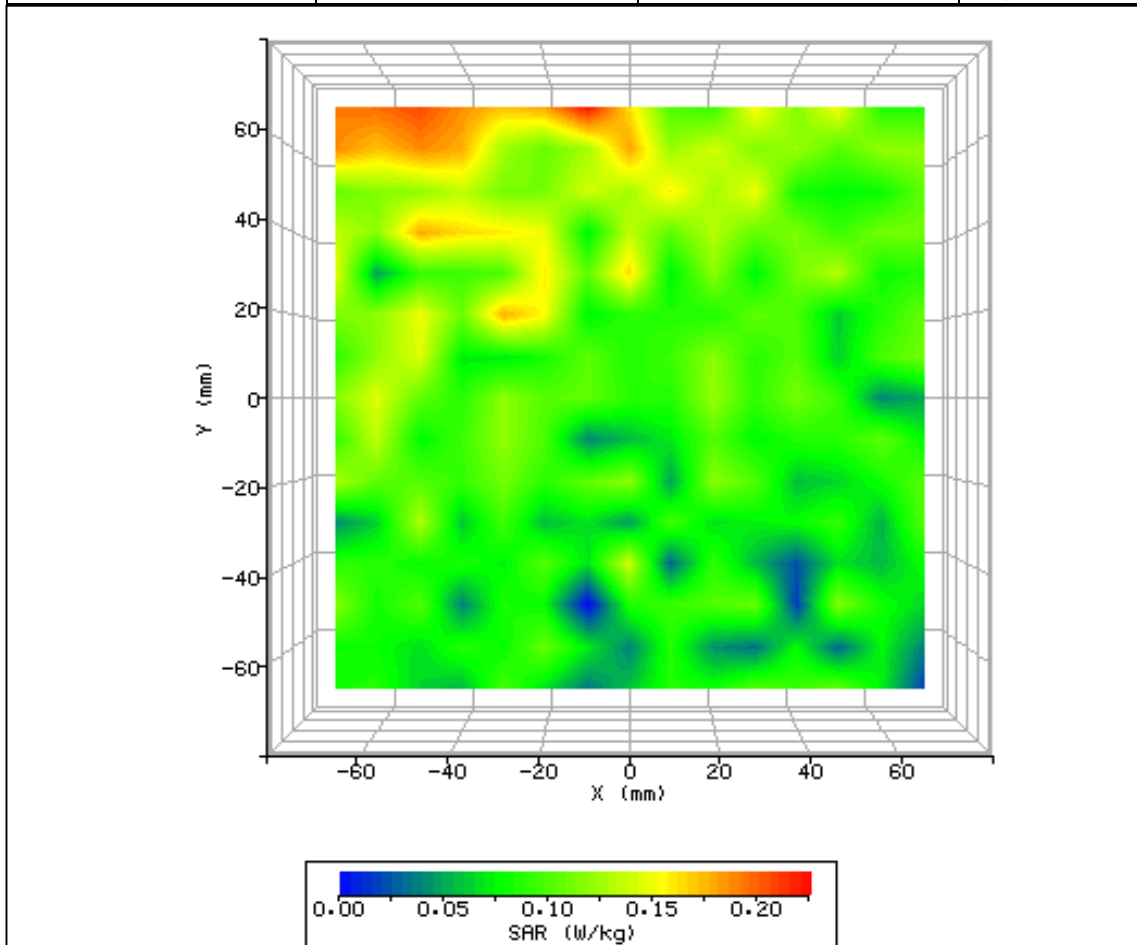

Figure 96: SAR Body Testing Results for the Intel WiFi Module in Screen 90° - Area 4 Phantom Position; Tested at 5785MHz (WLAN Mid Channel) with 2mm Separation Distance to the Phantom (NUA).

SYSTEM / SOFTWARE:	SARA2 / 2.53 VPM	INPUT POWER DRIFT:	0.0 dB
DATE / TIME:	21/08/2008 17:26:39	DUT BATTERY MODEL/NO:	N/A
FILENAME:	75903561-92a.txt	PROBE SERIAL NUMBER:	0171
AMBIENT TEMPERATURE:	22.00°C	LIQUID SIMULANT:	5800Body
DEVICE UNDER TEST:	Intel Module	RELATIVE PERMITTIVITY:	50.02
RELATIVE HUMIDITY:	54.50%	CONDUCTIVITY:	6.773
PHANTOM S/NO:	HeadBox1.csv	LIQUID TEMPERATURE:	22.30°C
PHANTOM ROTATION:	0°	MAX SAR X-AXIS LOCATION:	Off Edge
DUT POSITION:	Screen 90° - Area 5	MAX SAR Y-AXIS LOCATION:	Off Edge
ANTENNA CONFIGURATION:	C	MAX E FIELD:	5.39 V/m
TEST FREQUENCY:	5785MHz	SAR 1g:	N/A
AIR FACTORS:	368 / 390 / 442	SAR 10g:	N/A
CONVERSION FACTORS:	.276 / .276 / .276	SAR START:	N/A
TYPE OF MODULATION:	CW	SAR END:	N/A
MODN. DUTY CYCLE:	100.0 %	SAR DRIFT DURING SCAN:	0.00 %
DIODE COMPRESSION FACTORS (V*200):	20 / 20 / 20	PROBE BATTERY LAST CHANGED:	20/08/2008
INPUT POWER LEVEL:	13.9 dBm	EXTRAPOLATION:	poly4

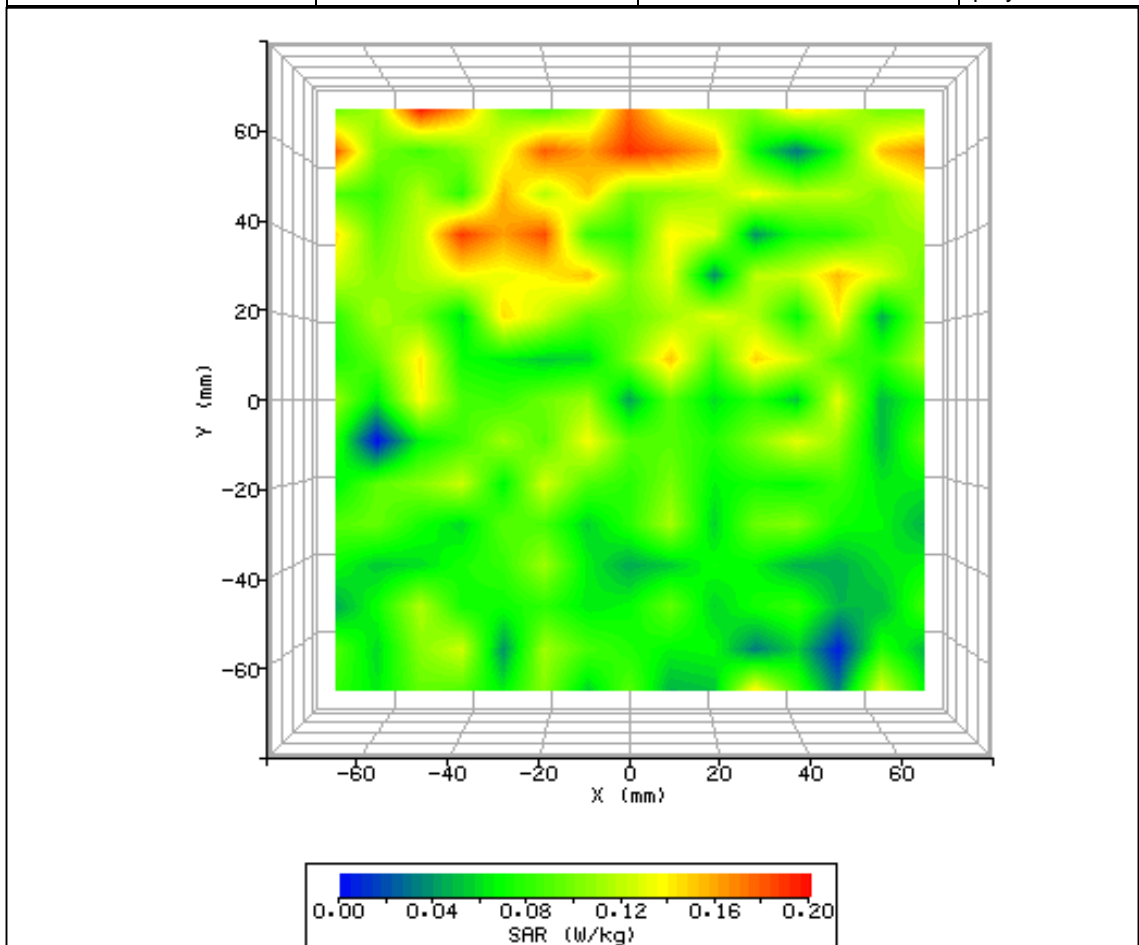

Figure 97: SAR Body Testing Results for the Intel WiFi Module in Screen 90° - Area 5 Phantom Position; Tested at 5785MHz (WLAN Mid Channel) with 2mm Separation Distance to the Phantom (NUA).

SYSTEM / SOFTWARE:	SARA2 / 2.53 VPM	INPUT POWER DRIFT:	0.0 dB
DATE / TIME:	21/08/2008 17:35:14	DUT BATTERY MODEL/NO:	N/A
FILENAME:	75903561-93a.txt	PROBE SERIAL NUMBER:	0171
AMBIENT TEMPERATURE:	22.20°C	LIQUID SIMULANT:	5800Body
DEVICE UNDER TEST:	Intel Module	RELATIVE PERMITTIVITY:	50.02
RELATIVE HUMIDITY:	55.60%	CONDUCTIVITY:	6.773
PHANTOM S/NO:	HeadBox1.csv	LIQUID TEMPERATURE:	22.30°C
PHANTOM ROTATION:	0°	MAX SAR X-AXIS LOCATION:	Off Edge
DUT POSITION:	Screen 90° - Area 6	MAX SAR Y-AXIS LOCATION:	Off Edge
ANTENNA CONFIGURATION:	C	MAX E FIELD:	5.66 V/m
TEST FREQUENCY:	5785MHz	SAR 1g:	N/A
AIR FACTORS:	368 / 390 / 442	SAR 10g:	N/A
CONVERSION FACTORS:	.276 / .276 / .276	SAR START:	N/A
TYPE OF MODULATION:	CW	SAR END:	N/A
MODN. DUTY CYCLE:	100.0 %	SAR DRIFT DURING SCAN:	0.00 %
DIODE COMPRESSION FACTORS (V*200):	20 / 20 / 20	PROBE BATTERY LAST CHANGED:	20/08/2008
INPUT POWER LEVEL:	13.9 dBm	EXTRAPOLATION:	poly4

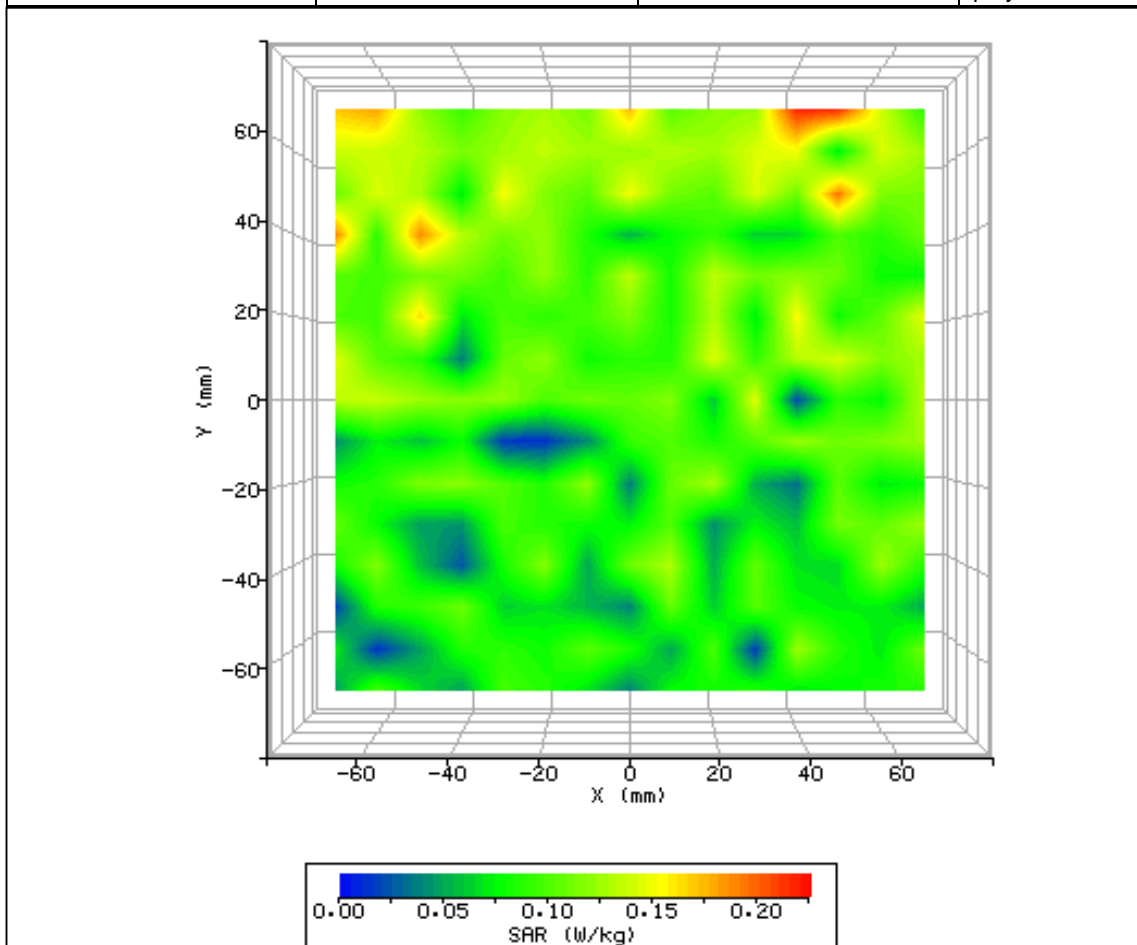

Figure 98: SAR Body Testing Results for the Intel WiFi Module in Screen 90° - Area 6 Phantom Position; Tested at 5785MHz (WLAN Mid Channel) with 2mm Separation Distance to the Phantom (NUA).



Product Service

### **SECTION 3**

#### **TEST EQUIPMENT USED**



### 3.1 TEST EQUIPMENT USED

The following test equipment was used at TUV Product Service Ltd:

Instrument Description	Manufacturer	Model Type	TE Number	Calibration Due
10MHz - 2.5GHz, 3W, Amplifier	Vectawave Technology	VTL5400	51	30-Nov-2008
Signal Generator	Marconi	2031	53	23-Feb-2009
2.5 GHz – 8 GHz Amplifier	Thorn	PTC6343	2068	TU
Signal Generator	Rohde & Schwarz	SMR 20	3475	27-Nov-2008
Spectrum Analyser	Rohde & Schwarz	FSB	55	TU
Industrial Robot	Mitsubishi	RV-E2/CR-E116	63	TU
Thermometer	Digitron	T208	64	10-Oct-2008
Thermocouple (Type K)	TUV	TYPE K	65	10-Oct-2008
Communications Tester	Rohde & Schwarz	CMU 200	442	09-Jul-2009
Attenuator (20dB, 10W)	Weinschel	37-20-34	482	1-Mar-2009
Flat Phantom	IndexSar Ltd	Headbox 02	1564	TU
Side Bench 1 Chamber 1	IndexSar Ltd	IXM-030	1570	TU
Bi-directional Coupler	IndexSar Ltd	7401 (VDC0830-20)	2414	2-Feb-2009
SAR Probe	IndexSar Ltd	IXP-050	3319	24-Sep-2008
SAR Probe	IndexSar Ltd	IXP-025	G0001	09-Jun-2009
Hygromer	Rotronic	Hygromer A1	0465	23-Oct-2008
Power Sensor	Rohde & Schwarz	NRV- Z5	2878	2-Jun-2009
Power Sensor	Rohde & Schwarz	NRV-Z1	2879	21-May-2009
Dual Channel Power Meter	Rohde & Schwarz	NRVD	3259	15-Nov-2008
900MHz Head Tissue Simulant	TUV Product Service Ltd	Batch 12	N/A	01-Sept-2008
1800MHz Head Tissue Simulant	TUV Product Service Ltd	Batch 9	N/A	01-Sept-2008
1900MHz Head Tissue Simulant	TUV Product Service Ltd	Batch 3	N/A	01-Sept-2008
2450MHz Head Tissue Simulant	TUV Product Service Ltd	Batch 7	N/A	01-Sept-2008
5800MHz Head Tissue Simulant	TUV Product Service Ltd	Batch 1	N/A	01-Sept-2008
900MHz Body Tissue Simulant	TUV Product Service Ltd	Batch 10	N/A	01-Sept-2008
1800MHz Body Tissue Simulant	TUV Product Service Ltd	Batch 4	N/A	01-Sept-2008
1900MHz Body Tissue Simulant	TUV Product Service Ltd	Batch 2	N/A	01-Sept-2008
2450MHz Body Tissue Simulant	TUV Product Service Ltd	Batch 6	N/A	01-Sept-2008
5800MHz Body Tissue Simulant	TUV Product Service Ltd	Batch 1	N/A	01-Sept-2008

TU – Traceability Unscheduled



Product Service

### 3.2 TEST SOFTWARE

The following software was used to control the TÜV Product Service SARA2 System.

Instrument	Version Number	Date
SARA2 system	v.2.5.3 VPM	28/11/2006
Mitsubishi robot controller firmware revision	RV-E2 Version C9a	-
IFA-10 Probe amplifier	Version 2	-



### 3.3 DIELECTRIC PROPERTIES OF SIMULANT LIQUIDS

The fluid properties of the simulant fluids used during routine SAR evaluation meet the dielectric properties required by EN 62209-1:2006 & OET Bulletin 65 (Edition 97-01).

The fluids were calibrated in our Laboratory and re-checked prior to any measurements being made against reference fluids stated in IEEE 1528-2003 of 0.9% NaCl (Salt Solution) at 23°C and also for Dimethylsulphoxide (DMS) at 21°C.

The fluids were made at TÜV Product Service Ltd under controlled conditions from the following OET(65)c formulae and IEEE 1528-2003. The composition of ingredients may have been modified accordingly to achieve the desired target tissue parameters required for routine SAR evaluation:

#### OET 65(c) Recipes

Ingredients (% by weight)	Frequency (MHz)									
	450		835		915		1900		2450	
Tissue Type	Head	Body	Head	Body	Head	Body	Head	Body	Head	Body
Water	38.56	51.16	41.45	52.4	41.05	56.0	54.9	40.4	62.7	73.2
Salt (NaCl)	3.95	1.49	1.45	1.4	1.35	0.76	0.18	0.5	0.5	0.04
Sugar	56.32	46.78	56.0	45.0	56.5	41.76	0.0	58.0	0.0	0.0
HEC	0.98	0.52	1.0	1.0	1.0	1.21	0.0	1.0	0.0	0.0
Bactericide	0.19	0.05	0.1	0.1	0.1	0.27	0.0	0.1	0.0	0.0
Triton X-100	0.0	0.0	0.0	0.0	0.0	0.0	0.0	0.0	36.8	0.0
DGBE	0.0	0.0	0.0	0.0	0.0	0.0	44.92	0.0	0.0	26.7
Dielectric Constant	43.42	58.0	42.54	56.1	42.0	56.8	39.9	54.0	39.8	52.5
Conductivity (S/m)	0.85	0.83	0.91	0.95	1.0	1.07	1.42	1.45	1.88	1.78

#### IEEE 1528 Recipes

Frequency (MHz)	300	450	835	900	1450	1800	1900	1950	2000	2100	2450	3000									
Recipe#	1	1	3	1	1	2	3	1	1	2	2	3	2								
Ingredients (% by weight)																					
1, 2-Propanediol				64.81																	
Bactericide	0.19	0.19	0.50	0.10	0.50							0.50									
Diacetin			48.90		49.20								49.45								
DGBE					45.41	47.00	13.84	44.92		44.94	13.84	45.00	50.00	50.00	7.99	7.99		7.99			
HEC	0.98	0.96		1.00	1.00																
NaCl	5.95	3.95	1.70	1.45	1.48	0.79	1.10	0.67	0.36	0.35	0.18	0.64	0.18	0.35			0.16	0.16	0.16		
Sucrose	55.32	56.32		57.00	56.50																
Triton X-100																					
Water	37.56	38.56	48.90	40.45	40.92	34.40	49.20	53.80	52.64	55.36	54.90	49.43	54.90	55.36	55.00	50.00	50.00	71.88	71.88	49.75	71.88
Measured dielectric parameters																					
$\epsilon_r$	46.00	43.40	44.30	41.60	41.20	41.80	42.70	40.9	39.3	41.00	40.40	39.20	39.90	41.00	40.10	37.00	36.80	41.10	40.30	39.20	37.90
$\sigma$ (S/m)	0.86	0.85	0.90	0.90	0.98	0.97	0.99	1.21	1.39	1.38	1.40	1.40	1.42	1.38	1.41	1.40	1.51	1.55	1.88	1.82	2.46
Temp (°C)	22	22	20	22	22	22	20	22	22	21	22	20	21	21	20	22	22	20	20	20	20
Target dielectric parameters (Table 2)																					
$\epsilon_r$	45.30	43.50	41.5	41.50	40.50	40.00						39.80	39.20	38.50							
$\sigma$ (S/m)	0.87	0.87	0.9	0.97	1.20	1.40						1.49	1.80	2.40							

NOTE – Multiple columns for any single frequency are optional recipe #, reference: 1 (Kanda et al. [B185]), 2 (Vigneras [B143]), 3 (Peyman and Gabriel [B119]), 4 (Fukunaga et al [B50])





Product Service

The dielectric properties of the tissue simulant liquids used for the SAR testing at TÜV Product Service Ltd are as follows:-

Fluid Type and Frequency	Relative Permittivity $\epsilon_R$ ( $\epsilon'$ ) Target	Relative Permittivity $\epsilon_R$ ( $\epsilon'$ ) Measured	Conductivity $\sigma$ Target	Conductivity $\sigma$ Measured
Body 850 MHz	55.00	58.20	1.050	0.998
Body 900 MHz	55.00	57.63	1.050	1.062
Body 1800 MHz	53.30	54.07	1.520	1.576
Body 1900 MHz	53.30	52.83	1.520	4.562
Body 2450 MHz	52.70	52.97	1.950	1.990
Body 5800 MHz	48.20	50.02	6.000	6.773

### 3.4 TEST CONDITIONS

#### 3.4.1 Test Laboratory Conditions

Ambient Temperature: Within +15°C to +25°C.

The actual Temperature during the testing ranged from 21.4°C to 24.5°C.

The actual Humidity during the testing ranged from 41.1% to 58.6% RH.

#### 3.4.2 Test Fluid Temperature Range

Frequency	850 MHz	900 MHz	1800 MHz	1900 MHz	2450 MHz
Body / Head Fluid	BODY	BODY	BODY	BODY	BODY
Min Temperature	22.7	22.5	21.5	22.2	20.5
Max Temperature	23.0	22.5	21.5	24.2	20.8

#### 3.4.3 SAR Drift

The SAR Drift was within acceptable limits during scans. The maximum SAR Drift, drift due to the handset electronics, was recorded as -4.420% (-0.20dB) for all of the testing. This figure has been included in the measurement uncertainty calculation.



### 3.5 MEASUREMENT UNCERTAINTY

Source of Uncertainty	Description	Tolerance / Uncertainty ± %	Probability distribution	Div	$C_i$ (10g)	Standard Uncertainty ± % (10g)	$V_i$ or $V_{eff}$
<i>Measurement System</i>							
Probe calibration	7.2.1	8.73	N	1	1	8.73	∞
Isotropy	7.2.1.2	3.18	R	1.73	1	1.84	∞
Probe angle >30deg	additional	12.00	R	1.73	1	6.93	∞
Boundary effect	7.2.1.5	0.49	R	1.73	1	0.28	∞
Linearity	7.2.1.3	1.00	R	1.73	1	0.58	∞
Detection limits	7.2.1.4	0.00	R	1.73	1	0.00	∞
Readout electronics	7.2.1.6	0.30	N	1	1	0.30	∞
Response time	7.2.1.7	0.00	R	1.73	1	0.00	∞
Integration time (equiv.)	7.2.1.8	1.38	R	1.73	1	0.80	∞
RF ambient conditions	7.2.3.6	3.00	R	1.73	1	1.73	∞
Probe positioner mech. restrictions	7.2.2.1	5.35	R	1.73	1	3.09	∞
Probe positioning with respect to phantom shell	7.2.2.3	5.00	R	1.73	1	2.89	∞
Post-processing	7.2.4	7.00	R	1.73	1	4.04	∞
<i>Test sample related</i>							
Test sample positioning	7.2.2.4	1.50	R	1.73	1	0.87	∞
Device holder uncertainty	7.2.2.4.2	1.73	R	1.73	1	1.00	∞
Drift of output power	7.2.3.4	5.00	R	1.73	1	4.420	∞
<i>Phantom and set-up</i>							
Phantom uncertainty (shape and thickness tolerances)	7.2.2.2	2.01	R	1.73	1	1.16	∞
Liquid conductivity (target)	7.2.3.3	5.00	R	1.73	0.43	1.85	∞
Liquid conductivity (meas.)	7.2.3.3	5.00	N	1	0.43	2.15	∞
Liquid permittivity (target)	7.2.3.4	5.00	R	1.73	0.49	1.41	∞
Liquid permittivity (meas.)	7.2.3.4	3.00	N	1	0.49	1.47	∞
Combined standard uncertainty			RSS			11.95	
Expanded uncertainty (95% confidence interval)			K=2			23.90	



Product Service

## **SECTION 4**

### **PHOTOGRAPHS**

#### 4.1 TEST POSITIONAL PHOTOGRAPHS



Figure 99:  
Positional Photograph of the F3507g  
Ericsson Mobile Broadband  
Module Installed in DELL Latitude  
E4200 Laptop Computer in Area 1  
Position



Figure 100:  
Positional Photograph of the F3507g  
Ericsson Mobile Broadband  
Module Installed in DELL Latitude  
E4200 Laptop Computer in Area 2  
Position



Figure 101:  
Positional Photograph of the F3507g  
Ericsson Mobile Broadband  
Module Installed in DELL Latitude  
E4200 Laptop Computer in Area 3  
Position



Figure 102:  
Positional Photograph of the F3507g  
Ericsson Mobile Broadband  
Module Installed in DELL Latitude  
E4200 Laptop Computer in Area 4  
Position



Figure 103:  
Positional Photograph of the F3507g  
Ericsson Mobile Broadband  
Module Installed in DELL Latitude  
E4200 Laptop Computer in Area 5  
Position



Figure 104:  
Positional Photograph of the F3507g  
Ericsson Mobile Broadband  
Module Installed in DELL Latitude  
E4200 Laptop Computer in Area 6  
Position

## 4.2 PHOTOGRAPHS OF EQUIPMENT UNDER TEST (EUT)



Figure 105:  
Front View of Laptop.



Figure 106:  
Rear View of Laptop.



Figure 107:  
Open View of Laptop.



Figure 108:  
View of Modules in Laptop.



Figure 109:  
Front View of F3507g Module.



Figure 110:  
Rear View of F3507g Module.





Figure 111:  
Front View of WLAN Module



Figure 112:  
Front View of WLAN Module



Product Service

## **SECTION 5**

### **ACCREDITATION, DISCLAIMERS AND COPYRIGHT**



Product Service

## 5.1 ACCREDITATION, DISCLAIMERS AND COPYRIGHT

This report relates only to the actual item/items tested.

This report must not be reproduced, except in its entirety, without the written permission of  
TÜV Product Service Limited

© 2008 TÜV Product Service Limited

## **ANNEX A**

### **PROBE CALIBRATION INFORMATION**



IMMERSIBLE SAR PROBE

CALIBRATION REPORT

Part Number: IXP – 050

S/N 0171

September 2007

---

Indexsar Limited  
Oakfield House  
Cudworth Lane  
Newdigate  
Surrey RH5 5BG  
Tel: +44 (0) 1306 632 870  
Fax: +44 (0) 1306 631 834  
e-mail: [enquiries@indexsar.com](mailto:enquiries@indexsar.com)



**Indexsar Limited**  
Oakfield House  
Cudworth Lane  
Newdigate  
Surrey RH5 5BG  
**Tel: +44 (0) 1306 632 870**  
Fax: +44 (0) 1306 631 834  
e-mail: [enquiries@indexsar.com](mailto:enquiries@indexsar.com)

**Calibration Certificate 0709/0171  
Dosimetric E-field Probe**

Type: IXP-050

Manufacturer: IndexSAR, UK

Serial Number: 0171

Place of Calibration: IndexSAR, UK

**IndexSAR Limited hereby declares that the IXP-050 Probe named above has been calibrated for conformity to the IEEE 1528 and CENELEC EN 50361 standards on the date shown below.**

Date of Initial Calibration: 24<sup>th</sup> September 2007

**The probe named above will require a calibration check on the date shown below.**

Next Calibration Date: September 2008

**The calibration was carried out using the methods described in the calibration document.**

**Where applicable, the standards used in the calibration process are traceable to the UK's National Physical Laboratory.**

Calibrated By:

Approved By:

Please keep this certificate with the calibration document. When the probe is sent for a calibration check, please include the calibration document.

**INTRODUCTION**

This Report presents measured calibration data for a particular Indexsar SAR probe (S/N 0171) and describes the procedures used for characterisation and calibration.

Indexsar probes are characterised using procedures that, where applicable, follow the recommendations of CENELEC [1] and IEEE [2] standards. The procedures incorporate techniques for probe linearisation, isotropy assessment and determination of liquid factors (conversion factors). Calibrations are determined by comparing probe readings with analytical computations in canonical test geometries (waveguides) using normalised power inputs.

Each step of the calibration procedure and the equipment used is described in the sections below.

## CALIBRATION PROCEDURE

### 1. Objectives

The calibration process comprises four stages

- 1) Determination of the channel sensitivity factors which optimise the probe's overall rotational isotropy in 900MHz brain fluid
- 2) Determination of the channel sensitivity factors and angular offset of the X channel which together optimise the probe's spherical isotropy in 900MHz brain fluid
- 3) Numerical combination of the two sets of channel sensitivity factors to give both acceptable rotational isotropy and acceptable spherical isotropy values
- 4) At each frequency of interest, application of these channel sensitivity factors to model the exponential decay of SAR in a waveguide fluid cell, and hence derive the liquid conversion factors at that frequency

### 2. Probe output

The probe channel output signals are linearised in the manner set out in Refs [1] and [2]. The following equation is utilized for each channel:

$$U_{lin} = U_{o/p} + U_{o/p}^2 / DCP \quad (1)$$

where  $U_{lin}$  is the linearised signal,  $U_{o/p}$  is the raw output signal in voltage units and DCP is the diode compression potential in similar voltage units.

DCP is determined from fitting equation (1) to measurements of  $U_{lin}$  versus source feed power over the full dynamic range of the probe. The DCP is a characteristic of the Schottky diodes used as the sensors. For the IXP-050 probes with CW signals the DCP values are typically 0.10V (or 20 in the voltage units used by Indexsar software, which are V\*200).

In turn, measurements of E-field are determined using the following equation (where output voltages are also in units of V\*200):

$$E_{liq}^2 \text{ (V/m)} = U_{linx} * \text{Air Factor}_x * \text{Liq Factor}_x + U_{liny} * \text{Air Factor}_y * \text{Liq Factor}_y + U_{linz} * \text{Air Factor}_z * \text{Liq Factor}_z \quad (3)$$

Here, "Air Factor" represents each channel's sensitivity, while "Liq Factor" represents the enhancement in signal level when the probe is immersed in tissue-simulant liquids at each frequency of interest.

### 3. Selecting channel sensitivity factors to optimise isotropic response

After manufacture, the first stage of the calibration process is to balance the three channels' Air Factor values, thereby optimising the probe's overall axial response ("rotational isotropy").

To do this, a 900MHz waveguide containing head-fluid simulant is selected. Like all waveguides used during probe calibration, this particular waveguide contains two distinct sections: an air-filled launcher

section, and a liquid cell section, separated by a dielectric matching window designed to minimise reflections at the air-liquid interface.

The waveguide stands in an upright position and the liquid cell section is filled with 900MHz brain fluid to within 10 mm of the open end. The depth of liquid ensures there is negligible radiation from the waveguide open top and that the probe calibration is not influenced by reflections from nearby objects.

During the measurement, a  $TE_{01}$  mode is launched into the waveguide by means of an N-type-to-waveguide adapter. The probe is then lowered vertically into the liquid until the tip is exactly 10mm above the centre of the dielectric window. This particular separation ensures that the probe is operating in a part of the waveguide where boundary corrections are not necessary.

Care must also be taken that the probe tip is centred while rotating.

The exact power applied to the input of the waveguide during this stage of the probe calibration is immaterial since only relative values are of interest while the probe rotates. However, the power must be sufficiently above the noise floor and free from drift.

The dedicated Indexasar calibration software rotates the probe in 10 degree steps about its axis, and at each position, an Indexasar 'Fast' amplifier samples the probe channels 500 times per second for 0.4 s. The raw  $U_{o/p}$  data from each sample are packed into 10 bytes and transmitted back to the PC controller via an optical cable.  $U_{linx}$ ,  $U_{liny}$  and  $U_{linz}$  are derived from the raw  $U_{o/p}$  values and written to an Excel template.

Once data have been collected from a full probe rotation, the Air Factors are adjusted using a special Excel Solver routine to equalise the output from each channel and hence minimise the rotational isotropy. This automated approach to optimisation removes the effect of human bias.

Figure 5 represents the output from each diode sensor as a function of probe rotation angle.

#### 4. Measurement of Spherical Isotropy

The setup for measuring the probe's spherical isotropy is shown in Figure 2.

A box phantom containing 900MHz head fluid is irradiated by a vertically-polarised, tuned dipole, mounted to the side of the phantom on the robot's seventh axis. During calibration, the spherical response is generated by rotating the probe about its axis in 20 degree steps and changing the dipole polarisation in 10 degree steps.

By using the VPM technique discussed below, an allowance can also be made for the effect of E-field gradient across the probe's spatial extent. This permits values for the probe's effective tip radius and X-channel angular offset to be modelled until the overall spherical isotropy figure is optimised.

The dipole is connected to a signal generator and amplifier via a directional coupler and power meter. As with the determination of rotational isotropy, the absolute power level is not important as long as it is stable.

The probe is positioned within the fluid so that its sensors are at the same vertical height as the centre of the source dipole. The line joining probe to dipole should be perpendicular to the phantom wall, while the horizontal separation between the two should be small enough for VPM corrections to be applicable, without encroaching near the boundary layer of the phantom wall. VPM corrections require a knowledge of the fluid skin depth. This is measured during the calibration by recording the E-field strength while systematically moving the probe away from the dipole in 2mm steps over a 20mm range.

The directionality of the orthogonally-arranged sensors can be checked by analysing the data using dedicated Indexasar software, which displays the data in 3D format, a representative image of which is shown in Figure 3. The left-hand side of this diagram shows the individual channel outputs after linearisation (see above). The program uses these data to balance the channel outputs and then applies an optimisation process, which makes fine adjustments to the channel factors for optimum isotropic response.

#### 5. Determination of Conversion ("Liquid") Factors at each frequency of interest



A lookup table of conversion factors for a probe allows a SAR value to be derived at the measured frequencies, and for either brain or body fluid-simulant.

The method by which the conversion factors are assessed is based on the comparison between measured and analytical rates of decay of SAR with height above a dielectric window. This way, not only can the conversion factors for that frequency/fluid combination be determined, but an allowance can also be made for the scale and range of boundary layer effects.

The theoretical relationship between the SAR at the cross-sectional centre of the lossy waveguide as a function of the longitudinal distance ( $z$ ) from the dielectric separator is given by Equation 4:

$$SAR(z) = \frac{4(P_f - P_b)}{\rho ab \delta} e^{-2z/\delta} \quad (4)$$

Here, the density  $\rho$  is conventionally assumed to be 1000 kg/m<sup>3</sup>,  $ab$  is the cross-sectional area of the waveguide, and  $P_f$  and  $P_b$  are the forward and reflected power inside the lossless section of the waveguide, respectively. The penetration depth  $\delta$  (which is the reciprocal of the waveguide-mode attenuation coefficient) is a property of the lossy liquid and is given by Equation (5).

$$\delta = \left[ \text{Re} \left\{ \sqrt{(\pi/a)^2 + j\omega\mu_o(\sigma + j\omega\epsilon_o\epsilon_r)} \right\} \right]^{-1} \quad (5)$$

where  $\sigma$  is the conductivity of the tissue-simulant liquid in S/m,  $\epsilon_r$  is its relative permittivity, and  $\omega$  is the radial frequency (rad/s). Values for  $\sigma$  and  $\epsilon_r$  are obtained prior to each waveguide test using an Indexsar DiLine measurement kit, which uses the TEM method as recommended in [2].  $\sigma$  and  $\epsilon_r$  are both temperature- and fluid-dependent, so are best measured using a sample of the tissue-simulant fluid immediately prior to the actual calibration.

Wherever possible, all DiLine and calibration measurements should be made in the open laboratory at 22 ± 2.0°C; if this is not possible, the values of  $\sigma$  and  $\epsilon_r$  should reflect the actual temperature. Values employed for calibration are listed in the tables below.

By ensuring the liquid height in the waveguide is at least three penetration depths, reflections at the upper surface of the liquid are negligible. The power absorbed in the liquid is therefore determined solely from the waveguide forward and reflected power.

Different waveguides are used for 835/900MHz, 1800/1900MHz, 2450MHz and 5200/5800MHz measurements. Table A.1 of [1] can be used for designing calibration waveguides with a return loss greater than 20 dB at the most important frequencies used for personal wireless communications, and better than 15dB for frequencies greater than 5GHz. Values for the penetration depth for these specific fixtures and tissue-simulating mixtures are also listed in Table A.1.

According to [1], this calibration technique provides excellent accuracy, with standard uncertainty of less than 3.6% depending on the frequency and medium. The calibration itself is reduced to power measurements traceable to a standard calibration procedure. The practical limitation to the frequency band of 800 to 5800 MHz because of the waveguide size is not severe in the context of compliance testing.

During calibration, the probe is lowered carefully until it is just touching the cross-sectional centre of the dielectric window. 200 samples are then taken and written to an Excel template file before moving the probe vertically upwards. This cycle is repeated 150 times. The vertical separation between readings is determined from practical considerations of the expected SAR decay rate, and range from 0.2mm steps at low frequency, through 0.1mm at 2450MHz, down to 0.05mm at 5GHz.

Once the data collection is complete, a Solver routine is run which optimises the measured-theoretical fit by varying the conversion factor, and the boundary correction size and range.

For 450 MHz calibrations, a slightly different technique must be used — the equatorial response of the probe-under-test is compared with the equivalent response of a probe whose 450MHz characteristics have already been determined by NPL. The conversion factor of the probe-under-test can then be deduced.

#### VPM (Virtual Probe Miniaturisation)

SAR probes with 3 diode-sensors in an orthogonal arrangement are designed to display an isotropic response when exposed to a uniform field. However, the probes are ordinarily used for measurements in non-uniform fields and isotropy is not assured when the field gradients are significant compared to the dimensions of the tip containing the three orthogonally-arranged dipole sensors.

It becomes increasingly important to assess the effects of field gradients on SAR probe readings when higher frequencies are being used. For Indexsar IXP-050 probes, which are of 5mm tip diameter, field gradient effects are minor at GSM frequencies, but are major above 5GHz. Smaller probes are less affected by field gradients and so probes, which are significantly less than 5mm diameter, would be better for applications above 5GHz.

The IndexSAR report IXS0223 describes theoretical and experimental studies to evaluate the issues associated with the use of probes at arbitrary angles to surfaces and field directions. Based upon these studies, the procedures and uncertainty analyses referred to in P1528 are addressed for the full range of probe presentation angles.

In addition, generalized procedures for correcting for the finite size of immersible SAR probes are developed. Use of these procedures enables application of schemes for virtual probe miniaturization (VPM) – allowing probes of a specific size to be used where physically-smaller probes would otherwise be required.

Given the typical dimensions of 3-channel SAR probes presently available, use of the VPM technique extends the satisfactory measurement range to higher frequencies.

#### CALIBRATION FACTORS MEASURED FOR PROBE S/N 0171

*The probe was calibrated at 450, 835, 900, 1800, 1900, 2100 and 2450 MHz in liquid samples representing brain and body liquid at these frequencies.*

*The calibration was for CW signals only, and the axis of the probe was parallel to the direction of propagation of the incident field i.e. end-on to the incident radiation. The axial isotropy of the probe was measured by rotating the probe about its axis in 10 degree steps through 360 degrees in this orientation.*

The reference point for the calibration is in the centre of the probe's cross-section at a distance of 2.7 mm from the probe tip in the direction of the probe amplifier. A value of 2.7 mm should be used for the tip to sensor offset distance in the software. The distance of 2.7mm for assembled probes has been confirmed by taking X-ray images of the probe tips (see Figure 9).

It is important that the diode compression point and air factors used in the software are the same as those quoted in the results tables, as these are used to convert the diode output voltages to a SAR value.

#### MEASUREMENT UNCERTAINTIES

A complete measurement uncertainty analysis for the SARA2 measurement system has been published in Reference [3]. Table 10 from that document is re-created below, and lists the uncertainty factors associated just with the calibration of probes.

<b>Source of uncertainty</b>	<b>Uncertainty value <math>\pm</math> %</b>	<b>Probability distribution</b>	<b>Divisor</b>	<b><math>c_i</math></b>	<b>Standard uncertainty <math>u_i \pm</math> %</b>	<b><math>v_i</math> or <math>v_{eff}</math></b>
Incident or forward power	5.743	N	1.00	1	5.743	$\infty$

Source of uncertainty	Uncertainty value $\pm$ %	Probability distribution	Divisor	$c_i$	Standard uncertainty $u_i \pm$ %	$\nu_i$ or $\nu_{eff}$
Reflected power	5.773	N	1.00	1	5.773	$\infty$
Liquid conductivity	1.120	N	1.00	1	1.120	$\infty$
Liquid permittivity	1.085	N	1.00	1	1.085	$\infty$
Field homogeneity	0.002	R	1.73	1	0.001	$\infty$
Probe positioning: +/- 0.05mm	0.55	R	1.73	1	0.318	
Influence on Probe pos: 11%/mm						
Field probe linearity	4.7	R	1.73	1	2.714	$\infty$
<b>Combined standard uncertainty</b>		<b>RSS</b>			<b>8.729</b>	

At the 95% confidence level, therefore, the expanded uncertainty is 17.1%

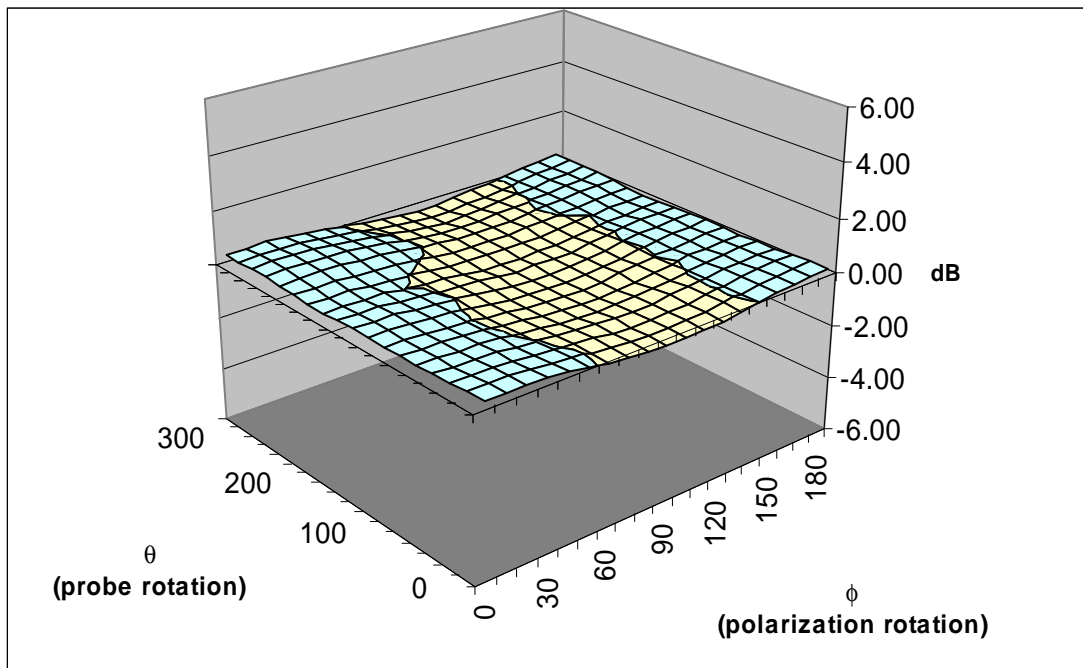

**Surface Isotropy diagram of IXP-050 Probe S/N 0171 at 900MHz after VPM** (rotational isotropy axial +/-0.07dB, spherical isotropy +/-0.33dB)

Probe tip radius 1.25  
 X Ch. Angle to red dot -1.7

Frequency	Head		Body	
	Bdy. Corr. – f(0)	Bdy. Corr. – d(mm)	Bdy. Corr. – f(0)	Bdy. Corr. – d(mm)
450	-	-	-	-
835	0.88	1.5	1.13	1.3
900	0.99	1.3	1.04	1.3
1800	0.83	1.5	0.83	1.6
1900	0.76	1.5	0.78	1.7
2100	0.83	1.5	0.66	2.0
2450	0.83	1.5	0.65	2.0

SUMMARY OF CALIBRATION FACTORS FOR PROBE IXP-050 S/N 0171

Spherical isotropy measured at 900MHz	0.33	(+/-) dB
---------------------------------------	------	----------

	X	Y	Z	
Air Factors	339	480	381	(V*200)
CW DCPs	20	20	20	(V*200)

Freq (MHz)	Axial Isotropy		SAR ConvF		Notes
	(+/- dB)		(liq/air)		
	Head	Body	Head	Body	
450	-	-	0.299	0.301	1,3
835	-	-	0.276	0.279	1,2
900	0.07	-	0.280	0.293	1,2
1800	-	-	0.342	0.382	1,2
1900	-	-	0.347	0.400	1,2
2100	-	-	0.366	0.422	1,2
2450	-	-	0.392	0.463	1,2

Notes	
1)	Calibrations done at 22°C +/-2°C
2)	Waveguide calibration
3)	Transfer calibration

## PROBE SPECIFICATIONS

Indexsar probe 0171, along with its calibration, is compared with CENELEC and IEEE standards recommendations (Refs [1] and [2]) in the Tables below. A listing of relevant specifications is contained in the tables below:

<b>1.1.1 Dimensions</b>	S/N 0171	CENELEC [1]	IEEE [2]
Overall length (mm)	350		
Tip length (mm)	10		
Body diameter (mm)	12		
Tip diameter (mm)	5.2	8	8
Distance from probe tip to dipole centers (mm)	2.7		

<b>1.1.2 Dynamic range</b>	S/N 0171	CENELEC [1]	IEEE [2]
Minimum (W/kg)	0.01	<0.02	0.01
Maximum (W/kg) N.B. only measured to > 100 W/kg on representative probes	>100	>100	100

<b>1.1.3 Isotropy (measured at 900MHz)</b>	S/N 0171	CENELEC [1]	IEEE [2]
Axial rotation with probe normal to source (+/- dB)	0.07 (See table above)	0.5	0.25
Spherical isotropy covering all orientations to source (+/- dB)	0.33	1.0	0.50

<b>1.1.4 Construction</b>	Each probe contains three orthogonal dipole sensors arranged on a triangular prism core, protected against static charges by built-in shielding, and covered at the tip by PEEK cylindrical enclosure material. No adhesives are used in the immersed section. Outer case materials are PEEK and heat-shrink sleeving.
<b>1.1.5 Chemical resistance</b>	Tested to be resistant to glycol and alcohol containing simulant liquids but probes should be removed, cleaned and dried when not in use.

## REFERENCES

- [1] CENELEC, EN 50361, July 2001. Basic Standard for the measurement of specific absorption rate related to human exposure to electromagnetic fields from mobile phones.
- [2] IEEE 1528, Recommended practice for determining the spatial-peak specific absorption rate (SAR) in the human body due to wireless communications devices: Experimental techniques.
- [3] Indexsar Report IXS-0300, October 2007. Measurement uncertainties for the SARA2 system assessed against the recommendations of BS EN 62209-1:2006

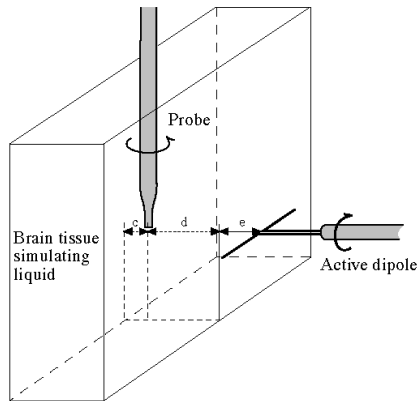

Figure 1. Spherical isotropy jig showing probe, dipole and box filled with simulated brain liquid (see Ref [2], Section A.5.2.1)

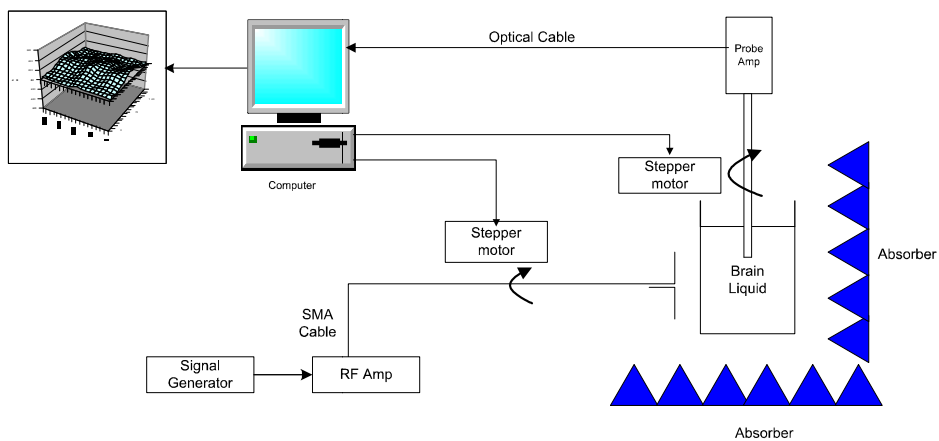

Figure 2. Schematic diagram of the test geometry used for isotropy determination



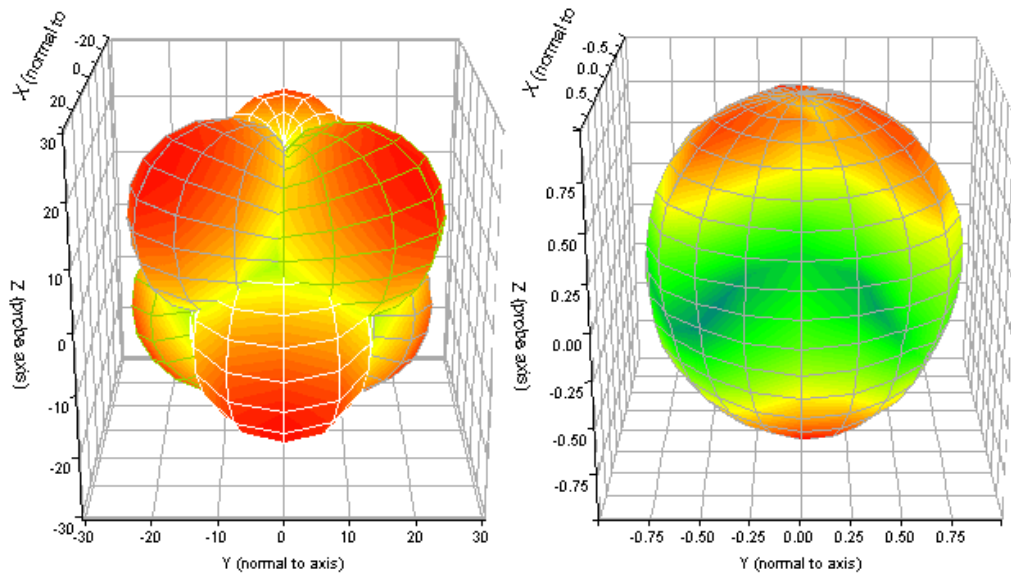

Figure 3. Graphical representation of a probe's response to fields applied from each direction. The diagram on the left shows the individual response characteristics of each of the three channels and the diagram on the right shows the resulting probe sensitivity in each direction. The colour range in the figure images the lowest values as blue and the maximum values as red. For probe S/N 0171, this range is (+/-) 0.33dB.

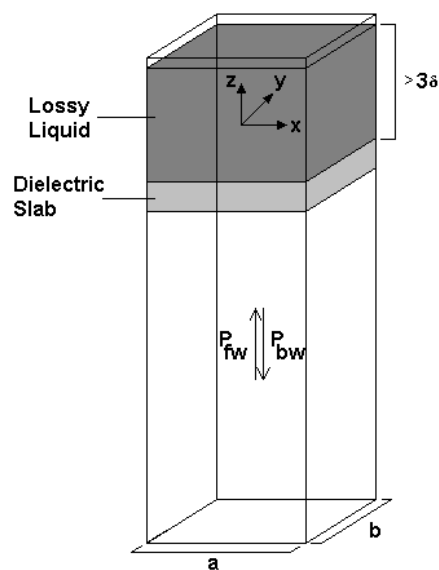

Figure 4. Geometry used for waveguide calibration (after Ref [2]. Section A.3.2.2)

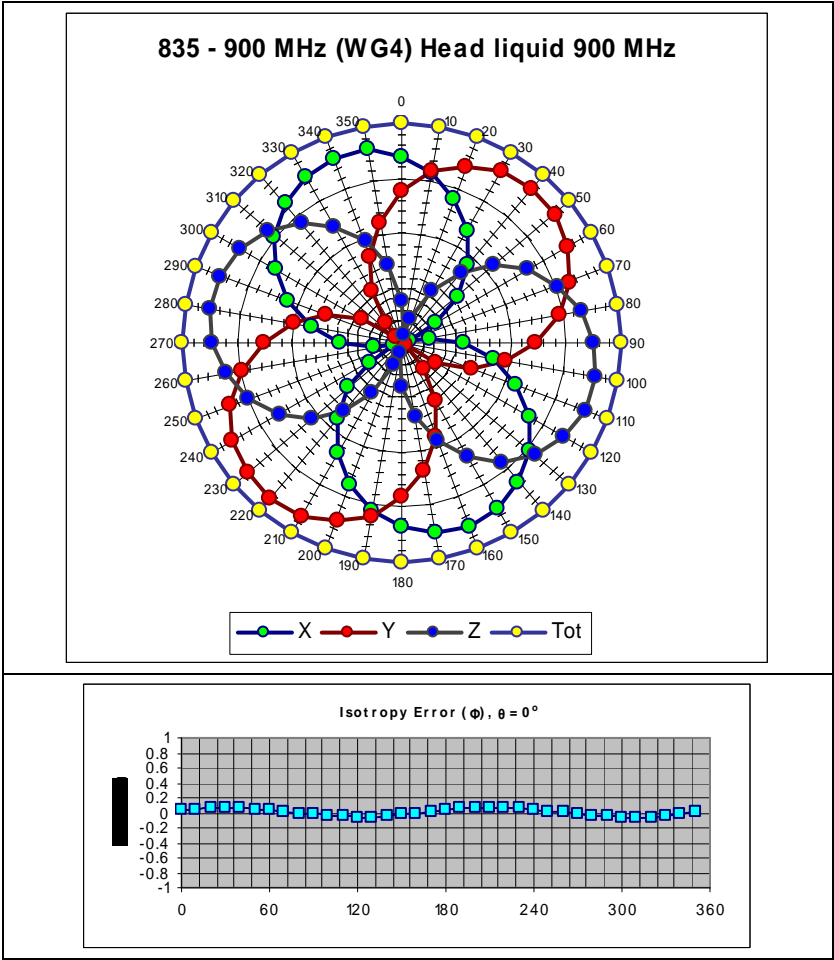

Figure 5. The rotational isotropy of probe S/N 0171 obtained by rotating the probe in a liquid-filled waveguide at 900 MHz.

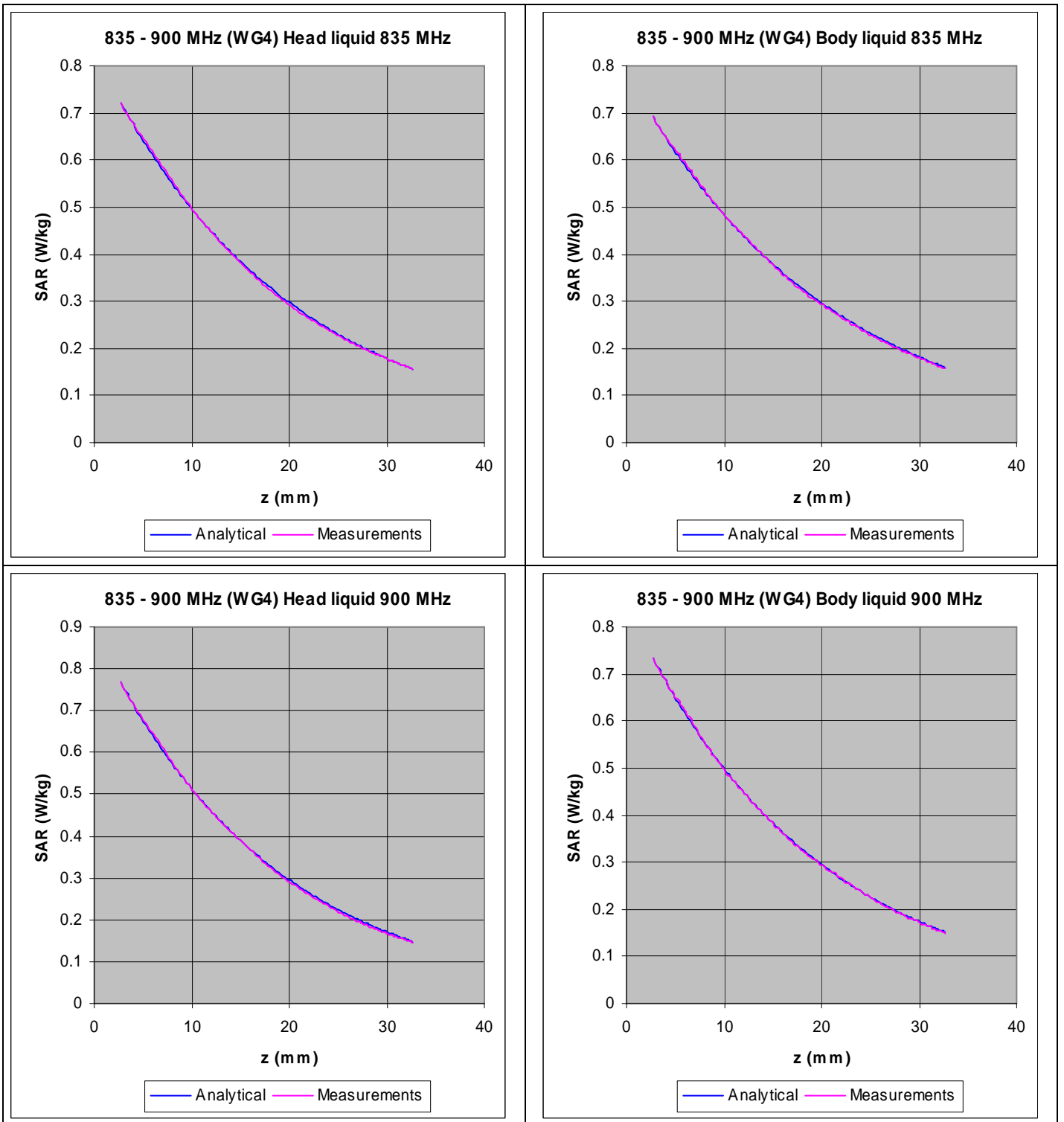
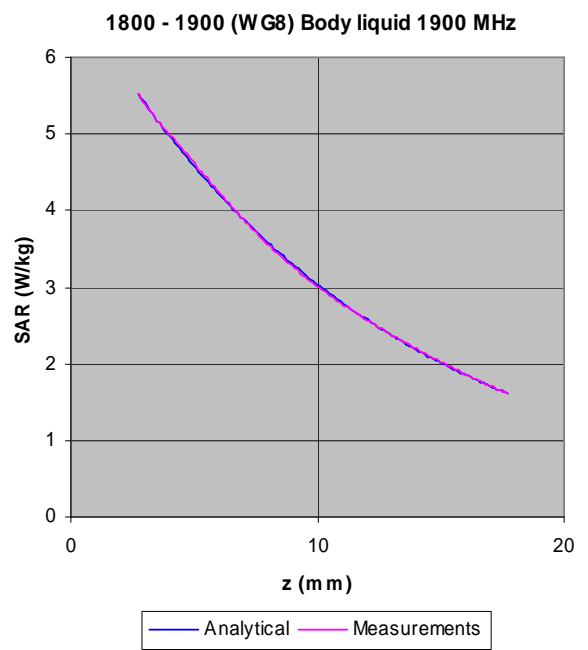
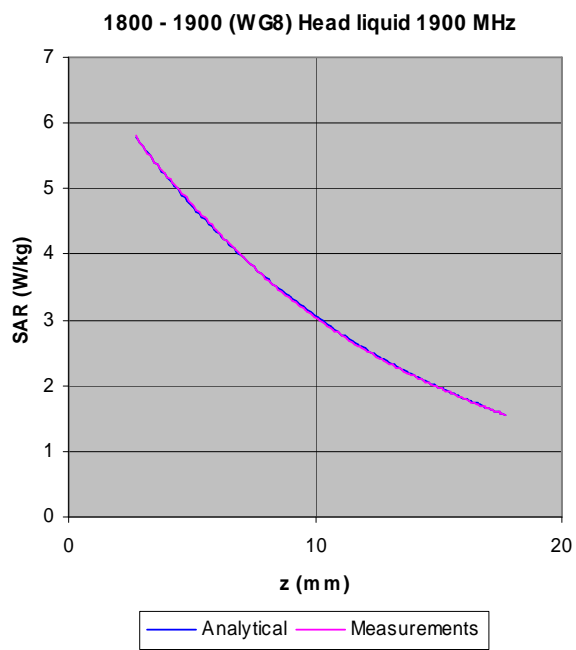
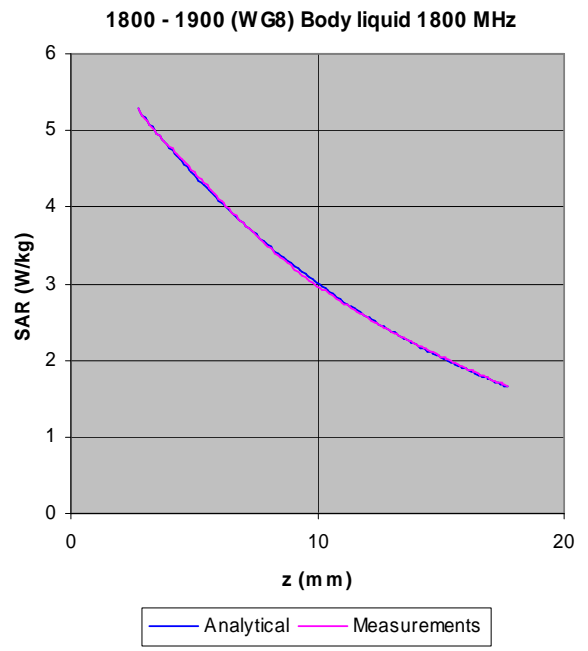
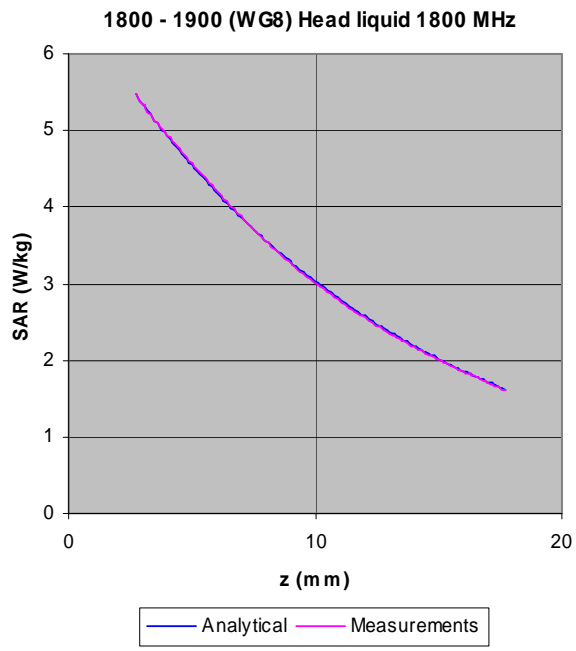

Figure 6. The measured SAR decay function along the centreline of the WG4 waveguide with conversion factors adjusted to fit to the theoretical function for the particular dimension, frequency, power and liquid properties employed.



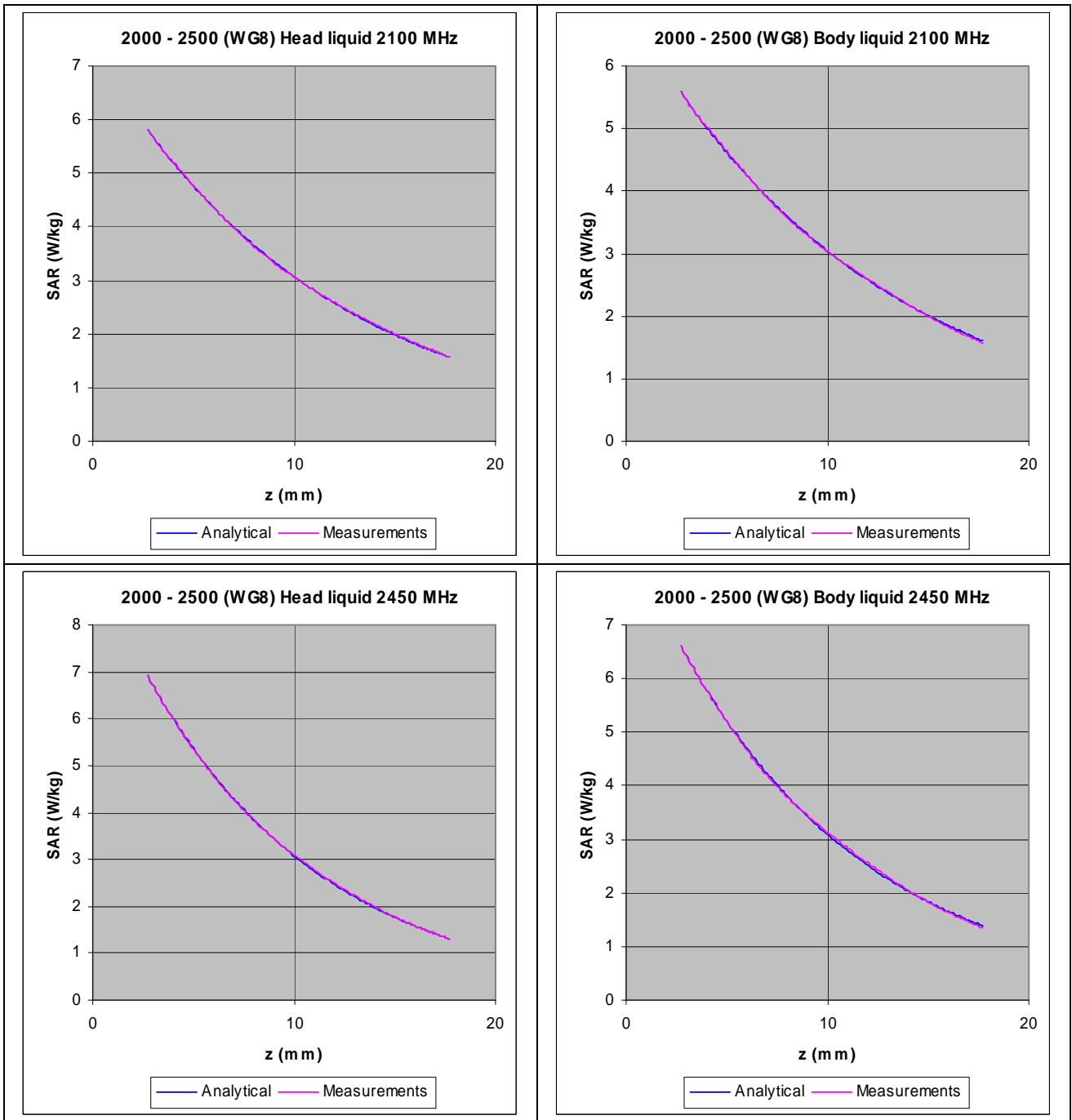

Figure 7. The measured SAR decay function along the centreline of the R22 waveguide with conversion factors adjusted to fit to the theoretical function for the particular dimension, frequency, power and liquid properties employed.

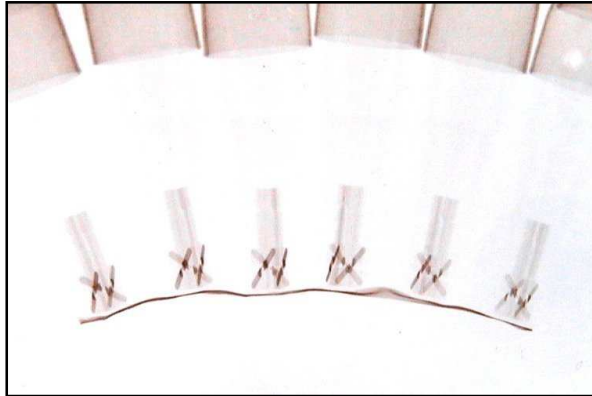

Figure 9: X-ray positive image of 5mm probes

**Table indicating the dielectric parameters of the liquids used for calibrations at each frequency**

<i>Liquid used</i>	<i>Relative permittivity (measured)</i>	<i>Conductivity (S/m) (measured)</i>
450 MHz BRAIN	44.56	0.84
450 MHz BODY	56.45	0.75
835 MHz BRAIN	42.06	0.91
835 MHz BODY	55.54	0.99
900 MHz BRAIN	41.28	0.97
900 MHz BODY	54.92	1.06
1800 MHz BRAIN	38.74	1.37
1800 MHz BODY	54.53	1.54
1900 MHz BRAIN	38.31	1.47
1900 MHz BODY	54.26	1.63
2100 MHz BRAIN	40.18	1.50
2100 MHz BODY	51.27	1.60
2450 MHz BRAIN	38.78	1.87
2450 MHz BODY	50.30	1.99



# NATIONAL PHYSICAL LABORATORY

Teddington Middlesex UK TW11 0LW Telephone +44 20 8977 3222

## Certificate of Calibration

SAR PROBE

IndexSAR

Model: IXP-025

Serial number: G0001

*This certificate provides traceability of measurement to recognised national standards, and to the units of measurement realised at the National Physical Laboratory or other recognised national standards laboratories. This certificate may not be reproduced other than in full, unless permission for the publication of an approved extract has been obtained in writing from the Managing Director. It does not of itself impute to the subject of calibration any attributes beyond those shown by the data contained therein.*

FOR: IndexSAR Ltd  
Oakfield House  
Cudworth Lane  
Newdigate  
Dorking  
Surrey  
RH5 5BG

Order number: 0577

DESCRIPTION: An IndexSAR isotropic electric field probe for determining specific absorption rates (SAR) in dielectric liquids. The probe has three orthogonal sensors, and the output voltage of the sensors is converted to an optical signal by a meter unit containing an analogue to digital (AD) converter. Probe readings are obtained using software via the RS232 port. The probe was calibrated with IndexSAR amplifier model IXA-010 S/N 036 belonging to NPL.

IDENTIFICATION: The probe is marked with the manufacturer's serial number G0001

MEASUREMENTS COMPLETED ON: 5 June 2008

PREVIOUS NPL CERTIFICATE: None

The reported uncertainty is based on a coverage factor  $k = 2$ , providing a level of confidence of approximately 95%

Reference : E08050261

Date of Issue : 9 June 2008

Checked by : *W Bennett*

Signed : *B Loader* (Authorised Signatory)

Name : B G Loader for Managing Director

Page 1 of 5

# NATIONAL PHYSICAL LABORATORY

Continuation Sheet

## MEASUREMENT PROCEDURE

The calibration method is based on establishing a calculable specific absorption rate (SAR) using a matched waveguide cell [1]. The cell has a feed-section and a liquid-filled section separated by a matching window that is designed to minimise reflections at the interface. A  $TE_{01}$  mode is launched into the waveguide by means of a N-type-to-waveguide adapter. The power delivered to the liquid is calculated from the forward power and reflection coefficient measured at the input to the cell. At the centre of the cross-section of the waveguide cell, the volume specific absorption rate ( $SAR^V$ ) in the liquid as a function of distance from the window is given by

$$SAR^V = \frac{4(P_w)}{ab\delta} e^{-2Z/\delta} \quad (1)$$

where

- $a$  = the larger cross-sectional dimension of the waveguide.
- $b$  = the smaller cross-sectional dimension of the waveguide.
- $\delta$  = the skin depth for the liquid in the waveguide.
- $Z$  = the distance of the probe's sensors from the liquid to matching window boundary.
- $P_w$  = the power delivered to the liquid.

Liquids having the properties specified by FCC guidelines [2] were used for the calibration. The value of  $\delta$  for the liquid was obtained by measuring the electric field ( $E$ ) at a number of distances from the matching window. The calibration was for continuous wave (CW) signals, and the axis of the probe was parallel to the direction of propagation of the incident field i.e. end-on to the incident radiation. The probe was rotated about its axis in 15-degree steps, and the ratio of the calibration factors for the three probe sensors X, Y, & Z were optimized to give the best axial isotropy.

The probe was calibrated with the linearisation and air-correction factors enabled. Comparing the measured values of  $E^2$  in the liquid to those calculated for the waveguide cell allows the ratio,  $ConvF$ , of sensitivity for  $(E^2_{LIQUID}) / (E^2_{AIR})$  to be determined, as required by the probe software.

## ENVIRONMENT

Measurements were made in a temperature-controlled laboratory at  $22 \pm 1^\circ\text{C}$ . The temperature of the liquid used was measured at the beginning and end of each measurement.

Reference : E08050261

Page 2 of 5

Date of Issue : 9 June 2008

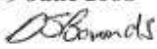
Checked by : 



# NATIONAL PHYSICAL LABORATORY

Continuation Sheet

## UNCERTAINTIES

The estimated uncertainty in calibration for SAR ( $W \text{ kg}^{-1}$ ) is  $\pm 10\%$ . The reported uncertainty is based on a standard uncertainty multiplied by a coverage factor  $k = 2$ , providing a level of confidence of approximately 95%.

This uncertainty is valid when the probe is used in a liquid with the same dielectric properties as those used for the calibration. No estimate is made for the long-term stability of the device calibrated or of the fluids used in the calibration.

When using the probe for SAR testing, additional uncertainties should be added to account for the spherical isotropy of the probe, proximity effects, linearity, and response to pulsed fields. There will be additional uncertainty if the probe is used in liquids having significantly different electrical properties to those used for the calibration. The electrical properties of the liquids will be related to temperature.

## RESULTS

Table 1 gives the results for the calibration in liquid and air at 5200 MHz

Table 2 gives the results for the calibration in liquid and air at 5800 MHz

**These calibration factors are only correct when the values for sensitivity in free-space, diode compression and sensor offset from the tip of the probe, as set in the probe software, are the same as those given in the Table.**

## REFERENCES:

[1] Pokovic, KT, T.Schmid and N.Kuster, "Robust set-up for Precise Calibration of E-field probes in Tissue Simulating Liquids at Mobile Phone Frequencies", Proceedings ICECOM 1997, pp 120 – 124, Dubrovnik, Croatia Oct 12-17, 1997.

[2] FCC-OET Bulletin 65 (97-01) "Evaluating Compliance with FCC Guidelines for Human Exposure to Radiofrequency Electromagnetic Fields", D. L. Means, K. W. Chan, June 2001.

Reference : E08050261

Page 3 of 5

Date of Issue : 9 June 2008

Checked by : *AS Samuel*

# NATIONAL PHYSICAL LABORATORY

Continuation Sheet

Table 1  
Sensitivity in Liquid and Air at 5200 MHz

SAR probe: IXP025 S/N: G0001							
Probe settings for calibration							
Sensitivity in free-space <sup>(4)</sup>		Diode Compression <sup>(1)</sup>		Sensor offset from tip of probe <sup>(1)</sup>			
Lin X = 988 (V/m) <sup>2</sup> /(V*200)		DCP <sub>X</sub> = 20 (V*200)		1.39 mm			
Lin Y = 1485 (V/m) <sup>2</sup> /(V*200)		DCP <sub>Y</sub> = 20 (V*200)					
Lin Z = 1102 (V/m) <sup>2</sup> /(V*200)		DCP <sub>Z</sub> = 20 (V*200)					
Sensitivity in Liquid.							
Calibration frequency	Liquid <sup>(2)</sup>			Calibration Factors for E <sup>2</sup> <sub>Liquid</sub> / E <sup>2</sup> <sub>Air</sub>			Axial Isotropy
(MHz)	Identifier	ε' <sup>(3)</sup>	σ <sup>(3)</sup> (Sm <sup>-1</sup> )	ConvF <sub>X</sub>	ConvF <sub>Y</sub>	ConvF <sub>Z</sub>	(dB)
5200	NPL5-6B-1	49.4	5.33	<b>0.65</b>	<b>1.02</b>	<b>1.27</b>	±0.07
5200	UOB5-6H-1	35.3	4.83	<b>0.56</b>	<b>0.88</b>	<b>1.08</b>	±0.10

Notes.

- <sup>(1)</sup> The manufacturer supplied these figures.
- <sup>(2)</sup> Head or Muscle Simulating Liquid supplied by NPL.
- <sup>(3)</sup> Measured at NPL at 22 ± 1 °C.
- <sup>(4)</sup> Measured at NPL in a Field Strength of 150 V/m.

Reference : E08050261

Page 4 of 5

Date of Issue : 9 June 2008

Checked by : *DS Bownds*

# NATIONAL PHYSICAL LABORATORY

Continuation Sheet

Table 2  
Sensitivity in Liquid and Air at 5800 MHz

SAR probe: IXP025 S/N: G0001							
Probe settings for calibration							
Sensitivity in free-space <sup>(4)</sup>		Diode Compression <sup>(1)</sup>		Sensor offset from tip of probe <sup>(1)</sup>			
Lin X = 1071 (V/m) <sup>2</sup> /(V*200)		DCP <sub>x</sub> = 20 (V*200)		1.39 mm			
Lin Y = 1566 (V/m) <sup>2</sup> /(V*200)		DCP <sub>y</sub> = 20 (V*200)					
Lin Z = 1164 (V/m) <sup>2</sup> /(V*200)		DCP <sub>z</sub> = 20 (V*200)					
Sensitivity in Liquid.							
Calibration frequency	Liquid <sup>(2)</sup>			Calibration Factors for $E^2_{\text{Liquid}} / E^2_{\text{Air}}$			Axial Isotropy
(MHz)	Identifier	$\epsilon'$ <sup>(3)</sup>	$\sigma$ <sup>(3)</sup> (Sm <sup>-1</sup> )	$ConvF_x$	$ConvF_y$	$ConvF_z$	(dB)
5800	NPL5-6B-1	50.5	6.22	<b>0.65</b>	<b>1.01</b>	<b>1.33</b>	$\pm 0.11$
5800	UOB5-6H-1	33.9	5.52	<b>0.54</b>	<b>0.86</b>	<b>1.08</b>	$\pm 0.11$

Notes.

- (1) The manufacturer supplied these figures.
- (2) Head or Muscle Simulating Liquid supplied by NPL.
- (3) Measured at NPL at 22 ± 1 °C.
- (4) Measured at NPL in a Field Strength of 150 V/m.

Reference : E08050261

Date of Issue : 9 June 2008

Checked by : *JBonnett*

Page 5 of 5