

# Technical Description and User Guide

## F3307

PRINTING ORIGINAL



© Ericsson AB, 2009. All Rights Reserved.

**Disclaimer**

The contents of this document are subject to change without prior notice due to continued progress in methodology, design, and manufacturing. Ericsson shall have no liability for any error or damages of any kind resulting from the use of this document.

**Abstract**

This document describes the Ericsson Mobile Broadband Module F3307. End-user value, functionality, characteristics and basic building blocks are described.

**Trademark and Acknowledgements**

Microsoft, Windows, Windows Vista, Internet Explorer, .NET and Outlook are registered trademarks or trademarks of Microsoft Corporation in the United States and/or other countries.

Ericsson is a trademark of Telefonaktiebolaget LM Ericsson.

All trademarks are the property of their respective owners. All other product or service names mentioned in this document are trademarks of their respective companies.

## Content

<b>1</b>	<b>About this Document .....</b>	<b>6</b>
1.1	Purpose .....	6
1.2	Audience.....	6
<b>2</b>	<b>Product Overview .....</b>	<b>7</b>
2.1	Product Features .....	7
<b>3</b>	<b>Communication .....</b>	<b>8</b>
3.1	Network Technologies .....	8
3.1.1	UMTS .....	8
3.1.2	GSM .....	9
3.2	Core Features.....	10
3.2.1	Browsing and internet access.....	10
3.2.2	SMS.....	10
<b>4</b>	<b>Hardware Overview .....</b>	<b>11</b>
4.1	General.....	11
4.2	Dimensions.....	12
4.3	Functional Block Diagram.....	14
<b>5</b>	<b>Software Overview .....</b>	<b>15</b>
5.1	Installation Procedure.....	16
5.2	Wireless Manager.....	16
5.2.1	Status Display.....	17
5.2.2	Settings.....	17
5.2.3	Help .....	18
5.3	SMS Utility .....	19
5.4	SDK .....	19
<b>6</b>	<b>Related Information and references .....</b>	<b>20</b>
<b>7</b>	<b>Technical Specifications.....</b>	<b>21</b>
7.1	General.....	21
7.2	Exterior Description .....	22
7.3	Environment .....	22
7.4	Electrical Characteristics .....	22
7.5	Operating System Support .....	22
7.6	UMTS Technical Data .....	23
7.7	HSPA Technical Data.....	23
7.8	GSM Performance and Technical Characteristics.....	24
7.9	Supported GSM Features.....	24
7.10	GPRS Maximum Data Rates.....	25
7.11	EDGE Technical Data .....	25
7.12	EDGE Maximum Data Rates.....	26
7.13	Smartcard Authentication .....	26
7.14	SMS Technical Data.....	26
7.15	Supported Languages .....	27

<b>8</b>	<b>Operational and Regulatory information.....</b>	<b>28</b>
8.1	Operational Information .....	28
8.1.1	Wireless Interoperability .....	28
8.1.2	Safety .....	28
8.1.3	Recommendations.....	29
8.1.4	Children .....	29
8.1.5	Disposal of old electrical & electronic equipment .....	29
8.1.6	Emergency calls .....	30
8.2	Regulatory Information .....	30
8.2.1	United States, FCC Notices.....	30
8.2.2	European Union, EU Declaration of Conformity .....	31
<b>9</b>	<b>Environmental Declaration .....</b>	<b>32</b>
<b>10</b>	<b>Material Declaration .....</b>	<b>33</b>
10.1	Banned Substances .....	33
10.2	Restricted Substances.....	33
10.3	Disposal.....	33
<b>11</b>	<b>Terminology .....</b>	<b>35</b>

# 1 About this Document

## 1.1 Purpose

This user guide for F3307 gives the reader a deeper technical understanding of the features, applications and configuration of F3307. A simplified technical explanation of GSM/GPRS/EDGE and UMTS/HSPA data services is also included in this document.

## 1.2 Audience

People who can benefit from this document include:

- End-users
- Notebook vendors
- IT professionals
- Software developers
- Support engineers
- Business decision-makers
- Mobile operators

More information can be found on the World Wide Web at <http://www.ericsson.com/mobilebroadbandmodules>.

## 2 Product Overview

F3307 is a PCI Express Full-Mini Card Mobile Broadband Module for UMTS and GSM, which enables notebook users to have flexible and high speed mobile access to the Internet or corporate network, including “always online” capability. It supports data services through HSPA, UMTS, EDGE, GPRS, and Data message service. New versions of the PC application software, drivers and module firmware can be installed by the end user.



### 2.1 Product Features

F3307 is flexible and automatically chooses the best data service available in a particular location, whether it is HSPA, UMTS, EDGE or GPRS. This is particularly useful for users roaming on several different networks.

As a dual-band UMTS device, F3307 can operate globally. It automatically chooses between UMTS band II and V (alternatively UMTS band I and VIII). It is also a quad-band GSM device, and can operate on any GSM system in the world. Therefore, users can use wireless communication from their notebooks on all five continents, in over 205 countries.

With the F3307 Mobile Broadband Module installed in a notebook computer, it is always available for data transfer. F3307 does not support voice calls. Connection settings are automatically created based on the SIM card. The user simply clicks the “Connect” button to make an Internet connection. The system is preconfigured. Parameters suitable for many networks are included and can be configured if needed to facilitate manual configuration where required. A status screen and an icon in the notification area enable users to check status information such as signal strength, perform common functions and access help.

F3307 has wide notebook compatibility. The PCI Express Mini Card is designed to use the integrated GSM/UMTS antennas in notebook computers. F3307 supports the Microsoft Windows XP, Vista, Windows 7 and Linux operating systems. Since the module is optimized to work with the notebook, it is better integrated and provides a superior end-user experience compared to generically produced cards that need to work across multiple computing platforms. Consequently, the built-in module has better radio performance and less battery power consumption than an external card.

Application developers may utilize F3307 via the high level API.

## 3 Communication

The F3307 Mobile Broadband Module keeps end-users up to date by giving them the best available mobile service wherever they are.

F3307 is a dual mode device, able to connect via UMTS/HSDPA and GSM/GPRS/EDGE. The user will remain connected without having to think about what system is being used – the handoff between two systems and network technologies is automatically managed by F3307. F3307 comes in two hardware versions:

- supporting both dual-band UMTS 2100MHz and 900MHz (Band I and VIII) and quad-band GSM/GPRS/EDGE 850/900/1800/1900 MHz
- supporting both dual-band UMTS 1900MHz and 850MHz (Band II, and V) and quad-band GSM/GPRS/EDGE 850/900/1800/1900 MHz.

### 3.1 Network Technologies

#### 3.1.1 UMTS

3G (third-generation) services combine high-speed radio access with IP-based (Internet Protocol) services. This not only means fast mobile connection to the World Wide Web, but also a totally new way to communicate, access information, conduct business, learn and be entertained.

Compared to 2G mobile networks, 3G significantly boosts network capacity, a much needed feature in densely populated areas. This means that operators are able to support more users and offer them more sophisticated services.



**3.1.1.1 HSPA**

HSPA (High Speed Packet Access) is available in all developed UMTS markets. With its HSDPA solution, F3307 is capable of downlink-speeds of up to 7.2 Mbps. This, together with its antenna diversity, gives F3307 a fast and reliable downlink. F3307 uses HSUPA which enables uplink speeds of up to 2 Mbps. With HSPA, users can enjoy faster download and upload capability while network operators benefit from increased capacity.

**3.1.1.2 WCDMA**

The initial implementation of UMTS networks enables Internet or corporate network access at bidirectional data rates of up to 384 kbps.

**3.1.2 GSM**

Global System for Mobile Communication (GSM) coverage is available almost everywhere, and provides a secure fall back so that network connection is maintained.

**3.1.2.1 GPRS**

General Packet Radio Services (GPRS) is an enhancement to GSM networks and provides packet data transmission. The connection setup is fast and, once connected, applications may send and receive data whenever required.

F3307 can achieve communication speeds through GPRS up to a theoretical maximum of 85.6 kbps downlink and 42.8kbps uplink.

**3.1.2.2 EDGE**

Enhanced Data rates for Global Evolution (EDGE) is an integral part of the GSM family of open mobile standards. EDGE improves GPRS by increasing data throughput by a factor of three. GPRS networks enhanced with EDGE are often referred to as Enhanced GPRS (E-GPRS) networks.

F3307 can achieve communication speeds up to a theoretical maximum of 247.4 kbps downlink and 123.7 kbps uplink; MCS-9). Typical end-user speeds are in the range of 120 kbps under average conditions, with burst speeds around 200 kbps in strong signal conditions.

## 3.2 Core Features

### 3.2.1 Browsing and internet access

F3307 provides a standard Internet connection using a Network Driver Interface Specification (NDIS) "Wireless WAN" adaptor. It is possible to use the Internet or intranet with a generic browser.

A common e-mail solution is to use an Internet connection and Transport Layer Security (TLS) to browse corporate e-mail via a web interface.

F3307 works with most popular corporate Virtual Private Networking (VPN) solutions.

### 3.2.2 SMS

F3307 can send and receive text messages with the convenience of a full keyboard. Facilities such as copy and paste make it fast and easy to send information via text messages from a computer. The standard maximum length of a text message is 160 characters, (dependent on text coding), but since concatenation is supported, messages larger than 160 characters can be sent and received.

## 4 Hardware Overview

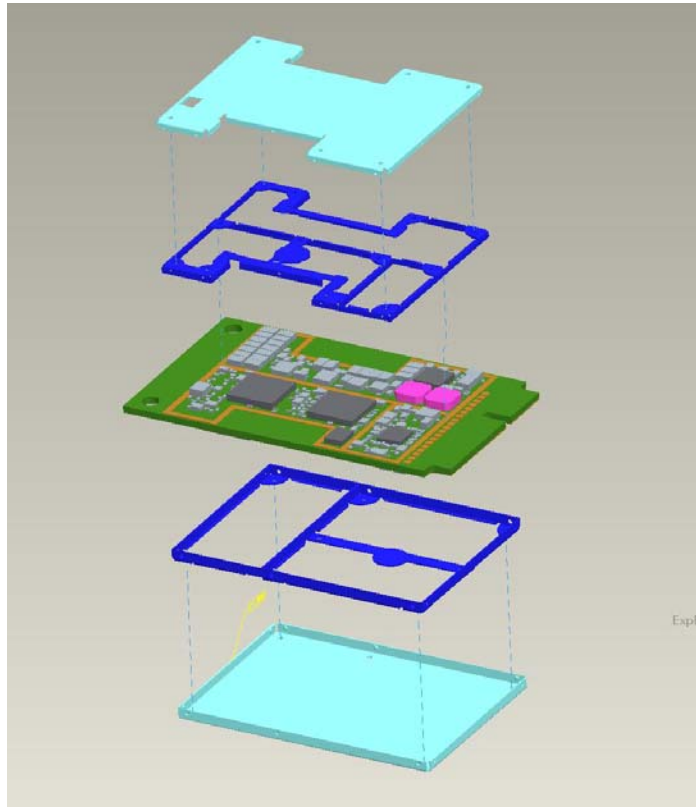

### 4.1 General

F3307 is a full-size, type F2 mini card, built according to the PCI express mini card specifications, see chapter 6, Related Information and references. F3307 is an integrated solution using the notebook's antenna system and UICC reader. It is designed as an add-in option for integrators of notebook computers and comprises the following component parts:

- HSPA wireless network adapter is the wireless enabler integrated onto the Mini Card PCB together with its mechanical RF shielding.
- RF connectors, which provide physical connectivity, and the antennas which are integrated into the notebook computer's mechanical housing.
- Voltage regulation circuitry, which converts power from the host power supply to the core-regulated voltage for the HSPA wireless components.
- System connector, which provides the data, control, power, status and UICC interface between the host and the wireless network adapter.

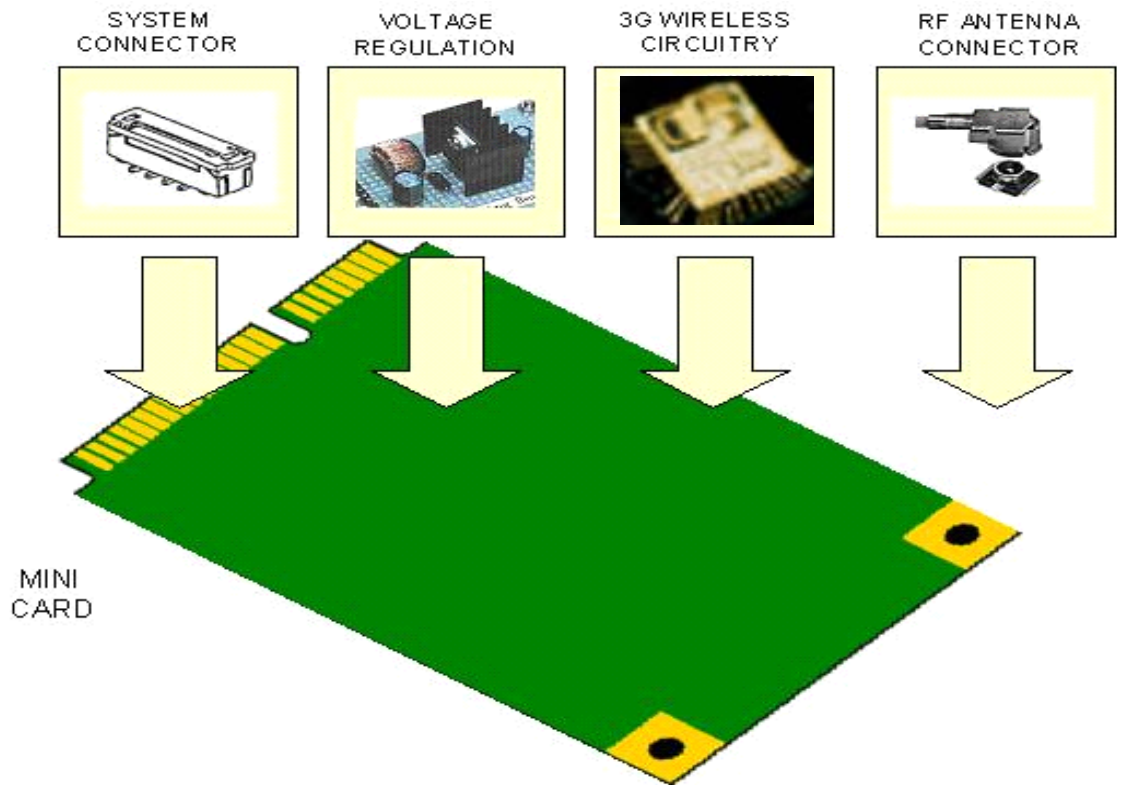

All components except the two antenna connectors are covered by EMC shields. All power and base band communication is routed through the edge connector of the card. The fastening holes in the upper corners are connected to ground.

## 4.2 Dimensions

The dimensions of the card are given in the figure below. The figure shows top and bottom views of the card with all measurements in millimeters. The mini card is a type F2 and is designed to fit into a full-size Mini card slot or into two half-size Mini card slots. Note that the figures are given without tolerance values; see the PCI Express Mini Card Electro Mechanical specification for more details.

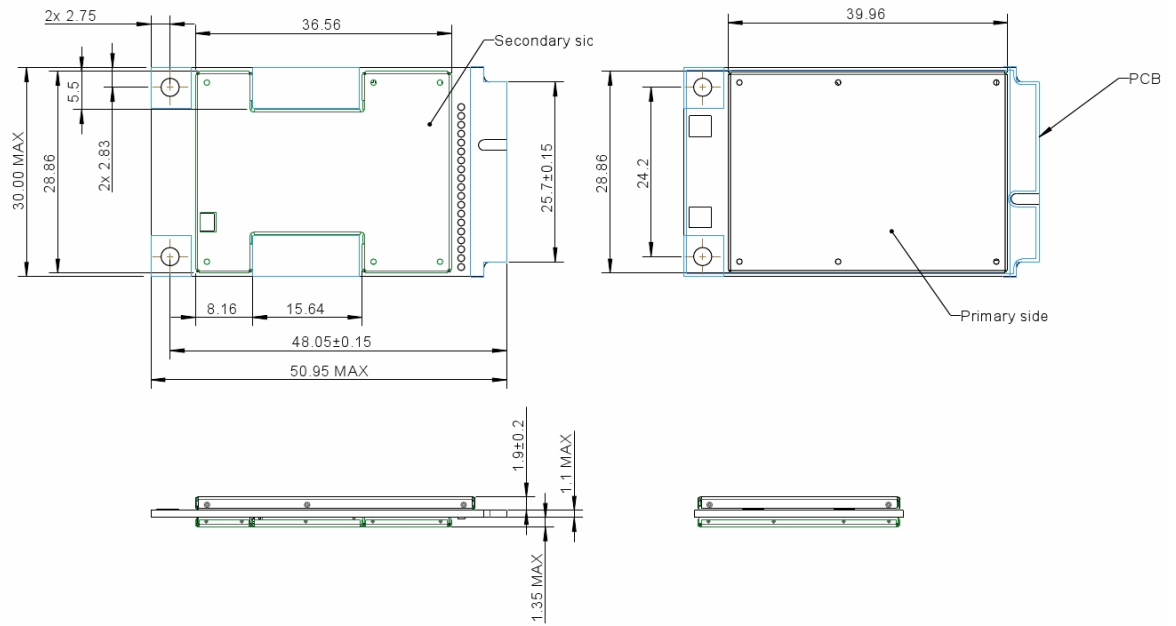

There are three connectors located on the card: two RF connectors located in the top corners and one system connector located on the lower edge, see the figure above.

The RF connectors are of type U.FL. The Main connector is used for UMTS/GSM transmission and reception. The AUX connector is used for UMTS diversity.

The System connector is a straight single 52-pin connector, 26 pins on each side of the card. The connector is specified in the PCI Express Mini Card specification.

### 4.3 Functional Block Diagram

A function representation of F3307 Mini Card is included in the figure below.

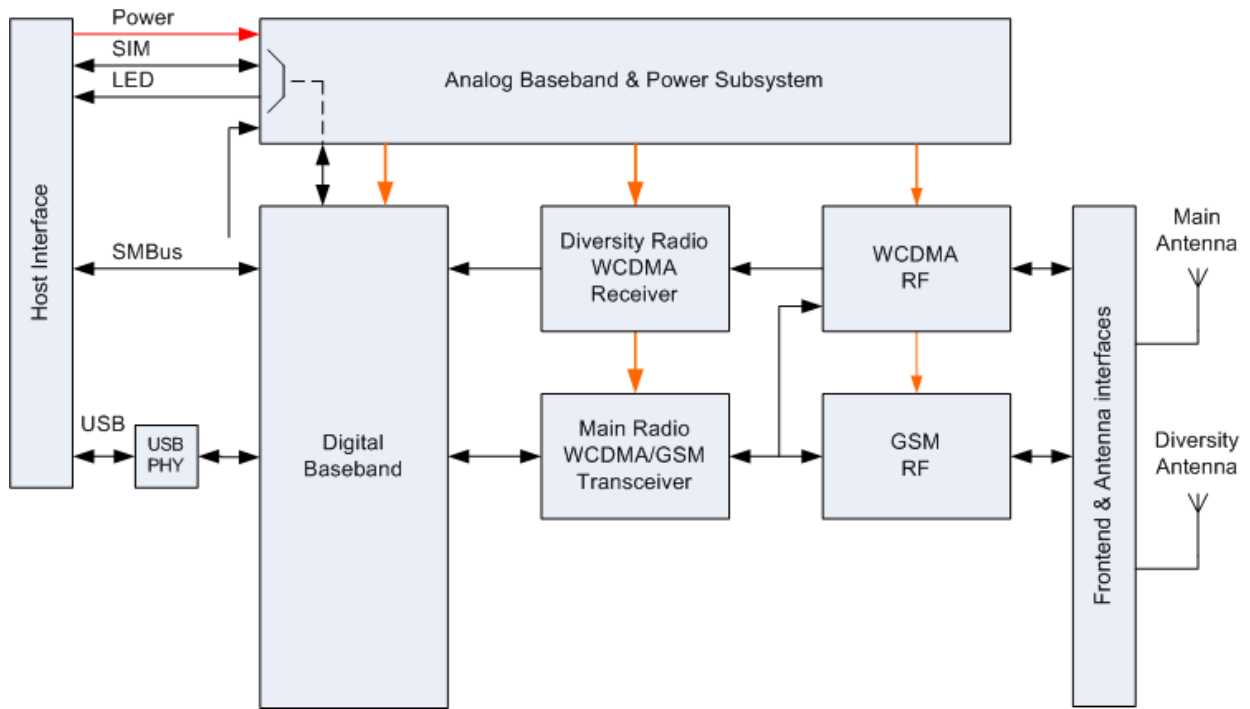

## 5 Software Overview

**Note:** This section and its subsections are applicable on the generic module. Customization differences may occur.

The PC software architecture consists of drivers, a Windows service, APIs and two applications

- Wireless Manager (WM) to control the Mobile Broadband connection
- SMS application, used to send and receive text messages

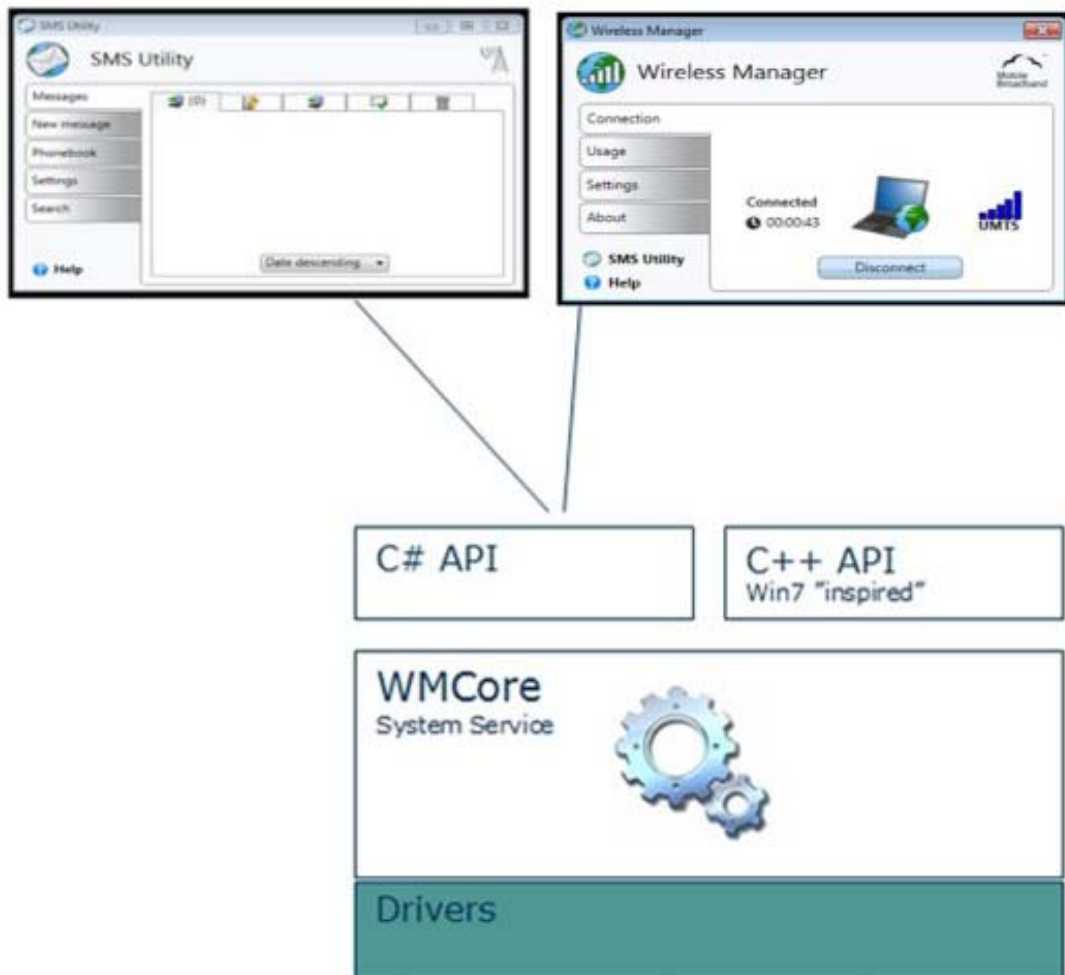

## 5.1 Installation Procedure

Installation follows normal Windows procedures. Microsoft .NET™ 3.5 or later needs to be installed on the machine. If missing, a prompt will inform the user during the installation process to install the .NET Framework.

The installation can be done both in interactive and silent mode to enable installation without user interaction.

## 5.2 Wireless Manager

The Wireless Manager is accessed from the Windows Desktop or via **Start | Programs | Wireless Manager**. Preferences can be set to automatically switch the transmitter on and make a connection.

A Wireless Manager icon is placed in the Windows notification area at the bottom right of the screen. Set the “Minimize to notification area” option in Wireless Manager to show an icon in the Windows notification area if the Wireless Manager Status window is minimized (if F3307 is active).

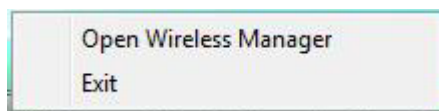

To open the Wireless Manager, right-click the Wireless Manager icon to access a menu and select “Open Wireless Manager”. Select “Exit” to quit the Wireless Manager.

The Windows NDIS icon  indicates an active connection and data flow. The total connection time and transmit and receive byte count is also shown in the Wireless Manager.



### 5.2.1 Status Display

Wireless Manager opens to a status window which provides network and connection information.



The network operator's and notebook manufacturer's logos can be customized in the application. Connection duration, connection mode, volume of data and an indication of the signal strength are provided in the Wireless Manager window while connection is active. The figures provide an approximate checkpoint of the data volumes. Please note that the information shown here is not guaranteed to match the mobile operator's bill.

### 5.2.2 Settings

Settings are presented in logical groups. Connection settings are automatically set up each time a new SIM card is inserted in to F3307. The Wireless Manager contains a list of many operator settings. The home operator on the SIM is matched with this list and a default connection profile is automatically created.

The settings may be viewed and edited. Alternative settings can be manually entered or selected from a database covering many mobile operators.

#### 5.2.2.1 Connection Configuration

When a new SIM card is detected by F3307, the Wireless Manager identifies the home network and automatically creates a connection profile from a pre-loaded list of operator settings. This becomes the default profile and is available immediately. Therefore, the user does not need to do anything, in most cases, except click the Connect button to establish a connection.

If the operator settings are not available or a personalized (company-specific) APN is in use, the information may be entered manually. Any number of profiles may be defined (including Access Point Name, Username and Password). Quality of Service parameters is set to "network default".

### **5.2.2.2 Connection Operation**

No user interaction is required to set the speed of the connection. It will be automatically set by the network depending on available network resources and the user's subscription.

F3307 will automatically use the UMTS network by preference and automatically switch over to GPRS/EDGE where the operator has an integrated UMTS/GSM network if UMTS coverage is not available. When UMTS coverage returns, the connection will return to the UMTS network. In some networks, data flow must be paused. F3307 therefore needs to return to an idle state before a return to UMTS can take place. This is network-specific.

Similarly, if HSPA is available in the UMTS network, the higher download speeds will be automatically available. In some networks, it is not possible to detect HSPA until a connection is made.

### **5.2.2.3 IP Number Allocation**

F3307 enables you to work within your corporate and/or ISP-assigned IP numbering scheme. It supports dynamic IP allocation. Dynamic IP allocation is normally used by both ISPs and corporate networks.

## **5.2.3 Help**

The Wireless Manager has a built in help function. The help window is started by clicking on help in the main window, or by pressing function key F1.

## 5.3 SMS Utility

Text messages can be sent and received with the SMS Utility. Concatenation is supported, so messages longer than 160 (dependent on character coding) characters can be sent and received. The phonebook is an integrated part of the application and messages can be sent from a phonebook contact.

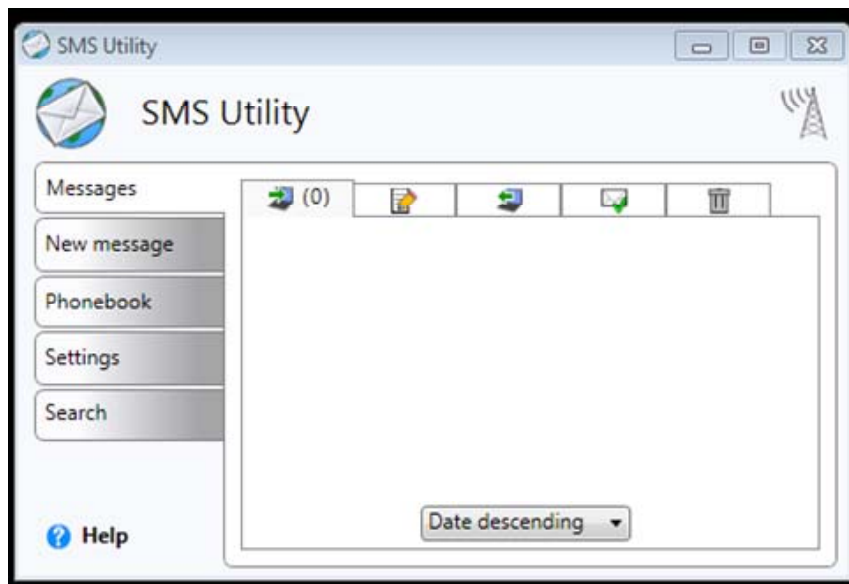

## 5.4 SDK

In addition to the AT-command interface, an Application Programming Interface (API) for F3307 is provided as part of the Software Development Kit (SDK) package. The API library is written in C++ and will provide third-party developers with a simplified interface to access device functionality.

The API is delivered as a Dynamic Link-Library (DLL), which exposes all necessary functionality to third party applications. The SDK package includes a detailed developer's guide, which covers all the exposed API functions with their descriptions, arguments, return values and code examples (where needed).

## 6 Related Information and references

Web Site	Information
<a href="http://www.ericsson.com/mobilebroadbandmodules">http://www.ericsson.com/mobilebroadbandmodules</a>	Product information and information about mobile network infrastructure
<a href="http://www.gsmworld.com/">http://www.gsmworld.com/</a>	General information on GSM, GPRS and EDGE
<a href="http://www.umts-forum.org">http://www.umts-forum.org</a>	General information on UMTS
<a href="http://www.pcisig.com/home">http://www.pcisig.com/home</a>	The PCI Express Mini Card Standard

- [1] PCI EXPRESS MINI CARD ELECTROMECHANICAL SPECIFICATION, REV 1.2

## 7 Technical Specifications

### 7.1 General

Information	Band I and VIII Variant	Band II and V Variant
Product name	F3307	
Card type	PCI Express Full-Mini Card type F2	
System	GSM 850 E-GSM 900 GSM 1800 GSM 1900 UMTS 900 UMTS 2100	GSM 850 E-GSM 900 GSM 1800 GSM 1900 UMTS 850 UMTS 1900
Services supported	GSM: Packet-Switched data GPRS/EDGE, SMS, UMTS: Packet-Switched data, HSPA, SMS	
SIM Card	USIM, GPRS-aware and Regular (non-GPRS-aware) supported 3 V and 1.8 V type	
Certification and Type Approval	CE R&TTE FCC Microsoft WHQL GCF PTCRB	CE R&TTE FCC Microsoft WHQL GCF PTCRB IC
Speech services	Speech services are not supported	
Type Number	KRD 131 16/02	KRD 131 16/01
Modes	PDP type IP	
IP Allocation	Dynamic	
FCC ID	VV7-MBMF33072	VV7-MBMF33071
IC		287AG-MBMF33071

## 7.2 Exterior Description

Attribute	Data
Size	PCI Express Full Mini Card type F2
Weight	<10 g
Antenna connector	U.FL connectors Main: Main TX/RX GSM/UMTS antenna connector Aux: UMTS RX diversity antenna connector

## 7.3 Environment

Attribute	Data
Ambient Temperature: Operating	-10°C to 65°C
Ambient Temperature: Storage	-30°C to 85°C
Directives	Waste Electrical and Electronic Equipment Directive (WEEE) Restriction of use of certain Hazardous Substances (RoHS)

## 7.4 Electrical Characteristics

Attribute	Data
Supported Voltage Range	3.0 V – 3.6 V (3.3 V ± 9%)
Nominal Operating Voltage	3.3 V
Average Standby Power (Radio off)	< 20 mW
Average Idle Power (Attached to network)	< 20 mW
Data Transfer Peak Average Power	< 2.8 W

## 7.5 Operating System Support

Attribute	Data
Supported Operating Systems	Microsoft Windows® XP Compatible (SP2) (32-bit and 64-bit) Microsoft Windows Vista™ (SP1)(32-bit and 64-bit) Microsoft Windows 7 (32-bit and 64-bit)

Attribute	Data
	Linux (32-bit and 64-bit)
Minimum Notebook Specification	CPU & Memory as recommended by Microsoft for Windows® PCI Express Mini Card compatible slot (USB) with GSM/UMTS two-port antenna system UICC reader

## 7.6 UMTS Technical Data

Power Class	Class 3			
Frequency bands	Band V (850)	Band VIII (900)	Band II (1900)	Band I (2100)
Frequency Range (MHz)	TX: 824-849 RX: 869-894	TX: 880 - 915 RX: 925 - 960	TX: 1850-1910 RX: 1930-1990	TX: 1920-1980 RX: 2110-2170
Duplex spacing	45 MHz	45 MHz	80 MHz	190 MHz
Advanced Receiver	Type I, Type II, Type III			
Maximum Downlink speed	384 kbps (Packet-Switched)			
Maximum Uplink speed	384 kbps (Packet-Switched)			
Features	Inter-Mode Handover (UMTS/EDGE/GPRS) Inter-Mode Reselection (UMTS/EDGE/GPRS)			
Quality Of Service	UMTS classes supported via AT Command (Wireless Manager selects default)			

## 7.7 HSPA Technical Data

Attribute	Data
Maximum Downlink Speed	7.2 Mbps
Maximum Uplink Speed	2.0 Mbps
HSDPA Categories	Categories up to 7.2 Mbps (Category 1-8)
HSUPA Categories	Categories up to 2.0 Mbps (Category 1, 3, 5)

## 7.8 GSM Performance and Technical Characteristics

Parameter	GSM 850	E-GSM 900	GSM 1800	GSM 1900
Frequency range (MHz)	TX: 824 – 849 RX: 869 – 894	TX: 880 – 914 RX: 925 – 959	TX: 1710 – 1785 RX: 1805 – 1880	TX: 1850 – 1910 RX: 1930 – 1990
Duplex spacing	45 MHz	45 MHz	95 MHz	80 MHz
Channel Spacing	200kHz	200kHz	200kHz	200kHz
Number of channels	123 Carriers x 8 (TDMA)	175 Carriers x 8 (TDMA)	374 Carriers x 8 (TDMA)	299 Carriers x 8 (TDMA)
Modulation	GMSK 8-PSK	GMSK 8-PSK	GMSK 8-PSK	GMSK 8-PSK
Power Class GSM/GPRS; EGPRS MCS1-4 (GMSK)	Class 4 2 W 33 dBm	Class 4 2 W 33 dBm	Class 1 1 W 30 dBm	Class 1 1 W 30 dBm
Power Class EGPRS MCS5-9 (8-PSK)	Class E2 0.5 W 27 dBm	Class E2 0.5 W 27 dBm	Class E2 0.4 W 26 dBm	Class E2 0.4 W 26 dBm

## 7.9 Supported GSM Features

Attribute	Data
SIM Personalization Locks	Network Network Subset Service Provider Corporate
SIM Application Toolkit USIM Application Toolkit	Supported by AT commands (Release 99) Supported by AT commands (Release 6)
Speech Coding	Not applicable (F3307 does not support speech services)
SMS over GPRS	Mobile Originated and Mobile Terminated
Data Rates	Multislot class 10 supported (see table below) GPRS Coding Schemes: CS-1, CS-2, CS-3, CS-4
Mode of Operation	Class B (attaches to both GSM and GPRS at the same time)



## 7.10 GPRS Maximum Data Rates

Coding Scheme	Data Rate per slot	4 + 1		3 + 2	
		Rx	Tx	Rx	Tx
CS-1	9.05	36.2	9.05	27.15	18.1
CS-2	13.4	53.6	13.4	40.2	26.8
CS-3	15.6	62.4	15.6	46.8	31.2
CS-4	21.4	85.6	21.4	64.2	42.8

Speed achieved depends on the Coding Scheme supported by the GSM Network. Data rate is the payload per slot, headers plus data.

## 7.11 EDGE Technical Data

Attribute	Data
Device Class	EDGE Class Multislot 10 (4 slot uplink, 2 slot downlink, maximum 5 concurrent)
Modulation Coding Schemes	MCS-1 to MCS-9
EDGE features	Link Adaptation Incremental Redundancy Extended Uplink TBF Network Assisted Cell Change (NACC)

## 7.12 EDGE Maximum Data Rates

Coding Scheme	Type of coding	Data Rate per slot	4 + 1		3 + 2	
			Rx	Tx	Rx	Tx
MCS-1	GMSK	10.60	42.40	10.60	31.80	21.20
MCS-2	GMSK	13.00	52.00	13.00	39.00	26.00
MCS-3	GMSK	16.60	66.40	16.60	49.80	33.20
MCS-4	GMSK	19.40	77.60	19.40	58.20	38.80
MCS-5	8-PSK	24.05	96.20	24.05	72.15	48.10
MCS-6	8-PSK	31.25	125.00	31.25	93.75	62.50
MCS-7	8-PSK	47.45	189.80	47.45	142.35	94.90
MCS-8	8-PSK	57.05	228.20	57.05	171.15	114.10
MCS-9	8-PSK	61.85	247.40	61.85	185.55	123.70

Speed achieved depends on the Coding Schemes supported by the GSM/EDGE Network. Data rate is the payload per slot (headers plus data).

## 7.13 Smartcard Authentication

Attribute	Data
Methods	EAP-SIM
Interface	Smart card interface

## 7.14 SMS Technical Data

Attribute	Data
Concatenated SMS	Yes, up to 10 messages
Character set	7-bit, 8-bit, Unicode
SMS Cell Broadcast	Supported by AT Command
SMS Immediate Display	Supported in Wireless Manager and by AT Command

## 7.15 Supported Languages

Product	Languages
Wireless Manager and SMS Utility	Arabic Brazilian Portuguese Chinese Traditional Chinese Simplified Croatian Czech Danish Dutch English (US) Finnish French German Greece Hungarian Italian Japanese Korean Norwegian Polish Portuguese Rumanian Russian Slovakian Spanish Swedish Thai Turkish

## 8 Operational and Regulatory information

Please read this information before using your Wireless Mobile Broadband Module.

### 8.1 Operational Information

#### 8.1.1 Wireless Interoperability

The Wireless Mobile Broadband Module is designed to be interoperable with the specific wireless service providers and their roaming partners.

#### 8.1.2 Safety

The Mobile Broadband Module, like other radio devices, emits radio frequency electromagnetic energy. The level of energy emitted by this device, however, is less than the electromagnetic energy emitted by other wireless devices such as mobile phones. The Mobile Broadband module operates within the guidelines found in radio frequency safety and recommendations. These standards and recommendations reflect the consensus of the scientific community and result from deliberations of panels and committees of scientists who continually review and interpret the extensive research literature. In some situations or environments, the use of the Mobile Broadband module may be restricted by the proprietor of the building or responsible representatives of the applicable organization.

Examples of such situations include the following:

- Using the Mobile Broadband equipment on board airplanes, or
- Using the Mobile Broadband equipment in any other environment where the risk of interference with other devices or services is perceived or identified as being harmful.

If you are uncertain of the policy that applies to the use of wireless devices in a specific organization or environment (an airport, for example), you are encouraged to ask for authorization to use the Mobile Broadband device before you turn it on.

**WARNING: Explosive Device Proximity Warning** – Do not operate a portable transmitter (such as a wireless network device) near unshielded blasting caps or in an explosive environment unless the device has been modified to be qualified for such use.

**CAUTION: Use on Aircraft** – Regulations of the FCC and FAA prohibit airborne operation of radio-frequency wireless devices because their signals could interfere with critical aircraft instruments.

### 8.1.3 Recommendations

- Always treat your product with care and keep it in a clean and dust-free place.
- Do not expose your product to liquid, moisture or humidity.
- Do not expose your product to extreme high or low temperatures.
- Do not expose your product to open flames or lit tobacco products.
- Do not drop, throw or try to bend your product.
- Do not paint your product.
- Do not use your product near medical equipment without requesting permission from your treating physician or authorized medical staff.
- Do not use your product when in or around aircraft or in areas displaying a “turn off two-way radio” sign.
- Do not use your product in an area where a potentially explosive atmosphere exists.
- Do not place your product or install wireless equipment in the area above your car’s airbag.
- Do not attempt to disassemble your product. Only authorized personnel should perform service.

### 8.1.4 Children

Do not allow children to play with your Module Broadband Module. They could hurt themselves or others, or could accidentally damage the Mobile Broadband Module. Your Mobile Broadband Module may contain small parts that could be detached and create a choking hazard.

### 8.1.5 Disposal of old electrical & electronic equipment

All electrical and electronic equipment included should not be treated as household waste. It should instead be left at the appropriate collection point for the recycling of electrical and electronic equipment. By ensuring this product is disposed of correctly, you will help prevent potential negative consequences for the environment and human health, which could otherwise be caused by inappropriate waste handling of this product. The recycling of materials will help to conserve natural resources. For more detailed information about the recycling of this product, please contact your local city office, your household waste disposal service or the store where you purchased your Mobile Broadband Module.

### 8.1.6 Emergency calls

This Mobile Broadband Modules do not support voice calls or serviced, nor emergency calls and should not be relied upon for essential communications.

## 8.2 Regulatory Information

The Mobile Broadband module must be installed and used in strict accordance with the manufacturer's instructions as described in the user documentation that comes with the product. The device manufacturer is not responsible for any radio or television interference caused by unauthorized modification of the devices included with the Mobile Broadband, or the substitution or attachment of connecting cables and equipment other than that specified by the device manufacturer. The correction of interference caused by such unauthorized modification, substitution or attachment is the responsibility of the user. The device manufacturer and its authorized resellers or distributors are not liable for any damage or violation of government regulations that may arise from the user failing to comply with these guidelines.

### 8.2.1 United States, FCC Notices

FCC Radiation Exposure Statement :

CAUTION: The radiated output power of the Wireless Mobile Broadband module is far below the FCC radio frequency exposure limits. Nevertheless, the Wireless Mobile Broadband module should be used in such a manner that the potential for human contact during normal operation is minimized. Details of the authorized configurations can be found at <https://fjallfoss.fcc.gov/oetcf/eas/reports/GenericSearch.cfm> by entering the FCC ID number on the device.

CAUTION: This device has been evaluated for and shown compliant with the FCC RF exposure limits under portable exposure conditions (antennas are within 20 cm of a person's body) when installed in certain specific OEM configurations. This device has also been evaluated and shown compliant with the FCC RF Exposure limits under mobile exposure conditions (antennas are greater than 20cm from a person's body). Details of the authorized configurations can be found at <https://fjallfoss.fcc.gov/oetcf/eas/reports/GenericSearch.cfm> by entering the FCC ID number on the device. Interference Statement:

This device complies with Part 15 of the Federal Communications Commission (FCC) Rules. Operation is subject to the following two conditions: (1) This device may not cause harmful interference, and (2) This device must accept any interference received, including interference that may cause undesired operation.

This equipment has been tested to, and found to be within the acceptable limits for a Class B digital device, pursuant to part 15 of the FCC Rules. These limits are designed to provide reasonable protection against harmful interference when the equipment is operated in a residential environment. This equipment generates radio frequency energy and is designed for use in accordance with the manufacturer's user manual. However, there is no guarantee that interference will not occur in any particular installation. If this equipment causes harmful interference to radio or television reception, which can be determined by turning the equipment off and on, you are encouraged to try to correct the interference by one or more of the following measures:

Reorient or relocate the receiving antenna

Increase the separation between the equipment and the receiver

Connect the equipment into an outlet on a circuit different from that to which the receiver is connected

Consult the dealer or an experienced radio/television technician for help

Note: This Mobile Broadband device must be installed and used in strict accordance with the manufacturer's instructions as described in the user documentation that comes with the product. Any other installation or use will violate FCC Part 15 regulations. Modifications not expressly approved by the device manufacturer could void your authority to operate the equipment.

## **8.2.2 European Union, EU Declaration of Conformity**

European Union, R&TTE Compliance Statement

Hereby, the device manufacturer declares that this Mobile Broadband device is in compliance with the essential requirements and other relevant provisions of Directive 1999/5/EC.

## 9 Environmental Declaration

Ericsson has a responsibility to the community to provide products which are safe to use and which have minimal impact upon the environment. Ericsson's Design for Environment program is designed to meet legislative and market requirements in the countries where Ericsson sell F3307.

Ericsson's Design for Environment program lists chemical substances that are banned or restricted for use in Ericsson's products and manufacturing operations. Ericsson works with its suppliers to eliminate such substances in procured material.

Restrictions on the use of substances in Ericsson products are divided into two categories; banned substances and restricted substances.

Banned substances are prohibited for use in specified applications in Ericsson products in accordance with relevant legislation.

Restricted substances may only be used where no technically and/or economically acceptable alternatives exist and will be replaced as soon as possible.

The ban or restriction does not apply where the presence of a substance is unintentional and in the form very small concentrations derived from natural impurities.

Note: Legislation regulating the use of banned substances includes exemptions allowing limited use where no technically acceptable alternatives exist. Ericsson makes use of some of these exemptions in order to maintain product quality.



## 10 Material Declaration

Laboratory reports indicate the following content of substances on Ericsson's banned and restricted list in the F3307 product.

### 10.1 Banned Substances

Substance	Allowed F3307
Cadmium	Not present
Mercury	Not present
Chromium (VI) compounds	Not present
Lead	0.0023g*
Halogenated hydrocarbons PBB/PBDE	Not present
Organo-tin compounds	Not present

\*This product is lead-free soldered but makes use of RoHS exemptions 5 & 7a 

### 10.2 Restricted Substances

Substance	Allowed F3307
Antimony	0.00045g
Beryllium	Not present
Bismuth	0.00055g
Phthalates	Not present
Chlorinated polymers	Not present
Halogenated hydrocarbons (TBBE and other non-prohibited BFR's)	0.0053g

F3307 is RoHS (Restrictions on Hazardous Substances) compliant. A full report can be obtained from Ericsson upon request.

### 10.3 Disposal

F3307 is compliant with WEEE (Waste Electrical and Electronic Equipment Directive). F3307 fulfills the directives of EFUP (Environment Friendly Use Period).



部件名称 Part Name	铅 Lead (Pb)	汞 Mercury (Hg)	镉 Cadmium (Cd)	六价铬 Hexavalent Chromium (Cr (VI))	多溴联苯 Polybrominated biphenyls (PBB)	多溴二苯醚 Polybrominated diphenyl ethers (PBDE)
金属部件 Metal Parts	X	O	O	O	O	O
塑料和聚合物部件 Plastic and Polymeric Parts	O	O	O	O	O	O
电缆及电缆组件 Cable and Cable Assemblies	O	O	O	O	O	O
机电部件 Electromechanical Parts	X	O	O	O	O	O
印刷电路板 Printed Board Assemblies	X	O	O	O	O	O
说明 Notes	<p>O: 表示该有毒有害物质在该部件所有均质材料中的含量均在SJ/T11363-2006 标准规定的限量要求以下。 Indicates that this toxic or hazardous substance contained in all of the homogeneous materials for this part is below the limit requirement in SJ/T11363-2006.</p> <p>X: 表示该有毒有害物质至少在该部件的某一均质材料中的含量超出SJ/T11363-2006 标准规定的限量要求。 Indicates that this toxic or hazardous substance contained in at least one of the homogeneous materials used for this part is above the limit requirement in SJ/T11363-2006.</p> <p>上图表明产品中哪些部件中含有所列的物质。所售产品中可能不含有所有所列的部件。 The table shows in what parts of the product the listed substances can be found. Note that some of the parts listed above may not be included in this product.</p>					

## 11 Terminology

<b>2G</b>	Generic term for the second generation of cellular networks, when digital technology was used. GSM is a 2G network.
<b>3G</b>	Generic term for the third generation of cellular networks such as UMTS.
<b>API</b>	Application Programming Interface.
<b>APN</b>	Access Point Name. Used in GPRS to define services to which the terminal can connect, for example, Internet, WAP, MyCompany.
<b>bps</b>	Bits per second – rate of data flow.
<b>CS</b>	Circuit Switched. Connection from A to B which has a fixed bandwidth and is maintained over a period of time, for example a voice telephone call.
<b>CS-1 to CS-4</b>	Coding Scheme. Determines the data rate per timeslot in GPRS.
<b>DLL</b>	Dynamic-link library, a shared library.
<b>E-GPRS</b>	Enhanced GPRS. A GPRS network enhanced with EDGE technology to provide greater speed and capacity.
<b>e-GSM</b>	Extended GSM. New frequencies specified by the European Radio Communications Committee (ERC) for GSM use when additional spectrum is needed (Network-dependent). It allows operators to transmit and receive just outside GSM's core 900 frequency band. This extension gives increased network capability.
<b>EAP</b>	Extensible Authentication Protocol.
<b>EDGE</b>	Enhanced Data Rates for Global Evolution. Technology which improves the throughput of a GPRS network by a factor of 3.
<b>GMSK</b>	Gaussian Minimum Shift Keying. A method of modulating data, used in GPRS and EDGE.
<b>GPRS</b>	General Packet Radio Services.
<b>GSM</b>	Global System for Mobile Communications. GSM is the world's most widely-used digital mobile phone system. At the end of Jan 2004 there were over one billion GSM subscribers across more than 205 countries.

<b>GSM850</b>	GSM network operating in the 850MHz band. Used in the USA.
<b>GSM 900</b>	GSM network operating in the 900MHz band. Used mainly in Europe, Australia and South Africa.
<b>GSM 1800</b>	Also known as DCS 1800 or PCN. A GSM network operating in the 1800 MHz band. Used in Europe and Asia-Pacific.
<b>GSM 1900</b>	Also known as PCS. A GSM network operating in the 1900MHz band. Used in the USA and Canada.
<b>GUI</b>	Graphical User Interface.
<b>HSPA</b>	High Speed Packet Access.
<b>HSDPA</b>	High Speed Downlink Packet Access.
<b>HSUPA</b>	High Speed Uplink Packet Access.
<b>ISDN</b>	Integrated Services Digital Network. Can provide circuit-switched data connections in multiples of 64 kbps.
<b>ISP</b>	Internet Service Provider.
<b>kbps</b>	Kilobits per second – rate of data flow.
<b>LAN</b>	Local Area Network.
<b>MCS</b>	Modulation Coding Scheme. MCS-1 to MCS-9 are used in EDGE.
<b>NACC</b>	Network Assisted Cell Change. Feature which reduces the time taken to perform a cell reselection.
<b>NDIS</b>	Network Driver Interface Specification. A Windows Device Driver specification, used for Ethernet cards, ISDN Adaptors and GPRS WAN adaptors.
<b>PC</b>	Personal Computer.
<b>PCS</b>	Personal Communications Services, often used to describe GSM1900 networks.
<b>PDF</b>	Portable Document Format. A common format for the electronic distribution of documents.
<b>PDP</b>	Packet Data Protocol.
<b>Phone book</b>	A memory in the SIM card where phone numbers can be stored and accessed by name or position.
<b>RoHS</b>	Restriction of use of certain Hazardous Substances.

<b>Rx</b>	Receive.
<b>SDK</b>	Software Developer's Kit.
<b>Service Provider</b>	A company that provides services and subscriptions to mobile services (phones, mobile broadband, etc.).
<b>SIM card</b>	Subscriber Identity Module card – a card that must be inserted in any GSM-based mobile terminal. It contains subscriber details, security information and memory for a personal directory of numbers. The card can be a small plug-in type or credit card-sized, but both types have the same functions.
<b>SMS</b>	Short Message Service. Allows messages of up to 160 characters to be sent and received via the network operator's message center to a mobile phone.
<b>TBF</b>	Temporary Block Flow.
<b>TCP/IP</b>	Transmission Control Protocol/Internet Protocol.
<b>TCP/IPv4</b>	TCP/IP Version 4. Most widely implemented form of TCP/IP today having a 4 byte address format such as 212.161.127.136.
<b>TE</b>	Terminal Equipment. Generic term for GSM terminals such as phones and Mobile Broadband Modules.
<b>TLS</b>	Transport Layer Security. Used, for example, by Web browsers
<b>Tx</b>	Transmit.
<b>UICC</b>	UMTS Integrated Circuit Card.
<b>UMTS</b>	Universal Mobile Telecommunications System. 3G network technology using WCDMA methods.
<b>USIM</b>	UMTS Subscriber Identity Module.
<b>VPN</b>	Virtual Private Network.
<b>WCDMA</b>	Wideband Code Division Multiple Access. A modulation technique using a wide bandwidth (5MHz in the case of UMTS). All terminals transmit in the entire bandwidth and the signals from each are differentiated via the use of unique codes assigned to each transmission.
<b>WEEE</b>	Waste Electrical and Electronic Equipment Directive.

**WHQL**

Windows Hardware Quality Labs. A Microsoft test and approval process. The Device Drivers for Ericsson Mobile Broadband Modules are signed by WHQL so that the Windows operating system does not warn the user of unknown or untested software.