



FCC REPORT

Report Reference No.: **TRE1612017401** R/C.....: 84205

FCC ID: **VUJAT870N**

Applicant's name.....: **ATID CO., LTD**

Address: #1211 Byuksan/Kyungin Digitalvalley 11, 184, Gasan digital 2-ro, Geumcheon-gu, Seoul, Korea

Manufacturer.....: ATID CO., LTD

Address.....: #1211 Byuksan/Kyungin Digitalvalley 11, 184, Gasan digital 2-ro, Geumcheon-gu, Seoul, Korea

Test item description: Industrial PDA

Trade Mark: Atid

Model/Type reference: AT870N

Standard.....: FCC Part 22: PUBLIC MOBILE SERVICES
FCC Part 24: PERSONAL COMMUNICATIONS SERVICES

Date of receipt of test sample.....: July. 14, 2016

Date of testing.....: Aug. 08, 2016 - Aug. 17, 2016

Date of issue.....: Aug. 18, 2016

Result: **Pass**

Compiled by
(position+printed name+signature) : File administrators Shayne Zhu *Shayne Zhu*

Supervised by
(position+printed name+signature) : Project Engineer Lion Cai *Lion Cai*

Approved by
(position+printed name+signature) : Manager Hans Hu *Hans Hu*

Testing Laboratory Name: **Shenzhen Huatongwei International Inspection Co., Ltd.**

Address: 1/F, Bldg 3, Hongfa Hi-tech Industrial Park, Genyu Road, Tianliao, Gongming, Shenzhen, China

Shenzhen Huatongwei International Inspection Co., Ltd. All rights reserved.

This publication may be reproduced in whole or in part for non-commercial purposes as long as the Shenzhen Huatongwei International Inspection Co., Ltd. is acknowledged as copyright owner and source of the material. Shenzhen Huatongwei International Inspection Co., Ltd. takes no responsibility for and will not assume liability for damages resulting from the reader's interpretation of the reproduced material due to its placement and context.

Table of Contents

1.	GENERAL INFORMATION	3
1.1	EUT Description	3
1.2	Maximum ERP/EIRP Power, Frequency Tolerance, and Emission Designator	4
1.3	Test Standards and Results	5
1.4	Test Configuration of Equipment under Test	6
1.5	Measurement Results Explanation Example	7
1.6	Facilities and Accreditations.....	7
2.	47 CFR PART 2, PART 22H & 24E REQUIREMENTS	8
2.1	Conducted RF Output Power	8
2.2	Peak to Average Ratio	11
2.3	99% Occupied Bandwidth and 26dB Bandwidth Measurement	21
2.4	Frequency Stability.....	32
2.5	Conducted Out of Band Emissions	36
2.6	Band Edge	55
2.7	Transmitter Radiated Power (EIRP/ERP).....	63
2.8	Radiated Spurious Emissions	67
3.	LIST OF MEASURING EQUIPMENT	74
4.	UNCERTAINTY OF EVALUATION	75

Change History		
Issue	Date	Reason for change
1.0	2016.08.18	First edition

1. GENERAL INFORMATION

1.1 EUT Description

EUT Type	Industrial PDA
Hardware Version	AT870N_MA_V3.0.1
Software Version	ENGSTD_0576_512_R4
EUT supports Radios application	GSM/GPRS/EDGE/WCDMA/HSPA WLAN2.4GHz 802.11b/g/n WLAN5.8GHz 802.11a/n Bluetooth V2.0 / RFID
Multi Slot Class	GPRS: Multi slot Class12, EGPRS: Multi slot Class12
Frequency Range	GSM 850MHz: Tx: 824.2 - 848.8MHz (at intervals of 200kHz); Rx: 869.2 - 893.8MHz (at intervals of 200kHz) GSM 1900MHz: Tx: 1850.2 - 1909.8MHz (at intervals of 200kHz); Rx: 1930.2 - 1989.8MHz (at intervals of 200kHz) WCDMA 850MHz Tx: 826.4 - 846.6MHz (at intervals of 200kHz); Rx: 871.4 - 891.6MHz (at intervals of 200kHz) WCDMA 1900MHz Tx: 1852.4 - 1907.6MHz (at intervals of 200kHz); Rx: 1932.4 - 1987.6MHz (at intervals of 200kHz)
Maximum Output Power to Antenna	GSM 850: 32.29dBm GSM 1900: 29.80dBm EDGE 850: 27.39dBm EDGE 1900: 25.76dBm WCDMA 850: 24.19dBm WCDMA 1900: 23.64Bm
Type of Modulation	GSM / GPRS:GMSK EDGE:GMSK / 8PSK WCDMA: QPSK(Uplink) HSDPA:QPSK(Downlink) HSUPA:QPSK(Uplink)
Antenna Type	Internal Antenna

1.2 Maximum ERP/EIRP Power, Frequency Tolerance, and Emission Designator

System	Type of Modulation	Emission Designator	Frequency Tolerance (ppm)	Maximum ERP/EIRP(W)
GSM 850	GMSK	246KGXW	0.03	1.469
GSM 1900	GMSK	245KGXW	0.03	0.726
EDGE 850	8PSK	245KG7W	0.03	0.475
EDGE 1900	8PSK	245KG7W	0.03	0.313
WCDMA 850 RMC 12.2Kbps	QPSK	4M13F9W	0.03	0.219
WCDMA 1900 RMC 12.2Kbps	QPSK	4M16F9W	0.03	0.188

1.3 Test Standards and Results

1. 47 CFR Part 2, 22(H), 24(E)
2. ANSI / TIA / EIA-603-D-2010
3. FCC KDB 971168 D01 Power Meas. License Digital Systems v02r02

Remark:

1. All test items were verified and recorded according to the standards and without any deviation during the test.
2. This EUT has also been tested and complied with the requirements of FCC Part 15, Subpart B, recorded in a separate test report.

Test detailed items/section required by FCC rules and results are as below:

No.	Section	Description	Limit	Result
	FCC			
1	2.1046	Conducted Output Power	Reporting Only	PASS
2	24.232(d)	Peak to Average Ratio	< 13dBm	PASS
3	2.1049 22.917(b) 24.238(b)	Occupied Bandwidth	Reporting Only	PASS
4	2.1055 22.355 24.235	Frequency Stability	$\leq \pm 2.5\text{ppm}$	PASS
5	2.1051 22.917 24.238	Conducted Out of Band Emissions	$< 43+10\log_{10}$ (P[Watts])	PASS
6	2.1051 22.917 24.238	Band Edge	$< 43+10\log_{10}$ (P[Watts])	PASS
7	22.913	Effective Radiated Power	< 7Watts	PASS
	24.232	Equivalent Isotropic Radiated Power	< 2Watts	PASS
8	2.1053 22.917 24.238	Radiated Spurious Emissions	$< 43+10\log_{10}$ (P[Watts])	PASS

1.4 Test Configuration of Equipment under Test

Antenna port conducted and radiated test items were performed according to KDB 971168 D01 Power Meas. License Digital Systems v02r02 with maximum output power.

Radiated measurements were performed with rotating EUT in different three orthogonal test planes to find the maximum emission.

Radiated emissions were investigated as following frequency range:

1. 30 MHz to 9000 MHz for GSM850 and WCDMA Band V.
2. 30 MHz to 20000 MHz for GSM1900 and WCDMA Band II.

All modes and data rates and positions were investigated.

Test modes are chosen to be reported as the worst case configuration below:

Test Modes		
Band	Radiated TCs	Conducted TCs
GSM 850	GSM Link EDGE Link	GSM Link EDGE Link
GSM 1900	GSM Link EDGE Link	GSM Link EDGE Link
WCDMA Band V	RMC 12.2Kbps Link	RMC 12.2Kbps Link
WCDMA Band II	RMC 12.2Kbps Link	RMC 12.2Kbps Link

Note: The maximum power levels are chosen to test as the worst case configuration as follows:

GSM mode for GMSK modulation,

EDGE multi-slot class 8 mode for 8PSK modulation,

RMC 12.2Kbps mode for WCDMA band V,

RMC 12.2Kbps mode for WCDMA band II, only these modes were used for all tests.

1.5 Measurement Results Explanation Example

For all conducted test items:

The offset level is set in the spectrum analyzer to compensate the RF cable loss and attenuator factor between EUT conducted output port and spectrum analyzer. With the offset compensation, the spectrum analyzer reading level is exactly the EUT RF output level.

The spectrum analyzer offset is derived from RF cable loss and attenuator factor.

Offset = RF cable loss + attenuator factor.

Following shows an offset computation example with cable loss 7dB and 10dB attenuator.

Example:

$$\begin{aligned}\text{Offset (dB)} &= \text{RF cable loss(dB)} + \text{attenuator factor(dB)} \\ &= 7 + 10 = 17 \text{ (dB)}\end{aligned}$$

1.6 Facilities and Accreditations

1.6.1 Test Facilities

CNAS-Lab Code: L1225

Shenzhen Huatongwei International Inspection Co., Ltd. has been assessed and proved to be in compliance with CNAS-CL01 Accreditation Criteria for Testing and Calibration Laboratories (identical to ISO/IEC17025: 2005 General Requirements) for the Competence of Testing and Calibration Laboratories, Date of Registration: February 28, 2015. Valid time is until February 27, 2018.

FCC-Registration No.: 317478

Shenzhen Huatongwei International Inspection Co., Ltd. EMC Laboratory has been registered and fully described in a report filed with the FCC (Federal Communications Commission). The acceptance letter from the FCC is maintained in our files. Registration 317478, Renewal date Jul. 18, 2014, valid time is until Jul. 18, 2017.

1.6.2 Test Environment Conditions

During the measurement, the environmental conditions were within the listed ranges:

Temperature (°C):	15°C - 35°C
Relative Humidity (%):	30% - 60%
Atmospheric Pressure (kPa):	86KPa - 106KPa

2. 47 CFR PART 2, PART 22H & 24E REQUIREMENTS

2.1 Conducted RF Output Power

2.1.1 Definition

A system simulator was used to establish communication with the EUT. Its parameters were set to enforce EUT transmitting at the maximum power. The measured power in the radio frequency on the transmitter output terminals shall be reported.

2.1.2 Measuring Instruments

The measuring equipment is listed in the section 3 of this test report.

2.1.3 Test Procedures

1. The transmitter output port was connected to the system simulator.
2. Set EUT at maximum power through system simulator.
3. Select lowest, middle, and highest channels for each band and different modulation.
4. Measure and record the power level from the system simulator.

2.1.4 Test Setup

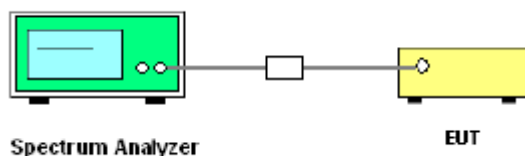

2.1.5 Test Results of Conducted Output Power

1. GSM Model Test Verdict:

Band	Channel	Frequency (MHz)	Measured Output Power dBm	Verdict
GSM 850MHz	128	824.2	32.29	PASS
	190	836.6	32.11	PASS
	251	848.8	32.08	PASS
GSM 1900MHz	512	1850.2	29.80	PASS
	661	1880.0	29.54	PASS
	810	1909.8	29.41	PASS
GPRS 850MHz	128	824.2	32.11	PASS
	190	836.6	32.02	PASS
	251	848.8	32.01	PASS
GPRS 1900MHz	512	1850.2	29.38	PASS
	661	1880.0	29.34	PASS
	810	1909.8	29.25	PASS
EDGE 850MHz	128	824.2	27.39	PASS
	190	836.6	27.15	PASS
	251	848.8	27.13	PASS
EDGE 1900MHz	512	1850.2	25.76	PASS
	661	1880.0	25.27	PASS
	810	1909.8	25.11	PASS

Note 1: For the GPRS and EDGE model, all the slots were tested and just the worst data was record in this report.

2. WCDMA Model Test Verdict:

Item	band	WCDMA 850			WCDMA 1900		
	Frequency	4132	4183	4233	9262	9400	9538
	Subtest	dBm			dBm		
WCDMA	RMC 12.2Kbps	24.19	24.06	24.11	23.36	23.64	23.53
HSDPA	1	22.25	22.31	22.28	22.08	22.03	22.06
	2	21.85	21.87	21.81	21.79	21.83	21.77
	3	21.72	21.67	21.74	21.58	21.61	21.65
	4	21.57	21.62	21.75	21.28	21.25	21.21
HSUPA	1	22.29	22.23	22.27	21.91	21.89	21.87
	2	21.79	21.81	21.84	21.74	21.69	21.67
	3	21.81	21.75	21.88	21.65	21.57	21.61
	4	21.66	21.63	21.69	21.54	21.48	21.52
	5	21.47	21.31	21.32	21.15	21.18	21.21

2.2 Peak to Average Ratio

2.2.1 Definition

Power Complementary Cumulative Distribution Function (CCDF) curves provide a means for characterizing the power peaks of a digitally modulated signal on a statistical basis. A CCDF curve depicts the probability of the peak signal amplitude exceeding the average power level. Most contemporary measurement instrumentation include the capability to produce CCDF curves for an input signal provided that the instrument's resolution bandwidth can be set wide enough to accommodate the entire input signal bandwidth. In measuring transmissions in this band using an average power technique, the peak-to-average ratio (PAR) of the transmission may not exceed 13 dB.

2.2.2 Measuring Instruments

The measuring equipment is listed in the section 3 of this test report.

2.2.3 Test Procedures

1. The testing follows FCC KDB 971168 D01v02r02 Section 5.7.1.
2. The EUT was connected to the spectrum analyzer and system simulator via a power divider.
3. For GSM/EGPRS operating modes:
 - a. Set EUT in maximum power output.
 - b. Set the RBW = 1MHz, VBW = 3MHz, Peak detector on spectrum analyzer for first trace.
 - c. Set the RBW = 1MHz, VBW = 3MHz, RMS detector on spectrum analyzer for second trace.
 - d. The wanted burst signal is triggered by spectrum analyzer, and measured respectively the peak level and Mean level without burst-off time, after system simulator has synchronized with the spectrum analyzer.
4. For UMTS operating modes:
 - a. Set the CCDF (Complementary Cumulative Distribution Function) option on the spectrum analyzer.
 - b. The highest RF powers were measured and recorded the maximum PAPR level associated with a probability of 0.1 %.
5. Record the deviation as Peak to Average Ratio.

2.2.4 Test Setup

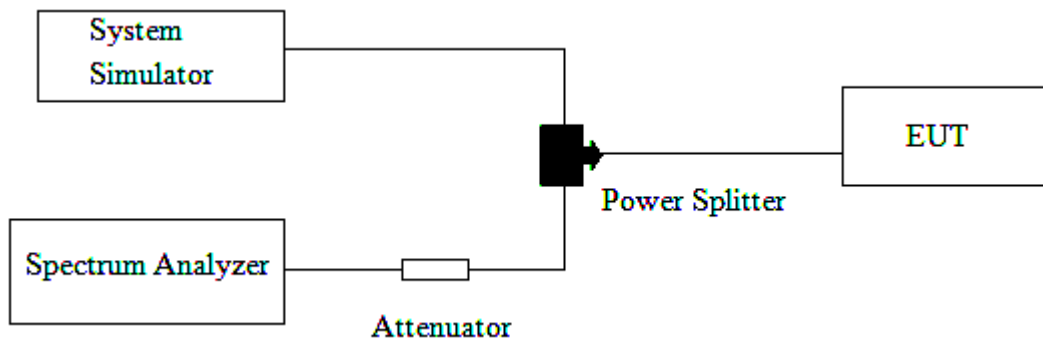

2.2.5 Test Results of Peak-to-Average Ratio

Band	Channel	Frequency (MHz)	Peak to Average ratio		Limit dB	Verdict
			dB	Refer to Plot		
GSM 1900MHz	512	1850.2	0.391	Plot A1 to A3	13	PASS
	661	1880.0	0.928			PASS
	810	1909.8	0.768			PASS
EDGE 1900MHz	512	1850.2	0.457	Plot B1 to B3	13	PASS
	661	1880.0	0.160			PASS
	810	1909.8	0.306			PASS
WCDMA 1900MHz	9262	1852.4	5.97	Plot C1 to C3	13	PASS
	9400	1880.0	5.97			PASS
	9538	1907.6	6.09			PASS

2.2.6 Test Results (Plots) of Peak-to-Average Ratio

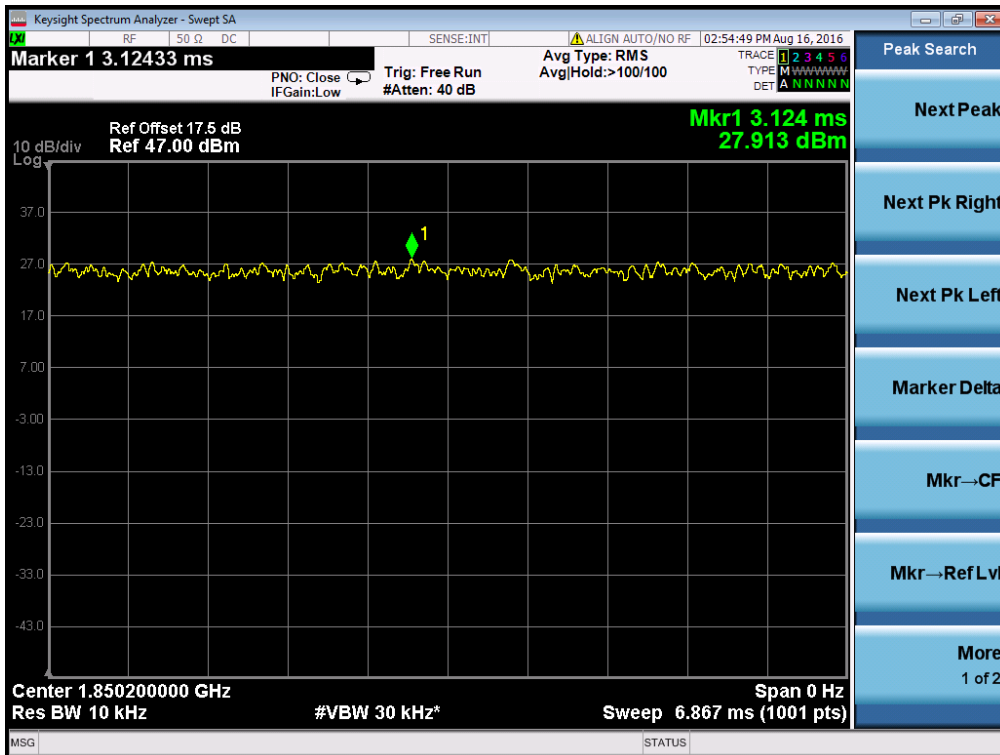
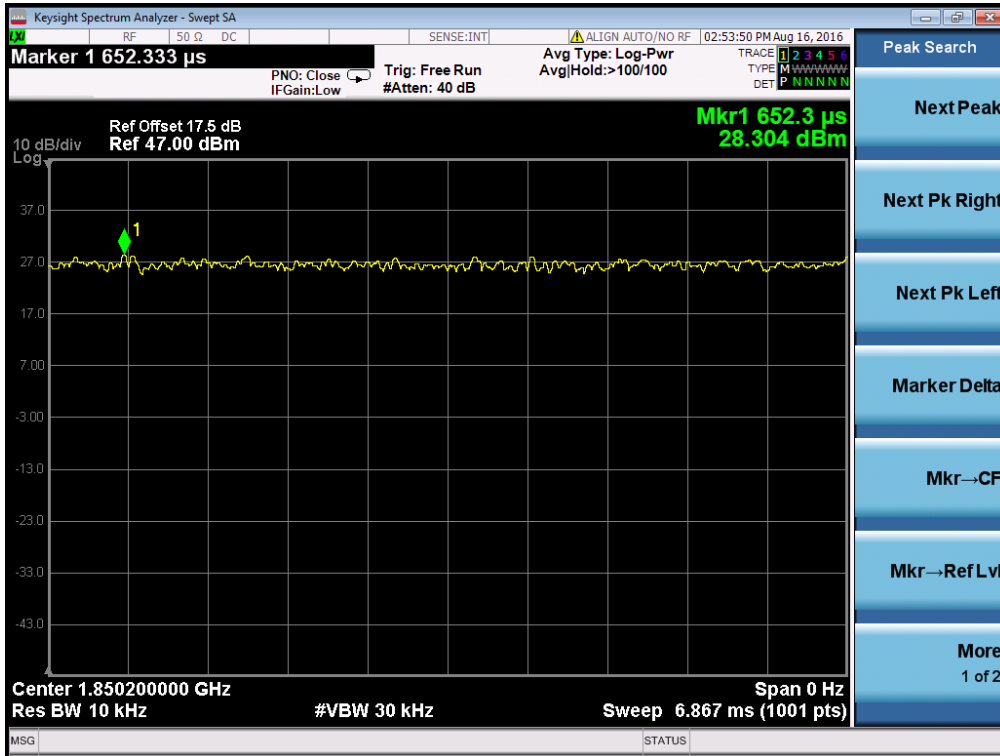

(Plot A1: GSM 1900 MHz Channel = 512)

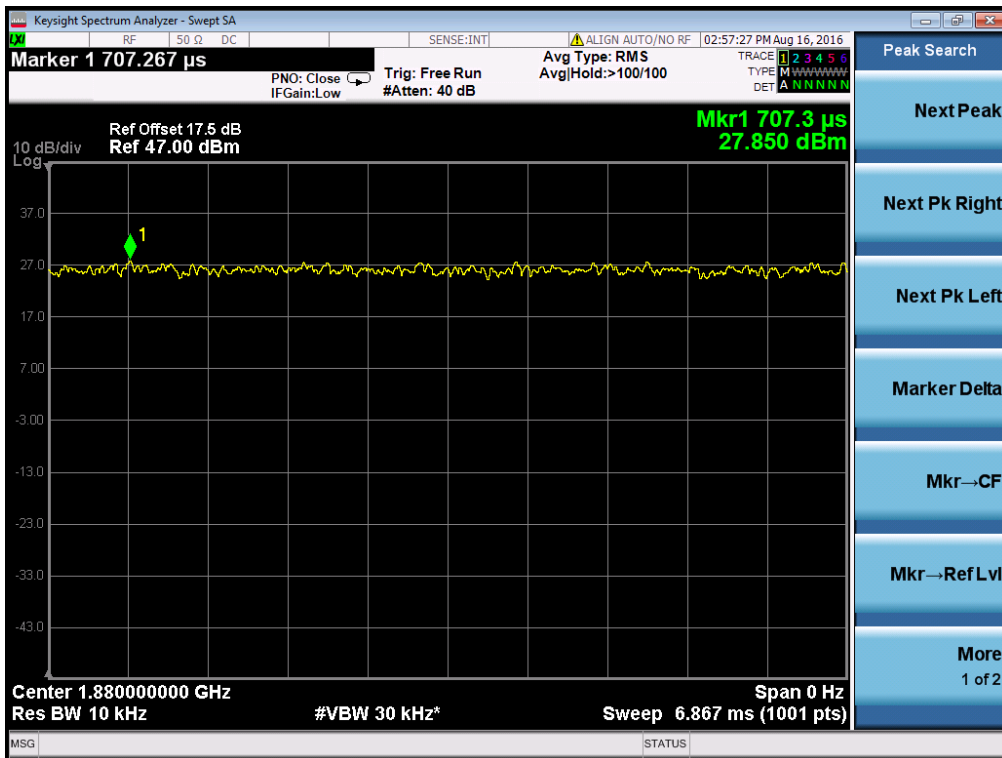
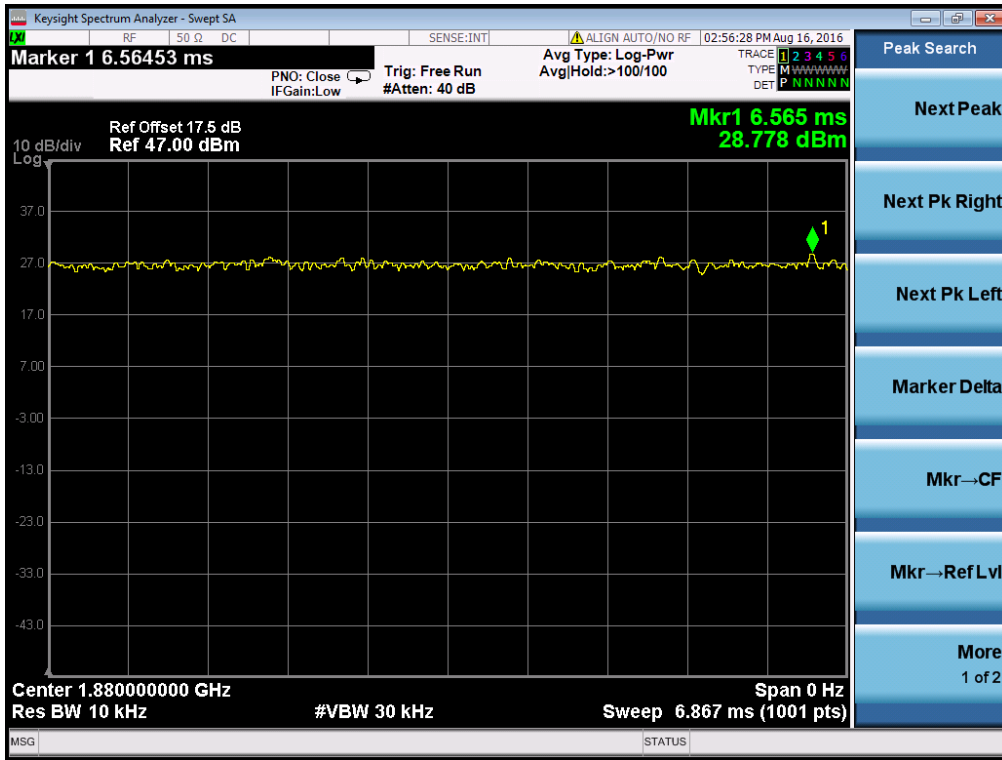

(Plot A2: GSM 1900 MHz Channel = 661)

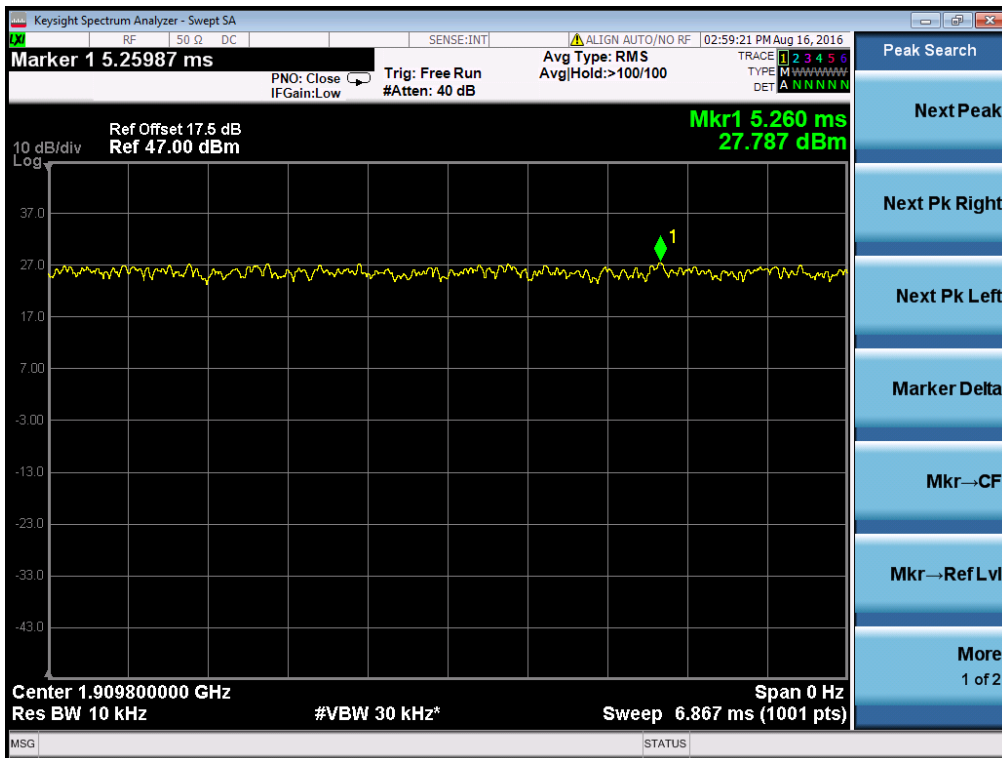
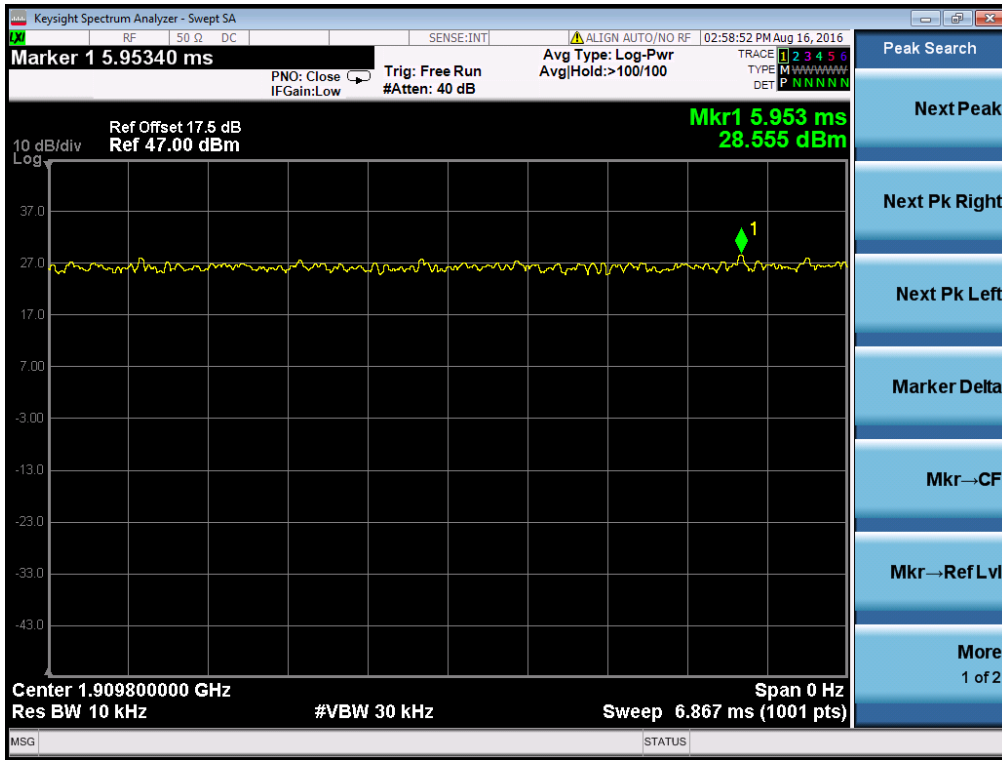

(Plot A3: GSM 1900MHz Channel = 810)

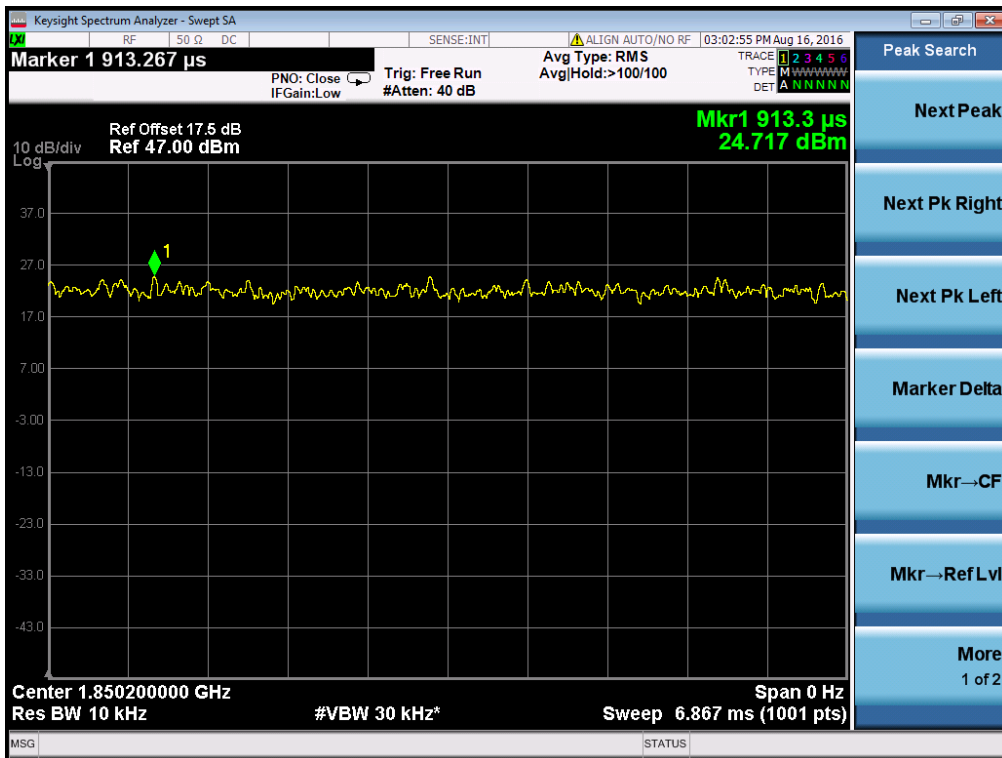
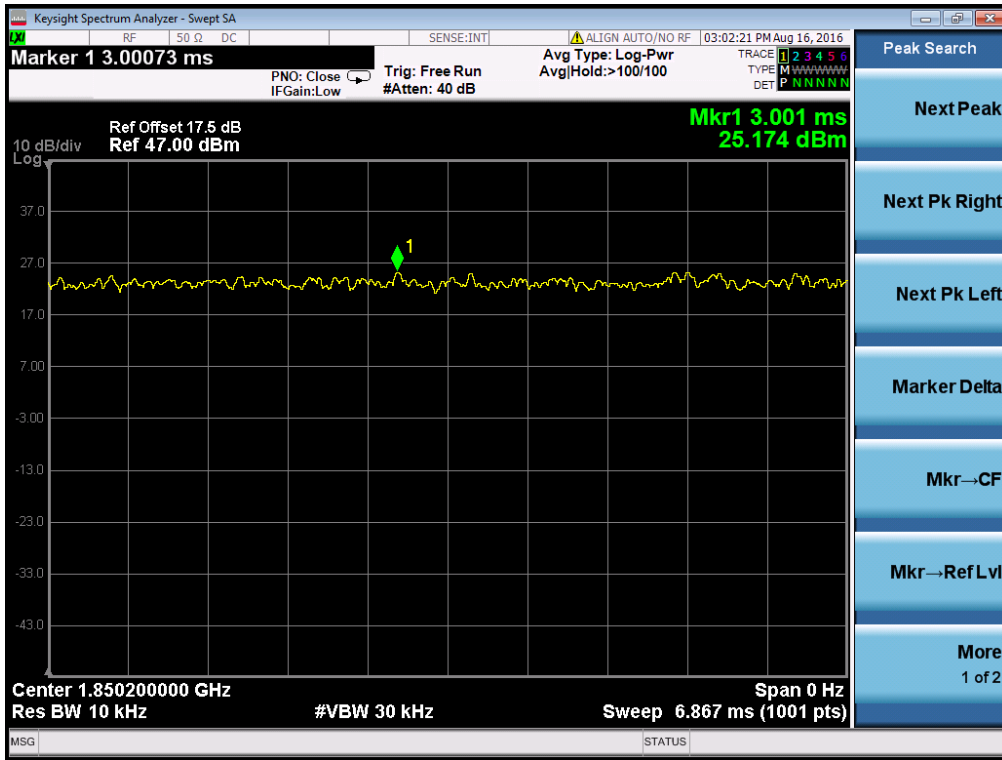

(Plot B1: EDGE 1900 MHz Channel = 512)

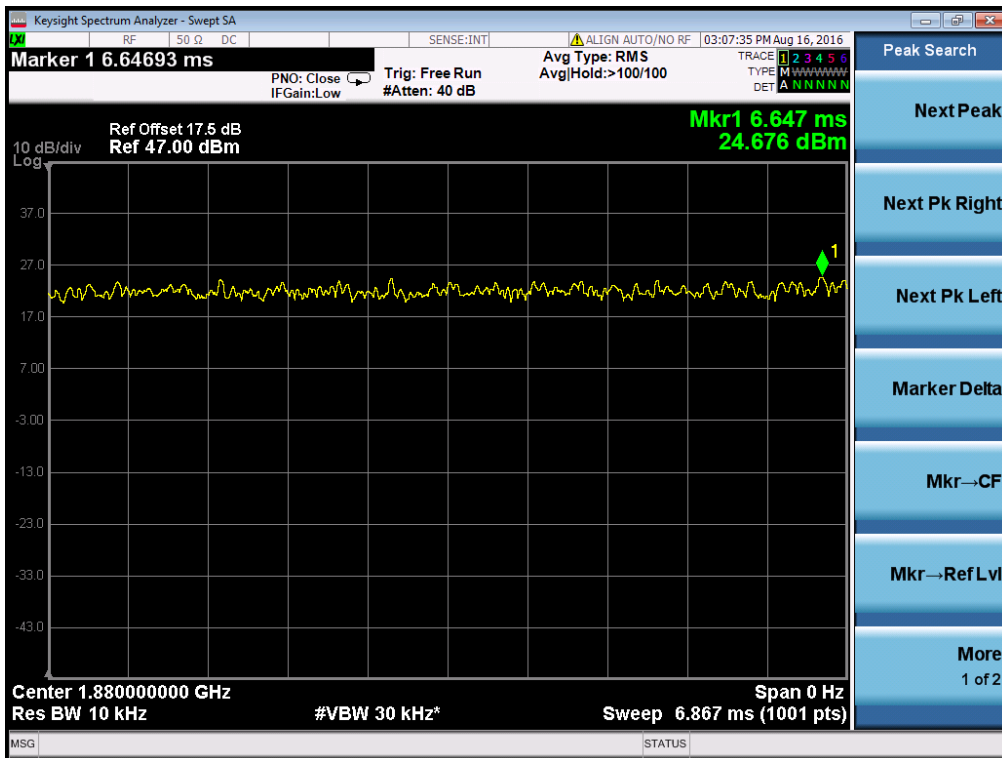
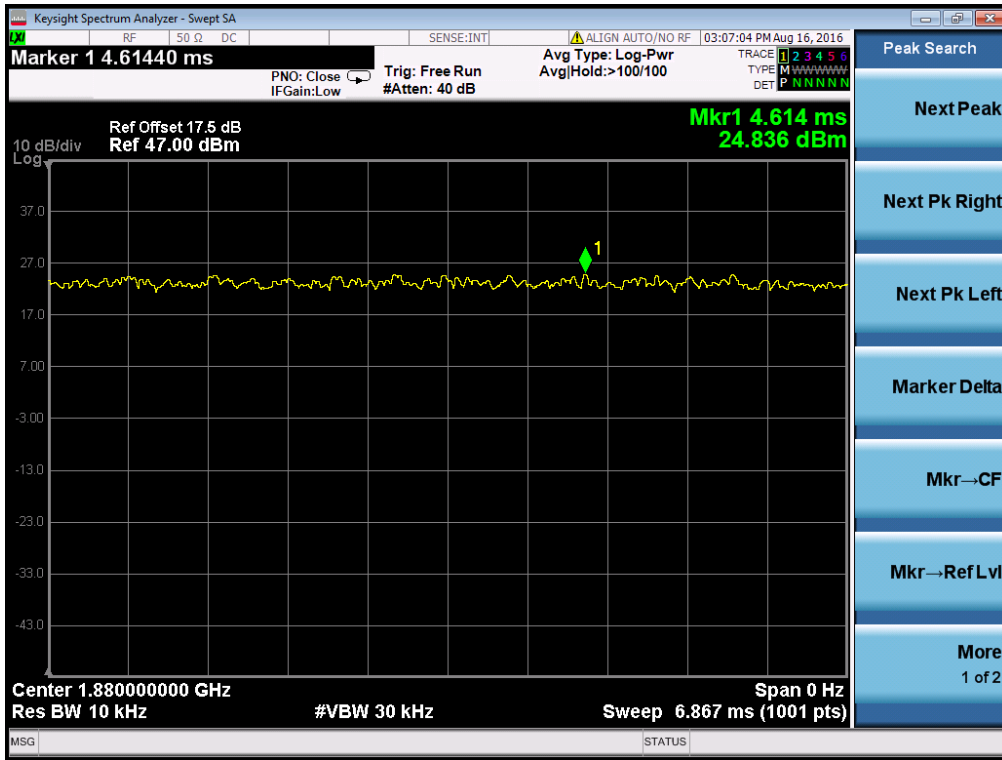

(Plot B2: EDGE 1900 MHz Channel = 661)

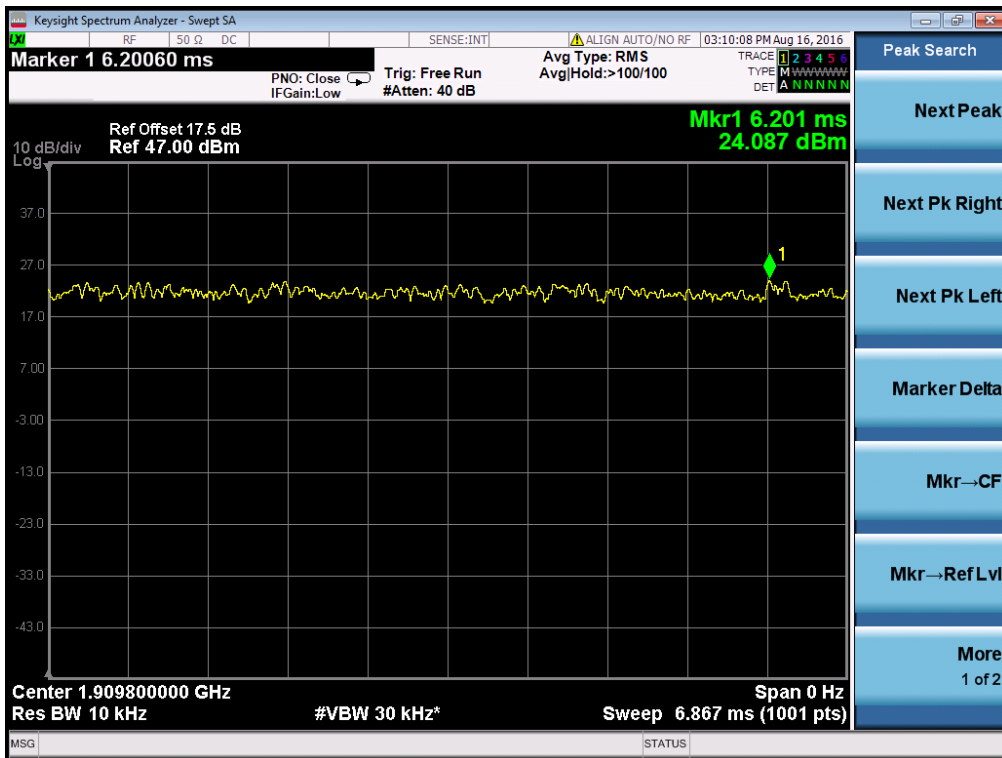
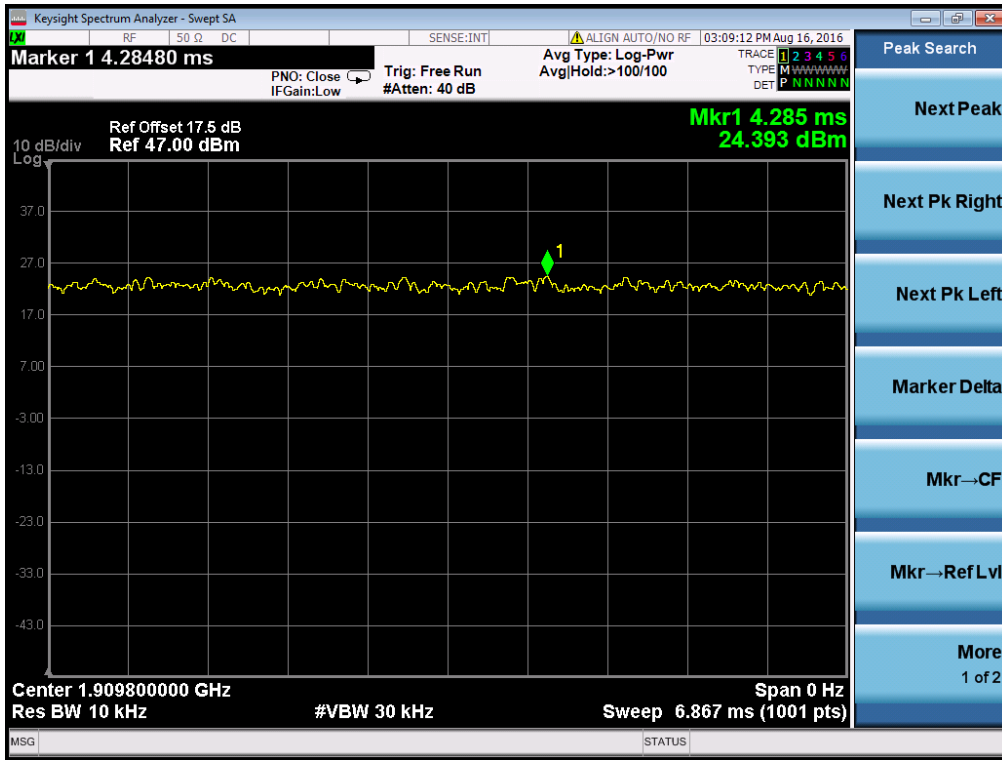

(Plot B3: EDGE 1900MHz Channel = 810)

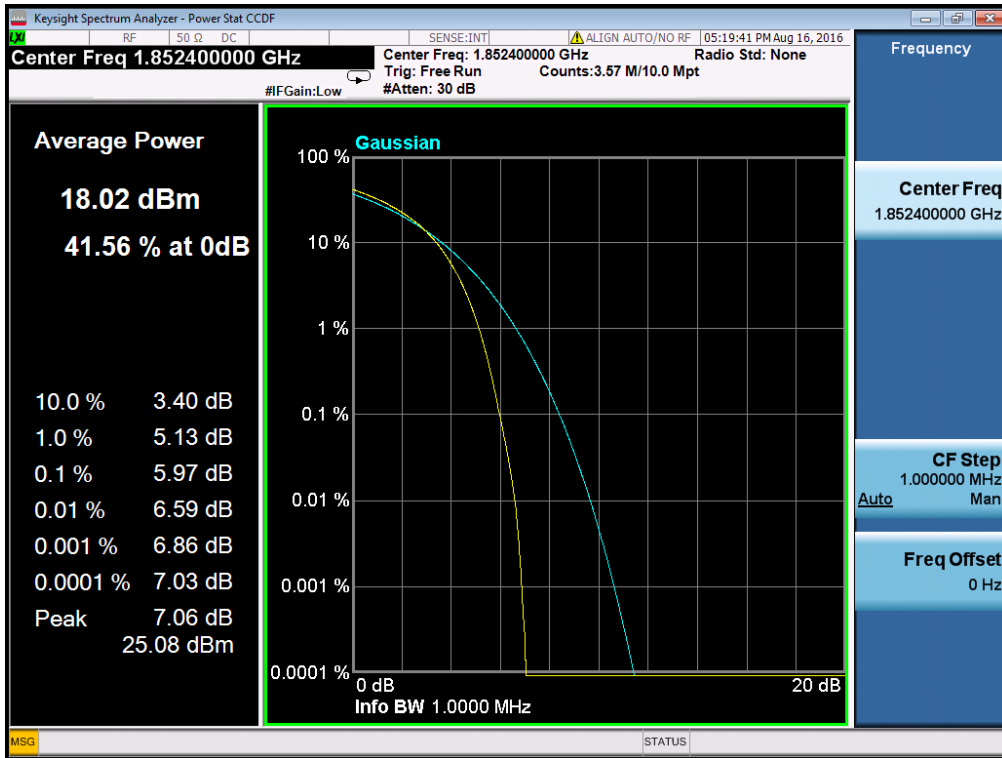

(Plot C1: WCDMA 1900MHz Channel = 9262)

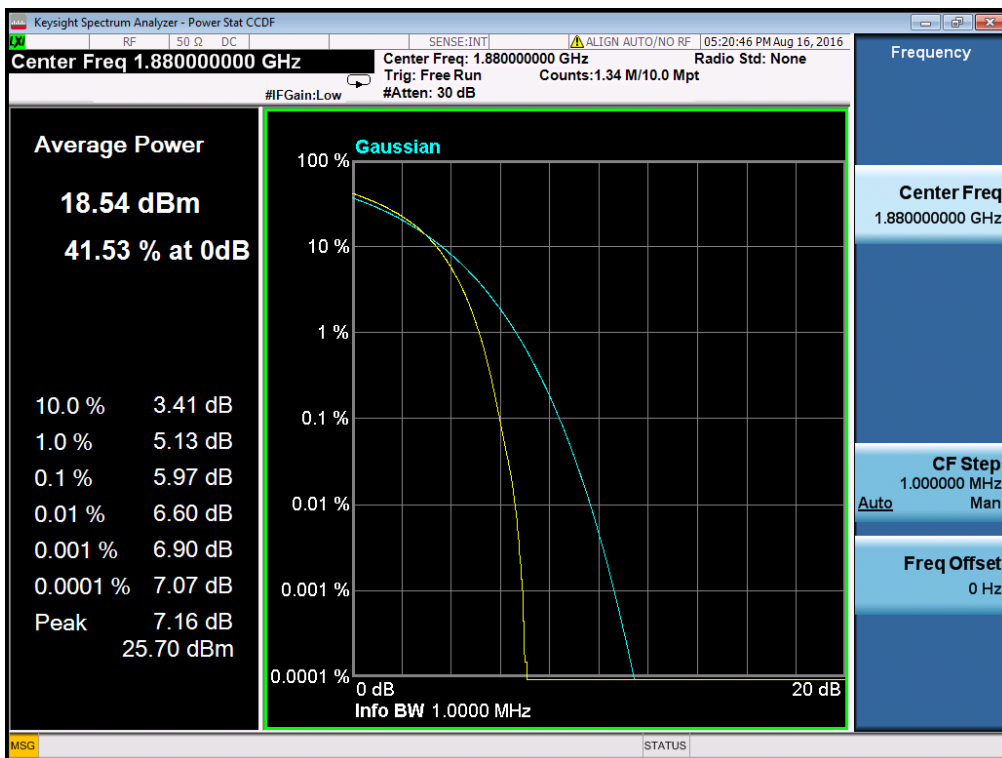

(Plot C2: WCDMA 1900MHz Channel = 9400)

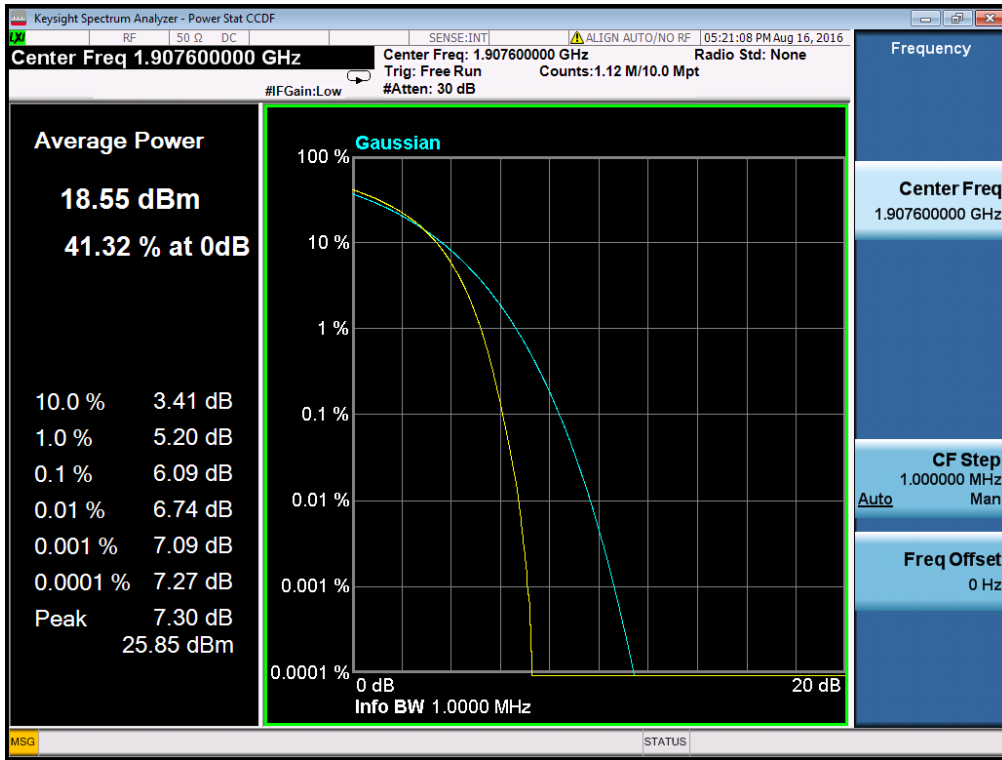

(Plot C3: WCDMA 1900MHz Channel = 9538)

2.3 99% Occupied Bandwidth and 26dB Bandwidth Measurement

2.3.1 Definition

The 99% occupied bandwidth is the width of a frequency band such that, below the lower and above the upper frequency limits, the mean powers emitted are each equal to a specified percentage 0.5% of the total mean transmitted power.

The emission bandwidth is defined as the width of the signal between two points, located at the 2 sides of the carrier frequency, outside of which all emissions are attenuated at least 26 dB below the transmitter power.

2.3.2 Measuring Instruments

The measuring equipment is listed in the section 3 of this test report.

2.3.3 Test Procedures

1. The testing follows FCC KDB 971168 D01v02r02 Section 4.2.
2. The EUT was connected to the spectrum analyzer and system simulator via a power divider.
 3. The RF output of the EUT was connected to the spectrum analyzer by RF cable and attenuator.
The path loss was compensated to the results for each measurement.
 4. The 99% occupied bandwidth were measured, set RBW= 1% of span, VBW= 3*RBW, sample detector, trace maximum hold.
 5. The 26dB bandwidth were measured, set RBW= 1% of EBW, VBW= 3*RBW, peak detector, trace maximum hold.

2.3.4 Test Setup

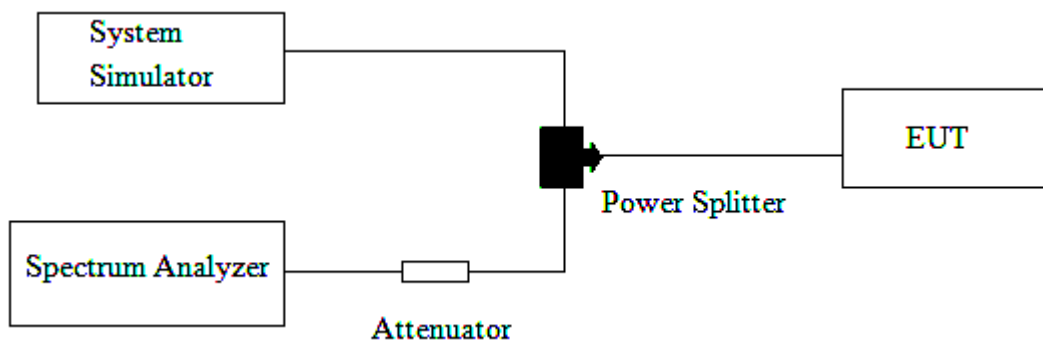

2.3.5 Test Results of 99% Occupied Bandwidth and 26dB Bandwidth

Band	Channel	Frequency (MHz)	26dB bandwidth	99% Occupied Bandwidth	Refer to Plot
GSM 850MHz	128	824.2	313 kHz	245 kHz	Plot A1
	190	836.6	311 kHz	243 kHz	Plot A2
	251	848.8	318 kHz	246 kHz	Plot A3
GSM 1900MHz	512	1850.2	312 kHz	243 kHz	Plot B1
	661	1880.0	313 kHz	245 kHz	Plot B2
	810	1909.8	311 kHz	244 kHz	Plot B3
EDGE 850MHz	128	824.2	393 kHz	240 kHz	Plot C1
	190	836.6	297 kHz	239 kHz	Plot C2
	251	848.8	303 kHz	245 kHz	Plot C3
EDGE 1900MHz	512	1850.2	311 kHz	240 kHz	Plot D1
	661	1880.0	307 kHz	243 kHz	Plot D2
	810	1909.8	308 kHz	245 kHz	Plot D3
WCDMA 850MHz	4132	826.4	4.65 MHz	4.13 MHz	Plot E1
	4183	836.6	4.65 MHz	4.13 MHz	Plot E2
	4233	846.6	4.65 MHz	4.13 MHz	Plot E3
WCDMA 1900MHz	9262	1852.4	4.66 MHz	4.14 MHz	Plot F1
	9400	1880	4.66 MHz	4.14 MHz	Plot F2
	9538	1907.6	4.66 MHz	4.16 MHz	Plot F3

2.3.6 Test Results (Plots) of 99% Occupied Bandwidth and 26dB Bandwidth

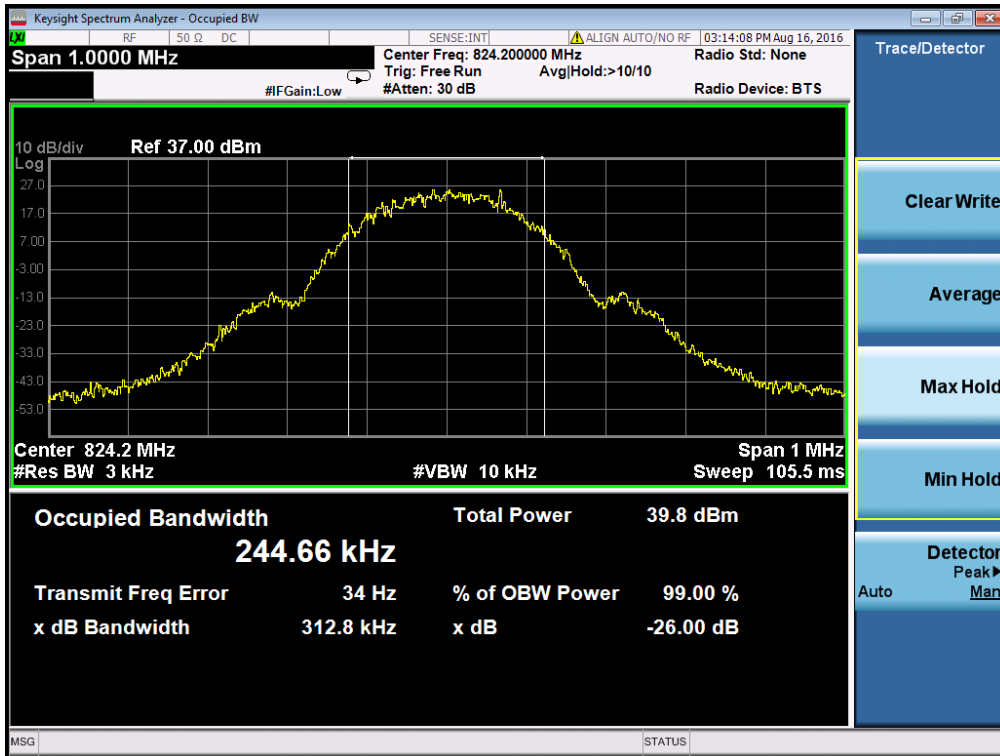

(Plot A1: GSM 850MHz Channel = 128 Occupied bandwidth)

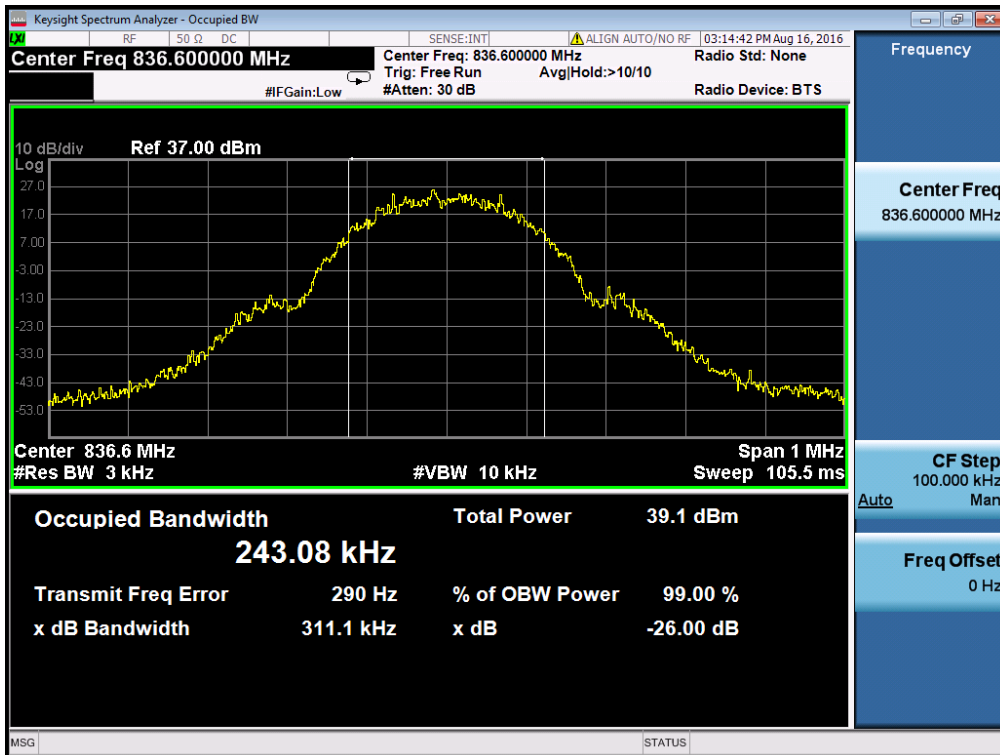

(Plot A2: GSM 850MHz Channel = 190 Occupied bandwidth)

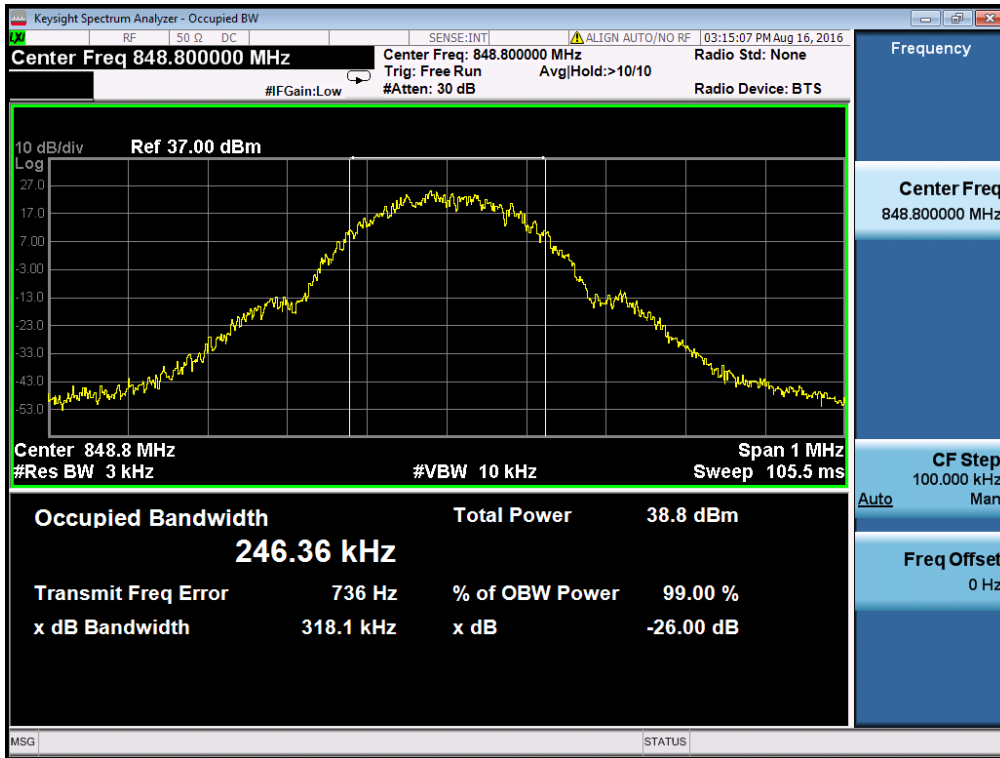

(Plot A3: GSM 850MHz Channel = 251 Occupied bandwidth)

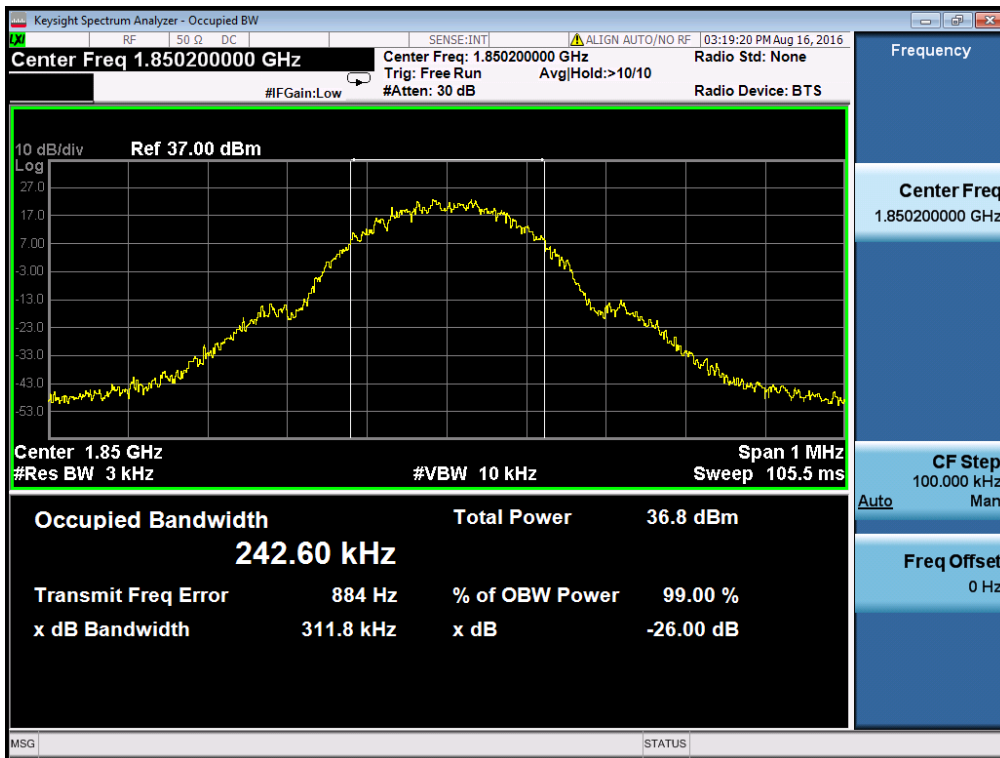

(Plot B1: GSM 1900MHz Channel = 512 Occupied bandwidth)

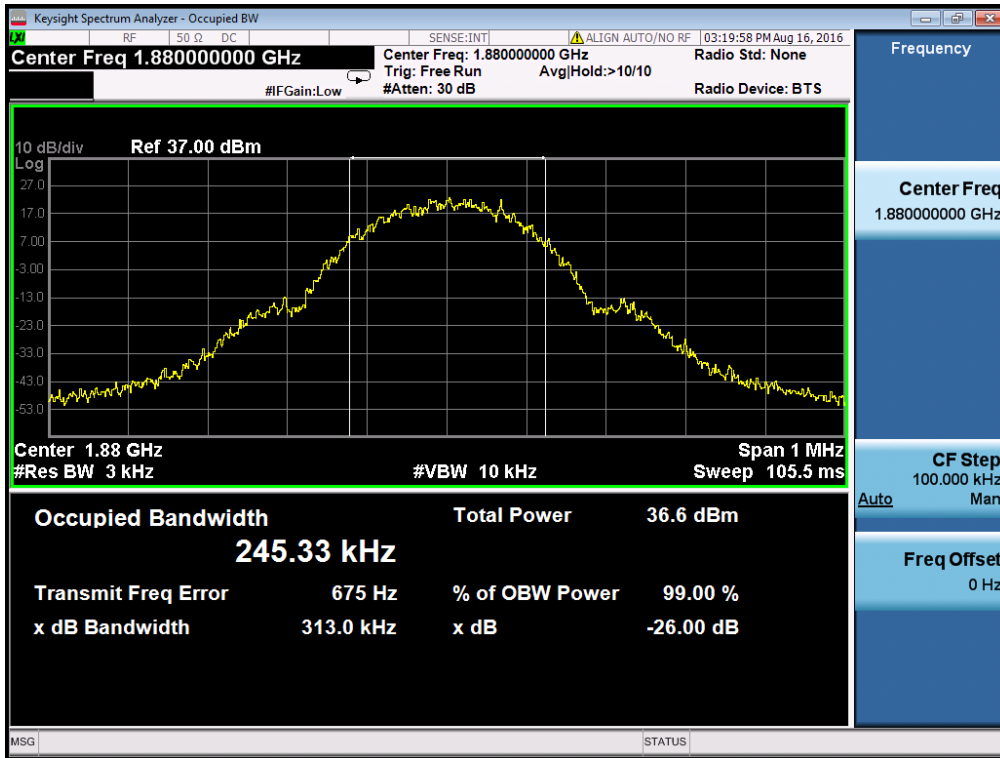

(Plot B2: GSM 1900MHz Channel = 661 Occupied bandwidth)

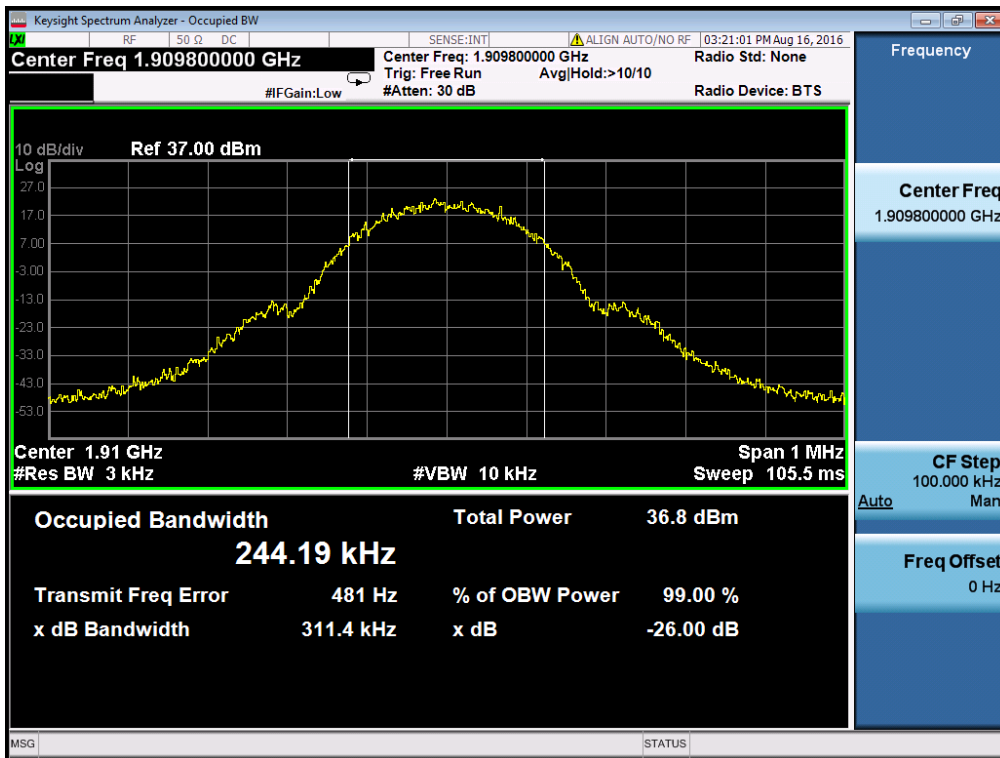

(Plot B3: GSM 1900MHz Channel = 810 Occupied bandwidth)

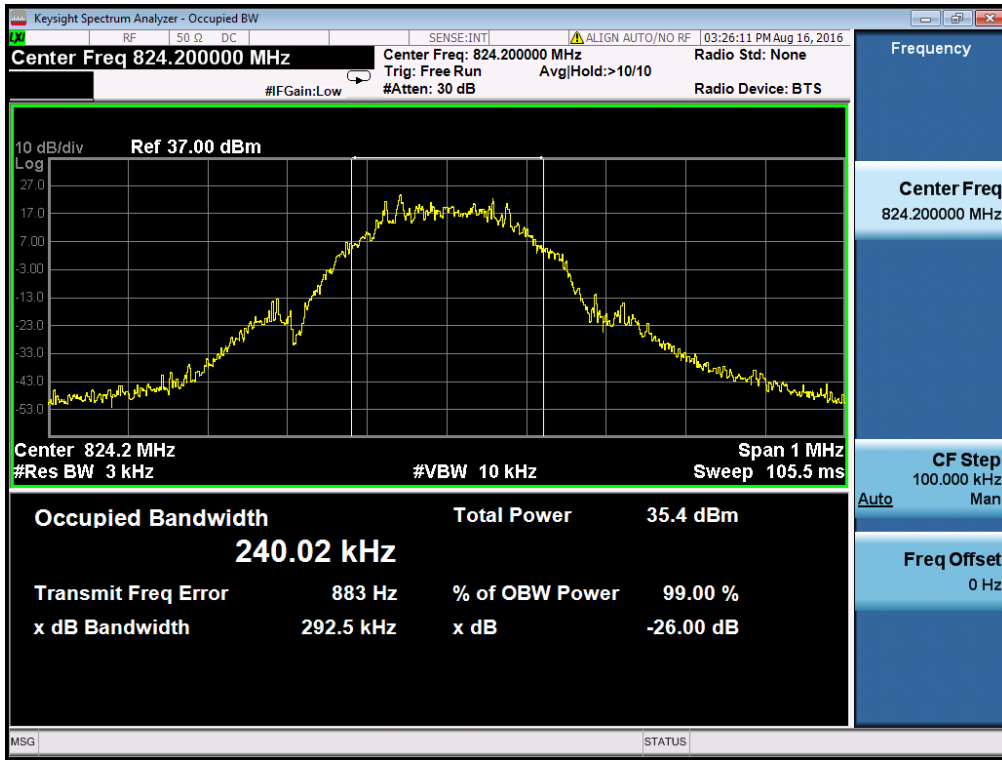

(Plot C1: EDGE 850MHz Channel = 128 Occupied bandwidth)

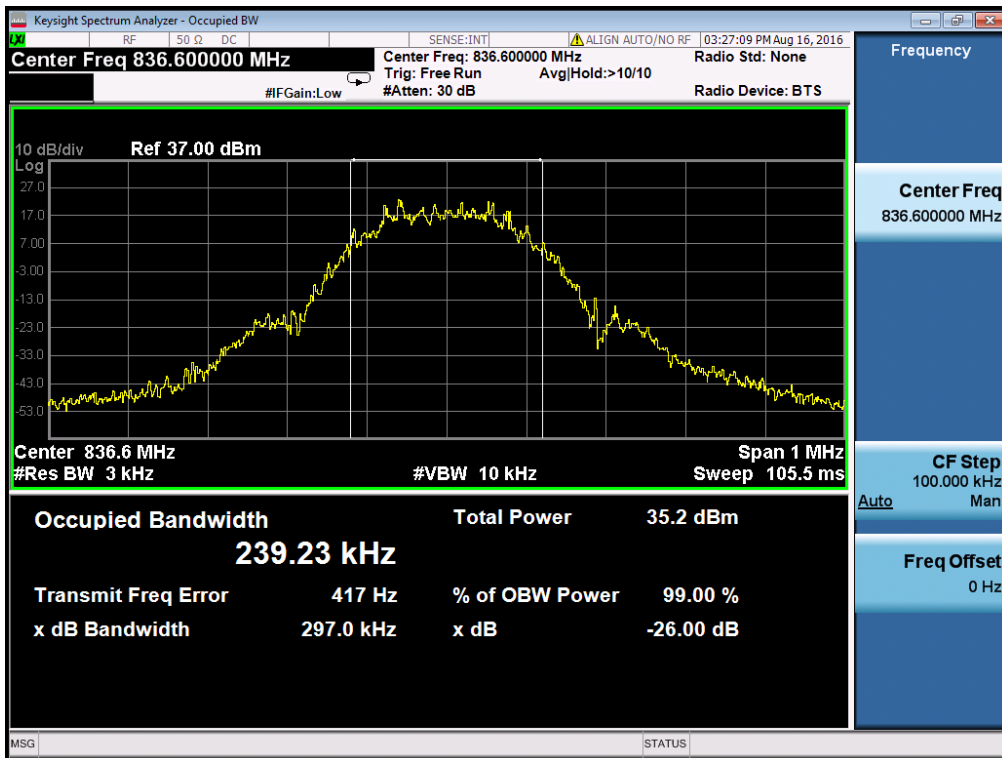

(Plot C2: EDGE 850MHz Channel = 190 Occupied bandwidth)



(Plot C3: EDGE 850MHz Channel = 251 Occupied bandwidth)

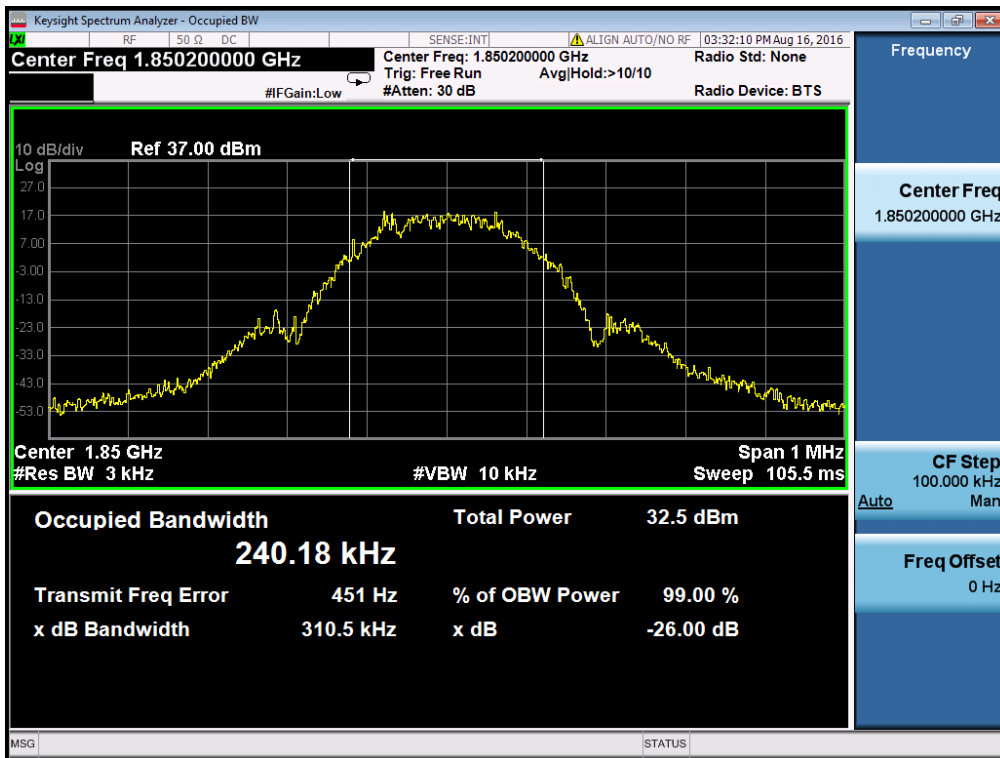

(Plot D1: EDGE 1900MHz Channel = 512 Occupied bandwidth)

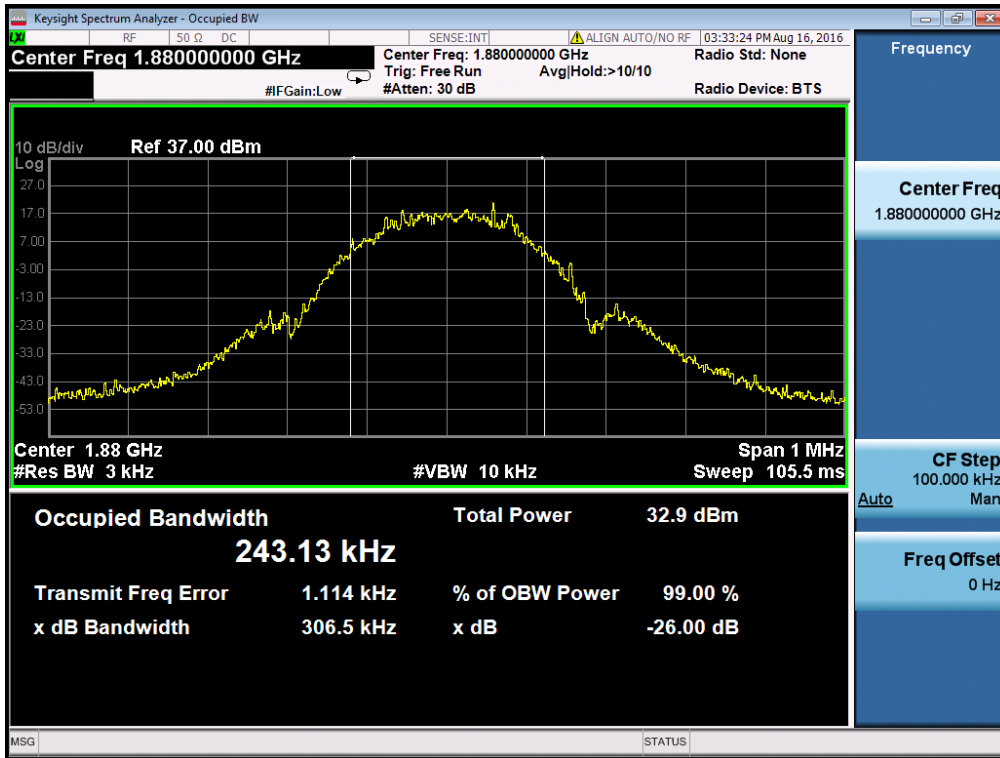

(Plot D2: EDGE 1900MHz Channel = 661 Occupied bandwidth)

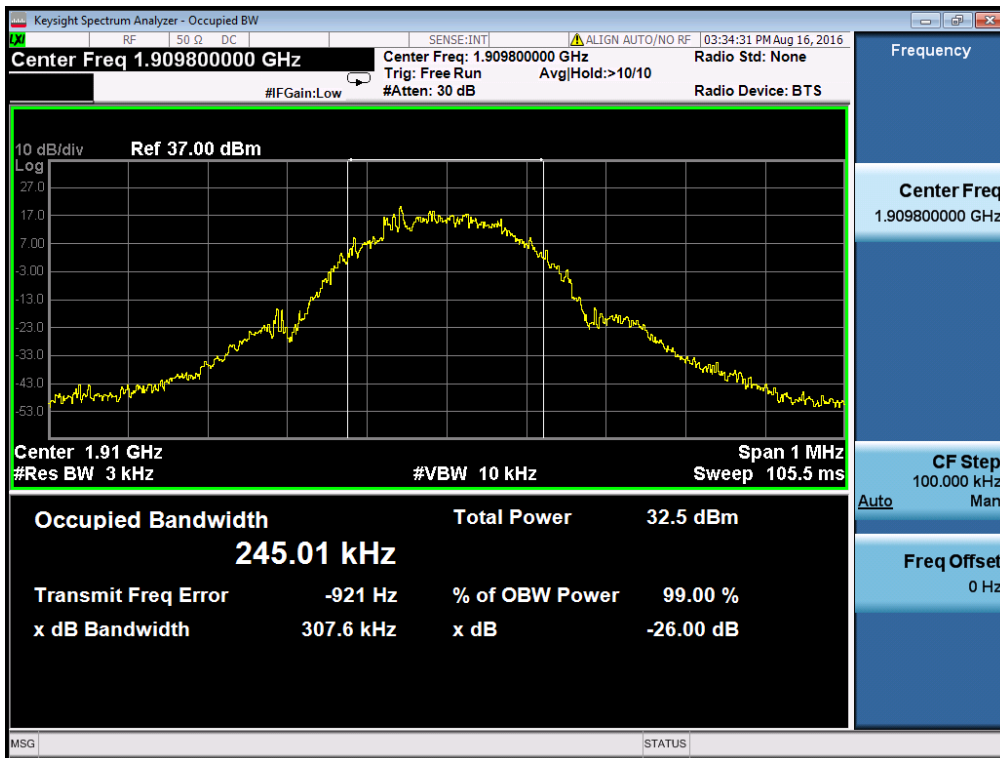

(Plot D3: EDGE 1900MHz Channel = 810 Occupied bandwidth)

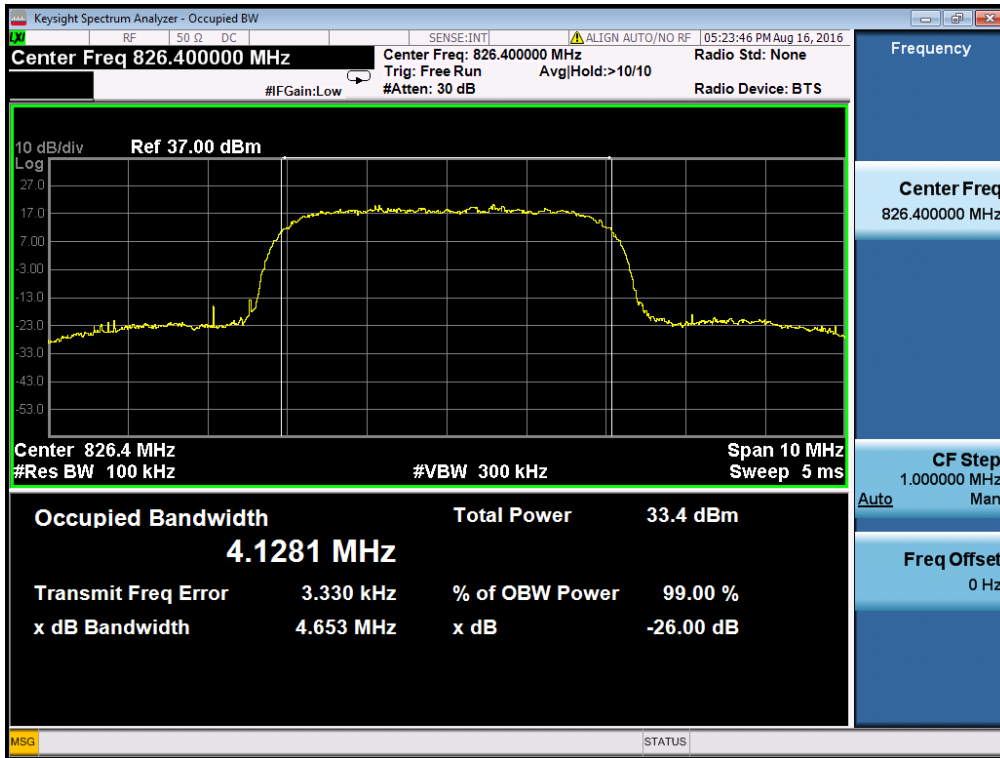

(Plot E1: WCDMA 850MHz Channel = 4132 Occupied bandwidth)

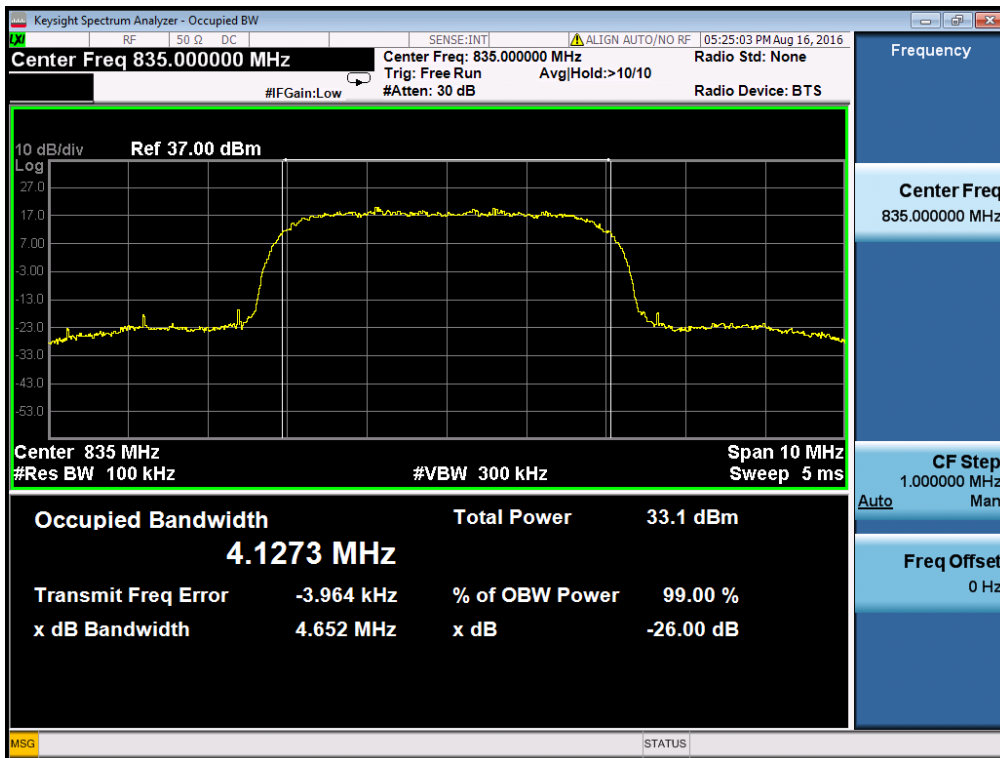

(Plot E2: WCDMA 850MHz Channel = 4183 Occupied bandwidth)

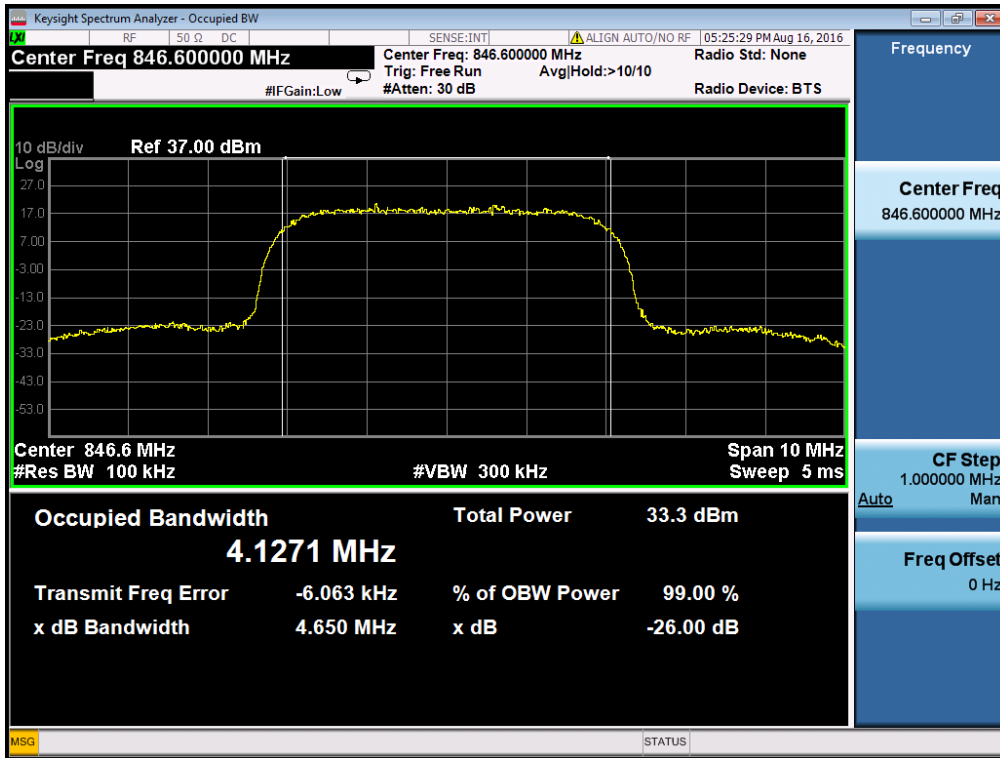

(Plot E3: WCDMA 850MHz Channel = 4233 Occupied bandwidth)

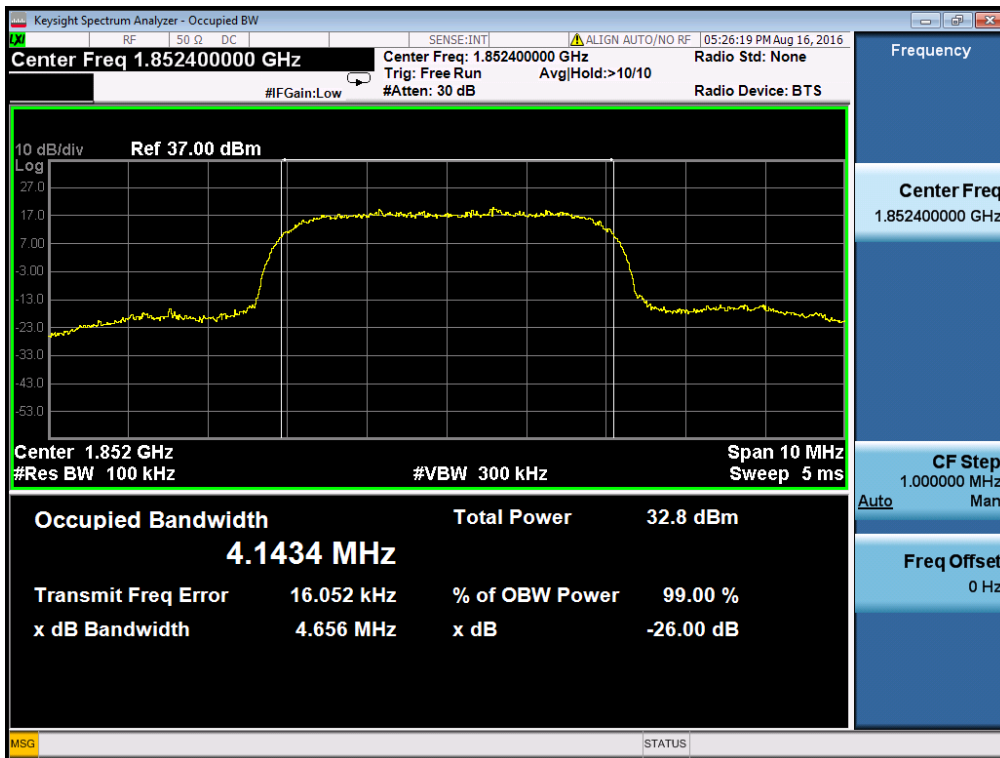

(Plot F1: WCDMA 1900MHz Channel = 9262 Occupied bandwidth)

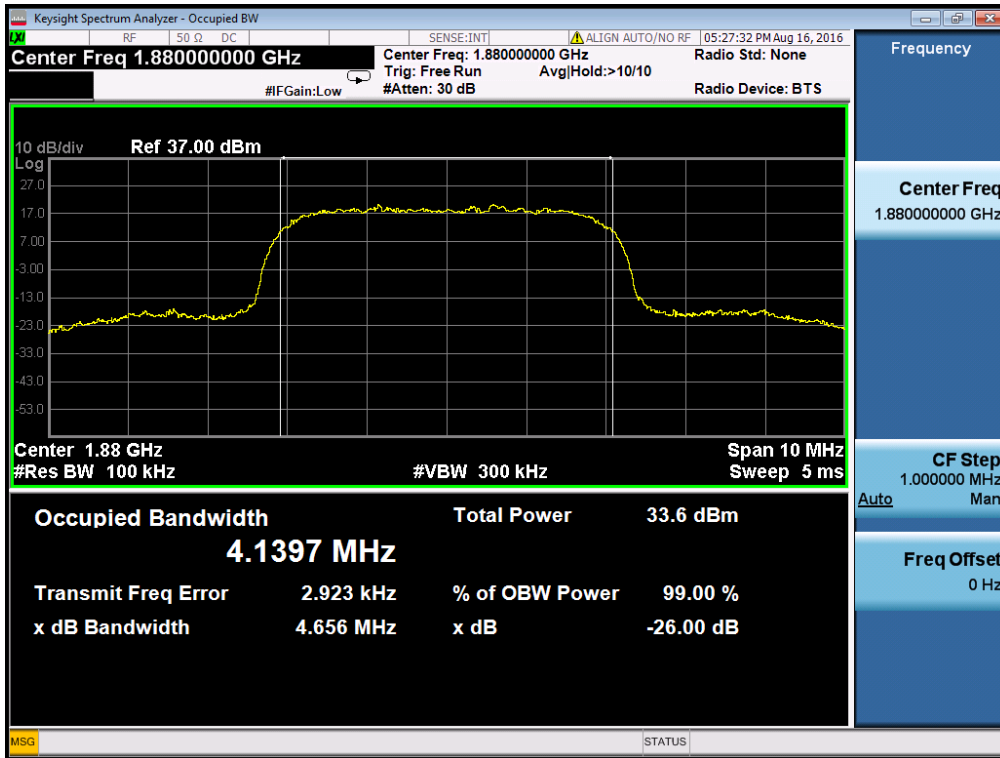

(Plot F2: WCDMA 1900MHz Channel = 9400 Occupied bandwidth)

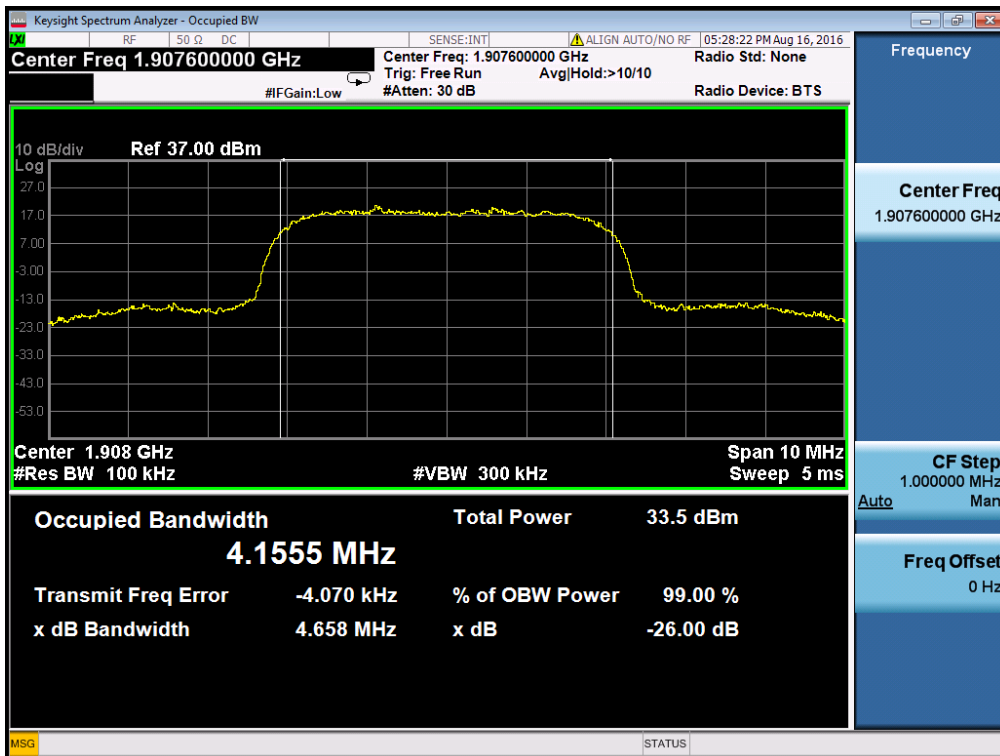

(Plot F3: WCDMA 1900MHz Channel = 9538 Occupied bandwidth)

2.4 Frequency Stability

2.4.1 Requirement

The frequency stability shall be measured by variation of ambient temperature and variation of primary supply voltage to ensure that the fundamental emission stays within the authorized frequency block. The frequency stability of the transmitter shall be maintained within $\pm 0.00025\%$ ($\pm 2.5\text{ppm}$) of the center frequency.

2.4.2 Measuring Instruments

The measuring equipment is listed in the section 3 of this test report.

2.4.3 Test Procedures for Temperature Variation

1. The testing follows FCC KDB 971168 D01v02r02 Section 9.0.
2. The EUT was set up in the thermal chamber and connected with the system simulator.
3. With power OFF, the temperature was decreased to -30°C and the EUT was stabilized before testing. Power was applied and the maximum change in frequency was recorded within one minute.
4. With power OFF, the temperature was raised in 10°C steps up to 50°C . The EUT was stabilized at each step for at least half an hour. Power was applied and the maximum frequency change was recorded within one minute.

2.4.4 Test Procedures for Voltage Variation

1. The testing follows FCC KDB 971168 D01v02r02 Section 9.0.
2. The EUT was placed in a temperature chamber at $25\pm 5^{\circ}\text{C}$ and connected with the system simulator.
3. The power supply voltage to the EUT was varied from BEP to 115% of the nominal value measured at the input to the EUT.
4. The variation in frequency was measured for the worst case.

2.4.5 Test Setup

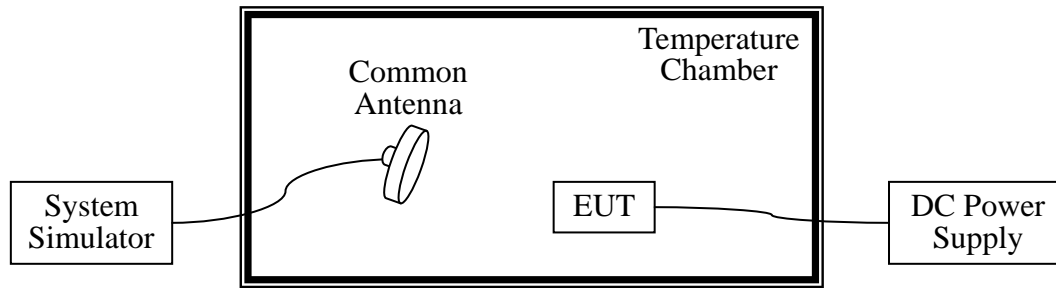

2.4.6 Test Results of Frequency Stability

1. GSM 850MHz Band

Band:	GSM 850	Channel:	190
Limit(ppm):	2.5	Frequency:	836.6MHz

Power (VDC)	Temperature (°C)	GSM		EDGE		Result
		Freq. Dev. (Hz)	Deviation (ppm)	Freq. Dev. (Hz)	Deviation (ppm)	
3.7	-30	18	0.02	12	0.01	PASS
	-20	20	0.02	19	0.02	
	-10	25	0.03	17	0.02	
	0	10	0.01	13	0.01	
	+10	11	0.01	26	0.03	
	+20	19	0.02	19	0.02	
	+30	17	0.02	12	0.01	
	+40	25	0.03	25	0.03	
	+50	8	0.01	10	0.01	
4.2	+25	11	0.01	26	0.03	
3.6	+25	26	0.03	19	0.02	

2. GSM 1900MHz Band

Band:	GSM 1900	Channel:	661
Limit(ppm):	2.5	Frequency:	1880.0MHz

Power (VDC)	Temperature (°C)	GSM		EDGE		Result
		Freq. Dev. (Hz)	Deviation (ppm)	Freq. Dev. (Hz)	Deviation (ppm)	
3.7	-30	38	0.02	59	0.03	PASS
	-20	47	0.02	22	0.01	
	-10	26	0.01	45	0.02	
	0	57	0.03	23	0.01	
	+10	44	0.02	45	0.02	
	+20	22	0.01	25	0.01	
	+30	41	0.02	46	0.02	
	+40	56	0.03	24	0.01	
	+50	25	0.01	58	0.03	
4.2	+25	58	0.03	23	0.01	
3.6	+25	22	0.01	57	0.03	

3. WCDMA 850MHz Band

Band:	WCDMA Band V	Channel:	4183
Limit(ppm):	2.5	Frequency:	836.6MHz

Power (VDC)	Temperature (°C)	RMC 12.2Kbps		Result
		Freq. Dev. (Hz)	Deviation (ppm)	
3.7	-30	15	0.02	PASS
	-20	16	0.02	
	-10	27	0.03	
	0	17	0.02	
	+10	18	0.02	
	+20	8	0.01	
	+30	17	0.02	
	+40	11	0.01	
	+50	25	0.03	
4.2	+25	19	0.02	
3.6	+25	26	0.03	

4. WCDMA 1900MHz Band

Band:	WCDMA Band II	Channel:	9400
Limit(ppm):	2.5	Frequency:	1880.0MHz

Power (VDC)	Temperature (°C)	RMC 12.2Kbps		Result
		Freq. Dev. (Hz)	Deviation (ppm)	
3.7	-30	54	0.03	PASS
	-20	37	0.02	
	-10	22	0.01	
	0	18	0.01	
	+10	45	0.02	
	+20	21	0.01	
	+30	57	0.03	
	+40	38	0.02	
	+50	15	0.01	
4.2	+25	54	0.03	
3.6	+25	21	0.01	

2.5 Conducted Out of Band Emissions

2.5.1 Requirement

The power of any emission outside of the authorized operating frequency ranges must be lower than the transmitter power (P) by a factor of at least $43 + 10 \log (P)$ dB.

It is measured by means of a calibrated spectrum analyzer and scanned from 30 MHz up to a frequency including its 10th harmonic.

2.5.2 Measuring Instruments

The measuring equipment is listed in the section 3 of this test report.

2.5.3 Test Procedures

1. The testing follows FCC KDB 971168 D01v02r02 Section 6.0.
2. The EUT was connected to the spectrum analyzer and system simulator via a power divider.
3. The RF output of EUT was connected to the spectrum analyzer by an RF cable and attenuator.

The path loss was compensated to the results for each measurement.

4. The middle channel for the highest RF power within the transmitting frequency was measured.
5. The conducted spurious emission for the whole frequency range was taken.
6. The RF fundamental frequency should be excluded against the limit line in the operating frequency band.

7. The limit line is derived from $43 + 10\log(P)$ dB below the transmitter power P(Watts)

$$= P(W) - [43 + 10\log(P)] \text{ (dB)}$$

$$= [30 + 10\log(P)] \text{ (dBm)} - [43 + 10\log(P)] \text{ (dB)}$$

$$= -13\text{dBm.}$$

8. For 9KHz to 30MHz: the amplitude of spurious emissions are attenuated by more than 20dB below the permissible value has no need to be reported.

2.5.4 Test Setup

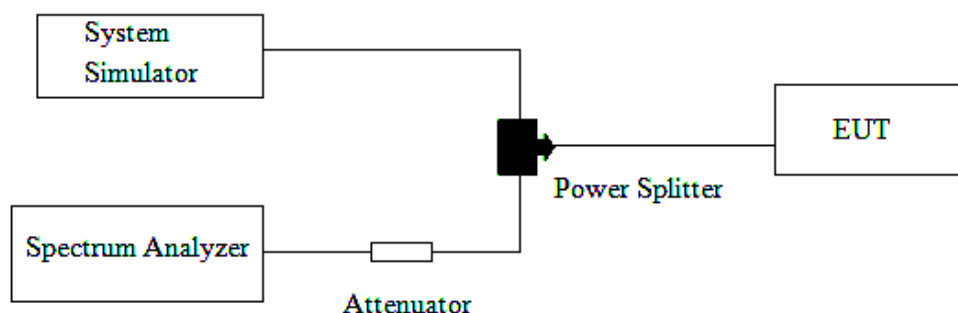

2.5.5 Test Result (Plots) of Conducted Spurious Emission

Note: For 9 KHz to 30MHz: the amplitude of spurious emissions is attenuated by more than 20dB below the permissible value, so we not provide the test result here.

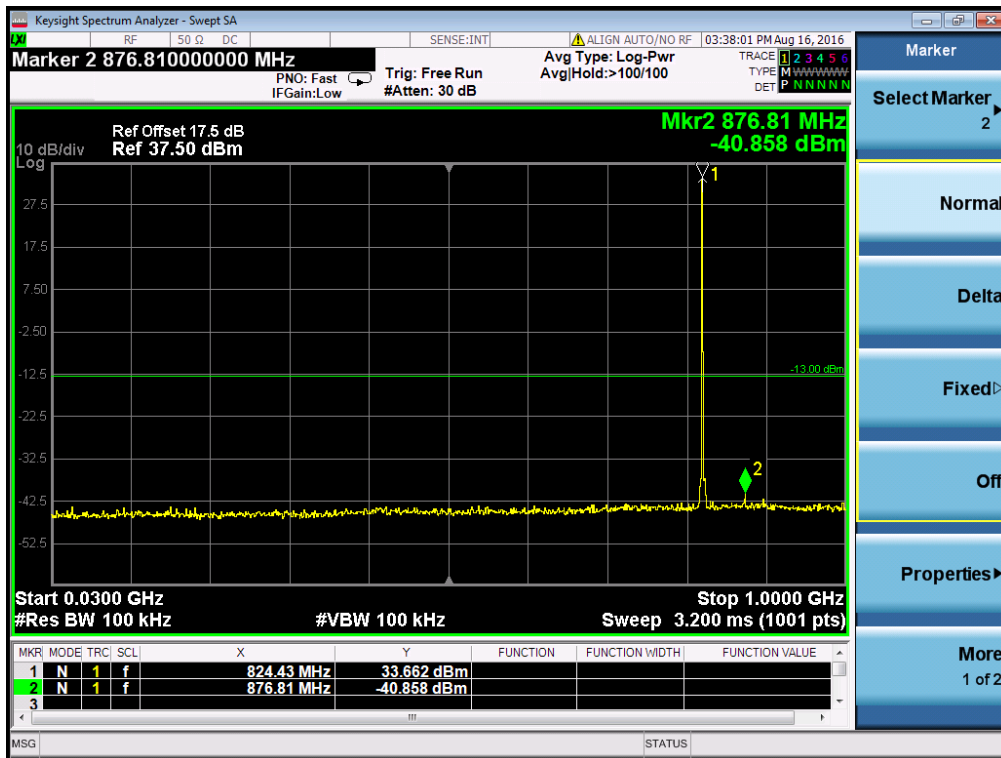

GSM 850MHz Channel = 128, 30MHz to 1GHz

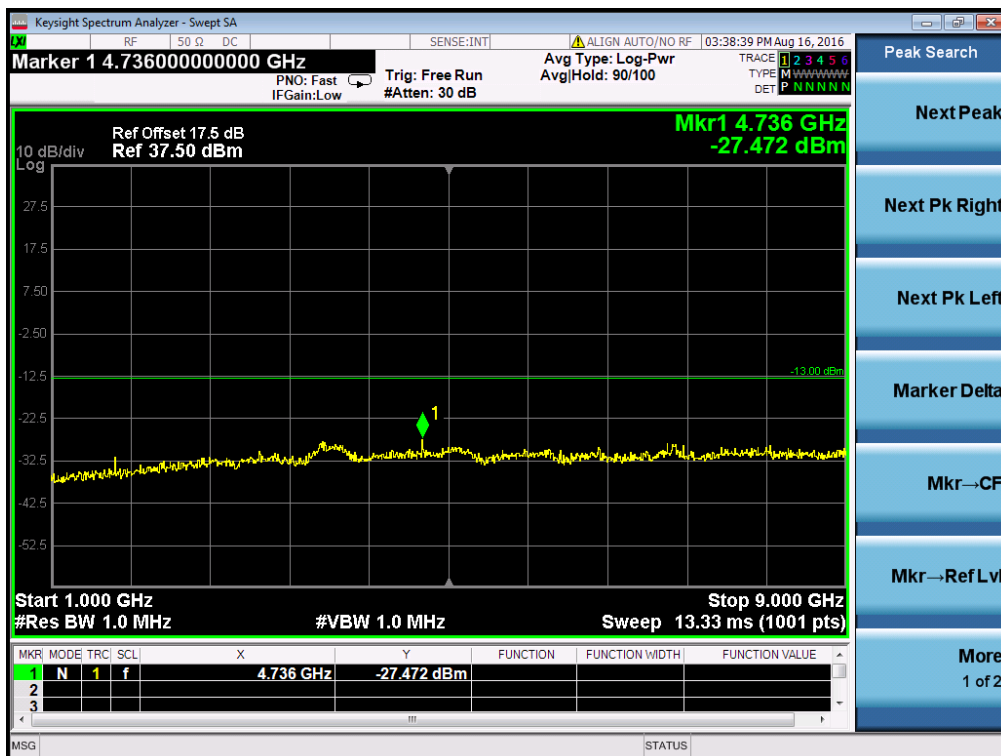

GSM 850MHz Channel = 128, 1GHz to 9GHz

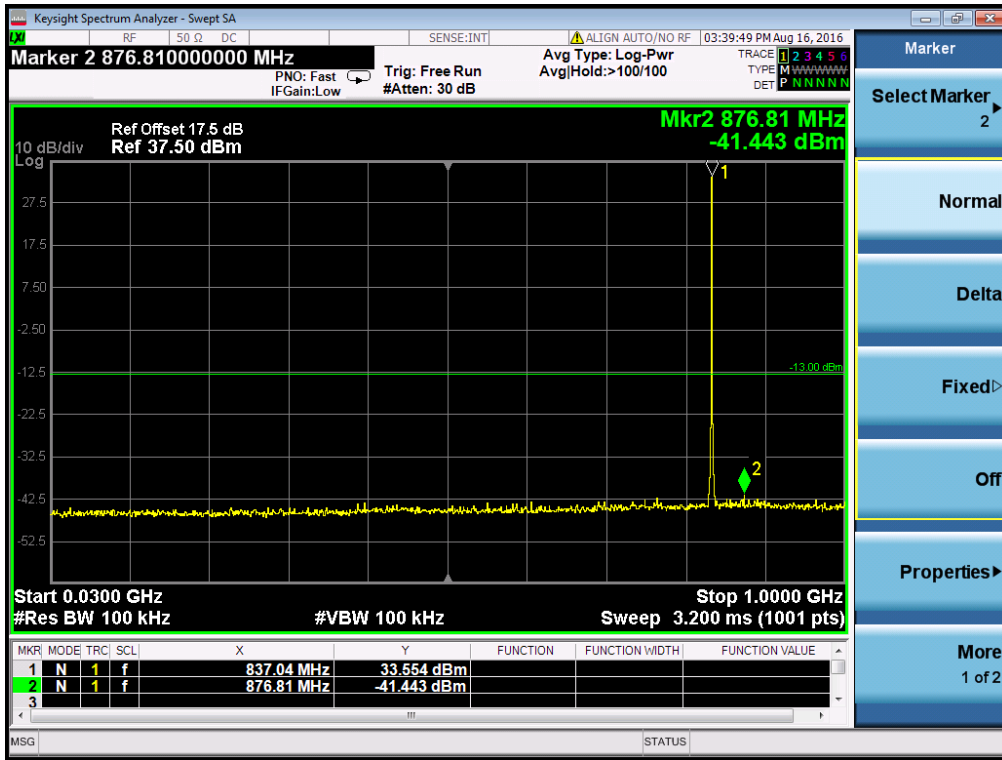

GSM 850MHz Channel = 190, 30MHz to 1GHz

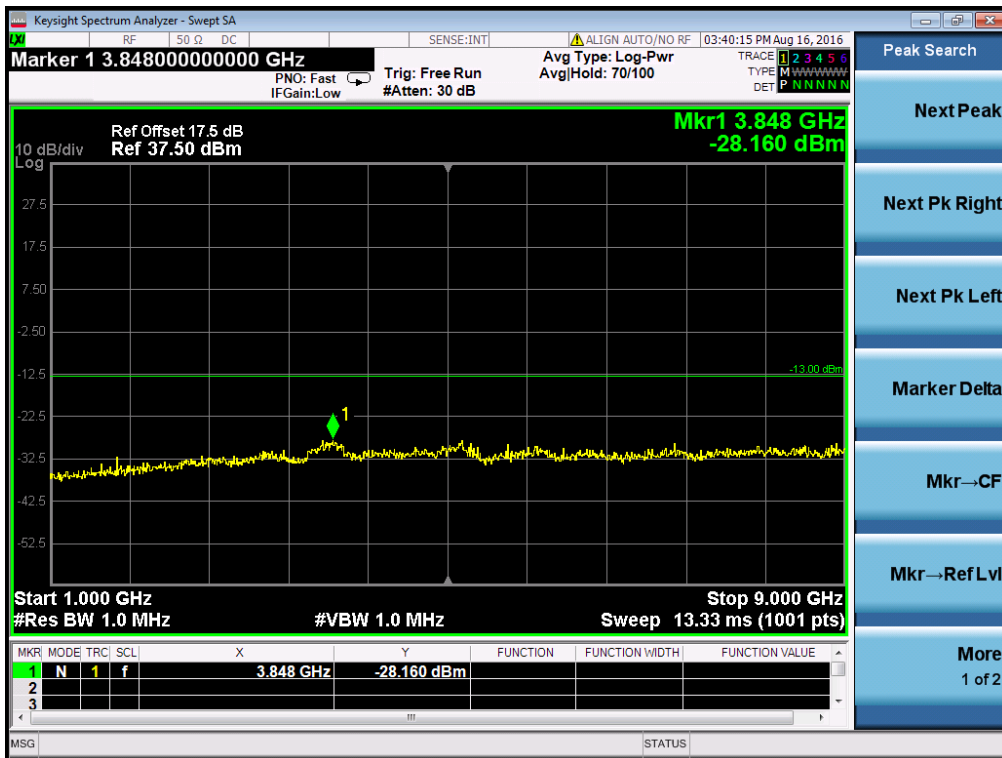

GSM 850MHz Channel = 190, 1GHz to 9GHz

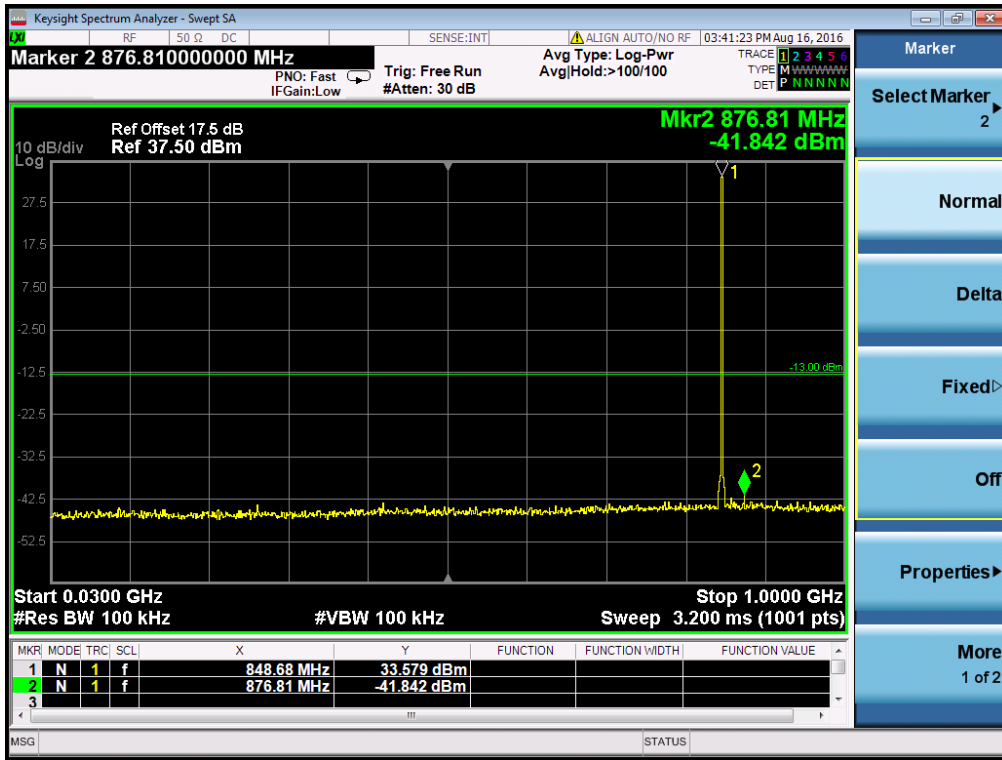

GSM 850MHz Channel = 251, 30MHz to 1GHz

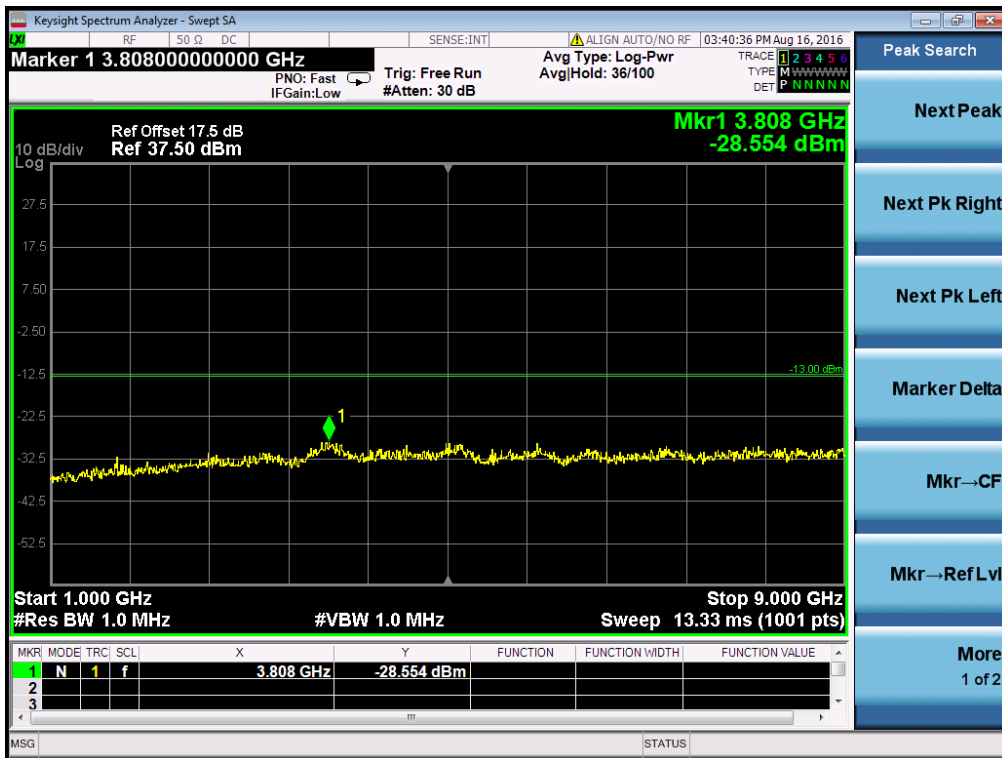

GSM 850MHz Channel = 251, 1GHz to 9GHz

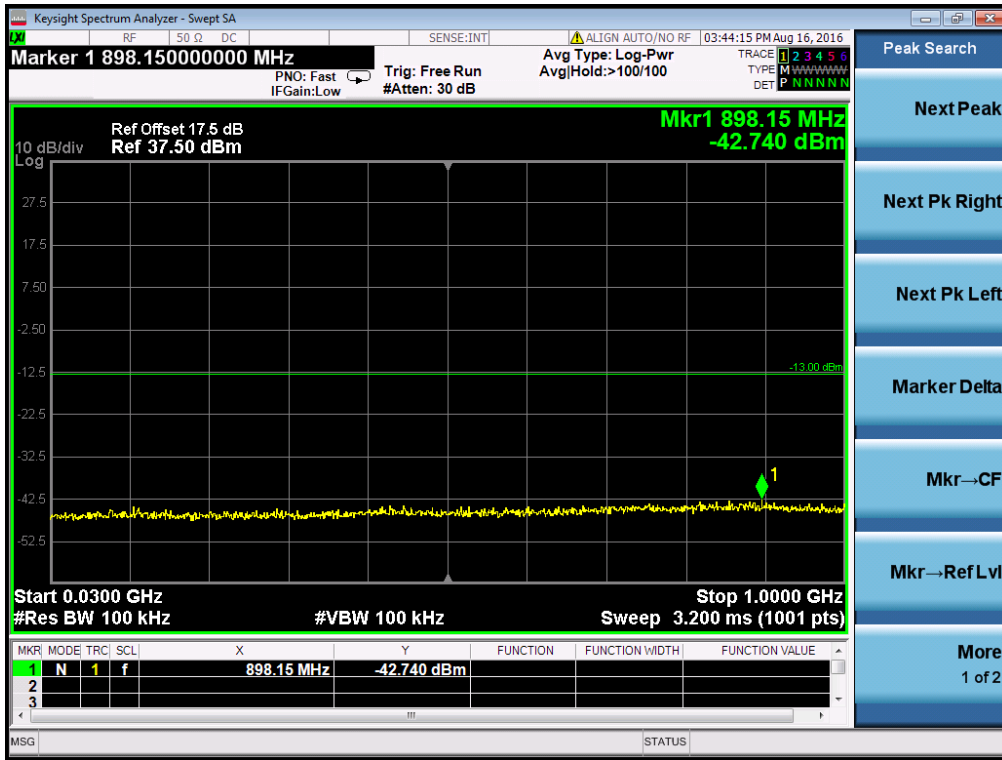

GSM 1900MHz Channel = 512, 30MHz to 1GHz

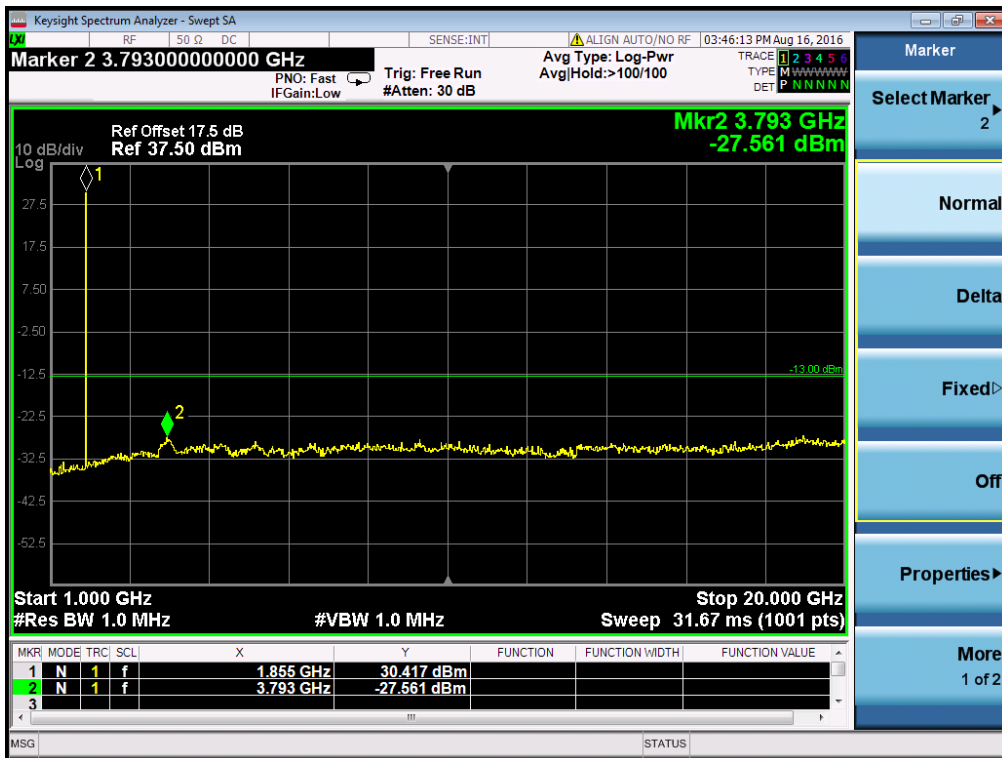

GSM 1900MHz Channel = 512, 1GHz to 20GHz

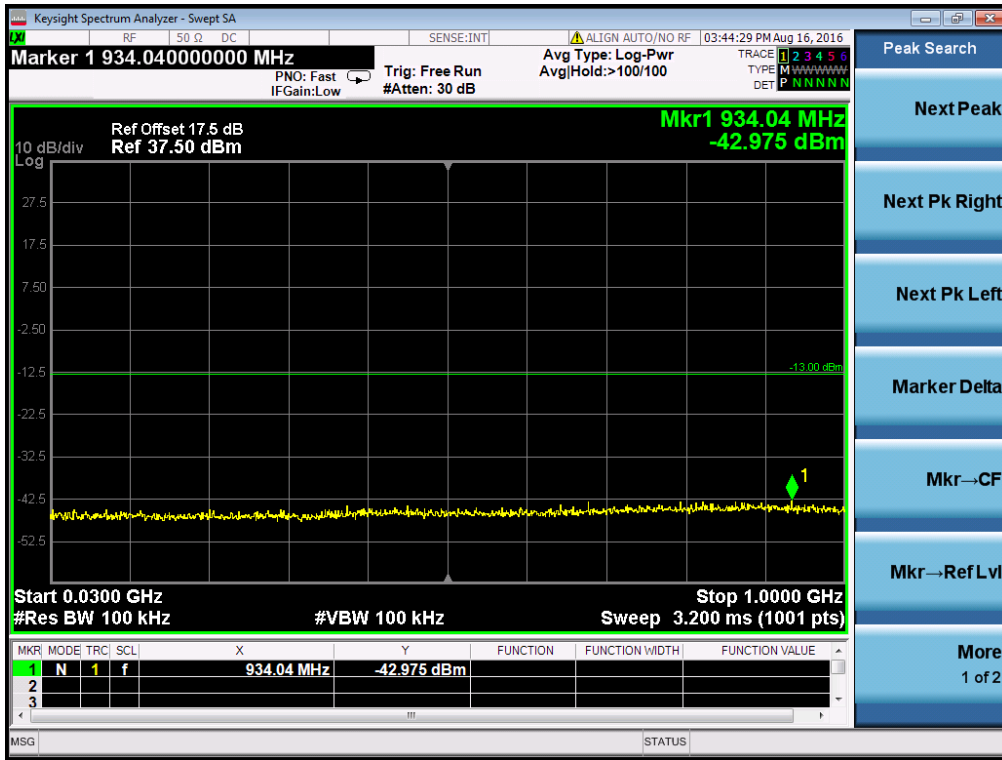

GSM 1900MHz Channel = 661, 30MHz to 1GHz

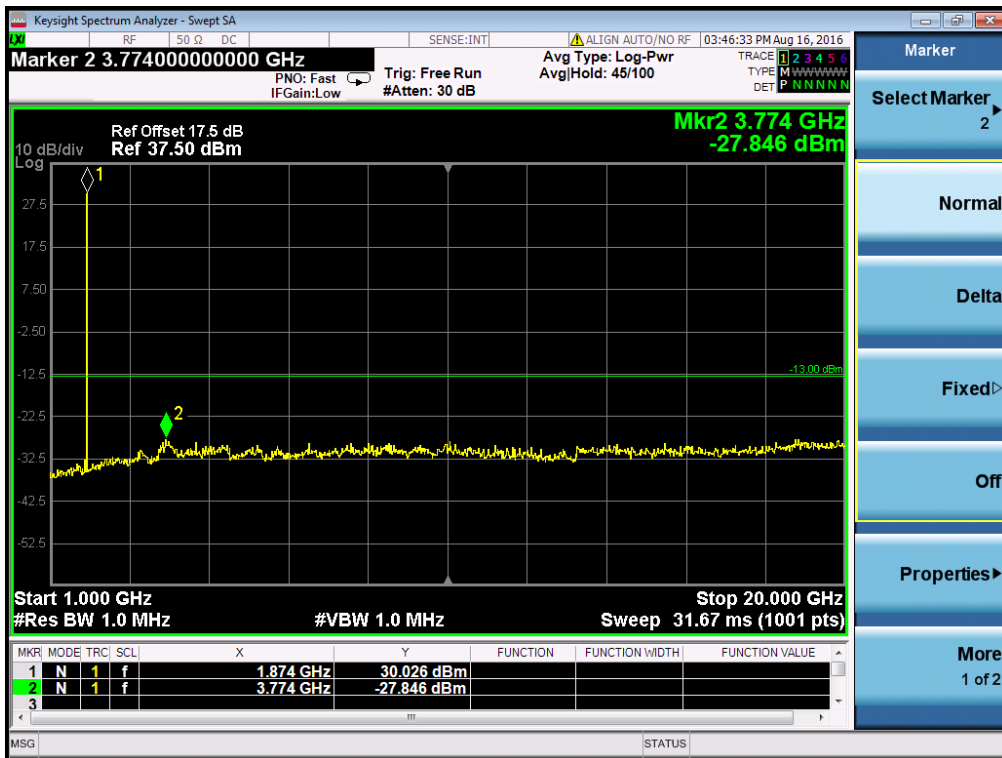

GSM 1900MHz Channel = 661, 1GHz to 20GHz

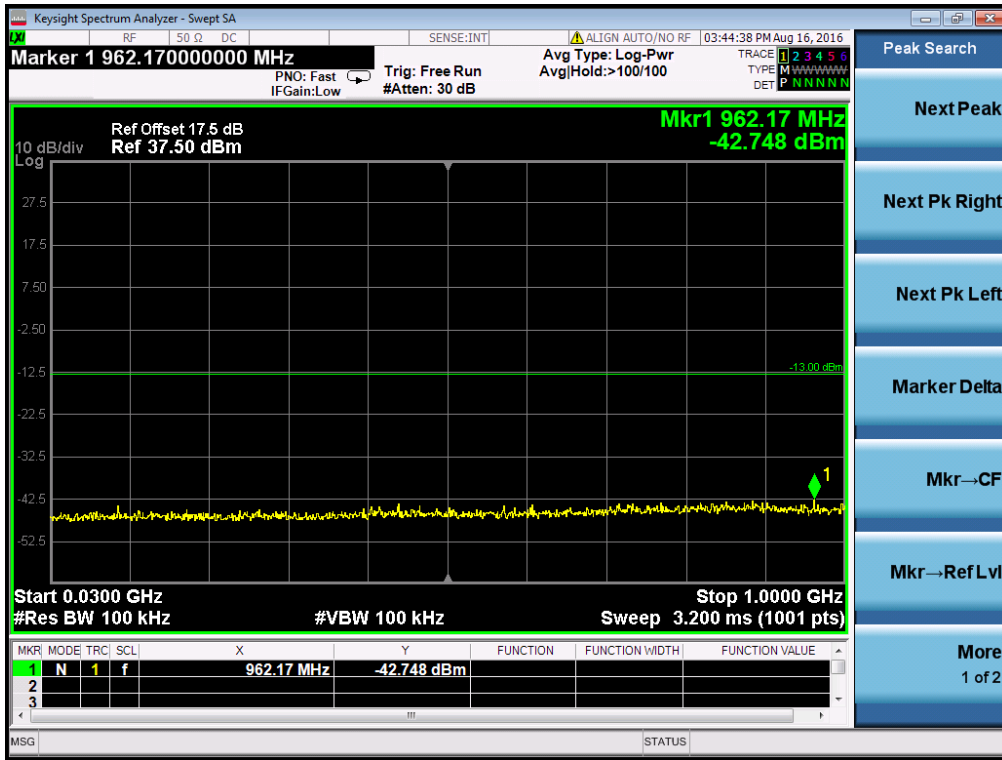

GSM 1900MHz Channel = 810, 30MHz to 1GHz

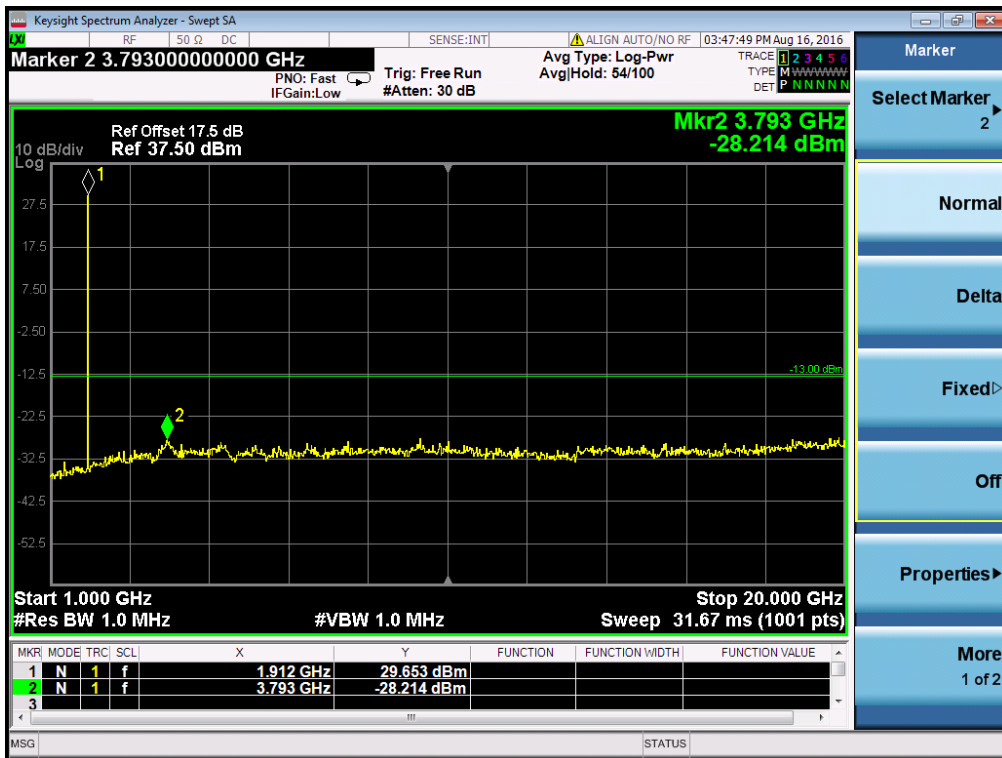

GSM 1900MHz Channel = 810, 1GHz to 20GHz

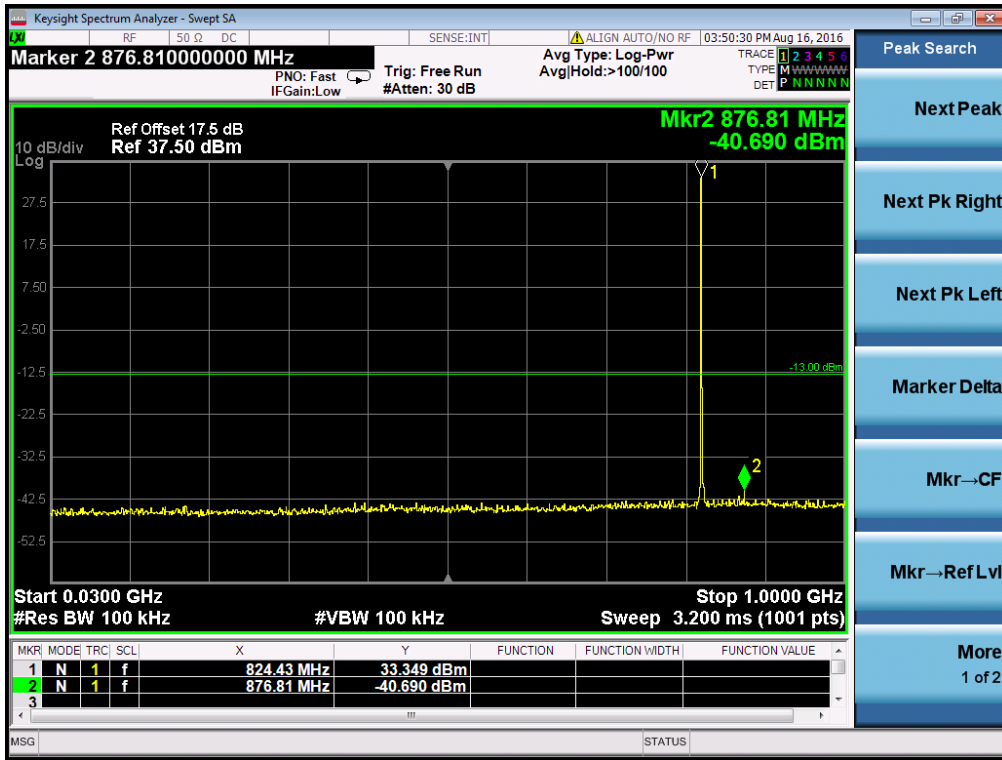

EDGE 850MHz Channel = 128, 30MHz to 1GHz

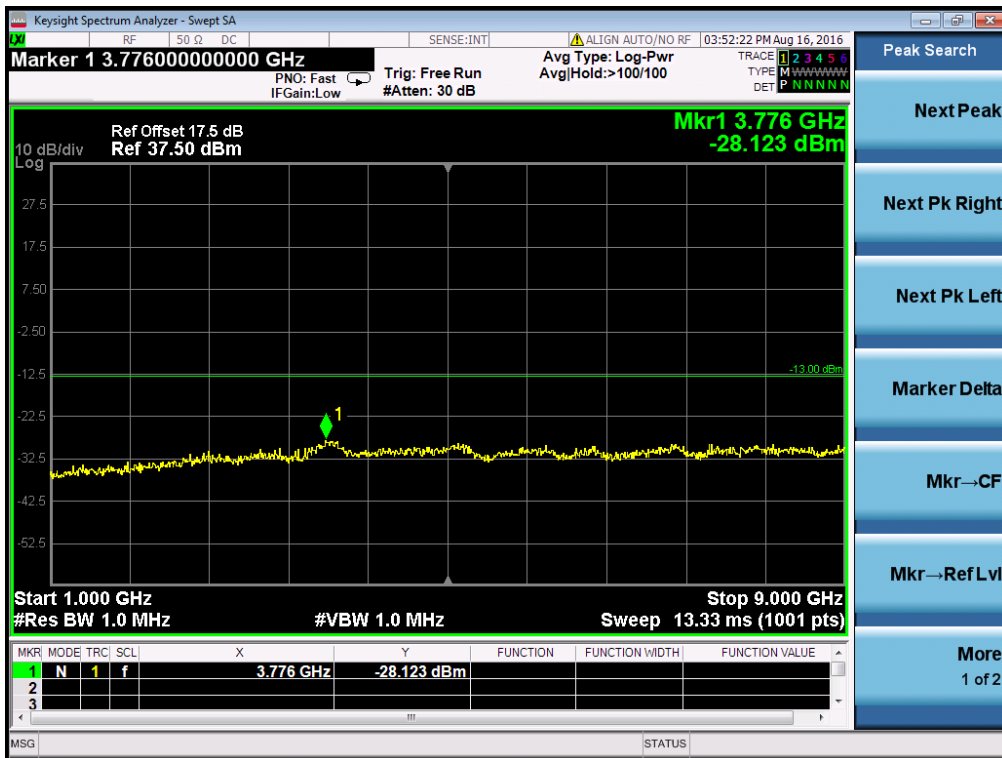

EDGE 850MHz Channel = 128, 1GHz to 9GHz

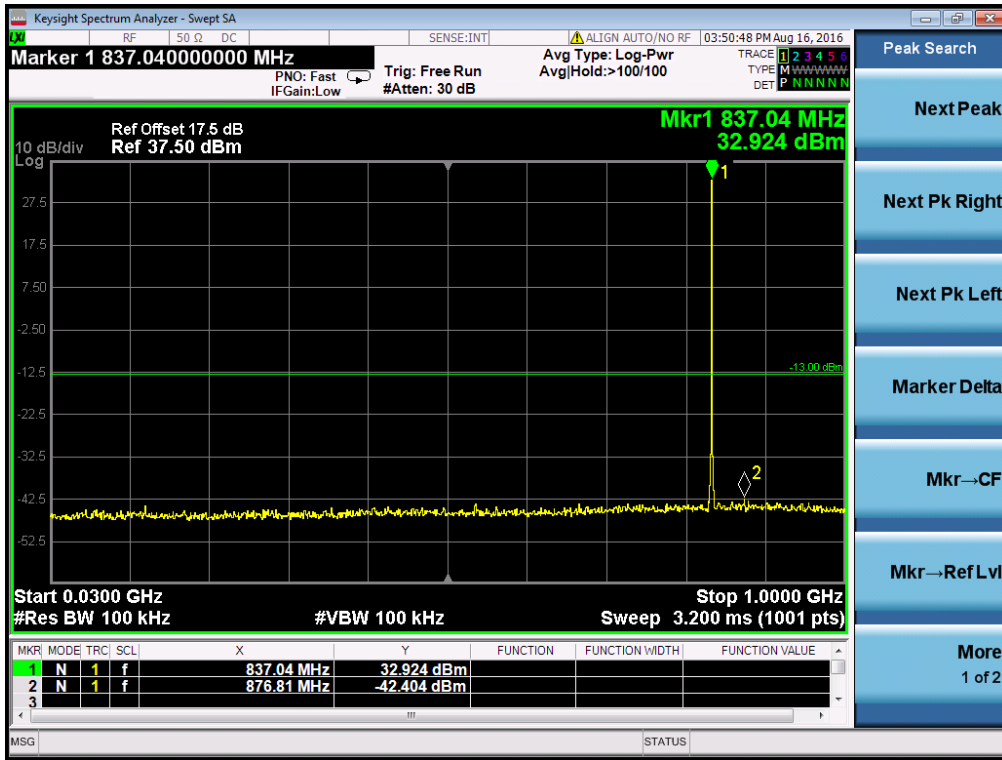

EDGE 850MHz Channel = 190, 30MHz to 1GHz

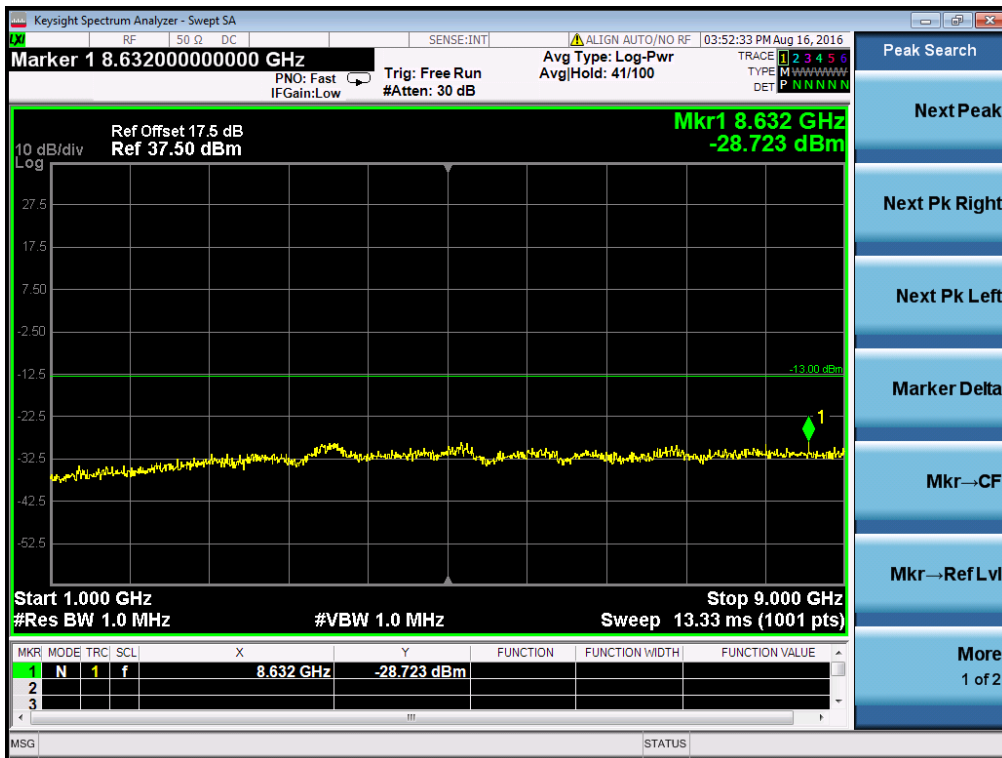

EDGE 850MHz Channel = 190, 1GHz to 9GHz

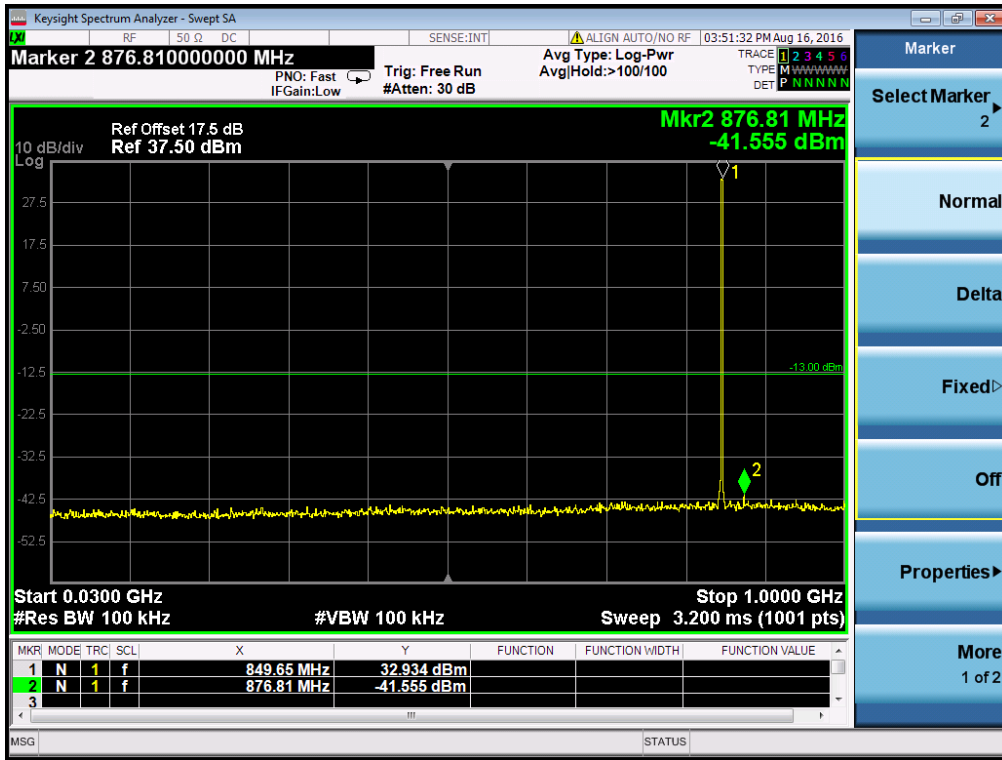

EDGE 850MHz Channel = 251, 30MHz to 1GHz

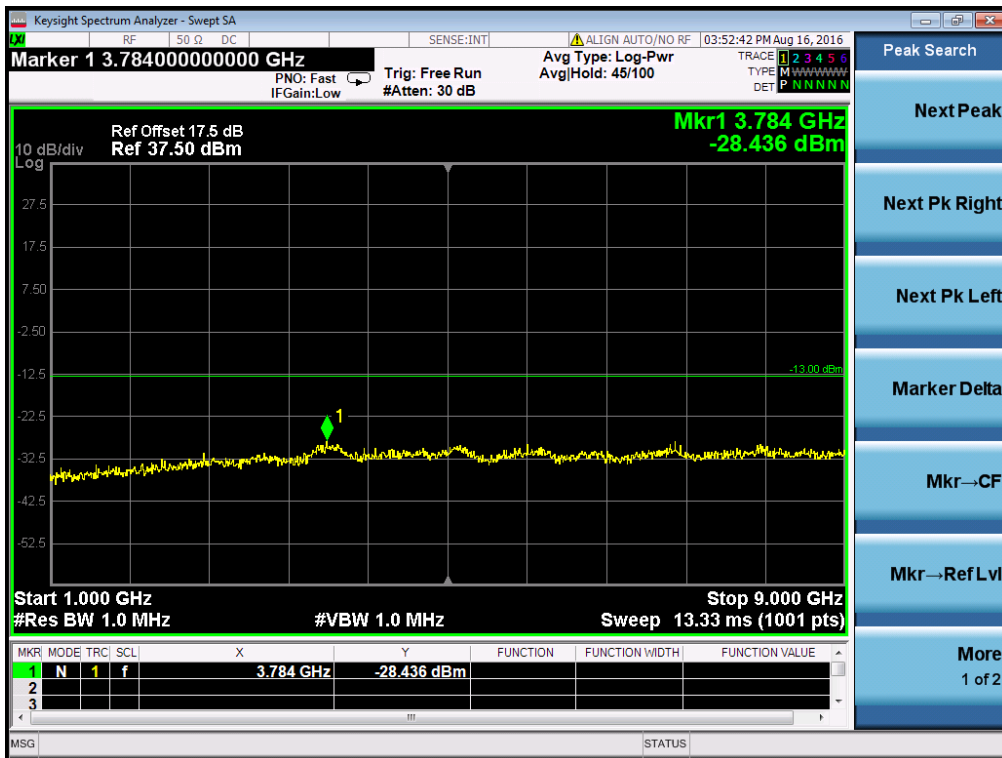

EDGE 850MHz Channel = 251, 1GHz to 9GHz

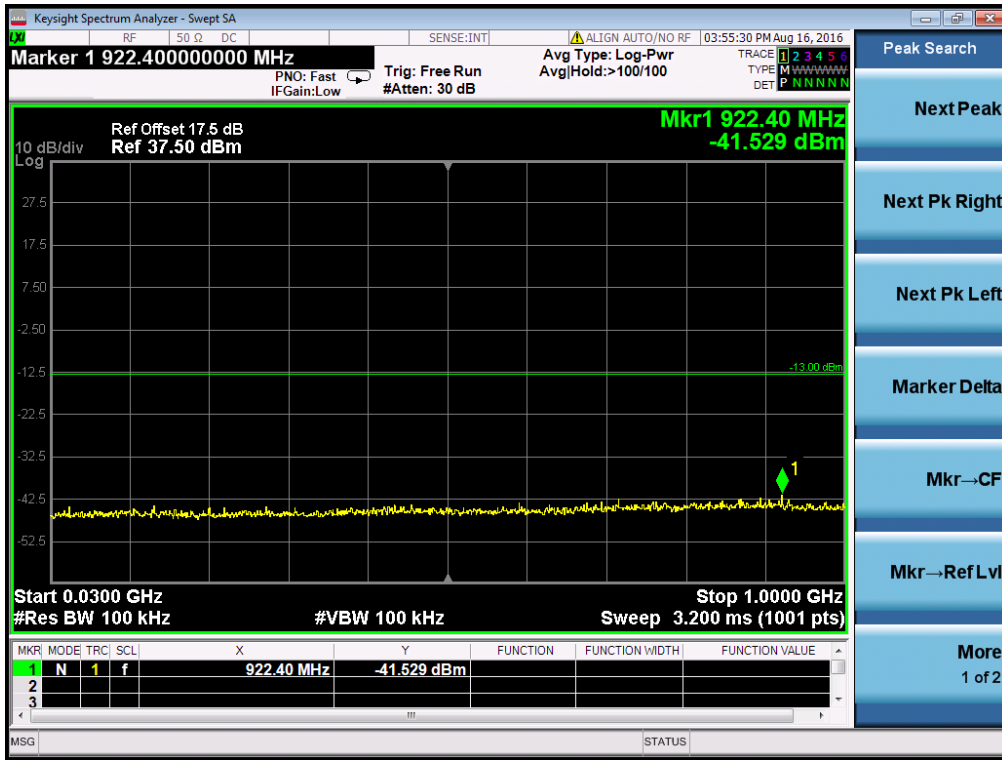

EDGE 1900MHz Channel = 512, 30MHz to 1GHz

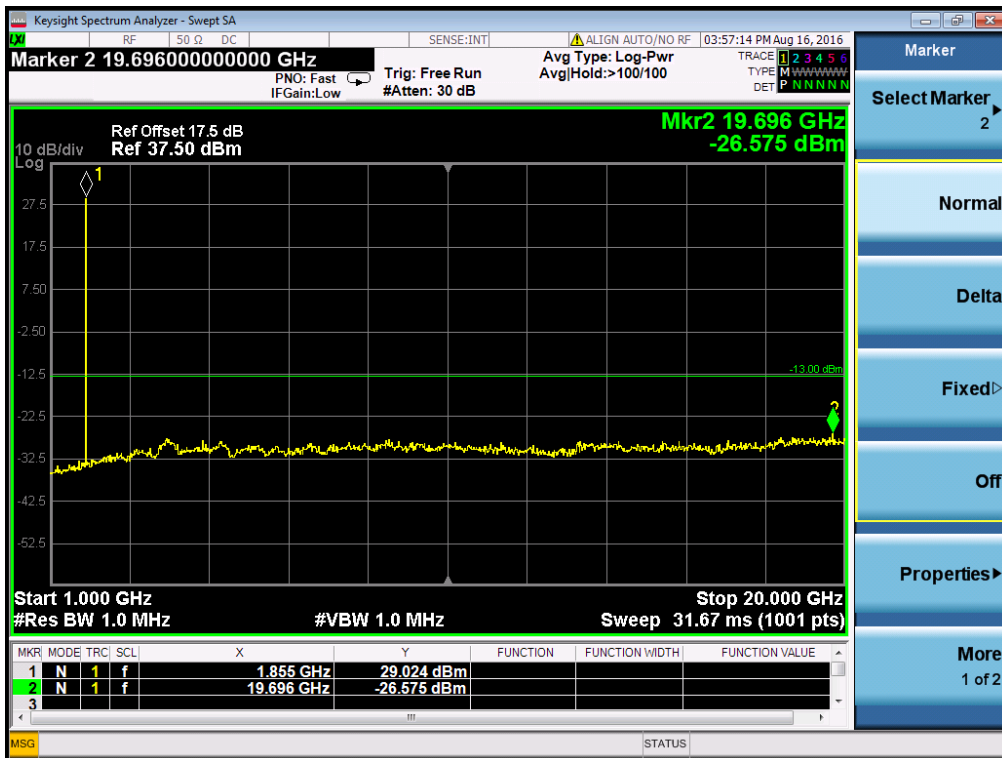

EDGE 1900MHz Channel = 512, 1GHz to 20GHz

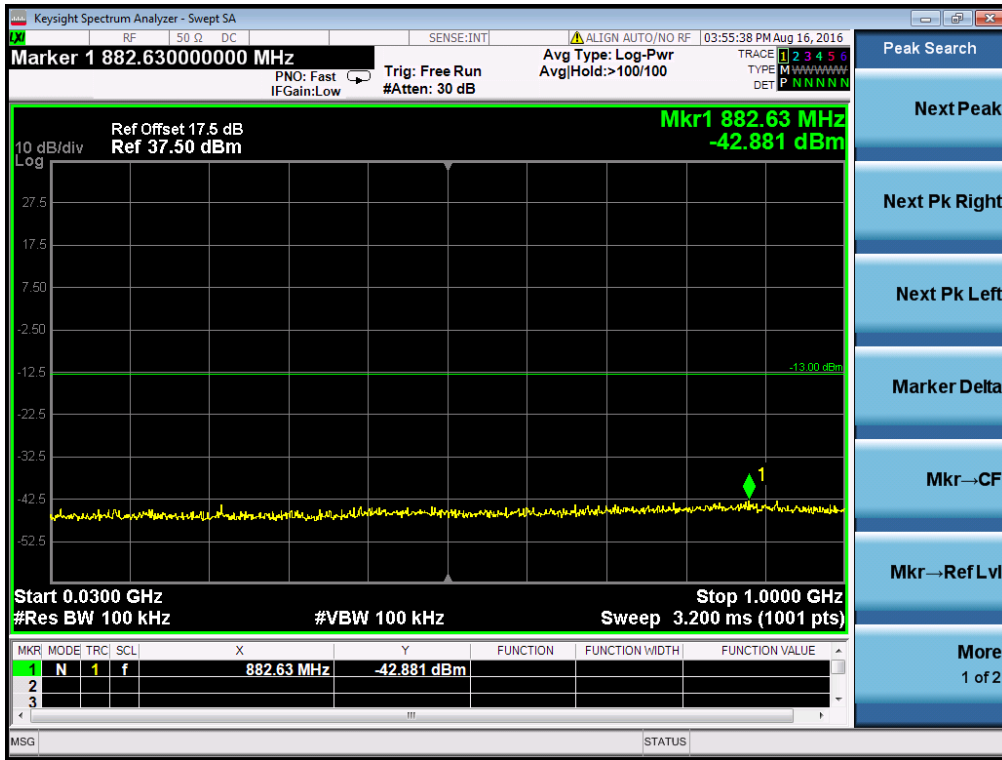

EDGE 1900MHz Channel = 661, 30MHz to 1GHz

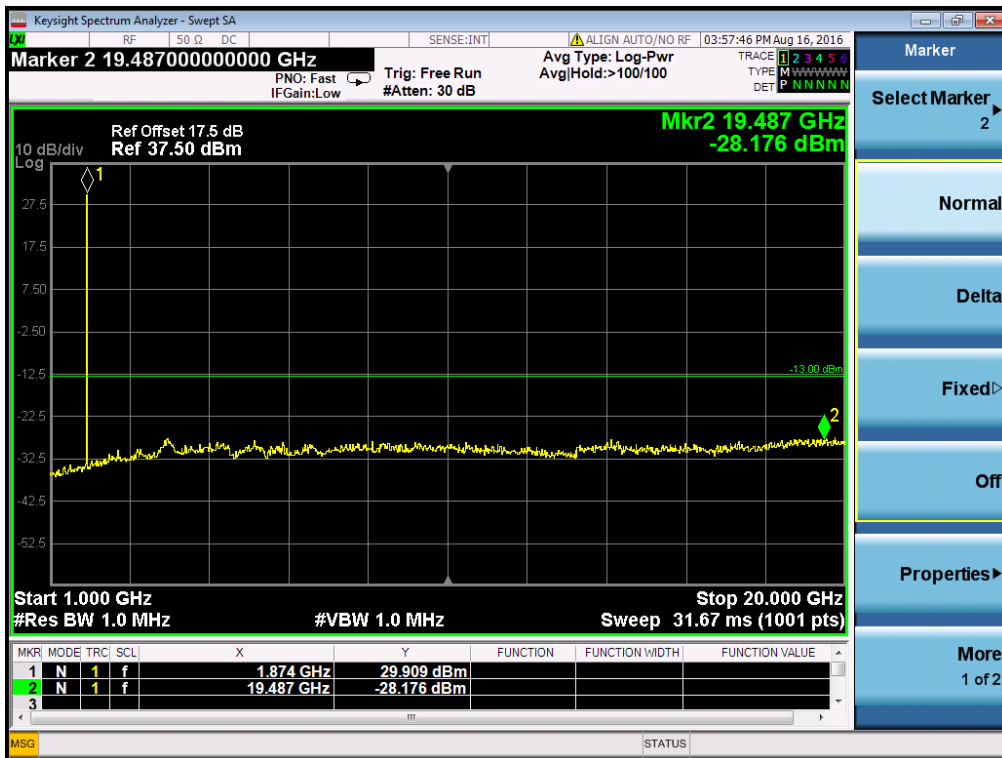

EDGE 1900MHz Channel = 661, 1GHz to 20GHz

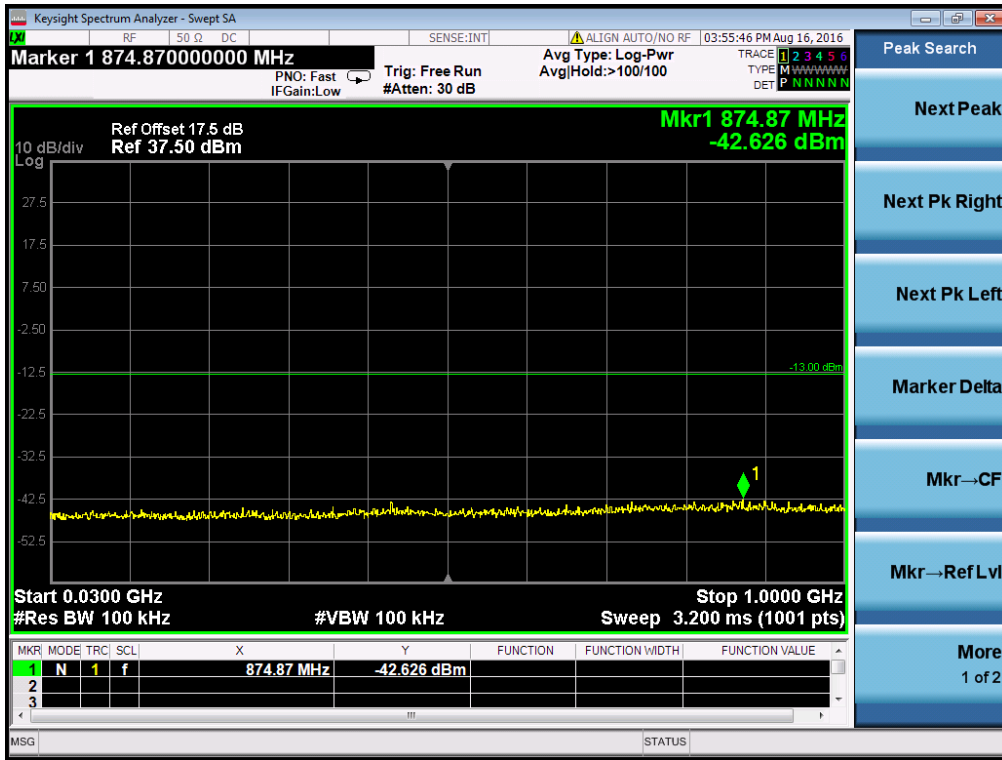

EDGE 1900MHz Channel = 810, 30MHz to 1GHz

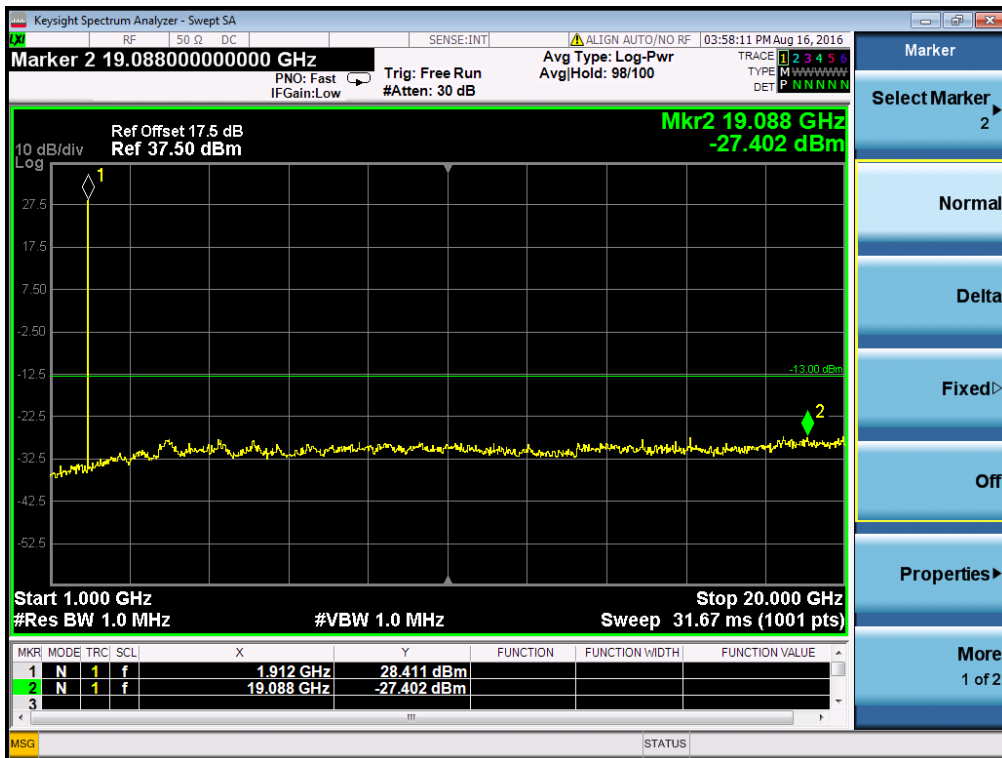

EDGE 1900MHz Channel = 810, 1GHz to 20GHz

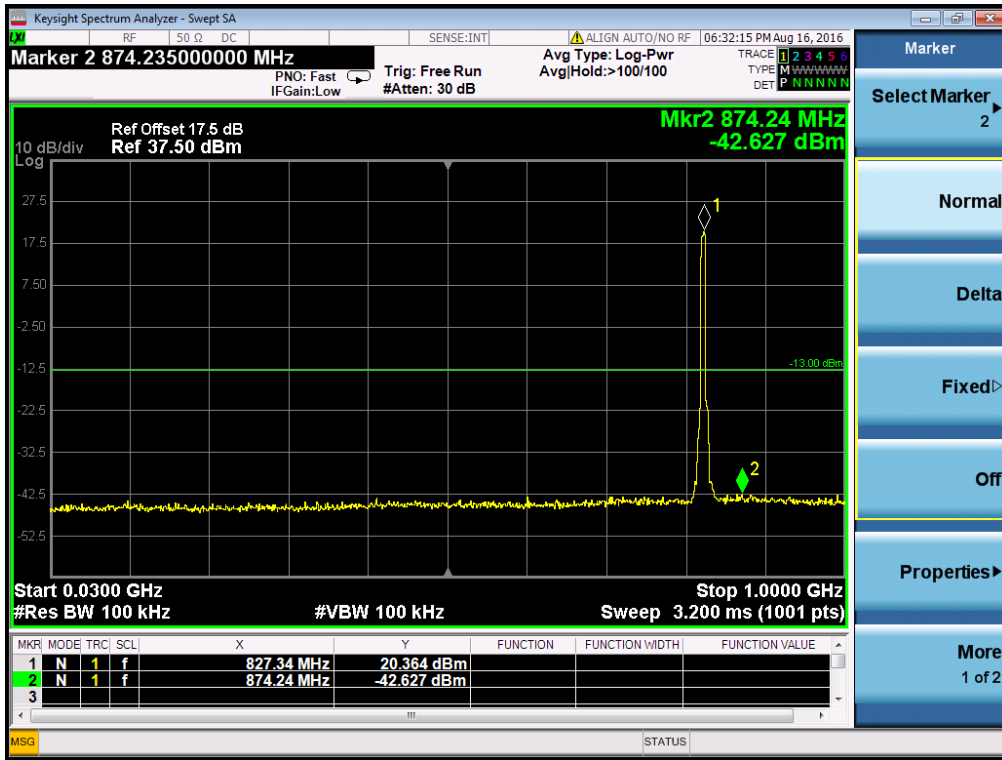

WCDMA850MHz Channel = 4132, 30MHz to 1GHz

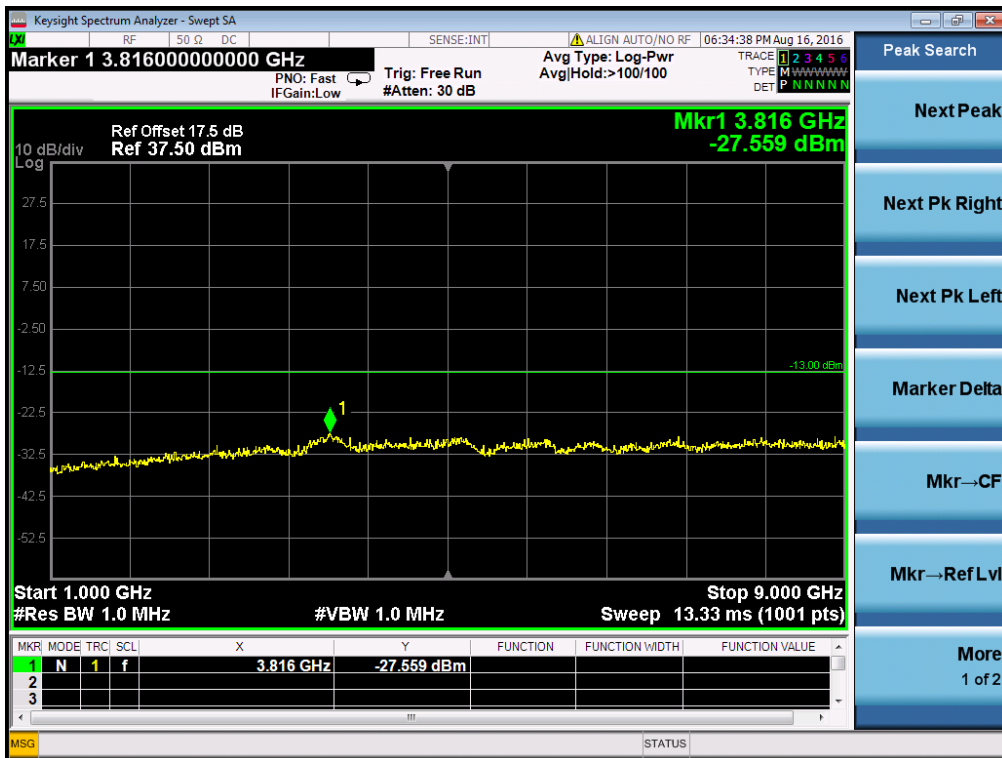

WCDMA850MHz Channel = 4132, 1GHz to 9GHz

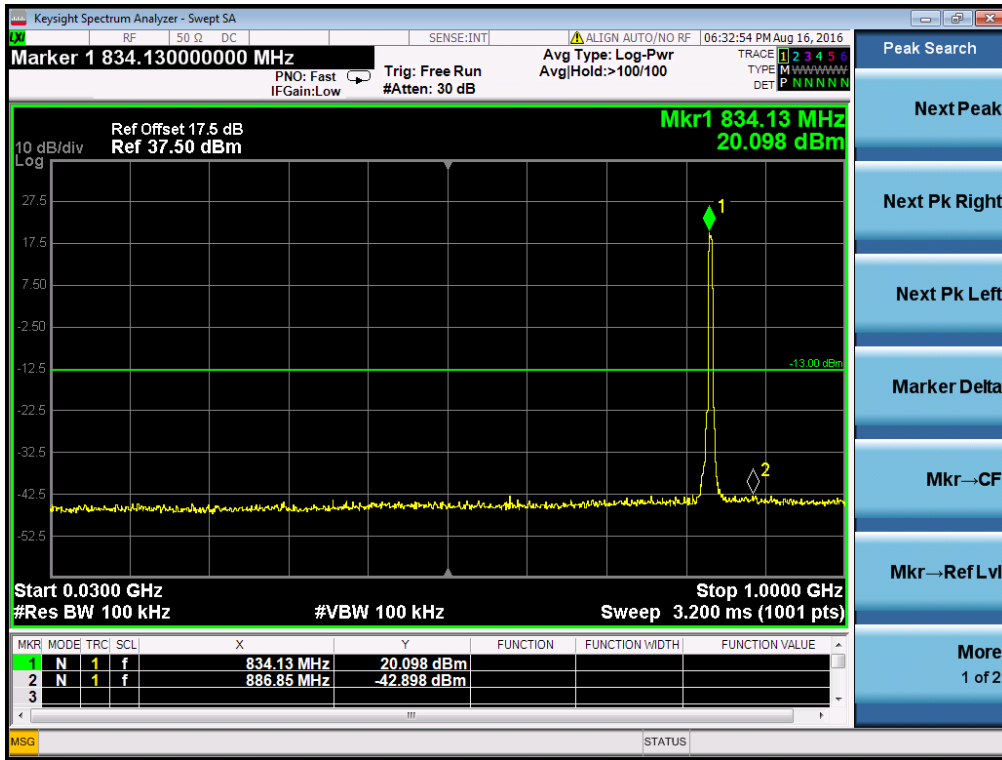

WCDMA850MHz Channel = 4183, 30MHz to 1GHz

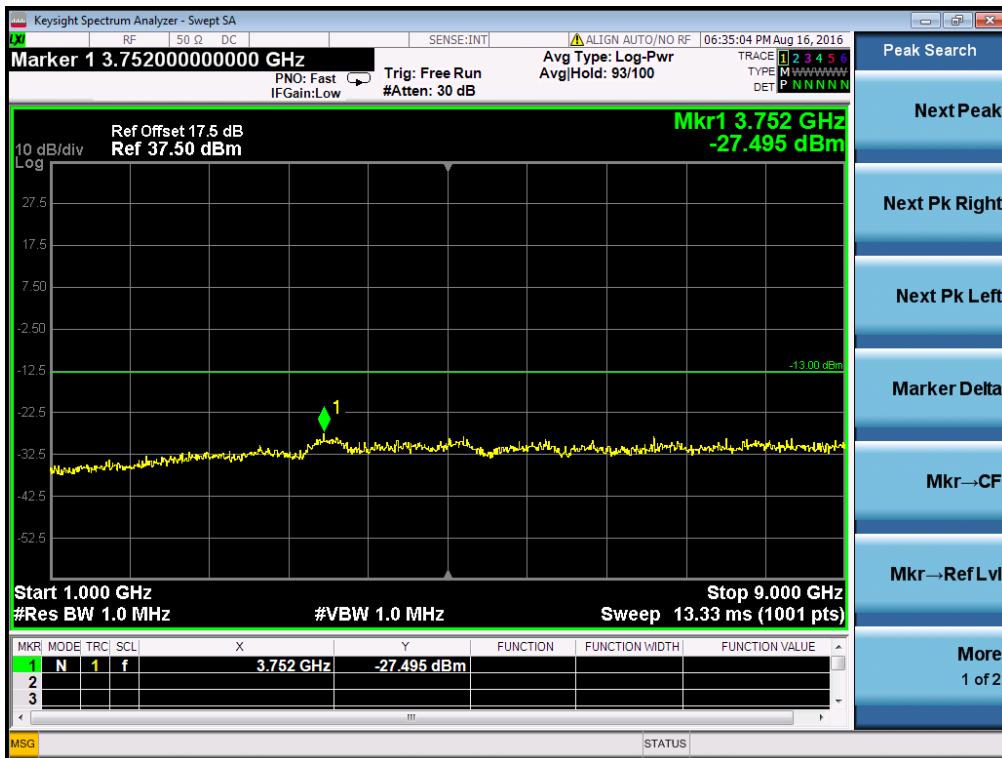

WCDMA850MHz Channel = 4183, 1GHz to 9GHz

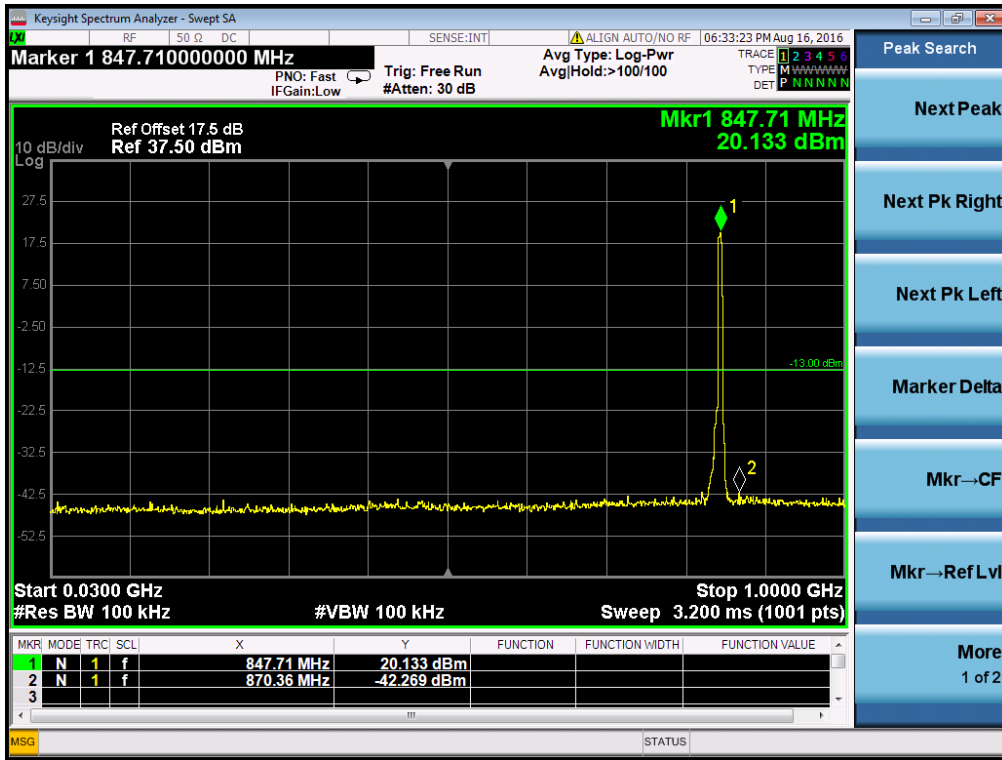

WCDMA850MHz Channel = 4233, 30MHz to 1GHz

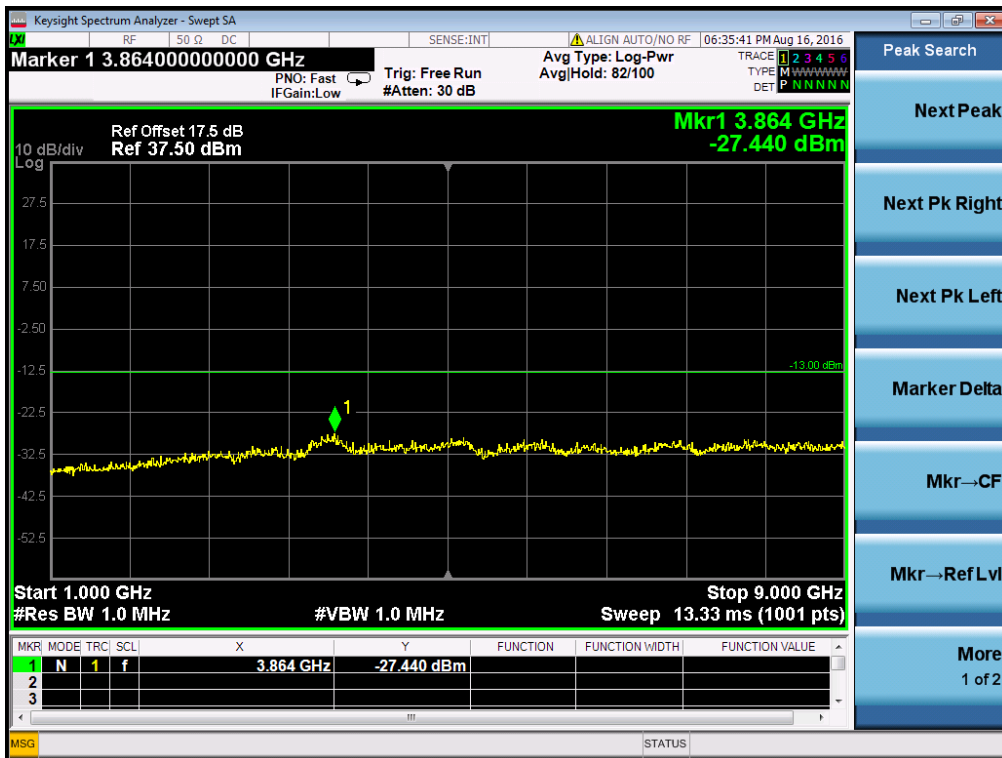

WCDMA850MHz Channel = 4233, 1GHz to 9GHz

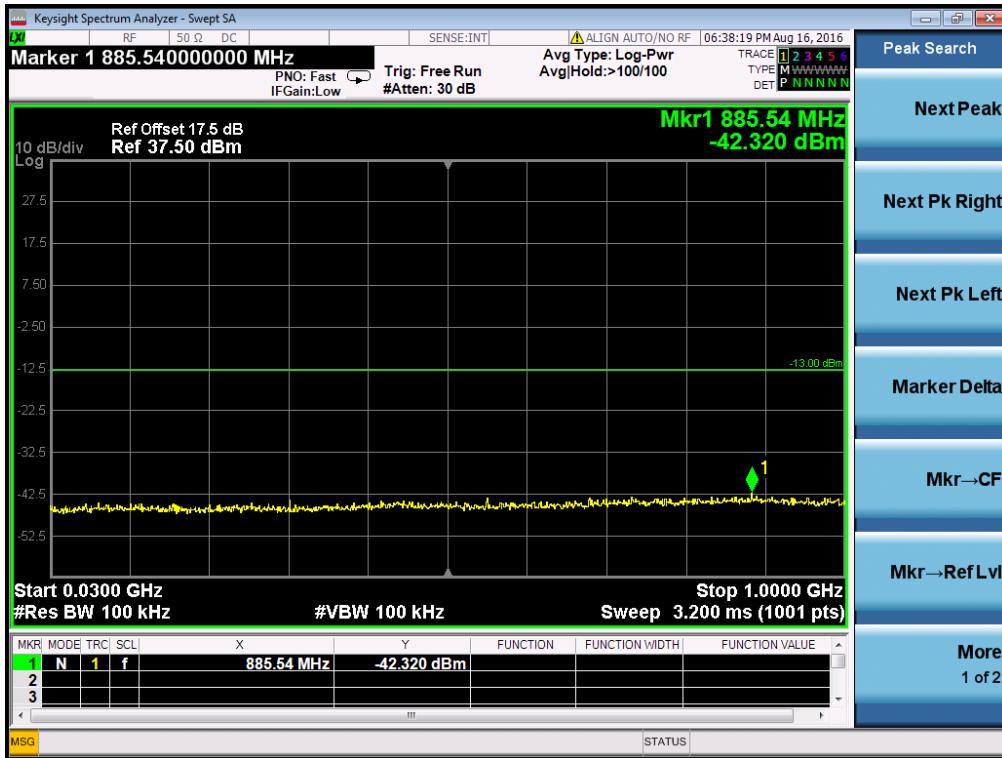

WCDMA1900MHz Channel = 9262, 30MHz to 1GHz

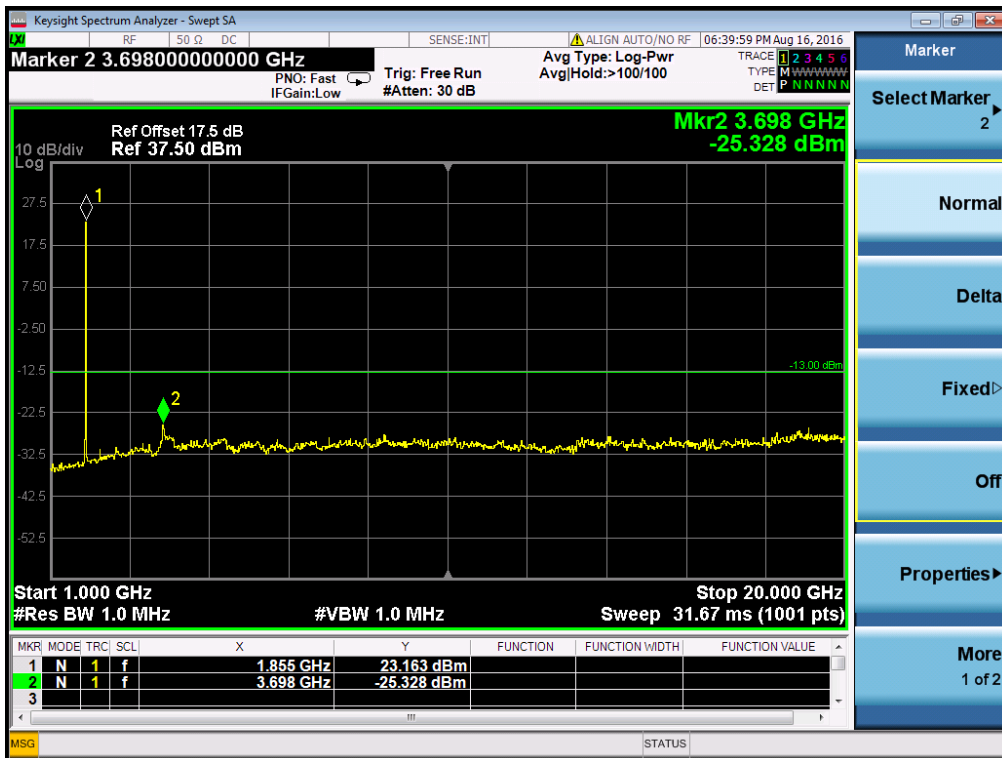

WCDMA1900MHz Channel = 9262, 1GHz to 20GHz

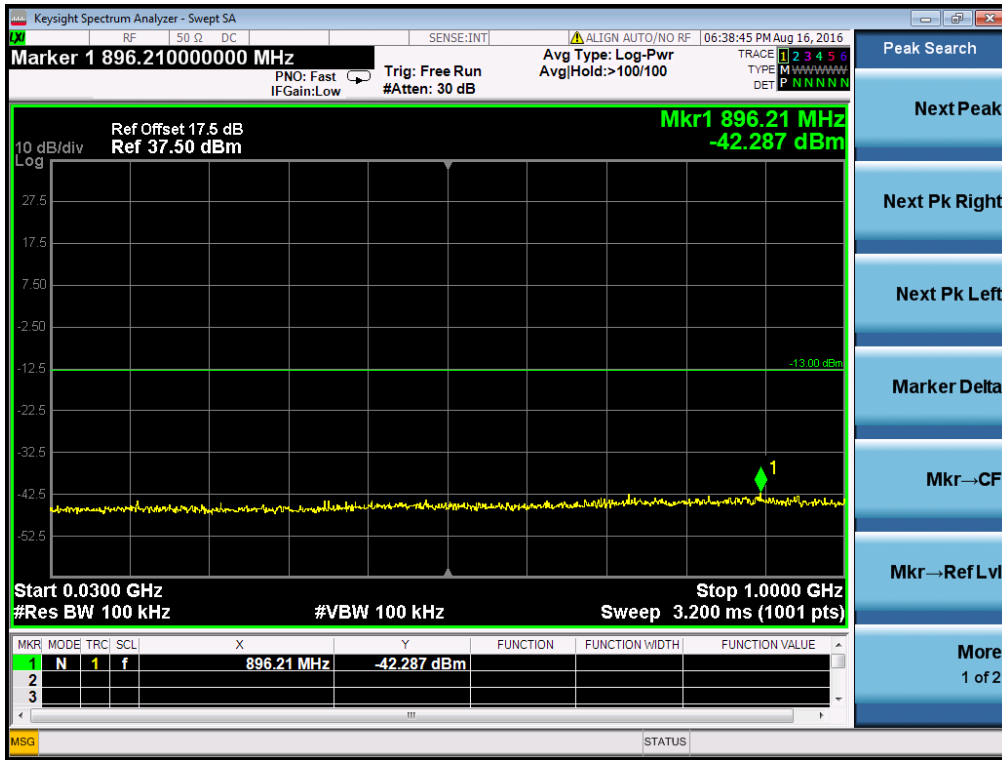

WCDMA1900MHz Channel = 9400, 30MHz to 1GHz

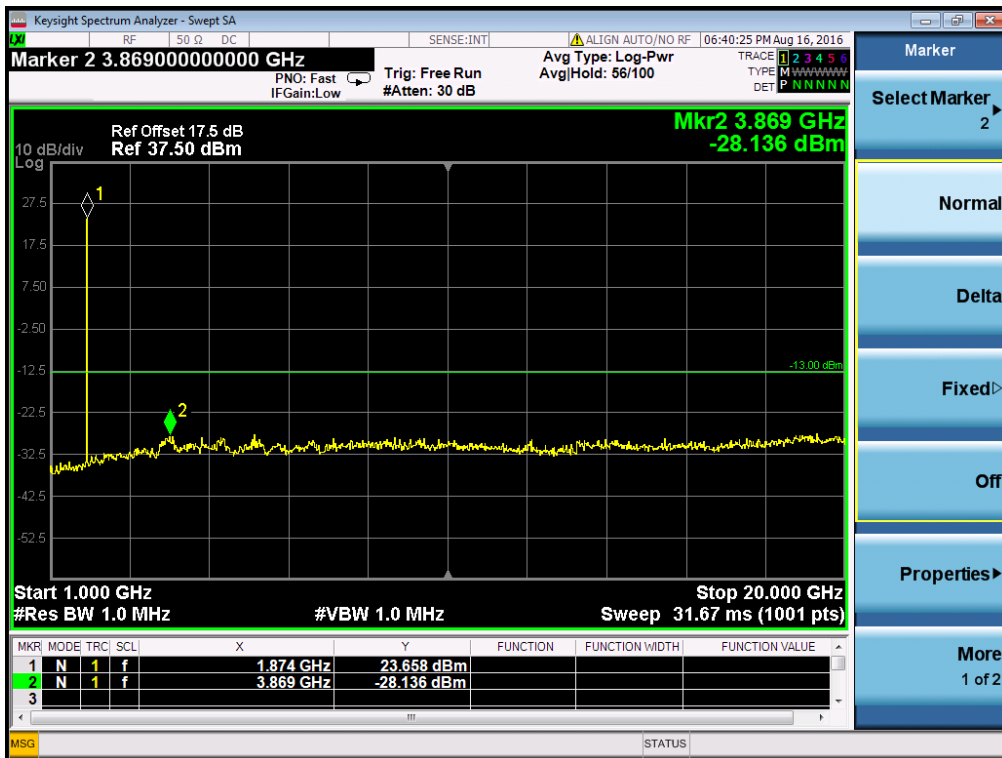

WCDMA1900MHz Channel = 9400, 1GHz to 20GHz

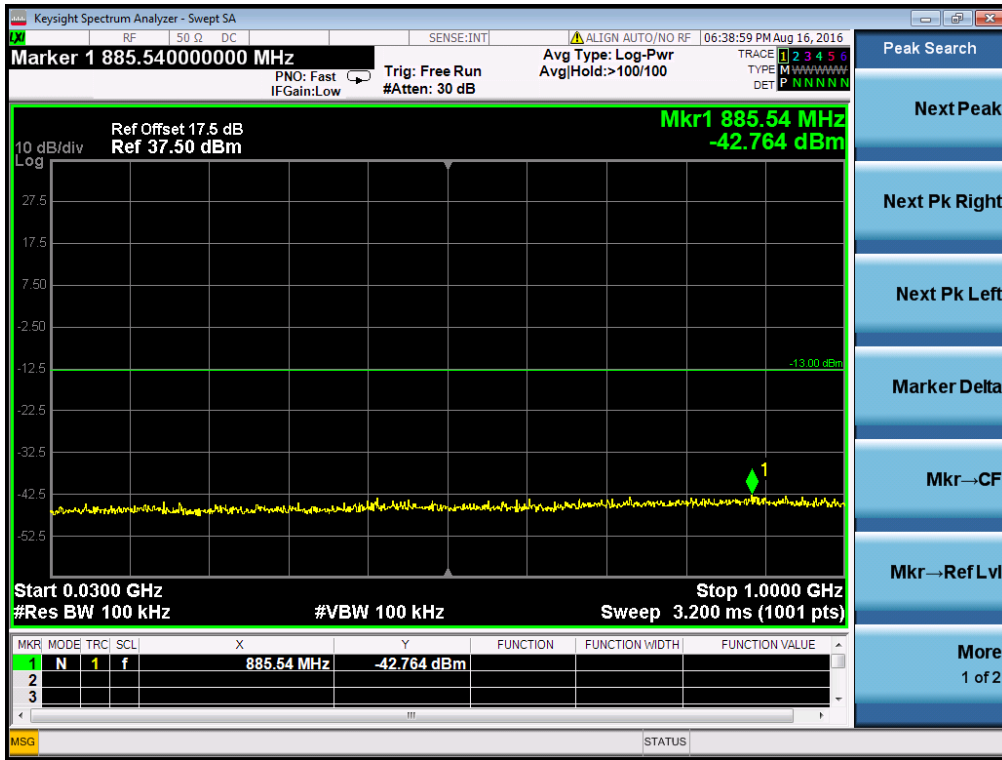

WCDMA1900MHz Channel = 9538, 30MHz to 1GHz

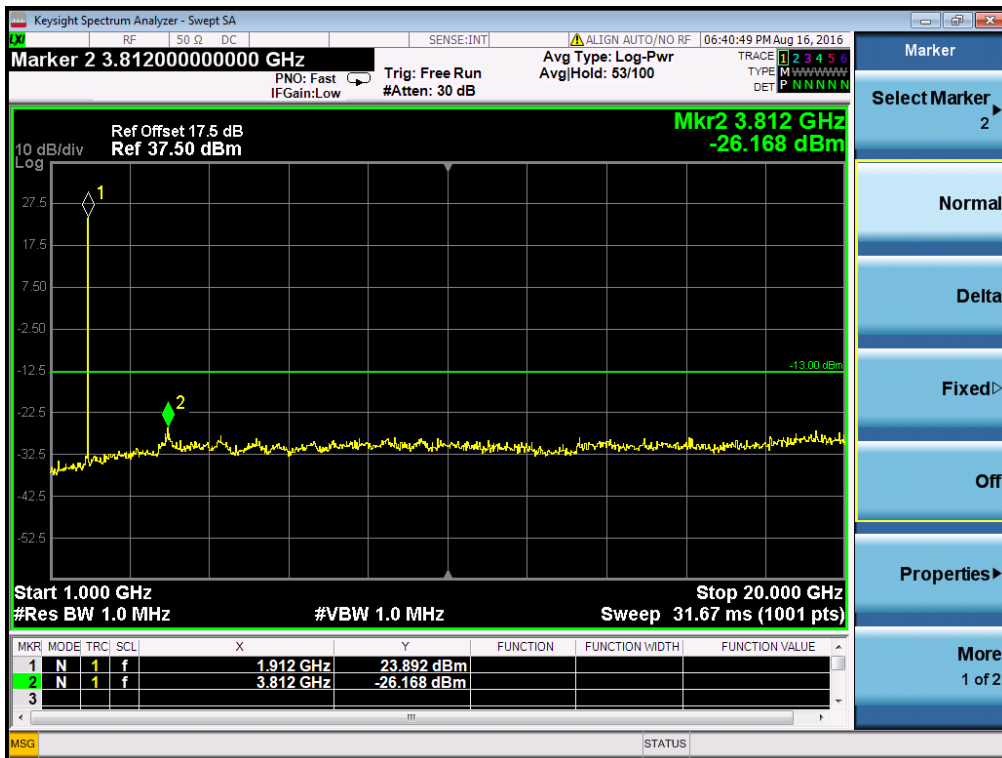

WCDMA1900MHz Channel = 9538 1GHz to 20GHz

2.6 Band Edge

2.6.1 Requirement

The power of any emission outside of the authorized operating frequency ranges must be lower than the transmitter power (P) by a factor of at least $43 + 10 \log (P)$ dB.

2.6.2 Measuring Instruments

The measuring equipment is listed in the section 3 of this test report.

2.6.3 Test Procedures

1. The testing follows FCC KDB 971168 D01v02r02 Section 6.0.
2. The EUT was connected to the spectrum analyzer and system simulator via a power divider.
3. The RF output of EUT was connected to the spectrum analyzer by an RF cable and attenuator. The path loss was compensated to the results for each measurement.
4. The band edges of low and high channels for the highest RF powers were measured.
5. The RF fundamental frequency should be excluded against the limit line in the operating frequency band.
6. The limit line is derived from $43 + 10\log(P)$ dB below the transmitter power P(Watts)
 $= P(W) - [43 + 10\log(P)] \text{ (dB)}$
 $= [30 + 10\log(P)] \text{ (dBm)} - [43 + 10\log(P)] \text{ (dB)}$
 $= -13\text{dBm}.$

2.6.4 Test Setup

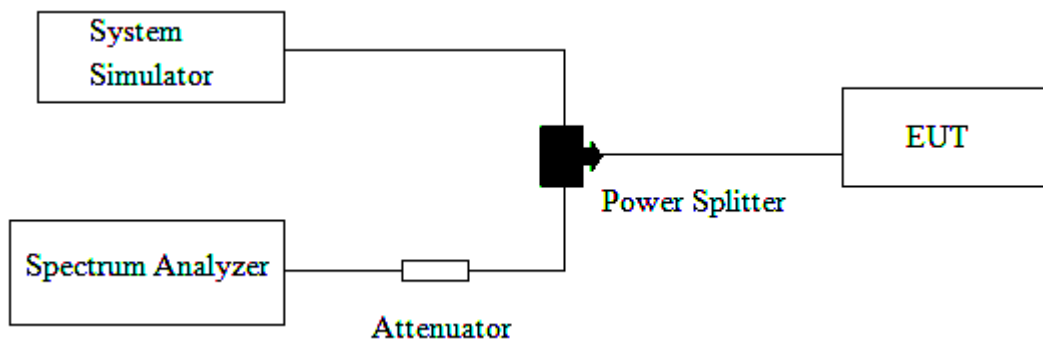

2.6.5 Test Result of Conducted Band Edge

Band	Channel	Frequency (MHz)	Measured Max. Band Edge Emission (dBm)	Refer to Plot	Limit (dBm)	Verdict
GSM 850MHz	128	824.2	-16.45	Plat A	-13	PASS
	251	848.8	-15.40	Plot B		PASS
GSM 1900MHz	512	1850.2	-15.61	Plat C	-13	PASS
	810	1909.8	-16.05	Plot D		PASS
EDGE 850MHz	128	824.2	-14.69	Plat E	-13	PASS
	251	848.8	-15.58	Plot F		PASS
EDGE 1900MHz	512	1850.2	-15.81	Plat G	-13	PASS
	810	1909.8	-15.18	Plot H		PASS
WCDMA 850MHz	4132	826.4	-19.08	Plot I	-13	PASS
	4233	846.6	-17.84	Plot J		PASS
WCDMA 1900MHz	9262	1852.4	-15.75	Plot K	-13	PASS
	9538	1907.6	-14.71	Plot L		PASS

2.6.6 Test Result (Plots) of Conducted Band Edge

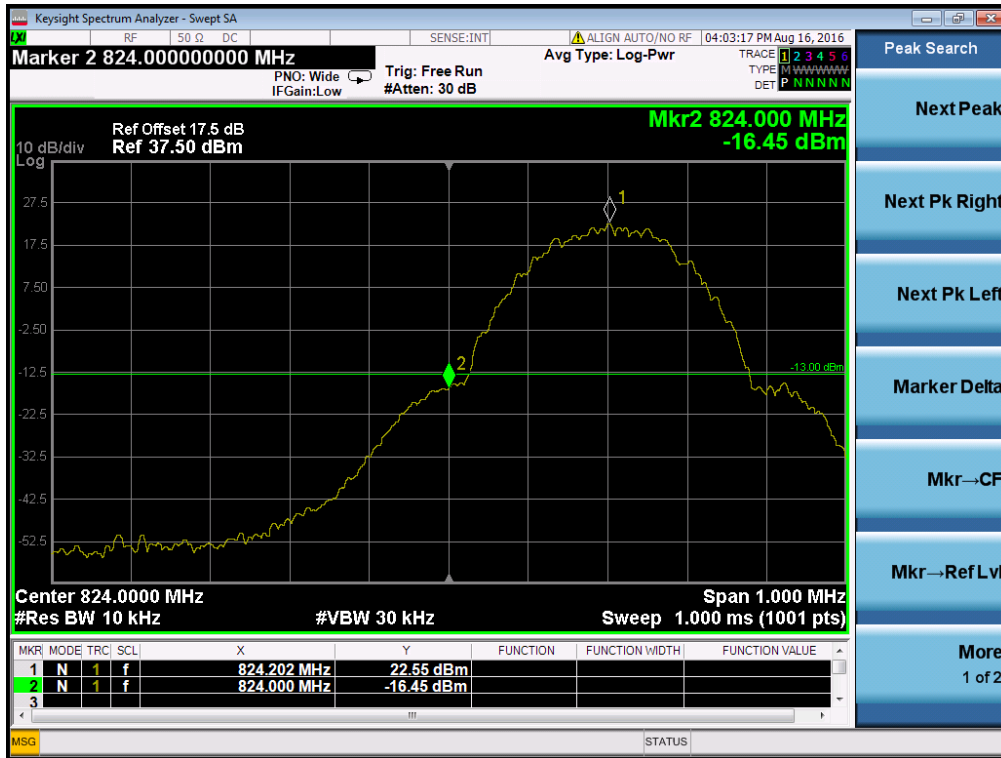

(Plot A: GSM 850 Channel = 128)

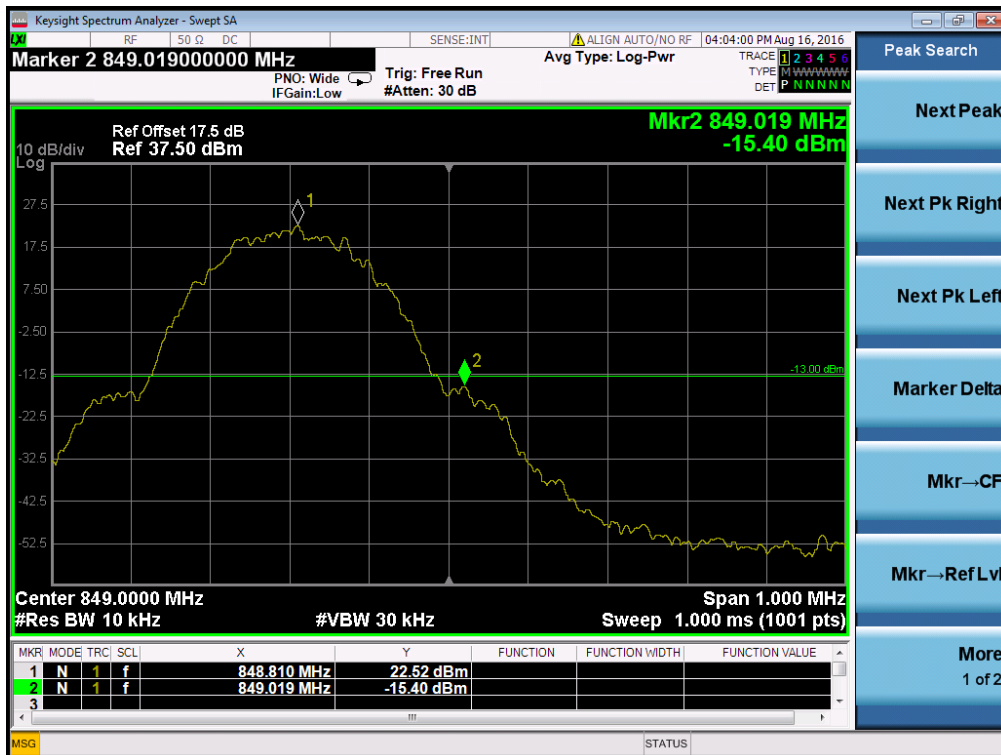

(Plot B: GSM 850 Channel = 251)

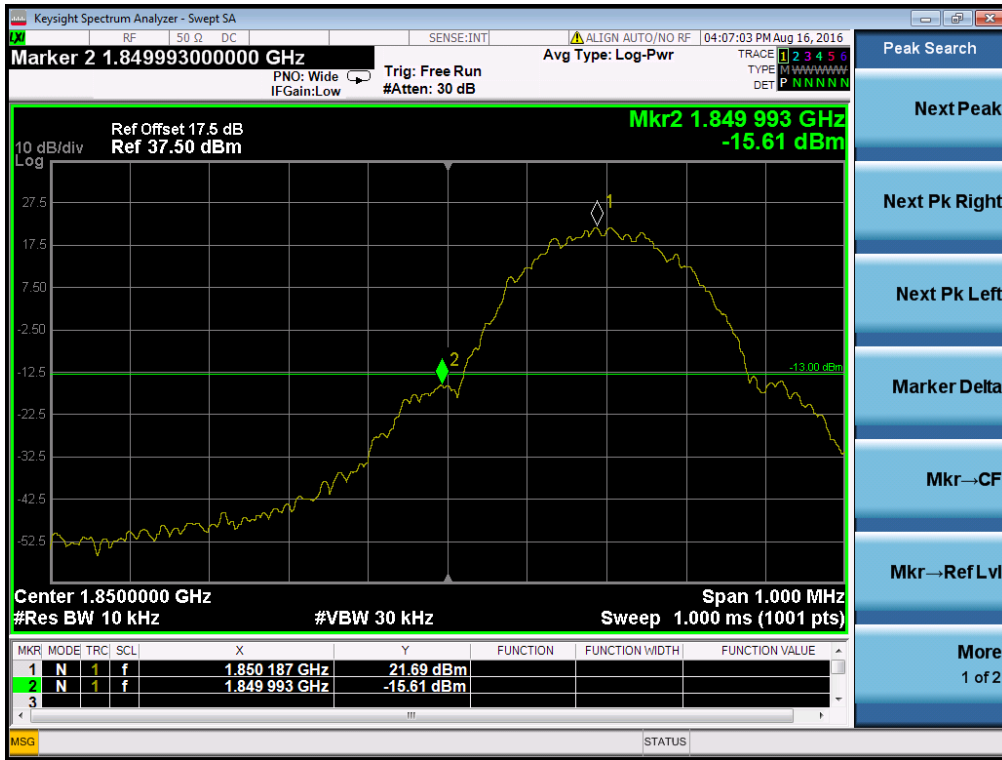

(Plot C: GSM 1900 Channel = 512)

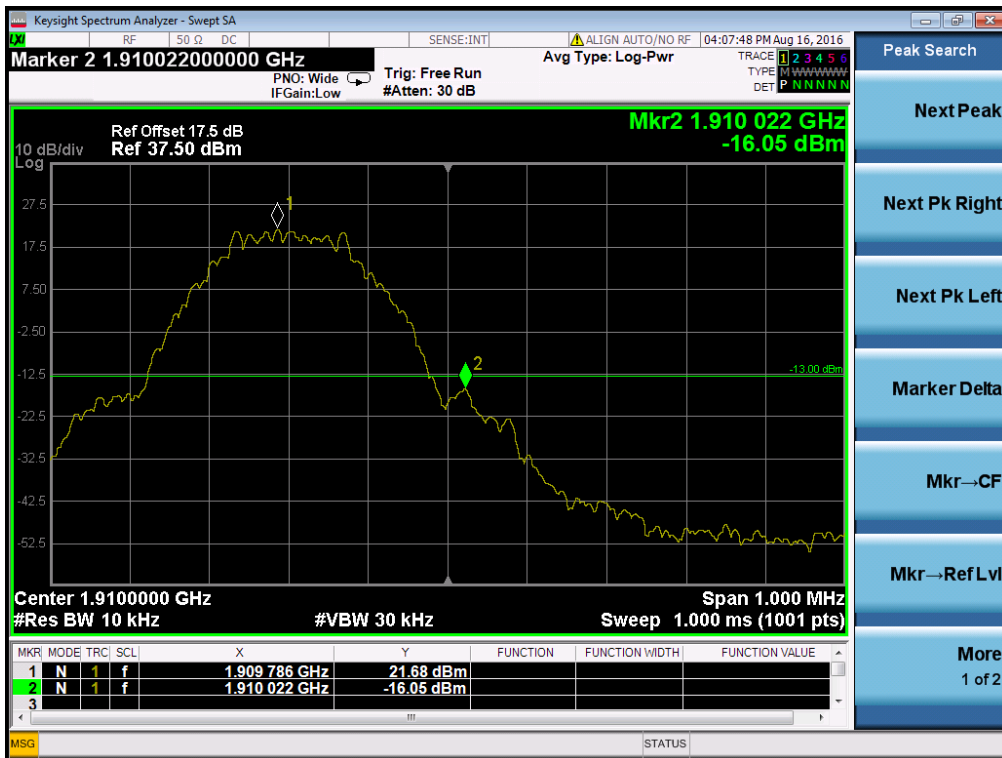

(Plot D: GSM 1900 Channel = 810)

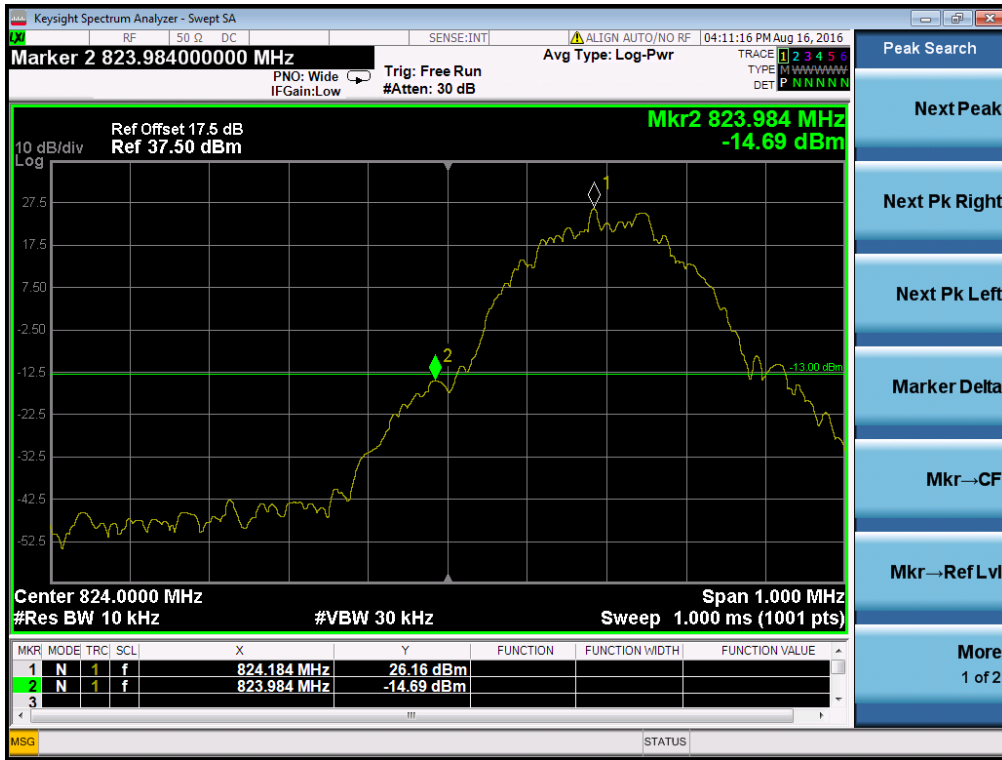

(Plot E: EDGE 850 Channel = 128)

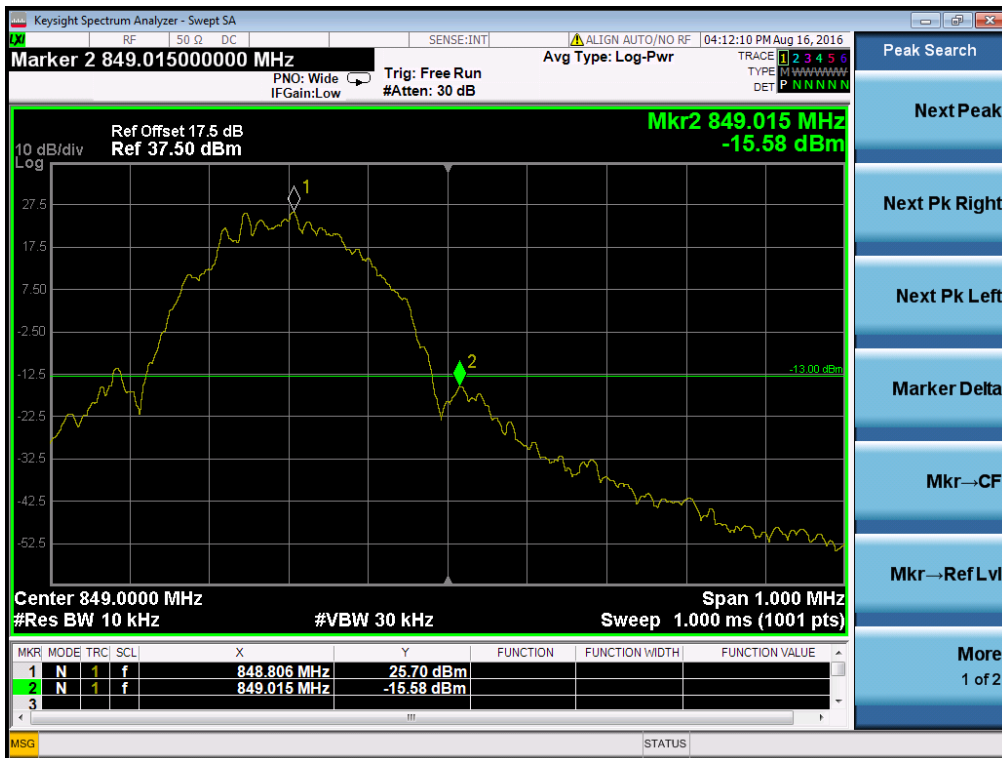

(Plot F: EDGE 850 Channel = 251)

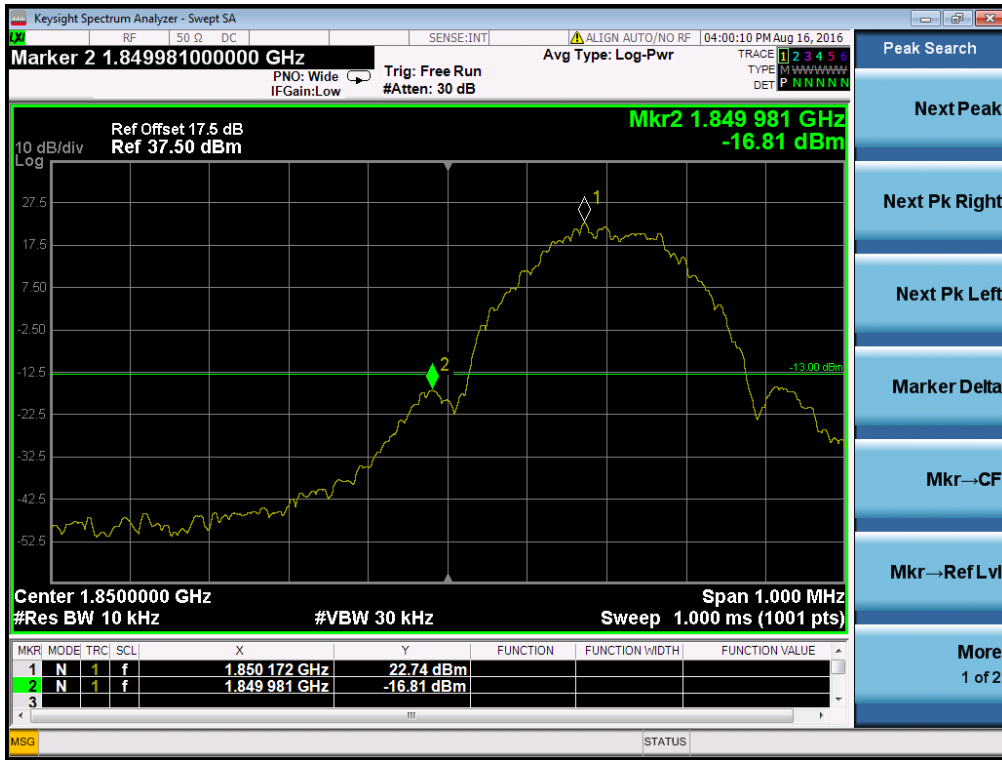

(Plot G: EDGE 1900 Channel = 512)

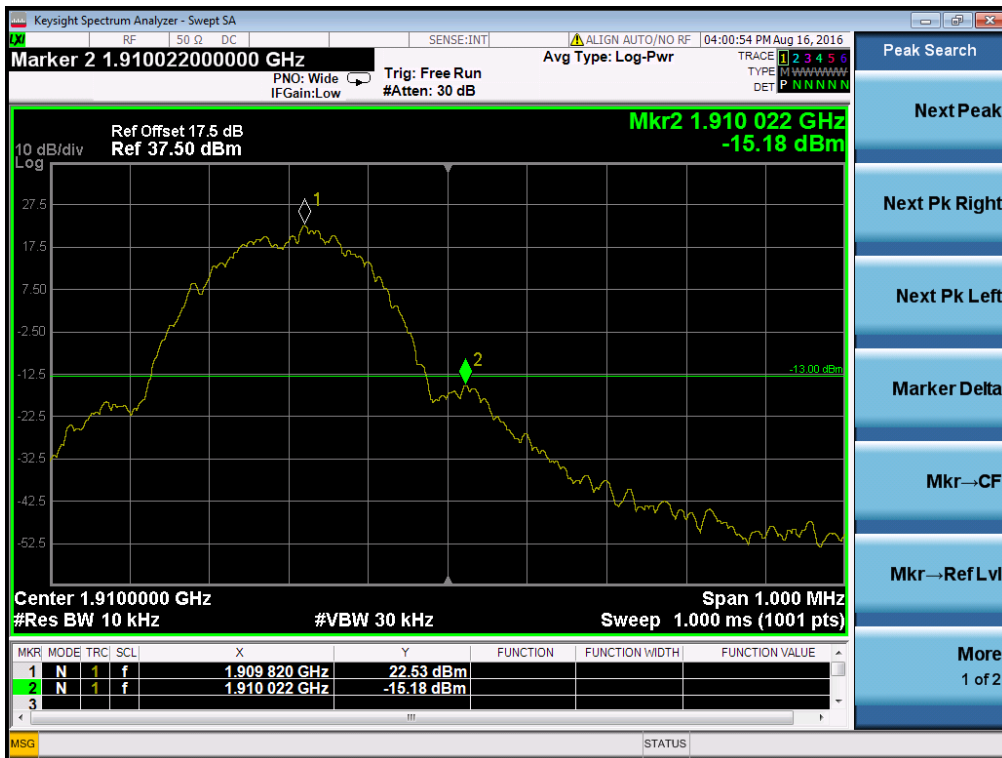

(Plot H: EDGE 1900 Channel = 810)

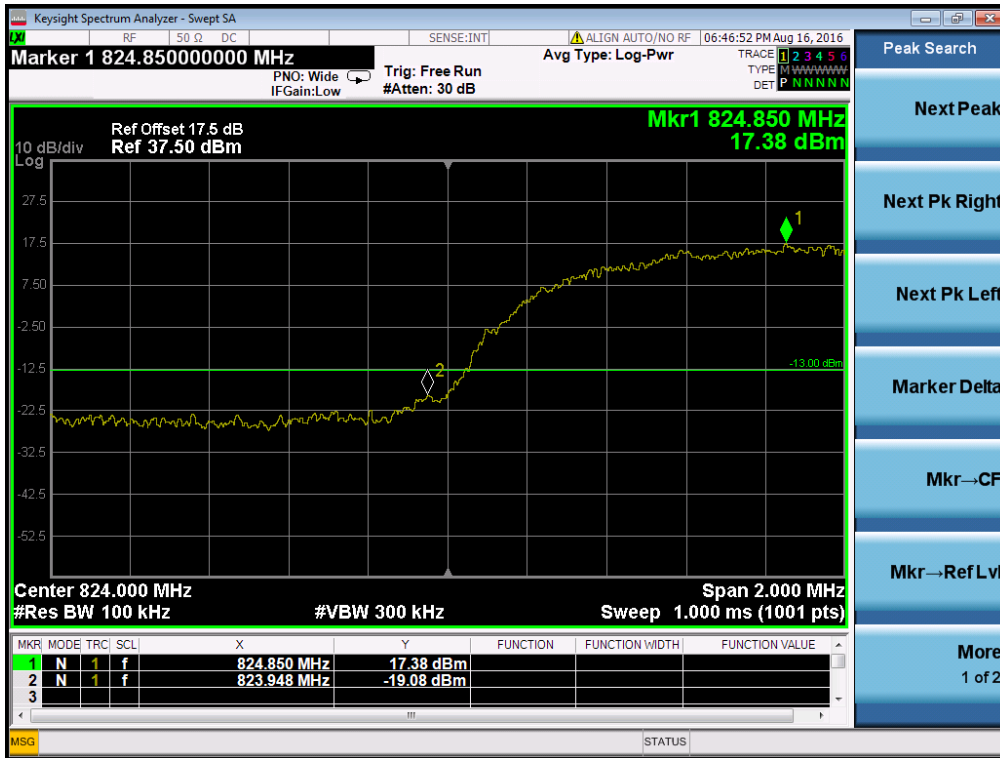

(Plot I: WCDMA 850 Channel = 4132)

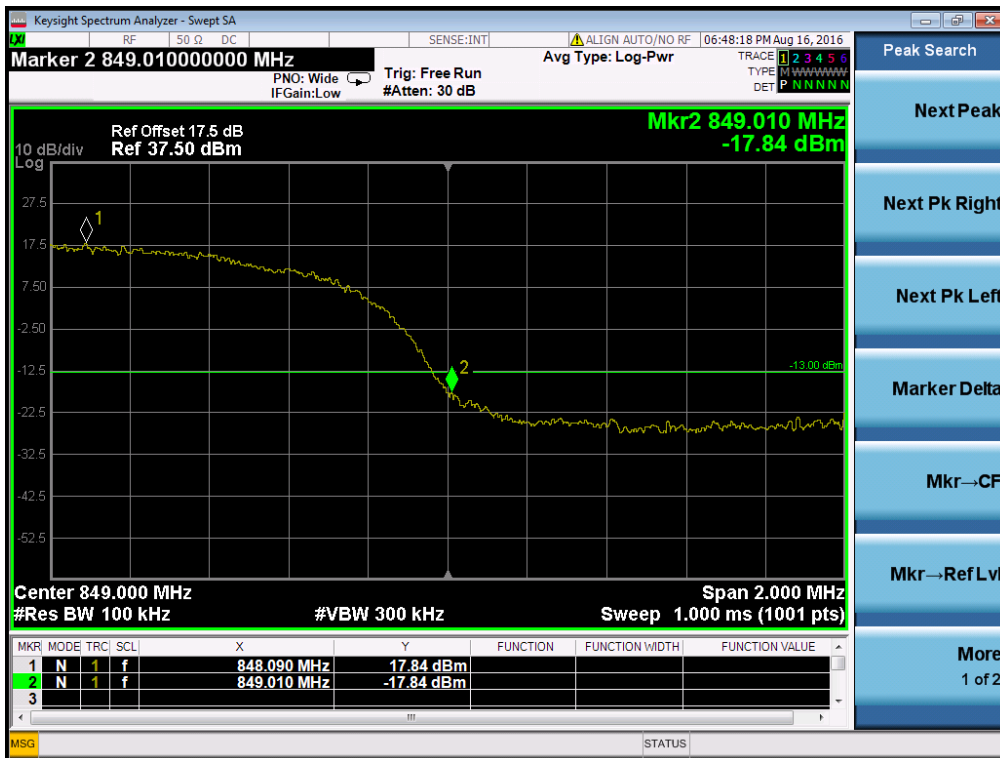

(Plot J: WCDMA 850 Channel = 4233)

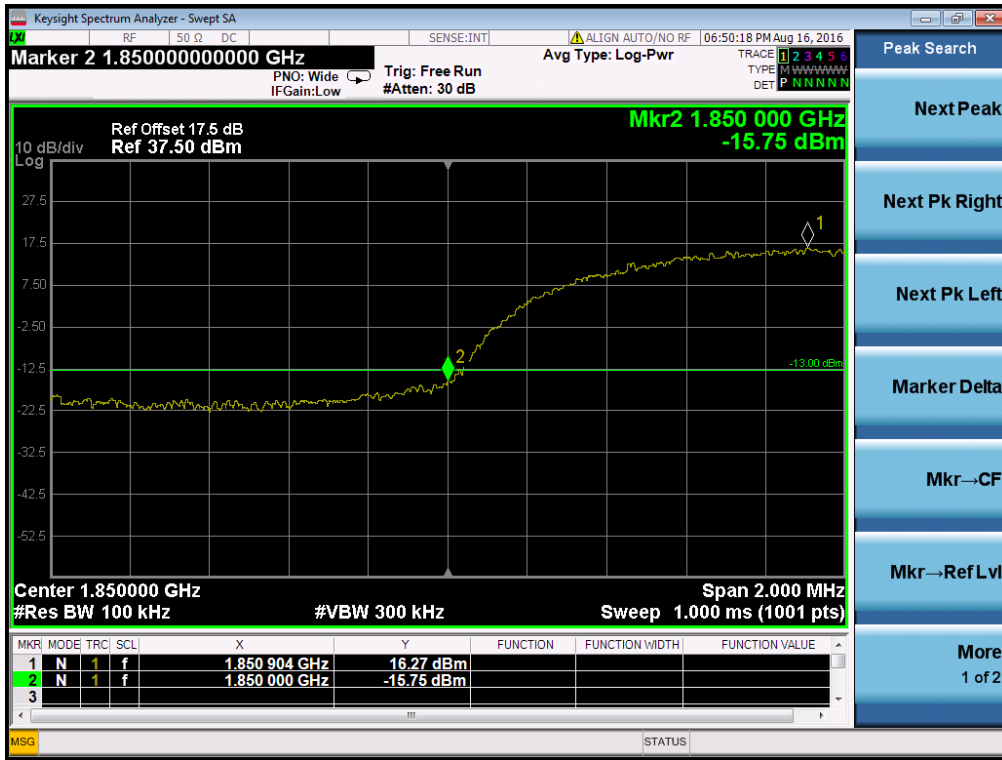

(Plot K: WCDMA 1900 Channel = 9262)



(Plot L: WCDMA 1900 Channel = 9538)

2.7 Transmitter Radiated Power (EIRP/ERP)

2.7.1 Requirement

The substitution method, in ANSI / TIA / EIA-603-D-2010, was used for ERP/EIRP measurement, and the spectrum analyzer configuration follows KDB 971168 D01 Power Meas. License Digital Systems v02r02. The ERP of mobile transmitters must not exceed 7 Watts (Cellular Band) and the EIRP of mobile transmitters are limited to 2 Watts (PCS Band) and 1 Watts (AWS Band).

2.7.2 Measuring Instruments

The measuring equipment is listed in the section 3 of this test report.

2.7.3 Test Procedures

1. The testing follows FCC KDB 971168 D01v02r02 Section 5.2.1. (for CDMA/WCDMA), Section 5.2.2.2 (for GSM/GPRS/EDGE) and ANSI / TIA-603-D-2010 Section 2.2.17.
2. The EUT was placed on a turntable 1.5 meters high in a fully anechoic chamber.
3. The EUT was placed 3 meters from the receiving antenna, which was mounted on the antenna tower.
4. GSM operating modes: Set RBW= 1MHz, VBW= 3MHz, RMS detector over burst;
UMTS operating modes: Set RBW= 100 kHz, VBW= 300 kHz, RMS detector over frame, and use channel power option with bandwidth=5MHz, per KDB 971168 D01 v02r02.
5. The table was rotated 360 degrees to determine the position of the highest radiated power.
6. The height of the receiving antenna is adjusted to look for the maximum ERP/EIRP.
7. Taking the record of maximum ERP/EIRP.
8. A dipole antenna was substituted in place of the EUT and was driven by a signal generator.
9. The conducted power at the terminal of the dipole antenna is measured.
10. Repeat step 3 to step 5 to get the maximum ERP/EIRP of the substitution antenna.
11. $ERP/EIRP = P_s + E_t - E_s + G_s = P_s + R_t - R_s + G_s$

P_s (dBm): Input power to substitution antenna.

G_s (dBi or dBd): Substitution antenna Gain.

$$E_t = R_t + AF \quad E_s = R_s + AF$$

AF (dB/m): Receive antenna factor

R_t : The highest received signal in spectrum analyzer for EUT.

R_s : The highest received signal in spectrum analyzer for substitution antenna.

2.7.4 Test Setup

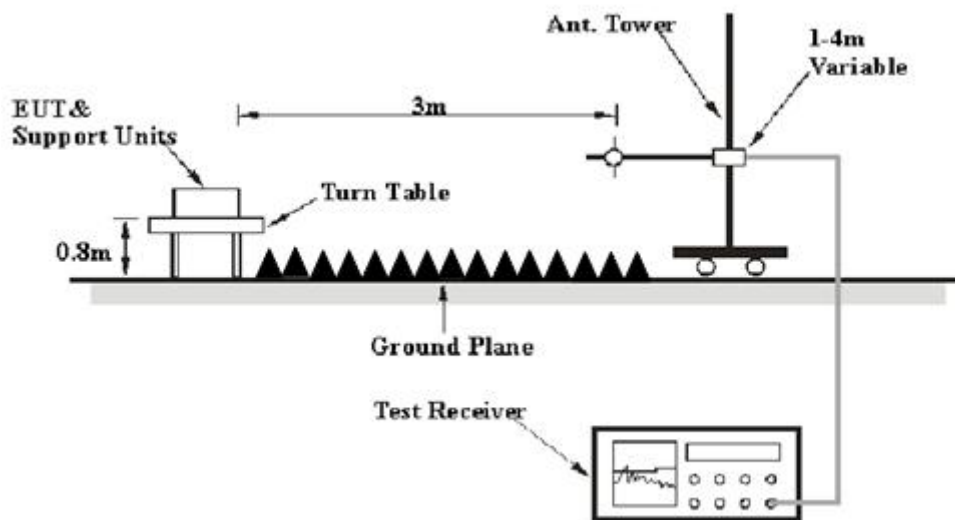

2.7.5 Test Result of Transmitter Radiated Power

Test Notes:

1. This device employs GMSK technology with GSM and GPRS capabilities. All configurations were investigated and the worst case emissions were found in GSM mode.
2. This device employs UMTS technology with WCDMA (AMR/RMC), HSDPA, HSUPA capabilities. All configurations were investigated and the worst case UMTS emissions were found in RMC WCDMA mode at 12.2Kbps.
3. This unit was tested with its standard battery.
4. The worst case test configuration was found in the vertical positioning where the EUT is laying on its side. The data reported in the tables below were measured in this test setup.

Band	Channel	Frequency (MHz)	PCL	Antenna Pol (H/V)	Measured ERP dBm	Limit dBm	Verdict
GSM 850MHz	128	824.20	5	V	31.59	38.5	PASS
				H	31.64		
	190	836.60	5	V	31.61		PASS
				H	31.56		
	251	848.80	5	V	31.67		PASS
				H	31.58		

Band	Channel	Frequency (MHz)	PCL	Antenna Pol (H/V)	Measured EIRP dBm	Limit dBm	Verdict
GSM 1900MHz	512	1850.2	0	V	28.58	33	PASS
				H	28.55		
	661	1880.0	0	V	28.61		PASS
				H	28.52		
	810	1909.8	0	V	28.54		PASS
				H	28.57		

Band	Channel	Frequency (MHz)	PCL	Antenna Pol (H/V)	Measured ERP dBm	Limit dBm	Verdict
EDGE 850MHz	128	824.20	5	V	26.74	38.5	PASS
				H	26.68		
	190	836.60	5	V	26.72		PASS
				H	26.75		
	251	848.80	5	V	26.77		PASS
				H	26.71		

Band	Channel	Frequency (MHz)	PCL	Antenna Pol (H/V)	Measured EIRP dBm	Limit dBm	Verdict
EDGE 1900MHz	512	1850.2	0	V	24.92	33	PASS
				H	24.86		
	661	1880.0	0	V	24.91		PASS
				H	24.88		
	810	1909.8	0	V	24.95		PASS
				H	24.92		

Band	Channel	Frequency (MHz)	Antenna Pol (H/V)	Measured ERP dBm	Limit dBm	Verdict
WCDMA 850MHz	4132	826.4	V	23.35	38.5	PASS
			H	23.31		
	4175	835	V	23.40		PASS
			H	23.32		
	4233	846.6	V	23.37		PASS
			H	23.35		

Band	Channel	Frequency (MHz)	Antenna Pol (H/V)	Measured EIRP dBm	Limit dBm	Verdict
WCDMA 1900MHz	9262	1852.4	V	22.64	33	PASS
			H	22.68		
	9400	1880	V	22.71		PASS
			H	22.74		
	9538	1907.6	V	22.67		PASS
			H	22.72		

2.8 Radiated Spurious Emissions

2.8.1 Requirement

The power of any emission outside of the authorized operating frequency ranges must be attenuated below the transmitter power (P) by a factor of at least $43 + 10 \log (P)$ dB. The spectrum is scanned from 30 MHz up to a frequency including its 10th harmonic.

2.8.2 Measuring Instruments

The measuring equipment is listed in the section 3 of this test report.

2.8.3 Test Setup

For radiated emissions from 9 kHz to 30MHz

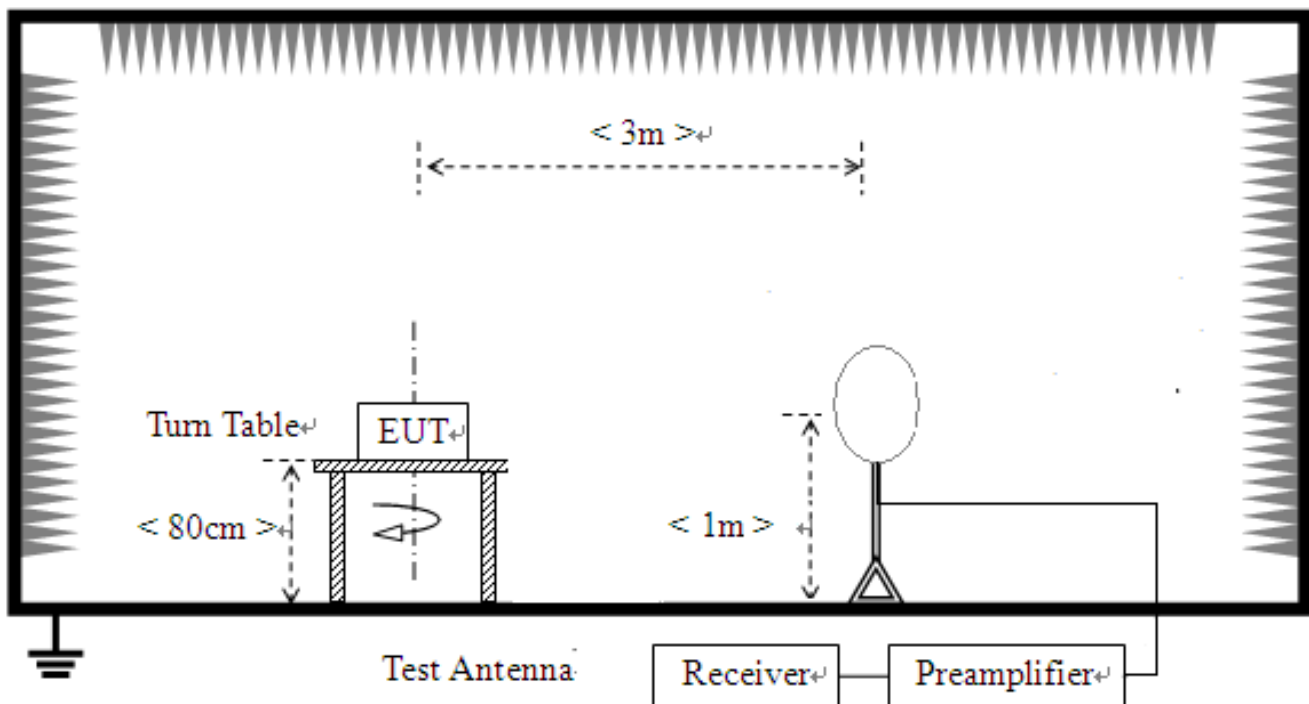

For radiated emissions from 30MHz to 1GHz

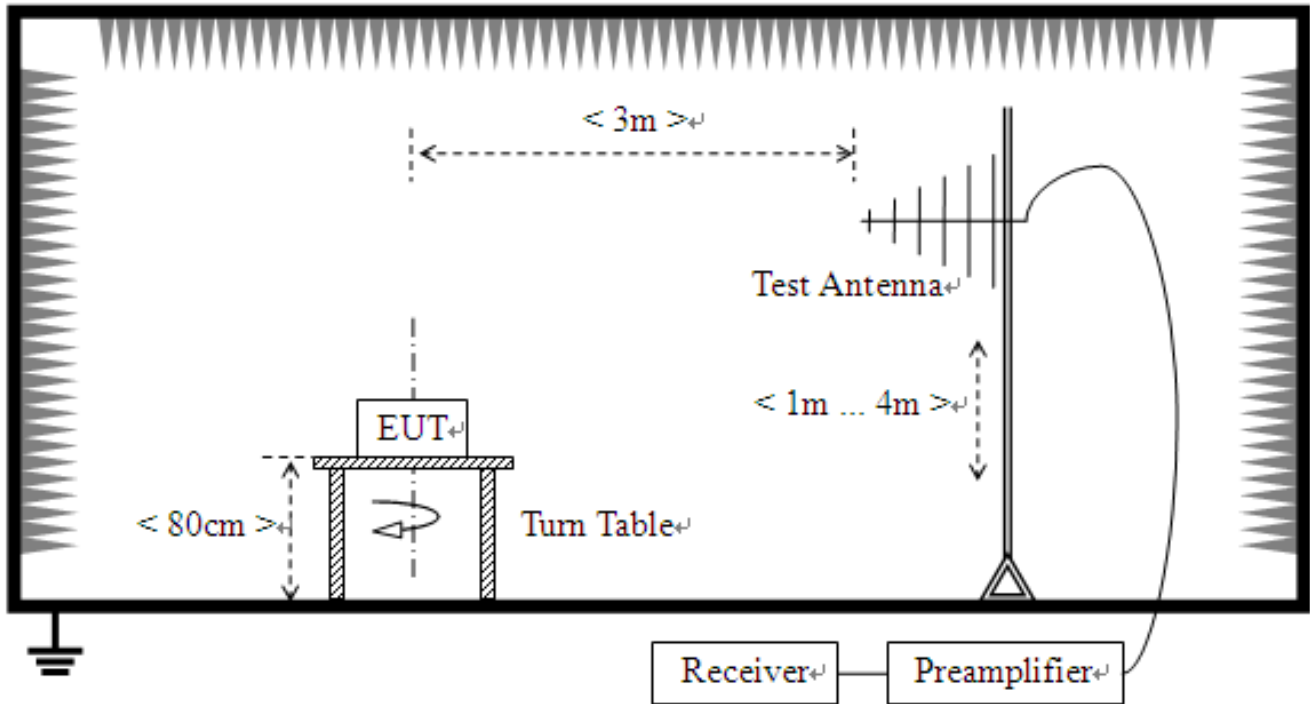

For radiated emissions above 1GHz

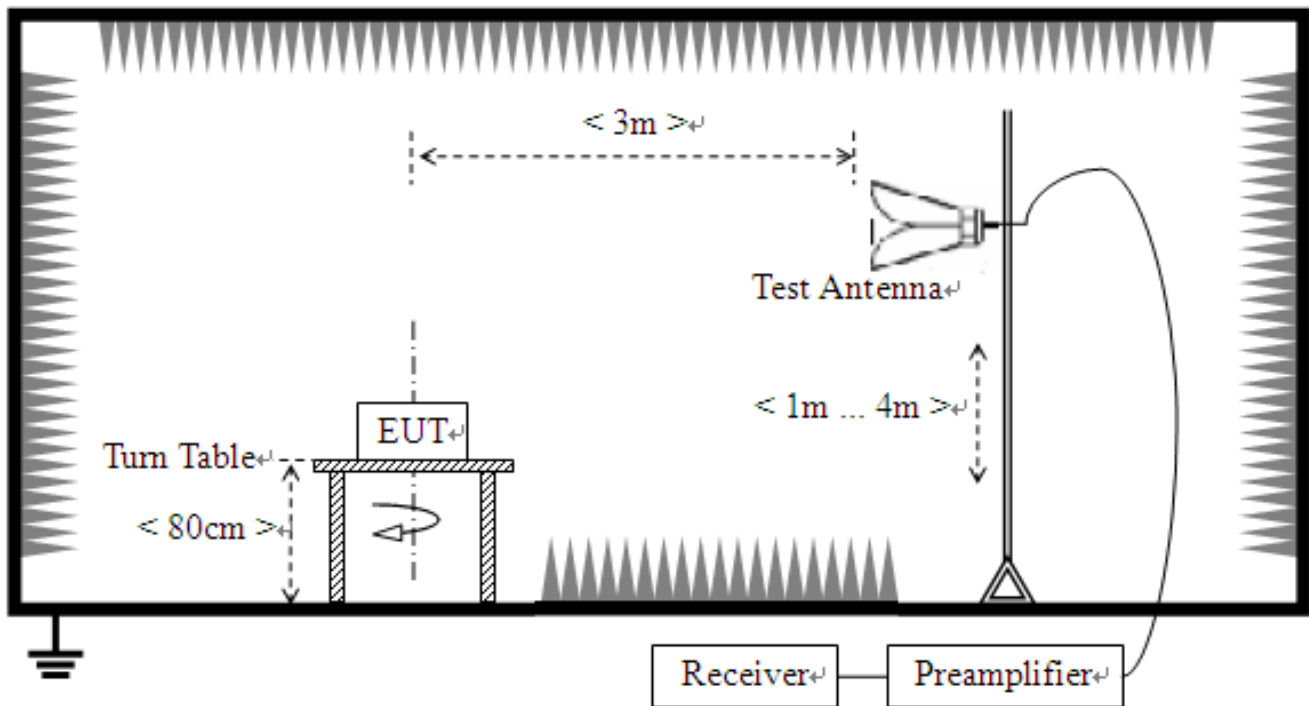

2.8.4 Test Procedures

1. The testing follows FCC KDB 971168 D01v02r02 Section 5.8 and ANSI / TIA-603-D-2010 Section 2.2.12.
2. The EUT was placed on a rotatable wooden table 0.8 meters above the ground.
3. The EUT was set 3 meters from the receiving antenna, which was mounted on the antenna tower.
4. The table was rotated 360 degrees to determine the position of the highest spurious emission.
5. The height of the receiving antenna is varied between one meter and four meters to search for the maximum spurious emission for both horizontal and vertical polarizations.
6. Make the measurement with the spectrum analyzer's RBW = 1MHz, VBW = 3MHz, taking record of maximum spurious emission.
7. A horn antenna was substituted in place of the EUT and was driven by a signal generator.
8. Tune the output power of signal generator to the same emission level with EUT maximum spurious emission.
9. Taking the record of output power at antenna port.
10. Repeat step 7 to step 8 for another polarization.
11. The RF fundamental frequency should be excluded against the limit line in the operating frequency band.
12. The limit line is derived from $43 + 10\log(P)$ dB below the transmitter power P(Watts)
 $= P(W) - [43 + 10\log(P)]$ (dB)
 $= [30 + 10\log(P)]$ (dBm) - $[43 + 10\log(P)]$ (dB)
 $= -13\text{dBm}$.
13. This device employs GMSK technology with GSM and GPRS capabilities. All configurations were investigated and the worst case emissions were found in GSM mode.
14. This device employs UMTS technology with WCDMA (AMR/RMC), HSDPA, HSUPA capabilities. All configurations were investigated and the worst case UMTS emissions were found in RMC WCDMA mode at 12.2Kbps.
15. This unit was tested with its standard battery.
16. All Spurious Emission tests were performed in X, Y, Z axis direction and low, middle, high channel. And only the worst axis test condition was recorded in this test report.
17. The spectrum is measured from 9 KHz to the 10th harmonic of the fundamental frequency of the transmitter using CISPR quasi peak detector below 1GHz. The worst case emissions are reported however emissions whose levels were not within 20dB of the respective limits were not reported.
18. For 9KHz to 30MHz: the amplitude of spurious emissions are attenuated by more than 20dB below the permissible value has no need to be reported.

2.8.5 Test Results of Radiated Spurious Emissions

Note: For 9 KHz to 30MHz: the amplitude of spurious emissions is attenuated by more than 20dB below the permissible value, so we not provide the test result here.

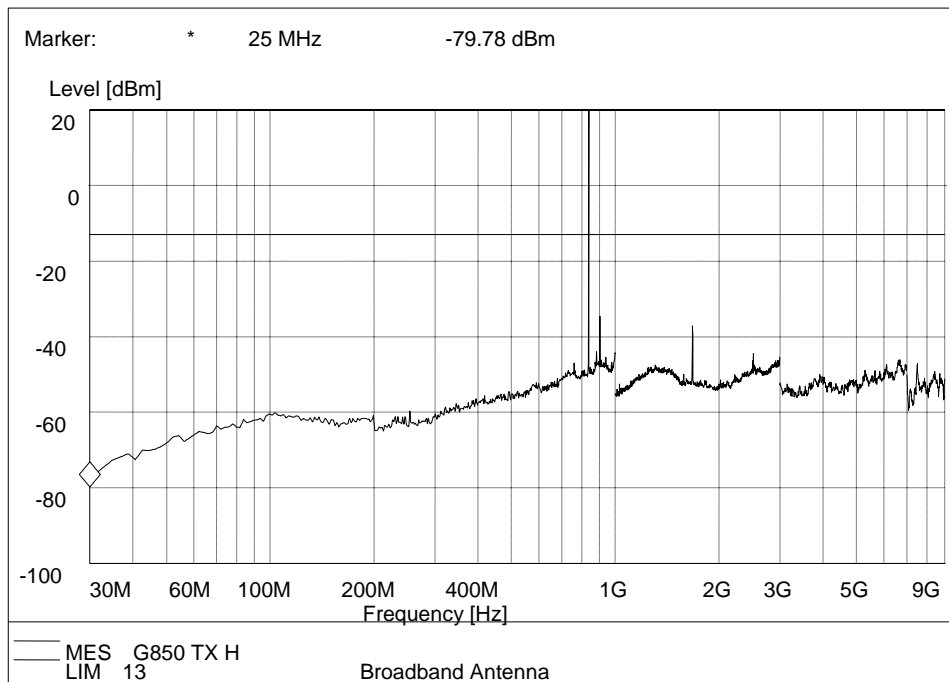

GSM 850MHz, Test Antenna Horizontal

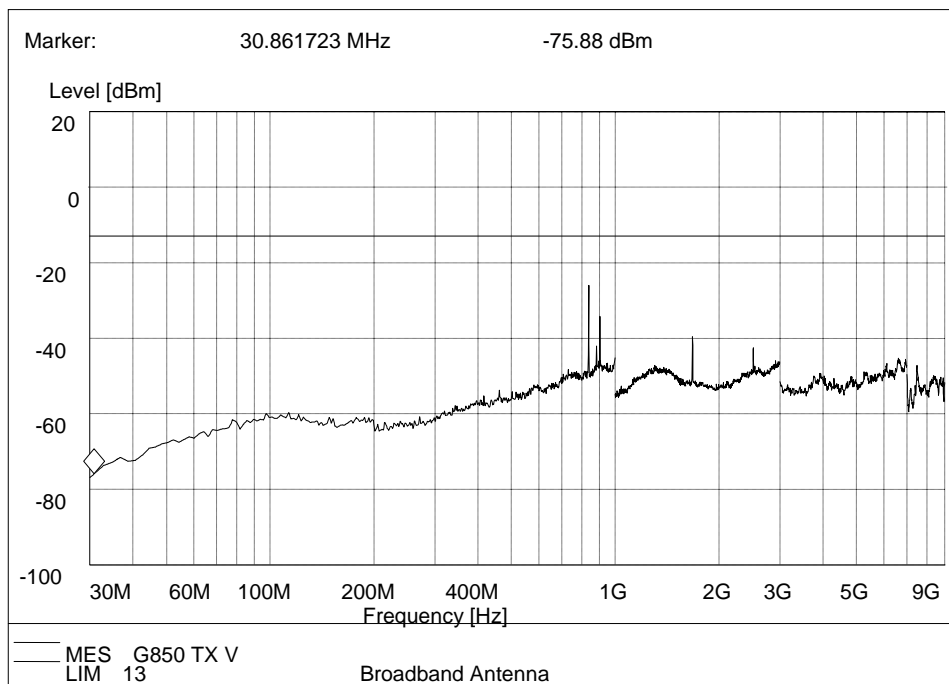

GSM 850MHz, Test Antenna Vertical

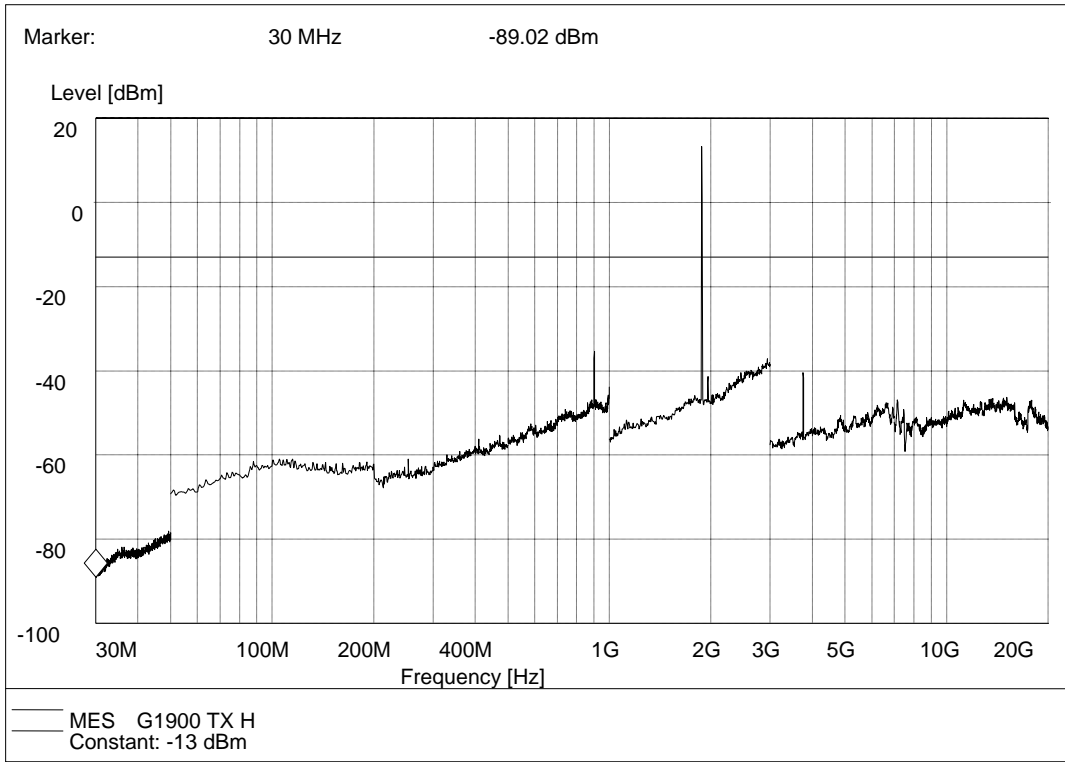

GSM 1900MHz, Test Antenna Horizontal

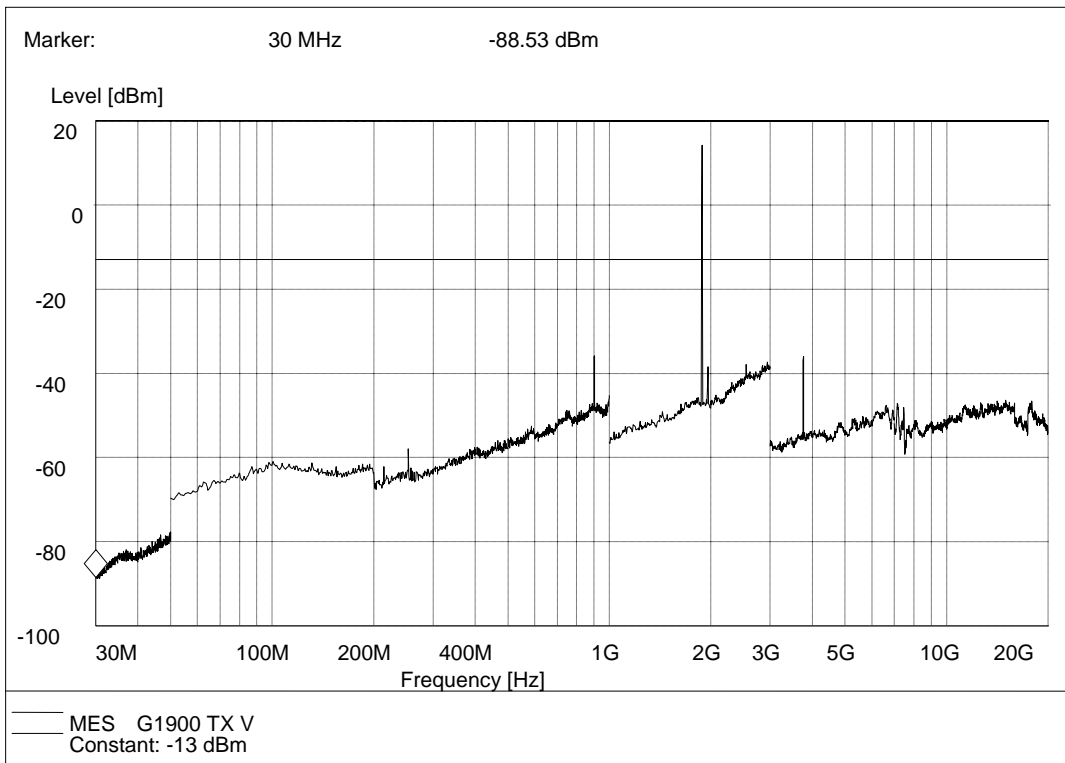

GSM 1900MHz, Test Antenna Vertical

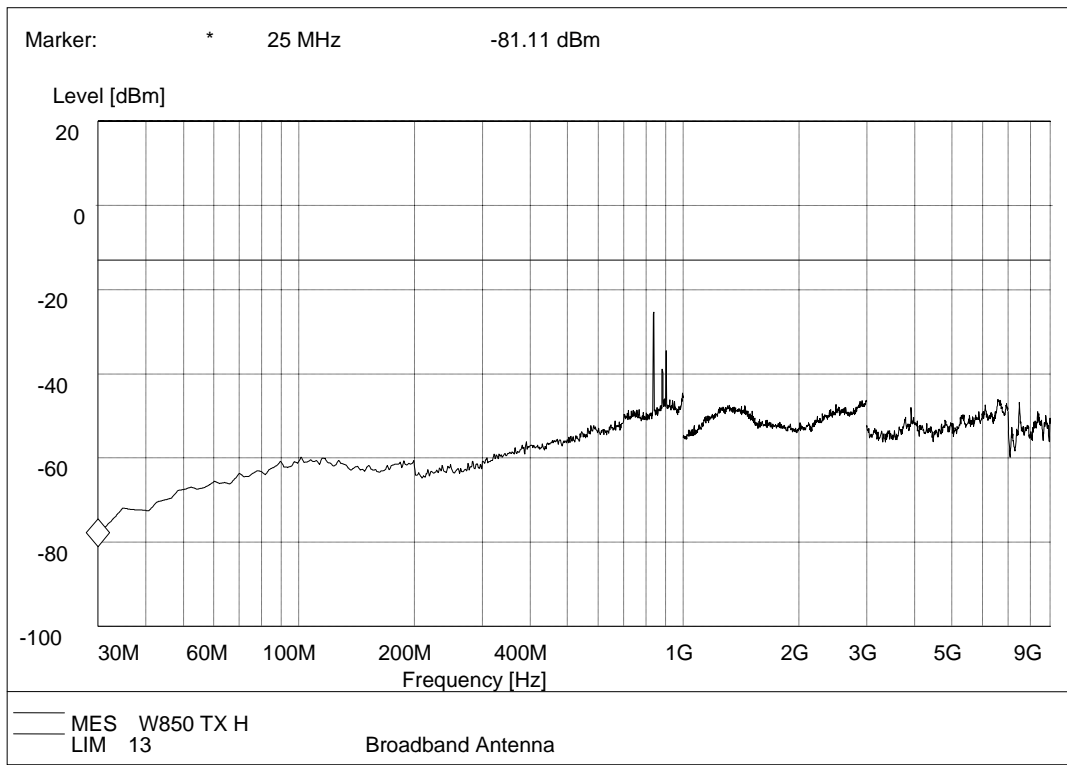

WCDMA 850MHz, Test Antenna Horizontal

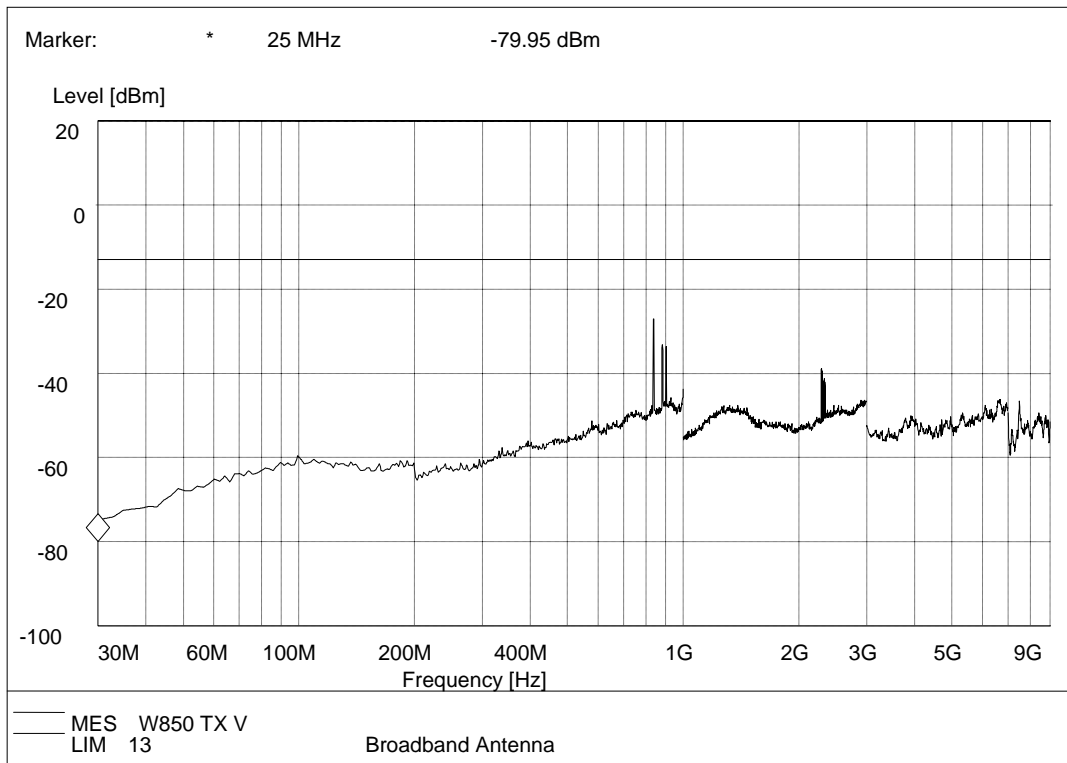

WCDMA 850MHz, Test Antenna Vertical

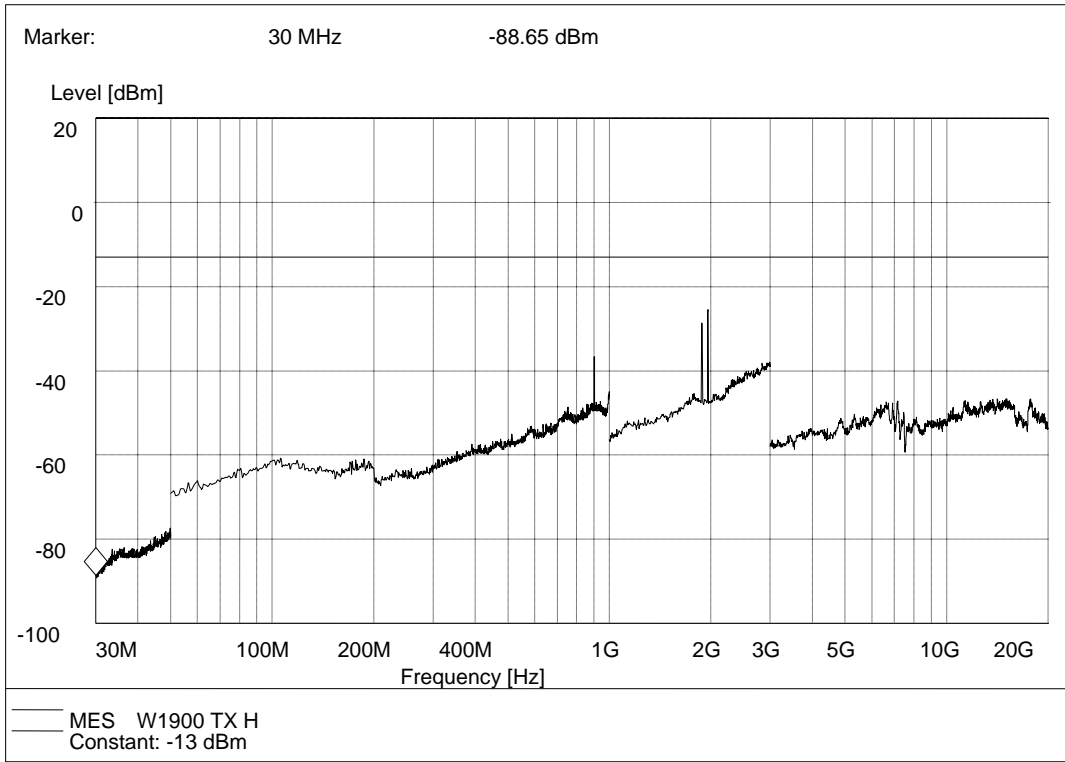

WCDMA 1900MHz, Test Antenna Horizontal

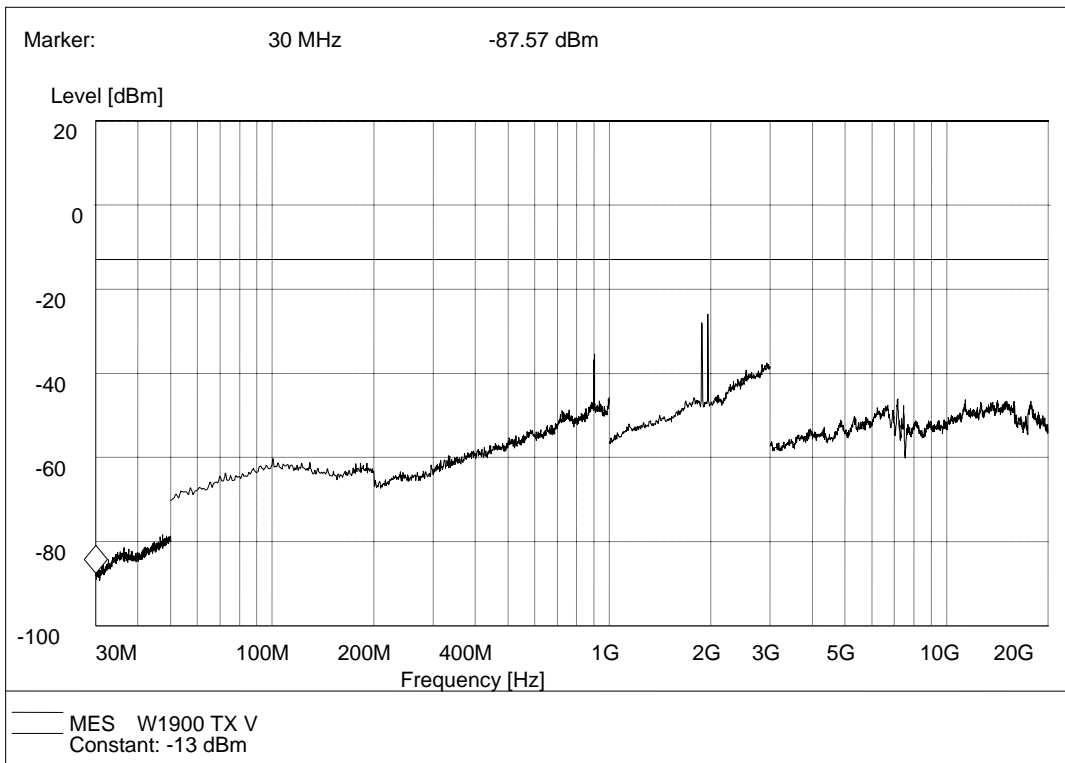

WCDMA 1900MHz, Test Antenna Vertical

3. LIST OF MEASURING EQUIPMENT

Radiated Emission					
Item	Test Equipment	Manufacturer	Model No.	Serial No.	Last Cal
1	Ultra-Broadband Antenna	ShwarzBeck	VULB9163	538	11/13/2016
2	EMI TEST RECEIVER	Rohde&Schwarz	ESI 26	100009	11/13/2016
3	EMI TEST Software	Audix	E3	N/A	N/A
4	TURNTABLE	ETS	2088	2149	N/A
5	ANTENNA MAST	ETS	2075	2346	N/A
6	EMI TEST Software	Rohde&Schwarz	ESK1	N/A	N/A
7	HORNANTENNA	ShwarzBeck	9120D	1011	11/13/2016
8	Amplifer	Sonoma	310N	E009-13	11/13/2016
9	JS amplifer	Rohde&Schwarz	JS4-00101800-2 8-5A	F201504	11/13/2016
10	High pass filter	Compliance Direction systems	BSU-6	34202	11/13/2016
11	HORNANTENNA	ShwarzBeck	9120D	1012	11/13/2016
12	Amplifer	Compliance Direction systems	PAP1-4060	120	11/13/2016
13	Loop Antenna	Rohde&Schwarz	HFH2-Z2	100020	11/13/2016
14	TURNTABLE	MATURO	TT2.0	----	N/A
15	ANTENNA MAST	MATURO	TAM-4.0-P	----	N/A
16	Horn Antenna	SCHWARZBECK	BBHA9170	25841	11/13/2016
17	ULTRA-BROADBAND ANTENNA	Rohde&Schwarz	HL562	100015	11/13/2016
18	UNIVERSAL RADIO COMMUNICATION	Rohde&Schwarz	CMU200	112012	11/13/2016

Maximum Peak Output Power / Power Spectral Density / 6dB Bandwidth / Band Edge Compliance of RF Emission / Spurious RF Conducted Emission					
Item	Test Equipment	Manufacturer	Model No.	Serial No.	Last Cal
1	Spectrum Analyzer	Rohde&Schwarz	FSP	1164.4391.40	11/13/2016
3	Spectrum Analyzer	Keysight	N9030A	ATO-67098	07/19/2016
4	Power Meter	Anritsu	ML2480B	100798	11/13/2016
5	Power Sensor	Anritsu	MA2411B	100258	11/13/2016
6	UNIVERSAL RADIO COMMUNICATION	Rohde&Schwarz	CMU200	112012	11/13/2016

4. UNCERTAINTY OF EVALUATION

Where relevant, the following measurement uncertainty levels have been estimated for tests performed on the EUT as specified in CISPR 16-4-2

Measurement	Frequency	Uncertainty
Radiated emissions	9KHz~40GHz	2.20dB
RF Conducted	9KHz~40GHz	1.60 dB

This uncertainty represents an expanded uncertainty expressed at approximately the 95% confidence level using a coverage factor of $k=2$.

**** END OF REPORT ****