



FCC SAR TEST REPORT

Report No.: SET2016-20884

Product: Industrial PDA

Brand Name: Atid

Model No.: AT870N

FCC ID: VUJAT870N

Applicant: ATID Co., Ltd.

Address: #1211 Byuksan/Kyungin Digitalvalley 11, 184, Gasan digital 2-ro, Geumcheon-gu. Seoul. Korea

Issued by: CCIC-SET

Lab Location: Building 28/29, East of Shigu, Xili Industrial Zone, Xili Road, Nanshan District, Shenzhen, Guangdong, China

Tel: 86 755 26627338 **Fax:** 86 755 26627238

Mail: manager@ccic-set.com **Website:** <http://www.ccic-set.com>

This test report consists of **158** pages in total. It may be duplicated completely for legal use with the approval of the applicant. It should not be reproduced except in full, without the written approval of our laboratory. The client should not use it to claim product endorsement by CCIC-SET. The test results in the report only apply to the tested sample. The test report shall be invalid without all the signatures of testing engineers, reviewer and approver. Any objections must be raised to CCIC-SET within 15 days since the date when the report is received. It will not be taken into consideration beyond this limit.



Test Report

Product: Industrial PDA
Model No.: AT870N
Brand Name.....: Atid
FCC ID.....: VUJAT870N
Applicant.....: ATID Co., Ltd.
Applicant Address.....: #1211 Byuksan/Kyungin Digitalvalley 11, 184, Gasan digital 2-ro, Geumcheon-gu, Seoul, Korea
Manufacturer.....: ATID Co., Ltd.
Manufacturer Address.....: #1211 Byuksan/Kyungin Digitalvalley 11, 184, Gasan digital 2-ro, Geumcheon-gu, Seoul, Korea
Test Standards.....: **47CFR § 2.1093-** Radiofrequency Radiation Exposure Evaluation: Portable Devices;
ANSI C95.1–1992: Safety Levels with Respect to Human Exposure to Radio Frequency Electromagnetic Fields, 3 kHz – 300 GHz.(IEEE Std C95.1-1991)
IEEE 1528–2013: IEEE Recommended Practice for Determining the Peak Spatial-Average Specific Absorption Rate (SAR) in the Human Head from Wireless Communications Devices: Measurement Techniques
Test Result.....: Pass
Tested by: Mei Chun 2016-10-10
Chun Mei, Test Engineer
Reviewed by.....: Shuangwen Zhang 2016-10-10
Shuangwen Zhang, Senior Engineer
Approved by.....: Wu Lian 2016-10-10
Wu Li'an , Manager



Contents

- 1. **GENERAL CONDITIONS**-----4
- 2. **ADMINISTRATIVE DATA**-----5
 - 2.1. Identification of the Responsible Testing Laboratory-----5
 - 2.2. Identification of the Responsible Testing Location(s)-----5
 - 2.3. Organization Item-----5
 - 2.4. Identification of Applicant-----5
 - 2.5. Identification of Manufacture-----5
- 3. **EQUIPMENT UNDER TEST (EUT)**-----6
- 4. **SAR SUMMAY**-----7
- 5. **Specific Absorption Rate(SAR)**-----8
 - 5.1. Introduction-----8
 - 5.2. SAR Definition-----8
 - 5.3. Phantoms-----9
 - 5.4. Device Holder-----9
 - 5.5. Probe Specification-----10
- 6. **OPERATIONAL CONDITIONS DURING TEST**-----11
 - 6.1. Schematic Test Configuration-----11
 - 6.2. SAR Measurement System-----11
 - 6.3. Equipments and results of validation testing-----13
 - 6.4. SAR measurement procedure-----15
 - 6.5. Antennas position and test position-----17
- 7. **CHARACTERISTICS OF THE TEST**-----18
 - 7.1. Applicable Limit Regulations-----18
 - 7.2. Applicable Measurement Standards-----18
- 8. **LABORATORY ENVIRONMENT**-----18
- 9. **CONDUCTED RF OUTPUT POWER**-----19
- 10. **TEST RESULTS**-----24
- 11. **MEASUREMENT UNCERTAINTY**-----30
- 12. **MAIN TEST INSTRUMENTS**-----33

This Test Report consists of the following Annexes:

Annex A: Test Layout -----	34
Annex B: Sample Photographs -----	38
Annex C: System Performance Check Data and Highest SAR Plots -----	40
Annex D: Calibration Certificate of Probe and Dipoles -----	87

1. GENERAL CONDITIONS

1.1 This report only refers to the item that has undergone the test.

1.2 This report standalone does not constitute or imply by its own an approval of the product by the certification Bodies or competent Authorities.

1.3 This document is only valid if complete; no partial reproduction can be made without written approval of CCIC-SET

1.4 This report cannot be used partially or in full for publicity and/or promotional purposes without previous written approval of CCIC-SET and the Accreditation Bodies, if it applies.



2. Administrative Date

2.1. Identification of the Responsible Testing Laboratory

Company Name: CCIC-SET

Department: EMC & RF Department

Address: Building 28/29, East of Shigu, Xili Industrial Zone, Xili Road,
Nanshan District, Shenzhen, Guangdong, China

Telephone: +86-755-26629676

Fax: +86-755-26627238

**Responsible Test Lab
Managers:** Mr. Wu Li'an

2.2. Identification of the Responsible Testing Location(s)

Company Name: CCIC-SET

Address: Building 28/29, East of Shigu, Xili Industrial Zone, Xili Road,
Nanshan District, Shenzhen, Guangdong, China

2.3. Organization Item

CCIC-SET Report No.: SET2016-20884

CCIC-SET Project Leader: Mr. Li Sixiong

**CCIC-SET Responsible
for accreditation scope:** Mr. Wu Li'an

Start of Testing: 2016-09-19

End of Testing: 2016-09-28

2.4. Identification of Applicant

Company Name: ATID Co., Ltd.

Address: #1211 Byuksan/Kyungin Digitalvalley 11, 184, Gasan digital
2-ro, Geumcheon-gu, Seoul, Korea

2.5. Identification of Manufacture

Company Name: ATID Co., Ltd.

Address: #1211 Byuksan/Kyungin Digitalvalley 11, 184, Gasan digital
2-ro, Geumcheon-gu, Seoul, Korea

Notes: This data is based on the information by the applicant.

3. Equipment Under Test (EUT)

3.1. Identification of the Equipment under Test

Sample Name: Industrial PDA

Model Name: AT870N

Brand Name: Atid

General description:	Support Band	GSM850MHz/1900MHz/900MHz/1800MHz WCDMA 850MHz/1900MHz,WIFI, BT,RFID
	Test Band	GSM 850MHz/ GSM 1900MHz, WCDMA 850MHz/1900MHz, WIFI2.4G, WIFI5G,RFID
	Multislot Class	GPRS: Class 12; EGPRS: Class 12
	GPRS Class	Class B
	Development Stage	Identical Prototype
	Accessories	Power Supply
	Antenna type	Inner Antenna
	Operation mode	GSM / WCDMA /WIFI/RFID
	Modulation mode	GSM(GMSK),UMTS(QPSK),WIFI(OFDM/DSSS)
	Hardware version	AT870N_MA_V3.0.1
	Software version	ENGSTD_0576_512_R4
	Max. RF Power	32.29dBm
	Max. SAR Value	Head: 1.229W/kg; Body-Worn: 0.479W/kg; Hotspot: 0.788W/kg (10mm distance)

NOTE:

- a. The above EUT's information was declared by manufacturer. Please refer to the specifications or user's manual for more detailed description.
- b. This device supports GPRS operation up to class12 (max.uplin:4, max.downlink:4, total timeslots:5). This device supports EDGE operation up to class12(max.uplin:4, max.downlink:4, total timeslots:5)



4 SAR SUMMARY

Highest Standalone SAR Summary

Exposure Position	Frequency Band	Scaled 1g-SAR(W/kg)	Highest Scaled 1g-SAR(W/kg)
Head	GSM850	1.068	1.229
	GSM1900	0.241	
	WCDMA Band V	1.229	
	WCDMA Band II	0.622	
	WIFI	0.230	
Body-worn Accessory (10mm Gap)	GSM850	0.396	0.479
	GSM1900	0.365	
	WCDMA Band V	0.427	
	WCDMA Band II	0.479	
	WIFI	0.161	
	RFID	0.335	
Hotspot (10mm Gap)	GSM850	0.680	0.788
	GSM1900	0.707	
	WCDMA Band V	0.782	
	WCDMA Band II	0.788	
	WIFI	0.215	

Highest Simultaneous SAR Summary

Exposure Position	Frequency Band	Highest Scaled 1g-SAR(W/kg)
Head	WWAN(WCDMA850)&WIFI	1.365
Body-worn (10mmGap)	WWAN(WCDMA1900)&WIFI	0.538
Hotspot (10mmGap)	WWAN(WCDMA1900)&WIFI	0.788

5 Specific Absorption Rate (SAR)

5.1 Introduction

SAR is related to the rate at which energy is absorbed per unit mass in an object exposed to a radio field. The SAR distribution in a biological body is complicated and is usually carried out by experimental techniques or numerical modeling. The standard recommends limits for two tiers of groups, occupational/controlled and general population/uncontrolled, based on a person's awareness and ability to exercise control over his or her exposure. In general, occupational/controlled exposure limits are higher than the limits for general population/uncontrolled.

5.2 SAR Definition

The SAR definition is the time derivative (rate) of the incremental energy (dW) absorbed by (dissipated in) an incremental mass (dm) contained in a volume element (dv) of a given density (ρ). The equation description is as below:

$$\text{SAR} = \frac{d}{dt} \left(\frac{dW}{dm} \right) = \frac{d}{dt} \left(\frac{dW}{\rho dv} \right)$$

SAR is expressed in units of Watts per kilogram (W/kg)

SAR measurement can be either related to the temperature elevation in tissue by

$$\text{SAR} = C \frac{\delta T}{\delta t}$$

where C is the specific heat capacity, δT is the temperature rise and δt the exposure duration, or related to the electrical field in the tissue by

$$\text{SAR} = \frac{\sigma |E|^2}{\rho}$$

where σ is the conductivity of the tissue, ρ is the mass density of the tissue and E is the rms electrical field strength.

However for evaluating SAR of low power transmitter, electrical field measurement is typically applied.

5.3 Phantoms

The phantom used for all tests i.e. for both system checks and device testing, was the twin-headed "SAM Phantom", manufactured by SATIMO. The SAM twin phantom is a fiberglass shell phantom with 2mm shell thickness (except the ear region, where shell thickness increases to 6mm).

System checking was performed using the flat section, whilst Head SAR tests used the left and right head profile sections. Body SAR testing also used the flat section between the head profiles.



SAM Twin Phantom

5.4 Device Holder

The device was placed in the device holder (illustrated below) that is supplied by SATIMO as an integral part of the COMOSAR test system.

The device holder is designed to cope with the different positions given in the standard. It has two scales for device rotation (with respect to the body axis) and device inclination (with respect to the line between the ear reference points). The rotation centers for both scales is the ear reference point (ERP). Thus the device needs no repositioning when changing the angles.

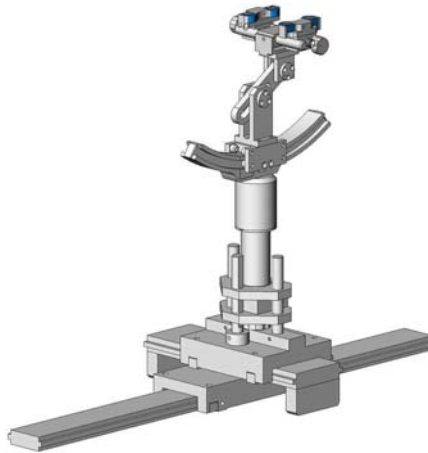

Device holder

5.5 Probe Specification



Construction	Symmetrical design with triangular core Interleaved sensors Built-in shielding against static charges PEEK enclosure material (resistant to organic solvents, e.g., DGBE)
Calibration	ISO/IEC 17025 calibration service available.
Frequency	700 MHz to 3 GHz; Linearity: ± 0.5 dB (700 MHz to 3 GHz)
Directivity	± 0.25 dB in HSL (rotation around probe axis) ± 0.5 dB in tissue material (rotation normal to probe axis)
Dynamic Range	1.5 μ W/g to 100 mW/g; Linearity: ± 0.5 dB
Dimensions	Overall length: 330 mm (Tip: 20 mm) Tip diameter: 5 mm Distance from probe tip to dipole centers: <2.7 mm
Application	General dosimetry up to 3 GHz Dosimetry in strong gradient fields Compliance tests of Industrial PDAs
Compatibility	COMOSAR

Isotropic E-Field Probe

The isotropic E-Field probe has been fully calibrated and assessed for isotropicity, and boundary effect within a controlled environment. Depending on the frequency for which the probe is calibrated the method utilized for calibration will change.

The E-Field probe utilizes a triangular sensor arrangement as detailed in the diagram below:

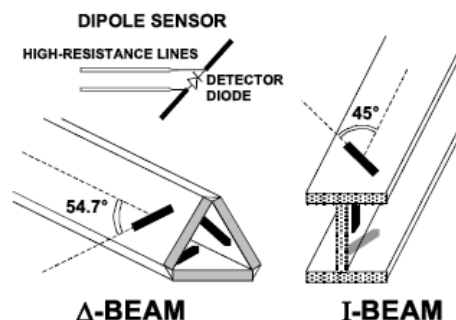

6 OPERATIONAL CONDITIONS DURING TEST

6.1 Schematic Test Configuration

During SAR test, EUT was operating in Traffic Mode (Channel Allocated) at Normal Voltage Condition. A communication link is set up with a System Simulator (SS) by air link, and a call is established. The EUT was commanded to operate at maximum transmitting power.

The EUT should use its internal transmitter. The antenna(s), battery and accessories shall be those specified by the manufacturer. The EUT battery must be fully charged and checked periodically during the test to ascertain uniform power output. If a wireless link was used, the antenna connected to the output of the base station simulator shall be placed at least 50 cm away from the handset.

The signal transmitted by the simulator to the antenna feeding point should be lower than the output power level of the handset by at least 35 dB

6.2 SAR Measurement System

The SAR measurement system being used is the SATIMO system, the system is controlled remotely from a PC, which contains the software to control the robot and data acquisition equipment. The software also displays the data obtained from test scans.

In operation, the system first does an area (2D) scan at a fixed depth within the liquid from the inside wall of the phantom. When the maximum SAR point has been found, the system will then carry out a 3D scan centred at that point to determine volume averaged SAR level.

6.2.1 Tissue Dielectric Parameters for Head and Body Phantoms

The head tissue dielectric parameters recommended by the IEEE SCC-34/SC-2 in P1528 have been incorporated in the following table. These head parameters are derived from planar layer models simulating the highest expected SAR for the dielectric properties and tissue thickness Power drifts in a human head. Other head and body tissue parameters that have not been specified in P1528 are derived from the tissue dielectric parameters computed from the 4-Cole-Cole equations described in Reference [12] and extrapolated according to the head parameters specified in P1528.

Table 1: Recommended Dielectric Performance of Tissue

Ingredients (% by weight)	Frequency (MHz)											
	450		835		915		1900		2450		2600	
Tissue Type	Head	Body	Head	Body	Head	Body	Head	Body	Head	Body	Head	Body
Water	38.56	51.16	41.46	52.4	41.05	56.0	54.9	40.4	62.7	73.2	55.24	64.49
Salt (Nacl)	3.95	1.49	1.45	1.4	1.35	0.76	0.18	0.5	0.5	0.04	0.5	0.024
Sugar	56.32	46.78	56.0	45.0	56.5	41.76	0.0	58.0	0.0	0.0	0.0	0.0
HEC	0.98	0.52	1.0	1.0	1.0	1.21	0.0	1.0	0.0	0.0	0.0	0.0
Bactericide	0.19	0.05	0.1	0.1	0.1	0.27	0.0	0.1	0.0	0.0	0.0	0.0
Triton x-100	0.0	0.0	0.0	0.0	0.0	0.0	0.0	0.0	36.8	0.0	44.45	32.25

DGBE	0.0	0.0	0.0	0.0	0.0	0.0	44.92	0.0	0.0	26.7	0.0	26.7
Dielectric Constant	43.42	58.0	42.54	56.1	42.0	56.8	39.9	54.0	39.8	52.5	39.0	52.5
Conductivity (s/m)	0.85	0.83	0.91	0.95	1.0	1.07	1.42	1.45	1.88	1.78	1.96	2.16

Table 2 Recommended Tissue Dielectric Parameters

Frequency (MHz)	Head Tissue		Body Tissue	
	ϵ_r	$\sigma(S/m)$	ϵ_r	$\sigma(S/m)$
150	52.3	0.76	61.9	0.80
300	45.3	0.87	58.2	0.92
450	43.5	0.87	56.7	0.94
835	41.5	0.90	55.2	0.97
900	41.5	0.97	55.0	1.05
915	41.5	0.98	55.0	1.06
1450	40.5	1.20	54.0	1.30
1610	40.3	1.29	53.8	1.40
1800-2000	40.0	1.40	53.3	1.52
2450	39.2	1.80	52.7	1.95
3000	38.5	2.40	52.0	2.73
5800	35.3	5.27	48.2	6.00

6.2.2 Simulate liquid

For measurements against the phantom head, the “cheek” and “tilt” position on both the left hand and the right hand sides of the phantom. For body-worn measurements, the EUT was tested against flat phantom representing the user body. The EUT was put on in the belt holder. Stimulate liquid that are used for testing at frequencies of GSM 850MHz/1900MHz, WCDMA850MHz/1900MHz, and Wi-Fi, RFID, which are made mainly of sugar, salt and water solutions may be left in the phantoms.

Table 3: Dielectric Performance of Head Tissue Simulating Liquid

Temperature: 23.2°C; Humidity: 64%;			
/	Frequency	Permittivity ϵ	Conductivity σ (S/m)
Target value	850MHz	$41.5 \pm 5\%$	$0.90 \pm 5\%$
Validation value (Sep. 26th, 2016)	850MHz	41.89	0.89
Target value	1900MHz	$40.0 \pm 5\%$	$1.40 \pm 5\%$
Validation value (Sep. 28th, 2016)	1900MHz	39.42	1.30
Target value	2450MHz	$39.2 \pm 5\%$	$1.80 \pm 5\%$
Validation value (Sep. 24th, 2016)	2450MHz	39.20	1.80
Target value	5800MHz	$35.3 \pm 5\%$	$5.27 \pm 5\%$
Validation value (Sep. 24th, 2016)	5800MHz	35.39	5.30

Table 4: Dielectric Performance of Body Tissue Simulating Liquid

Temperature: 23.2°C; Humidity: 64%;			
/	Frequency	Permittivity ϵ	Conductivity σ (S/m)
Target value	850MHz	$55.2 \pm 5\%$	$0.97 \pm 5\%$
Validation value (Sep. 19th, 2016)	850MHz	55.23	0.98
Target value	1900MHz	$53.3 \pm 5\%$	$1.52 \pm 5\%$
Validation value (Sep. 20th, 2016)	1900MHz	53.26	1.50
Target value	2450MHz	$52.7 \pm 5\%$	$1.95 \pm 5\%$
Validation value (Sep. 21th, 2016)	2450MHz	54.66	1.90
Target value	5800MHz	$48.2 \pm 5\%$	$6.0 \pm 5\%$
Validation value (Sep. 21th, 2016)	5800MHz	47.64	5.84

6.3 Results of validation testing

Prior to the assessment, the system validation kit was used to test whether the system was operating within its specifications of $\pm 10\%$. The validation results are tabulated below. And also the corresponding SAR plot is attached as well in the SAR plots files.

The following procedure, recommended for performing validation tests using box phantoms is based on the procedures described in the IEEE standard P1528. Setup according to the setup diagram below:

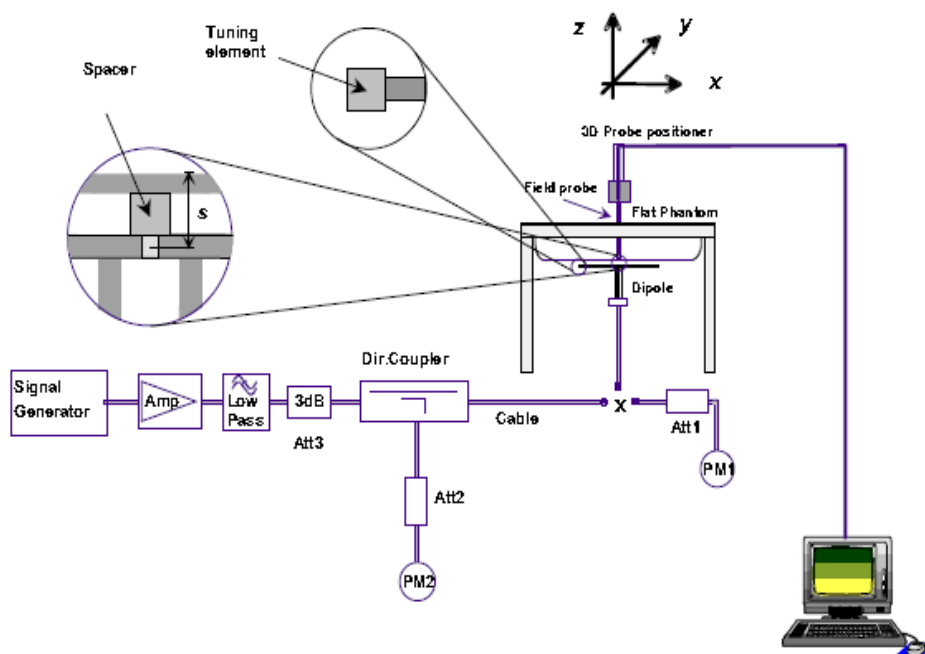

With the SG and Amp and with directional coupler in place, set up the source signal at the relevant frequency and use a power meter to measure the power at the end of the SMA cable that you intend to connect to the balanced dipole. Adjust the SG to make this, say, 0.01W (10 dBm). If this level is too high to read directly with the power meter sensor, insert

a calibrated attenuator (e.g. 10 or 20 dB) and make a suitable correction to the power meter reading.

Note 1: In this method, the directional coupler is used for monitoring rather than setting the exact feed power level. If, however, the directional coupler is used for power measurement, you should check the frequency range and power rating of the coupler and measure the coupling factor (referred to output) at the test frequency using a VNA.

Note 2: Remember that the use of a 3dB attenuator (as shown in Figure 8.1 of P1528) means that you need an RF amplifier of 2 times greater power for the same feed power. The other issue is the cable length. You might get up to 1dB of loss per meter of cable, so the cable length after the coupler needs to be quite short.

Note 3: For the validation testing done using CW signals, most power meters are suitable. However, if you are measuring the output of a modulated signal from either a signal generator or a handset, you must ensure that the power meter correctly reads the modulated signals.

The measured 1-gram averaged SAR values of the device against the phantom are provided in Tables 5 and Table 6. The humidity and ambient temperature of test facility were 64% and 23.2°C respectively. The body phantom were full of the body tissue simulating liquid. The EUT was supplied with full-charged battery for each measurement.

The distance between the back of the EUT and the bottom of the flat phantom is 10 mm (taking into account of the IEEE 1528 and the place of the antenna).

Table 5: Head SAR system validation (1g)

Frequency	Duty cycle	Target value (W/kg)	Test value (W/kg)	
			10 mW	1W
835MHz(Sep. 26th, 2016)	1:1	$9.77 \pm 10\%$	0.0993	9.93
1900MHz(Sep. 28th, 2016)	1:1	$40.37 \pm 10\%$	0.4060	40.60
2450MHz(Sep. 24th, 2016)	1:1	$53.60 \pm 10\%$	0.5239	52.39
5800MHz(Sep. 24th, 2016)	1:1	$181.89 \pm 10\%$	1.7314	173.14

Table 6: Body SAR system validation (1g)

Frequency	Duty cycle	Target value (W/kg)	Test value (W/kg)	
			10 mW	1W
835MHz(Sep. 19th, 2016)	1:1	$10.31 \pm 10\%$	0.1031	10.31
1900MHz(Sep. 20th, 2016)	1:1	$40.81 \pm 10\%$	0.2163	21.63
2450MHz(Sep. 21th, 2016)	1:1	$52.66 \pm 10\%$	0.5359	53.59
5800MHz(Sep. 21th, 2016)	1:1	$176.72 \pm 10\%$	1.7987	179.87

* Note: Target value was referring to the measured value in the calibration certificate of reference dipole.

Note: All SAR values are normalized to 1W forward power.

6.4 SAR measurement procedure

The SAR test against the head phantom was carried out as follow:

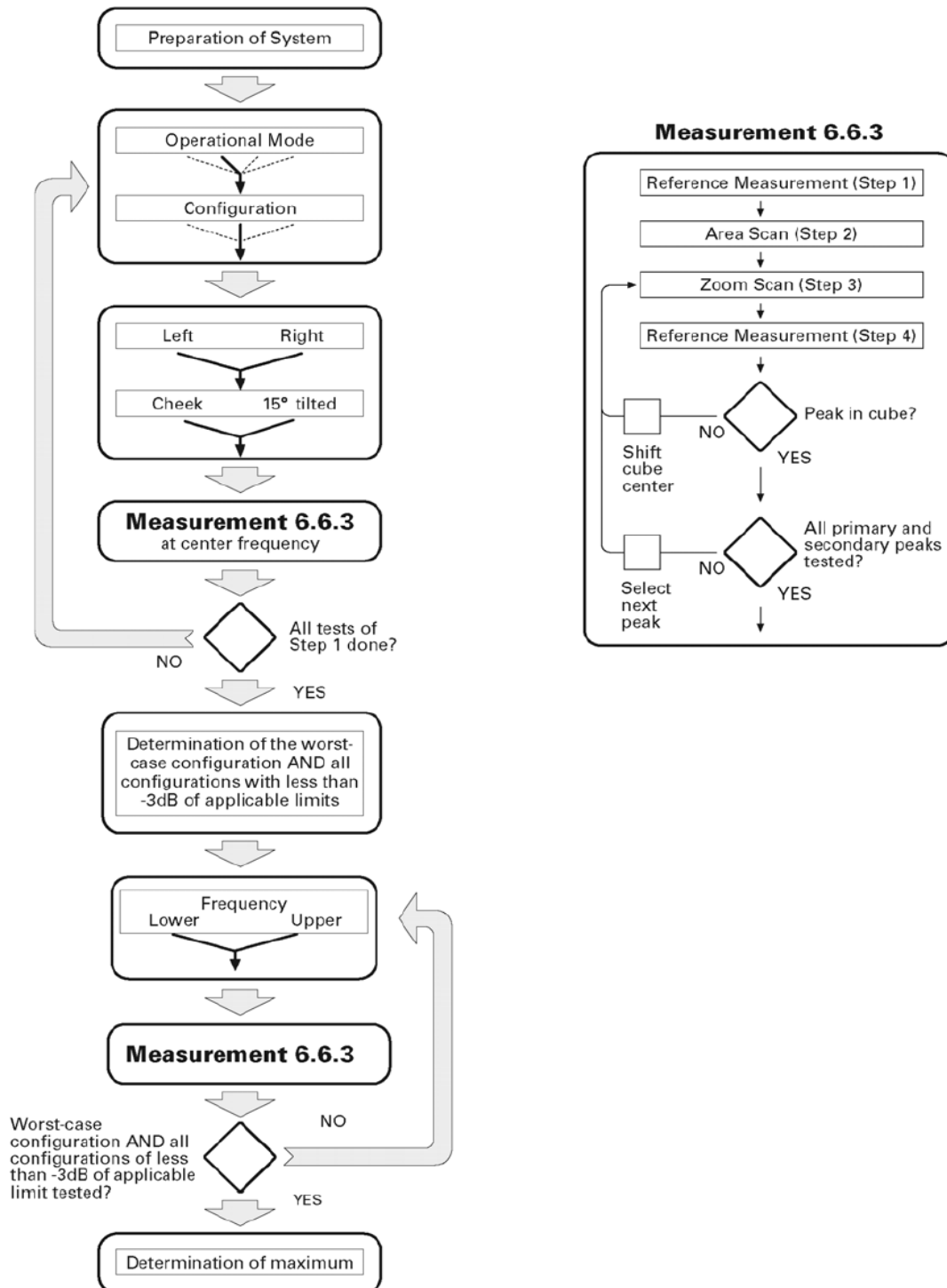

Establish a call with the maximum output power with a base station simulator, the connection between the EUT and the base station simulator is established via air interface.

After an area scan has been done at a fixed distance of 2mm from the surface of the phantom on the source side, a 3D scan is set up around the location of the maximum spot SAR. First, a point within the scan area is visited by the probe and a SAR reading taken at the start of testing. At the end of testing, the probe is returned to the same point and a

second reading is taken. Comparison between these start and end readings enables the power drift during measurement to be assessed.

Above is the scanning procedure flow chart and table from the IEEE p1528 standard. This is the procedure for which all compliant testing should be carried out to ensure that all variations of the device position and transmission behavior are tested.

For SAR measurement, the liquid deep max more than 15cm as below photo

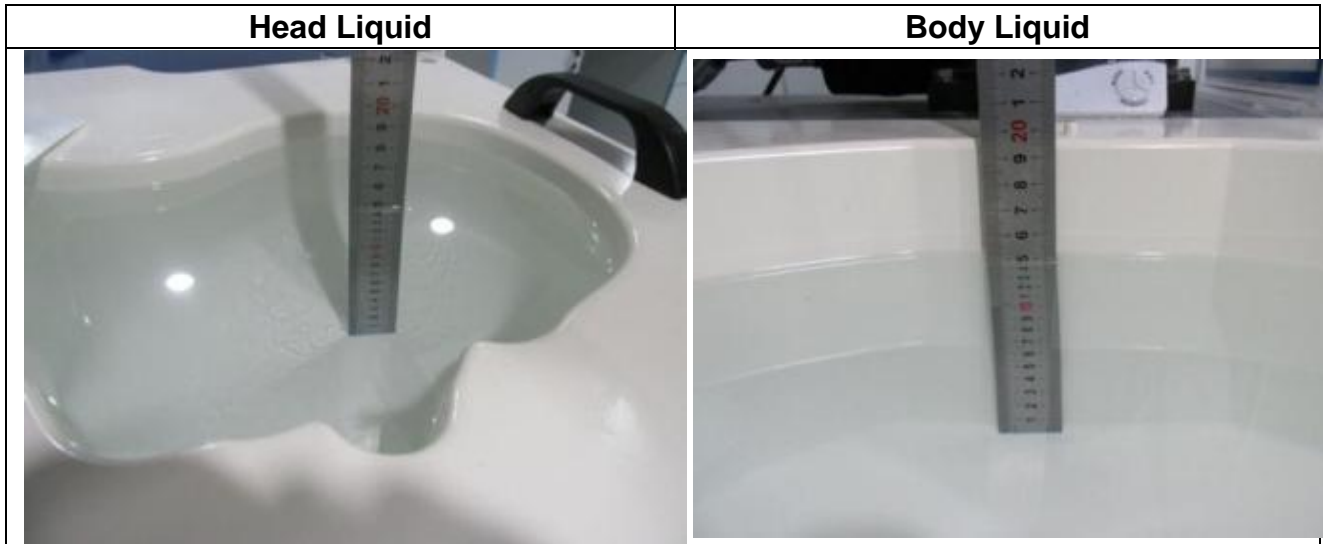

6.5 Transmitting antenna information

The GSM&WCDMA&WIFI&BT antennas inside the EUT.



The Body SAR measurement positions of each band are as below:

Antenna	Front	Back	Edge A	Edge B	Edge C	Edge D
WWAN Antenna Body-worn	Yes	Yes	No	No	No	No
WWAN Antenna hotspot	Yes	Yes	Yes	No	No	Yes
WLAN Antenna Body-worn	Yes	Yes	No	No	No	No
WLAN Antenna hotspot	Yes	Yes	No	Yes	Yes	No
RFID Antenna Body-support	Yes	Yes	Yes	Yes	No	Yes

Note: According to KDB 941225 D06 v02r01, when antenna-to-edge>2.5cm, SAR is not required.



7 CHARACTERISTICS OF THE TEST

7.1 Applicable Limit Regulations

47CFR § 2.1093- Radiofrequency Radiation Exposure Evaluation: Portable Devices;

ANSI C95.1–1992: Safety Levels with Respect to Human Exposure to Radio Frequency Electromagnetic Fields, 3 kHz – 300 GHz.(IEEE Std C95.1-1991)

IEEE 1528–2013: IEEE Recommended Practice for Determining the Peak Spatial-Average Specific Absorption Rate (SAR) in the Human Head from Wireless Communications Devices: Measurement Techniques

It specifies the maximum exposure limit of **1.6 W/kg** as averaged over any 1 gram of tissue for portable devices being used within 20 cm of the user in the uncontrolled environment.

7.2 Applicable Measurement Standards

The Specific Absorption Rate (SAR) testing specification, method, and procedure for this is in accordance with the following standards:

FCC 47 CFR Part2 (2.1093)

ANSI/IEEE C95.1-1992

IEEE 1528-2013

FCC KDB 248227 D01 802.11 Wi-Fi SAR v02r02

FCC KDB 447498 D01 v06 General RF Exposure Guidance

FCC KDB 648474 D04 v01r03 Handset SAR

FCC KDB 865664 D01 v01r04 SAR Measurement 100MHz to 6GHz

FCC KDB 865664 D02 v01r02 SAR Exposure Reporting

FCC KDB 941225 D01 v03r01 3G SAR Procedures

FCC KDB 941225 D06 v02r01 Hotspot Mode

FCC KDB 941225 D04 v01 Evaluating SAR for GSM/(E)GPRS Dual Transfer Mode

8 LABORATORY ENVIRONMENTS

The Ambient Conditions during SAR Test

Temperature	Min. = 22 ° C, Max. = 25 ° C
Atmospheric pressure	Min.=86 kPa, Max.=106 kPa
Relative humidity	Min. = 45%, Max. = 75%
Ground system resistance	< 0.5 Ω

Ambient noise is checked and found very low and in compliance with requirement of standards. Reflection of surrounding objects is minimized and in compliance with requirement of standards.

9. Conducted RF Output Power

9.1 GSM Conducted Power

Band		Burst Average Power (dBm)			Frame-Average Power (dBm)		
GSM850	TX Channel	128	190	251	128	190	251
	Frequency(MHz)	824.2	836.6	848.8	824.2	836.6	848.8
	GSM	32.29	32.11	32.08	22.92	23.10	22.89
	GPRS (Slot 1)	32.11	32.02	32.01	22.92	22.83	22.82
	GPRS (Slot 2)	29.36	29.34	29.31	23.23	23.21	23.18
	GPRS (Slot 3)	27.82	27.93	27.86	23.40	23.51	23.44
	GPRS (Slot 4)	26.75	26.88	26.69	23.57	23.70	23.51
	EDGE (Slot 1)	27.39	27.15	27.13	18.20	17.96	17.94
	EDGE (Slot 2)	25.11	25.13	25.08	18.98	19.00	18.95
	EDGE (Slot 3)	23.53	23.61	23.52	19.11	19.19	19.10
EDGE (Slot 4)	22.42	22.58	22.61	19.24	19.40	19.43	

Band		Burst Average Power (dBm)			Frame-Average Power (dBm)		
GSM1900	TX Channel	512	661	810	512	661	810
	Frequency(MHz)	1850.2	1880	1909.8	1850.2	1880	1909.8
	GSM	29.80	29.54	29.41	20.61	20.35	20.22
	GPRS (Slot 1)	29.38	29.34	29.25	20.19	20.15	20.06
	GPRS (Slot 2)	27.31	27.12	27.21	21.18	20.99	21.08
	GPRS (Slot 3)	25.88	25.79	25.71	21.46	21.37	21.29
	GPRS (Slot 4)	24.98	24.91	24.93	21.80	21.73	21.75
	EDGE (Slot 1)	25.76	25.27	25.11	16.57	16.08	15.92
	EDGE (Slot 2)	23.12	23.25	23.18	16.99	17.12	17.05
	EDGE (Slot 3)	21.48	21.53	21.55	17.06	17.11	17.13
EDGE (Slot 4)	20.56	20.62	20.55	17.38	17.44	17.37	

Note: Per KDB 447498 D01 v06, the maximum output power channel is used for SAR testing and for further SAR test reduction.

For hotspot SAR, EUT was performed at GPRS Class 12 multi-slots(4TX) mode

Timeslot consignations

No. Of Slots	Slot 1	Slot 2	Slot 3	Slot 4
Slot Consignation	1Up4Down	2UpDown	3UpDown	4Up1Down
Duty Cycle	1:8	1:4	1:2.67	1:2
Crest Factor	-9.19dB	-6.13dB	-4.42dB	-3.18dB



9.2 WCDMA Conducted output Power

Item	band	WCDMA 850			WCDMA 1900		
	ARFCN	4132	4183	4233	9262	9400	9538
	subtest	dBm			dBm		
RMC 12.2kbps	non	24.19	24.06	24.11	23.36	23.64	23.53
HSDPA	1	22.25	22.31	22.28	22.08	22.03	22.06
	2	21.85	21.87	21.81	21.79	21.83	21.77
	3	21.72	21.67	21.74	21.58	21.61	21.65
	4	21.57	21.62	21.75	21.28	21.25	21.21
HSUPA	1	22.29	22.23	22.27	21.91	21.89	21.87
	2	21.79	21.81	21.84	21.74	21.69	21.67
	3	21.81	21.75	21.88	21.65	21.57	21.61
	4	21.66	21.63	21.69	21.54	21.48	21.52
	5	21.47	21.31	21.32	21.15	21.18	21.21

Note:

1. WCDMA SAR was tested under PMC 12.2kbps with HSPA Inactive per KDB Publication 941225 D01v03r01. HSPA SAR was not required since the average output power of the HSPA subtests was not more than 0.25dB higher than the RMC level and SAR was less than 1.2W/kg.
2. It is expected by the manufacturer that MPR for some HSPA subtests may be up to 2dB more than specified by 3GPP, but also as low as 0dB according to the chipset implementation in this model.

WLAN 2.4GHz Band Conducted Power

Channel/Freq.(MHz)	Maximum Conducted Out Power (dBm)		
	802.11b	802.11g	802.11n(HT20)
1(2412)	18.10	18.14	18.64
6(2437)	18.49	18.62	18.70
11(2462)	17.22	17.01	17.04

WLAN 5GHz Band Conducted Power

Average Conducted Output Power (dBm)		
Test Frequency(MHz)	802.11a mode	802.11n-HT20 mode
5745	11.47	11.46
5785	12.07	11.73
5825	11.92	11.78

Note:

1. Per KDB248227 D01 v02r02, choose the highest output power channel to test SAR and determine further SAR exclusion
2. For each frequency band, testing at higher data rates and higher order modulations is not required when the maximum average output power for each of these configurations is less than 1/4dB higher than those measured at lowest data rate
3. Per KDB248227 D01 v02r02, 802.11g /11n-HT20/11n-HT40 is not required. . When the highest reported SAR for DSSS is adjusted by the ratio of OFDM to DSSS specified maximum output power and the adjusted SAR is $\leq 1.2W/Kg$. Thus the SAR can be excluded.

Bluetooth Output Power

Channel	Frequency (MHz)	BT3.0 Output Power(dBm)
		GFSK
CH 0	2402	-0.203
CH 39	2441	-0.135
CH 78	2480	-0.669

RFID Output Power

Channel	Frequency (MHz)	Conducted Output Power(dBm)
1	902.75	29.114
26	915.25	29.354
50	927.25	29.048

**SAR test Exclusion and estimate SAR calculation:****Note:**

1. Per KDB 447498 D01v06, the 1-g and 10-g SAR test exclusion thresholds for 100MHz to 6GHz at test separation distances $\leq 50\text{mm}$ are determined by: [(max. power of channel, including tune-up tolerance, mW)/(min. test separation distance, mm)] $\cdot [\sqrt{f}$ (GHz)] ≤ 3.0 for 1-g SAR and ≤ 7.5 for 10-g extremity SAR
- (1) f(GHz) is the RF channel transmit frequency in GHz
 (2) Power and distance are round to the nearest mW and mm before calculation
 (3) The result is rounded to one decimal place for comparison
 (4) If the test separation distance(antenna-user) is $< 5\text{mm}$, 5mm is used for excluded SAR calculation
 (5)

BT3.0	Max Power (dBm)	mW	Test Distance (mm)	Frequency(GHz)	Exclusion Thresholds
	1	1.259	5	2.45	0.394

Per KDB 447498 D01v06 exclusion thresholds is $0.394 < 3$, RF exposure evaluation is not required.

BT estimated SAR value=Exclusion Thresholds/7.5= $0.394/7.5=0.053\text{W/Kg}$

BT3.0	Max Power (dBm)	mW	Test Distance (mm)	Frequency(GHz)	Exclusion Thresholds
	1	1.259	10	2.45	0.197

Per KDB 447498 D01v06 exclusion thresholds is 0.197 RF exposure evaluation is not required.

BT estimated SAR value=Exclusion Thresholds/7.5= $0.197/7.5=0.026\text{Kg}$

The estimated SAR value is used for simultaneous transmission analysis.



General Note:

1. Per KDB 447498 D01v06, the reported SAR is the measured SAR value adjusted for maximum tune-up tolerance.
2. Per KDB447498 D01v06, testing of other required channels within the operating mode of a frequency band is not required when the reported 1-g or 10-g SAR for the mid-band or highest output power channel is: ≤ 0.8 W/kg or 2.0 W/kg, for 1-g or 10-g respectively, when the transmission band is ≤ 100 MHz. When the maximum output power variation across the required test channels is $> \frac{1}{2}$ dB, instead of the middle channel, the highest output power channel must be used.
3. Per KDB941225 D06 v02r01, the DUT Dimension is bigger than 9 cm x 5 cm, so 10mm is chosen as the test separation distance for Hotspot mode. When the antenna-to-edge distance is greater than 2.5cm, such position does not need to be tested. As the manufacture required, the separation distance use 5mm for Hotspot mode.
4. Per KDB 865664 D01v01r04, for each frequency band, repeated SAR measurement is required only when the measured SAR is ≥ 0.8 W/Kg; if the deviation among the repeated measurement is $\leq 20\%$, and the measured SAR < 1.45 W/Kg, only one repeated measurement is required.
5. Per KDB865664 D02 v01r02, SAR plot is only required for the highest measured SAR in each exposure configuration, wireless mode and frequency band combination; Plots are also required when the measured SAR is > 1.5 W/kg, or > 7.0 W/kg for occupational exposure. The published RF exposure KDB procedures may require additional plots; for example, to support SAR to peak location separation ratio test exclusion and/or volume scan post-processing(Refer to appendix D for details).
6. Per KDB941225 D04 v01, when multiple slots can be used, the GPRS/EDGE slot configuration with the highest frame-averaged output power was selected for SAR testing.
7. Per KDB941225 D01 v03r01, when the maximum output power and tune-up tolerance specified for production units in a secondary mode is $\leq \frac{1}{4}$ dB higher than the primary mode or when the highest reported SAR of the primary mode is scaled by the ratio of specified maximum output power and tune-up tolerance of secondary to primary mode and the adjusted SAR is ≤ 1.2 W/kg, SAR measurement is not required for the secondary mode.
8. Per KDB248227 D01 v02r02, 802.11g /11n-HT20/11n-HT40 is not required. When the highest reported SAR for DSSS is adjusted by the ratio of OFDM to DSSS specified maximum output power and the adjusted SAR is ≤ 1.2 W/Kg. Thus the SAR can be excluded.



9.3. Scaling Factor calculation

Operation Mode	Channel	Output Power(dBm)	Tune up Power in tolerance(dBm)	Scaling Factor
GSM 850	128	32.29	31.5 ± 1.0	1.050
	190	32.11	31.5 ± 1.0	1.094
	251	32.08	31.5 ± 1.0	1.102
GPRS 850(4Tx)	128	26.75	26.0 ± 1.0	1.059
	190	26.88	26.0 ± 1.0	1.028
	251	26.69	26.0 ± 1.0	1.074
GSM1900	512	29.80	29.0 ± 1.0	1.047
	661	29.54	29.0 ± 1.0	1.112
	810	29.41	29.0 ± 1.0	1.146
GPRS1900(4Tx)	512	24.98	24.0 ± 1.0	1.005
	661	24.91	24.0 ± 1.0	1.021
	810	24.93	24.0 ± 1.0	1.016
WCDMA850	4132	24.19	23.5 ± 1.0	1.074
	4183	24.06	23.5 ± 1.0	1.107
	4233	24.11	23.5 ± 1.0	1.094
WCDMA1900	9262	23.36	23.0 ± 1.0	1.159
	9400	23.64	23.0 ± 1.0	1.086
	9538	23.53	23.0 ± 1.0	1.114
WIFI 802.11b	1	18.10	18.0 ± 1.0	1.230
	6	18.49	18.0 ± 1.0	1.125
	11	17.22	18.0 ± 1.0	1.507
WIFI 802.11a	149	11.47	11.5 ± 1.0	1.268
	157	12.07	11.5 ± 1.0	1.104
	165	11.92	11.5 ± 1.0	1.143
BT	78	-0.135	0 ± 1.0	1.299
RFID	1	29.114	28.5 ± 1.0	1.093
	26	29.354	28.5 ± 1.0	1.034
	50	29.048	28.5 ± 1.0	1.110

10 TEST RESULTS

10.1 Summary of SAR Measurement Results

Table 7: SAR Values of GSM 850MHz Band

Temperature: 23.0~23.5°C, humidity: 62~64%. Without RFID component							
Test Positions		Channel /Frequency (MHz)	SAR(W/Kg), 1.6 (1g average)			Plot No.	
			SAR (W/Kg),1g	Scaled Factor	Scaled SAR(W/Kg) ,1g		
Right Side of Head	Cheek	190/836.6	0.685	1.094	0.749	--	
	Tilt 15 degrees	128/824.2	0.945	1.050	0.992	--	
		190/836.6	0.976	1.094	1.068	1	
		251/848.8	0.923	1.102	1.017	--	
		128/824.2 Repeat	0.915	1.050	0.961	--	
		190/836.6 Repeat	0.956	1.094	1.046	--	
		251/848.8 Repeat	0.902	1.102	0.994	--	
Left Side of Head	Cheek	190/836.6	0.446	1.094	0.488	--	
	Tilt 15 degrees	190/836.6	0.560	1.094	0.613	--	
Body-worn (10mm Separation)	GSM	Face Upward	190/836.6	0.362	1.094	0.396	2
		Back Upward	190/836.6	0.265	1.094	0.290	--
Hotspot (10mm Separation)	GPRS (4Tx)	Face Upward	190/836.6	0.291	1.028	0.299	--
		Back Upward	190/836.6	0.202	1.028	0.208	--
		Edge A	190/836.6	0.661	1.028	0.680	3
		Edge D	190/836.6	0.082	1.028	0.084	--

Table 8: SAR Values of GSM1900 MHz Band

Temperature: 23.0~23.5°C, humidity: 62~64%. Without RFID component							
Test Positions		Channel /Frequency (MHz)	SAR(W/Kg), 1.6 (1g average)			Plot No.	
			SAR (W/Kg),1g	Scaled Factor	Scaled SAR(W/Kg),1g		
Right Side of Head	Cheek	661/1880.0	0.196	1.112	0.218	--	
	Tilt 15 degrees	661/1880.0	0.217	1.112	0.241	4	
Left Side of Head	Cheek	661/1880.0	0.078	1.112	0.087	--	
	Tilt 15 degrees	661/1880.0	0.104	1.112	0.116	--	
Body-worn (10mm Separation)	GSM	Face Upward	661/1880.0	0.149	1.112	0.166	--
		Back Upward	661/1880.0	0.328	1.112	0.365	5
Hotspot (10mm Separation)	GPRS (4Tx)	Face Upward	661/1880.0	0.253	1.021	0.258	--
		Back Upward	661/1880.0	0.236	1.021	0.241	--
		Edge A	661/1880.0	0.278	1.021	0.284	--
		Edge D	661/1880.0	0.692	1.021	0.707	6

Table 9: SAR Values of WCDMA850

Temperature: 23.0~23.5°C, humidity: 62~64%. Without RFID component						
Test Positions		Channel /Frequency (MHz)	SAR(W/Kg), 1.6 (1g average)			Plot No.
			SAR (W/Kg), 1g	Scaled Factor	Scaled SAR(W/Kg),1g	
Right Side of Head	Cheek	4183/836.6	0.597	1.107	0.661	--
	Tilt 15 degrees	4132/826.4	1.096	1.074	1.177	--
		4183/836.6	1.110	1.107	1.229	7
		4233/846.6	1.058	1.094	1.157	--
		4132/826.4 Repeat	1.036	1.074	1.113	--
		4183/836.6 Repeat	1.055	1.107	1.168	--
		4233/846.6 Repeat	1.046	1.094	1.144	--
Left Side of Head	Cheek	4183/836.6	0.225	1.107	0.249	--
	Tilt 15 degrees	4183/836.6	0.699	1.107	0.774	--
Body-worn (10mm Separation)	Face Upward	4183/836.6	0.361	1.107	0.400	--
	Back Upward	4183/836.6	0.386	1.107	0.427	--
Hotspot (10mm Separation)	Face Upward	4183/836.6	0.361	1.107	0.400	--
	Back Upward	4183/836.6	0.386	1.107	0.427	--
	Edge A	4183/836.6	0.706	1.107	0.782	8
	Edge D	4183/836.6	0.233	1.107	0.258	--

Table 10: SAR Values of WCDMA1900

Temperature: 23.0~23.5°C, humidity: 62~64%. Without RFID component						
Test Positions		Channel /Frequency (MHz)	SAR(W/Kg), 1.6 (1g average)			Plot No.
			SAR (W/Kg),1g	Scaled Factor	Scaled SAR(W/Kg),1g	
Right Side of Head	Cheek	9400/1880	0.512	1.086	0.556	--
	Tilt 15 degrees	9400/1880	0.573	1.086	0.622	9
Left Side of Head	Cheek	9400/1880	0.423	1.086	0.459	--
	Tilt 15 degrees	9400/1880	0.511	1.086	0.555	--
Body-worn (10mm Separation)	Face Upward	9400/1880	0.316	1.086	0.343	--
	Back Upward	9400/1880	0.441	1.086	0.479	--
Hotspot (10mm Separation)	Face Upward	9400/1880	0.316	1.086	0.343	--
	Back Upward	9400/1880	0.441	1.086	0.479	--
	Edge A	9400/1880	0.726	1.086	0.788	10
	Edge D	9400/1880	0.469	1.086	0.509	--

Table 15: SAR Values of Wi-Fi 802.11b

Temperature: 23.0~23.5°C, humidity: 62~64%. Without RFID component						
Test Positions		Channel /Frequency (MHz)	SAR(W/Kg), 1.6 (1g average)			Plot No.
			SAR(W/Kg)1g	Scaled Factor	Scaled SAR(W/Kg),1g	
Right Side of Head	Cheek	6/2437	0.204	1.125	0.230	11
	Tilt 15 degrees	6/2437	0.121	1.125	0.136	--
Left Side of Head	Cheek	6/2437	0.165	1.125	0.186	--
	Tilt 15 degrees	6/2437	0.097	1.125	0.109	--
Body-worn (10mm Separation)	Face Upward	6/2437	0.143	1.125	0.161	--
	Back Upward	6/2437	0.052	1.125	0.059	--
Hotspot (10mm Separation)	Face Upward	6/2437	0.143	1.125	0.161	--
	Back Upward	6/2437	0.052	1.125	0.059	--
	Edge B	6/2437	0.191	1.125	0.215	12
	Edge C	6/2437	0.113	1.125	0.127	--



Table 16: SAR Values of Wi-Fi 802.11a

Temperature: 23.0~23.5°C, humidity: 62~64%. Without RFID component						
Test Positions		Channel /Frequency (MHz)	SAR(W/Kg), 1.6 (1g average)			Plot No.
			SAR(W/Kg)1g	Scaled Factor	Scaled SAR(W/Kg),1g	
Right Side of Head	Cheek	157/5785	0.175	1.104	0.193	13
	Tilt 15 degrees	157/5785	0.115	1.104	0.127	--
Left Side of Head	Cheek	157/5785	0.158	1.104	0.174	--
	Tilt 15 degrees	157/5785	0.143	1.104	0.158	--
Body-worn (10mm Separation)	Face Upward	157/5785	0.115	1.104	0.127	--
	Back Upward	157/5785	0.051	1.104	0.056	--
	Edge B	157/5785	0.139	1.104	0.153	14
	Edge C	157/5785	0.088	1.104	0.097	--

Table 17: SAR Values of RFID

Test Positions		Channel /Frequency (MHz)	SAR(W/Kg), 1.6 (1g average)			Plot No.
			SAR(W/Kg)1g Peak)	Scaled Factor	Scaled SAR(W/Kg),1g	
Body (10mm Separation)	Face Upward	26/915.25	0.124	1.034	0.128	--
	Back Upward	26/915.25	0.132	1.034	0.136	--
	Edge A	26/915.25	0.324	1.034	0.335	15
	Edge B	26/915.25	0.089	1.034	0.092	--
	Edge D	26/915.25	0.091	1.034	0.094	--

Note:

Per KDB Publication 941225 D01v03r01. RMC 12.2kbps was as primary mode SAR, when the primary mode SAR less than 1.2W/kg, secondary SAR (HSPA) was not requires.

When the 1-g SAR for the mid-band channel or the channel with the highest output power satisfy the following conditions, testing of the other channels in the band is not required. (Per KDB 447498 D01 General RF Exposure Guidance v06)

- ≤ 0.8 W/kg, when the transmission band is ≤ 100 MHz
- ≤ 0.6 W/kg, when the transmission band is between 100 MHz and 200 MHz
- ≤ 0.4 W/kg, when the transmission band is ≥ 200 MHz



10.2 Simultaneous Transmissions Analysis

Localized Specific Absorption Rate (SAR) of this portable wireless device has been measured in all cases requested by the relevant standards cited in Clause 6 of this report. Maximum localized SAR is **below** exposure limits specified in the relevant standards.

Simultaneous SAR

No.	Transmitter Combinations	Scenario Supported or not	Supported for Mobile Hotspot or not
1	GSM+ BT	Yes	No
2	GSM + WIFI	Yes	Yes
3	WCDMA +BT	Yes	No
4	WCDMA +WIFI	Yes	Yes
5	GSM+ RFID	Yes	No
6	WCDMA +RFID	Yes	No



Test Position		Right Cheek	Right Title	Left Cheek	Left Tilt
Head MAX 1-g SAR(W/Kg)	GSM850	0.749	1.068	0.488	0.613
	GSM1900	0.218	0.241	0.087	0.116
	WCDMA850	0.661	1.229	0.249	0.774
	WCDMA1900	0.556	0.622	0.459	0.555
	WIFI 802.11b	0.230	0.136	0.186	0.109
	WIFI 802.11a	0.193	0.127	0.174	0.158
	BT	*0.053	*0.053	*0.053	*0.053
WIFI Simultaneous Σ 1-g SAR(W/Kg)		0.979	1.365	0.674	0.849
BT Simultaneous Σ 1-g SAR(W/Kg)		0.802	1.282	0.541	0.827

Simultaneous Tx Combination of GSM/WCDMA and BT/WIFI (Head).

Test Position		Face	Back	Edge A	Edge B	Edge C	Edge D
Body-worn 10mm separation MAX 1-g SAR(W/Kg)	GSM850	0.396	0.290	--	--	--	--
	GSM1900	0.166	0.365	--	--	--	--
	WCDMA850	0.400	0.427	--	--	--	--
	WCDMA1900	0.343	0.479	--	--	--	--
	WIFI 802.11b	0.161	0.059	--	--	--	--
	WIFI 802.11a	0.127	0.056	--	--	--	--
	RFID	0.128	0.136	--	--	--	--
	BT	*0.026	*0.026	--	--	--	--
WIFI Simultaneous Σ 1-g SAR(W/Kg)		0.561	0.538	--	--	--	--
BT Simultaneous Σ 1-g SAR(W/Kg)		0.426	0.505	--	--	--	--

Simultaneous Tx Combination of GSM/WCDMA and BT/WIFI (Body).

Test Position		Face	Back	Edge A	Edge B	Edge C	Edge D
Hotspot 10mm separation MAX 1-g SAR(W/Kg)	GPRS850	0.299	0.208	0.680	--	--	0.084
	GPRS1900	0.258	0.241	0.284	--	--	0.707
	WCDMA 850	0.400	0.427	0.782	--	--	0.258
	WCDMA 1900	0.343	0.479	0.788	--	--	0.509
	WIFI 802.11b	0.161	0.059	--	0.215	0.127	--
	WIFI 802.11a	0.127	0.056	--	0.153	0.097	--
	BT	*0.026	*0.026	--	--	--	*0.026
WIFI Simultaneous Σ 1-g SAR(W/Kg)		0.561	0.538	--	--	--	--
BT Simultaneous Σ 1-g SAR(W/Kg)		0.426	0.505	--	--	--	0.733

Simultaneous Tx Combination of GSM/WCDMA and BT/WIFI (Body).

The estimated SAR value with * Signal

SAR to Peak Location Separation Ratio (SPLSR)

As the Sum of the SAR is not greater than 1.6 W/kg SPLSR assessment is not required

11 Measurement Uncertainty

No.	Uncertainty Component	Type	Uncertainty Value (%)	Probability Distribution	k	ci	Standard Uncertainty (%) $u_i(\%)$	Degree of freedom ν_{eff} or ν_i
Measurement System								
1	– Probe Calibration	B	5.8	N	1	1	5.8	∞
2	– Axial isotropy	B	3.5	R	$\sqrt{3}$	0.5	1.43	∞
3	– Hemispherical Isotropy	B	5.9	R	$\sqrt{3}$	0.5	2.41	∞
4	– Boundary Effect	B	1	R	$\sqrt{3}$	1	0.58	∞
5	– Linearity	B	4.7	R	$\sqrt{3}$	1	2.71	∞
6	– System Detection Limits	B	1.0	R	$\sqrt{3}$	1	0.58	∞
7	Modulation response	B	3	N	1	1	3.00	
8	– Readout Electronics	B	0.5	N	1	1	0.50	∞
9	– Response Time	B	1.4	R	$\sqrt{3}$	1	0.81	∞
10	– Integration Time	B	3.0	R	$\sqrt{3}$	1	1.73	∞
11	– RF Ambient Conditions	B	3.0	R	$\sqrt{3}$	1	1.73	∞
12	– Probe Position Mechanical tolerance	B	1.4	R	$\sqrt{3}$	1	0.81	∞
13	– Probe Position with respect to Phantom Shell	B	1.4	R	$\sqrt{3}$	1	0.81	∞
14	– Extrapolation, Interpolation and Integration Algorithms for Max. SAR evaluation	B	2.3	R	$\sqrt{3}$	1	1.33	∞
Uncertainties of the DUT								
15	– Position of the DUT	A	2.6	N	$\sqrt{3}$	1	2.6	5
16	– Holder of the DUT	A	3	N	$\sqrt{3}$	1	3.0	5



17	- Output Power Variation -SAR drift measurement	B	5.0	R	$\sqrt{3}$	1	2.89	∞
Phantom and Tissue Parameters								
18	- Phantom Uncertainty(shape and thickness tolerances)	B	4	R	$\sqrt{3}$	1	2.31	∞
19	Uncertainty in SAR correction for deviation(in permittivity and conductivity)	B	2	N	1	1	2.00	
20	- Liquid Conductivity Target -tolerance	B	2.5	R	$\sqrt{3}$	0.6	1.95	∞
21	- Liquid Conductivity -measurement Uncertainty)	B	4	N	$\sqrt{3}$	1	0.92	9
22	- Liquid Permittivity Target tolerance	B	2.5	R	$\sqrt{3}$	0.6	1.95	∞
23	- Liquid Permittivity -measurement uncertainty	B	5	N	$\sqrt{3}$	1	1.15	∞
Combined Standard Uncertainty				RSS			10.63	
Expanded uncertainty (Confidence interval of 95 %)				K=2			21.26	

System Check Uncertainty

No.	Uncertainty Component	Type	Uncertainty Value (%)	Probability Distribution	k	ci	Standard Uncertainty (%) $u_i(\%)$	Degree of freedom v_{eff} or v_i
Measurement System								
1	- Probe Calibration	B	5.8	N	1	1	5.8	∞
2	- Axial isotropy	B	3.5	R	$\sqrt{3}$	0.5	1.43	∞
3	- Hemispherical Isotropy	B	5.9	R	$\sqrt{3}$	0.5	2.41	∞
4	- Boundary Effect	B	1	R	$\sqrt{3}$	1	0.58	∞
5	- Linearity	B	4.7	R	$\sqrt{3}$	1	2.71	∞
6	- System Detection Limits	B	1	R	$\sqrt{3}$	1	0.58	∞
7	Modulation response	B	0	N	1	1	0.00	



8	– Readout Electronics	B	0.5	N	1	1	0.50	∞
9	– Response Time	B	0.00	R	$\sqrt{3}$	1	0.00	∞
10	– Integration Time	B	1.4	R	$\sqrt{3}$	1	0.81	∞
11	– RF Ambient Conditions	B	3.0	R	$\sqrt{3}$	1	1.73	∞
12	– Probe Position Mechanical tolerance	B	1.4	R	$\sqrt{3}$	1	0.81	∞
13	– Probe Position with respect to Phantom Shell	B	1.4	R	$\sqrt{3}$	1	0.81	∞
14	– Extrapolation, Interpolation and Integration Algorithms for Max. SAR evaluation	B	2.3	R	$\sqrt{3}$	1	1.33	∞
Uncertainties of the DUT								
15	Deviation of experimental source from numerical source	A	4	N	1	1	4.00	5
16	Input Power and SAR drift measurement	A	5	R	$\sqrt{3}$	1	2.89	5
17	Dipole Axis to Liquid Distance	B	2	R	$\sqrt{3}$	1	1.2	∞
Phantom and Tissue Parameters								
18	– Phantom Uncertainty(shape and thickness tolerances)	B	4	R	$\sqrt{3}$	1	2.31	∞
19	Uncertainty in SAR correction for deviation(in permittivity and conductivity)	B	2	N	1	1	2.00	
20	– Liquid Conductivity Target –tolerance	B	2.5	R	$\sqrt{3}$	0.6	1.95	∞
21	– Liquid Conductivity –measurement Uncertainty)	B	4	N	$\sqrt{3}$	1	0.92	9
22	– Liquid Permittivity Target tolerance	B	2.5	R	$\sqrt{3}$	0.6	1.95	∞
23	– Liquid Permittivity –measurement uncertainty	B	5	N	$\sqrt{3}$	1	1.15	∞
Combined Standard Uncertainty				RSS			10.15	
Expanded uncertainty (Confidence interval of 95 %)				K=2			20.29	

**12 MAIN TEST INSTRUMENTS**

EQUIPMENT	TYPE	Series No.	Calibration Date	calibration period
System Simulator	CMW500	130805	2016/08/10	1 Year
SAR Probe	SATIMO	SN43/15 EP276	2015/12/09	1 Year
SAR Probe	SATIMO	SN27/15 EPGO261	2016/07/09	1 Year
Dipole	SID835	SN09/13 DIP0G835-217	2014/08/28	3 Year
Dipole	SID1800	SN09/13 DIP1G800-216	2014/08/28	3 Year
Dipole	SID1900	SN09/13 DIP1G900-218	2014/08/28	3 Year
Dipole	SID2450	SN09/13 DIP2G450-220	2014/08/28	3 Year
Dipole	5G-6GHz	SN15/15 WGA 39	2016/06/01	1 Year
Vector Network Analyzer	ZVB8	A0802530	2016/06/08	1 Year
Signal Generator	SMR27	A0304219	2016/06/08	1 Year
Power Meter	NRP2	A140401673	2016/03/27	1 Year
Power Sensor	NPR-Z11	1138.3004.02-114072-nq	2016/03/27	1 Year
Amplifier	Nucletudes	143060	2016/03/27	1 Year
Directional Coupler	DC6180A	305827	2016/03/27	1 Year
Power Meter	NRVS	A0802531	2016/03/27	1 Year
Power Sensor	NRV-Z4	100069	2016/03/27	1 Year
Multimeter	Keithley-2000	4014020	2016/03/27	1 Year



ANNEX A

of

CCIC-SET

CONFORMANCE TEST REPORT FOR

HUMAN EXPOSURE TO ELECTROMAGNETIC FIELDS

SET2016-20884

Industrial PDA

Type Name: AT870N

**Hardware Version: **

**Software Version: **

TEST SETUP

This Annex consists of 4 pages

Date of Report: 2016-10-10

Photo 1: Measurement System SATIMO



Photo 2: Right Head Cheek

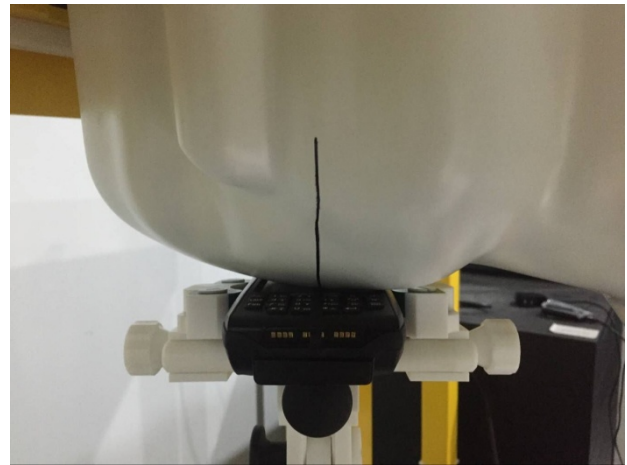

Photo 3: Right Head Tilt



Photo 4: Left Head Cheek

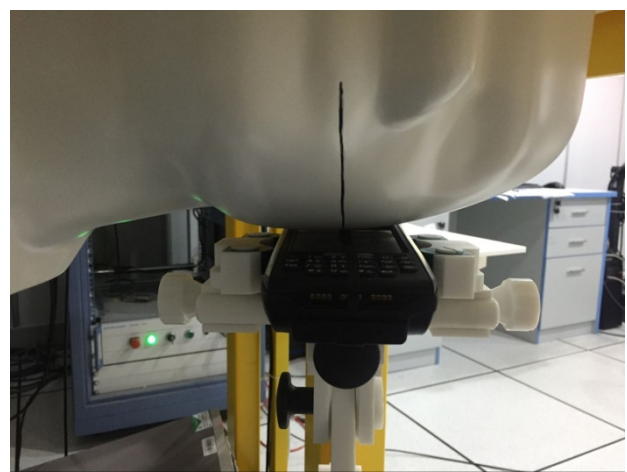

Photo 5: Left Head Tilt



Photo 6: Body-Worn/hotspot Front(10mm)

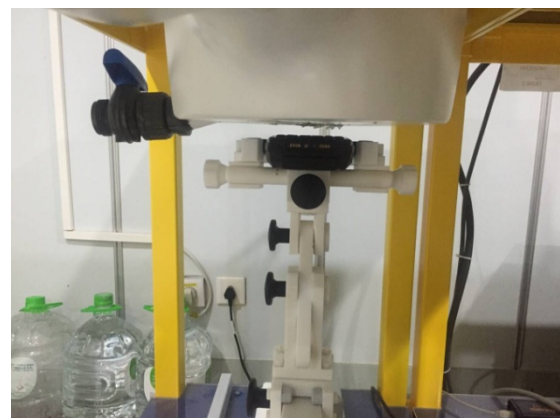

Photo 7: Body-Worn/hotspot Back(10mm)



Photo 8: Edge A(10mm)

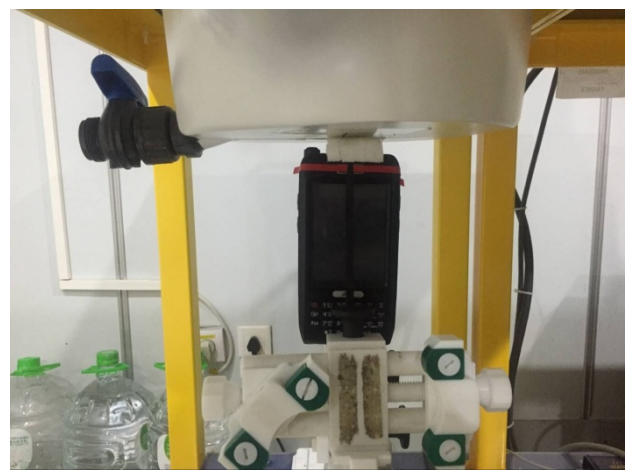

Photo 9: Edge B(10mm)

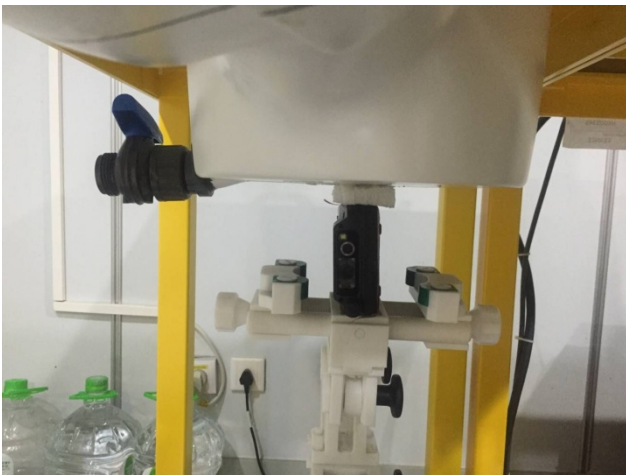

Photo 10: Edge C(10mm)

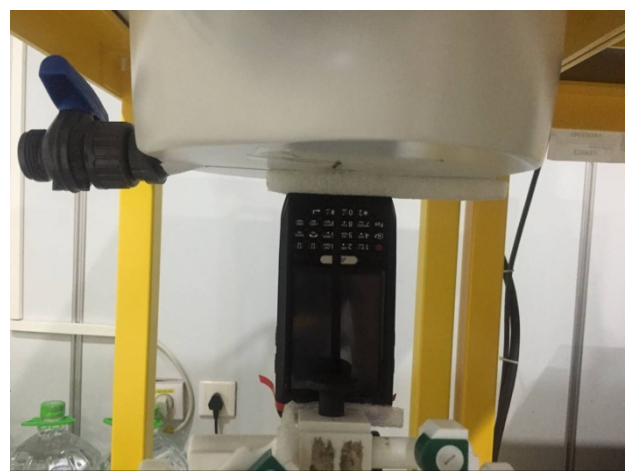

Photo 11: Edge D(10mm)



Photo 12: RFID FACE(10mm)

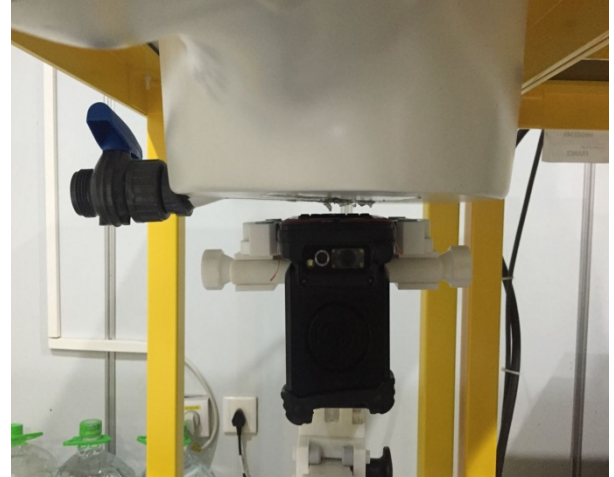

Photo 13: RFID Back(10mm)



Photo 14: RFID Edge A(10mm)



Photo 15: RFID Edge B(10mm)

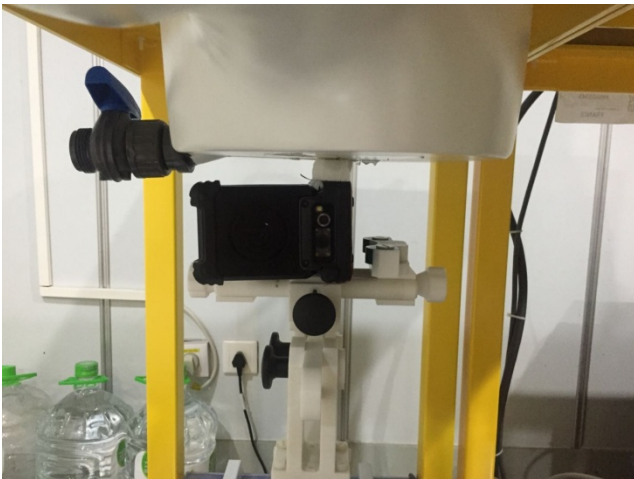
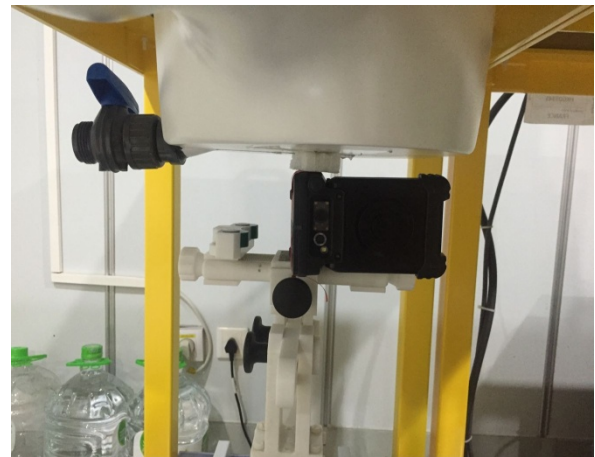

Photo 16: RFID Edge D(10mm)





ANNEX B
of
CCIC-SET

CONFORMANCE TEST REPORT FOR
HUMAN EXPOSURE TO ELECTROMAGNETIC FIELDS

SET2016-20884

Industrial PDA

Type Name: AT870N

Hardware Version: AT870N_MA_V3.0.1

Software Version: ENGSTD_0576_512_R4

Sample Photographs

This Annex consists of 2 page

Date of Report: 2016-10-10

1. Appearance

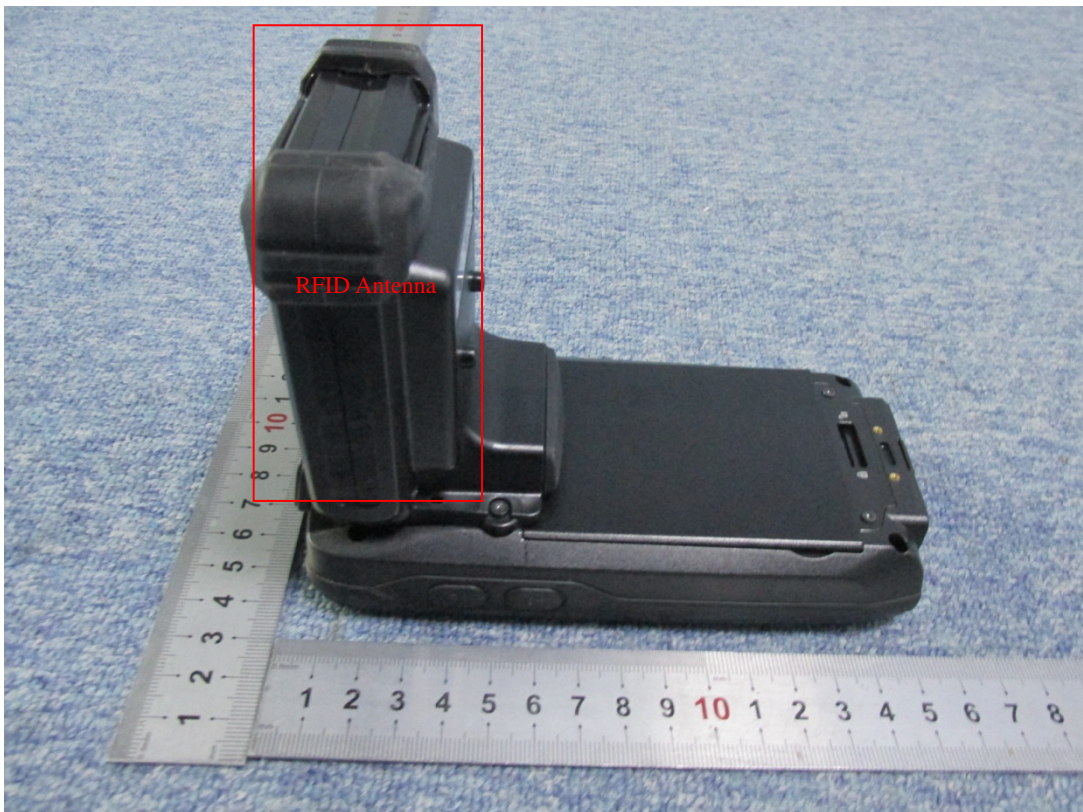



ANNEX C
of
CCIC-SET

CONFORMANCE TEST REPORT FOR
HUMAN EXPOSURE TO ELECTROMAGNETIC FIELDS

SET2016-20884

Industrial PDA

Type Name: AT870N

Hardware Version: AT870N_MA_V3.0.1

Software Version: ENGSTD_0576_512_R4

System Performance Check Data and Highest SAR Plots

This Annex consists of 47 pages

Date of Report: 2016-10-10

System Performance Check (Head, 835MHz)

Type: Validation measurement

Area scan resolution: dx=8mm,dy=8mm

Zoom scan resolution: dx=8mm, dy=8mm, dz=5mm

Date of measurement: 26/09/2016

Measurement duration: 22 minutes 15 seconds

A. Experimental conditions.

Phantom File	dx=8mm dy=8mm
Phantom	5x5x7,dx=8mm dy=8mm dz=5mm
Device Position	
Band	835MHz
Channels	
Signal	CW

B. SAR Measurement Results

Band SAR

E-Field Probe	SATIMO SN_43/15_EP276
Frequency (MHz)	835
Relative permittivity (real part)	41.85
Relative permittivity	19.24
Conductivity (S/m)	0.87
Power drift (%)	-0.22
Ambient Temperature:	23.2°C
Liquid Temperature:	23.5°C
ConvF:	6.81
Duty factor:	1:1

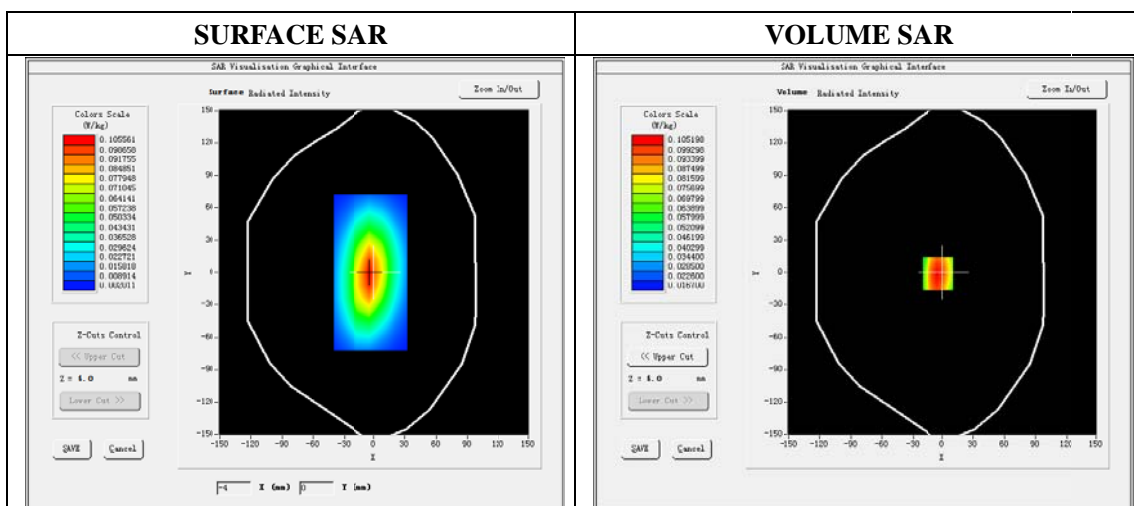

Maximum location: X=-5.00, Y=-1.00

SAR 10g (W/Kg)	0.064060
SAR 1g (W/Kg)	0.099340

Z (mm)	0.00	4.00	8.00	12.00	16.00
SAR (W/Kg)	0.1432	0.1015	0.0742	0.0554	0.0423

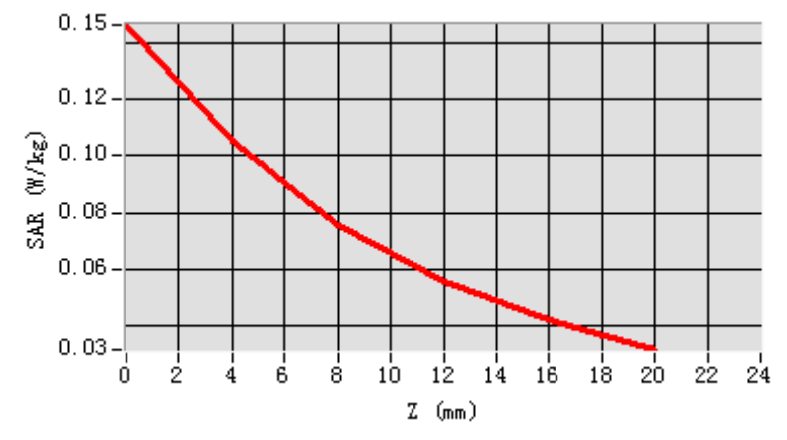

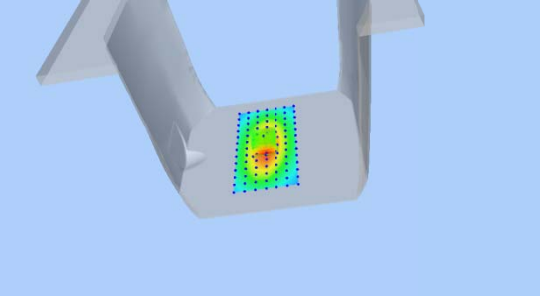
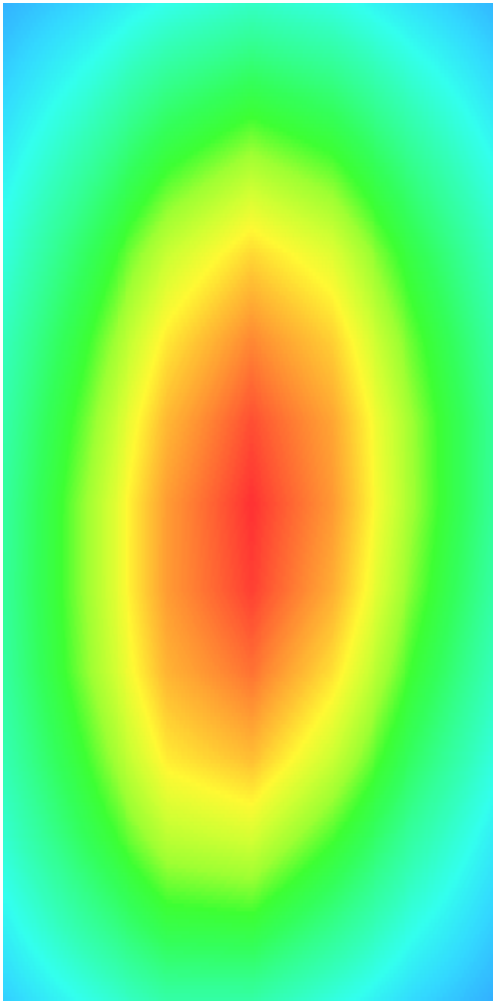
3D screen shot	Hot spot position
	

System Performance Check (Head, 1900MHz)

Type: Validation measurement

Area scan resolution: dx=8mm,dy=8mm

Zoom scan resolution: dx=8mm, dy=8mm, dz=5mm

Date of measurement: 28/09/2016

Measurement duration: 22 minutes 21seconds

A. Experimental conditions.

Phantom File	dx=8mm dy=8mm
Phantom	5x5x7,dx=8mm dy=8mm dz=5mm
Device Position	
Band	1900MHz
Channels	
Signal	CW

B. SAR Measurement Results

Band SAR

E-Field Probe	SATIMO SN_43/15_EP276
Frequency (MHz)	1900
Relative permittivity (real part)	39.42
Relative permittivity	13.17
Conductivity (S/m)	1.30
Power drift (%)	-0.68
Ambient Temperature:	22.2°C
Liquid Temperature:	22.5°C
ConvF:	6.05
Duty factor:	1:1

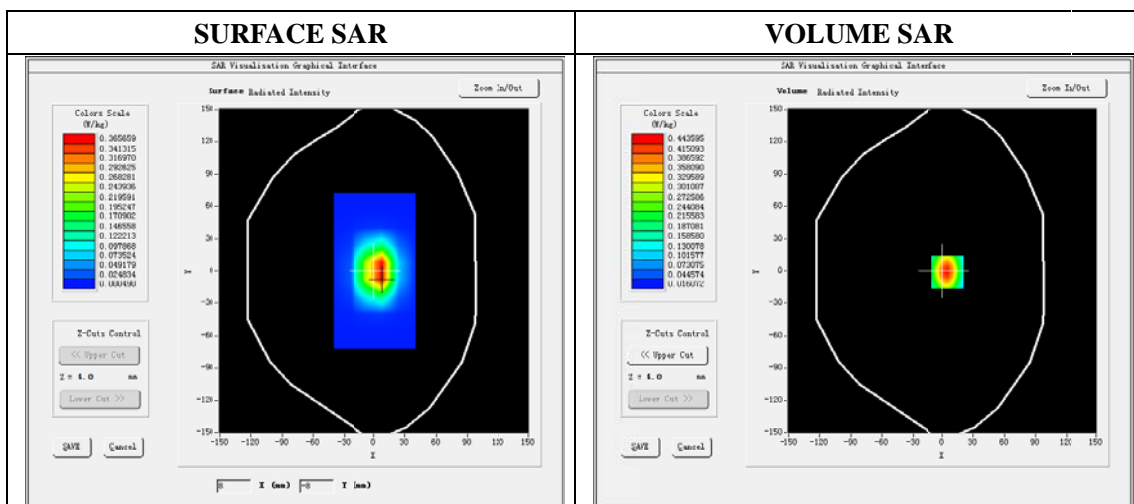

Maximum location: X=5.00, Y=-1.00

SAR 10g (W/Kg)	0.215880
SAR 1g (W/Kg)	0.406011

Z (mm)	0.00	4.00	8.00	12.00	16.00
SAR (W/Kg)	0.6733	0.4475	0.2865	0.1914	0.1313

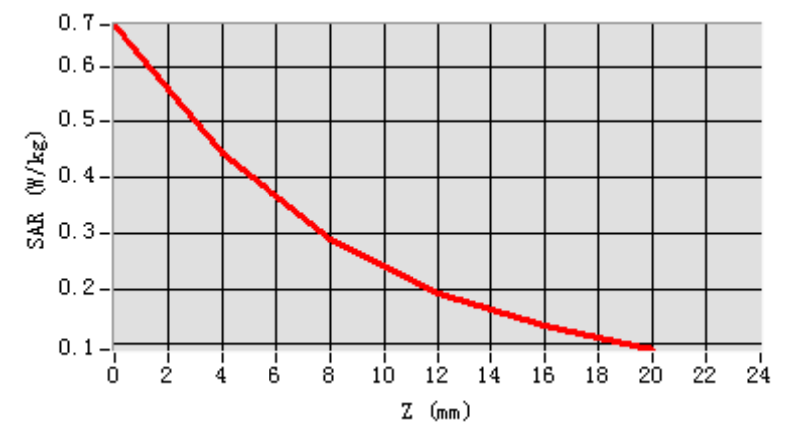

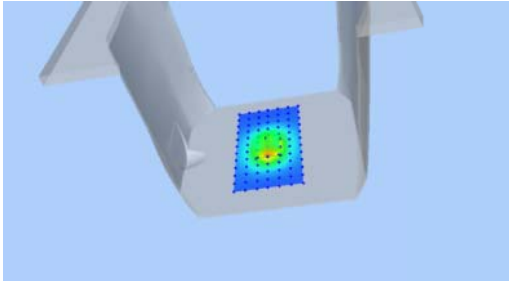
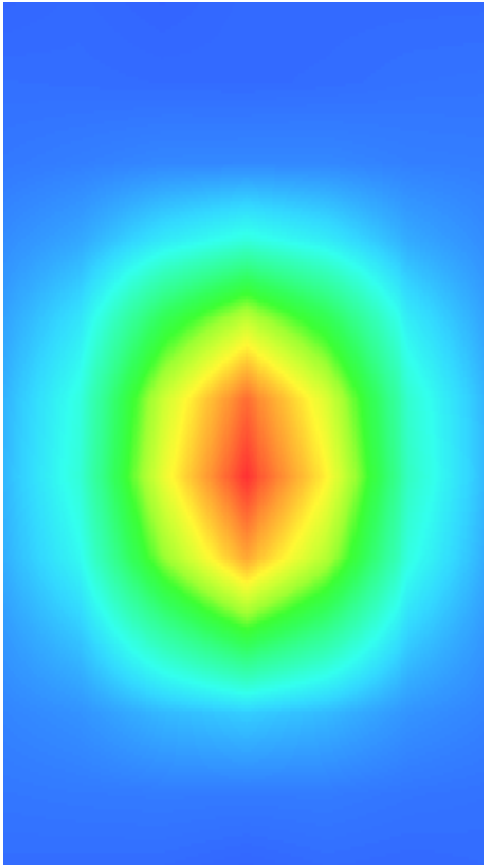
3D screen shot	Hot spot position
	

System Performance Check (Head, 2450MHz)

Type: Phone measurement

Area scan resolution: dx=8mm,dy=8mm

Zoom scan resolution: dx=5mm dy=5mm dz=4mm

Date of measurement: 09/24/2016

Measurement duration: 22 minutes 20 seconds

A. Experimental conditions.

Phantom File	dx=8mm dy=8mm
Phantom	7x7x8,dx=5mm dy=5mm dz=4mm
Device Position	Dipole
Band	2450MHz
Channels	
Signal	CW

B. SAR Measurement Results

Band SAR

E-Field Probe	SATIMO SN_43/15_EP276
Frequency (MHz)	2450
Relative permittivity (real part)	39.20
Relative permittivity	13.15
Conductivity (S/m)	1.80
Power Drift (%)	-1.22
ConvF:	5.52
Duty factor:	1:1

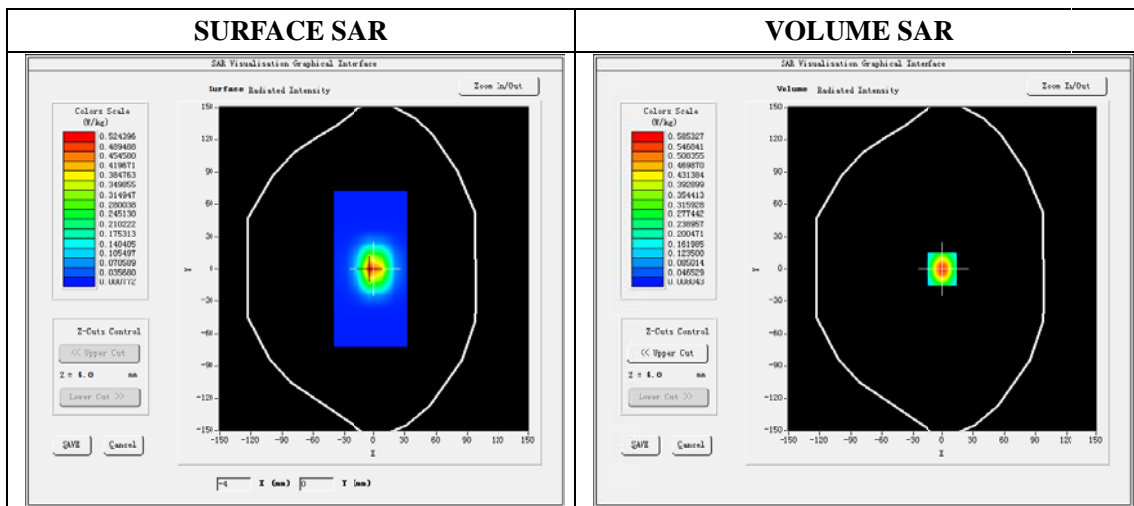

Maximum location: X=-1.00, Y=0.00

SAR 10g (W/Kg)	0.246812
SAR 1g (W/Kg)	0.523939

Z (mm)	0.00	4.00	8.00	12.00	16.00
SAR (W/Kg)	0.9776	0.5843	0.3418	0.2026	0.1234

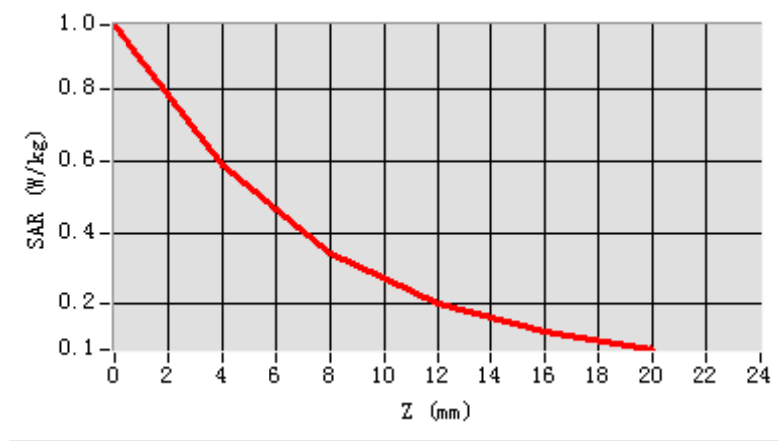

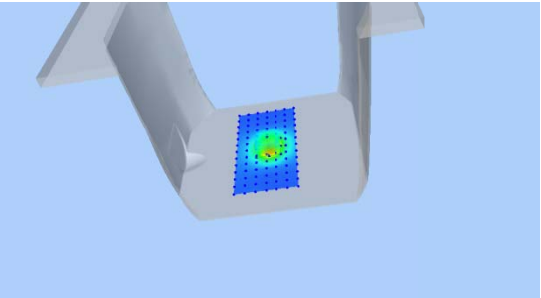
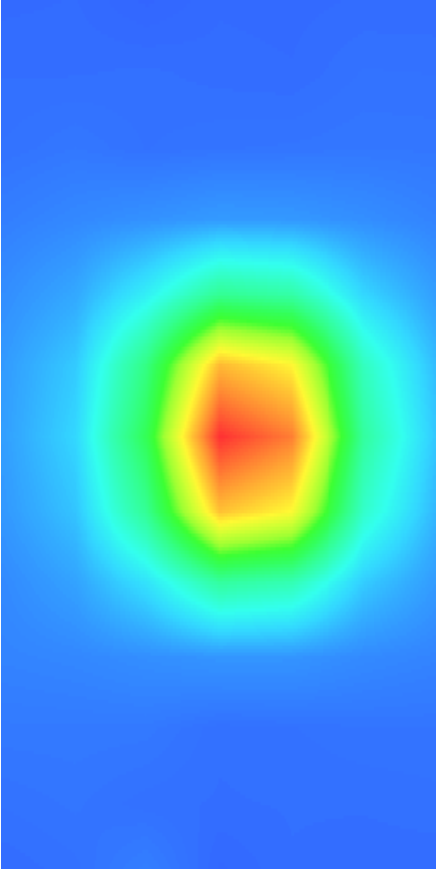
3D screen shot	Hot spot position
	

System Performance Check (Head, 5800MHz)

Type: Phone measurement (Complete)

Area scan resolution: dx=8mm,dy=8mm

Zoom scan resolution: dx=8mm, dy=8mm, dz=5mm

Date of measurement: 24/09/2016

Measurement duration: 22 minutes 28seconds

A. Experimental conditions.

Phantom File	surf_sam_plan.txt
Phantom	Flat Plane
Device Position	
Band	5800MHz
Channels	
Signal	CW

B. SAR Measurement Results

Band SAR

Frequency (MHz)	5800
Relative permittivity (real part)	35.39
Relative permittivity	16.45
Conductivity (S/m)	5.30
Power drift (%)	1.25
Ambient Temperature:	22.3°C
Liquid Temperature:	22.6°C
Crest factor:	1:1
ConvF:	2.34

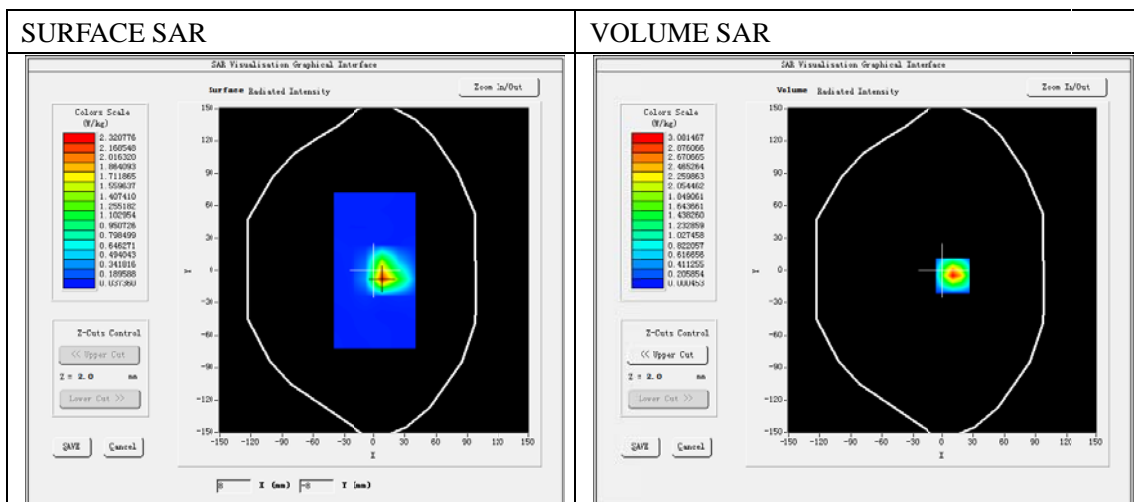

Maximum location: X=10.00, Y=-5.00

SAR 10g (W/Kg)	0.608842
SAR 1g (W/Kg)	1.731425

Z (mm)	0.00	2.00	7.00	12.00	17.00
SAR (W/Kg)	5.3020	3.0811	0.5113	0.0326	0.0032

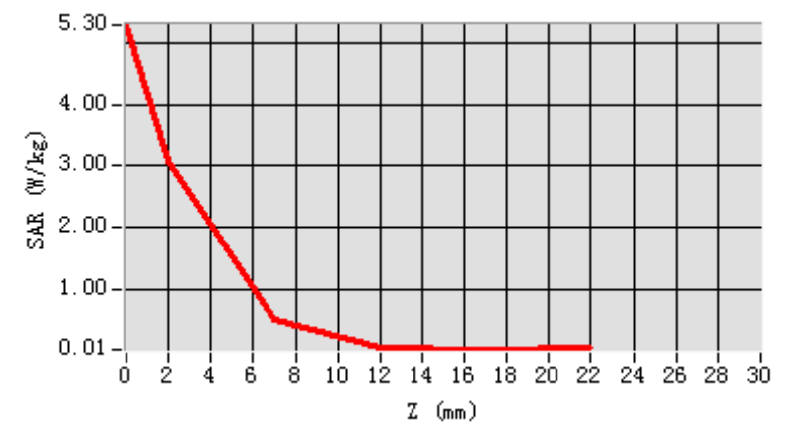

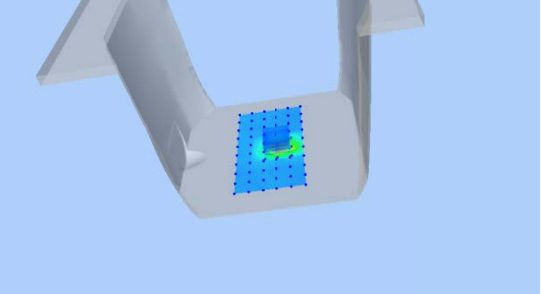
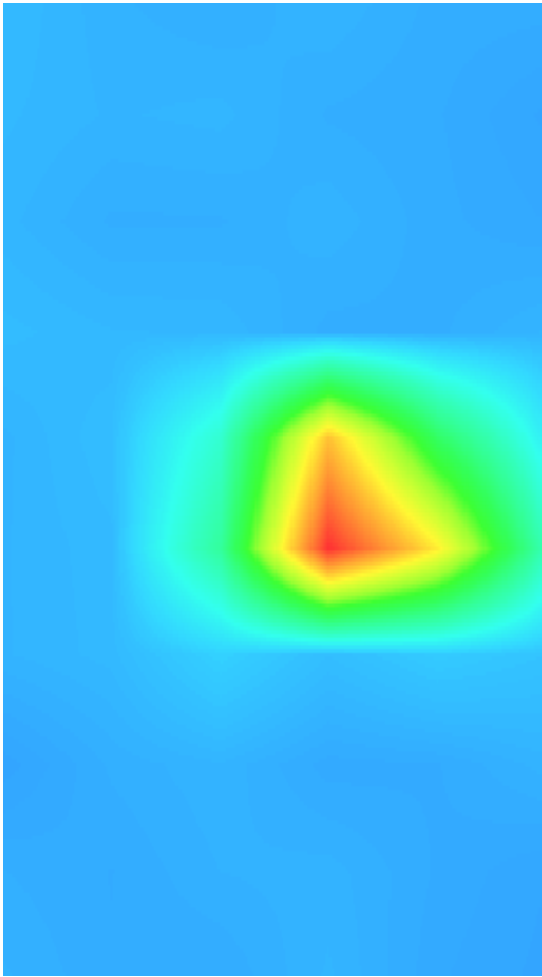
3D screen shot	Hot spot position
	

System Performance Check (Body, 835MHz)

Type: Validation measurement

Area scan resolution: dx=8mm,dy=8mm

Zoom scan resolution: dx=8mm, dy=8mm, dz=5mm

Date of measurement: 19/09/2016

Measurement duration: 21 minutes 26seconds

A. Experimental conditions.

Phantom File	dx=8mm dy=8mm
Phantom	5x5x7,dx=8mm dy=8mm dz=5mm
Device Position	Dipole
Band	835MHz
Channels	
Signal	CW

B. SAR Measurement Results

Band SAR

E-Field Probe	SATIMO SN_43/15_EP276
Frequency (MHz)	850
Relative permittivity (real part)	55.23
Relative permittivity	20.54
Conductivity (S/m)	0.98
Power drift (%)	-0.23
Ambient Temperature:	22.2°C
Liquid Temperature:	22.5°C
ConvF:	7.07
Duty factor:	1:1

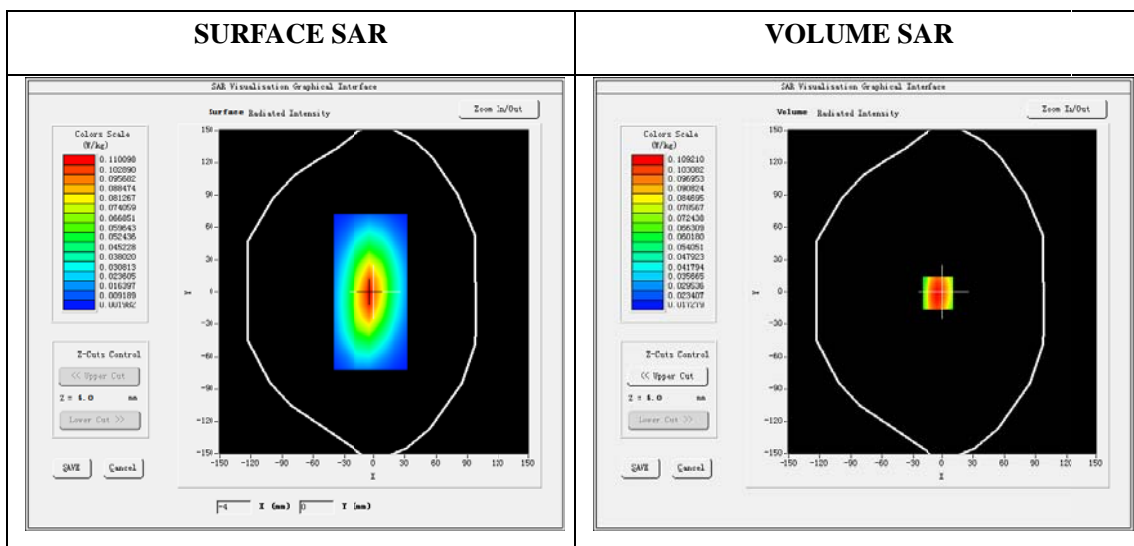



Maximum location: X=-5.00, Y=-1.00

SAR 10g (W/Kg)	0.066449
SAR 1g (W/Kg)	0.103121

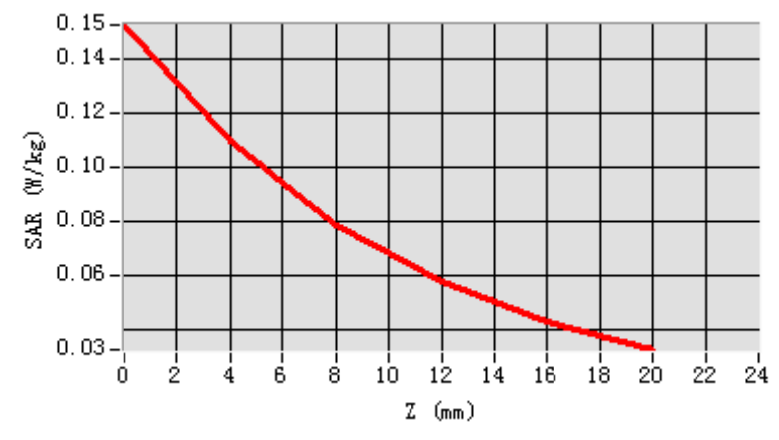
Z (mm)	0.00	4.00	8.00	12.00	16.00
SAR (W/Kg)	0.1533	0.1051	0.0724	0.0553	0.0426

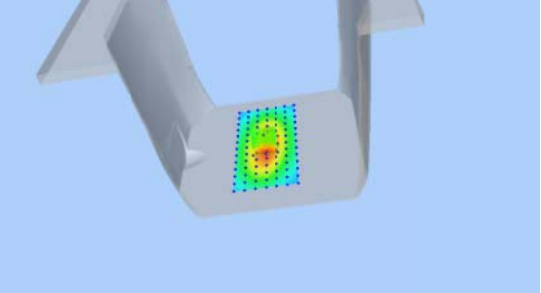

3D screen shot	Hot spot position
	

System Performance Check (Body, 1900MHz)

Type: Validation measurement

Area scan resolution: dx=8mm,dy=8mm

Zoom scan resolution: dx=8mm, dy=8mm, dz=5mm

Date of measurement: 20/09/2016

Measurement duration: 22 minutes 22 seconds

A. Experimental conditions.

Phantom File	dx=8mm dy=8mm
Phantom	5x5x7,dx=8mm dy=8mm dz=5mm
Device Position	Dipole
Band	1900MHz
Channels	
Signal	CW

B. SAR Measurement Results

Band SAR

E-Field Probe	SATIMO SN_43/15_EP276
Frequency (MHz)	1900
Relative permittivity (real part)	53.26
Relative permittivity	14.40
Conductivity (S/m)	1.50
Power Drift (%)	-0.83
Ambient Temperature:	22.1°C
Liquid Temperature:	22.6°C
ConvF:	6.18
Duty factor:	1:1

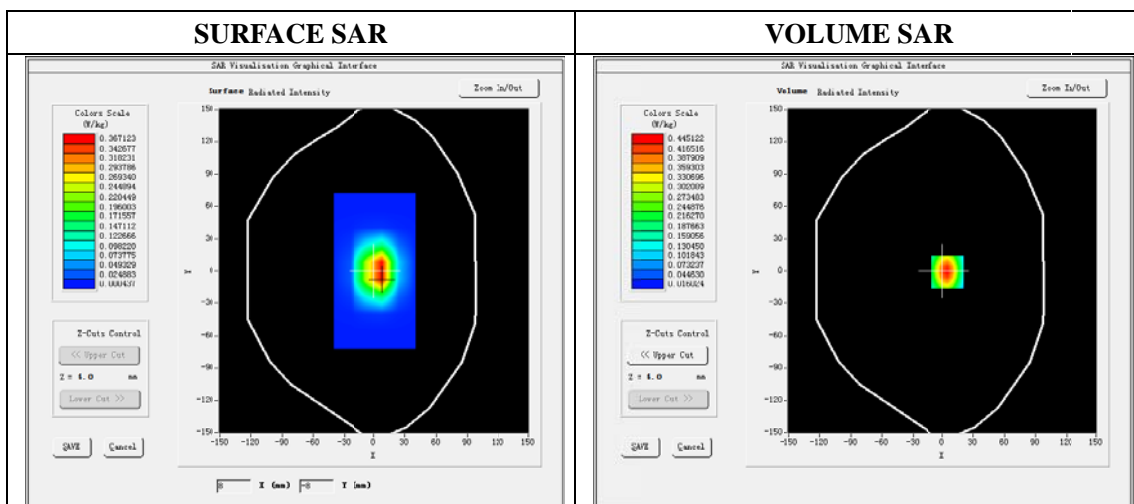

Maximum location: X=5.00, Y=-1.00

SAR 10g (W/Kg)	0.216303
SAR 1g (W/Kg)	0.407405

Z (mm)	0.00	4.00	8.00	12.00	16.00
SAR (W/Kg)	0.6953	0.4417	0.2829	0.1833	0.1242

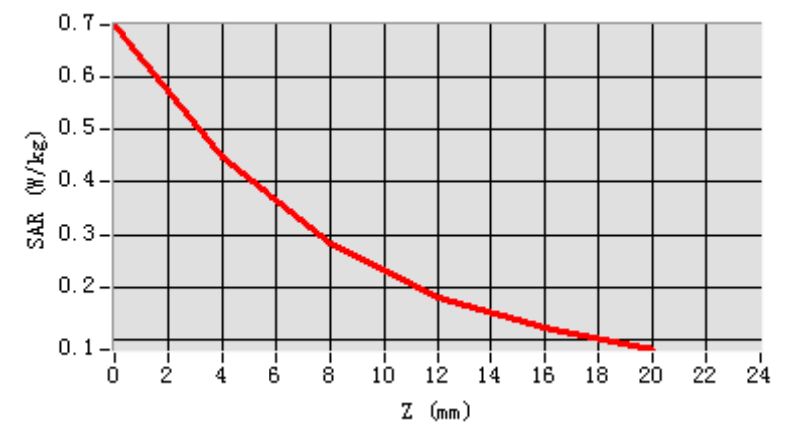

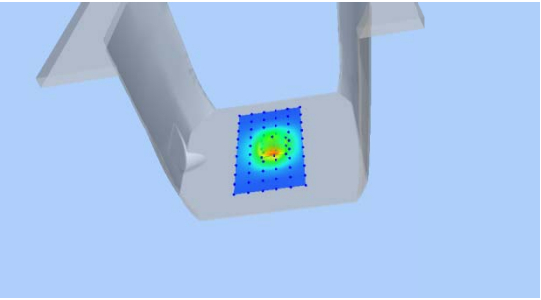
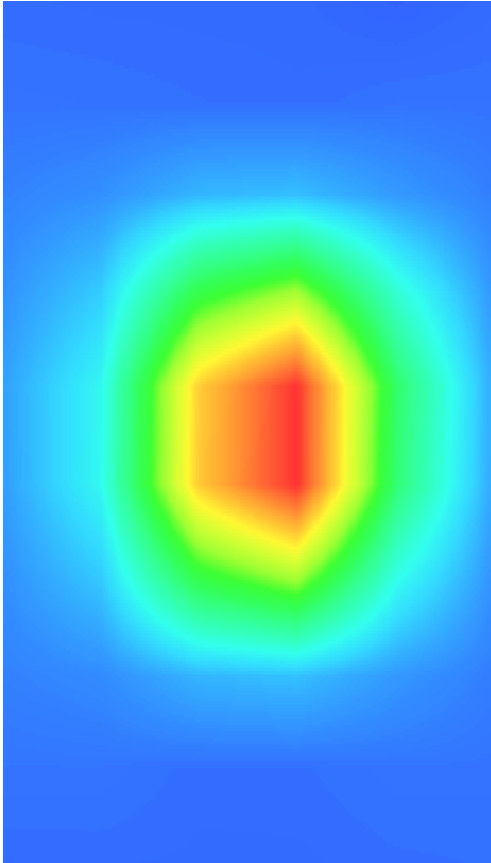
3D screen shot	Hot spot position
	

System Performance Check (Body, 2450MHz)

Type: Phone measurement

Area scan resolution: dx=8mm,dy=8mm

Zoom scan resolution: dx=5mm, dy=5mm, dz=4mm

Date of measurement: 21/09/2016

Measurement duration: 22 minutes 15 seconds

A. Experimental conditions.

Phantom File	dx=8mm dy=8mm
Phantom	7x7x8,dx=5mm dy=5mm dz=4mm
Device Position	Dipole
Band	2450MHz
Channels	
Signal	CW

B. SAR Measurement Results

Band SAR

E-Field Probe	SATIMO SN_43/15_EP276
Frequency (MHz)	2450
Relative permittivity (real part)	54.66
Relative permittivity	14.25
Conductivity (S/m)	1.90
Power Drift (%)	0.73
Duty factor:	1:1
ConvF:	5.70

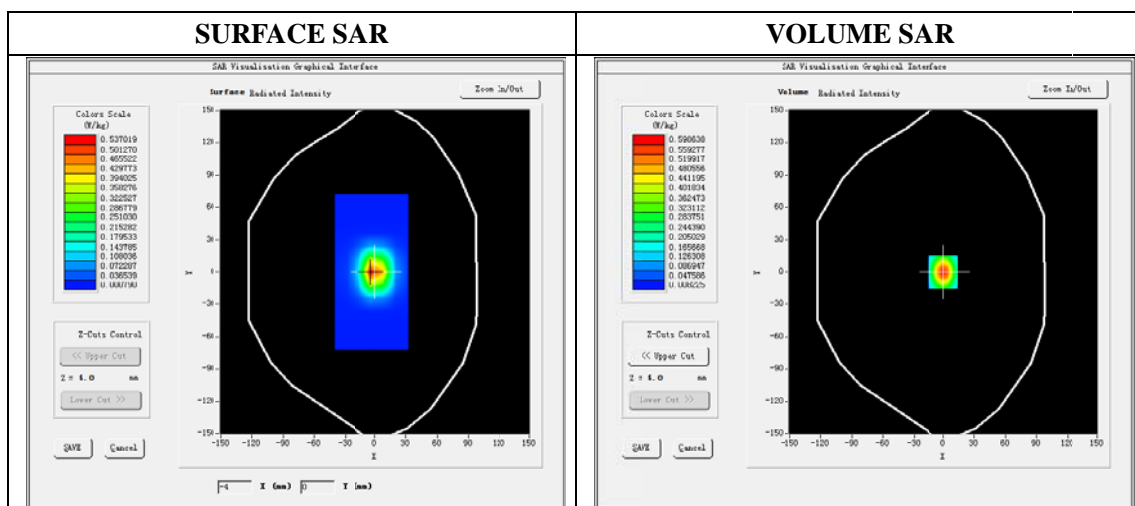

Maximum location: X=-1.00, Y=0.00

SAR 10g (W/Kg)	0.252316
SAR 1g (W/Kg)	0.535939

Z (mm)	0.00	4.00	8.00	12.00	16.00
SAR (W/Kg)	0.9946	0.5928	0.3515	0.2036	0.1215

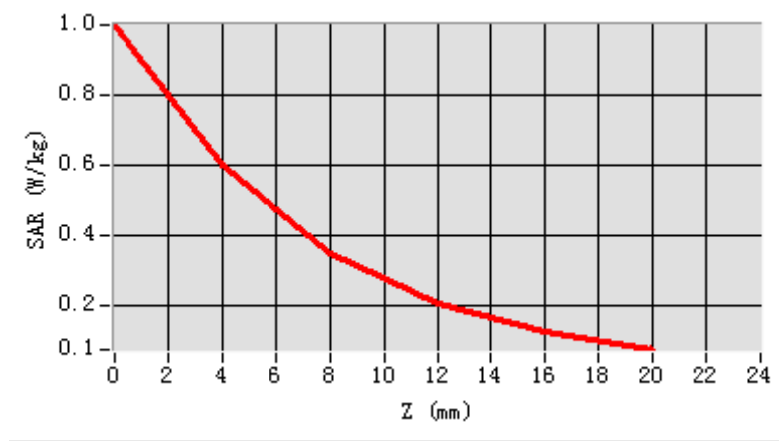

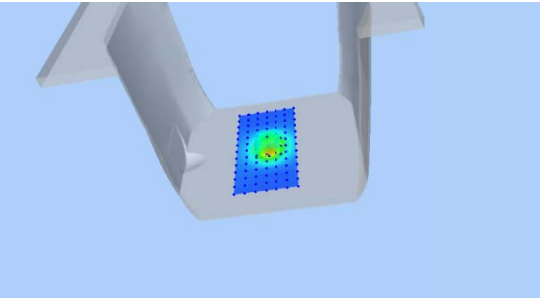
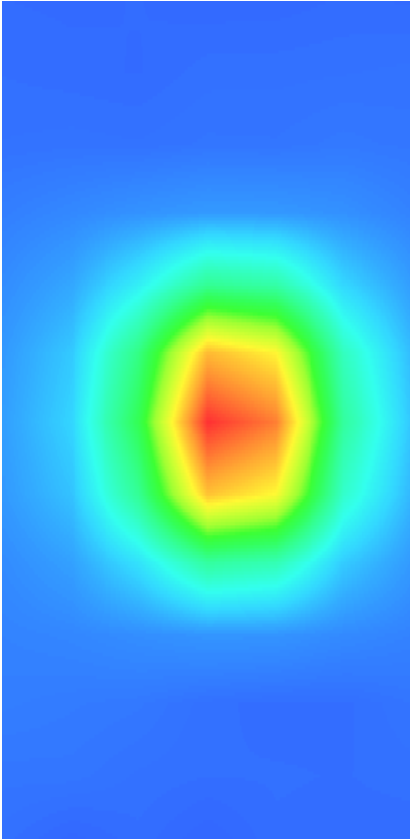
3D screen shot	Hot spot position
	

System Performance Check (Body, 5800MHz)

Type: Phone measurement

Area scan resolution: dx=8mm,dy=8mm

Zoom scan resolution: dx=5mm, dy=5mm, dz=4mm

Date of measurement: 21/09/2016

Measurement duration: 22 minutes 16 seconds

A. Experimental conditions.

Phantom File	dx=8mm dy=8mm
Phantom	7x7x8,dx=5mm dy=5mm dz=4mm
Device Position	Dipole
Band	5800MHz
Channels	
Signal	CW

B. SAR Measurement Results

Band SAR

E-Field Probe	SATIMO SN_43/15_EP276
Frequency (MHz)	5800
Relative permittivity (real part)	47.64
Relative permittivity	18.12
Conductivity (S/m)	5.84
Power Drift (%)	-2.39
Duty factor:	1:1
ConvF:	2.39

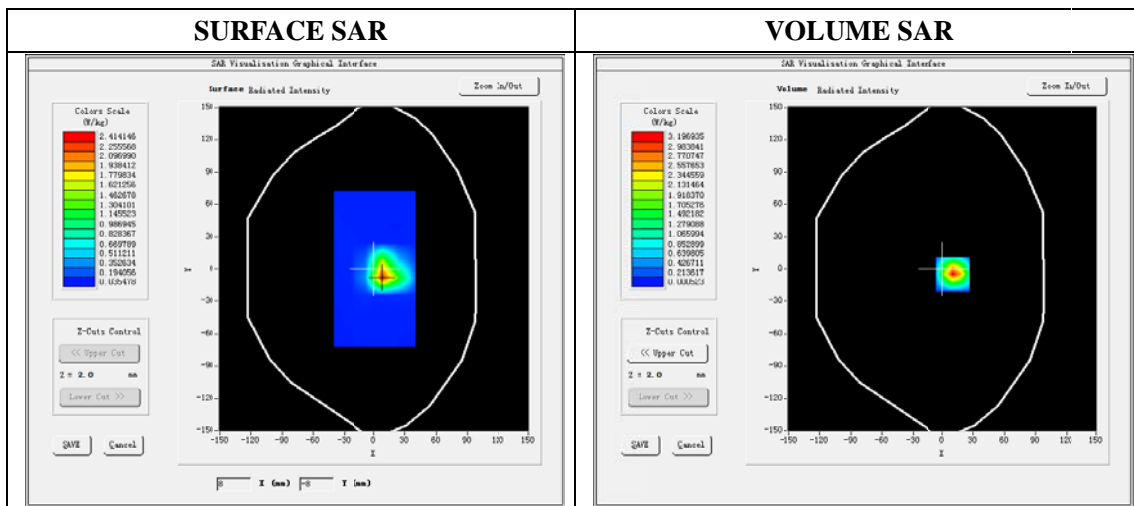

Maximum location: X=10.00, Y=-5.00

SAR 10g (W/Kg)	0.634367
SAR 1g (W/Kg)	1.798768

Z (mm)	0.00	2.00	7.00	12.00	17.00
SAR (W/Kg)	5.4900	3.1969	0.5369	0.0379	0.0101

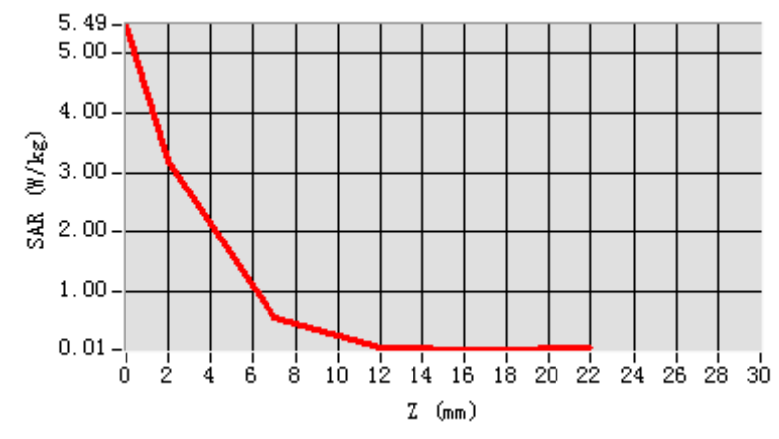

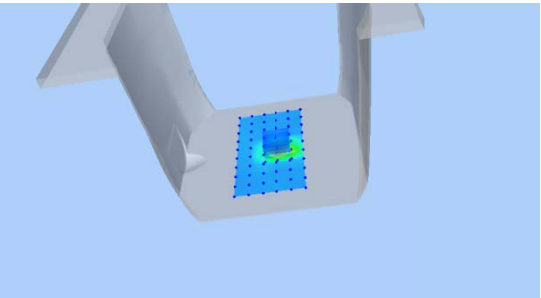
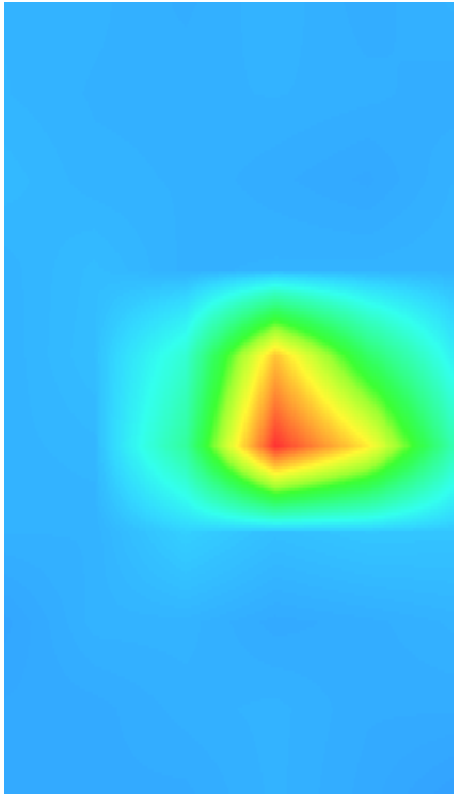
3D screen shot	Hot spot position
	

Plot 1: GSM850, Right Tilt, Mid

Type: Phone measurement
 Date of measurement: 26/09/2016
 Measurement duration: 22 minutes 11seconds
 Mobile Phone IMEI number: --

A. Experimental conditions.

Area Scan	dx=8mm dy=8mm
ZoomScan	5x5x7,dx=8mm dy=8mm dz=5mm
Phantom	Right head
Device Position	Tilt
Band	GSM850
Channels	190
Signal	GSM (Duty cycle: 1:8)

B. SAR Measurement Results

E-Field Probe	SATIMO SN_43/15_EP276
Frequency (MHz)	836.6
Relative permittivity (real part)	41.89
Relative permittivity (imaginary part)	19.19
Conductivity (S/m)	0.89
Variation (%)	0.69
ConvF:	6.81

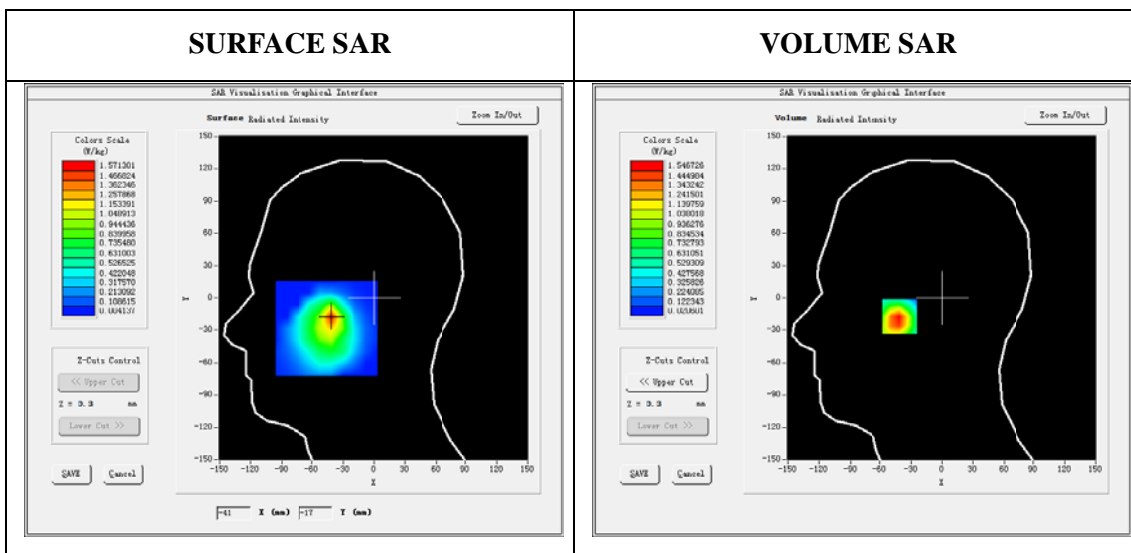

Maximum location: X=-41.00, Y=-17.00
 SAR Peak: 2.54 W/kg

SAR 10g (W/Kg)	0.585026
SAR 1g (W/Kg)	0.975610

Z (mm)	0.00	4.00	9.00	14.00	19.00
SAR (W/Kg)	2.4756	1.5467	0.8478	0.4880	0.3167

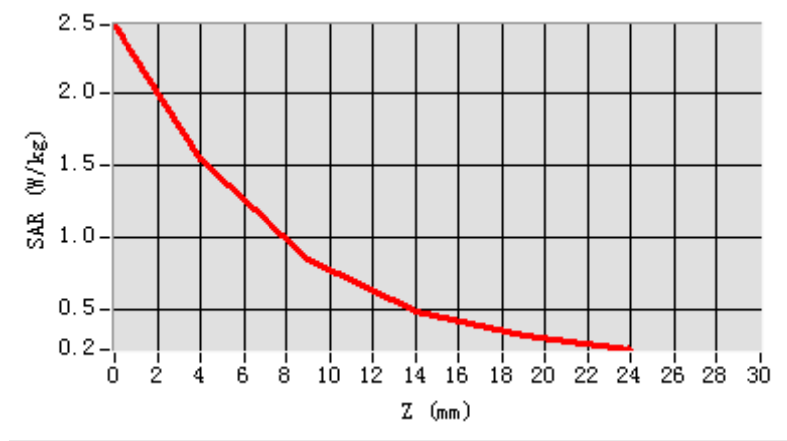

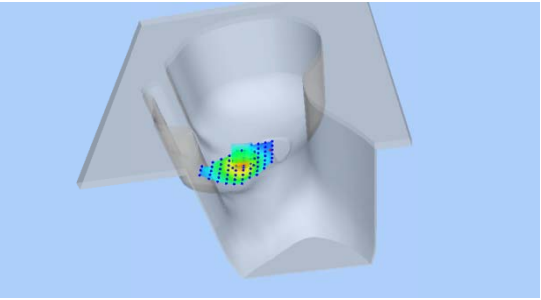
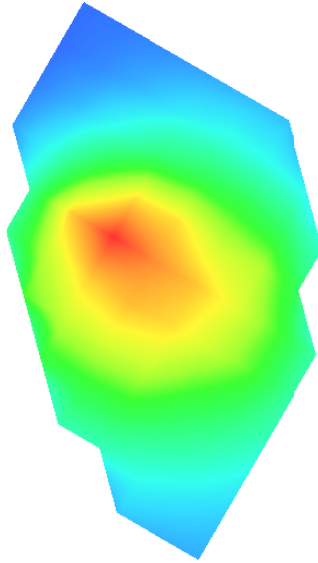
3D screen shot	Hot spot position
	

Plot 2: GSM850, Face, Body-Worn, Mid

Type: Phone measurement
 Date of measurement: 19/09/2016
 Measurement duration: 22minutes 12 seconds
 Mobile Phone IMEI number: --

A. Experimental conditions.

Area Scan	dx=8mm dy=8mm
ZoomScan	5x5x7,dx=8mm dy=8mm dz=5mm
Phantom	Validation plane
Device Position	Face
Band	GSM850
Channels	190
Signal	GSM(Duty cycle: 1:8)

B. SAR Measurement Results

E-Field Probe	SATIMO SN_43/15_EP276
Frequency (MHz)	836.6
Relative permittivity (real part)	55.23
Relative permittivity (imaginary part)	20.54
Conductivity (S/m)	0.98
Variation (%)	-4.46
ConvF:	7.07

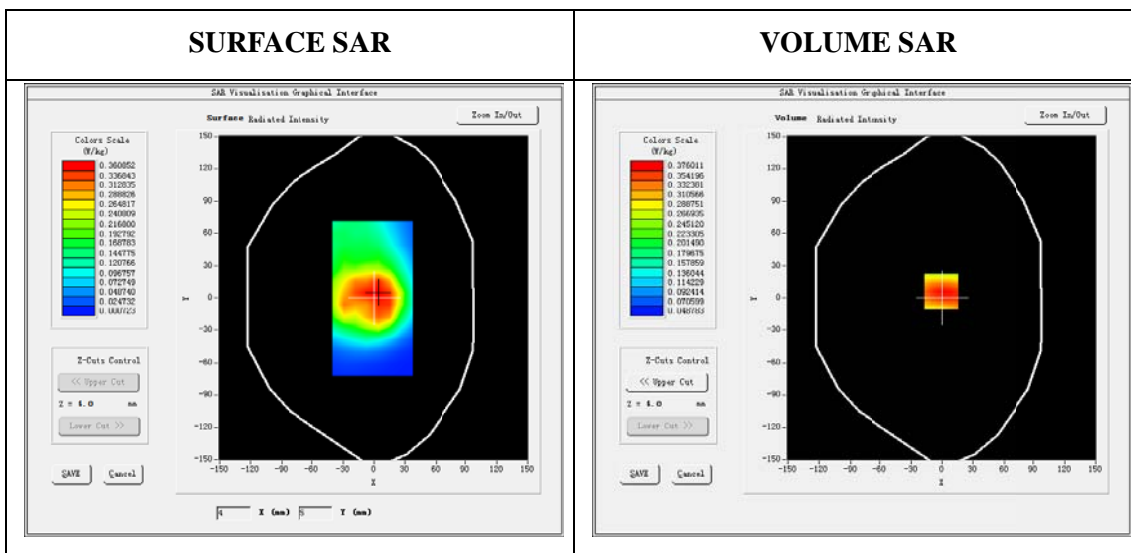

Maximum location: X=-1.00, Y=6.00
 SAR Peak: 0.55 W/kg

SAR 10g (W/Kg)	0.229945
SAR 1g (W/Kg)	0.361593

Z (mm)	0.00	4.00	9.00	14.00	19.00
SAR (W/Kg)	0.5498	0.3760	0.2334	0.1498	0.1024

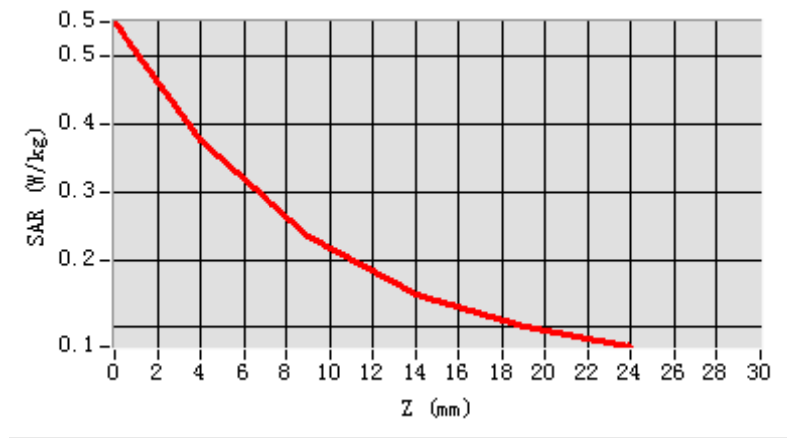

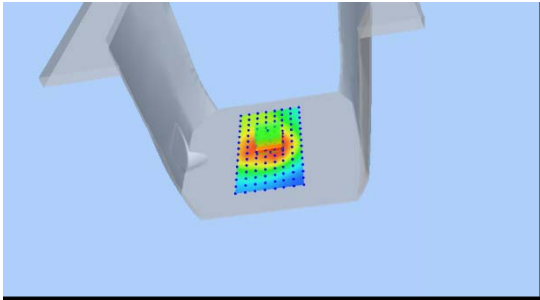
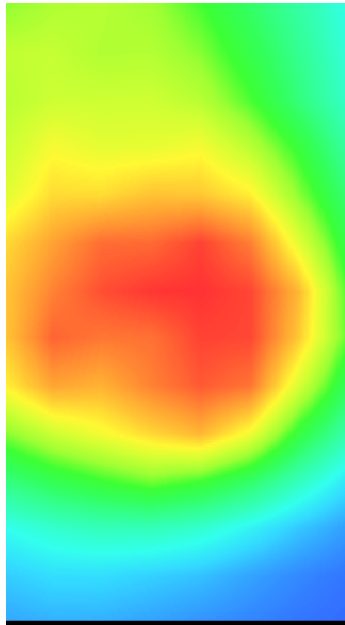
3D screen shot	Hot spot position
	

Plot 3: GPRS850, Edge A, Mid, Hotspot

Type: Phone measurement
 Date of measurement: 19/09/2016
 Measurement duration: 6 minutes 15 seconds
 Mobile Phone IMEI number: --

A. Experimental conditions.

Area Scan	dx=8mm dy=8mm
ZoomScan	5x5x7,dx=8mm dy=8mm dz=5mm
Phantom	Validation plane
Device Position	Edge A
Band	GSPRS850_4Tx
Channels	190
Signal	GPRS(Duty cycle: 1:2)

B. SAR Measurement Results

E-Field Probe	SATIMO SN_43/15_EP276
Frequency (MHz)	836.6
Relative permittivity (real part)	55.23
Relative permittivity (imaginary part)	20.54
Conductivity (S/m)	0.98
Variation (%)	2.61
ConvF:	7.07

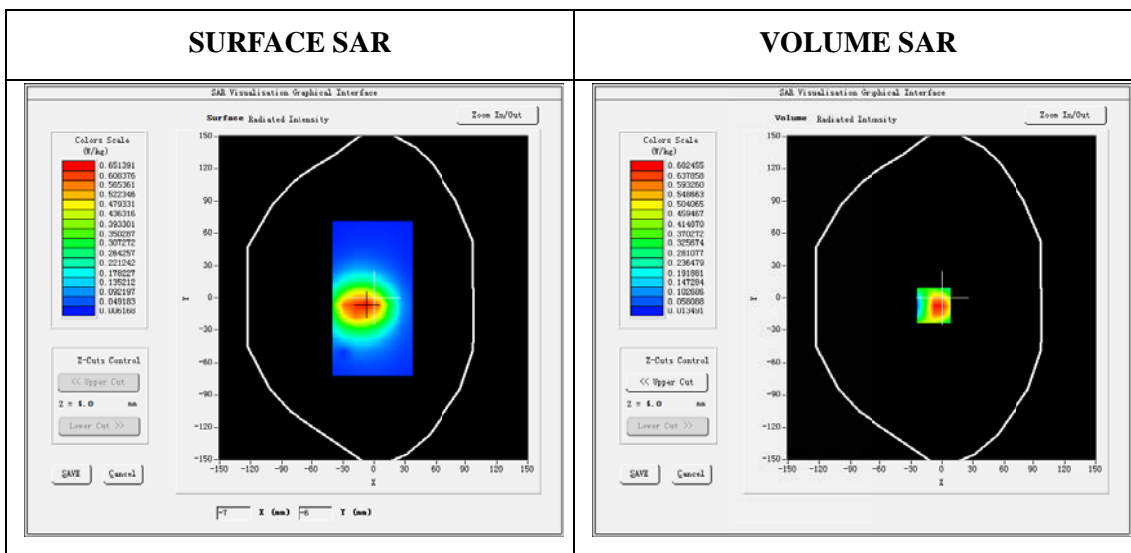

Maximum location: X=-8.00, Y=-7.00

SAR 10g (W/Kg)	0.389680
SAR 1g (W/Kg)	0.660952

Z (mm)	0.00	4.00	9.00	14.00	19.00
SAR (W/Kg)	2.7961	0.6825	0.2443	0.3236	0.1162

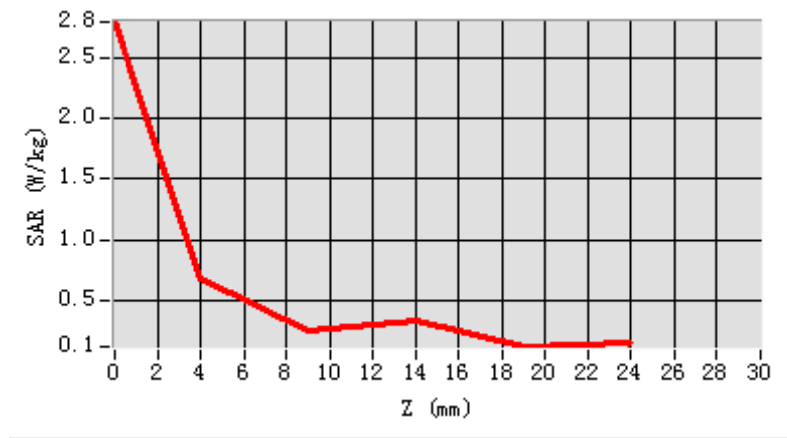

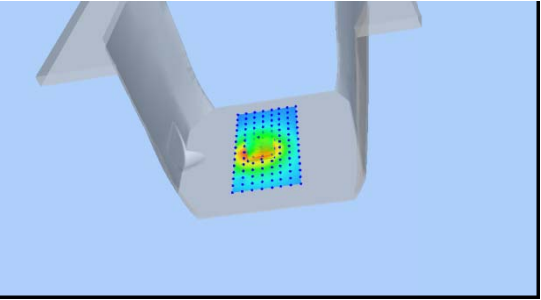
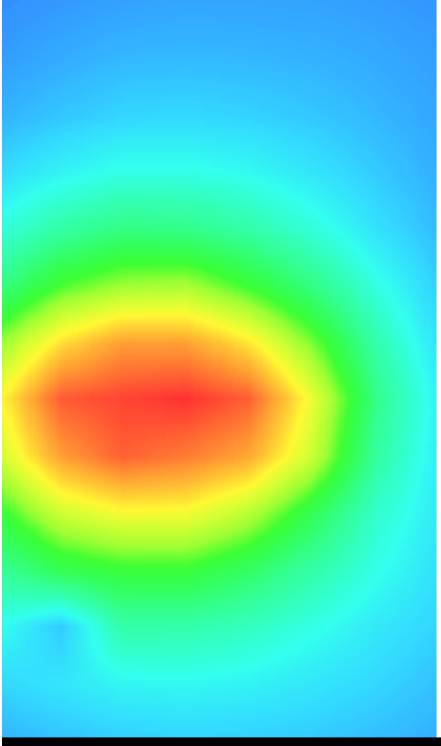
3D screen shot	Hot spot position
	

Plot 4: GSM1900, Right Tilt, Middle

Type: Phone measurement
 Date of measurement: 28/09/2016
 Measurement duration: 22 minutes 03 seconds
 Mobile Phone IMEI number: --

A. Experimental conditions.

Area Scan	dx=8mm dy=8mm
ZoomScan	5x5x7,dx=8mm dy=8mm dz=5mm
Phantom	Right head
Device Position	Tilt
Band	GSM1900
Channels	661
Signal	GSM (Duty cycle: 1:8)

B. SAR Measurement Results

E-Field Probe	SATIMO SN_43/15_EP276
Frequency (MHz)	1880.0
Relative permittivity (real part)	39.42
Relative permittivity (imaginary part)	13.17
Conductivity (S/m)	1.30
Variation (%)	0.04
ConvF:	6.05



Maximum location: X=-38.00, Y=-15.00

SAR 10g (W/Kg)	0.217420
SAR 1g (W/Kg)	0.455387

Z (mm)	0.00	4.00	9.00	14.00	19.00
SAR (W/Kg)	0.8542	0.4830	0.2200	0.0958	0.0428

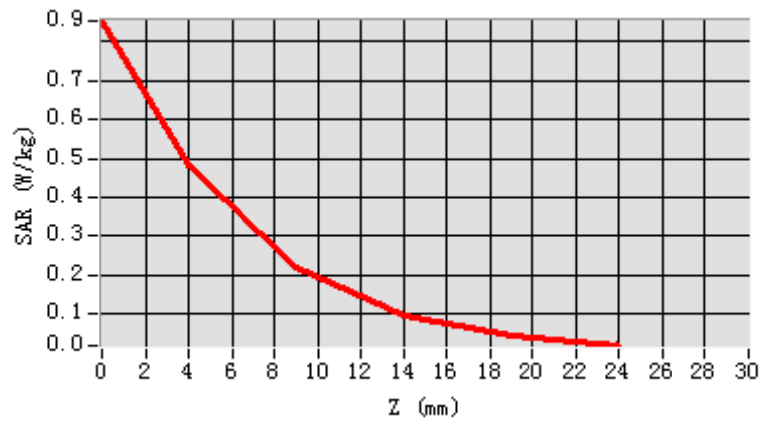

3D screen shot

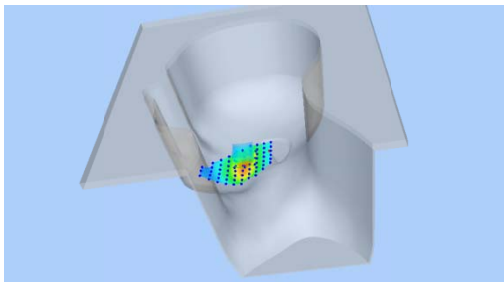

Hot spot position

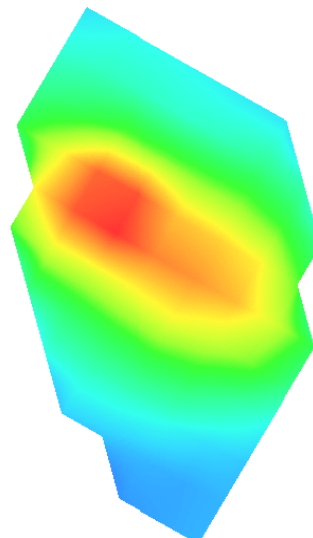

Plot 4: GSM1900, Back, Middle

Type: Phone measurement

Date of measurement: 20/09/2016

Measurement duration: 22 minutes 11 seconds

Mobile Phone IMEI number: --

A. Experimental conditions.

Area Scan	dx=8mm dy=8mm
ZoomScan	5x5x7,dx=8mm dy=8mm dz=5mm
Phantom	Validation plane
Device Position	Back
Band	GSM1900
Channels	661
Signal	GSM (Duty cycle: 1:8)

B. SAR Measurement Results

E-Field Probe	SATIMO SN_43/15_EP276
Frequency (MHz)	1880
Relative permittivity (real part)	53.26
Relative permittivity (imaginary part)	14.40
Conductivity (S/m)	1.50
Variation (%)	-3.46
ConvF:	6.18

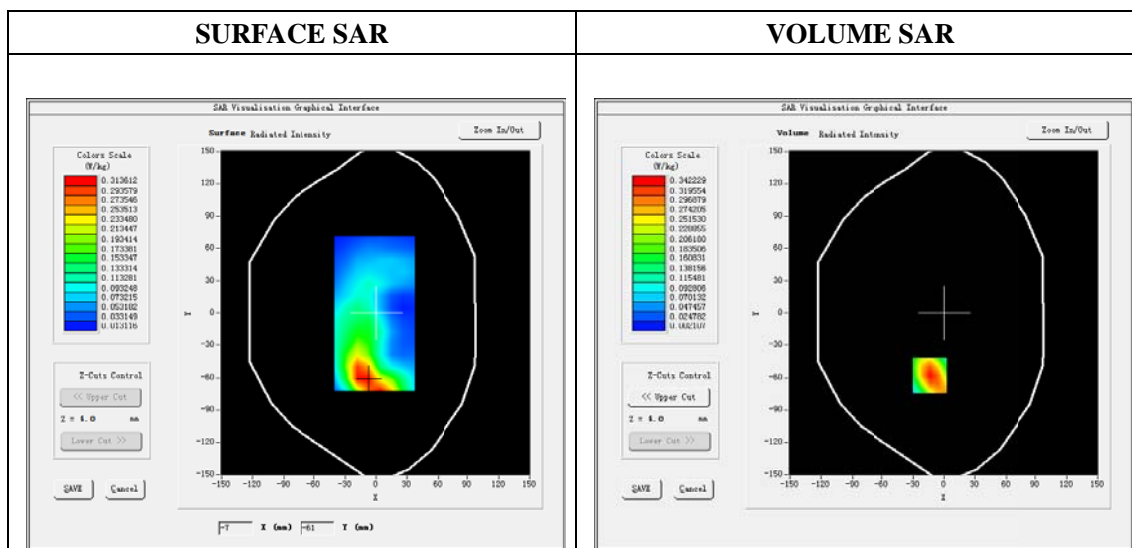

Maximum location: X=-14.00, Y=-58.00

SAR 10g (W/Kg)	0.156657
SAR 1g (W/Kg)	0.327902

Z (mm)	0.00	4.00	9.00	14.00	19.00
SAR (W/Kg)	0.6472	0.3422	0.1403	0.0555	0.0248

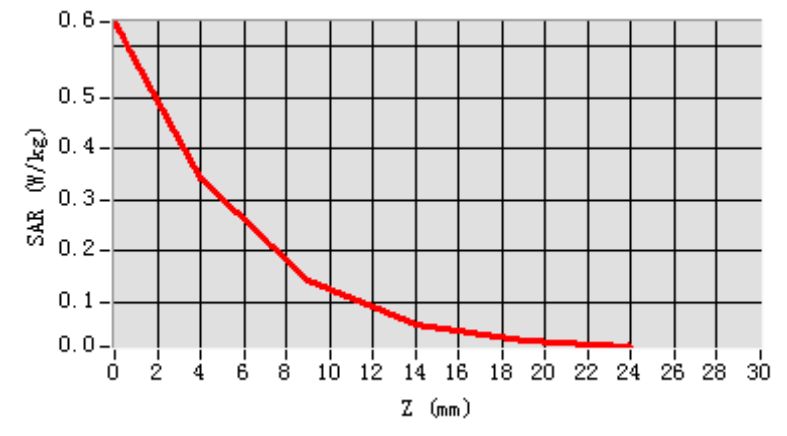

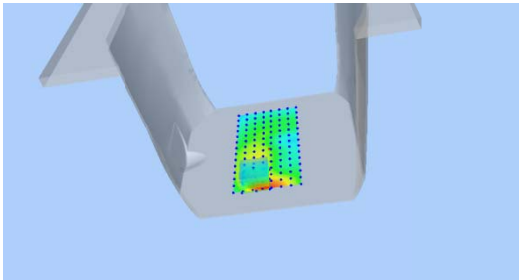
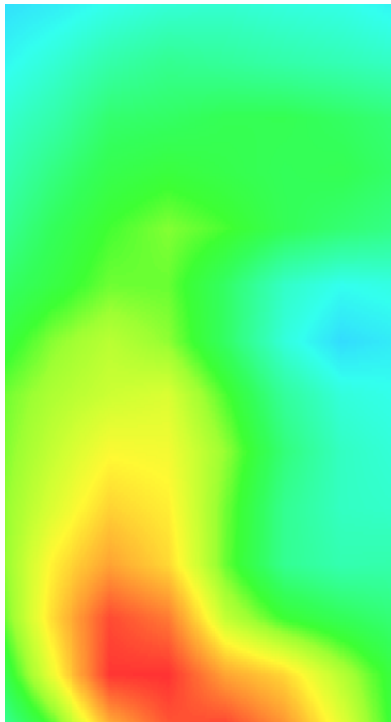
3D screen shot	Hot spot position
	

Plot 6: GPRS1900, Edge D, hotspot , Middle

Type: Phone measurement

Date of measurement: 20/09/2016

Measurement duration: 6 minutes 13 seconds

Mobile Phone IMEI number: --

A. Experimental conditions.

Area Scan	dx=8mm dy=8mm
ZoomScan	5x5x7,dx=8mm dy=8mm dz=5mm
Phantom	Validation plane
Device Position	Edge D
Band	GPRS1900_4Tx
Channels	661
Signal	GPRS (Duty cycle: 1:2)

B. SAR Measurement Results

E-Field Probe	SATIMO SN_43/15_EP276
Frequency (MHz)	1880.0
Relative permittivity (real part)	53.26
Relative permittivity (imaginary part)	14.40
Conductivity (S/m)	1.50
Variation (%)	-1.50
ConvF:	6.18

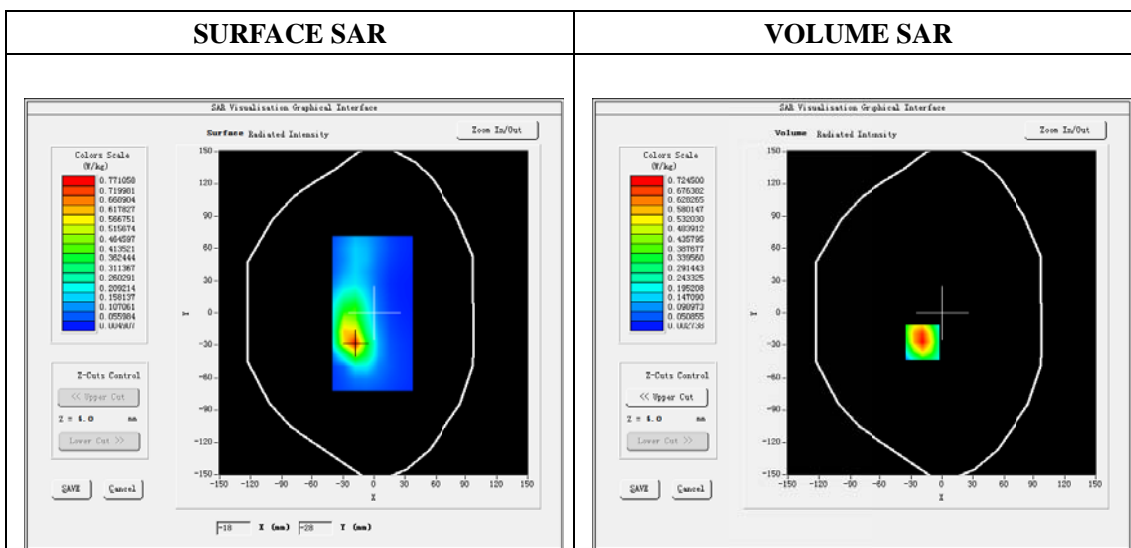

Maximum location: X=-19.00, Y=-27.00

SAR 10g (W/Kg)	0.316180
SAR 1g (W/Kg)	0.692499

Z (mm)	0.00	4.00	9.00	14.00	19.00
SAR (W/Kg)	1.3620	0.7245	0.2992	0.1180	0.0512

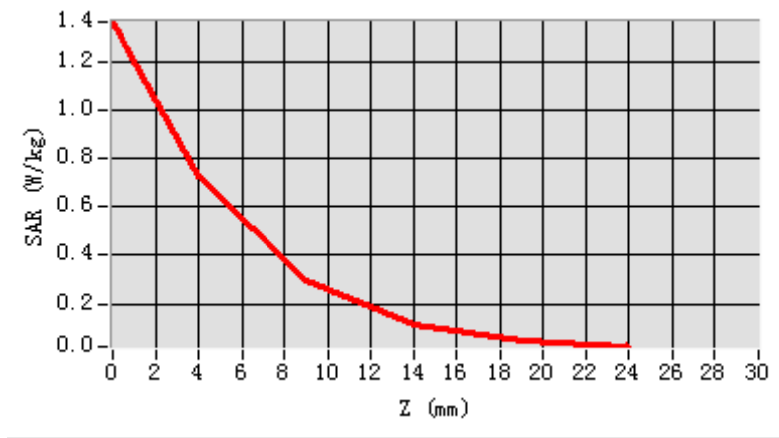

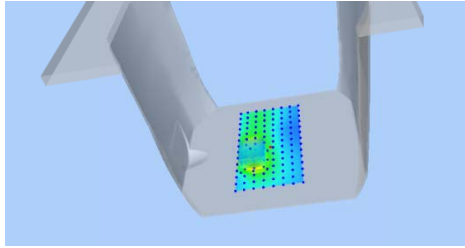
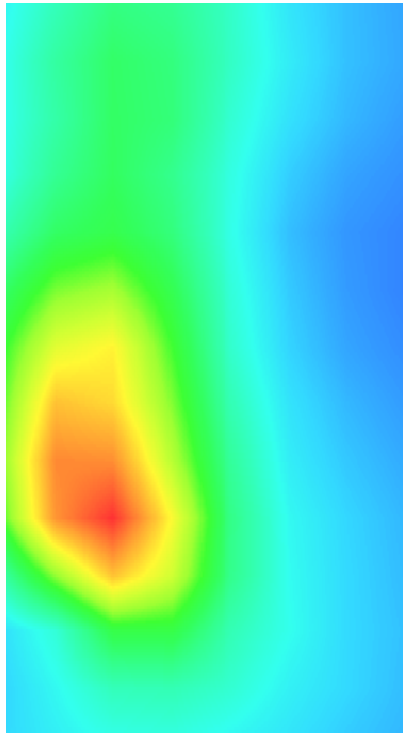
3D screen shot	Hot spot position
	

Plot 7: WCDMA850, Right Tilt, Mid

Type: Phone measurement
 Date of measurement: 26/09/2016
 Measurement duration: 22 minutes 06seconds
 Mobile Phone IMEI number: --

A. Experimental conditions.

Area Scan	dx=8mm dy=8mm
ZoomScan	5x5x7,dx=8mm dy=8mm dz=5mm
Phantom	Right head
Device Position	Tilt
Band	Band5_WCDMA850
Channels	4183
Signal	WCDMA (Duty cycle: 1:1)

B. SAR Measurement Results

E-Field Probe	SATIMO SN_43/15_EP276
Frequency (MHz)	836.6
Relative permittivity (real part)	41.89
Relative permittivity (imaginary part)	19.19
Conductivity (S/m)	0.89
Variation (%)	3.85
ConvF:	6.81

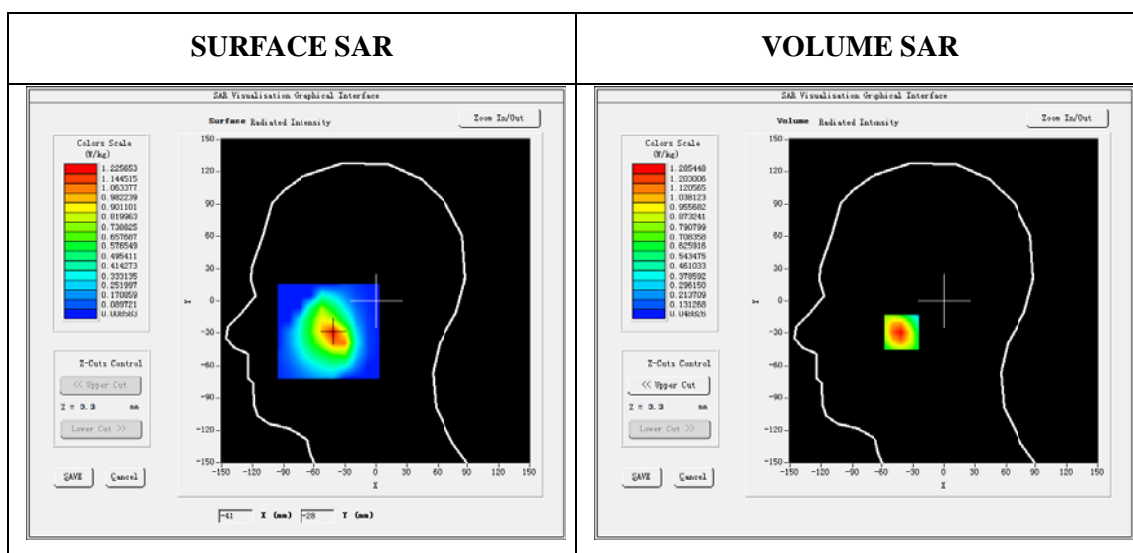

Maximum location: X=-41.00, Y=-29.00

SAR 10g (W/Kg)	0.699521
SAR 1g (W/Kg)	1.110230

Z (mm)	0.00	4.00	9.00	14.00	19.00
SAR (W/Kg)	1.9272	1.2854	0.7747	0.4893	0.3380

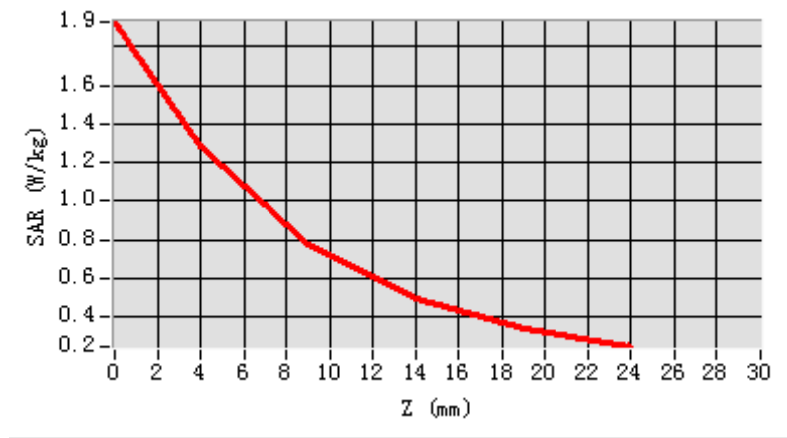

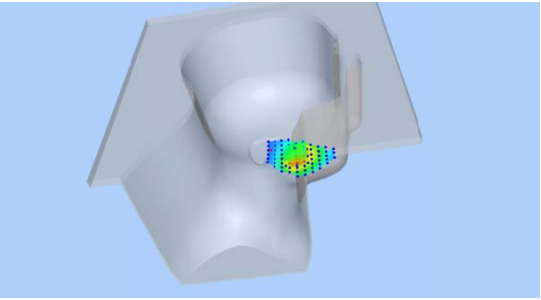
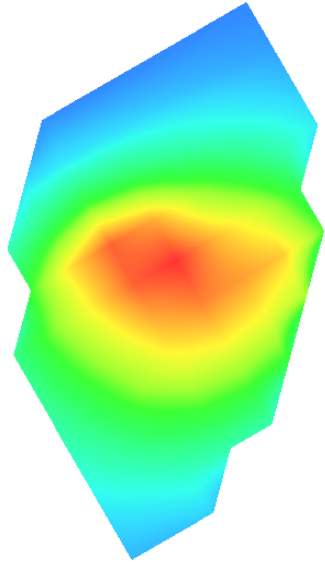
3D screen shot	Hot spot position
	

Plot 8: WCDMA850, Edge A(Body-worn, hotspot), Mid

Type: Phone measurement
 Date of measurement: 19/09/2016
 Measurement duration: 22 minutes 11 seconds
 Mobile Phone IMEI number: --

A. Experimental conditions.

Area Scan	dx=8mm dy=8mm
ZoomScan	5x5x7,dx=8mm dy=8mm dz=5mm
Phantom	Validation plane
Device Position	Edge A
Band	Band5_WCDMA850
Channels	4183
Signal	WCDMA (Duty cycle: 1:1)

B. SAR Measurement Results

E-Field Probe	SATIMO SN_43/15_EP276
Frequency (MHz)	836.6
Relative permittivity (real part)	55.23
Relative permittivity (imaginary part)	20.54
Conductivity (S/m)	0.98
Variation (%)	-0.80
ConvF:	7.07

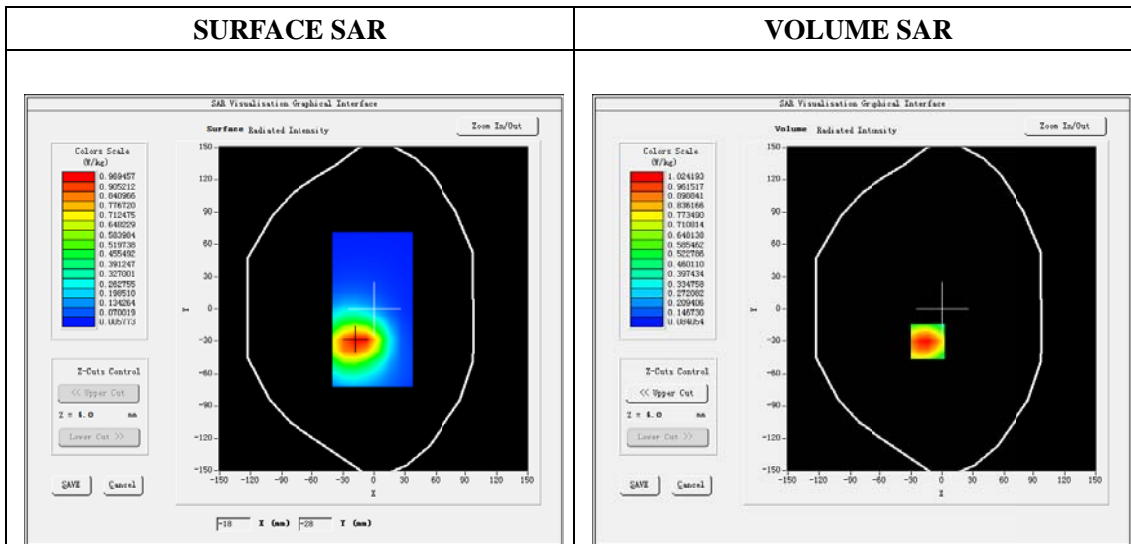

Maximum location: X=-14.00, Y=-30.00

SAR 10g (W/Kg)	0.422467
SAR 1g (W/Kg)	0.705571

Z (mm)	0.00	4.00	9.00	14.00	19.00
SAR (W/Kg)	1.3887	1.0242	0.6968	0.4784	0.3341

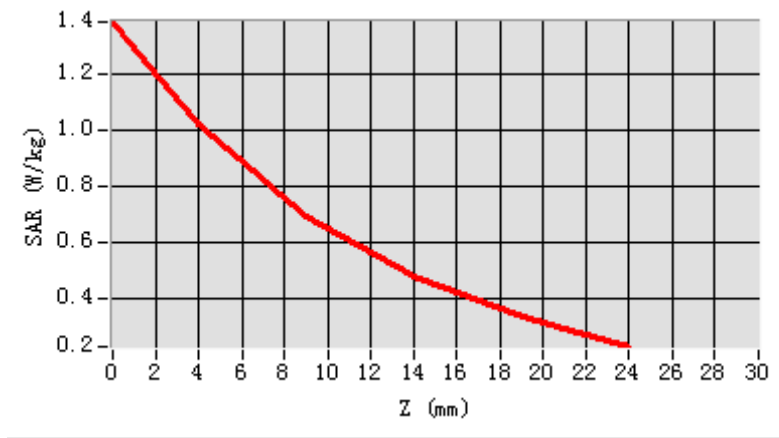

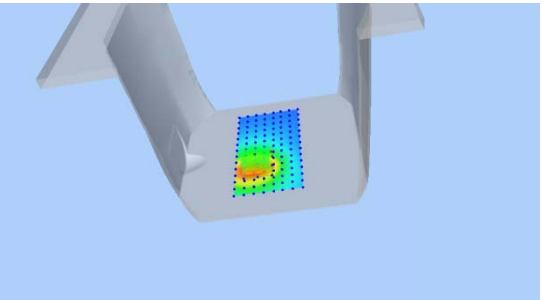
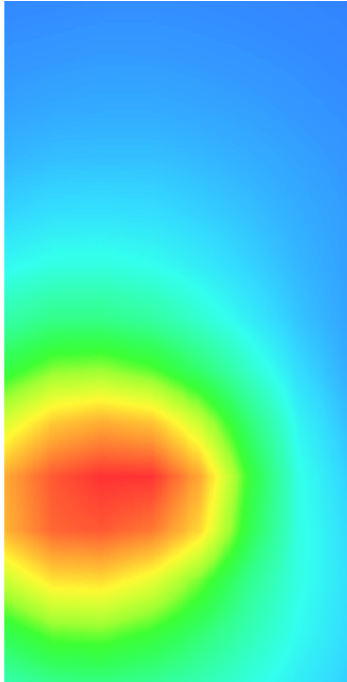
3D screen shot	Hot spot position
	

Plot 9 WCDMA1900, Right Tilt, Mid

Type: Phone measurement
 Date of measurement: 28/09/2016
 Measurement duration: 23minutes 03 seconds
 Mobile Phone IMEI number: --

A. Experimental conditions.

Area Scan	dx=8mm dy=8mm
ZoomScan	5x5x7,dx=8mm dy=8mm dz=5mm
Phantom	Validation plane
Device Position	Right head
Band	Tilt
Channels	9400
Signal	WCDMA (Duty cycle: 1:1)

B. SAR Measurement Results

E-Field Probe	SATIMO SN_43/23_EP276
Frequency (MHz)	1880.0
Relative permittivity (real part)	39.42
Relative permittivity (imaginary)	13.17
Conductivity (S/m)	1.30
Variation (%)	-1.99
ConvF:	6.05

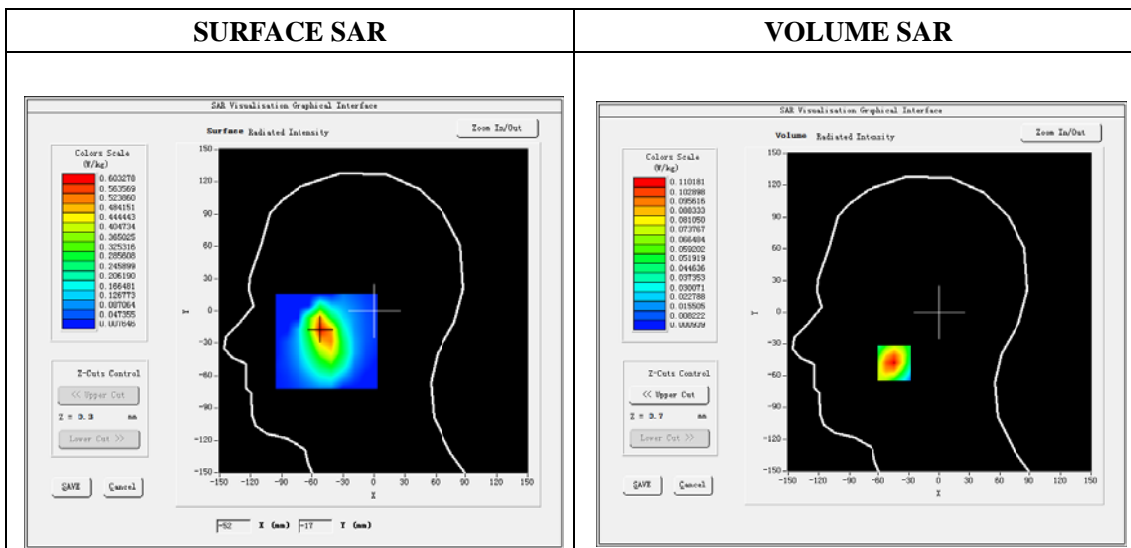

Maximum location: X=-50.00, Y=-17.00

SAR 10g (W/Kg)	0.268691
SAR 1g (W/Kg)	0.572724

Z (mm)	0.00	4.00	9.00	14.00	19.00
SAR (W/Kg)	1.1292	0.6056	0.2538	0.1020	0.0449

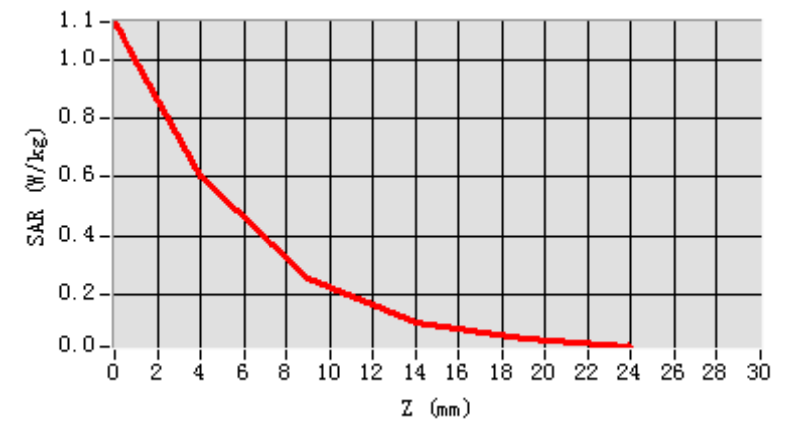

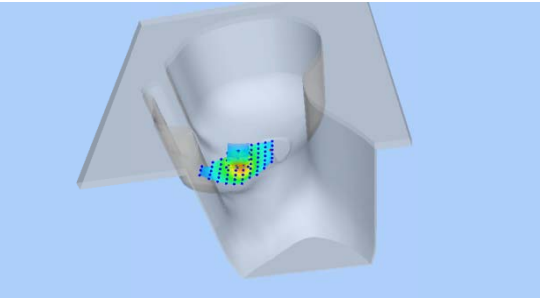
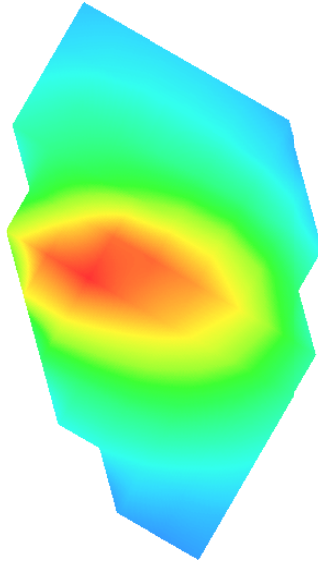
3D screen shot	Hot spot position
	

Plot 10 WCDMA1900, Edge A , Body-Worn/Hotspot, middle

Type: Phone measurement

Date of measurement: 20/09/2016

Measurement duration: 22 minutes 13 seconds

Mobile Phone IMEI number: --

A. Experimental conditions.

Area Scan	dx=8mm dy=8mm
ZoomScan	5x5x7,dx=8mm dy=8mm dz=5mm
Phantom	Validation plane
Device Position	Edge D
Band	Band2_WCDMA1900
Channels	9538
Signal	WCDMA (Duty cycle: 1:1)

B. SAR Measurement Results

E-Field Probe	SATIMO SN_43/15_EP276
Frequency (MHz)	1880.0
Relative permittivity (real part)	53.26
Relative permittivity (imaginary)	14.40
Conductivity (S/m)	1.50
Variation (%)	-1.81
ConvF:	6.18

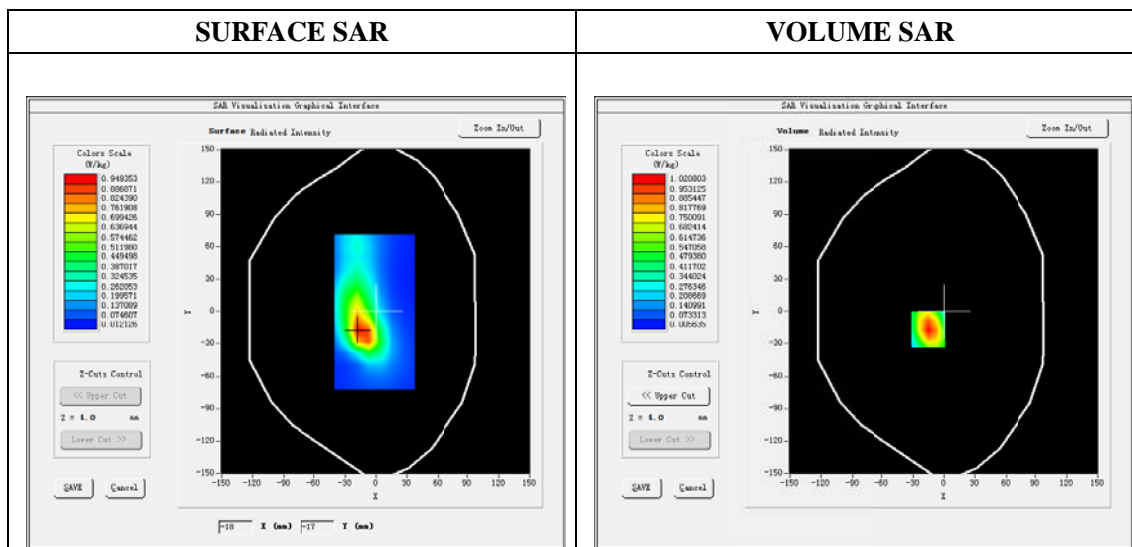

Maximum location: X=-15.00, Y=17.00

SAR Peak: 1.91 W/kg

SAR 10g (W/Kg)	0.448822
SAR 1g (W/Kg)	0.725527

Z (mm)	0.00	4.00	9.00	14.00	19.00
SAR (W/Kg)	1.9002	1.0208	0.4293	0.1735	0.0771

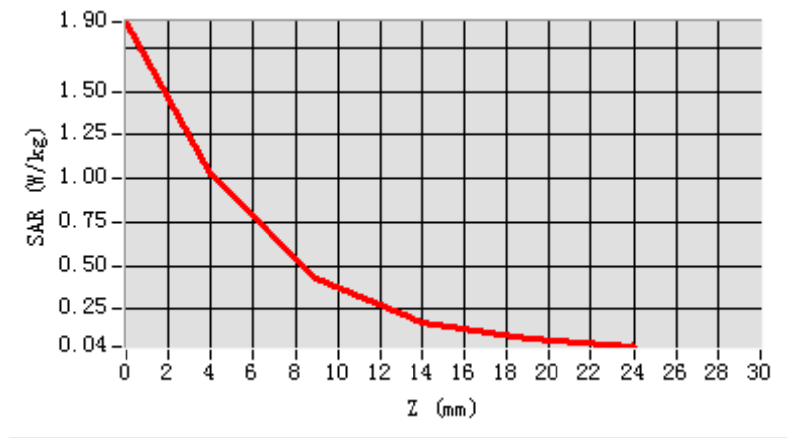

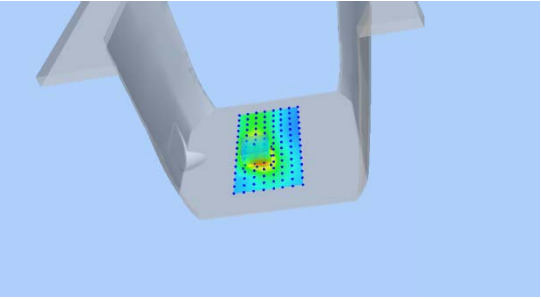
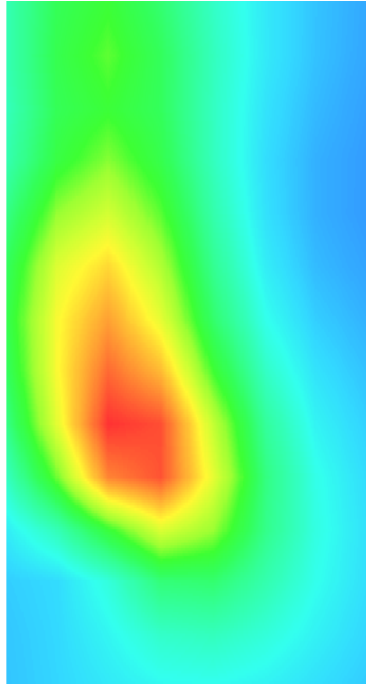
3D screen shot	Hot spot position
	

Plot 11: Wi-Fi 802.11b , Right-Cheek, Middle

Type: Phone measurement
 Date of measurement: 24/09/2016
 Measurement duration: 22 minutes 06 seconds
 Mobile Phone IMEI number: --

A. Experimental conditions.

Area Scan	dx=8mm dy=8mm
ZoomScan	7x7x8,dx=5mm dy=5mm dz=4mm
Phantom	Right head
Device Position	Cheek
Band	IEEE 802.11b ISM
Channels	6
Signal	DSSS (Crest factor: 1:1)

B. SAR Measurement Results

E-Field Probe	SATIMO SN_43/15_EP276
Frequency (MHz)	2437
Relative permittivity (real part)	39.20
Relative permittivity (imaginary part)	13.15
Conductivity (S/m)	1.80
Variation (%)	-0.68
ConvF:	5.52

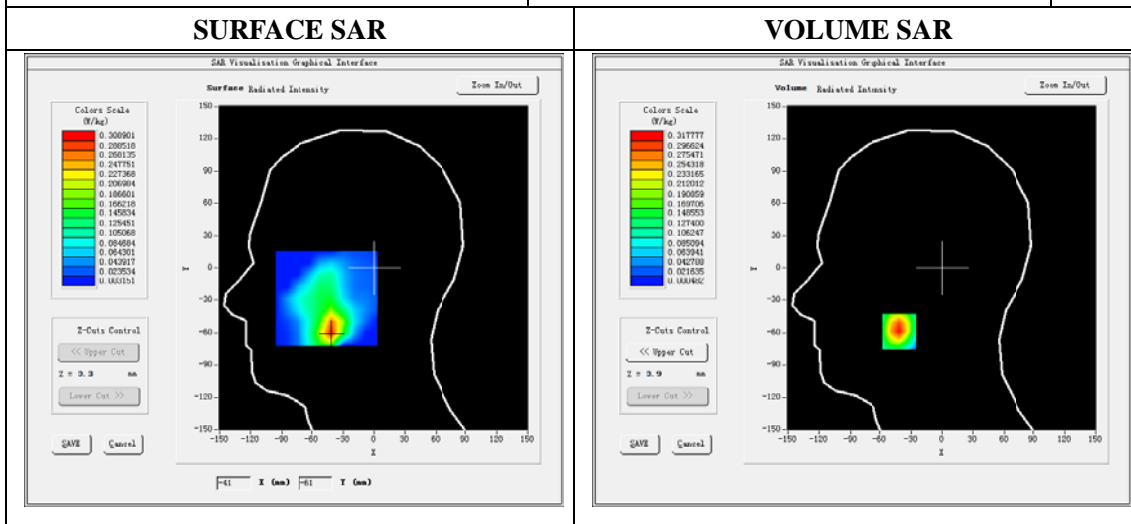

Maximum location: X=-41.00, Y=-59.00
 SAR Peak: 0.65 W/kg

SAR 10g (W/Kg)	0.131240
SAR 1g (W/Kg)	0.204023

Z (mm)	0.00	4.00	9.00	14.00	19.00
SAR (W/Kg)	0.6471	0.3178	0.1133	0.0370	0.0142

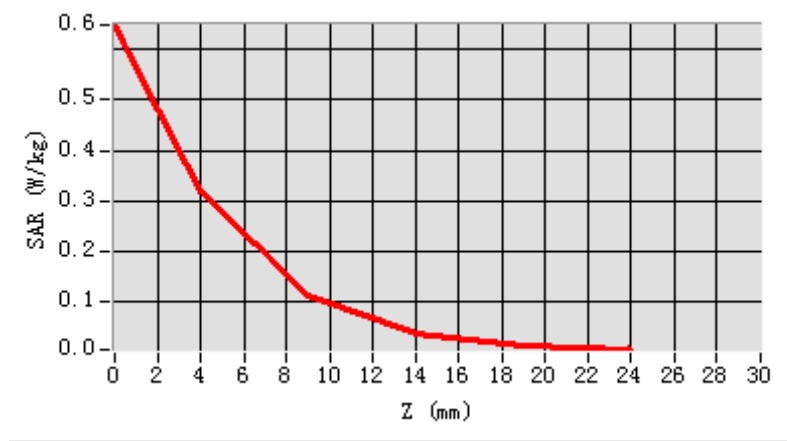

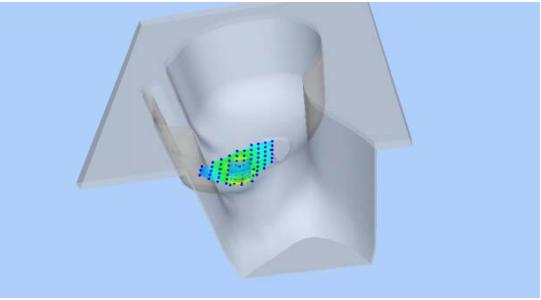
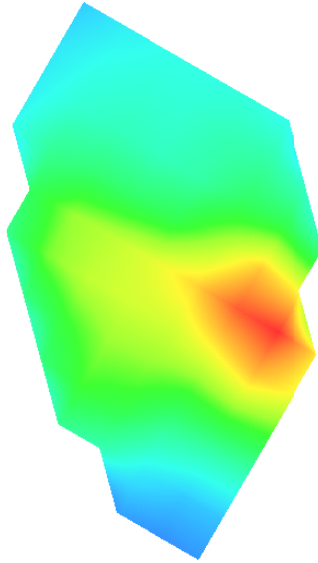
3D screen shot	Hot spot position
	

Plot 12: Wi-Fi 802.11b , Edge B(Body-worn, hotspot), Mid

Type: Phone measurement
 Date of measurement: 21/09/2016
 Measurement duration: 22minutes 21 seconds
 Mobile Phone IMEI number: --

A. Experimental conditions.

Area Scan	dx=8mm dy=8mm
ZoomScan	7x7x8,dx=5mm dy=5mm dz=4mm
Phantom	Validation plane
Device Position	Edge B
Band	IEEE 802.11b
Channels	6
Signal	DSSS (Crest factor: 1:1)

B. SAR Measurement Results

E-Field Probe	SATIMO SN_43/15_EP276
Frequency (MHz)	2437
Relative permittivity (real part)	54.66
Relative permittivity (imaginary part)	14.25
Conductivity (S/m)	1.90
Variation (%)	-0.57
ConvF:	5.70

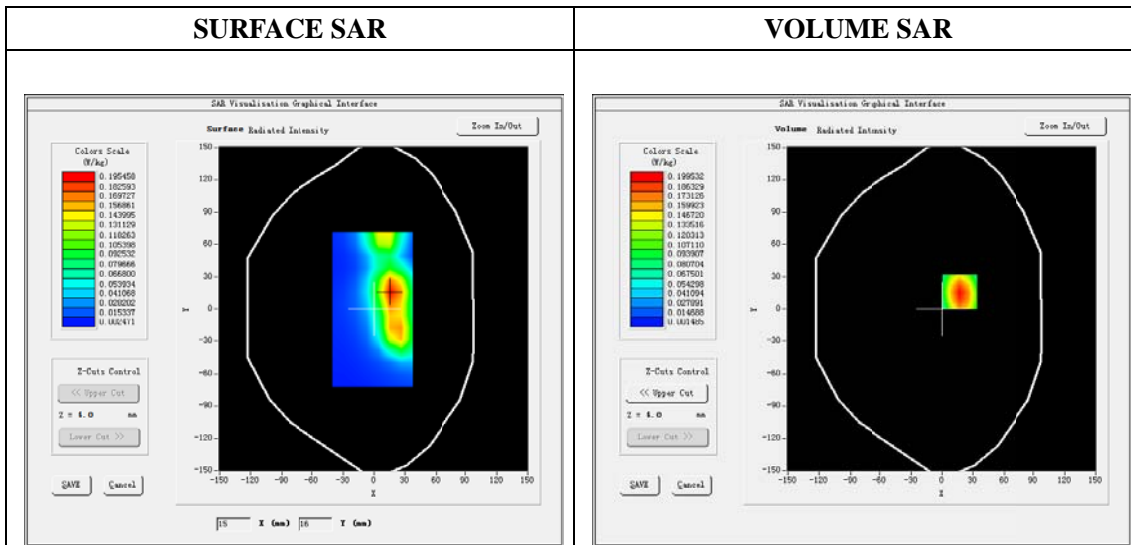

Maximum location: X=17.00, Y=16.00

SAR Peak: 0.40 W/kg

SAR 10g (W/Kg)	0.088814
SAR 1g (W/Kg)	0.191483

Z (mm)	0.00	4.00	9.00	14.00	19.00
SAR (W/Kg)	0.3973	0.1995	0.0743	0.0258	0.0104

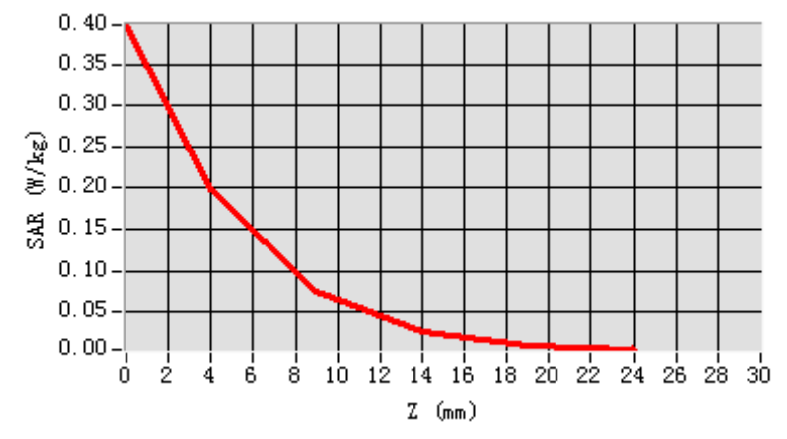

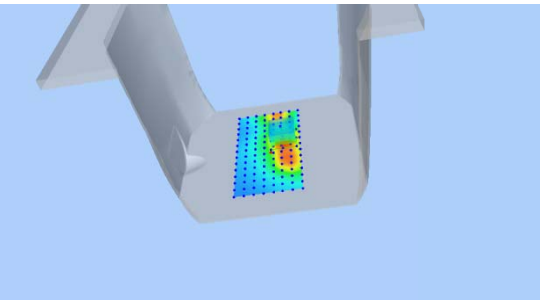
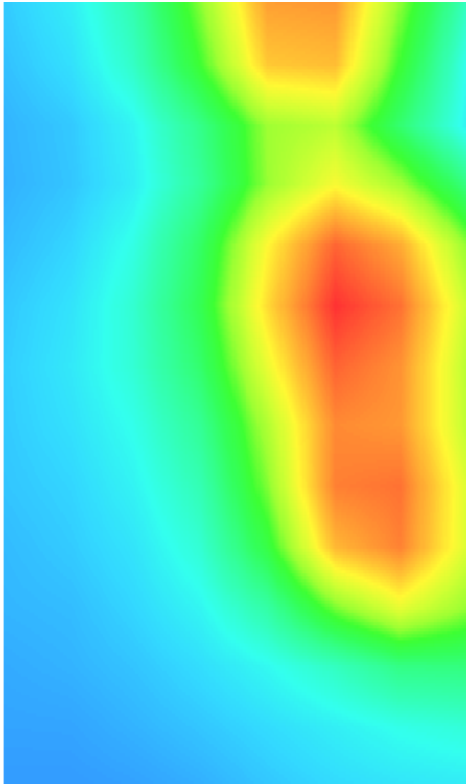
3D screen shot	Hot spot position
	

Plot 13: Testing result (WIFI WIFI 802.11a, Right Cheek, Middle)

Type: Phone measurement
 Date of measurement: 24/09/2016
 Measurement duration: 22 minutes 35 seconds
 Mobile Phone IMEI number: --

A. Experimental conditions.

Area Scan	dx=8mm dy=8mm
ZoomScan	5x5x7,dx=8mm dy=8mm dz=5mm
Phantom	Right head
Device Position	Cheek
Band	WIFI 802.11a
Channels	Middle
Signal	DSSS (Duty cycle: 1:1)

B. SAR Measurement Results

Frequency (MHz)	5785
Relative permittivity (real part)	35.39
Relative permittivity (imaginary part)	16.45
Conductivity (S/m)	5.30
Variation (%)	-0.97

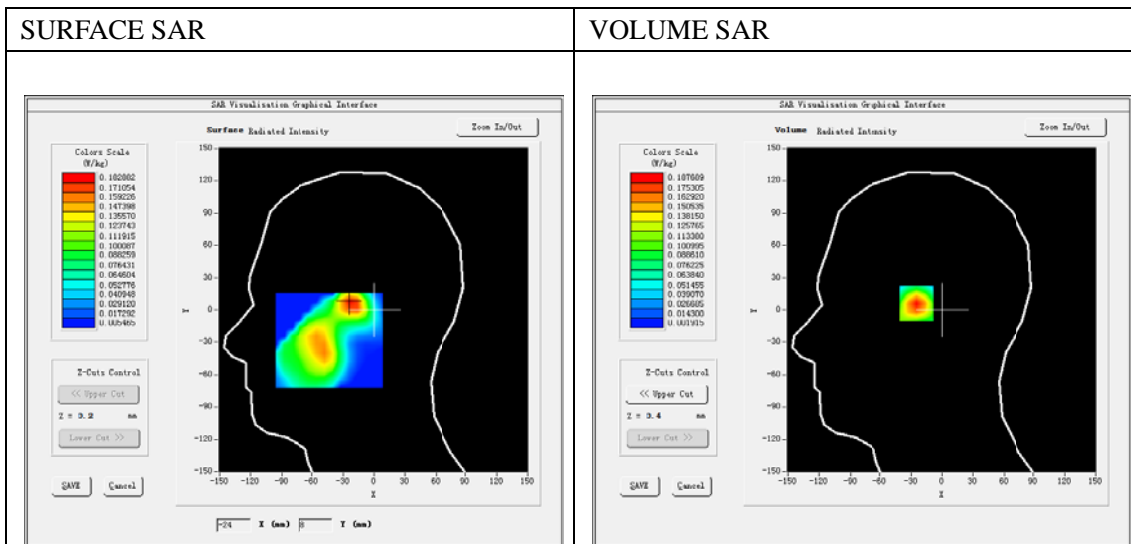

Maximum location: X=-23.00, Y=7.00
 SAR Peak: 0.32 W/kg

SAR 10g (W/Kg)	0.085786
SAR 1g (W/Kg)	0.175276

Z (mm)	0.00	4.00	9.00	14.00	19.00
SAR (W/Kg)	0.3223	0.1877	0.0904	0.0430	0.0218

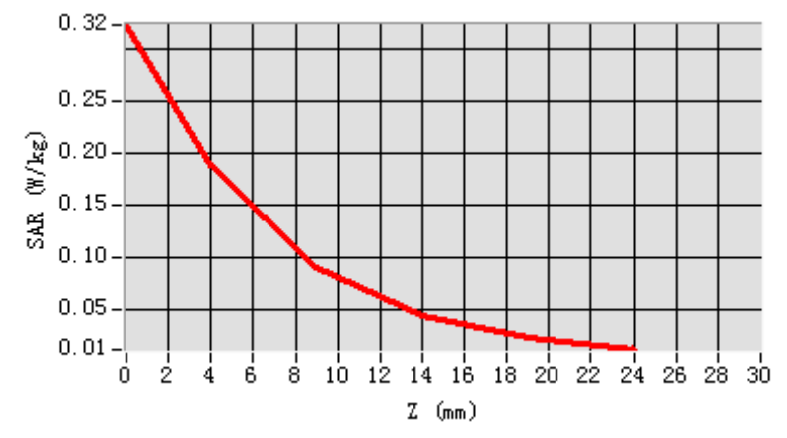

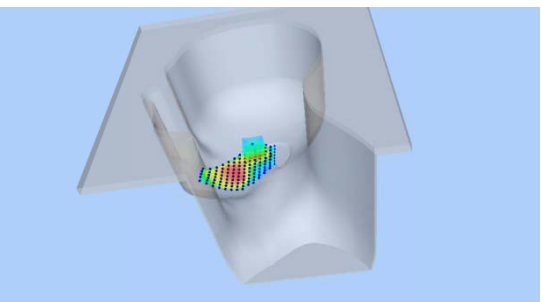
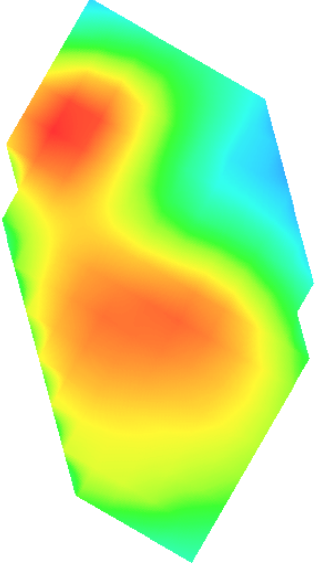
3D screen shot	Hot spot position
	

Plot 14: Testing result (WIFI 802.11a, Edge B, Middle)

Type: Phone measurement

Date of measurement: 21/09/2016

Measurement duration: 22minutes 31 seconds

Mobile Phone IMEI number: --

A. Experimental conditions.

Area Scan	dx=8mm dy=8mm
ZoomScan	5x5x7,dx=8mm dy=8mm dz=5mm
Phantom	Validation plane
Device Position	Body
Band	WIFI 802.11a
Channels	Middle
Signal	DSSS (Duty cycle: 1:1)

B. SAR Measurement Results

Frequency (MHz)	5785
Relative permittivity (real part)	35.39
Relative permittivity (imaginary part)	16.45
Conductivity (S/m)	5.30
Variation (%)	-2.17

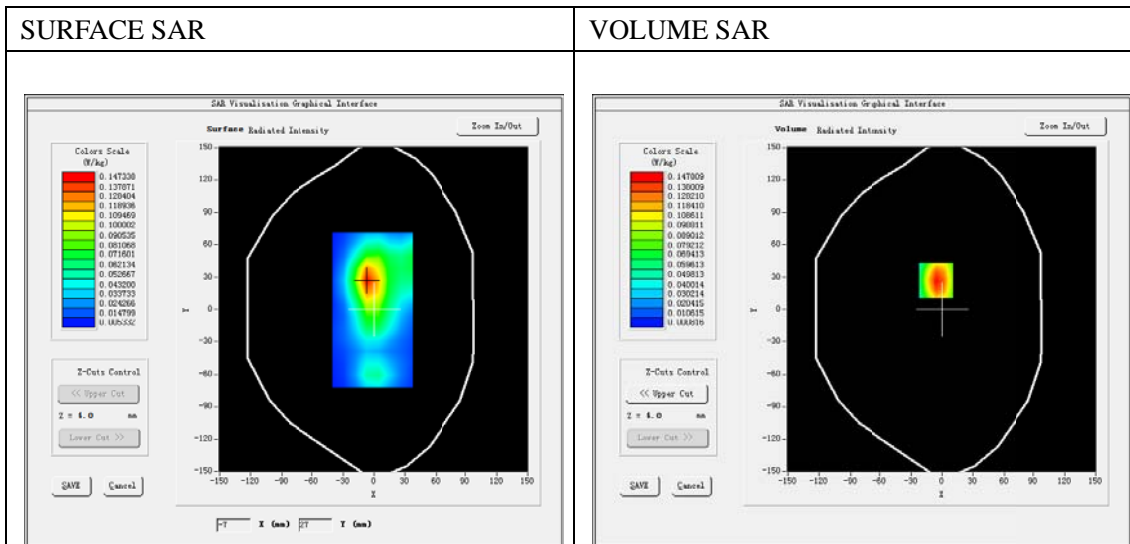

Maximum location: X=-6.00, Y=27.00

SAR Peak: 0.31 W/kg

SAR 10g (W/Kg)	0.065056
SAR 1g (W/Kg)	0.138995

Z (mm)	0.00	4.00	9.00	14.00	19.00
SAR (W/Kg)	0.3077	0.1478	0.0507	0.0159	0.0062

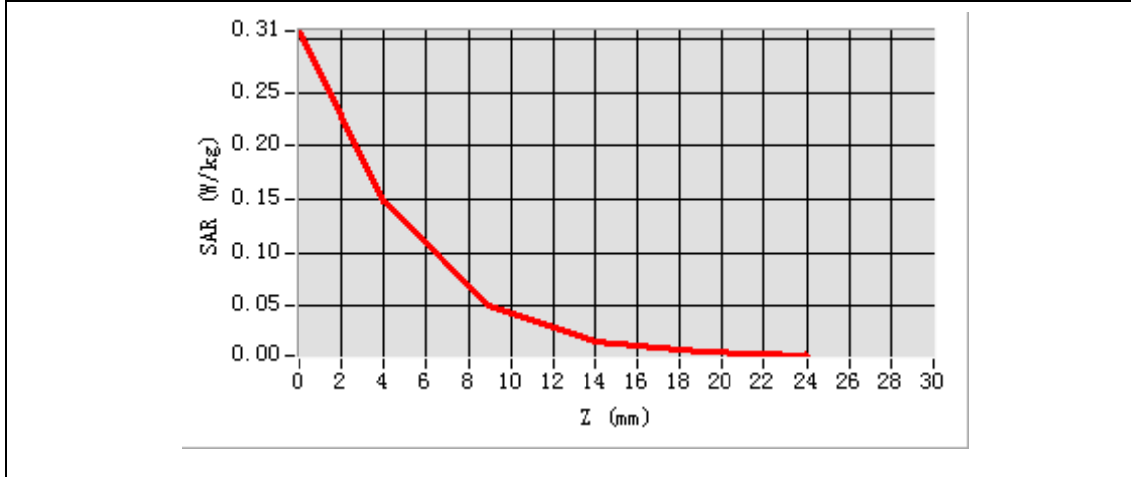

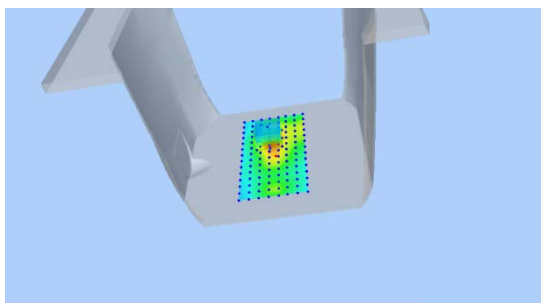
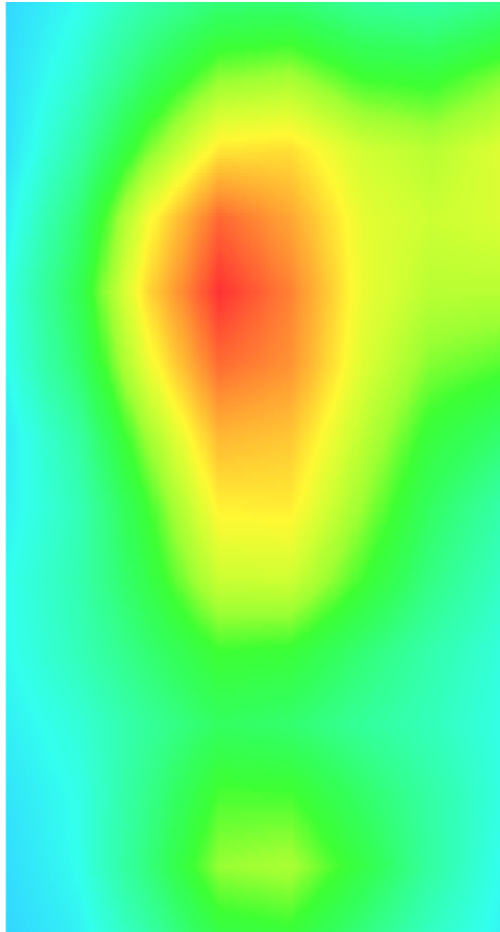
3D screen shot	Hot spot position
	

Plot 15: RFID, Edge A(Body-worn), Mid

Type: Phone measurement
 Date of measurement: 19/09/2016
 Measurement duration: 22 minutes 14 seconds
 Mobile Phone IMEI number: --

A. Experimental conditions.

Area Scan	dx=8mm dy=8mm
ZoomScan	5x5x7,dx=8mm dy=8mm dz=5mm
Phantom	Validation plane
Device Position	Edge A
Band	RFID
Channels	Middle

B. SAR Measurement Results

E-Field Probe	SATIMO SN_43/15_EP276
Frequency (MHz)	915.25
Relative permittivity (real part)	55.47
Relative permittivity (imaginary part)	20.54
Conductivity (S/m)	0.98
Variation (%)	2.65
ConvF:	7.07

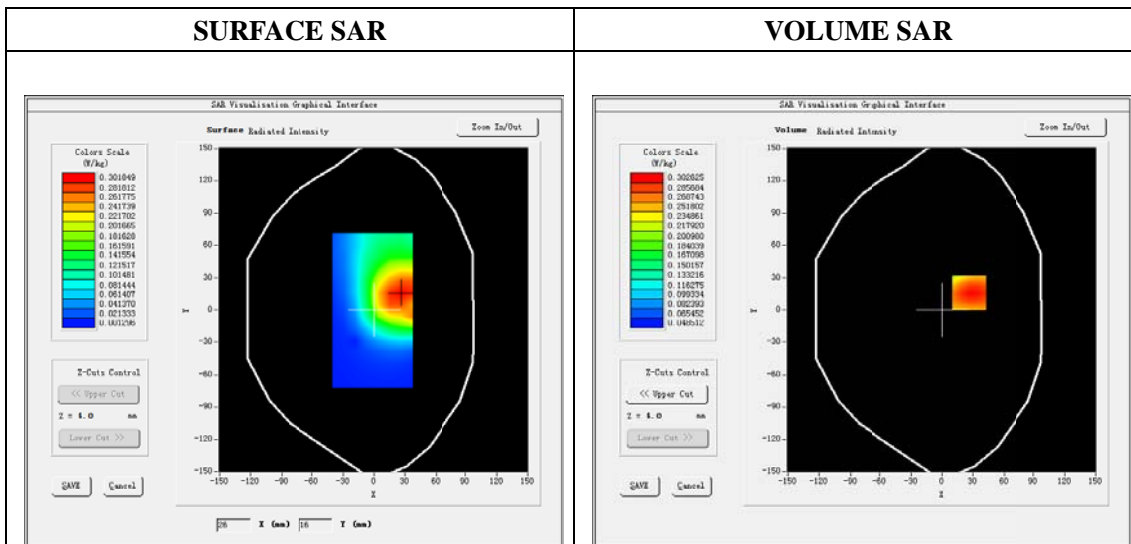

Maximum location: X=26.00, Y=16.00

SAR Peak: 0.42 W/kg

SAR 10g (W/Kg)	0.195408
SAR 1g (W/Kg)	0.323905

Z (mm)	0.00	4.00	9.00	14.00	19.00
SAR (W/Kg)	0.4189	0.3026	0.2020	0.1384	0.0989

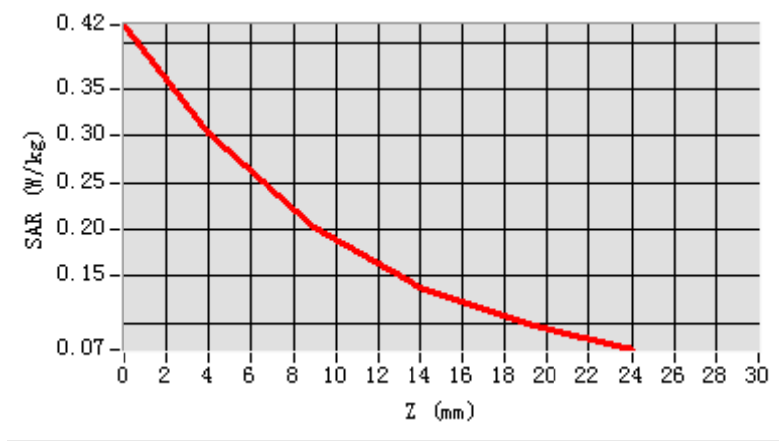

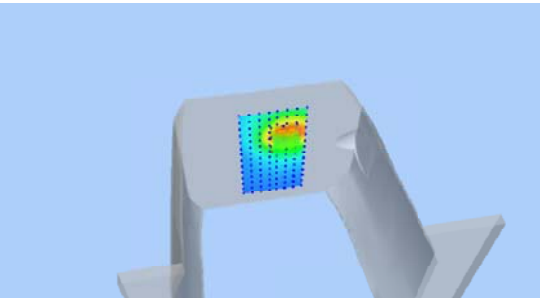
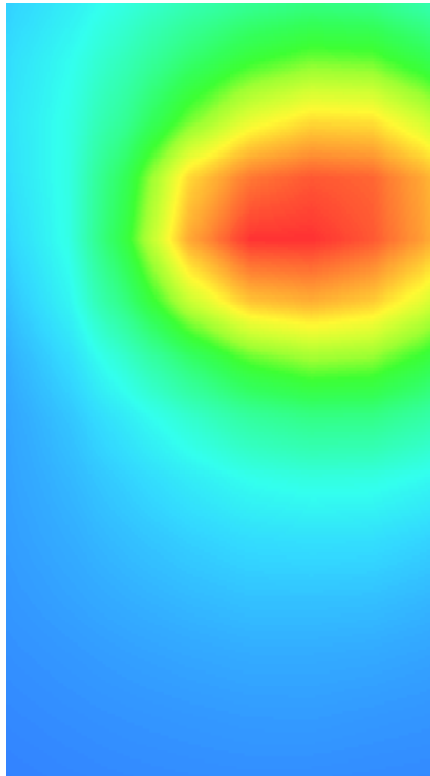
3D screen shot	Hot spot position
	



ANNEX D
of
CCIC-SET

CONFORMANCE TEST REPORT FOR
HUMAN EXPOSURE TO ELECTROMAGNETIC FIELDS

SET2016-20884

Industrial PDA

Type Name: AT870N

Hardware Version: AT870N_MA_V3.0.1

Software Version: ENGSTD_0576_512_R4

Calibration Certificate of Probe and Dipoles

This Annex consists of 71 pages

Date of Report: 2016-10-10

Probe Calibration Certificate

**COMOSAR E-Field Probe Calibration Report**

Ref : ACR.344.2.15.SATU.A

**CCIC SOUTHERN ELECTRONIC PRODUCT
TESTING (SHENZHEN) CO., LTD**
ELECTRONIC TESTING BUILDING, SHAHE ROAD, XILI
TOWN
SHENZHEN, P.R. CHINA (POST CODE:518055)
MVG COMOSAR DOSIMETRIC E-FIELD PROBE
SERIAL NO.: SN 43/15 EP276

Calibrated at MVG US
2105 Barrett Park Dr. - Kennesaw, GA 30144



Calibration Date: 12/09/15

Summary:

This document presents the method and results from an accredited COMOSAR Dosimetric E-Field Probe calibration performed in MVG USA using the CALISAR / CALIBAIR test bench, for use with a COMOSAR system only. All calibration results are traceable to national metrology institutions.



COMOSAR E-FIELD PROBE CALIBRATION REPORT

Ref: ACR.344.0.15.SATU.A

	<i>Name</i>	<i>Function</i>	<i>Date</i>	<i>Signature</i>
<i>Prepared by :</i>	Jérôme LUC	Product Manager	12/10/2015	<i>JS</i>
<i>Checked by :</i>	Jérôme LUC	Product Manager	12/10/2015	<i>JS</i>
<i>Approved by :</i>	Kim RUTKOWSKI	Quality Manager	12/10/2015	<i>Kim Rutkowski</i>

Customer Name

 CCIC SOUTHERN
 ELECTRONIC
 PRODUCT
Distribution : TESTING
 (SHENZHEN) Co.,
 Ltd

<i>Issue</i>	<i>Date</i>	<i>Modifications</i>
A	12/10/2015	Initial release

Page: 2/9

*This document shall not be reproduced, except in full or in part, without the written approval of MVG.
 The information contained herein is to be used only for the purpose for which it is submitted and is not to
 be released in whole or part without written approval of MVG.*



TABLE OF CONTENTS

1	Device Under Test	4
2	Product Description	4
2.1	General Information	4
3	Measurement Method	4
3.1	Linearity	4
3.2	Sensitivity	5
3.3	Lower Detection Limit	5
3.4	Isotropy	5
3.5	Boundary Effect	5
4	Measurement Uncertainty	5
5	Calibration Measurement Results	6
5.1	Sensitivity in air	6
5.2	Linearity	7
5.3	Sensitivity in liquid	7
5.4	Isotropy	8
6	List of Equipment	9

This document shall not be reproduced, except in full or in part, without the written approval of MVG. The information contained herein is to be used only for the purpose for which it is submitted and is not to be released in whole or part without written approval of MVG.



1 DEVICE UNDER TEST

Device Under Test	
Device Type	COMOSAR DOSIMETRIC E FIELD PROBE
Manufacturer	MVG
Model	SSE5
Serial Number	SN 43/15 EP276
Product Condition (new / used)	New
Frequency Range of Probe	0.7 GHz-3GHz
Resistance of Three Dipoles at Connector	Dipole 1: R1=0.211 MΩ Dipole 2: R2=0.206 MΩ Dipole 3: R3=0.211 MΩ

A yearly calibration interval is recommended.

2 PRODUCT DESCRIPTION

2.1 GENERAL INFORMATION

MVG's COMOSAR E field Probes are built in accordance to the IEEE 1528, OET 65 Bulletin C and CEI/IEC 62209 standards.



Figure 1 – MVG COMOSAR Dosimetric E field Dipole

Probe Length	330 mm
Length of Individual Dipoles	4.5 mm
Maximum external diameter	8 mm
Probe Tip External Diameter	5 mm
Distance between dipoles / probe extremity	2.7 mm

3 MEASUREMENT METHOD

The IEEE 1528, OET 65 Bulletin C, CENELEC EN50361 and CEI/IEC 62209 standards provide recommended practices for the probe calibrations, including the performance characteristics of interest and methods by which to assess their affect. All calibrations / measurements performed meet the fore mentioned standards.

3.1 LINEARITY

The evaluation of the linearity was done in free space using the waveguide, performing a power sweep to cover the SAR range 0.01W/kg to 100W/kg.

Page: 4/9

*This document shall not be reproduced, except in full or in part, without the written approval of MVG.
The information contained herein is to be used only for the purpose for which it is submitted and is not to be released in whole or part without written approval of MVG.*



3.2 SENSITIVITY

The sensitivity factors of the three dipoles were determined using a two step calibration method (air and tissue simulating liquid) using waveguides as outlined in the standards.

3.3 LOWER DETECTION LIMIT

The lower detection limit was assessed using the same measurement set up as used for the linearity measurement. The required lower detection limit is 10 mW/kg.

3.4 ISOTROPY

The axial isotropy was evaluated by exposing the probe to a reference wave from a standard dipole with the dipole mounted under the flat phantom in the test configuration suggested for system validations and checks. The probe was rotated along its main axis from 0 - 360 degrees in 15 degree steps. The hemispherical isotropy is determined by inserting the probe in a thin plastic box filled with tissue-equivalent liquid, with the plastic box illuminated with the fields from a half wave dipole. The dipole is rotated about its axis (0°–180°) in 15° increments. At each step the probe is rotated about its axis (0°–360°).

3.5 BOUNDARY EFFECT

The boundary effect is defined as the deviation between the SAR measured data and the expected exponential decay in the liquid when the probe is oriented normal to the interface. To evaluate this effect, the liquid filled flat phantom is exposed to fields from either a reference dipole or waveguide. With the probe normal to the phantom surface, the peak spatial average SAR is measured and compared to the analytical value at the surface.

4 MEASUREMENT UNCERTAINTY

The guidelines outlined in the IEEE 1528, OET 65 Bulletin C, CENELEC EN50361 and CEI/IEC 62209 standards were followed to generate the measurement uncertainty associated with an E-field probe calibration using the waveguide technique. All uncertainties listed below represent an expanded uncertainty expressed at approximately the 95% confidence level using a coverage factor of $k=2$, traceable to the Internationally Accepted Guides to Measurement Uncertainty.

Uncertainty analysis of the probe calibration in waveguide					
ERROR SOURCES	Uncertainty value (%)	Probability Distribution	Divisor	ci	Standard Uncertainty (%)
Incident or forward power	3.00%	Rectangular	$\sqrt{3}$	1	1.732%
Reflected power	3.00%	Rectangular	$\sqrt{3}$	1	1.732%
Liquid conductivity	5.00%	Rectangular	$\sqrt{3}$	1	2.887%
Liquid permittivity	4.00%	Rectangular	$\sqrt{3}$	1	2.309%
Field homogeneity	3.00%	Rectangular	$\sqrt{3}$	1	1.732%
Field probe positioning	5.00%	Rectangular	$\sqrt{3}$	1	2.887%

Page: 5/9

This document shall not be reproduced, except in full or in part, without the written approval of MVG. The information contained herein is to be used only for the purpose for which it is submitted and is not to be released in whole or part without written approval of MVG.



Field probe linearity	3.00%	Rectangular	$\sqrt{3}$	1	1.732%
Combined standard uncertainty					5.831%
Expanded uncertainty 95 % confidence level k = 2					12.0%

5 CALIBRATION MEASUREMENT RESULTS

Calibration Parameters	
Liquid Temperature	21 °C
Lab Temperature	21 °C
Lab Humidity	45 %

5.1 SENSITIVITY IN AIR

Normx dipole 1 ($\mu\text{V}/(\text{V}/\text{m})^2$)	Normy dipole 2 ($\mu\text{V}/(\text{V}/\text{m})^2$)	Normz dipole 3 ($\mu\text{V}/(\text{V}/\text{m})^2$)
4.37	4.52	5.21

DCP dipole 1 (mV)	DCP dipole 2 (mV)	DCP dipole 3 (mV)
100	96	97

Calibration curves $e_i=f(V)$ ($i=1,2,3$) allow to obtain H-field value using the formula:

$$E = \sqrt{E_1^2 + E_2^2 + E_3^2}$$

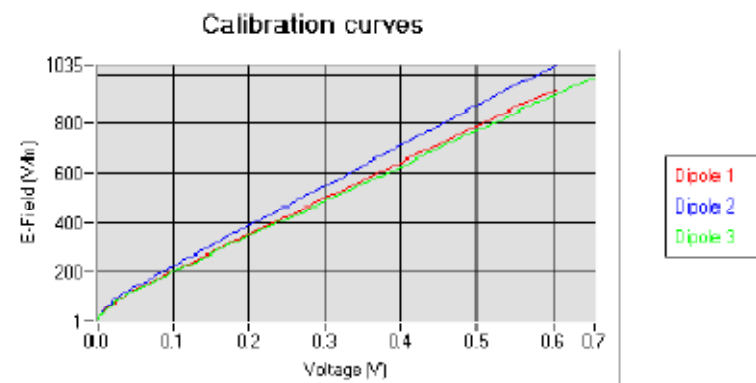

Page: 6/9

This document shall not be reproduced, except in full or in part, without the written approval of MVG. The information contained herein is to be used only for the purpose for which it is submitted and is not to be released in whole or part without written approval of MVG.



5.2 LINEARITY

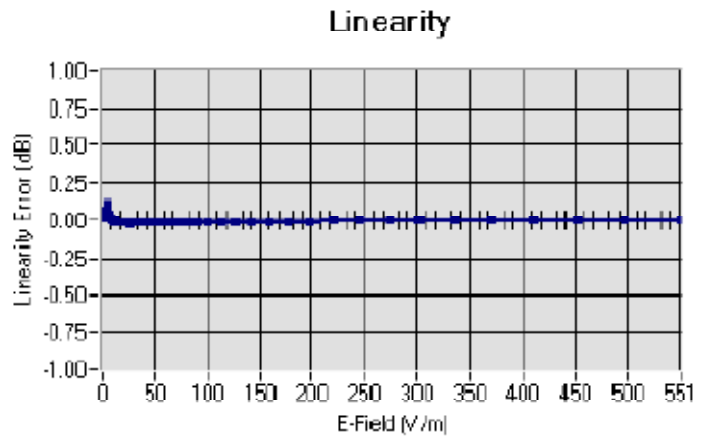

Linearity: \pm 2.48% (\pm 0.11 dB)

5.3 SENSITIVITY IN LIQUID

Liquid	Frequency (MHz +/- 100MHz)	Permittivity	Epsilon (S/m)	ConvF
HL750	750	42.24	0.90	5.96
BL750	750	56.85	0.99	6.13
HL850	835	43.02	0.90	6.81
BL850	835	53.72	0.98	7.07
HL900	900	42.47	0.99	6.05
BL900	900	56.97	1.09	6.28
HL1800	1750	42.24	1.40	5.44
BL1800	1750	53.53	1.53	5.62
HL1900	1880	40.79	1.42	6.05
BL1900	1880	54.47	1.57	6.18
HL2000	1950	40.52	1.44	5.63
BL2000	1950	54.18	1.56	5.79
HL2300	2300	39.14	1.66	5.76
BL2300	2300	52.17	1.79	5.99
HL2450	2450	38.73	1.81	5.52
BL2450	2450	53.23	1.96	5.70
HL2600	2600	38.54	1.95	5.57
BL2600	2600	52.07	2.23	5.73

LOWER DETECTION LIMIT: 8mW/kg

Page: 7/9

*This document shall not be reproduced, except in full or in part, without the written approval of MVG.
The information contained herein is to be used only for the purpose for which it is submitted and is not to be released in whole or part without written approval of MVG.*

5.4 ISOTROPY

HL900 MHz

- Axial isotropy: 0.04 dB
- Hemispherical isotropy: 0.06 dB

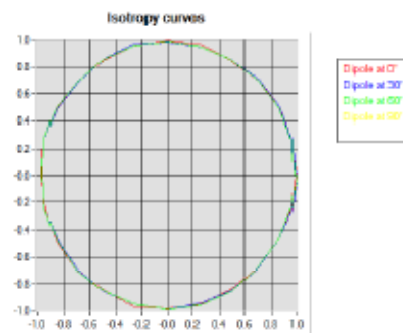

HL1800 MHz

- Axial isotropy: 0.04 dB
- Hemispherical isotropy: 0.07 dB

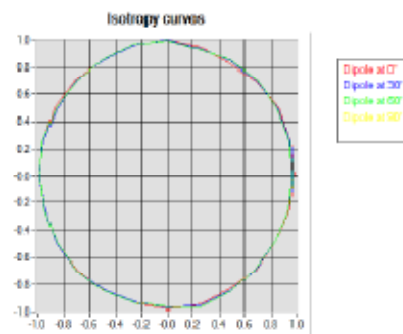

Page: 8/9

*This document shall not be reproduced, except in full or in part, without the written approval of MVG.
The information contained here in is to be used only for the purpose for which it is submitted and is not to be released in whole or part without written approval of MVG.*



6 LIST OF EQUIPMENT

Equipment Summary Sheet				
Equipment Description	Manufacturer / Model	Identification No.	Current Calibration Date	Next Calibration Date
Flat Phantom	MVG	SN-20/09-SAM71	Validated. No cal required.	Validated. No cal required.
COMOSAR Test Bench	Version 3	NA	Validated. No cal required.	Validated. No cal required.
Network Analyzer	Rhode & Schwarz ZVA	SN100132	02/2013	02/2016
Reference Probe	MVG	EP 94 SN 37/08	10/2015	10/2016
Multimeter	Keithley 2000	1188656	12/2013	12/2016
Signal Generator	Agilent E4438C	MY49070581	12/2013	12/2016
Amplifier	Aethercomm	SN 046	Characterized prior to test. No cal required.	Characterized prior to test. No cal required.
Power Meter	HP E4418A	US38261498	12/2013	12/2016
Power Sensor	HP ECP-E26A	US37181460	12/2013	12/2016
Directional Coupler	Narda 4216-20	01386	Characterized prior to test. No cal required.	Characterized prior to test. No cal required.
Waveguide	Mega Industries	069Y7-158-13-712	Validated. No cal required.	Validated. No cal required.
Waveguide Transition	Mega Industries	069Y7-158-13-701	Validated. No cal required.	Validated. No cal required.
Waveguide Termination	Mega Industries	069Y7-158-13-701	Validated. No cal required.	Validated. No cal required.

Page: 9/9

This document shall not be reproduced, except in full or in part, without the written approval of MVG. The information contained herein is to be used only for the purpose for which it is submitted and is not to be released in whole or part without written approval of MVG.

SID835 Dipole Calibration Certificate**SAR Reference Dipole Calibration Report**

Ref: ACR.240.1.14.SATU.A

**CCIC SOUTHERN ELECTRONIC PRODUCT
TESTING (SHENZHEN) CO., LTD
ELECTRONIC TESTING BUILDING, SHAHE ROAD, XILI
TOWN
SHENZHEN, P.R. CHINA (POST CODE:518055)
SATIMO COMOSAR REFERENCE DIPOLE
FREQUENCY: 835 MHZ
SERIAL NO.: SN 09/13 DIP0G835-217**

**Calibrated at SATIMO US
2105 Barrett Park Dr. - Kennesaw, GA 30144**



08/28/14

Summary:

This document presents the method and results from an accredited SAR reference dipole calibration performed in SATIMO USA using the COMOSAR test bench. All calibration results are traceable to national metrology institutions.



SAR REFERENCE DIPOLE CALIBRATION REPORT

Ref: ACR.240.1.14 SATU.A

	<i>Name</i>	<i>Function</i>	<i>Date</i>	<i>Signature</i>
<i>Prepared by :</i>	Jérôme LUC	Product Manager	8/29/2014	<i>JL</i>
<i>Checked by :</i>	Jérôme LUC	Product Manager	8/29/2014	<i>JL</i>
<i>Approved by :</i>	Kim RUTKOWSKI	Quality Manager	8/29/2014	<i>Kim Rutkowski</i>

	<i>Customer Name</i>
<i>Distribution :</i>	CCIC SOUTHERN ELECTRONIC PRODUCT TESTING (SHENZHEN) Co., Ltd

<i>Issue</i>	<i>Date</i>	<i>Modifications</i>
A	8/29/2014	Initial release



TABLE OF CONTENTS

1 Introduction.....4

2 Device Under Test4

3 Product Description4

 3.1 General Information 4

4 Measurement Method 5

 4.1 Return Loss Requirements 5

 4.2 Mechanical Requirements 5

5 Measurement Uncertainty 5

 5.1 Return Loss 5

 5.2 Dimension Measurement 5

 5.3 Validation Measurement 5

6 Calibration Measurement Results..... 6

 6.1 Return Loss and Impedance In Head Liquid 6

 6.2 Return Loss and Impedance In Body Liquid 6

 6.3 Mechanical Dimensions 6

7 Validation measurement 7

 7.1 Head Liquid Measurement 7

 7.2 SAR Measurement Result With Head Liquid 8

 7.3 Body Liquid Measurement 9

 7.4 SAR Measurement Result With Body Liquid 10

8 List of Equipment 11



1 INTRODUCTION

This document contains a summary of the requirements set forth by the IEEE 1528, OET 65 Bulletin C and CEI/IEC 62209 standards for reference dipoles used for SAR measurement system validations and the measurements that were performed to verify that the product complies with the fore mentioned standards.

2 DEVICE UNDER TEST

Device Under Test	
Device Type	COMOSAR 835 MHz REFERENCE DIPOLE
Manufacturer	Satimo
Model	SID835
Serial Number	SN 09/13 DIP0G835-217
Product Condition (new / used)	used

A yearly calibration interval is recommended.

3 PRODUCT DESCRIPTION

3.1 GENERAL INFORMATION

Satimo's COMOSAR Validation Dipoles are built in accordance to the IEEE 1528, OET 65 Bulletin C and CEI/IEC 62209 standards. The product is designed for use with the COMOSAR test bench only.



Figure 1 – Satimo COMOSAR Validation Dipole

Page: 4/11

This document shall not be reproduced, except in full or in part, without the written approval of SATIMO.