

FCC Test Report

Report No.: RF180312C26-2

FCC ID: VUITX061AEI

Test Model: TX061AEI

Received Date: Mar. 12, 2018

Test Date: Feb. 13, 2018 ~ Mar. 16, 2018

Issued Date: Mar. 31, 2018

Applicant: PEGATRON CORPORATION

Address: 5F., NO. 76, LIGONG ST., BEITOU DISTRICT, TAIPEI CITY 11259, Taiwan

Issued By: Bureau Veritas Consumer Products Services (H.K.) Ltd., Taoyuan Branch

Lab Address: No. 47-2, 14th Ling, Chia Pau Vil., Lin Kou Dist., New Taipei City, Taiwan
(R.O.C)

Test Location: No. 19, Hwa Ya 2nd Rd, Wen Hwa Tsuen, Kwei Shan Hsiang, Taoyuan
Hsien 333, Taiwan, R.O.C.

**FCC Registration /
Designation Number:** 788550 / TW0003



This report is for your exclusive use. Any copying or replication of this report to or for any other person or entity, or use of our name or trademark, is permitted only with our prior written permission. This report sets forth our findings solely with respect to the test samples identified herein. The results set forth in this report are not indicative or representative of the quality or characteristics of the lot from which a test sample was taken or any similar or identical product unless specifically and expressly noted. Our report includes all of the tests requested by you and the results thereof based upon the information that you provided to us. You have 60 days from date of issuance of this report to notify us of any material error or omission caused by our negligence, provided, however, that such notice shall be in writing and shall specifically address the issue you wish to raise. A failure to raise such issue within the prescribed time shall constitute your unqualified acceptance of the completeness of this report, the tests conducted and the correctness of the report contents. Unless specific mention, the uncertainty of measurement has been explicitly taken into account to declare the compliance or non-compliance to the specification.

Table of Contents

Release Control Record	4
1 Certificate of Conformity	5
2 Summary of Test Results	6
2.1 Measurement Uncertainty	6
2.2 Modification Record	6
3 General Information	7
3.1 General Description of EUT	7
3.2 Description of Test Modes	8
3.2.1 Test Mode Applicability and Tested Channel Detail	9
3.3 Duty Cycle of Test Signal	11
3.4 Description of Support Units	12
3.4.1 Configuration of System under Test	12
3.5 General Description of Applied Standards	12
4 Test Types and Results	13
4.1 Radiated Emission and Bandedge Measurement	13
4.1.1 Limits of Radiated Emission and Bandedge Measurement	13
4.1.2 Test Instruments	14
4.1.3 Test Procedures	15
4.1.4 Deviation from Test Standard	15
4.1.5 Test Set Up	16
4.1.6 EUT Operating Conditions	17
4.1.7 Test Results	18
4.2 Conducted Emission Measurement	31
4.2.1 Limits of Conducted Emission Measurement	31
4.2.2 Test Instruments	31
4.2.3 Test Procedures	32
4.2.4 Deviation from Test Standard	32
4.2.5 Test Setup	32
4.2.6 EUT Operating Conditions	32
4.2.7 Test Results	33
4.3 6 dB Bandwidth Measurement	35
4.3.1 Limits of 6 dB Bandwidth Measurement	35
4.3.2 Test Setup	35
4.3.3 Test Instruments	35
4.3.4 Test Procedure	35
4.3.5 Deviation from Test Standard	35
4.3.6 EUT Operating Conditions	35
4.3.7 Test Result	36
4.4 Occupied Bandwidth Measurement	38
4.4.1 Test Setup	38
4.4.2 Test Instruments	38
4.4.3 Test Procedure	38
4.4.4 Deviation from Test Standard	38
4.4.5 EUT Operating Conditions	38
4.4.6 Test Results	39
4.5 Conducted Output Power Measurement	41
4.5.1 Limits of Conducted Output Power Measurement	41
4.5.2 Test Setup	41
4.5.3 Test Instruments	41
4.5.4 Test Procedures	41
4.5.5 Deviation from Test Standard	41
4.5.6 EUT Operating Conditions	41
4.5.7 Test Results	42

4.6	Power Spectral Density Measurement	44
4.6.1	Limits of Power Spectral Density Measurement.....	44
4.6.2	Test Setup.....	44
4.6.3	Test Instruments	44
4.6.4	Test Procedure	44
4.6.5	Deviation from Test Standard	44
4.6.6	EUT Operating Condition	44
4.6.7	Test Results	45
4.7	Conducted Out of Band Emission Measurement	47
4.7.1	Limits of Conducted Out of Band Emission Measurement.....	47
4.7.2	Test Setup.....	47
4.7.3	Test Instruments	47
4.7.4	Test Procedure	47
4.7.5	Deviation from Test Standard	47
4.7.6	EUT Operating Condition	47
4.7.7	Test Results	48
5	Pictures of Test Arrangements.....	64
	Appendix – Information on the Testing Laboratories	65

Release Control Record

Issue No.	Description	Date Issued
RF180312C26-2	Original Release	Mar. 31, 2018

1 Certificate of Conformity

Product: Networked Client Set-Top BOX

Brand: technicolor

Test Model: TX061AEI

Sample Status: ENGINEERING SAMPLE

Applicant: PEGATRON CORPORATION

Test Date: Feb. 13, 2018 ~ Mar. 16, 2018

Standards: 47 CFR FCC Part 15, Subpart C (Section 15.247)
ANSI C63.10:2013

The above equipment has been tested by **Bureau Veritas Consumer Products Services (H.K.) Ltd., Taoyuan Branch**, and found compliance with the requirement of the above standards. The test record, data evaluation & Equipment Under Test (EUT) configurations represented herein are true and accurate accounts of the measurements of the sample's RF characteristics under the conditions specified in this report.

Prepared by : Evonne Liu, **Date:** Mar. 31, 2018
Evonne Liu / Specialist

Approved by : Dylan Chiou, **Date:** Mar. 31, 2018
Dylan Chiou / Project Engineer

2 Summary of Test Results

47 CFR FCC Part 15, Subpart C (Section 15.247)			
FCC Clause	Test Item	Result	Remarks
15.207	AC Power Conducted Emission	Pass	Meet the requirement of limit. Minimum passing margin is -9.58 dB at 0.15000 MHz.
15.205 / 15.209 / 15.247(d)	Radiated Emissions and Band Edge Measurement	Pass	Meet the requirement of limit. Minimum passing margin is -0.78 dB at 2483.52 MHz.
15.247(d)	Antenna Port Emission	Pass	Meet the requirement of limit.
15.247(a)(2)	6 dB Bandwidth	Pass	Meet the requirement of limit.
---	Occupied Bandwidth Measurement	Pass	Reference only
15.247(b)	Conducted power	Pass	Meet the requirement of limit.
15.247(e)	Power Spectral Density	Pass	Meet the requirement of limit.
15.203	Antenna Requirement	Pass	No antenna connector is used.

2.1 Measurement Uncertainty

Where relevant, the following measurement uncertainty levels have been estimated for tests performed on the EUT:

The listed uncertainties are the worst case uncertainty for the entire range of measurement. Please note that the uncertainty values are provided for informational purposes only and are not used in determining the PASS/FAIL results.

Measurement	Frequency	Expanded Uncertainty (k=2) (\pm)
Conducted Emissions at mains ports	150 kHz ~ 30 MHz	2.44 dB
Radiated Emissions up to 1 GHz	30 MHz ~ 200 MHz	2.93 dB
	200 MHz ~ 1000 MHz	2.95 dB
Radiated Emissions above 1 GHz	1 GHz ~ 18 GHz	2.26 dB
	18 GHz ~ 40 GHz	1.94 dB

2.2 Modification Record

There were no modifications required for compliance.

3 General Information

3.1 General Description of EUT

Product	Networked Client Set-Top BOX
Brand	technicolor
Test Model	TX061AEI
Status of EUT	ENGINEERING SAMPLE
Power Supply Rating	5.0 Vdc (adapter)
Modulation Type	CCK, DQPSK, DBPSK for DSSS 64QAM, 16QAM, QPSK, BPSK for OFDM
Modulation Technology	DSSS, OFDM
Transfer Rate	802.11b: 11.0 / 5.5 / 2.0 / 1.0 Mbps 802.11g: 54.0 / 48.0 / 36.0 / 24.0 / 18.0 / 12.0 / 9.0 / 6.0 Mbps 802.11n: up to 300Mbps
Operating Frequency	2412 ~ 2462 MHz
Number of Channel	11 for 802.11b, 802.11g, 802.11n (HT20) 7 for 802.11n (HT40)
Output Power	639.623 mW
Antenna Type	PCB antenna with 4 dBi gain (Main) / 3.2 dBi gain (Aux.)
Antenna Connector	N/A
Accessory Device	Refer to Note as below
Data Cable Supplied	Refer to Note as below

Note:

- The EUT incorporates a MIMO function. Physically, the EUT provides two completed transmitters and two receivers.

Modulation Mode	Tx Function
802.11b	2TX
802.11g	2TX
802.11n (HT20)	2TX
802.11n (HT40)	2TX

- The EUT contains following accessory devices.

Product	Brand	Model	Description
Adapter 1	Lite-On	EPS-10	I/P: 100-120 Vac, 60 Hz, 0.8 A O/P: 5 Vdc, 3 A
Adapter 2	Comcast	EPS-10	I/P: 100-120 Vac, 60 Hz, 0.8 A O/P: 5 Vdc, 3 A
Adapter 3	AcBel	EPS-10	I/P: 100-120 Vac, 60 Hz, 0.4 A O/P: 5 Vdc, 3 A

- The above EUT information is declared by manufacturer and for more detailed features description, please refer to the manufacturer's specifications or user's manual.

3.2 Description of Test Modes

11 channels are provided for 802.11b, 802.11g and 802.11n (HT20):

Channel	Frequency (MHz)	Channel	Frequency (MHz)
1	2412	7	2442
2	2417	8	2447
3	2422	9	2452
4	2427	10	2457
5	2432	11	2462
6	2437		

7 channels are provided for 802.11n (HT40):

Channel	Frequency (MHz)	Channel	Frequency (MHz)
3	2422	7	2442
4	2427	8	2447
5	2432	9	2452
6	2437		

3.2.1 Test Mode Applicability and Tested Channel Detail

EUT Configure Mode	Applicable To				Description
	RE \geq 1G	RE<1G	PLC	APCM	
-	√	√	√	√	-

Where **RE \geq 1G**: Radiated Emission above 1 GHz **RE<1G**: Radiated Emission below 1 GHz
PLC: Power Line Conducted Emission **APCM**: Antenna Port Conducted Measurement

NOTE: The EUT had been pre-tested on the positioned of each 3 axis. The worst case was found when positioned on **Y-plane**.

Radiated Emission Test (Above 1 GHz):

- Pre-Scan has been conducted to determine the worst-case mode from all possible combinations between available modulations, data rates and antenna ports (if EUT with antenna diversity architecture).
- Following channel(s) was (were) selected for the final test as listed below.

EUT Configure Mode	Mode	Available Channel	Tested Channel	Modulation Technology	Modulation Type	Data Rate (Mbps)
-	802.11b	1 to 11	1, 6, 11	DSSS	DBPSK	1.0
-	802.11g	1 to 11	1, 6, 11	OFDM	BPSK	6.0
-	802.11n (HT20)	1 to 11	1, 6, 11	OFDM	BPSK	MCS0
-	802.11n (HT40)	3 to 9	3, 6, 9	OFDM	BPSK	MCS0

Radiated Emission Test (Below 1 GHz):

- Pre-Scan has been conducted to determine the worst-case mode from all possible combinations between available modulations, data rates and antenna ports (if EUT with antenna diversity architecture).
- Following channel(s) was (were) selected for the final test as listed below.

EUT Configure Mode	Mode	Available Channel	Tested Channel	Modulation Technology	Modulation Type	Data Rate (Mbps)
AcBel	802.11g	1 to 11	11	OFDM	BPSK	6.0

Power Line Conducted Emission Test:

- Pre-Scan has been conducted to determine the worst-case mode from all possible combinations between available modulations, data rates and antenna ports (if EUT with antenna diversity architecture).
- Following channel(s) was (were) selected for the final test as listed below.

EUT Configure Mode	Mode	Available Channel	Tested Channel	Modulation Technology	Modulation Type	Data Rate (Mbps)
-	802.11g	1 to 11	11	OFDM	BPSK	6.0

Bandedge Measurement:

- Pre-Scan has been conducted to determine the worst-case mode from all possible combinations between available modulations, data rates and antenna ports (if EUT with antenna diversity architecture).
- Following channel(s) was (were) selected for the final test as listed below.

EUT Configure Mode	Mode	Available Channel	Tested Channel	Modulation Technology	Modulation Type	Data Rate (Mbps)
-	802.11b	1 to 11	1, 11	DSSS	DBPSK	1.0
-	802.11g	1 to 11	1, 11	OFDM	BPSK	6.0
-	802.11n (HT20)	1 to 11	1, 11	OFDM	BPSK	MCS0
-	802.11n (HT40)	3 to 9	3, 9	OFDM	BPSK	MCS0

Antenna Port Conducted Measurement:

- This item includes all test value of each mode, but only includes spectrum plot of worst value of each mode.
- Pre-Scan has been conducted to determine the worst-case mode from all possible combinations between available modulations, data rates and antenna ports (if EUT with antenna diversity architecture).
- Following channel(s) was (were) selected for the final test as listed below.

EUT Configure Mode	Mode	Available Channel	Tested Channel	Modulation Technology	Modulation Type	Data Rate (Mbps)
-	802.11b	1 to 11	1, 6, 11	DSSS	DBPSK	1.0
-	802.11g	1 to 11	1, 6, 11	OFDM	BPSK	6.0
-	802.11n (HT20)	1 to 11	1, 6, 11	OFDM	BPSK	MCS0
-	802.11n (HT40)	3 to 9	3, 6, 9	OFDM	BPSK	MCS0

Test Condition:

Applicable To	Environmental Conditions	Input Power	Tested by
RE \geq 1G	25 deg. C, 65 % RH	120 Vac, 60 Hz	Getaz Yang
RE<1G	25 deg. C, 65 % RH	120 Vac, 60 Hz	Getaz Yang
PLC	25 deg. C, 65 % RH	120 Vac, 60 Hz	Getaz Yang
APCM	25 deg. C, 65 % RH	120 Vac, 60 Hz	Vincent Yang

3.3 Duty Cycle of Test Signal

802.11b: Duty cycle of test signal is > 98 %

802.11g: Duty cycle = $2.061/2.18 = 0.945$, Duty factor = $10 * \log(1/0.945) = 0.24$

802.11n (HT20): Duty cycle = $0.981/1.099 = 0.893$, Duty factor = $10 * \log(1/0.893) = 0.49$

802.11n (HT40): Duty cycle = $0.493/0.629 = 0.784$, Duty factor = $10 * \log(1/0.784) = 1.06$

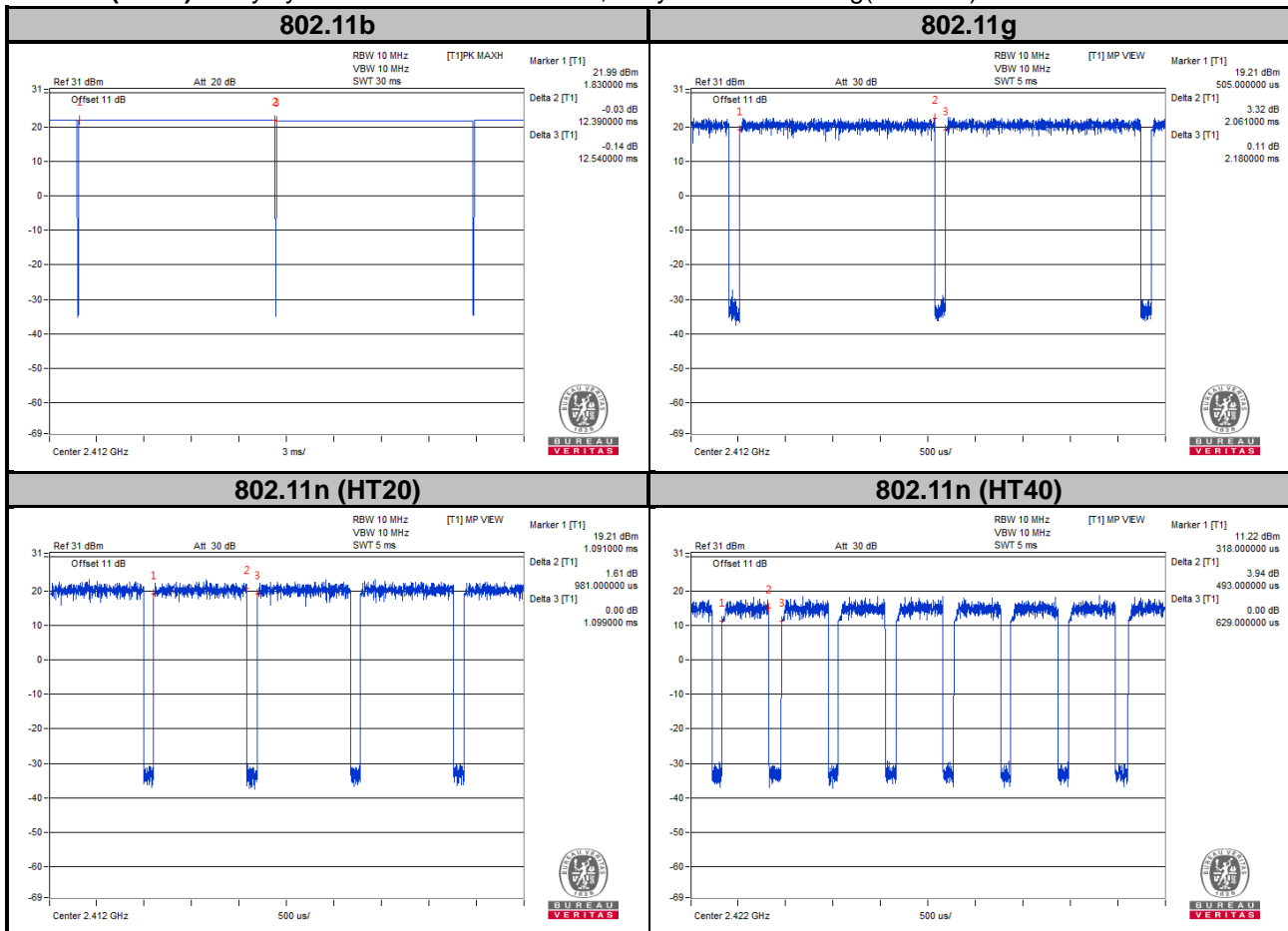

3.4 Description of Support Units

The EUT has been tested as an independent unit together with other necessary accessories or support units.

3.4.1 Configuration of System under Test

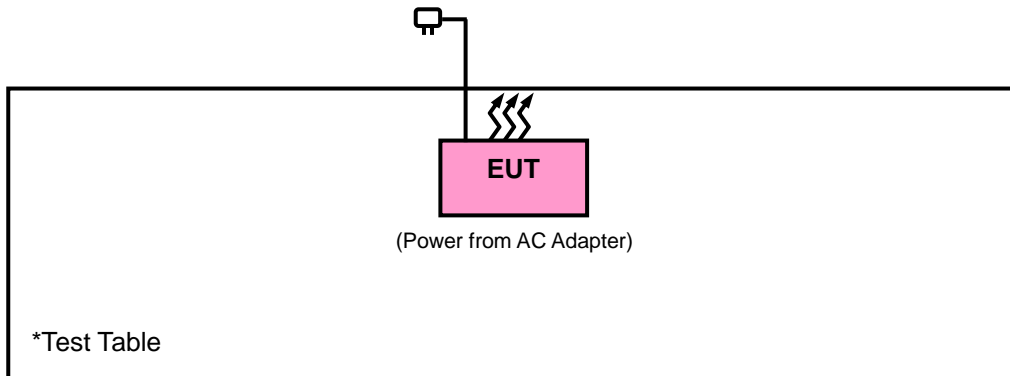

3.5 General Description of Applied Standards

The EUT is a RF Product. According to the specifications of the manufacturer, it must comply with the requirements of the following standards:

FCC Part 15, Subpart C (15.247)

558074 D01 DTS Meas Guidance v04

662911 D01 Multiple Transmitter Output v02r01

ANSI C63.10-2013

All test items have been performed and recorded as per the above standards.

4 Test Types and Results

4.1 Radiated Emission and Bandedge Measurement

4.1.1 Limits of Radiated Emission and Bandedge Measurement

Radiated emissions which fall in the restricted bands must comply with the radiated emission limits specified as below table. Other emissions shall be at least 20 dB below the highest level of the desired power:

Frequencies (MHz)	Field Strength (microvolts/meter)	Measurement Distance (meters)
0.009 ~ 0.490	2400/F (kHz)	300
0.490 ~ 1.705	24000/F (kHz)	30
1.705 ~ 30.0	30	30
30 ~ 88	100	3
88 ~ 216	150	3
216 ~ 960	200	3
Above 960	500	3

NOTE:

1. The lower limit shall apply at the transition frequencies.
2. Emission level (dBuV/m) = 20 log Emission level (uV/m).
3. For frequencies above 1000 MHz, the field strength limits are based on average detector, however, the peak field strength of any emission shall not exceed the maximum permitted average limits, specified above by more than 20 dB under any condition of modulation.

4.1.2 Test Instruments

Description & Manufacturer	Model No.	Serial No.	Date of Calibration	Due Date of Calibration
Test Receiver Agilent	N9038A	MY51210137	Jun. 23, 2017	Jun. 22, 2018
Spectrum Analyzer Agilent	N9010A	MY52220314	Nov. 24, 2017	Nov. 23, 2018
Spectrum Analyzer ROHDE & SCHWARZ	FSU43	101261	Jan. 11, 2018	Jan. 10, 2019
BILOG Antenna SCHWARZBECK	VULB9168	9168-472	Dec. 06, 2017	Dec. 05, 2018
HORN Antenna SCHWARZBECK	BBHA 9120 D	9120D-969	Dec. 12, 2017	Dec. 11, 2018
HORN Antenna SCHWARZBECK	BBHA 9170	9170-480	Dec. 01, 2017	Nov. 30, 2018
Fixed Attenuator Mini-Circuits	MDCS18N-10	MDCS18N-10-01	Apr. 17, 2017	Apr. 16, 2018
Loop Antenna	HLA 6121	45745	May 19, 2017	May 18, 2018
Preamplifier EMCI	EMC001340	980201	Nov. 01, 2017	Oct. 31, 2018
Bluetooth Tester	CBT	100946	Jul. 29, 2016	Jul. 28, 2018
Preamplifier EMCI	EMC 012645	980115	Oct. 20, 2017	Oct. 19, 2018
Preamplifier EMCI	EMC 184045	980116	Oct. 20, 2017	Oct. 19, 2018
Preamplifier EMCI	EMC 330H	980112	Oct. 13, 2017	Oct. 12, 2018
Power Meter Anritsu	ML2495A	1012010	Aug. 15, 2017	Aug. 14, 2018
Power Sensor Anritsu	MA2411B	1315050	Aug. 15, 2017	Aug. 14, 2018
RF Coaxial Cable HUBER+SUHNNER	EMC104-SM-SM-8 000&3000	140811+170717	Oct. 20, 2017	Oct. 19, 2018
RF Coaxial Cable HUBER+SUHNNER	SUCOFLEX 104	EMC104-SM-SM- 1000(140807)	Oct. 20, 2017	Oct. 19, 2018
RF Coaxial Cable Worken	8D-FB	Cable-Ch10-01	Oct. 20, 2017	Oct. 19, 2018
Software BV ADT	E3 6.120103	NA	NA	NA
Antenna Tower MF	MFA-440H	NA	NA	NA
Turn Table MF	MFT-201SS	NA	NA	NA
Antenna Tower & Turn Table Controller MF	MF-7802	NA	NA	NA

- Note: 1. The calibration interval of the above test instruments is 12 months and the calibrations are traceable to NML/ROC and NIST/USA.
2. The test was performed in HwaYa Chamber 10.
3. The horn antenna and preamplifier (model: EMC 184045) are used only for the measurement of emission frequency above 1 GHz if tested.
4. The IC Site Registration No. is IC7450F-10.

4.1.3 Test Procedures

- a. The EUT was placed on the top of a rotating table 0.8 meters (for below 1 GHz) / 1.5 meters (for above 1 GHz) above the ground at 3 meter chamber room for test. The table was rotated 360 degrees to determine the position of the highest radiation.
- b. The EUT was set 3 meters away from the interference-receiving antenna, which was mounted on the top of a variable-height antenna tower.
- c. The height of antenna is varied from one meter to four meters above the ground to determine the maximum value of the field strength. Both horizontal and vertical polarizations of the antenna are set to make the measurement.
- d. For each suspected emission, the EUT was arranged to its worst case and then the antenna was tuned to heights from 1 meter to 4 meters and the rotatable table was turned from 0 degrees to 360 degrees to find the maximum reading.
- e. The test-receiver system was set to quasi-peak detect function and specified bandwidth with maximum hold mode when the test frequency is below 1 GHz.
- f. The test-receiver system was set to peak and average detected function and specified bandwidth with maximum hold mode when the test frequency is above 1 GHz. If the peak reading value also meets average limit, measurement with the average detector is unnecessary.

Note:

1. The resolution bandwidth and video bandwidth of test receiver/spectrum analyzer is 120 kHz & 360 KHz for Quasi-peak detection (QP) at frequency below 1 GHz.
2. The resolution bandwidth of test receiver/spectrum analyzer is 1 MHz and the video bandwidth is 3 MHz for Peak detection (PK) at frequency above 1 GHz.
3. The resolution bandwidth of test receiver/spectrum analyzer is 1 MHz and the video bandwidth is 1/T for Average (Duty cycle < 98 %) detection at frequency above 1 GHz.
4. The resolution bandwidth of test receiver/spectrum analyzer is 1 MHz and the video bandwidth is 10 Hz (Duty cycle \geq 98 %) for Average detection (AV) at frequency above 1 GHz.
5. All modes of operation were investigated and the worst-case emissions are reported.

4.1.4 Deviation from Test Standard

No deviation.

4.1.5 Test Set Up

<Radiated emission below 30 MHz>

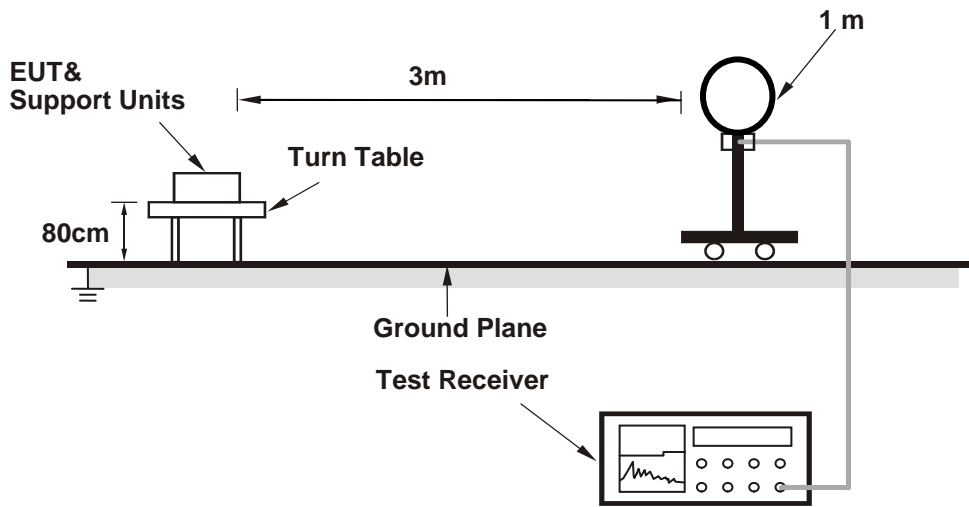

<Frequency Range below 1 GHz>

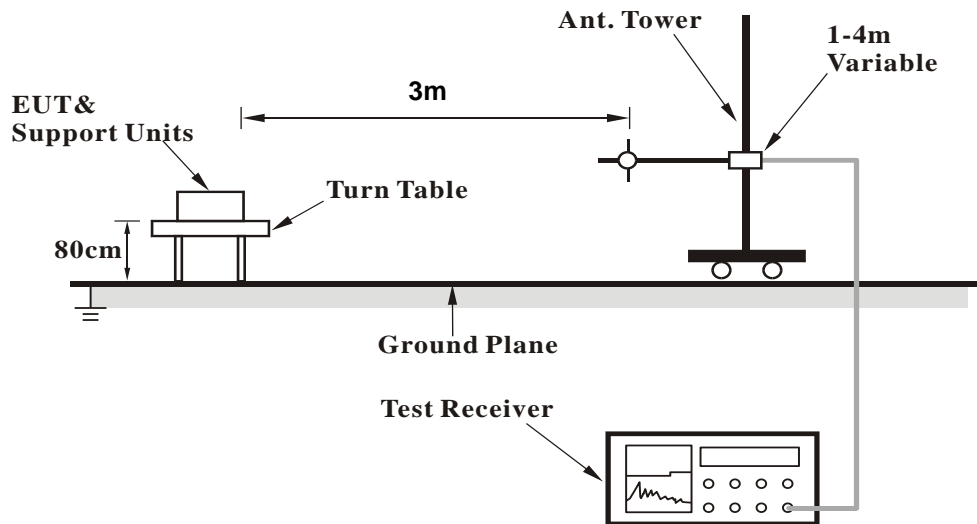

<Frequency Range above 1 GHz>

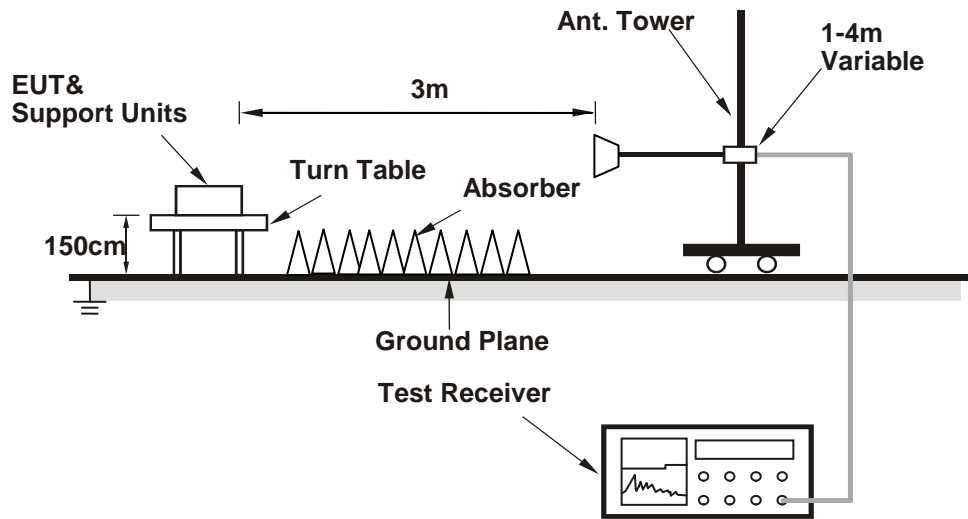

For the actual test configuration, please refer to the attached file (Test Setup Photo).

4.1.6 EUT Operating Conditions

- a. Placed the EUT on a testing table.
- b. Use the software to control the EUT under transmission condition continuously at specific channel frequency.

4.1.7 Test Results

Above 1 GHz Data :
802.11b

EUT Test Condition		Measurement Detail	
Channel	Channel 1	Frequency Range	1 GHz ~ 25 GHz
Input Power	120 Vac, 60 Hz	Detector Function	Peak (PK) Average (AV)
Environmental Conditions	25 deg. C, 65 % RH	Tested By	Getaz Yang

Antennal Polarity & Test Distance: Horizontal at 3 m										
Frequency (MHz)	Emission Level (dBuV/m)	Read Level (dBuV)	Limit (dBuV/m)	Margin (dB)	Antenna Factor (dB/m)	Cable Loss (dB)	Preamp Factor (dB)	Antenna Height (cm)	Table Angle (Degree)	Remark
2389.1	46.89	52.87	54	-7.11	27.16	4.36	37.5	149	167	Average
2389.1	59.14	65.12	74	-14.86	27.16	4.36	37.5	149	167	Peak
2412	105.24	111.15			27.23	4.38	37.52	149	167	Average
2412	114.82	120.73			27.23	4.38	37.52	149	167	Peak
4824	49.32	64.23	54	-4.68	31.17	6.81	52.89	101	160	Average
4824	57.2	72.11	74	-16.8	31.17	6.81	52.89	101	160	Peak
*9648	53.67	58.09	85.24	-31.57	38.59	9.59	52.6	140	317	Average
*9648	61.36	65.78	94.82	-33.46	38.59	9.59	52.6	140	317	Peak
Antennal Polarity & Test Distance: Vertical at 3 m										
Frequency (MHz)	Emission Level (dBuV/m)	Read Level (dBuV)	Limit (dBuV/m)	Margin (dB)	Antenna Factor (dB/m)	Cable Loss (dB)	Preamp Factor (dB)	Antenna Height (cm)	Table Angle (Degree)	Remark
2383.78	46.16	52.45	54	-7.84	26.86	4.35	37.5	124	96	Average
2383.78	54.98	61.22	74	-19.02	26.91	4.35	37.5	124	96	Peak
2412	108.37	114.28			27.23	4.38	37.52	124	96	Average
2412	111.93	117.84			27.23	4.38	37.52	124	96	Peak
4824	50.05	65.33	54	-3.95	30.99	6.81	53.08	132	325	Average
4824	57.62	72.9	74	-16.38	30.99	6.81	53.08	132	325	Peak
*9648	57.91	60.28	88.37	-30.46	38.32	9.59	50.28	143	24	Average
*9648	65.02	67.39	91.93	-26.91	38.32	9.59	50.28	143	24	Peak

Remarks:

- Emission Level = Read Level + Antenna Factor + Cable Loss - Preamp Factor
Margin value = Emission level – Limit value
- 2412 MHz: Fundamental frequency.
- *: Out of Restricted Band

EUT Test Condition		Measurement Detail	
Channel	Channel 6	Frequency Range	1 GHz ~ 25 GHz
Input Power	120 Vac, 60 Hz	Detector Function	Peak (PK) Average (AV)
Environmental Conditions	25 deg. C, 65 % RH	Tested By	Getaz Yang

Antennal Polarity & Test Distance: Horizontal at 3 m										
Frequency (MHz)	Emission Level (dBuV/m)	Read Level (dBuV)	Limit (dBuV/m)	Margin (dB)	Antenna Factor (dB/m)	Cable Loss (dB)	Preamp Factor (dB)	Antenna Height (cm)	Table Angle (Degree)	Remark
2389.8	39	45.25	54	-15	26.91	4.36	37.52	154	15	Average
2389.8	50.83	57.06	74	-23.17	26.91	4.36	37.5	154	15	Peak
2437	109.82	115.82			27.06	4.4	37.46	154	15	Average
2437	114.42	120.42			27.06	4.4	37.46	154	15	Peak
2483.8	41.34	47.08	54	-12.66	27.15	4.43	37.32	154	15	Average
2483.8	53.73	59.47	74	-20.27	27.15	4.43	37.32	154	15	Peak
4874	45.55	60.3	54	-8.45	31.25	6.86	52.86	111	123	Average
4874	53.03	67.78	74	-20.97	31.25	6.86	52.86	111	123	Peak
*9748	51.47	55.67	89.82	-38.35	38.74	9.74	52.68	201	123	Average
*9748	58.27	62.47	94.42	-36.15	38.74	9.74	52.68	201	123	Peak
Antennal Polarity & Test Distance: Vertical at 3 m										
Frequency (MHz)	Emission Level (dBuV/m)	Read Level (dBuV)	Limit (dBuV/m)	Margin (dB)	Antenna Factor (dB/m)	Cable Loss (dB)	Preamp Factor (dB)	Antenna Height (cm)	Table Angle (Degree)	Remark
2388.96	38.93	45.16	54	-15.07	26.91	4.36	37.5	121	94	Average
2388.96	49.91	56.15	74	-24.09	26.91	4.35	37.5	121	94	Peak
2437	107.74	113.74			27.06	4.4	37.46	121	94	Average
2437	111.24	117.24			27.06	4.4	37.46	121	94	Peak
2485.2	41.66	47.27	54	-12.34	27.2	4.44	37.25	121	94	Average
2485.2	52.25	57.99	74	-21.75	27.15	4.43	37.32	121	94	Peak
4874	47.43	62.56	54	-6.57	31.06	6.86	53.05	102	256	Average
4874	54.06	69.19	74	-19.94	31.06	6.86	53.05	102	256	Peak
*9748	54.73	56.98	87.74	-33.01	38.41	9.74	50.4	102	123	Average
*9748	62.17	64.42	91.24	-29.07	38.41	9.74	50.4	102	123	Peak

Remarks:

- Emission Level = Read Level + Antenna Factor + Cable Loss - Preamp Factor
Margin value = Emission level – Limit value
- 2437 MHz: Fundamental frequency.
- *: Out of Restricted Band

EUT Test Condition		Measurement Detail	
Channel	Channel 11	Frequency Range	1 GHz ~ 25 GHz
Input Power	120 Vac, 60 Hz	Detector Function	Peak (PK) Average (AV)
Environmental Conditions	25 deg. C, 65 % RH	Tested By	Getaz Yang

Antennal Polarity & Test Distance: Horizontal at 3 m										
Frequency (MHz)	Emission Level (dBuV/m)	Read Level (dBuV)	Limit (dBuV/m)	Margin (dB)	Antenna Factor (dB/m)	Cable Loss (dB)	Preamp Factor (dB)	Antenna Height (cm)	Table Angle (Degree)	Remark
2462	104.39	109.91			27.46	4.41	37.39	179	168	Average
2462	114.33	119.85			27.46	4.41	37.39	179	168	Peak
2484.04	47.97	53.33	54	-6.03	27.53	4.43	37.32	179	168	Average
2484.04	60.89	66.25	74	-13.11	27.53	4.43	37.32	179	168	Peak
4924	42.97	57.63	54	-11.03	31.34	6.89	52.89	111	165	Average
4924	48.79	63.45	74	-25.21	31.34	6.89	52.89	111	165	Peak
*9848	49.49	53.55	84.39	-34.9	38.86	9.8	52.72	203	251	Average
*9848	56.07	60.13	94.33	-38.26	38.86	9.8	52.72	203	251	Peak

Antennal Polarity & Test Distance: Vertical at 3 m										
Frequency (MHz)	Emission Level (dBuV/m)	Read Level (dBuV)	Limit (dBuV/m)	Margin (dB)	Antenna Factor (dB/m)	Cable Loss (dB)	Preamp Factor (dB)	Antenna Height (cm)	Table Angle (Degree)	Remark
2462	104.76	110.28			27.46	4.41	37.39	125	86	Average
2462	112.57	118.09			27.46	4.41	37.39	125	86	Peak
2499.92	42.71	48.32	54	-11.29	27.2	4.44	37.25	125	86	Average
2499.92	54.01	59.62	74	-19.99	27.2	4.44	37.25	125	86	Peak
4924	45.22	60.24	54	-8.78	31.12	6.89	53.03	102	236	Average
4924	51.61	66.63	74	-22.39	31.12	6.89	53.03	102	236	Peak
*9848	52.82	55.48	84.76	-31.94	38.48	9.8	50.94	222	236	Average
*9848	59.69	62.35	92.57	-32.88	38.48	9.8	50.94	222	236	Peak

Remarks:

- Emission Level = Read Level + Antenna Factor + Cable Loss - Preamp Factor
Margin value = Emission level – Limit value
- 2462 MHz: Fundamental frequency.
- *: Out of Restricted Band

802.11g

EUT Test Condition		Measurement Detail	
Channel	Channel 1	Frequency Range	1 GHz ~ 25 GHz
Input Power	120 Vac, 60 Hz	Detector Function	Peak (PK) Average (AV)
Environmental Conditions	25 deg. C, 65 % RH	Tested By	Getaz Yang

Antennal Polarity & Test Distance: Horizontal at 3 m										
Frequency (MHz)	Emission Level (dBuV/m)	Read Level (dBuV)	Limit (dBuV/m)	Margin (dB)	Antenna Factor (dB/m)	Cable Loss (dB)	Preamp Factor (dB)	Antenna Height (cm)	Table Angle (Degree)	Remark
2389.94	52.87	58.87	54	-1.13	27.16	4.36	37.52	150	186	Average
2389.94	67.72	73.72	74	-6.28	27.16	4.36	37.52	150	186	Peak
2412	104.84	110.75			27.23	4.38	37.52	150	186	Average
2412	114.78	120.69			27.23	4.38	37.52	150	186	Peak
4824	40.45	55.36	54	-13.55	31.17	6.81	52.89	111	123	Average
4824	50.4	65.3	74	-23.6	31.17	6.82	52.89	111	123	Peak
Antennal Polarity & Test Distance: Vertical at 3 m										
Frequency (MHz)	Emission Level (dBuV/m)	Read Level (dBuV)	Limit (dBuV/m)	Margin (dB)	Antenna Factor (dB/m)	Cable Loss (dB)	Preamp Factor (dB)	Antenna Height (cm)	Table Angle (Degree)	Remark
2389.1	50.39	56.37	54	-3.61	27.16	4.36	37.5	121	218	Average
2389.1	66.4	72.38	74	-7.6	27.16	4.36	37.5	121	218	Peak
2412	103.24	109.15			27.23	4.38	37.52	121	218	Average
2412	112.74	118.65			27.23	4.38	37.52	121	218	Peak
4824	40.4	55.68	54	-13.6	30.99	6.81	53.08	123	125	Average
4824	50.42	65.7	74	-23.58	30.99	6.81	53.08	123	125	Peak

Remarks:

- Emission Level = Read Level + Antenna Factor + Cable Loss - Preamp Factor
Margin value = Emission level – Limit value
- 2412 MHz: Fundamental frequency.

EUT Test Condition		Measurement Detail	
Channel	Channel 6	Frequency Range	1 GHz ~ 25 GHz
Input Power	120 Vac, 60 Hz	Detector Function	Peak (PK) Average (AV)
Environmental Conditions	25 deg. C, 65 % RH	Tested By	Getaz Yang

Antennal Polarity & Test Distance: Horizontal at 3 m										
Frequency (MHz)	Emission Level (dBuV/m)	Read Level (dBuV)	Limit (dBuV/m)	Margin (dB)	Antenna Factor (dB/m)	Cable Loss (dB)	Preamp Factor (dB)	Antenna Height (cm)	Table Angle (Degree)	Remark
2389.94	41.31	47.56	54	-12.69	26.91	4.36	37.52	159	9	Average
2389.94	54.04	60.28	74	-19.96	26.91	4.35	37.5	159	9	Peak
2437	106.13	111.81			27.38	4.4	37.46	159	9	Average
2437	115.91	121.59			27.38	4.4	37.46	159	9	Peak
2483.64	44.89	50.63	54	-9.11	27.15	4.43	37.32	159	9	Average
2483.64	54.66	60.4	74	-19.34	27.15	4.43	37.32	159	9	Peak
4874	39.59	54.53	54	-14.41	31.06	6.86	52.86	158	10	Average
4874	47.29	62.23	74	-26.71	31.06	6.86	52.86	158	10	Peak

Antennal Polarity & Test Distance: Vertical at 3 m										
Frequency (MHz)	Emission Level (dBuV/m)	Read Level (dBuV)	Limit (dBuV/m)	Margin (dB)	Antenna Factor (dB/m)	Cable Loss (dB)	Preamp Factor (dB)	Antenna Height (cm)	Table Angle (Degree)	Remark
2389.1	38.8	45.03	54	-15.2	26.91	4.36	37.5	124	91	Average
2389.1	50.6	56.83	74	-23.4	26.91	4.36	37.5	124	91	Peak
2437	104.04	110.04			27.06	4.4	37.46	124	91	Average
2437	113.09	119.09			27.06	4.4	37.46	124	91	Peak
2484.8	42.04	47.65	54	-11.96	27.2	4.44	37.25	124	91	Average
2484.8	52.65	58.39	74	-21.35	27.15	4.43	37.32	124	91	Peak
4874	38.27	53.21	54	-15.73	31.06	6.86	52.86	124	128	Average
4875	46.36	61.3	74	-27.64	31.06	6.86	52.86	124	128	Peak

Remarks:

- Emission Level = Read Level + Antenna Factor + Cable Loss - Preamp Factor
Margin value = Emission level – Limit value
- 2437 MHz: Fundamental frequency.

EUT Test Condition		Measurement Detail	
Channel	Channel 11	Frequency Range	1 GHz ~ 25 GHz
Input Power	120 Vac, 60 Hz	Detector Function	Peak (PK) Average (AV)
Environmental Conditions	25 deg. C, 65 % RH	Tested By	Getaz Yang

Antennal Polarity & Test Distance: Horizontal at 3 m										
Frequency (MHz)	Emission Level (dBuV/m)	Read Level (dBuV)	Limit (dBuV/m)	Margin (dB)	Antenna Factor (dB/m)	Cable Loss (dB)	Preamp Factor (dB)	Antenna Height (cm)	Table Angle (Degree)	Remark
2462	104.54	110.06			27.46	4.41	37.39	162	165	Average
2462	114.54	120.06			27.46	4.41	37.39	162	165	Peak
2483.52	53.22	58.58	54	-0.78	27.53	4.43	37.32	162	165	Average
2483.52	70.18	75.54	74	-3.82	27.53	4.43	37.32	162	165	Peak
4924	36.81	51.69	54	-17.19	31.12	6.89	52.89	164	8	Average
4924	44.74	59.62	74	-29.26	31.12	6.89	52.89	164	8	Peak
Antennal Polarity & Test Distance: Vertical at 3 m										
Frequency (MHz)	Emission Level (dBuV/m)	Read Level (dBuV)	Limit (dBuV/m)	Margin (dB)	Antenna Factor (dB/m)	Cable Loss (dB)	Preamp Factor (dB)	Antenna Height (cm)	Table Angle (Degree)	Remark
2462	101.89	107.41			27.46	4.41	37.39	130	84	Average
2462	112.06	117.58			27.46	4.41	37.39	130	84	Peak
2483.52	52.33	58.07	54	-1.67	27.15	4.43	37.32	130	84	Average
2483.52	66.83	72.57	74	-7.17	27.15	4.43	37.32	130	84	Peak
4924	36.92	51.8	54	-17.08	31.12	6.89	52.89	135	114	Average
4924	44.07	58.95	74	-29.93	31.12	6.89	52.89	135	114	Peak

Remarks:

- Emission Level = Read Level + Antenna Factor + Cable Loss - Preamp Factor
Margin value = Emission level – Limit value
- 2462 MHz: Fundamental frequency.

802.11n (HT20)

EUT Test Condition		Measurement Detail	
Channel	Channel 1	Frequency Range	1 GHz ~ 25 GHz
Input Power	120 Vac, 60 Hz	Detector Function	Peak (PK) Average (AV)
Environmental Conditions	25 deg. C, 65 % RH	Tested By	Getaz Yang

Antennal Polarity & Test Distance: Horizontal at 3 m

Frequency (MHz)	Emission Level (dBuV/m)	Read Level (dBuV)	Limit (dBuV/m)	Margin (dB)	Antenna Factor (dB/m)	Cable Loss (dB)	Preamp Factor (dB)	Antenna Height (cm)	Table Angle (Degree)	Remark
2389.94	52.96	58.96	54	-1.04	27.16	4.36	37.52	168	165	Average
2389.94	69.28	75.28	74	-4.72	27.16	4.36	37.52	168	165	Peak
2412	104.64	110.55			27.23	4.38	37.52	168	165	Average
2412	114.64	120.55			27.23	4.38	37.52	168	165	Peak
4824	39.42	54.51	54	-14.58	30.99	6.81	52.89	158	10	Average
4824	48.86	63.95	74	-25.14	30.99	6.81	52.89	158	10	Peak

Antennal Polarity & Test Distance: Vertical at 3 m

Frequency (MHz)	Emission Level (dBuV/m)	Read Level (dBuV)	Limit (dBuV/m)	Margin (dB)	Antenna Factor (dB/m)	Cable Loss (dB)	Preamp Factor (dB)	Antenna Height (cm)	Table Angle (Degree)	Remark
2389.94	52.03	58.28	54	-1.97	26.91	4.36	37.52	124	80	Average
2389.94	68.51	74.76	74	-5.49	26.91	4.36	37.52	124	80	Peak
2412	101.82	108			26.96	4.38	37.52	124	80	Average
2412	111.52	117.7			26.96	4.38	37.52	124	80	Peak
4824	36.14	51.23	54	-17.86	30.99	6.81	52.89	135	151	Average
4824	48.73	63.82	74	-25.27	30.99	6.81	52.89	135	151	Peak

Remarks:

- Emission Level = Read Level + Antenna Factor + Cable Loss - Preamp Factor
Margin value = Emission level – Limit value
- 2412 MHz: Fundamental frequency.

EUT Test Condition		Measurement Detail	
Channel	Channel 6	Frequency Range	1 GHz ~ 25 GHz
Input Power	120 Vac, 60 Hz	Detector Function	Peak (PK) Average (AV)
Environmental Conditions	25 deg. C, 65 % RH	Tested By	Getaz Yang

Antennal Polarity & Test Distance: Horizontal at 3 m										
Frequency (MHz)	Emission Level (dBuV/m)	Read Level (dBuV)	Limit (dBuV/m)	Margin (dB)	Antenna Factor (dB/m)	Cable Loss (dB)	Preamp Factor (dB)	Antenna Height (cm)	Table Angle (Degree)	Remark
2389.8	44.05	50.05	54	-9.95	27.16	4.36	37.52	176	8	Average
2389.8	58.51	64.51	74	-15.49	27.16	4.36	37.52	176	8	Peak
2437	108.36	114.04			27.38	4.4	37.46	176	8	Average
2437	117.25	122.93			27.38	4.4	37.46	176	8	Peak
2483.52	45.09	50.45	54	-8.91	27.53	4.43	37.32	176	8	Average
2483.52	57.57	62.93	74	-16.43	27.53	4.43	37.32	176	8	Peak
4874	37.95	52.89	54	-16.05	31.06	6.86	52.86	165	0	Average
4874	48.25	63.19	74	-25.75	31.06	6.86	52.86	165	0	Peak

Antennal Polarity & Test Distance: Vertical at 3 m										
Frequency (MHz)	Emission Level (dBuV/m)	Read Level (dBuV)	Limit (dBuV/m)	Margin (dB)	Antenna Factor (dB/m)	Cable Loss (dB)	Preamp Factor (dB)	Antenna Height (cm)	Table Angle (Degree)	Remark
2389.38	43.02	49	54	-10.98	27.16	4.36	37.5	122	95	Average
2389.38	57.57	63.55	74	-16.43	27.16	4.36	37.5	122	95	Peak
2437	105.03	110.71			27.38	4.4	37.46	122	95	Average
2437	115.66	121.34			27.38	4.4	37.46	122	95	Peak
2484.36	42.73	48.09	54	-11.27	27.53	4.43	37.32	122	95	Average
2484.36	57.12	62.48	74	-16.88	27.53	4.43	37.32	122	95	Peak
4874	41.57	56.51	54	-12.43	31.06	6.86	52.86	129	161	Average
4874	49.63	64.57	74	-24.37	31.06	6.86	52.86	129	161	Peak

Remarks:

- Emission Level = Read Level + Antenna Factor + Cable Loss - Preamp Factor
Margin value = Emission level – Limit value
- 2437 MHz: Fundamental frequency.

EUT Test Condition		Measurement Detail	
Channel	Channel 11	Frequency Range	1 GHz ~ 25 GHz
Input Power	120 Vac, 60 Hz	Detector Function	Peak (PK) Average (AV)
Environmental Conditions	25 deg. C, 65 % RH	Tested By	Getaz Yang

Antennal Polarity & Test Distance: Horizontal at 3 m										
Frequency (MHz)	Emission Level (dBuV/m)	Read Level (dBuV)	Limit (dBuV/m)	Margin (dB)	Antenna Factor (dB/m)	Cable Loss (dB)	Preamp Factor (dB)	Antenna Height (cm)	Table Angle (Degree)	Remark
2462	103.45	108.97			27.46	4.41	37.39	164	159	Average
2462	113.46	118.98			27.46	4.41	37.39	164	159	Peak
2483.56	52.06	57.42	54	-1.94	27.53	4.43	37.32	164	159	Average
2483.56	69.61	74.97	74	-4.39	27.53	4.43	37.32	164	159	Peak
4924	35.69	50.57	54	-18.31	31.12	6.89	52.89	169	2	Average
4924	46.92	61.8	74	-27.08	31.12	6.89	52.89	169	2	Peak
Antennal Polarity & Test Distance: Vertical at 3 m										
Frequency (MHz)	Emission Level (dBuV/m)	Read Level (dBuV)	Limit (dBuV/m)	Margin (dB)	Antenna Factor (dB/m)	Cable Loss (dB)	Preamp Factor (dB)	Antenna Height (cm)	Table Angle (Degree)	Remark
2462	99.56	105.08			27.46	4.41	37.39	127	99	Average
2462	109.06	114.58			27.46	4.41	37.39	127	99	Peak
2483.56	51.42	57.16	54	-2.58	27.15	4.43	37.32	127	99	Average
2483.56	67.45	73.19	74	-6.55	27.15	4.43	37.32	127	99	Peak
4924	36.61	51.49	54	-17.39	31.12	6.89	52.89	128	141	Average
4924	43.34	58.22	74	-30.66	31.12	6.89	52.89	128	141	Peak

Remarks:

- Emission Level = Read Level + Antenna Factor + Cable Loss - Preamp Factor
Margin value = Emission level – Limit value
- 2462 MHz: Fundamental frequency.

802.11n (HT40)

EUT Test Condition		Measurement Detail	
Channel	Channel 3	Frequency Range	1 GHz ~ 25 GHz
Input Power	120 Vac, 60 Hz	Detector Function	Peak (PK) Average (AV)
Environmental Conditions	25 deg. C, 65 % RH	Tested By	Getaz Yang

Antennal Polarity & Test Distance: Horizontal at 3 m

Frequency (MHz)	Emission Level (dBuV/m)	Read Level (dBuV)	Limit (dBuV/m)	Margin (dB)	Antenna Factor (dB/m)	Cable Loss (dB)	Preamp Factor (dB)	Antenna Height (cm)	Table Angle (Degree)	Remark
2389.94	51.5	57.5	54	-2.5	27.16	4.36	37.52	189	165	Average
2389.94	71.06	77.06	74	-2.94	27.16	4.36	37.52	189	165	Peak
2422	98.09	103.85			27.31	4.39	37.46	189	165	Average
2422	108.1	113.86			27.31	4.39	37.46	189	165	Peak
2483.56	39.52	44.88	54	-14.48	27.53	4.43	37.32	189	165	Average
2483.56	61.36	66.72	74	-12.64	27.53	4.43	37.32	189	165	Peak
4822	34.9	49.99	54	-19.1	30.99	6.81	52.89	104	98	Average
4822	41.59	56.68	74	-32.41	30.99	6.81	52.89	104	98	Peak

Antennal Polarity & Test Distance: Vertical at 3 m

Frequency (MHz)	Emission Level (dBuV/m)	Read Level (dBuV)	Limit (dBuV/m)	Margin (dB)	Antenna Factor (dB/m)	Cable Loss (dB)	Preamp Factor (dB)	Antenna Height (cm)	Table Angle (Degree)	Remark
2389.24	50.93	57.16	54	-3.07	26.91	4.36	37.5	129	92	Average
2389.24	68.56	74.85	74	-5.44	26.86	4.35	37.5	129	92	Peak
2422	96.59	102.35			27.31	4.39	37.46	129	92	Average
2422	106.23	111.99			27.31	4.39	37.46	129	92	Peak
2484.88	42.78	48.39	54	-11.22	27.2	4.44	37.25	129	92	Average
2484.88	63.62	69.36	74	-10.38	27.15	4.43	37.32	129	92	Peak
4844	35.3	50.34	54	-18.7	31.01	6.83	52.88	133	138	Average
4844	44.25	59.29	74	-29.75	31.01	6.83	52.88	133	138	Peak

Remarks:

- Emission Level = Read Level + Antenna Factor + Cable Loss - Preamp Factor
Margin value = Emission level – Limit value
- 2422 MHz: Fundamental frequency.

EUT Test Condition		Measurement Detail	
Channel	Channel 6	Frequency Range	1 GHz ~ 25 GHz
Input Power	120 Vac, 60 Hz	Detector Function	Peak (PK) Average (AV)
Environmental Conditions	25 deg. C, 65 % RH	Tested By	Getaz Yang

Antennal Polarity & Test Distance: Horizontal at 3 m										
Frequency (MHz)	Emission Level (dBuV/m)	Read Level (dBuV)	Limit (dBuV/m)	Margin (dB)	Antenna Factor (dB/m)	Cable Loss (dB)	Preamp Factor (dB)	Antenna Height (cm)	Table Angle (Degree)	Remark
2389.94	50.62	56.62	54	-3.38	27.16	4.36	37.52	200	20	Average
2389.94	70.26	76.26	74	-3.74	27.16	4.36	37.52	200	20	Peak
2437	100.01	105.69			27.38	4.4	37.46	200	20	Average
2437	108.2	113.88			27.38	4.4	37.46	200	20	Peak
2483.52	52.68	58.04	54	-1.32	27.53	4.43	37.32	200	20	Average
2483.52	70.69	76.05	74	-3.31	27.53	4.43	37.32	200	20	Peak
4874	35.45	50.2	54	-18.55	31.25	6.86	52.86	102	236	Average
4874	45.55	60.3	74	-28.45	31.25	6.86	52.86	102	236	Peak

Antennal Polarity & Test Distance: Vertical at 3 m										
Frequency (MHz)	Emission Level (dBuV/m)	Read Level (dBuV)	Limit (dBuV/m)	Margin (dB)	Antenna Factor (dB/m)	Cable Loss (dB)	Preamp Factor (dB)	Antenna Height (cm)	Table Angle (Degree)	Remark
2389.94	47.94	53.94	54	-6.06	27.16	4.36	37.52	104	22	Average
2389.94	66.85	72.85	74	-7.15	27.16	4.36	37.52	104	22	Peak
2437	99.03	104.71			27.38	4.4	37.46	104	22	Average
2437	107.6	113.28			27.38	4.4	37.46	104	22	Peak
2483.52	49.74	55.1	54	-4.26	27.53	4.43	37.32	104	22	Average
2483.52	67.28	72.64	74	-6.72	27.53	4.43	37.32	104	22	Peak
4874	35.96	51.09	54	-18.04	31.06	6.86	53.05	102	251	Average
4874	45.96	61.09	74	-28.04	31.06	6.86	53.05	102	251	Peak

Remarks:

- Emission Level = Read Level + Antenna Factor + Cable Loss - Preamp Factor
Margin value = Emission level – Limit value
- 2437 MHz: Fundamental frequency.

EUT Test Condition		Measurement Detail	
Channel	Channel 9	Frequency Range	1 GHz ~ 25 GHz
Input Power	120 Vac, 60 Hz	Detector Function	Peak (PK) Average (AV)
Environmental Conditions	25 deg. C, 65 % RH	Tested By	Getaz Yang

Antennal Polarity & Test Distance: Horizontal at 3 m										
Frequency (MHz)	Emission Level (dBuV/m)	Read Level (dBuV)	Limit (dBuV/m)	Margin (dB)	Antenna Factor (dB/m)	Cable Loss (dB)	Preamp Factor (dB)	Antenna Height (cm)	Table Angle (Degree)	Remark
2389.66	38.84	44.82	54	-15.16	27.16	4.36	37.5	164	162	Average
2389.66	63.36	69.34	74	-10.64	27.16	4.36	37.5	164	162	Peak
2452	98.19	103.79			27.38	4.41	37.39	164	162	Average
2452	108.22	113.82			27.38	4.41	37.39	164	162	Peak
2483.8	52.97	58.33	54	-1.03	27.53	4.43	37.32	164	162	Average
2483.8	72.18	77.54	74	-1.82	27.53	4.43	37.32	164	162	Peak
4904	34.9	49.77	54	-19.1	31.1	6.88	52.85	112	94	Average
4904	42.25	57.12	74	-31.75	31.1	6.88	52.85	112	94	Peak
Antennal Polarity & Test Distance: Vertical at 3 m										
Frequency (MHz)	Emission Level (dBuV/m)	Read Level (dBuV)	Limit (dBuV/m)	Margin (dB)	Antenna Factor (dB/m)	Cable Loss (dB)	Preamp Factor (dB)	Antenna Height (cm)	Table Angle (Degree)	Remark
2389.52	40.74	46.97	54	-13.26	26.91	4.36	37.5	129	92	Average
2389.52	62.7	68.93	74	-11.3	26.91	4.36	37.5	129	92	Peak
2452	97.43	103.03			27.38	4.41	37.39	129	92	Average
2452	106.49	112.09			27.38	4.41	37.39	129	92	Peak
2483.88	52.34	58.08	54	-1.66	27.15	4.43	37.32	129	92	Average
2483.88	67.69	73.43	74	-6.31	27.15	4.43	37.32	129	92	Peak
4904	35.24	50.11	54	-18.76	31.1	6.88	52.85	115	119	Average
4904	43.15	58.02	74	-30.85	31.1	6.88	52.85	115	119	Peak

Remarks:

- Emission Level = Read Level + Antenna Factor + Cable Loss - Preamp Factor
Margin value = Emission level – Limit value
- 2452 MHz: Fundamental frequency.

9 kHz ~ 30 MHz Data:

The amplitude of spurious emissions attenuated more than 20 dB below the permissible value is not required to be report.

30 MHz ~ 1 GHz Worst-Case Data:

802.11g

EUT Test Condition		Measurement Detail	
Channel	Channel 11	Frequency Range	30 MHz ~ 1 GHz
Input Power	120 Vac, 60 Hz	Detector Function	Peak (PK) Quasi-peak (QP)
Environmental Conditions	25 deg. C, 65 % RH	Tested By	Getaz Yang

Antennal Polarity & Test Distance: Horizontal at 3 m										
Frequency (MHz)	Emission Level (dBuV/m)	Read Level (dBuV)	Limit (dBuV/m)	Margin (dB)	Antenna Factor (dB/m)	Cable Loss (dB)	Preamp Factor (dB)	Antenna Height (cm)	Table Angle (Degree)	Remark
120.21	22.43	42.47	43.5	-21.07	11.02	0.84	31.9	112	223	Peak
216.24	18.55	38.85	46	-27.45	10.05	1.31	31.66	130	30	Peak
322.94	23.95	40.56	46	-22.05	13.5	1.76	31.87	103	138	Peak
544.1	24.43	35.25	46	-21.57	18.33	2.67	31.82	129	135	Peak
629.46	27.68	36.84	46	-18.32	19.96	3.02	32.14	119	94	Peak
900.09	36.11	40.58	46	-9.89	23.51	4.03	32.01	150	50	Peak

Antennal Polarity & Test Distance: Vertical at 3 m										
Frequency (MHz)	Emission Level (dBuV/m)	Read Level (dBuV)	Limit (dBuV/m)	Margin (dB)	Antenna Factor (dB/m)	Cable Loss (dB)	Preamp Factor (dB)	Antenna Height (cm)	Table Angle (Degree)	Remark
41.64	28.5	45.49	40	-11.5	13.56	0.5	31.05	114	289	Peak
147.37	19.73	37.77	43.5	-23.77	12.61	0.97	31.62	126	349	Peak
216.24	18.35	38.65	46	-27.65	10.05	1.31	31.66	147	110	Peak
359.8	18.75	34.42	46	-27.25	14.38	1.92	31.97	103	69	Peak
544.1	29.55	40.37	46	-16.45	18.33	2.67	31.82	111	121	Peak
900.09	28.36	32.83	46	-17.64	23.51	4.03	32.01	139	49	Peak

Remarks:

1. Emission Level = Read Level + Antenna Factor + Cable Loss - Preamp Factor

Margin value = Emission level – Limit value

4.2 Conducted Emission Measurement

4.2.1 Limits of Conducted Emission Measurement

Frequency (MHz)	Conducted Limit (dBuV)	
	Quasi-peak	Average
0.15 - 0.5	66 - 56	56 - 46
0.50 - 5.0	56	46
5.0 - 30.0	60	50

- Note: 1. The lower limit shall apply at the transition frequencies.
 2. The limit decreases in line with the logarithm of the frequency in the range of 0.15 to 0.50 MHz.

4.2.2 Test Instruments

Description & Manufacturer	Model No.	Serial No.	Date of Calibration	Due Date of Calibration
Test Receiver ROHDE & SCHWARZ	ESCI	100613	Nov. 23, 2017	Nov. 22, 2018
RF signal cable (with 10dB PAD) Woken	5D-FB	Cable-cond1-01	Sep. 05, 2017	Sep. 04, 2018
LISN/AMN ROHDE & SCHWARZ (EUT)	ESH3-Z5	835239/001	Mar. 10, 2017	Mar. 09, 2018
LISN/AMN ROHDE & SCHWARZ (Peripheral)	ESH3-Z5	100311	Aug. 15, 2017	Aug. 14, 2018
Software ADT	BV ADT_Cond_ V7.3.7.3	NA	NA	NA

- Note: 1. The calibration interval of the above test instruments is 12 months and the calibrations are traceable to NML/ROC and NIST/USA.
 2. The test was performed in HwaYa Shielded Room 1.
 3. The VCCI Site Registration No. is C-2040.

4.2.3 Test Procedures

- a. The EUT was placed 0.4 meters from the conducting wall of the shielded room with EUT being connected to the power mains through a line impedance stabilization network (LISN). Other support units were connected to the power mains through another LISN. The two LISNs provide 50 ohm/50 uH of coupling impedance for the measuring instrument.
- b. Both lines of the power mains connected to the EUT were checked for maximum conducted interference.
- c. The frequency range from 150 kHz to 30 MHz was searched. Emission levels under (Limit – 20 dB) was not recorded.

NOTE: All modes of operation were investigated and the worst-case emissions are reported.

4.2.4 Deviation from Test Standard

No deviation.

4.2.5 Test Setup

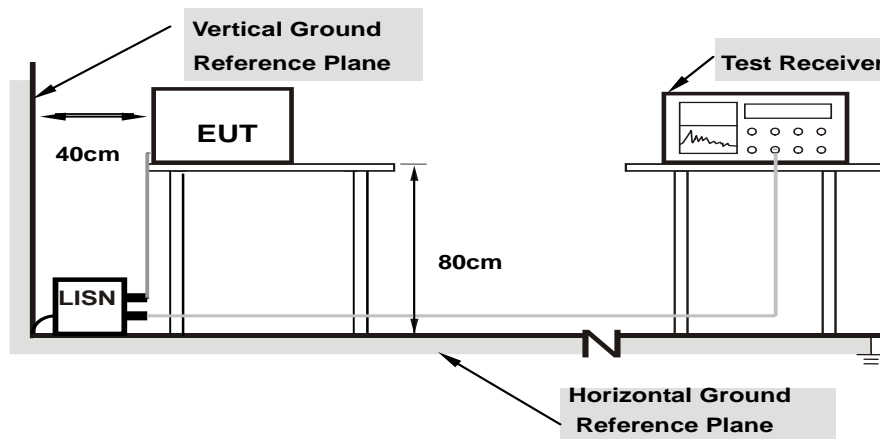

Note: 1.Support units were connected to second LISN.

For the actual test configuration, please refer to the attached file (Test Setup Photo).

4.2.6 EUT Operating Conditions

- a. Placed the EUT on a testing table.
- b. Use the software to control the EUT under transmission condition continuously at specific channel frequency.

4.2.7 Test Results

Frequency Range	150kHz ~ 30MHz	Detector Function & Resolution Bandwidth	Quasi-Peak (QP) / Average (AV), 9kHz
Input Power	120Vac, 60Hz	Environmental Conditions	25°C, 65%RH
Tested by	Getaz Yang	Test Date	2018/2/27

Phase Of Power : Line (L)										
No	Frequency (MHz)	Correction Factor (dB)	Reading Value (dBuV)		Emission Level (dBuV)		Limit (dBuV)		Margin (dB)	
			Q.P.	AV.	Q.P.	AV.	Q.P.	AV.	Q.P.	AV.
1	0.15782	10.10	45.15	27.57	55.25	37.67	65.58	55.58	-10.33	-17.91
2	0.16955	10.10	44.54	27.38	54.64	37.48	64.98	54.98	-10.34	-17.50
3	0.21256	10.10	42.01	24.85	52.11	34.95	63.10	53.10	-10.99	-18.15
4	0.29858	10.11	34.38	18.37	44.49	28.48	60.28	50.28	-15.79	-21.80
5	0.50581	10.12	29.27	19.66	39.39	29.78	56.00	46.00	-16.61	-16.22
6	7.55945	10.48	15.03	1.64	25.51	12.12	60.00	50.00	-34.49	-37.88

Remarks:

1. Q.P. and AV. are abbreviations of quasi-peak and average individually.
2. The emission levels of other frequencies were very low against the limit.
3. Margin value = Emission level – Limit value
4. Correction factor = Insertion loss + Cable loss
5. Emission Level = Correction Factor + Reading Value

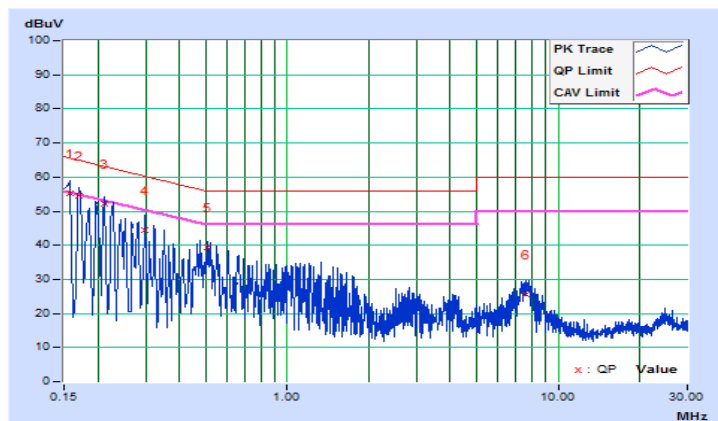

Frequency Range	150kHz ~ 30MHz	Detector Function & Resolution Bandwidth	Quasi-Peak (QP) / Average (AV), 9kHz
Input Power	120Vac, 60Hz	Environmental Conditions	25°C, 65%RH
Tested by	Getaz Yang	Test Date	2018/2/27

Phase Of Power : Neutral (N)										
No	Frequency (MHz)	Correction Factor (dB)	Reading Value (dBuV)		Emission Level (dBuV)		Limit (dBuV)		Margin (dB)	
			Q.P.	AV.	Q.P.	AV.	Q.P.	AV.	Q.P.	AV.
1	0.15000	10.10	46.32	29.13	56.42	39.23	66.00	56.00	-9.58	-16.77
2	0.18910	10.10	41.63	24.50	51.73	34.60	64.08	54.08	-12.35	-19.48
3	0.25557	10.11	35.95	20.00	46.06	30.11	61.57	51.57	-15.51	-21.46
4	0.50581	10.12	30.95	17.45	41.07	27.57	56.00	46.00	-14.93	-18.43
5	1.33864	10.15	21.36	10.88	31.51	21.03	56.00	46.00	-24.49	-24.97
6	7.15281	10.40	12.27	3.29	22.67	13.69	60.00	50.00	-37.33	-36.31

Remarks:

1. Q.P. and AV. are abbreviations of quasi-peak and average individually.
2. The emission levels of other frequencies were very low against the limit.
3. Margin value = Emission level – Limit value
4. Correction factor = Insertion loss + Cable loss
5. Emission Level = Correction Factor + Reading Value

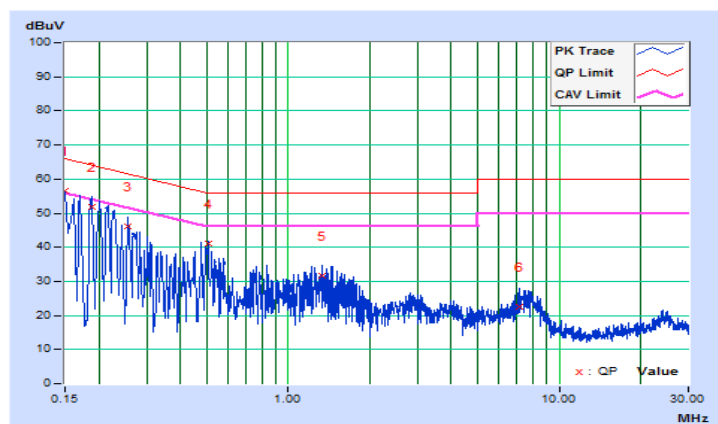

4.3 6 dB Bandwidth Measurement

4.3.1 Limits of 6 dB Bandwidth Measurement

The minimum of 6 dB Bandwidth Measurement is 0.5 MHz.

4.3.2 Test Setup

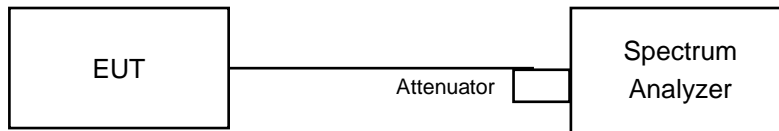

4.3.3 Test Instruments

Refer to section 4.1.2 to get information of above instrument.

4.3.4 Test Procedure

- a. Set resolution bandwidth (RBW) = 100 kHz
- b. Set the video bandwidth (VBW) $\geq 3 \times$ RBW, Detector = Peak.
- c. Trace mode = max hold.
- d. Sweep = auto couple.
- e. Measure the maximum width of the emission that is constrained by the frequencies associated with the two amplitude points (upper and lower) that are attenuated by 6 dB relative to the maximum level measured in the fundamental emission

4.3.5 Deviation from Test Standard

No deviation.

4.3.6 EUT Operating Conditions

The software provided by client to enable the EUT under transmission condition continuously at lowest, middle and highest channel frequencies individually.

4.3.7 Test Result

802.11b

Channel	Frequency (MHz)	6 dB Bandwidth (MHz)		Minimum Limit (MHz)	Pass / Fail
		Chain 0	Chain 1		
1	2412	8.09	8.09	0.5	Pass
6	2437	7.59	8.09	0.5	Pass
11	2462	8.09	8.09	0.5	Pass

802.11g

Channel	Frequency (MHz)	6 dB Bandwidth (MHz)		Minimum Limit (MHz)	Pass / Fail
		Chain 0	Chain 1		
1	2412	15.14	15.14	0.5	Pass
6	2437	15.19	15.20	0.5	Pass
11	2462	15.16	15.19	0.5	Pass

802.11n (HT20)

Channel	Frequency (MHz)	6 dB Bandwidth (MHz)		Minimum Limit (MHz)	Pass / Fail
		Chain 0	Chain 1		
1	2412	15.15	15.15	0.5	Pass
6	2437	15.19	15.75	0.5	Pass
11	2462	15.19	15.77	0.5	Pass

802.11n (HT40)

Channel	Frequency (MHz)	6 dB Bandwidth (MHz)		Minimum Limit (MHz)	Pass / Fail
		Chain 0	Chain 1		
3	2422	35.16	35.16	0.5	Pass
6	2437	35.15	35.15	0.5	Pass
9	2452	35.23	35.22	0.5	Pass

Spectrum Plot of Worst Value

802.11b

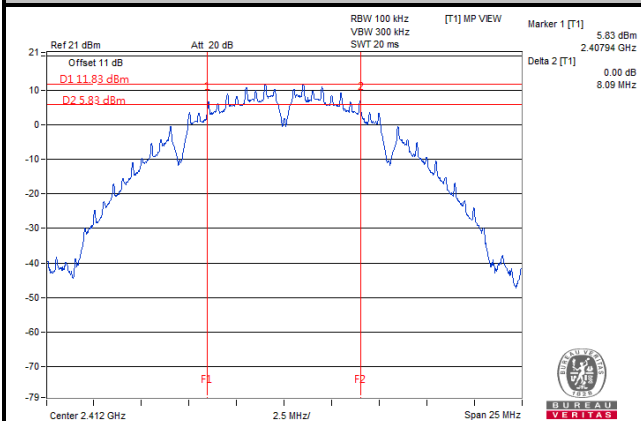

802.11g

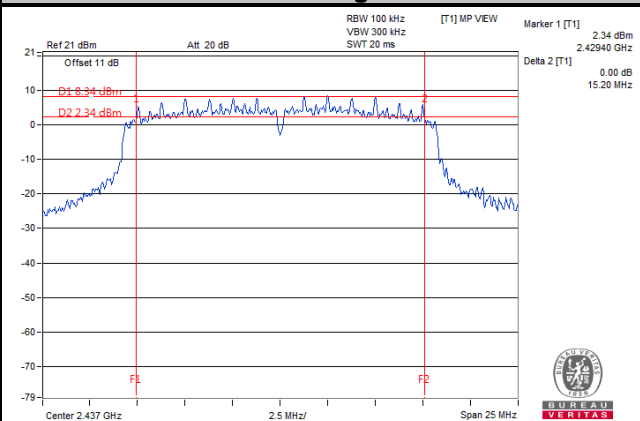

802.11n (HT20)

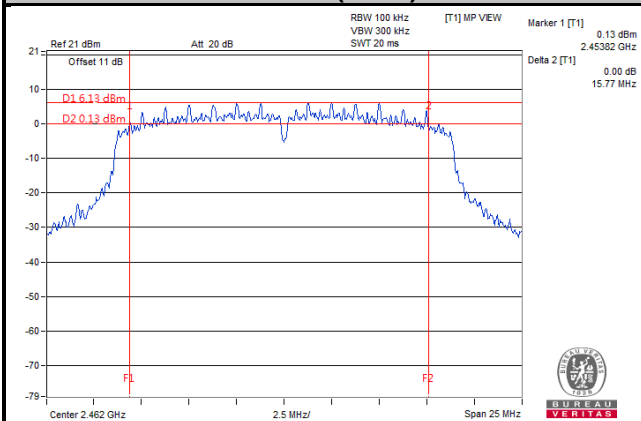

802.11n (HT40)

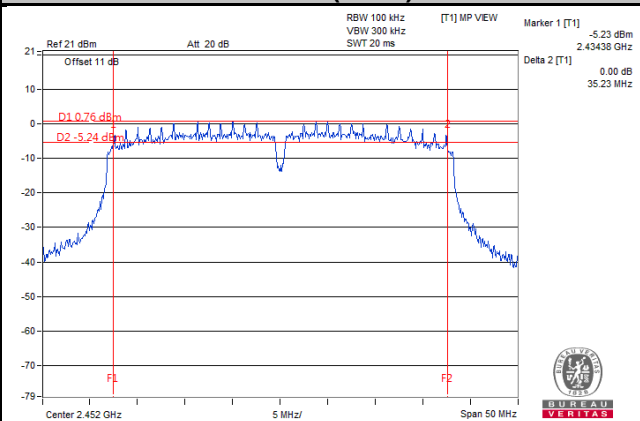

4.4 Occupied Bandwidth Measurement

4.4.1 Test Setup

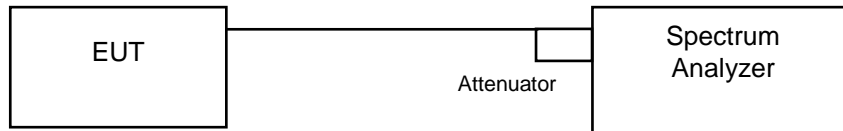

4.4.2 Test Instruments

Refer to section 4.1.2 to get information of above instrument.

4.4.3 Test Procedure

The transmitter output was connected to the spectrum analyzer through an attenuator. The bandwidth of the fundamental frequency was measured by spectrum analyzer with resolution bandwidth in the range of 1 % to 5 % of the anticipated emission bandwidth, and a video bandwidth at least 3x the resolution bandwidth and set the detector to PEAK. The width of a frequency band such that, below the lower and above the upper frequency limits, the mean powers emitted are each equal to a specified percentage 0.5 % of the total mean power of a given emission.

4.4.4 Deviation from Test Standard

No deviation.

4.4.5 EUT Operating Conditions

The software provided by client to enable the EUT under transmission condition continuously at lowest, middle and highest channel frequencies individually.

4.4.6 Test Results

802.11b

Channel	Frequency (MHz)	Occupied Bandwidth (MHz)		Pass / Fail
		Chain 0	Chain 1	
1	2412	12.96	13.17	Pass
6	2437	12.99	13.20	Pass
11	2462	13.05	13.17	Pass

802.11g

Channel	Frequency (MHz)	Occupied Bandwidth (MHz)		Pass / Fail
		Chain 0	Chain 1	
1	2412	16.26	16.32	Pass
6	2437	16.35	16.30	Pass
11	2462	16.30	16.35	Pass

802.11n (HT20)

Channel	Frequency (MHz)	Occupied Bandwidth (MHz)		Pass / Fail
		Chain 0	Chain 1	
1	2412	17.43	17.43	Pass
6	2437	17.45	17.45	Pass
11	2462	17.40	17.45	Pass

802.11n (HT40)

Channel	Frequency (MHz)	Occupied Bandwidth (MHz)		Pass / Fail
		Chain 0	Chain 1	
3	2422	36.00	35.90	Pass
6	2437	36.10	36.00	Pass
9	2452	36.00	36.00	Pass

Spectrum Plot of Worst Value

802.11b

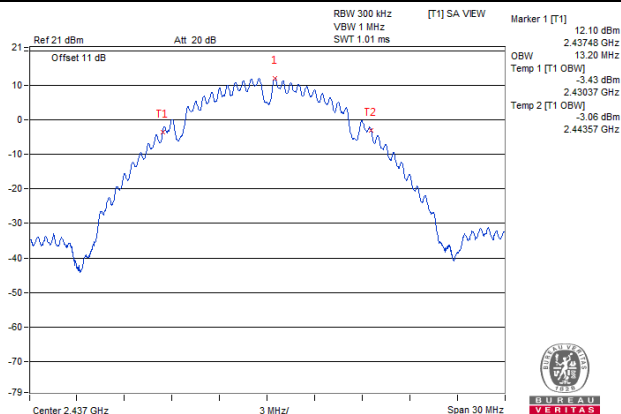

802.11g

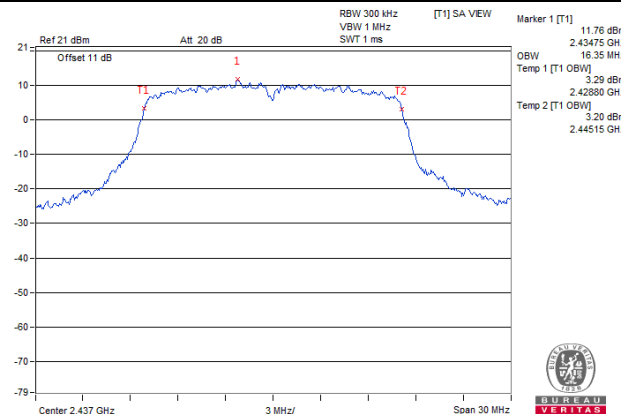

802.11n (HT20)

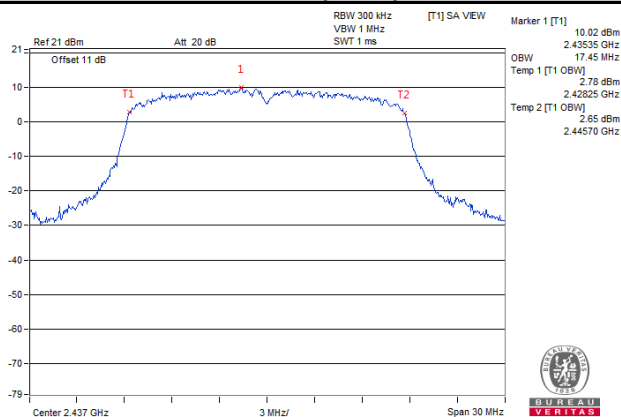

802.11n (HT40)

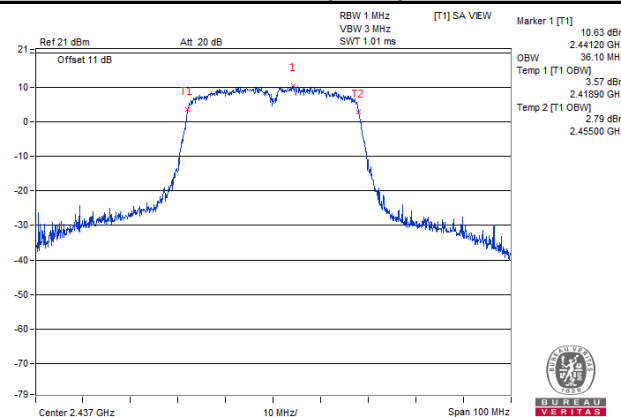

4.5 Conducted Output Power Measurement

4.5.1 Limits of Conducted Output Power Measurement

For systems using digital modulation in the 2400–2483.5 MHz bands: 1 Watt (30 dBm)

Per KDB 662911 D01 Multiple Transmitter Output Method of conducted output power measurement on IEEE 802.11 devices,

Array Gain = 0 dB (i.e., no array gain) for NANT \leq 4;

Array Gain = 0 dB (i.e., no array gain) for channel widths \geq 40 MHz for any NANT;

Array Gain = $5 \log(\text{NANT}/\text{NSS})$ dB or 3 dB, whichever is less for 20 MHz channel widths with NANT \geq 5.

For power measurements on all other devices: Array Gain = $10 \log(\text{NANT}/\text{NSS})$ dB.

4.5.2 Test Setup

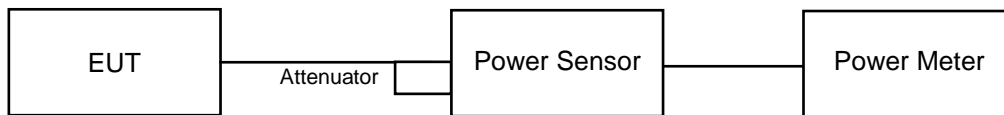

4.5.3 Test Instruments

Refer to section 4.1.2 to get information of above instrument.

4.5.4 Test Procedures

A peak power sensor was used on the output port of the EUT. A power meter was used to read the response of the peak power sensor. Record the power level.

4.5.5 Deviation from Test Standard

No deviation.

4.5.6 EUT Operating Conditions

The software provided by client to enable the EUT under transmission condition continuously at lowest, middle and highest channel frequencies individually.

4.5.7 Test Results

<Peak Power>

802.11b

Channel	Frequency (MHz)	Peak Power (dBm)		Total Power (mW)	Total Power (dBm)	Limit (dBm)	Pass / Fail
		Chain 0	Chain 1				
1	2412	21.32	21.22	267.953	24.28	30	Pass
6	2437	21.54	21.26	276.221	24.41	30	Pass
11	2462	21.37	21.13	266.806	24.26	30	Pass

802.11g

Channel	Frequency (MHz)	Peak Power (dBm)		Total Power (mW)	Total Power (dBm)	Limit (dBm)	Pass / Fail
		Chain 0	Chain 1				
1	2412	23.03	22.71	387.547	25.88	30	Pass
6	2437	23.51	23.39	442.661	26.46	30	Pass
11	2462	22.83	22.63	375.098	25.74	30	Pass

802.11n (HT20)

Channel	Frequency (MHz)	Peak Power (dBm)		Total Power (mW)	Total Power (dBm)	Limit (dBm)	Pass / Fail
		Chain 0	Chain 1				
1	2412	23.06	23.02	402.749	26.05	30	Pass
6	2437	25.23	24.86	639.623	28.06	30	Pass
11	2462	22.47	22.23	343.713	25.36	30	Pass

802.11n (HT40)

Channel	Frequency (MHz)	Peak Power (dBm)		Total Power (mW)	Total Power (dBm)	Limit (dBm)	Pass / Fail
		Chain 0	Chain 1				
3	2422	20.63	20.33	223.506	23.49	30	Pass
6	2437	22.21	22.03	325.929	25.13	30	Pass
9	2452	20.66	20.38	225.557	23.53	30	Pass

<Average Power>

802.11b

Channel	Frequency (MHz)	Average Power (dBm)		Total Power (mW)	Total Power (dBm)	Limit (dBm)	Pass / Fail
		Chain 0	Chain 1				
1	2412	18.76	18.71	149.464	21.75	30	Pass
6	2437	18.79	18.74	150.500	21.78	30	Pass
11	2462	18.74	18.68	148.607	21.72	30	Pass

802.11g

Channel	Frequency (MHz)	Average Power (dBm)		Total Power (mW)	Total Power (dBm)	Limit (dBm)	Pass / Fail
		Chain 0	Chain 1				
1	2412	17.04	16.88	99.335	19.97	30	Pass
6	2437	17.95	17.88	123.749	20.93	30	Pass
11	2462	16.89	16.83	97.060	19.87	30	Pass

802.11n (HT20)

Channel	Frequency (MHz)	Average Power (dBm)		Total Power (mW)	Total Power (dBm)	Limit (dBm)	Pass / Fail
		Chain 0	Chain 1				
1	2412	17.03	16.91	99.557	19.98	30	Pass
6	2437	19.15	19.12	163.882	22.15	30	Pass
11	2462	15.87	15.81	76.744	18.85	30	Pass

802.11n (HT40)

Channel	Frequency (MHz)	Average Power (dBm)		Total Power (mW)	Total Power (dBm)	Limit (dBm)	Pass / Fail
		Chain 0	Chain 1				
3	2422	13.77	13.68	47.158	16.74	30	Pass
6	2437	15.17	15.14	65.544	18.17	30	Pass
9	2452	13.76	13.64	46.889	16.71	30	Pass

4.6 Power Spectral Density Measurement

4.6.1 Limits of Power Spectral Density Measurement

The Maximum of Power Spectral Density Measurement is 8 dBm.

4.6.2 Test Setup

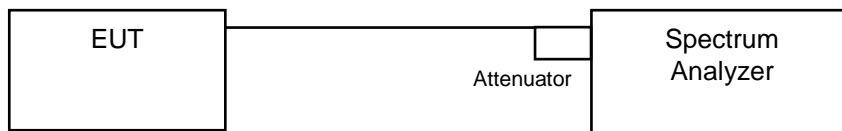

4.6.3 Test Instruments

Refer to section 4.1.2 to get information of above instrument.

4.6.4 Test Procedure

- a. Set analyzer center frequency to DTS channel center frequency.
- b. Set the span to 1.5 times the DTS bandwidth.
- c. Set the RBW to: $3 \text{ kHz} \leq \text{RBW} \leq 100 \text{ kHz}$.
- d. Set the VBW $\geq 3 \times \text{RBW}$.
- e. Detector = peak.
- f. Sweep time = auto couple.
- g. Trace mode = max hold.
- h. Allow trace to fully stabilize.
- i. Use the peak marker function to determine the maximum amplitude level within the RBW.

4.6.5 Deviation from Test Standard

No deviation.

4.6.6 EUT Operating Condition

The software provided by client to enable the EUT under transmission condition continuously at lowest, middle and highest channel frequencies individually.

4.6.7 Test Results

802.11b

TX Chain	Channel	Freq. (MHz)	PSD (dBm/3 kHz)	10 log (N=2) dB	Total PSD (dBm/3 kHz)	Limit (dBm/3 kHz)	Pass / Fail
0	1	2412	-4.79	3.01	-1.78	6.99	Pass
	6	2437	-4.60	3.01	-1.59	6.99	Pass
	11	2462	-5.06	3.01	-2.05	6.99	Pass
1	1	2412	-4.97	3.01	-1.96	6.99	Pass
	6	2437	-4.57	3.01	-1.56	6.99	Pass
	11	2462	-5.18	3.01	-2.17	6.99	Pass

NOTE: Directional gain = 4 dBi + 10log(2) = 7.01 dBi > 6 dBi , so the power density limit shall be reduced to 8-(7.01-6) = 6.99 dBm.

802.11g

TX Chain	Channel	Freq. (MHz)	PSD (dBm/3 kHz)	10 log (N=2) dB	Total PSD (dBm/3 kHz)	Limit (dBm/3 kHz)	Pass / Fail
0	1	2412	-9.23	3.01	-6.22	6.99	Pass
	6	2437	-7.70	3.01	-4.69	6.99	Pass
	11	2462	-9.42	3.01	-6.41	6.99	Pass
1	1	2412	-9.57	3.01	-6.56	6.99	Pass
	6	2437	-7.78	3.01	-4.77	6.99	Pass
	11	2462	-9.82	3.01	-6.81	6.99	Pass

NOTE: Directional gain = 4 dBi + 10log(2) = 7.01 dBi > 6 dBi , so the power density limit shall be reduced to 8-(7.01-6) = 6.99 dBm.

802.11n (HT20)

TX Chain	Channel	Freq. (MHz)	PSD (dBm/3 kHz)	10 log (N=2) dB	Total PSD (dBm/3 kHz)	Limit (dBm/3 kHz)	Pass / Fail
0	1	2412	-8.22	3.01	-5.21	6.99	Pass
	6	2437	-7.99	3.01	-4.98	6.99	Pass
	11	2462	-9.31	3.01	-6.30	6.99	Pass
1	1	2412	-8.63	3.01	-5.62	6.99	Pass
	6	2437	-7.71	3.01	-4.70	6.99	Pass
	11	2462	-9.61	3.01	-6.60	6.99	Pass

NOTE: Directional gain = 4 dBi + 10log(2) = 7.01 dBi > 6 dBi , so the power density limit shall be reduced to 8-(7.01-6) = 6.99 dBm.

802.11n (HT40)

TX Chain	Channel	Freq. (MHz)	PSD (dBm/3 kHz)	10 log (N=2) dB	Total PSD (dBm/3 kHz)	Limit (dBm/3 kHz)	Pass / Fail
0	3	2422	-14.66	3.01	-11.65	6.99	Pass
	6	2437	-13.35	3.01	-10.34	6.99	Pass
	9	2452	-14.88	3.01	-11.87	6.99	Pass
1	3	2422	-15.28	3.01	-12.27	6.99	Pass
	6	2437	-13.36	3.01	-10.35	6.99	Pass
	9	2452	-15.48	3.01	-12.47	6.99	Pass

NOTE: Directional gain = 4 dBi + 10log(2) = 7.01 dBi > 6 dBi , so the power density limit shall be reduced to 8-(7.01-6) = 6.99 dBm.

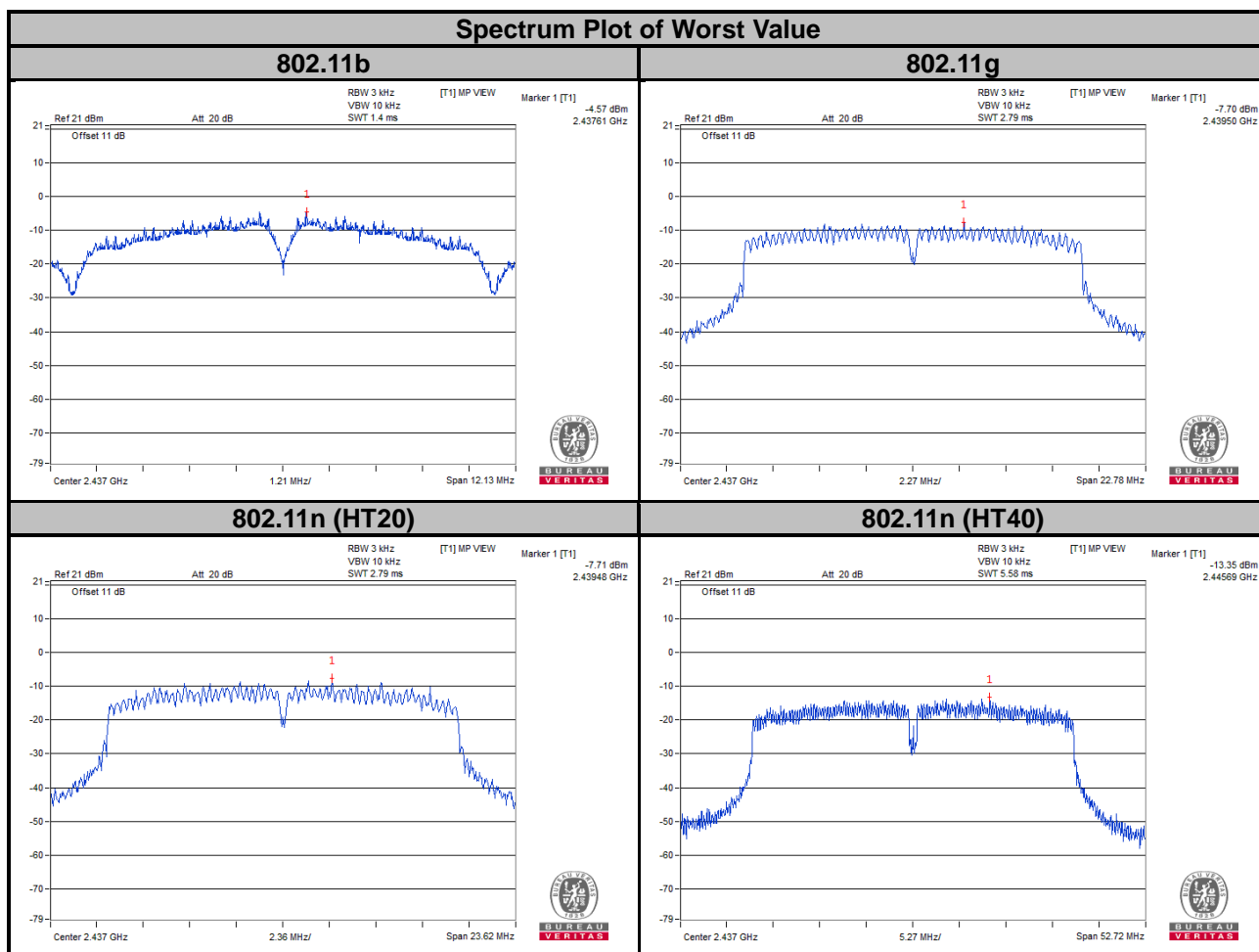

4.7 Conducted Out of Band Emission Measurement

4.7.1 Limits of Conducted Out of Band Emission Measurement

Below 20 dB of the highest emission level of operating band (in 100 kHz Resolution Bandwidth).

4.7.2 Test Setup

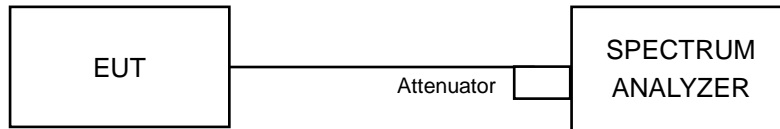

4.7.3 Test Instruments

Refer to section 4.1.2 to get information of above instrument.

4.7.4 Test Procedure

MEASUREMENT PROCEDURE REF

1. Set the RBW = 100 kHz.
2. Set the VBW \geq 300 kHz.
3. Detector = peak.
4. Sweep time = auto couple.
5. Trace mode = max hold.
6. Allow trace to fully stabilize.
7. Use the peak marker function to determine the maximum power level in any 100 kHz band segment within the fundamental EBW.

MEASUREMENT PROCEDURE OOB

1. Set RBW = 100 kHz.
2. Set VBW \geq 300 kHz.
3. Detector = peak.
4. Sweep = auto couple.
5. Trace Mode = max hold.
6. Allow trace to fully stabilize.
7. Use the peak marker function to determine the maximum amplitude level.

4.7.5 Deviation from Test Standard

No deviation.

4.7.6 EUT Operating Condition

The software provided by client to enable the EUT under transmission condition continuously at lowest, middle and highest channel frequencies individually.

4.7.7 Test Results

The spectrum plots are attached on the following images. D1 line indicates the highest level, and D2 line indicates the 20 dB offset below D1. It shows compliance with the requirement.

802.11b CHAIN 0

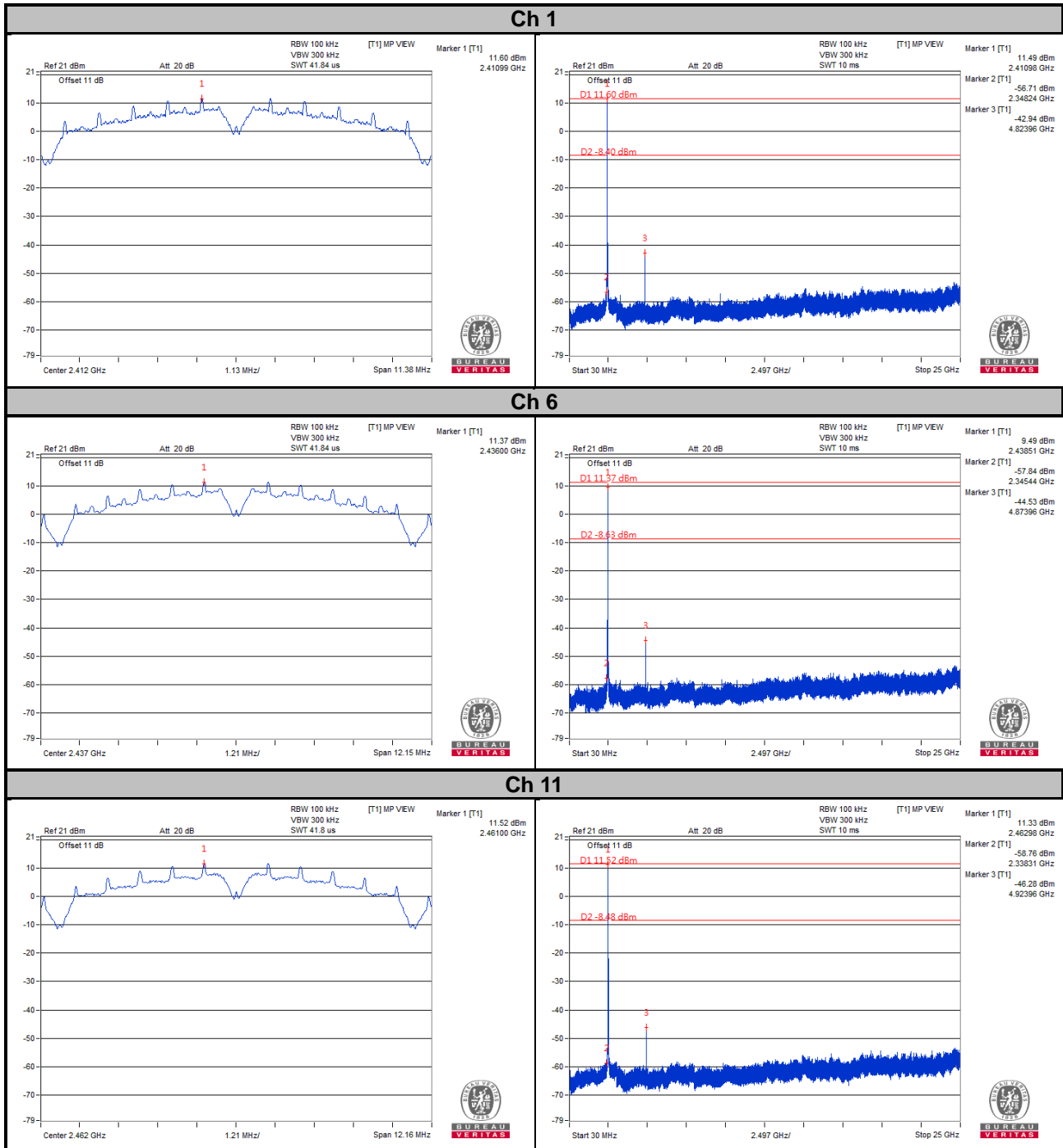

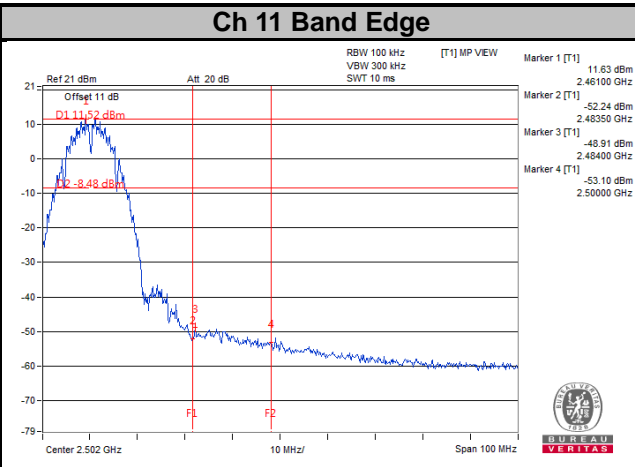
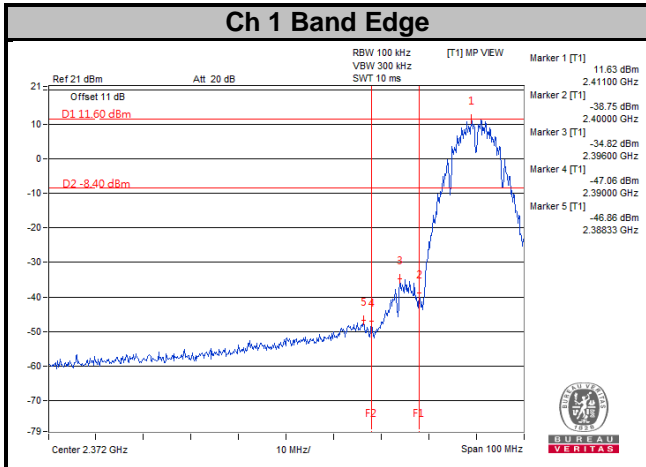

CHAIN 1

Ch 1

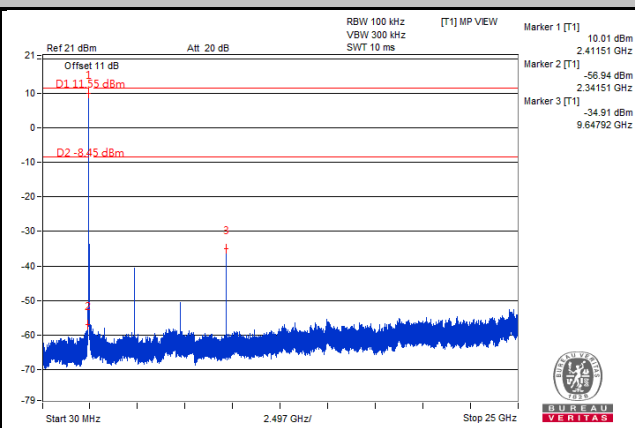
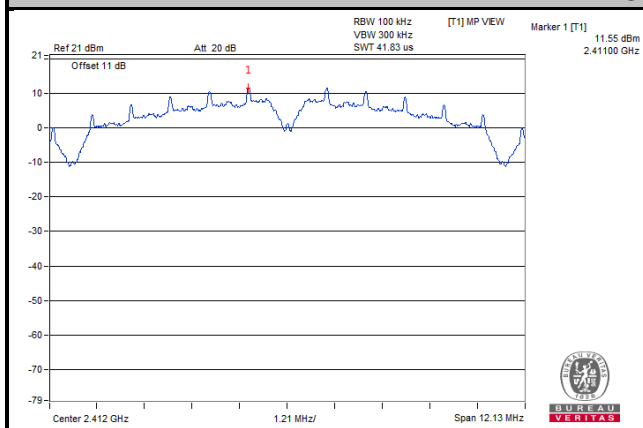

Ch 6

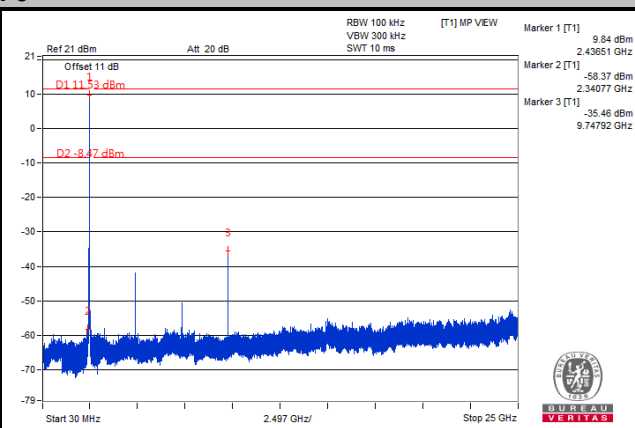
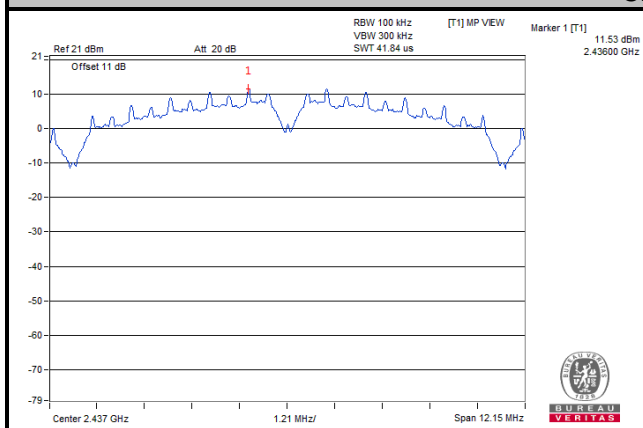

Ch 11

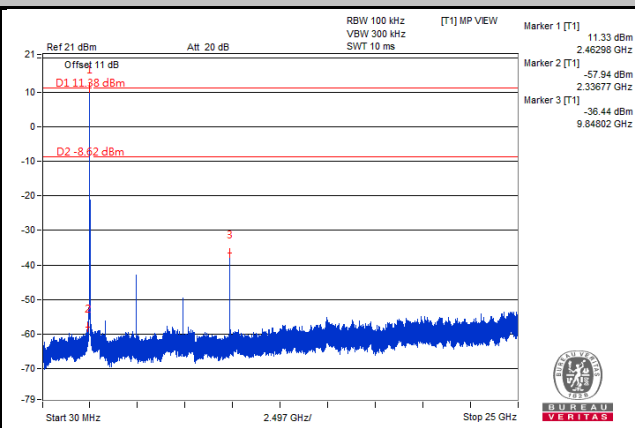
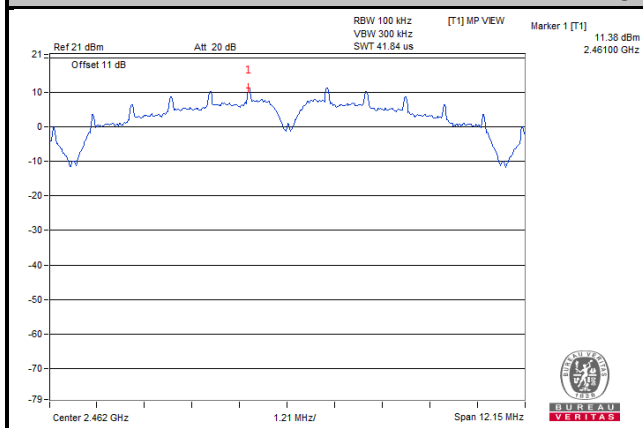

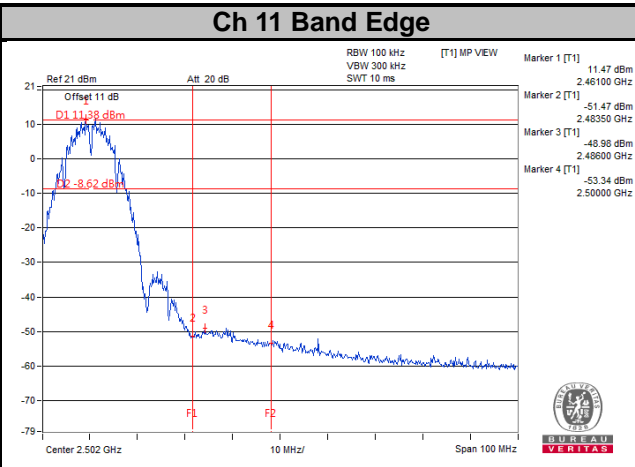
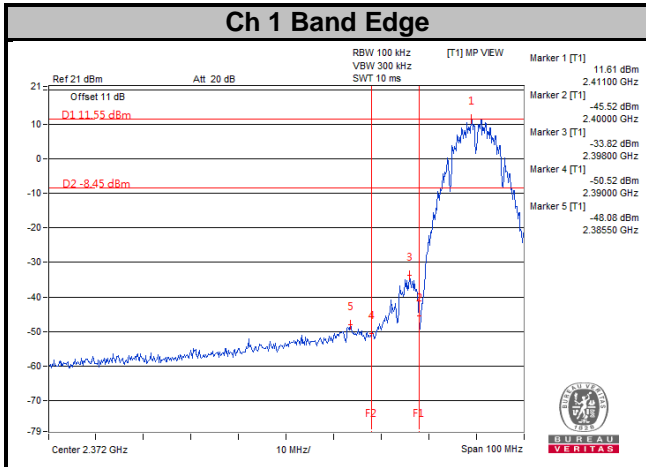

802.11g
CHAIN 0

Ch 1

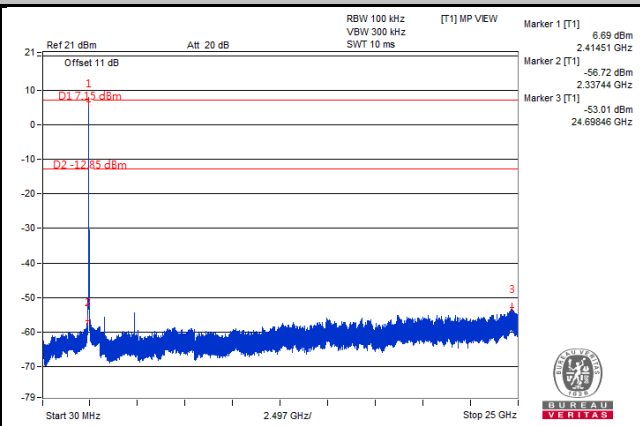
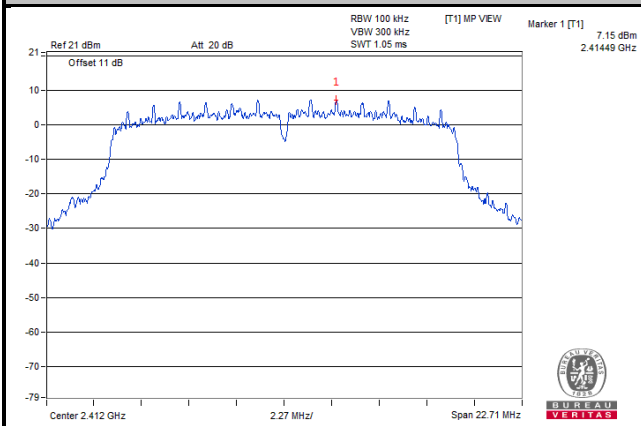

Ch 6

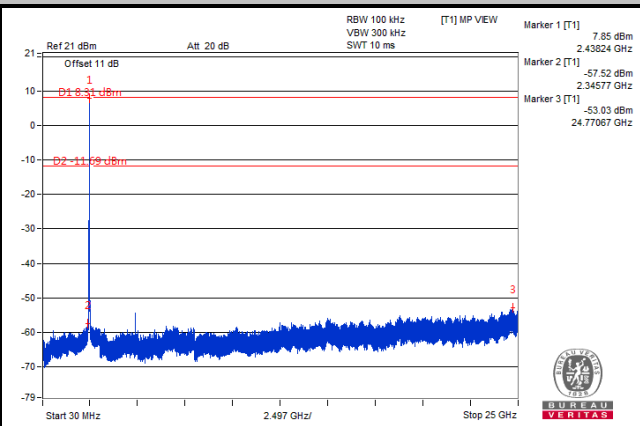
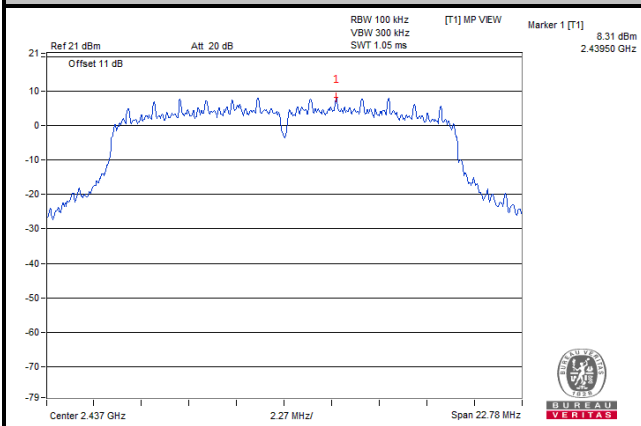

Ch 11

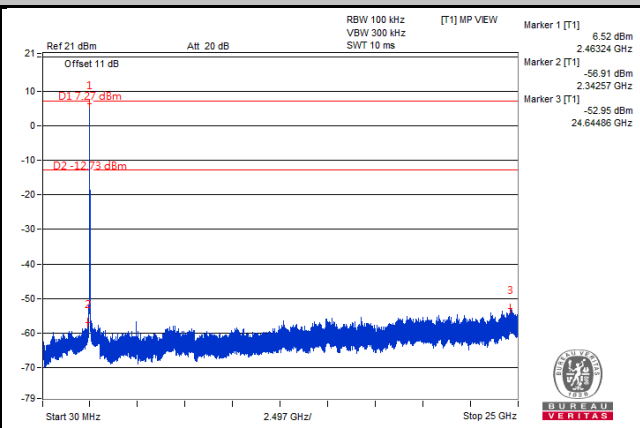
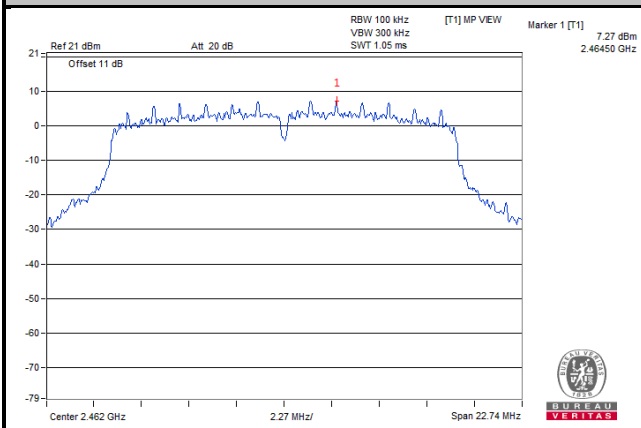

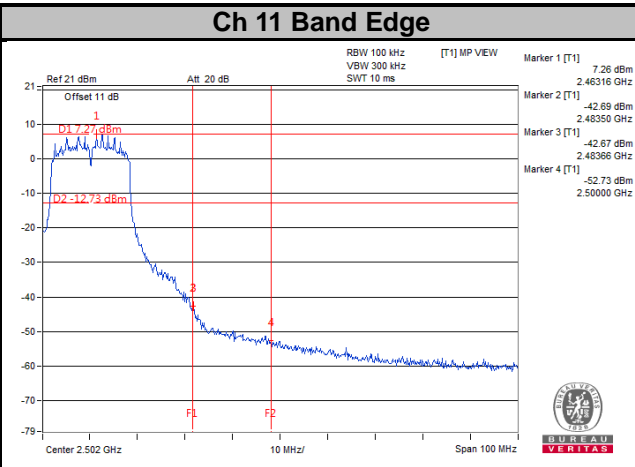
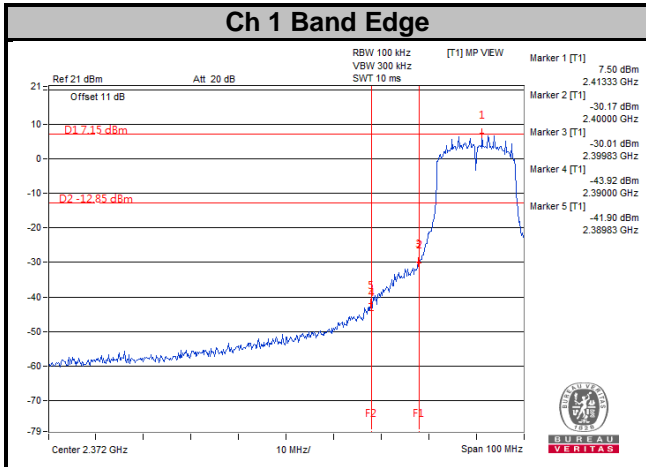

CHAIN 1

Ch 1

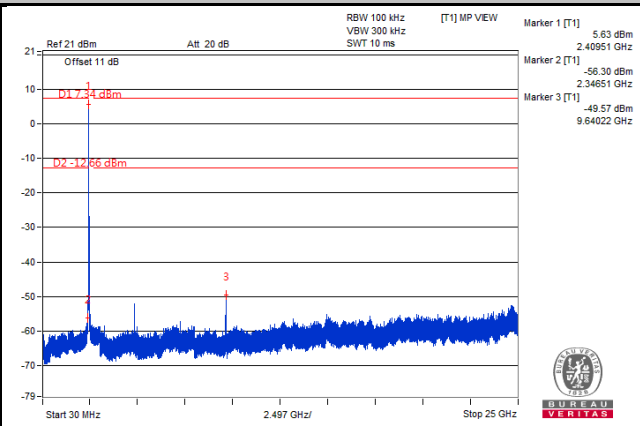
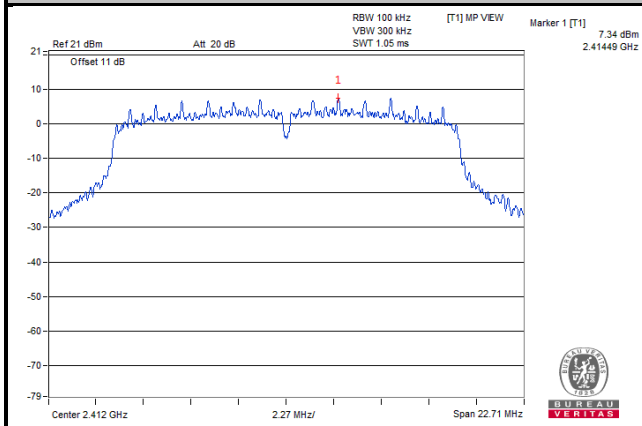

Ch 6

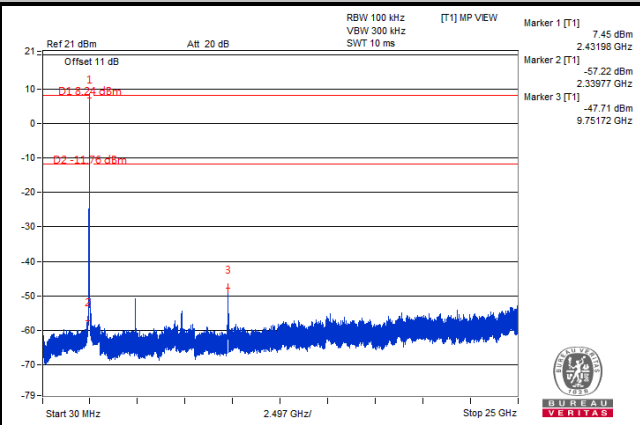
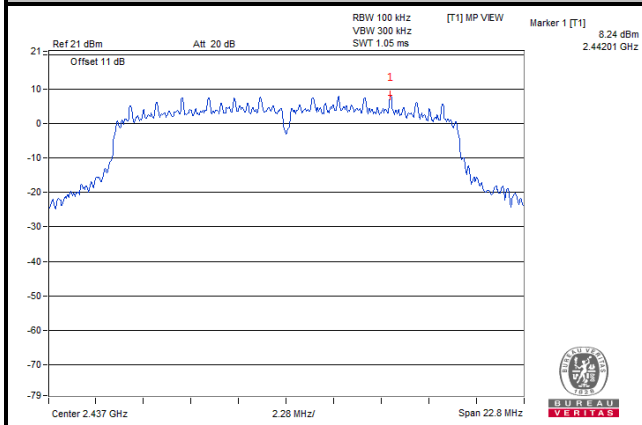

Ch 11

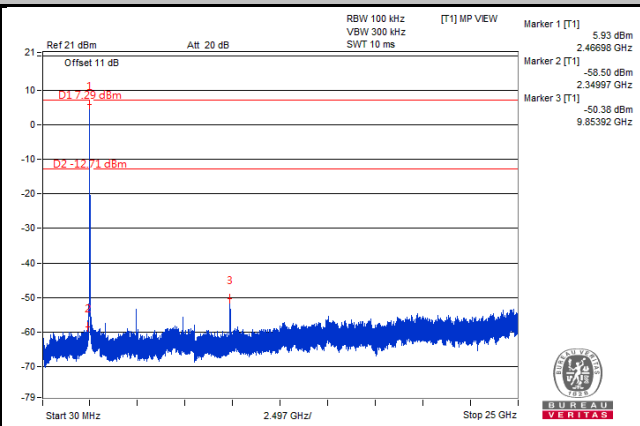
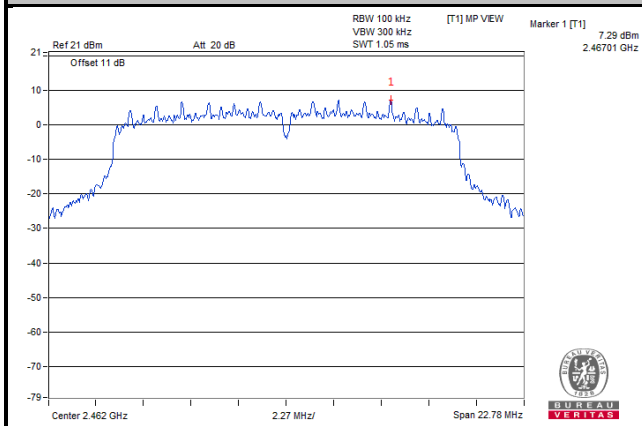

Ch 1 Band Edge

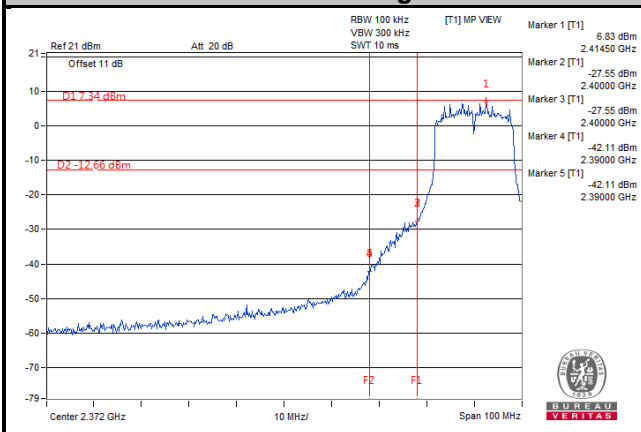

Ch 11 Band Edge

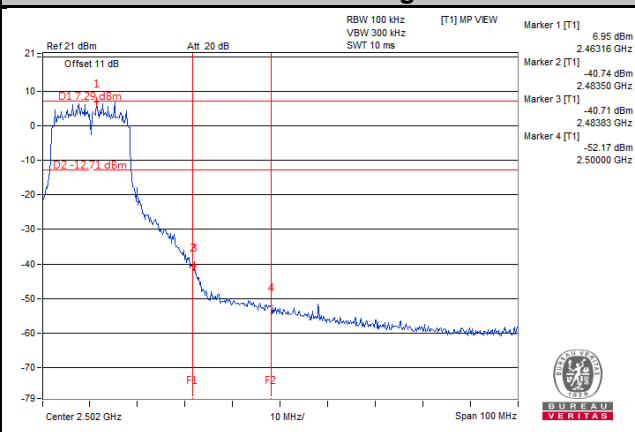

802.11n (HT20)
CHAIN 0

Ch 1

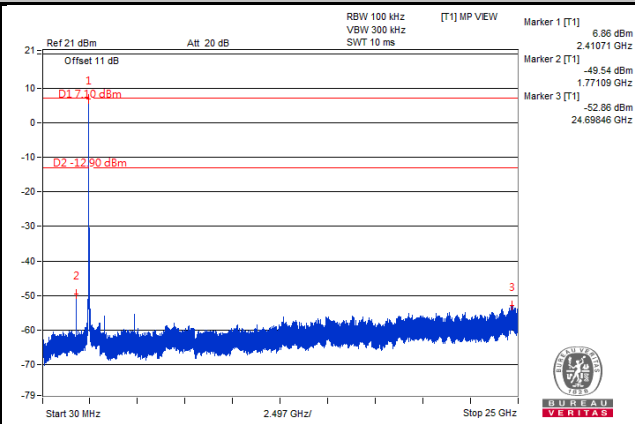
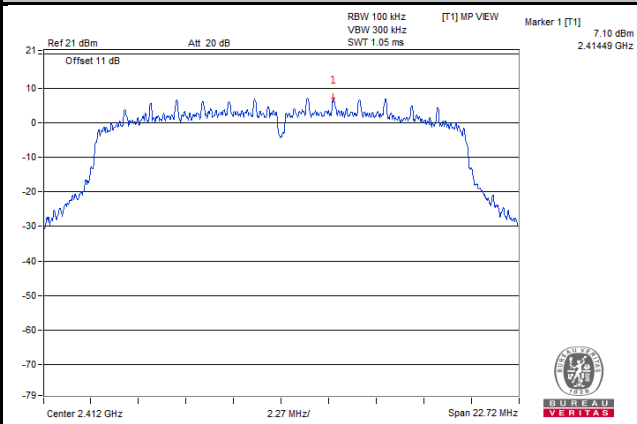

Ch 6

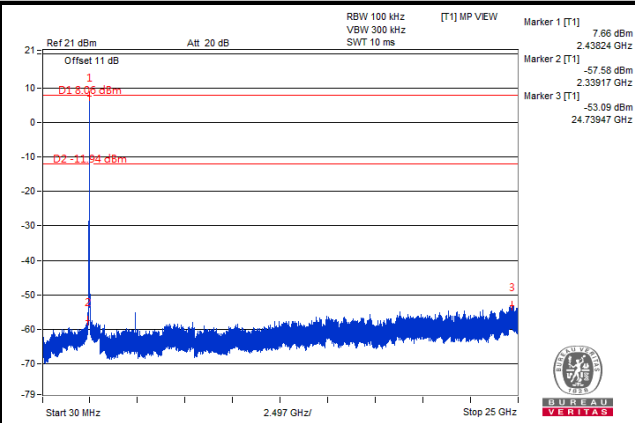
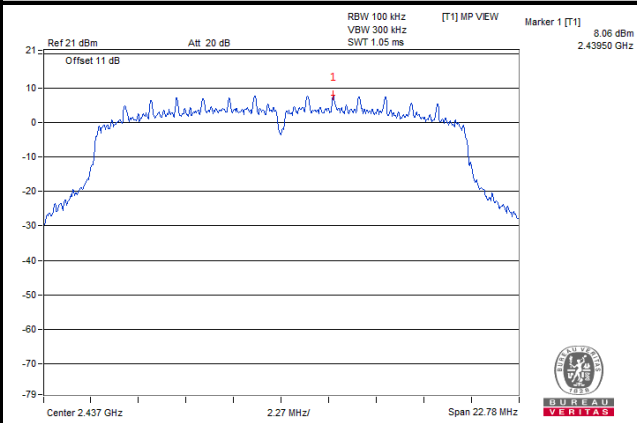

Ch 11

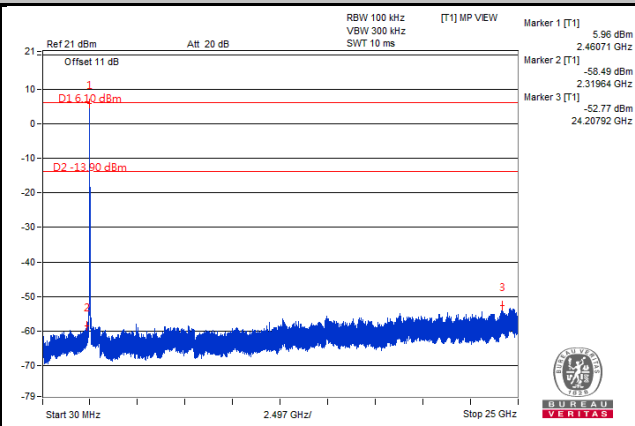
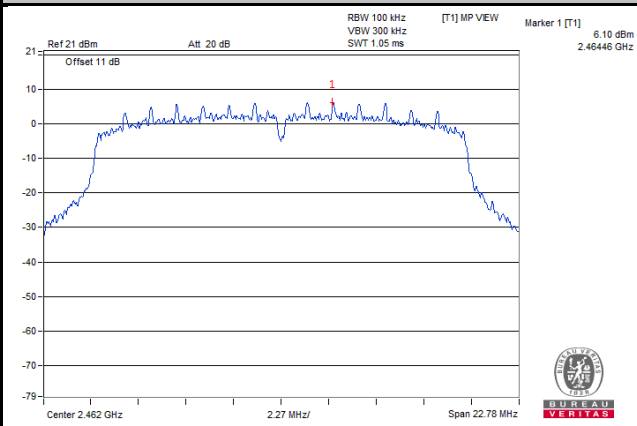

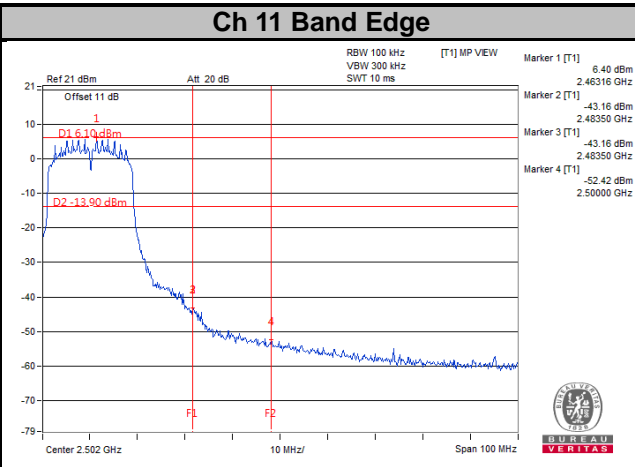
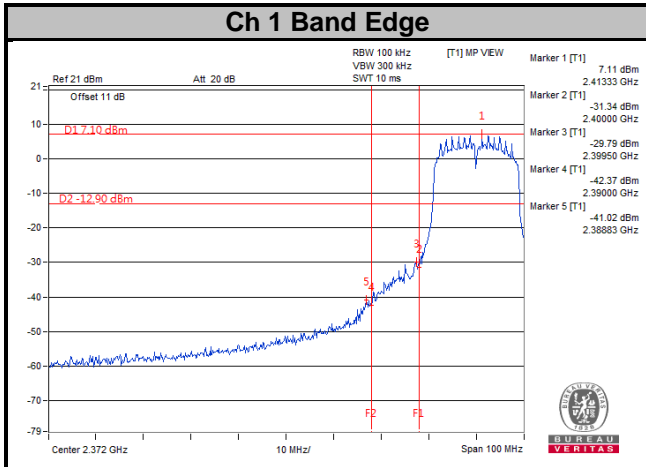

CHAIN 1

Ch 1

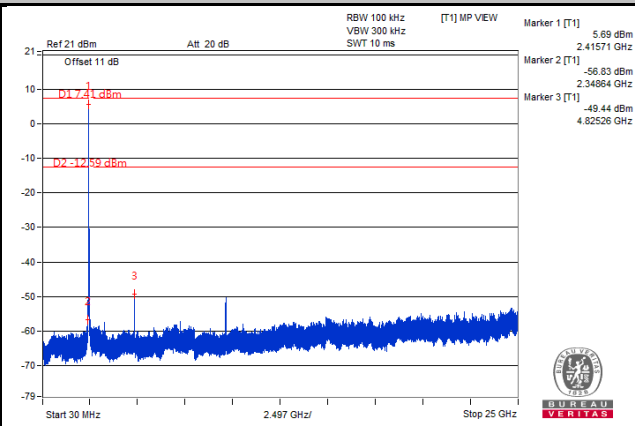
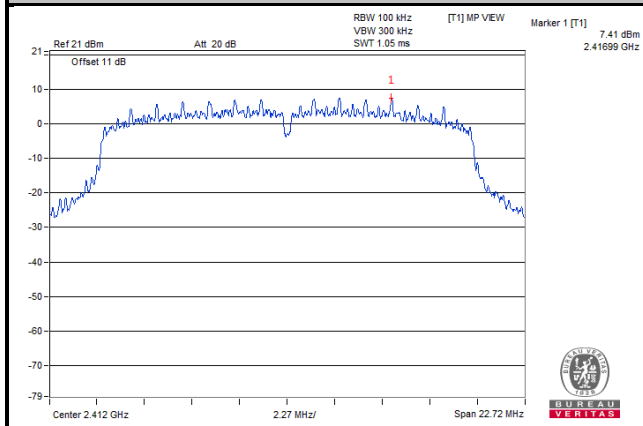

Ch 6

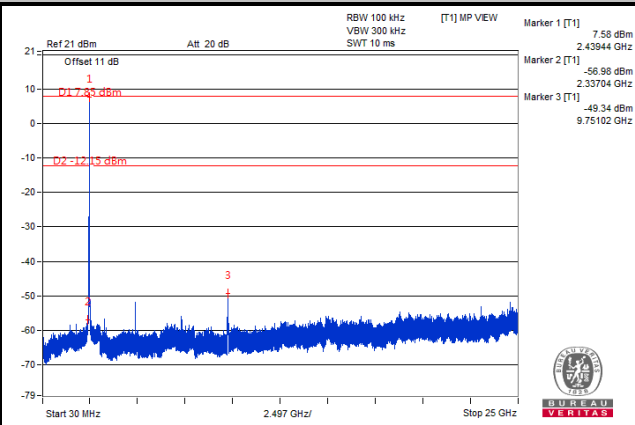
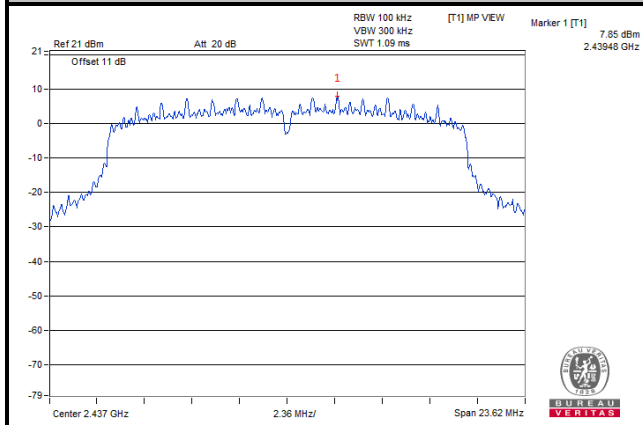

Ch 11

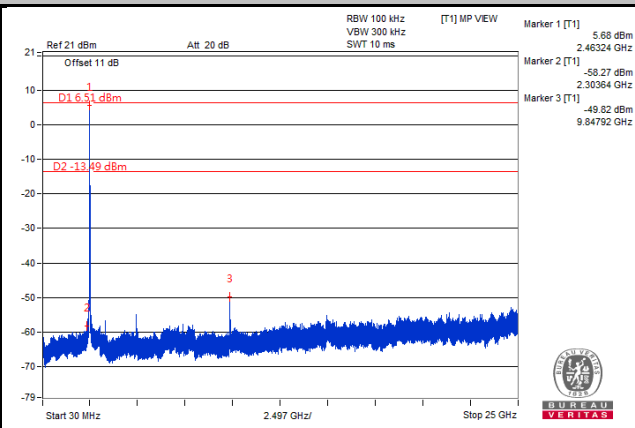
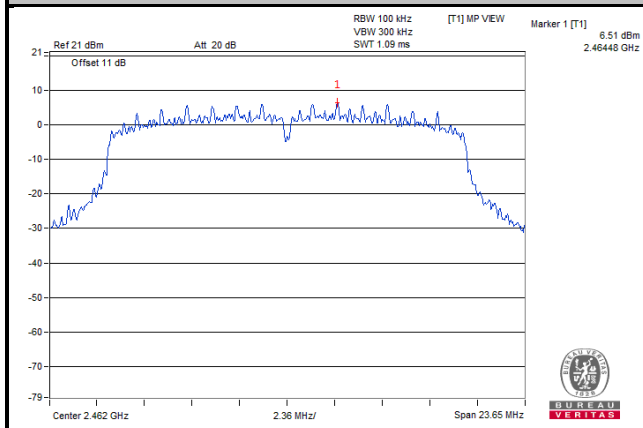

Ch 1 Band Edge

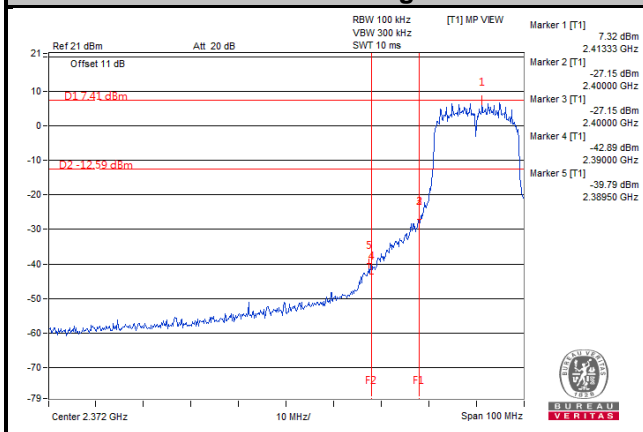

Ch 11 Band Edge

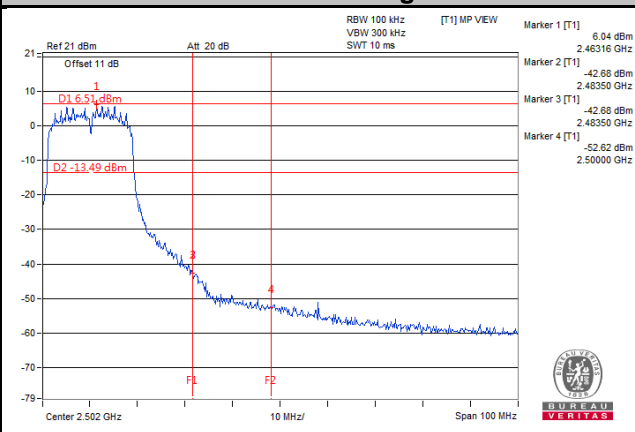

802.11n (HT40)
CHAIN 0

Ch 3

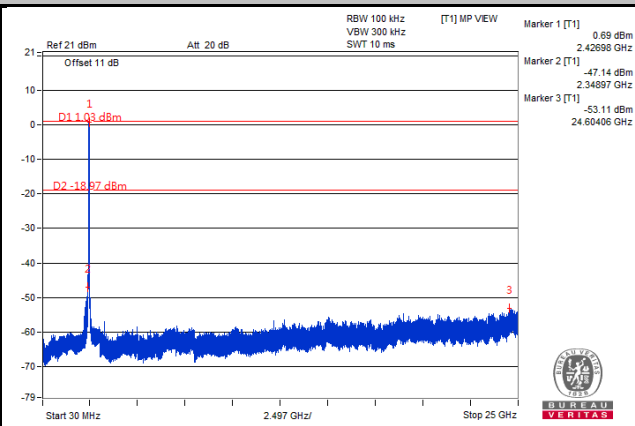
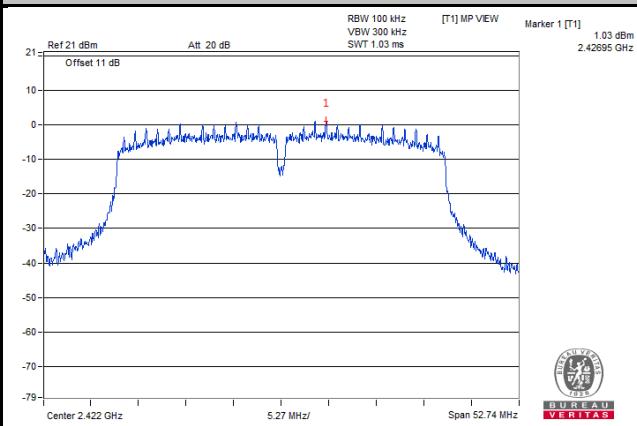

Ch 6

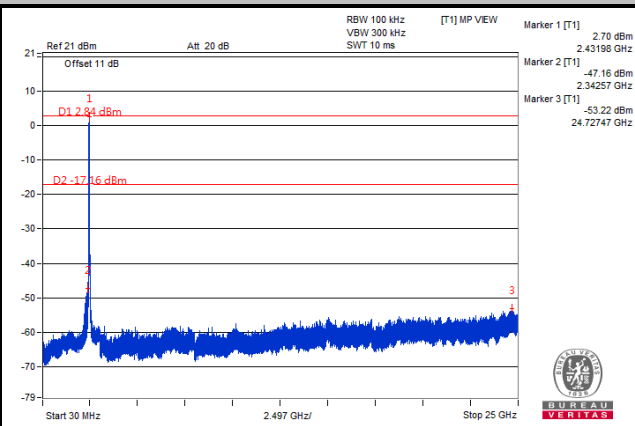
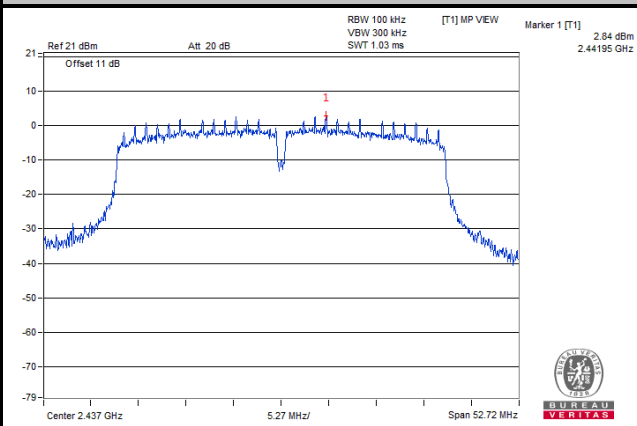

Ch 9

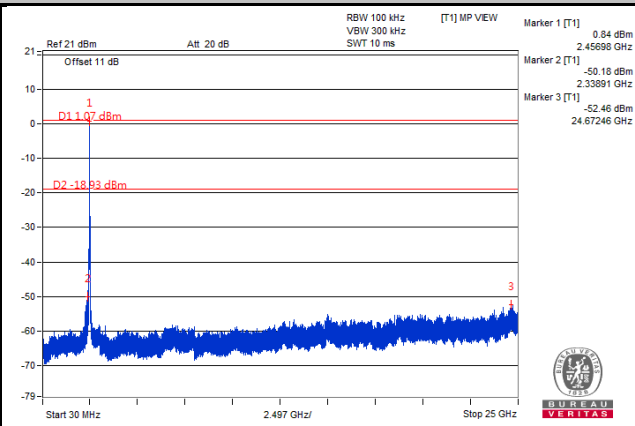
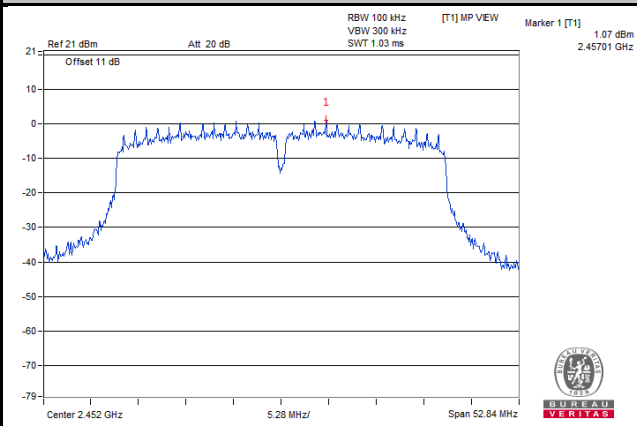

Ch 3 Band Edge

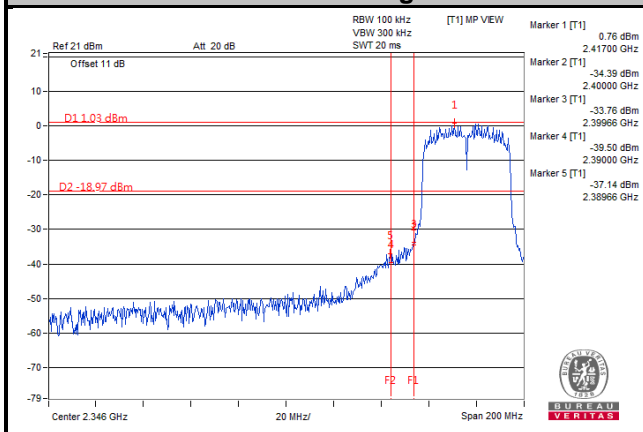

Ch 9 Band Edge

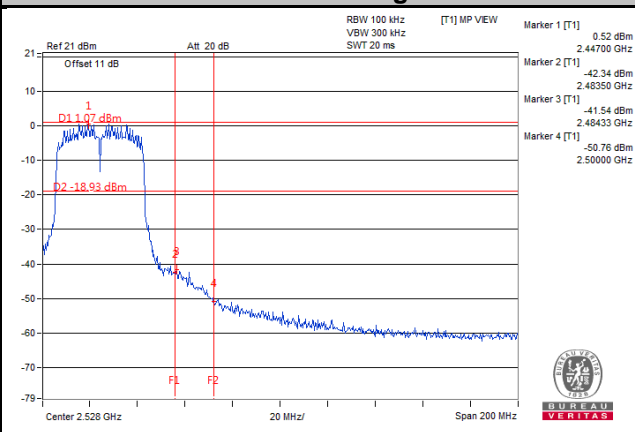

CHAIN 1

Ch 3

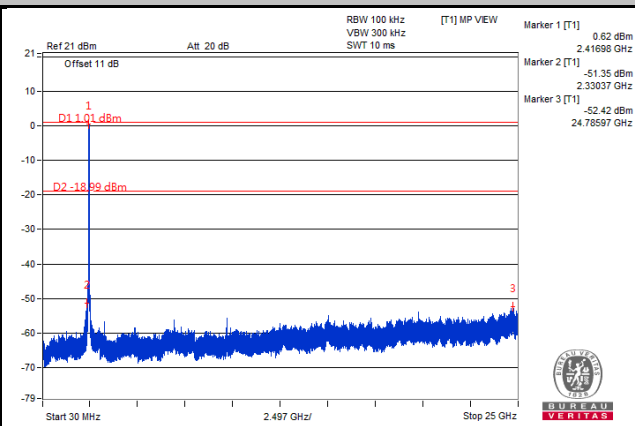
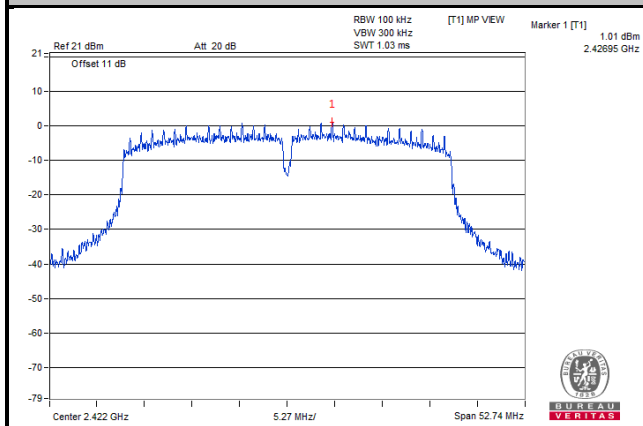

Ch 6

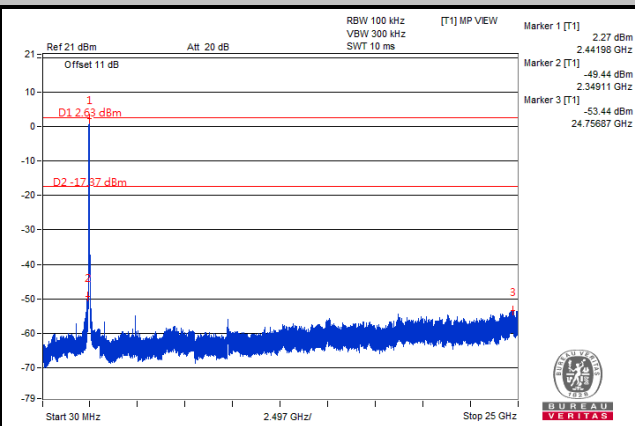
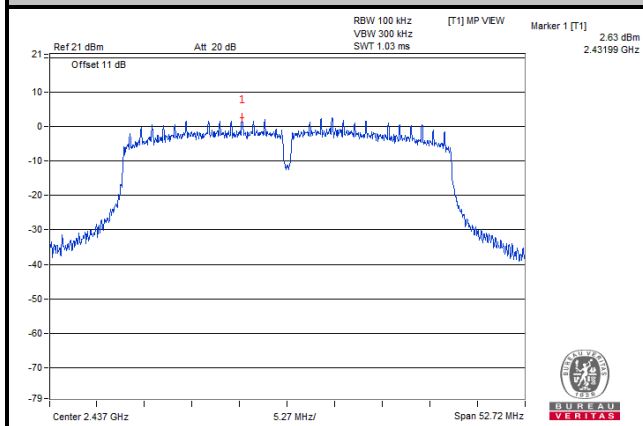

Ch 9

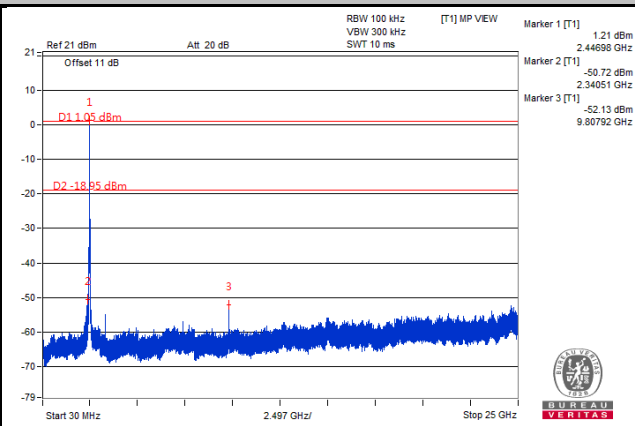
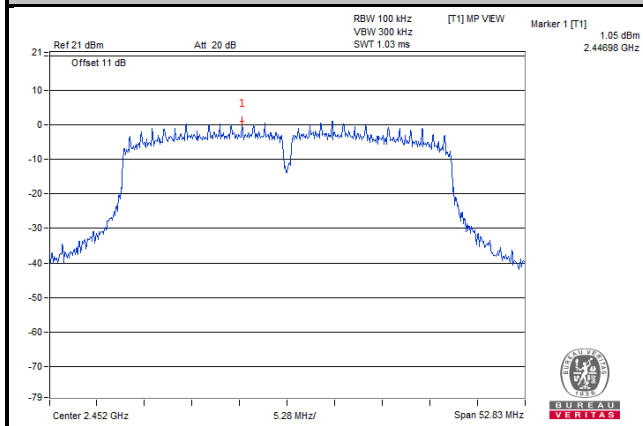

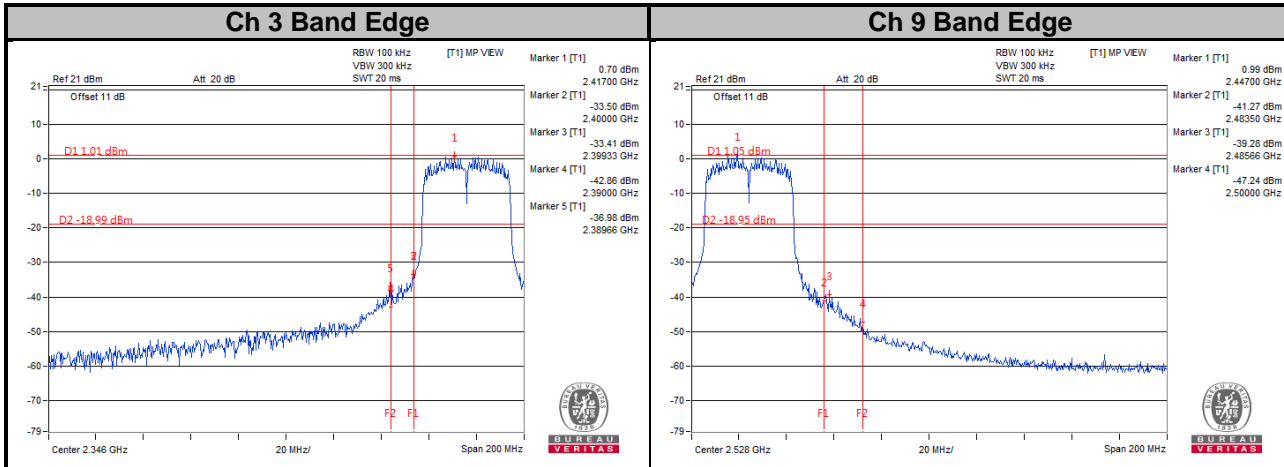

5 Pictures of Test Arrangements

Please refer to the attached file (Test Setup Photo).

Appendix – Information on the Testing Laboratories

We, Bureau Veritas Consumer Products Services (H.K.) Ltd., Taoyuan Branch, were founded in 1988 to provide our best service in EMC, Radio, Telecom and Safety consultation. Our laboratories are FCC recognized accredited test firms and accredited according to ISO/IEC 17025.

If you have any comments, please feel free to contact us at the following:

Linko EMC/RF Lab

Tel: 886-2-26052180

Fax: 886-2-26051924

Hsin Chu EMC/RF/Telecom Lab

Tel: 886-3-6668565

Fax: 886-3-6668323

Hwa Ya EMC/RF/Safety Lab

Tel: 886-3-3183232

Fax: 886-3-3270892

Email: service.adt@tw.bureauveritas.com

Web Site: www.bureauveritas-adt.com

The address and road map of all our labs can be found in our web site also.

--- END ---