

## FCC Test Report (Zigbee)

**Report No.:** RF170413C60-2

**FCC ID:** VUISPECTRUM-T

**Test Model:** Spectrum210-T

**Series Model:** Spectrum110-T

**Received Date:** Apr. 13, 2017

**Test Date:** Apr. 20 to 25, 2017

**Issued Date:** May 24, 2017

**Applicant:** PEGATRON CORPORATION

**Address:** 5F, No. 76 Ligong St., Beitou, Taipei 112, Taiwan

**Issued By:** Bureau Veritas Consumer Products Services (H.K.) Ltd., Taoyuan Branch  
Hsin Chu Laboratory

**Lab Address:** E-2, No.1, Li Hsin 1st Road, Hsinchu Science Park, Hsinchu City 300,  
Taiwan R.O.C.

**Test Location (1):** E-2, No.1, Li Hsin 1st Road, Hsinchu Science Park, Hsinchu City 300,  
Taiwan R.O.C.

**Test Location (2):** No. 49, Ln. 206, Wende Rd., Shangshan Tsuen, Chiung Lin Hsiang, Hsin  
Chu Hsien 307, Taiwan R.O.C.



This report is for your exclusive use. Any copying or replication of this report to or for any other person or entity, or use of our name or trademark, is permitted only with our prior written permission. This report sets forth our findings solely with respect to the test samples identified herein. The results set forth in this report are not indicative or representative of the quality or characteristics of the lot from which a test sample was taken or any similar or identical product unless specifically and expressly noted. Our report includes all of the tests requested by you and the results thereof based upon the information that you provided to us. You have 60 days from date of issuance of this report to notify us of any material error or omission caused by our negligence, provided, however, that such notice shall be in writing and shall specifically address the issue you wish to raise. A failure to raise such issue within the prescribed time shall constitute your unqualified acceptance of the completeness of this report, the tests conducted and the correctness of the report contents. Unless specific mention, the uncertainty of measurement has been explicitly taken into account to declare the compliance or non-compliance to the specification. The report must not be used by the client to claim product certification, approval, or endorsement by TAF or any government agencies.

## Table of Contents

<b>Release Control Record</b> .....	<b>4</b>
<b>1 Certificate of Conformity</b> .....	<b>5</b>
<b>2 Summary of Test Results</b> .....	<b>6</b>
2.1 Measurement Uncertainty .....	6
2.2 Modification Record .....	6
<b>3 General Information</b> .....	<b>7</b>
3.1 General Description of EUT (Zigbee) .....	7
3.2 Description of Test Modes .....	8
3.2.1 Test Mode Applicability and Tested Channel Detail .....	9
3.3 Duty Cycle of Test Signal .....	10
3.4 Description of Support Units .....	11
3.4.1 Configuration of System under Test .....	11
3.5 General Description of Applied Standards .....	12
<b>4 Test Types and Results</b> .....	<b>13</b>
4.1 Radiated Emission and Bandedge Measurement .....	13
4.1.1 Limits of Radiated Emission and Bandedge Measurement .....	13
4.1.2 Test Instruments .....	14
4.1.3 Test Procedures .....	15
4.1.4 Deviation from Test Standard .....	15
4.1.5 Test Setup .....	16
4.1.6 EUT Operating Conditions .....	17
4.1.7 Test Results .....	18
4.2 Conducted Emission Measurement .....	22
4.2.1 Limits of Conducted Emission Measurement .....	22
4.2.2 Test Instruments .....	22
4.2.3 Test Procedures .....	23
4.2.4 Deviation from Test Standard .....	23
4.2.5 Test Setup .....	23
4.2.6 EUT Operating Conditions .....	23
4.2.7 Test Results .....	24
4.3 6dB Bandwidth Measurement .....	26
4.3.1 Limits of 6dB Bandwidth Measurement .....	26
4.3.2 Test Setup .....	26
4.3.3 Test Instruments .....	26
4.3.4 Test Procedures .....	26
4.3.5 Deviation from Test Standard .....	26
4.3.6 EUT Operating Conditions .....	26
4.3.7 Test Results .....	27
4.4 Conducted Output Power Measurement .....	28
4.4.1 Limits of Conducted Output Power Measurement .....	28
4.4.2 Test Setup .....	28
4.4.3 Test Instruments .....	28
4.4.4 Test Procedures .....	28
4.4.5 Deviation from Test Standard .....	28
4.4.6 EUT Operating Conditions .....	28
4.4.7 Test Results .....	29
4.5 Power Spectral Density Measurement .....	30
4.5.1 Limits of Power Spectral Density Measurement .....	30
4.5.2 Test Setup .....	30
4.5.3 Test Instruments .....	30
4.5.4 Test Procedures .....	30
4.5.5 Deviation from Test Standard .....	30
4.5.6 EUT Operating Conditions .....	30

4.5.7 Test Results .....	31
4.6 Conducted Out of Band Emission Measurement .....	32
4.6.1 Limits of Conducted Out of Band Emission Measurement.....	32
4.6.2 Test Setup.....	32
4.6.3 Test Instruments .....	32
4.6.4 Test Procedures.....	32
4.6.5 Deviation from Test Standard .....	32
4.6.6 EUT Operating Conditions.....	32
4.6.7 Test Results .....	32
<b>5 Pictures of Test Arrangements.....</b>	<b>34</b>
<b>Appendix – Information on the Testing Laboratories .....</b>	<b>35</b>

### Release Control Record

Issue No.	Description	Date Issued
RF170413C60-2	Original release.	May 24, 2017

## 1 Certificate of Conformity

**Product:** STB  
**Brand:** Technicolor  
**Test Model:** Spectrum210-T  
**Series Model:** Spectrum110-T  
**Sample Status:** ENGINEERING SAMPLE  
**Applicant:** PEGATRON CORPORATION  
**Test Date:** Apr. 20 to 25, 2017  
**Standards:** 47 CFR FCC Part 15, Subpart C (Section 15.247)  
ANSI C63.10:2013

The above equipment has been tested by **Bureau Veritas Consumer Products Services (H.K.) Ltd., Taoyuan Branch**, and found compliance with the requirement of the above standards. The test record, data evaluation & Equipment Under Test (EUT) configurations represented herein are true and accurate accounts of the measurements of the sample's EMC characteristics under the conditions specified in this report.

**Prepared by :** Cindy Hsin , **Date:** May 24, 2017  
Cindy Hsin / Specialist

**Approved by :** May Chen , **Date:** May 24, 2017  
May Chen / Manager

## 2 Summary of Test Results

47 CFR FCC Part 15, Subpart C (SECTION 15.247)			
FCC Clause	Test Item	Result	Remarks
15.207	AC Power Conducted Emission	PASS	Meet the requirement of limit. Minimum passing margin is -12.40dB at 13.78906MHz.
15.205 / 15.209 / 15.247(d)	Radiated Emissions and Band Edge Measurement	PASS	Meet the requirement of limit. Minimum passing margin is -1.1dB at 7425.00MHz.
15.247(d)	Antenna Port Emission	PASS	Meet the requirement of limit.
15.247(a)(2)	6dB bandwidth	PASS	Meet the requirement of limit.
15.247(b)	Conducted power	PASS	Meet the requirement of limit.
15.247(e)	Power Spectral Density	PASS	Meet the requirement of limit.
15.203	Antenna Requirement	PASS	No antenna connector is used.

### 2.1 Measurement Uncertainty

Where relevant, the following measurement uncertainty levels have been estimated for tests performed on the EUT as specified in CISPR 16-4-2:

Measurement	Frequency	Expanded Uncertainty (k=2) ( $\pm$ )
Conducted Emissions at mains ports	150kHz ~ 30MHz	1.84 dB
Radiated Emissions up to 1 GHz	30MHz ~ 1GHz	5.30 dB
Radiated Emissions above 1 GHz	1GHz ~ 6GHz	4.78 dB
	6GHz ~ 18GHz	4.52 dB
	18GHz ~ 40GHz	5.08 dB

### 2.2 Modification Record

There were no modifications required for compliance.

### 3 General Information

#### 3.1 General Description of EUT (Zigbee)

Product	STB
Brand	Technicolor
Test Model	Spectrum210-T
Series Model	Spectrum110-T
Status of EUT	ENGINEERING SAMPLE
Power Supply Rating	DC 12V
Modulation Type	O-QPSK
Modulation Technology	DSSS
Transfer Rate	250kbps
Operating Frequency	2425 ~ 2475MHz
Number of Channel	11
Output Power	2.588mW
Antenna Type	Refer to Note
Antenna Connector	Refer to Note
Accessory Device	NA
Cable Supplied	NA

Note:

1. Simultaneously transmission condition.

Condition	Technology	
1	Bluetooth	Zigbee

Note: The emission of the simultaneous operation has been evaluated and no non-compliance was found.

2. The EUT has below model names which are identical to each other in all aspects except for the following table:

Brand	Model Name	Difference
Technicolor	Spectrum110-T	Without HDD sku
	Spectrum210-T	With HDD sku

From the above models, model: **Spectrum210-T** was selected as representative model for the test and its data was recorded in this report.

3. The EUT must be supplied from a power adapter (not for sale together) as following table:

Brand	Model	Spec.
DELTA Electronics, INC.	ADP-36KR A	Input: 100-120Vac, 50-60Hz, 1.2A AC Input cable (Unshielded, 0.9m,) Output: 12V, 3A DC output cable (Unshielded, 1.8m, one core)

4. The antennas provided to the EUT, please refer to the following table:

For Bluetooth				
Antenna Net. Gain(dBi)	Frequency range (GHz)	Antenna Type	Antenna Connector	Cable Length (mm)
4.01	2.4~2.5	PCB	i-pex(MHF)	113mm
For Zigbee				
Antenna Net. Gain(dBi)	Frequency range (GHz)	Antenna Type	Antenna Connector	Cable Length (mm)
3.2	2.4~2.5	PCB	NA	NA

5. The above EUT information is declared by manufacturer and for more detailed features description,

please refer to the manufacturer's specifications or user's manual.

### 3.2 Description of Test Modes

11 channels are provided to the EUT:

Channel	Frequency	Channel	Frequency
15	2425	21	2455
16	2430	22	2460
17	2435	23	2465
18	2440	24	2470
19	2445	25	2475
20	2450		



### 3.2.1 Test Mode Applicability and Tested Channel Detail

EUT CONFIGURE MODE	APPLICABLE TO				DESCRIPTION
	RE $\geq$ 1G	RE $<$ 1G	PLC	APCM	
-	√	√	-	√	-

Where **RE $\geq$ 1G**: Radiated Emission above 1GHz & Bandedge Measurement  
**RE $<$ 1G**: Radiated Emission below 1GHz  
**PLC**: Power Line Conducted Emission  
**APCM**: Antenna Port Conducted Measurement

#### Radiated Emission Test (Above 1GHz):

- Pre-Scan has been conducted to determine the worst-case mode from all possible combinations between available modulations, data rates and antenna ports (if EUT with antenna diversity architecture).
- Following channel(s) was (were) selected for the final test as listed below.

AVAILABLE CHANNEL	TESTED CHANNEL	MODULATION TYPE	DATA RATE (kbps)
15 to 25	15, 20, 25	O-QPSK	250

#### Radiated Emission Test (Below 1GHz):

- Pre-Scan has been conducted to determine the worst-case mode from all possible combinations between available modulations, data rates and antenna ports (if EUT with antenna diversity architecture).
- Following channel(s) was (were) selected for the final test as listed below.

AVAILABLE CHANNEL	TESTED CHANNEL	MODULATION TYPE	DATA RATE (kbps)
15 to 25	15	O-QPSK	250

#### Antenna Port Conducted Measurement:

- This item includes all test value of each mode, but only includes spectrum plot of worst value of each mode.
- Pre-Scan has been conducted to determine the worst-case mode from all possible combinations between available modulations, data rates and antenna ports (if EUT with antenna diversity architecture).
- Following channel(s) was (were) selected for the final test as listed below.

AVAILABLE CHANNEL	TESTED CHANNEL	MODULATION TYPE	DATA RATE (kbps)
15 to 25	15	O-QPSK	250

#### Test Condition:

APPLICABLE TO	ENVIRONMENTAL CONDITIONS	INPUT POWER	TESTED BY
RE $\geq$ 1G	24deg. C, 65%RH	120Vac, 60Hz	Weiwei Lo
RE $<$ 1G	24deg. C, 67%RH	120Vac, 60Hz	Jyunchun Lin
APCM	25deg. C, 75%RH	120Vac, 60Hz	Andy Ho

### 3.3 Duty Cycle of Test Signal

Duty cycle of test signal is 100 %, duty factor is not required.

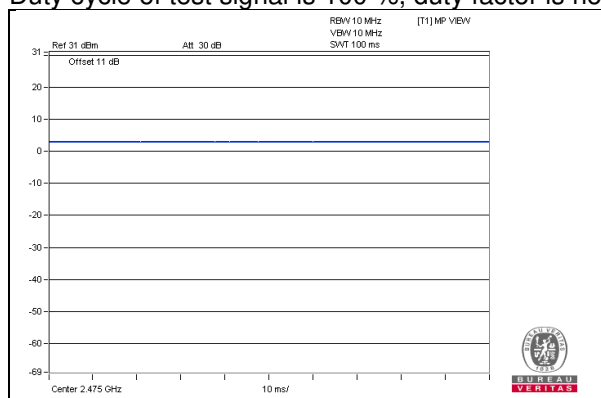

### 3.4 Description of Support Units

The EUT has been tested as an independent unit.

ID	Descriptions	Qty.	Length (m)	Shielding (Yes/No)	Cores (Qty.)	Remarks
1.	DC Cable	1	1.8	No	1	Supplied by client
2.	AC Cable	1	0.9	No	0	Supplied by client
3.	Console Cable	1	0.23	No	0	Supplied by client(for RF Setup)

Note: The core(s) is(are) originally attached to the cable(s).

#### 3.4.1 Configuration of System under Test

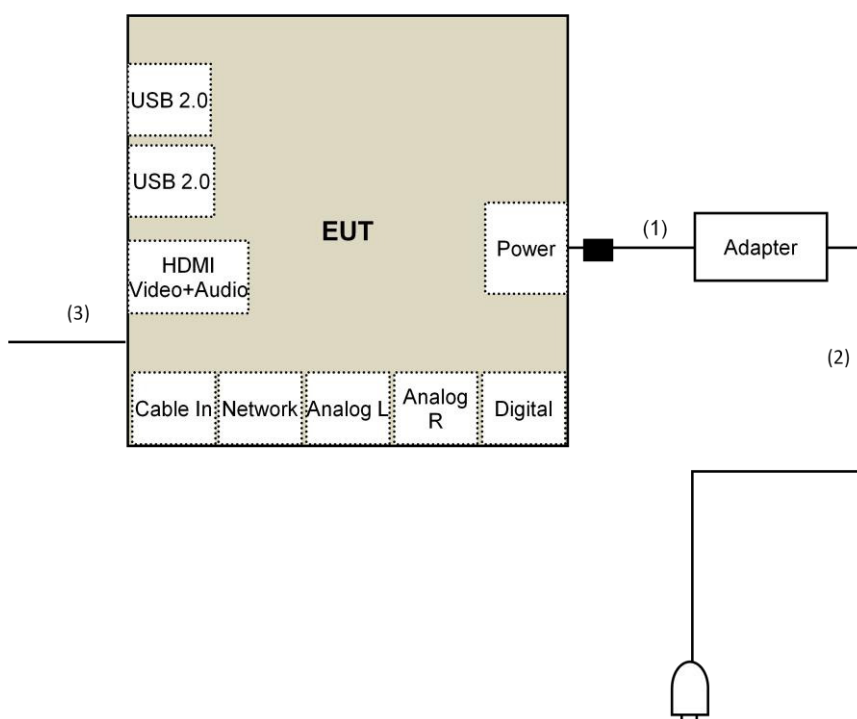

### 3.5 General Description of Applied Standards

The EUT is a RF Product. According to the specifications of the manufacturer, it must comply with the requirements of the following standards:

**FCC Part 15, Subpart C (15.247)**

**558074 D01 DTS Meas Guidance v04**

ANSI C63.10-2013

All test items have been performed and recorded as per the above standards.

**NOTE:** The EUT has been verified to comply with the requirements of FCC Part 15, Subpart B, Class B (DoC). The test report has been issued separately.

## 4 Test Types and Results

### 4.1 Radiated Emission and Bandedge Measurement

#### 4.1.1 Limits of Radiated Emission and Bandedge Measurement

Radiated emissions which fall in the restricted bands must comply with the radiated emission limits specified as below table. Other emissions shall be at least 20dB below the highest level of the desired power:

Frequencies (MHz)	Field Strength (microvolts/meter)	Measurement Distance (meters)
0.009 ~ 0.490	2400/F(kHz)	300
0.490 ~ 1.705	24000/F(kHz)	30
1.705 ~ 30.0	30	30
30 ~ 88	100	3
88 ~ 216	150	3
216 ~ 960	200	3
Above 960	500	3

**NOTE:**

1. The lower limit shall apply at the transition frequencies.
2. Emission level (dBuV/m) = 20 log Emission level (uV/m).
3. For frequencies above 1000MHz, the field strength limits are based on average detector, however, the peak field strength of any emission shall not exceed the maximum permitted average limits, specified above by more than 20dB under any condition of modulation.

## 4.1.2 Test Instruments

DESCRIPTION & MANUFACTURER	MODEL NO.	SERIAL NO.	CALIBRATED DATE	CALIBRATED UNTIL
Test Receiver Keysight	N9038A	MY54450088	July 20, 2016	July 19, 2017
Pre-Amplifier <sup>(*)</sup> EMCI	EMC001340	980142	Jan. 20, 2016	Jan. 19, 2018
Loop Antenna <sup>(*)</sup> Electro-Metrics	EM-6879	264	Dec. 16, 2016	Dec. 15, 2018
RF Cable	NA	LOOPCAB-001 LOOPCAB-002	Jan. 17, 2017	Jan. 16, 2018
Pre-Amplifier Mini-Circuits	ZFL-1000VH2B	AMP-ZFL-01	Nov. 10, 2016	Nov. 09, 2017
Trilog Broadband Antenna SCHWARZBECK	VULB 9168	9168-406	Dec. 13, 2016	Dec. 12, 2017
RF Cable	8D	966-4-1 966-4-2 966-4-3	Apr. 01, 2017	Mar. 31, 2018
Fixed attenuator Mini-Circuits	UNAT-5+	PAD-3m-4-01	Oct. 05, 2016	Oct. 04, 2017
Horn_Antenna SCHWARZBECK	BBHA 9120D	9120D-783	Dec. 27, 2016	Dec. 26, 2017
Pre-Amplifier EMCI	EMC12630SE	980385	Feb. 02, 2017	Feb. 01, 2018
RF Cable	EMC104-SM-SM-1200 EMC104-SM-SM-2000 EMC104-SM-SM-5000	160923 150318 150323	Feb. 02, 2017 Mar. 29, 2017 Mar. 29, 2017	Feb. 01, 2018 Mar. 28, 2018 Mar. 28, 2018
Pre-Amplifier EMCI	EMC184045SE	980387	Feb. 02, 2017	Feb. 01, 2018
Horn_Antenna SCHWARZBECK	BBHA 9170	BBHA9170608	Dec. 15, 2016	Dec. 14, 2017
RF Cable	SUCOFLEX 102	36432/2 36433/2	Jan. 15, 2017	Jan. 14, 2018
Software	ADT_Radiated_V8.7.08	NA	NA	NA
Antenna Tower & Turn Table Max-Full	MF-7802	MF780208410	NA	NA
Boresight Antenna Fixture	FBA-01	FBA-SIP02	NA	NA
Spectrum Analyzer R&S	FSv40	100964	June 28, 2016	June 27, 2017
Power meter Anritsu	ML2495A	1014008	May 5, 2016	May 4, 2017
Power sensor Anritsu	MA2411B	0917122	May 5, 2016	May 4, 2017

**Note:**

1. The calibration interval of the above test instruments is 12 months and the calibrations are traceable to NML/ROC and NIST/USA.
2. \*The calibration interval of the above test instruments is 24 months and the calibrations are traceable to NML/ROC and NIST/USA.
3. The test was performed in 966 Chamber No. 4.
4. The FCC Site Registration No. is 292998
5. The CANADA Site Registration No. is 20331-2
- 6 Loop antenna was used for all emissions below 30 MHz.
7. Tested Date: Apr. 20, 2017

#### 4.1.3 Test Procedures

##### **For Radiated emission below 30MHz**

- a. The EUT was placed on the top of a rotating table 0.8 meters above the ground at a 3 meter chamber room. The table was rotated 360 degrees to determine the position of the highest radiation.
- b. The EUT was set 3 meters away from the interference-receiving antenna, which was mounted on the top of a variable-height antenna tower.
- c. Both X and Y axes of the antenna are set to make the measurement.
- d. For each suspected emission, the EUT was arranged to its worst case and the rotatable table was turned from 0 degrees to 360 degrees to find the maximum reading.
- e. The test-receiver system was set to Quasi-Peak Detect Function and Specified Bandwidth with Maximum Hold Mode.

##### **NOTE:**

1. The resolution bandwidth and video bandwidth of test receiver/spectrum analyzer is 9kHz at frequency below 30MHz.

##### **For Radiated emission above 30MHz**

- a. The EUT was placed on the top of a rotating table 0.8 meters (for 30MHz ~ 1GHz) / 1.5 meters (for above 1GHz) above the ground at 3 meter chamber room for test. The table was rotated 360 degrees to determine the position of the highest radiation.
- b. The EUT was set 3 meters away from the interference-receiving antenna, which was mounted on the top of a variable-height antenna tower.
- c. The height of antenna is varied from one meter to four meters above the ground to determine the maximum value of the field strength. Both horizontal and vertical polarizations of the antenna are set to make the measurement.
- d. For each suspected emission, the EUT was arranged to its worst case and then the antenna was tuned to heights from 1 meter to 4 meters and the rotatable table was turned from 0 degrees to 360 degrees to find the maximum reading.
- e. The test-receiver system was set to quasi-peak detect function and specified bandwidth with maximum hold mode when the test frequency is below 1 GHz.
- f. The test-receiver system was set to peak and average detect function and specified bandwidth with maximum hold mode when the test frequency is above 1 GHz. If the peak reading value also meets average limit, measurement with the average detector is unnecessary.

##### **Note:**

1. The resolution bandwidth and video bandwidth of test receiver/spectrum analyzer is 120kHz for Quasi-peak detection (QP) at frequency below 1GHz.
2. The resolution bandwidth of test receiver/spectrum analyzer is 1 MHz and the video bandwidth is 3 MHz for Peak detection (PK) at frequency above 1GHz.
3. The resolution bandwidth of test receiver/spectrum analyzer is 1 MHz and the video bandwidth is 3 MHz for Average detection (AV) at frequency above 1GHz. If duty cycle of test signal is < 98%, the duty factor need added to measured value.
4. All modes of operation were investigated and the worst-case emissions are reported.

#### 4.1.4 Deviation from Test Standard

No deviation.

#### 4.1.5 Test Setup

##### For Radiated emission below 30MHz

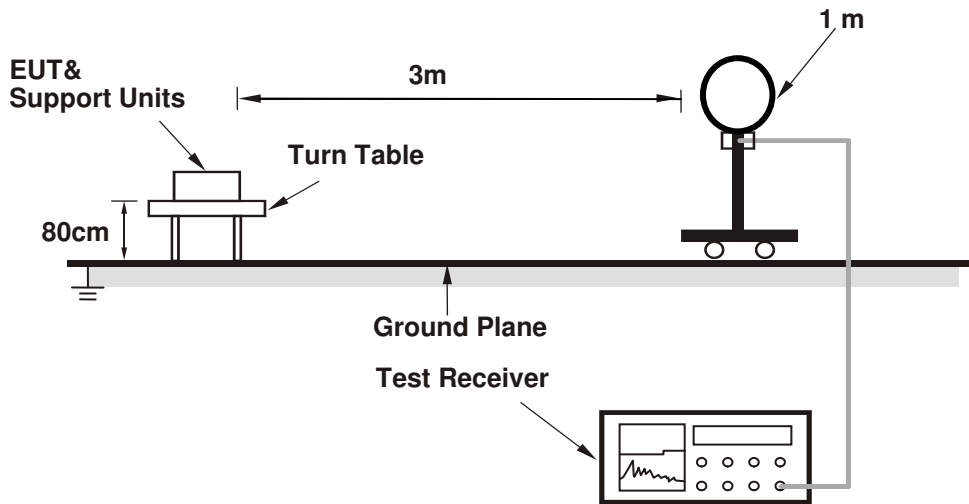

##### For Radiated emission 30MHz to 1GHz

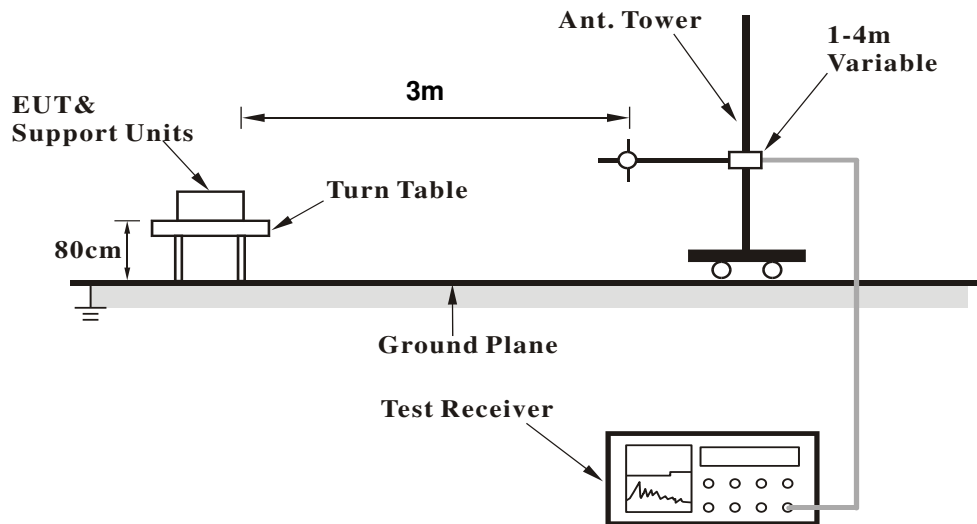



**For Radiated emission above 1GHz**

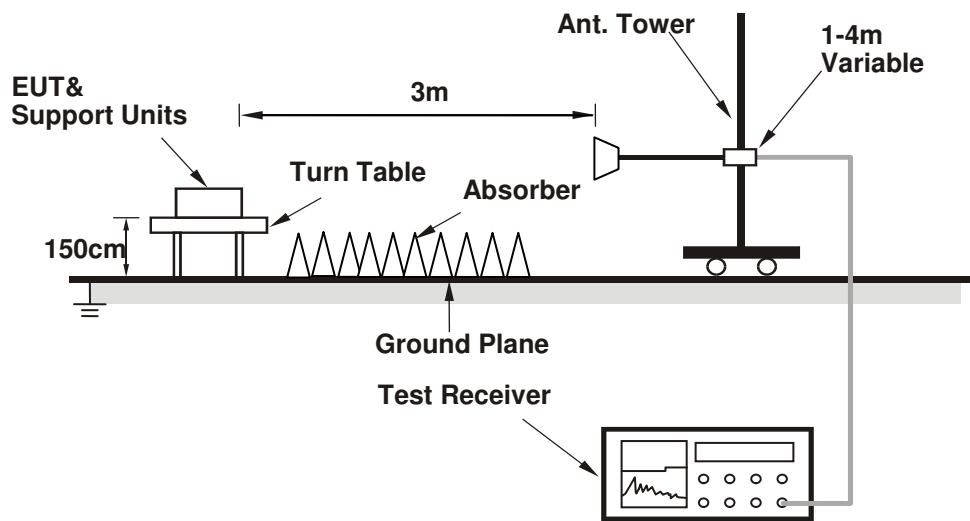

For the actual test configuration, please refer to the attached file (Test Setup Photo).

**4.1.6 EUT Operating Conditions**

- a. Controlling software (Setup SmartRF Studio 7-2.5.0) has been activated to set the EUT on specific status.

## 4.1.7 Test Results

## Above 1GHz Data:

<b>CHANNEL</b>	TX Channel 15	<b>DETECTOR FUNCTION</b>	Peak (PK)
<b>FREQUENCY RANGE</b>	1GHz ~ 25GHz		Average (AV)

**ANTENNA POLARITY & TEST DISTANCE: HORIZONTAL AT 3 M**

NO.	FREQ. (MHz)	EMISSION LEVEL (dBuV/m)	LIMIT (dBuV/m)	MARGIN (dB)	ANTENNA HEIGHT (m)	TABLE ANGLE (Degree)	RAW VALUE (dBuV)	CORRECTION FACTOR (dB/m)
1	2375.00	46.8 PK	74.0	-27.2	2.71 H	242	48.2	-1.4
2	2375.00	34.7 AV	54.0	-19.3	2.71 H	242	36.1	-1.4
3	*2425.00	102.5 PK			2.71 H	242	103.7	-1.2
4	*2425.00	98.7 AV			2.71 H	242	99.9	-1.2
5	4850.00	45.5 PK	74.0	-28.5	1.25 H	89	42.2	3.3
6	4850.00	40.7 AV	54.0	-13.3	1.25 H	89	37.4	3.3
7	7275.00	59.8 PK	74.0	-14.2	3.83 H	178	50.0	9.8
8	7275.00	50.0 AV	54.0	-4.0	3.83 H	178	40.2	9.8

**ANTENNA POLARITY & TEST DISTANCE: VERTICAL AT 3 M**

NO.	FREQ. (MHz)	EMISSION LEVEL (dBuV/m)	LIMIT (dBuV/m)	MARGIN (dB)	ANTENNA HEIGHT (m)	TABLE ANGLE (Degree)	RAW VALUE (dBuV)	CORRECTION FACTOR (dB/m)
1	2375.00	48.3 PK	74.0	-25.7	2.80 V	305	49.7	-1.4
2	2375.00	38.2 AV	54.0	-15.8	2.80 V	305	39.6	-1.4
3	*2425.00	101.9 PK			2.80 V	305	103.1	-1.2
4	*2425.00	98.1 AV			2.80 V	305	99.3	-1.2
5	4850.00	47.9 PK	74.0	-26.1	1.10 V	156	44.6	3.3
6	4850.00	44.2 AV	54.0	-9.8	1.10 V	156	40.9	3.3
7	7275.00	60.6 PK	74.0	-13.4	1.09 V	105	50.8	9.8
8	7275.00	51.0 AV	54.0	-3.0	1.09 V	105	41.2	9.8

**REMARKS:**

1. Emission Level(dBuV/m) = Raw Value(dBuV) + Correction Factor(dB/m)
2. Correction Factor(dB/m) = Antenna Factor(dB/m) + Cable Factor(dB) – Pre-Amplifier Factor(dB)
3. The other emission levels were very low against the limit.
4. Margin value = Emission Level – Limit value
5. " \* ": Fundamental frequency.

<b>CHANNEL</b>	TX Channel 20	<b>DETECTOR FUNCTION</b>	Peak (PK)
<b>FREQUENCY RANGE</b>	1GHz ~ 25GHz		Average (AV)

**ANTENNA POLARITY & TEST DISTANCE: HORIZONTAL AT 3 M**

NO.	FREQ. (MHz)	EMISSION LEVEL (dBuV/m)	LIMIT (dBuV/m)	MARGIN (dB)	ANTENNA HEIGHT (m)	TABLE ANGLE (Degree)	RAW VALUE (dBuV)	CORRECTION FACTOR (dB/m)
1	*2450.00	101.8 PK			2.71 H	245	102.9	-1.1
2	*2450.00	98.2 AV			2.71 H	245	99.3	-1.1
3	4900.00	45.5 PK	74.0	-28.5	1.12 H	89	42.0	3.5
4	4900.00	41.0 AV	54.0	-13.0	1.12 H	89	37.5	3.5
5	7350.00	58.8 PK	74.0	-15.2	3.66 H	172	48.9	9.9
6	7350.00	49.0 AV	54.0	-5.0	3.66 H	172	39.1	9.9

**ANTENNA POLARITY & TEST DISTANCE: VERTICAL AT 3 M**

NO.	FREQ. (MHz)	EMISSION LEVEL (dBuV/m)	LIMIT (dBuV/m)	MARGIN (dB)	ANTENNA HEIGHT (m)	TABLE ANGLE (Degree)	RAW VALUE (dBuV)	CORRECTION FACTOR (dB/m)
1	*2450.00	101.6 PK			3.02 V	284	102.7	-1.1
2	*2450.00	97.7 AV			3.02 V	284	98.8	-1.1
3	4900.00	48.3 PK	74.0	-25.7	1.19 V	156	44.8	3.5
4	4900.00	44.9 AV	54.0	-9.1	1.19 V	156	41.4	3.5
5	7350.00	60.9 PK	74.0	-13.1	1.21 V	100	51.0	9.9
6	7350.00	50.9 AV	54.0	-3.1	1.21 V	100	41.0	9.9

**REMARKS:**

1. Emission Level(dBuV/m) = Raw Value(dBuV) + Correction Factor(dB/m)
2. Correction Factor(dB/m) = Antenna Factor(dB/m) + Cable Factor(dB) – Pre-Amplifier Factor(dB)
3. The other emission levels were very low against the limit.
4. Margin value = Emission Level – Limit value
5. " \* ": Fundamental frequency.

<b>CHANNEL</b>	TX Channel 25	<b>DETECTOR FUNCTION</b>	Peak (PK)
<b>FREQUENCY RANGE</b>	1GHz ~ 25GHz		Average (AV)

**ANTENNA POLARITY & TEST DISTANCE: HORIZONTAL AT 3 M**

NO.	FREQ. (MHz)	EMISSION LEVEL (dBuV/m)	LIMIT (dBuV/m)	MARGIN (dB)	ANTENNA HEIGHT (m)	TABLE ANGLE (Degree)	RAW VALUE (dBuV)	CORRECTION FACTOR (dB/m)
1	*2475.00	100.9 PK			2.71 H	245	101.9	-1.0
2	*2475.00	97.3 AV			2.71 H	245	98.3	-1.0
3	2483.50	48.2 PK	74.0	-25.8	2.71 H	245	49.2	-1.0
4	2483.50	35.1 AV	54.0	-18.9	2.71 H	245	36.1	-1.0
5	4950.00	46.9 PK	74.0	-27.1	1.26 H	99	43.3	3.6
6	4950.00	43.0 AV	54.0	-11.0	1.26 H	99	39.4	3.6
7	7425.00	58.9 PK	74.0	-15.1	3.63 H	179	49.0	9.9
8	7425.00	50.1 AV	54.0	-3.9	3.63 H	179	40.2	9.9

**ANTENNA POLARITY & TEST DISTANCE: VERTICAL AT 3 M**

NO.	FREQ. (MHz)	EMISSION LEVEL (dBuV/m)	LIMIT (dBuV/m)	MARGIN (dB)	ANTENNA HEIGHT (m)	TABLE ANGLE (Degree)	RAW VALUE (dBuV)	CORRECTION FACTOR (dB/m)
1	*2475.00	102.1 PK			3.58 V	267	103.1	-1.0
2	*2475.00	98.4 AV			3.58 V	267	99.4	-1.0
3	2483.50	50.0 PK	74.0	-24.0	3.58 V	267	51.0	-1.0
4	2483.50	36.8 AV	54.0	-17.2	3.58 V	267	37.8	-1.0
5	4950.00	48.9 PK	74.0	-25.1	1.15 V	156	45.3	3.6
6	4950.00	45.2 AV	54.0	-8.8	1.15 V	156	41.6	3.6
7	7425.00	62.8 PK	74.0	-11.2	1.06 V	87	52.9	9.9
<b>8</b>	<b>7425.00</b>	<b>52.9 AV</b>	<b>54.0</b>	<b>-1.1</b>	<b>1.06 V</b>	<b>87</b>	<b>43.0</b>	<b>9.9</b>

**REMARKS:**

1. Emission Level(dBuV/m) = Raw Value(dBuV) + Correction Factor(dB/m)
2. Correction Factor(dB/m) = Antenna Factor(dB/m) + Cable Factor(dB) – Pre-Amplifier Factor(dB)
3. The other emission levels were very low against the limit.
4. Margin value = Emission Level – Limit value
5. " \* ": Fundamental frequency.

**Below 1GHz Data:**

<b>CHANNEL</b>	TX Channel 15	<b>DETECTOR FUNCTION</b>	Quasi-Peak (QP)
<b>FREQUENCY RANGE</b>	9kHz ~ 1GHz		

**ANTENNA POLARITY & TEST DISTANCE: HORIZONTAL AT 3 M**

NO.	FREQ. (MHz)	EMISSION LEVEL (dBuV/m)	LIMIT (dBuV/m)	MARGIN (dB)	ANTENNA HEIGHT (m)	TABLE ANGLE (Degree)	RAW VALUE (dBuV)	CORRECTION FACTOR (dB/m)
1	242.96	35.3 QP	46.0	-10.7	1.50 H	116	45.1	-9.8
2	405.00	34.9 QP	46.0	-11.1	1.00 H	225	40.0	-5.1
3	499.99	31.4 QP	46.0	-14.6	2.00 H	360	34.2	-2.8
4	580.50	33.0 QP	46.0	-13.0	1.50 H	352	34.1	-1.1
5	729.03	30.9 QP	46.0	-15.1	2.00 H	360	29.6	1.3
6	874.99	40.4 QP	46.0	-5.6	2.00 H	68	36.8	3.6

**ANTENNA POLARITY & TEST DISTANCE: VERTICAL AT 3 M**

NO.	FREQ. (MHz)	EMISSION LEVEL (dBuV/m)	LIMIT (dBuV/m)	MARGIN (dB)	ANTENNA HEIGHT (m)	TABLE ANGLE (Degree)	RAW VALUE (dBuV)	CORRECTION FACTOR (dB/m)
1	243.01	31.3 QP	46.0	-14.7	2.50 V	9	41.0	-9.7
2	567.02	30.2 QP	46.0	-15.8	1.00 V	325	31.8	-1.6
3	580.50	30.0 QP	46.0	-16.0	1.00 V	324	31.1	-1.1
4	625.02	42.6 QP	46.0	-3.4	1.00 V	60	42.7	-0.1
5	729.01	30.6 QP	46.0	-15.4	1.00 V	318	29.3	1.3
6	891.02	33.7 QP	46.0	-12.3	1.50 V	208	29.9	3.8

**REMARKS:**

1. Emission Level(dBuV/m) = Raw Value(dBuV) + Correction Factor(dB/m)
2. Correction Factor(dB/m) = Antenna Factor(dB/m) + Cable Factor(dB) – Pre-Amplifier Factor(dB)
3. The other emission levels were very low against the limit.
4. Margin value = Emission Level – Limit value

## 4.2 Conducted Emission Measurement

### 4.2.1 Limits of Conducted Emission Measurement

Frequency (MHz)	Conducted Limit (dBuV)	
	Quasi-peak	Average
0.15 - 0.5	66 - 56	56 - 46
0.50 - 5.0	56	46
5.0 - 30.0	60	50

Note: 1. The lower limit shall apply at the transition frequencies.

2. The limit decreases in line with the logarithm of the frequency in the range of 0.15 to 0.50MHz.

### 4.2.2 Test Instruments

DESCRIPTION & MANUFACTURER	MODEL NO.	SERIAL NO.	CALIBRATED DATE	CALIBRATED UNTIL
Test Receiver R&S	ESCS 30	847124/029	Oct. 24, 2016	Oct. 23, 2017
Line-Impedance Stabilization Network (for EUT) R&S	ESH3-Z5	848773/004	Oct. 26, 2016	Oct. 25, 2017
Line-Impedance Stabilization Network (for Peripheral) R&S	ENV216	100072	June 13, 2016	June 12, 2017
50 ohms Terminator	N/A	EMC-02	Sep. 29, 2016	Sep. 28, 2017
RF Cable	5D-FB	COCCAB-001	Sep. 30, 2016	Sep. 29, 2017
10 dB PAD Mini-Circuits	HAT-10+	CONATT-004	June 20, 2016	June 19, 2017
Software BVADT	BVADT_Cond_ V7.3.7.4	NA	NA	NA

#### Note:

1. The calibration interval of the above test instruments are 12 months and the calibrations are traceable to NML/ROC and NIST/USA.
2. The test was performed in Shielded Room No. 1.
3. Tested Date: Apr. 25, 2017

#### 4.2.3 Test Procedures

- The EUT was placed 0.4 meters from the conducting wall of the shielded room with EUT being connected to the power mains through a line impedance stabilization network (LISN). Other support units were connected to the power mains through another LISN. The two LISNs provide 50 ohm/ 50uH of coupling impedance for the measuring instrument.
- Both lines of the power mains connected to the EUT were checked for maximum conducted interference.
- The frequency range from 150kHz to 30MHz was searched. Emission levels under (Limit - 20dB) was not recorded.

**NOTE:** The resolution bandwidth and video bandwidth of test receiver is 9kHz for quasi-peak detection (QP) and average detection (AV) at frequency 0.15MHz-30MHz.

#### 4.2.4 Deviation from Test Standard

No deviation.

#### 4.2.5 Test Setup

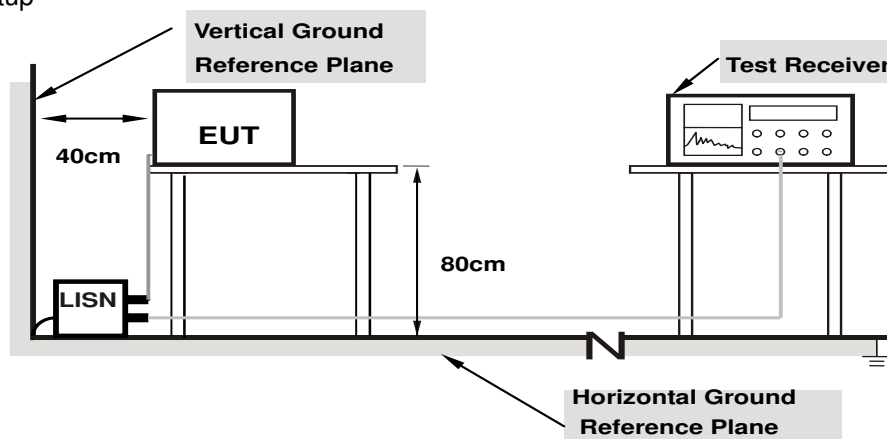

**Note:** 1.Support units were connected to second LISN.

For the actual test configuration, please refer to the attached file (Test Setup Photo).

#### 4.2.6 EUT Operating Conditions

Same as 4.1.6.

#### 4.2.7 Test Results

Phase	Line (L)	Detector Function	Quasi-Peak (QP) / Average (AV)
-------	----------	-------------------	--------------------------------

No	Freq. [MHz]	Corr. Factor	Reading Value [dB (uV)]		Emission Level [dB (uV)]		Limit [dB (uV)]		Margin (dB)	
		(dB)	Q.P.	AV.	Q.P.	AV.	Q.P.	AV.	Q.P.	AV.
	1	0.15781	10.19	35.55	24.86	45.74	35.05	65.58	55.58	-19.84
2	0.19297	10.19	20.10	3.74	30.29	13.93	63.91	53.91	-33.62	-39.98
3	0.26328	10.20	22.25	11.35	32.45	21.55	61.33	51.33	-28.88	-29.78
4	1.42188	10.25	17.66	9.53	27.91	19.78	56.00	46.00	-28.09	-26.22
5	2.76563	10.24	20.86	13.02	31.10	23.26	56.00	46.00	-24.90	-22.74
<b>6</b>	<b>13.78906</b>	<b>10.93</b>	<b>33.96</b>	<b>26.67</b>	<b>44.89</b>	<b>37.60</b>	<b>60.00</b>	<b>50.00</b>	<b>-15.11</b>	<b>-12.40</b>

#### REMARKS:

1. Q.P. and AV. are abbreviations of quasi-peak and average individually.
2. The emission levels of other frequencies were very low against the limit.
3. Margin value = Emission Level – Limit value
4. Correction Factor = Insertion loss + Cable loss
5. Emission Level = Correction Factor + Reading Value

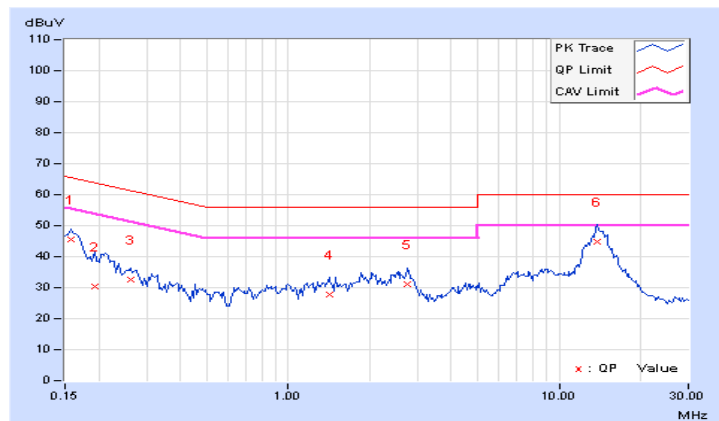



Phase	Neutral (N)	Detector Function	Quasi-Peak (QP) / Average (AV)
-------	-------------	-------------------	--------------------------------

No	Freq. [MHz]	Corr.	Reading Value		Emission Level		Limit		Margin	
		Factor	[dB (uV)]		[dB (uV)]		[dB (uV)]		(dB)	
	(dB)	Q.P.	AV.	Q.P.	AV.	Q.P.	AV.	Q.P.	AV.	
1	0.15000	10.18	27.73	9.34	37.91	19.52	66.00	56.00	-28.09	-36.48
2	0.19687	10.16	20.58	3.68	30.74	13.84	63.74	53.74	-33.00	-39.90
3	0.31016	10.19	17.60	1.94	27.79	12.13	59.97	49.97	-32.18	-37.84
4	2.92578	10.22	17.49	9.49	27.71	19.71	56.00	46.00	-28.29	-26.29
5	6.69141	10.31	18.64	13.08	28.95	23.39	60.00	50.00	-31.05	-26.61
6	13.46094	10.76	31.81	23.79	42.57	34.55	60.00	50.00	-17.43	-15.45

**REMARKS:**

1. Q.P. and AV. are abbreviations of quasi-peak and average individually.
2. The emission levels of other frequencies were very low against the limit.
3. Margin value = Emission Level – Limit value
4. Correction Factor = Insertion loss + Cable loss
5. Emission Level = Correction Factor + Reading Value

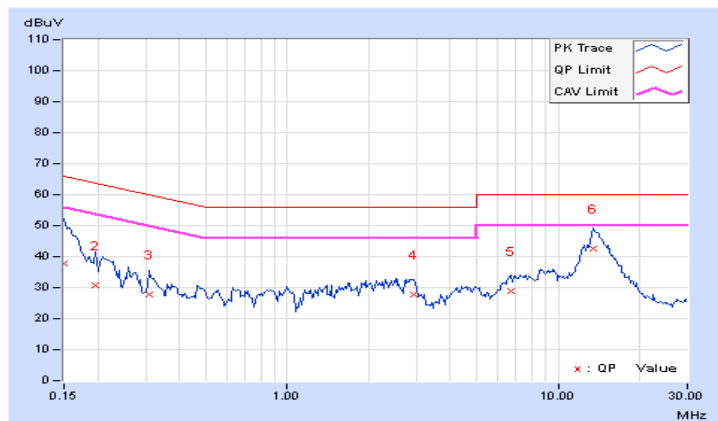

### 4.3 6dB Bandwidth Measurement

#### 4.3.1 Limits of 6dB Bandwidth Measurement

The minimum of 6dB Bandwidth Measurement is 0.5 MHz.

#### 4.3.2 Test Setup

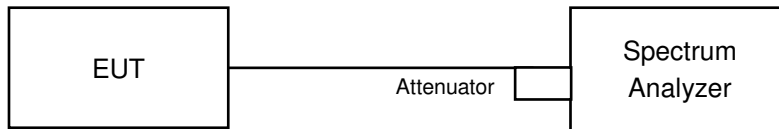

#### 4.3.3 Test Instruments

Refer to section 4.1.2 to get information of above instrument.

#### 4.3.4 Test Procedures

- a. Set resolution bandwidth (RBW) = 100kHz
- b. Set the video bandwidth (VBW)  $\geq 3 \times$  RBW, Detector = Peak.
- c. Trace mode = max hold.
- d. Sweep = auto couple.
- e. Measure the maximum width of the emission that is constrained by the frequencies associated with the two amplitude points (upper and lower) that are attenuated by 6 dB relative to the maximum level measured in the fundamental emission

#### 4.3.5 Deviation from Test Standard

No deviation.

#### 4.3.6 EUT Operating Conditions

The software provided by client to enable the EUT under transmission condition continuously at lowest, middle and highest channel frequencies individually.



## 4.4 Conducted Output Power Measurement

### 4.4.1 Limits of Conducted Output Power Measurement

For systems using digital modulation in the 2400–2483.5 MHz bands: 1 Watt (30dBm)

### 4.4.2 Test Setup

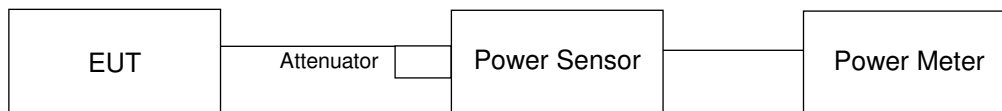

### 4.4.3 Test Instruments

Refer to section 4.1.2 to get information of above instrument.

### 4.4.4 Test Procedures

The peak / average power sensor was used on the output port of the EUT. A power meter was used to read the response of the peak / average power sensor. Record the power level.

### 4.4.5 Deviation from Test Standard

No deviation.

### 4.4.6 EUT Operating Conditions

Same as Item 4.3.6.

#### 4.4.7 Test Results

##### FOR PEAK POWER

Channel	Frequency (MHz)	Peak Power (mW)	Peak Power (dBm)	Limit (dBm)	Pass/Fail
15	2425	2.588	4.13	30	Pass
20	2450	2.576	4.11	30	Pass
25	2475	2.57	4.10	30	Pass

##### FOR AVERAGE POWER

Channel	Frequency (MHz)	Average Power (mW)	Average Power (dBm)
15	2425	2.371	3.75
20	2450	2.36	3.73
25	2475	2.35	3.71

## 4.5 Power Spectral Density Measurement

### 4.5.1 Limits of Power Spectral Density Measurement

The Maximum of Power Spectral Density Measurement is 8dBm.

### 4.5.2 Test Setup

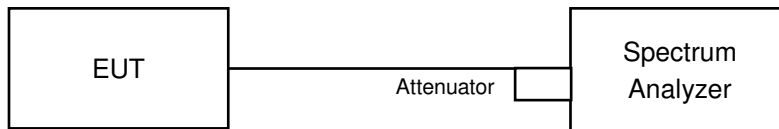

### 4.5.3 Test Instruments

Refer to section 4.1.2 to get information of above instrument.

### 4.5.4 Test Procedures

- a. Set analyzer center frequency to DTS channel center frequency.
- b. Set the span to 1.5 times the DTS bandwidth.
- c. Set the RBW to:  $3 \text{ kHz} \leq \text{RBW} \leq 100 \text{ kHz}$ .
- d. Set the VBW  $\geq 3 \times \text{RBW}$ .
- e. Detector = peak.
- f. Sweep time = auto couple.
- g. Trace mode = max hold.
- h. Allow trace to fully stabilize.
- i. Use the peak marker function to determine the maximum amplitude level within the RBW.

### 4.5.5 Deviation from Test Standard

No deviation.

### 4.5.6 EUT Operating Conditions

Same as Item 4.3.6.

#### 4.5.7 Test Results

Channel	Frequency (MHz)	PSD (dBm/3kHz)	Limit (dBm/3kHz)	Pass /Fail
15	2425	-12.56	8	Pass
20	2450	-12.79	8	Pass
25	2475	-12.69	8	Pass

Spectrum Plot of Worst Value

CH15

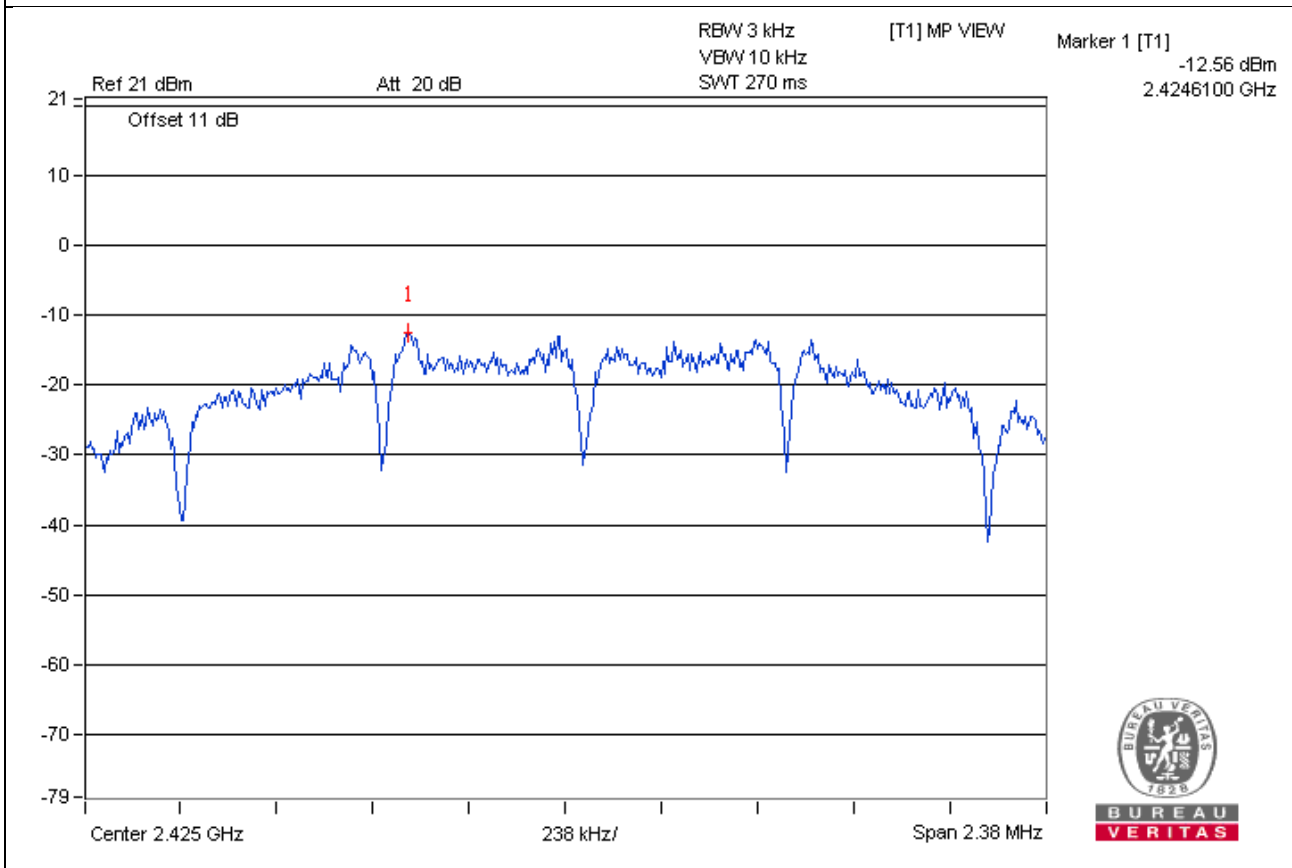

## 4.6 Conducted Out of Band Emission Measurement

### 4.6.1 Limits of Conducted Out of Band Emission Measurement

Below 20dB of the highest emission level of operating band (in 100kHz Resolution Bandwidth).

### 4.6.2 Test Setup

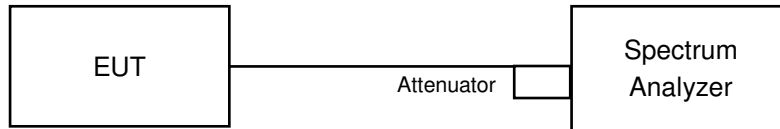

### 4.6.3 Test Instruments

Refer to section 4.3.3 to get information of above instrument.

### 4.6.4 Test Procedures

#### MEASUREMENT PROCEDURE REF

1. Set the RBW = 100 kHz.
2. Set the VBW  $\geq$  300 kHz.
3. Detector = peak.
4. Sweep time = auto couple.
5. Trace mode = max hold.
6. Allow trace to fully stabilize.
7. Use the peak marker function to determine the maximum power level in any 100 kHz band segment within the fundamental EBW.

#### MEASUREMENT PROCEDURE OOB

1. Set RBW = 100 kHz.
2. Set VBW  $\geq$  300 kHz.
3. Detector = peak.
4. Sweep = auto couple.
5. Trace Mode = max hold.
6. Allow trace to fully stabilize.
7. Use the peak marker function to determine the maximum amplitude level.

### 4.6.5 Deviation from Test Standard

No deviation.

### 4.6.6 EUT Operating Conditions

Same as Item 4.3.6

### 4.6.7 Test Results

The spectrum plots are attached on the following pages. D1 line indicates the highest level, and D2 line indicates the 20dB offset below D1. It shows compliance with the requirement.



### CH 15

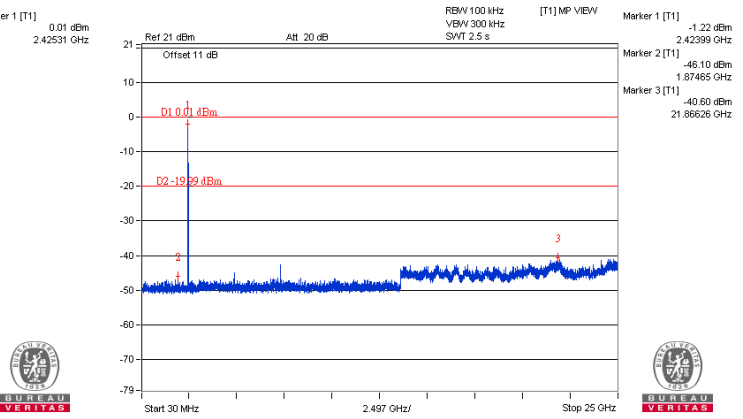
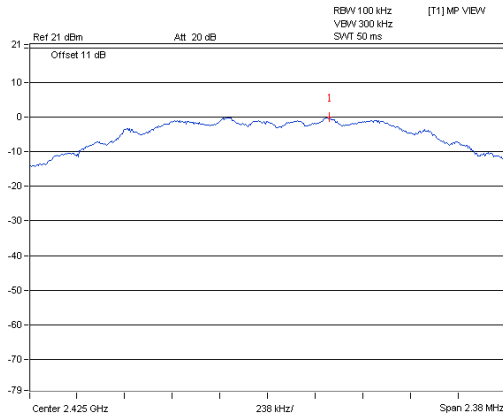

### CH 20

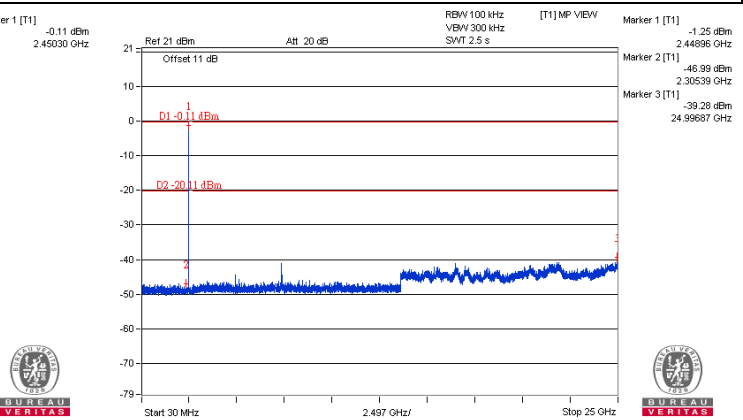
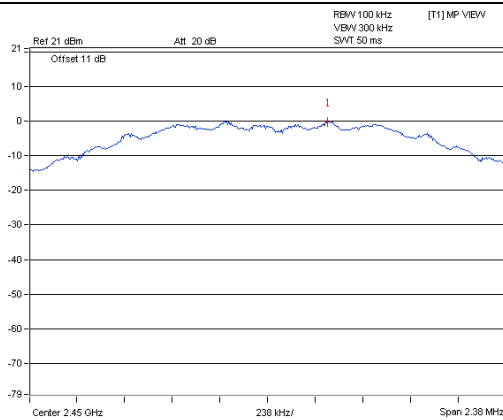

### CH 25

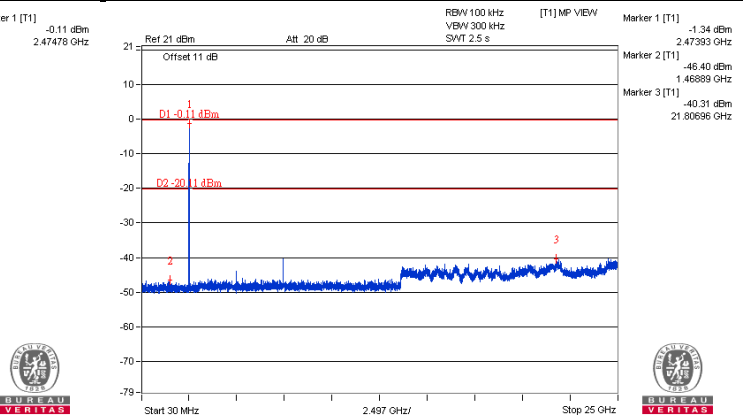
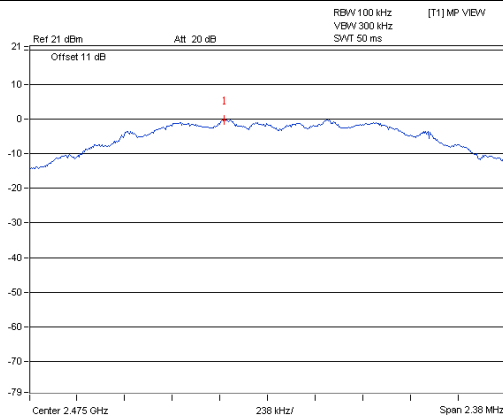

### CH 15 Band edge

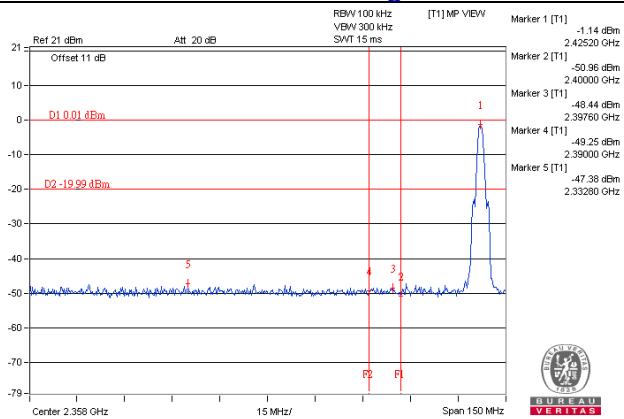

### CH 25 Band edge

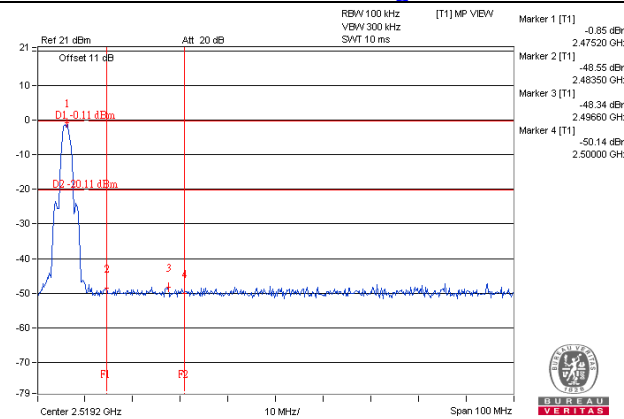

## 5 Pictures of Test Arrangements

Please refer to the attached file (Test Setup Photo).

## Appendix – Information on the Testing Laboratories

We, Bureau Veritas Consumer Products Services (H.K.) Ltd., Taoyuan Branch, were founded in 1988 to provide our best service in EMC, Radio, Telecom and Safety consultation. Our laboratories are accredited and approved according to ISO/IEC 17025.

If you have any comments, please feel free to contact us at the following:

### Linko EMC/RF Lab

Tel: 886-2-26052180

Fax: 886-2-26051924

### Hsin Chu EMC/RF/Telecom Lab

Tel: 886-3-6668565

Fax: 886-3-6668323

### Hwa Ya EMC/RF/Safety Lab

Tel: 886-3-3183232

Fax: 886-3-3270892

**Email:** [service.adt@tw.bureauveritas.com](mailto:service.adt@tw.bureauveritas.com)

**Web Site:** [www.bureauveritas-adt.com](http://www.bureauveritas-adt.com)

The address and road map of all our labs can be found in our web site also.

--- END ---