



**FCC 47 CFR PART 15 SUBPART E &
INDUSTRY CANADA RSS-210**

TEST REPORT

For

Tablet Computer

Model: WT8PE-B

Trade Name: TOSHIBA

Issued to

Pegatron Corporation
5F, NO. 76, LIGONG ST., BEITOU DISTRICT,
TAIPEI CITY 112, TAIWAN (R.O.C.)

Issued by

Compliance Certification Services Inc.
No.11, Wugong 6th Rd., Wugu Dist.,
New Taipei City 24891, Taiwan. (R.O.C.)
<http://www.ccsrf.com>
service@ccsrf.com
Issued Date: August 8, 2014



Testing Laboratory
1309

Note: This report shall not be reproduced except in full, without the written approval of Compliance Certification Services Inc. This document may be altered or revised by Compliance Certification Services Inc. personnel only, and shall be noted in the revision section of the document.



Revision History

Rev.	Issue Date	Revisions	Effect Page	Revised By
00	August 8, 2014	Initial Issue	ALL	Kelly Cheng



TABLE OF CONTENTS

1. TEST RESULT CERTIFICATION.....	4
2. EUT DESCRIPTION	5
3. TEST METHODOLOGY	7
3.1 EUT CONFIGURATION	7
3.2 EUT EXERCISE	7
3.3 GENERAL TEST PROCEDURES.....	7
3.4 FCC PART 15.205 RESTRICTED BANDS OF OPERATIONS.....	8
3.5 DESCRIPTION OF TEST MODES.....	9
4. INSTRUMENT CALIBRATION.....	10
4.1 MEASURING INSTRUMENT CALIBRATION	10
4.2 MEASUREMENT EQUIPMENT USED.....	10
4.3 MEASUREMENT UNCERTAINTY.....	11
5. FACILITIES AND ACCREDITATIONS	12
5.1 FACILITIES	12
5.2 EQUIPMENT	12
5.3 LABORATORY ACCREDITATIONS AND LISTING.....	12
5.4 TABLE OF ACCREDITATIONS AND LISTINGS	13
6. SETUP OF EQUIPMENT UNDER TEST	14
6.1 SETUP CONFIGURATION OF EUT	14
6.2 SUPPORT EQUIPMENT	14
7. APPLICABLE RULES	15
8. FCC PART 15 REQUIREMENTS & RSS 210 REQUIREMENTS	24
8.1 99% BANDWIDTH.....	24
8.2 26 DB EMISSION BANDWIDTH	39
8.3 MAXIMUM CONDUCTED OUTPUT POWER	55
8.4 BAND EDGES MEASUREMENT	61
8.5 PEAK POWER SPECTRAL DENSITY	74
8.6 RADIATED UNDESIRABLE EMISSION.....	91
8.7 POWERLINE CONDUCTED EMISSIONS	121
8.8 FREQUENCY STABILITY	124
8.9 DYNAMIC FREQUENCY SELECTION.....	150
APPENDIX I PHOTOGRAPHS OF TEST SETUP	189



1. TEST RESULT CERTIFICATION

Applicant: Pegatron Corporation
 5F, NO. 76, LIGONG ST., BEITOU DISTRICT, TAIPEI CITY 112,
 TAIWAN (R.O.C.)

Manufacturer: Toshiba Corporation
 1-1, Shibaura 1-Chome, Minato-Ku, Tokyo, 105-8001, Japan

Equipment Under Test: Tablet Computer

Trade Name: TOSHIBA

Model: WT8PE-B

Date of Test: July 28 ~ August 3, 2014

APPLICABLE STANDARDS	
STANDARD	TEST RESULT
FCC 47 CFR Part 15 Subpart E & Industry Canada RSS-210 Issue 8 <small>December, 2010</small>	No non-compliance noted

We hereby certify that:

Compliance Certification Services Inc. tested the above equipment. The test data, data evaluation, test procedures, and equipment configurations shown in this report were made in accordance with the procedures given in **ANSI C63.4: 2009** and the energy emitted by the sample EUT tested as described in this report is in compliance with conducted and radiated emission limits of FCC Rules Part 15.407 and Industry Canada RSS-210 Issue 8.

The test results of this report relate only to the tested sample identified in this report.

Approved by:

Reviewed by:

Miller Lee
 Section Manager
 Compliance Certification Services Inc.

Angel Cheng
 Section Manager
 Compliance Certification Services Inc.



2. EUT DESCRIPTION

Product	Tablet Computer				
Trade Name	TOSHIBA				
Model Number	WT8PE-B				
Model Discrepancy	N/A				
Received Date	July 21, 2014				
Power Supply	<p>1. VDC from Power Adapter Chicony / W12-010N3A I/P: 100-240V~ 50/60Hz, 0.3A O/P: 5VDC, 2A</p> <p>2. Powered from host device via USB cable.</p> <p>3. Power from Battery LG (Trademark: Toshiba) / PA5203U-1BRS Rating: 3.78V, 14Wh, 3788mAhc</p>				
Operating Frequency Range & Number of Channels		Mode	Frequency Range (MHz)	Number of Channels	
	UNII Band I	IEEE 802.11a	5180 – 5240	4 Channels	
		IEEE 802.11n HT 20 MHz	5180 – 5240	4 Channels	
		IEEE 802.11n HT 40 MHz	5190 ~ 5230	2 Channels	
	UNII Band II	IEEE 802.11a	5260 - 5320	4 Channels	
		IEEE 802.11n HT 20 MHz	5260 - 5320	4 Channels	
		IEEE 802.11n HT 40 MHz	5270 - 5310	2 Channels	
	UNII Band III	IEEE 802.11a	5500 - 5700	11 Channels	
		IEEE 802.11n HT 20 MHz	5500 – 5700	11 Channels	
		IEEE 802.11n HT 40 MHz	5510 - 5670	5 Channels	
Transmit Power		Mode	Frequency Range (MHz)	Output Power (dBm)	Output Power (W)
	UNII Band I	IEEE 802.11a	5180 – 5240	11.50	0.0141
		IEEE 802.11n HT 20 MHz	5180 – 5240	11.40	0.0138
		IEEE 802.11n HT 40 MHz	5190 ~ 5230	9.70	0.0093
	UNII Band II	IEEE 802.11a	5260 - 5320	11.40	0.0138
		IEEE 802.11n HT 20 MHz	5260 - 5320	11.20	0.0132
		IEEE 802.11n HT 40 MHz	5270 - 5310	9.50	0.0089
	UNII Band III	IEEE 802.11a	5500 - 5700	11.30	0.0135
		IEEE 802.11n HT 20 MHz	5500 – 5700	11.20	0.0132
		IEEE 802.11n HT 40 MHz	5510 - 5670	9.60	0.0091
Modulation Technique	OFDM (QPSK, BPSK, 16-QAM, 64-QAM)				
Transmit Data Rate	<p>IEEE 802.11a mode: 54, 48, 36, 24, 18, 12, 9, 6 Mbps</p> <p>IEEE 802.11n HT 20 MHz: OFDM (6.5, 7.2, 13, 14.4, 14.44, 19.5, 21.7, 26, 28.89, 28.9, 39, 43.3, 43.33 52, 57.78, 57.8, 58.5, 65.0, 72.2, 78, 86.67, 104, 115.56, 117, 130, 144.44 Mbps)</p> <p>IEEE 802.11n HT 40 MHz: OFDM (13.5, 15, 27, 30, 40.5, 45, 54, 60, 81, 90, 108, 120, 121.5, 135, 150, 162, 180, 216, 240, 243, 270, 300 Mbps)</p>				
Antenna Specification	YAGEO P/N: ANT1003LL15R2455A / Gain 0.8dBi				
Antenna Designation	Chip Antenna				
Accessory	TOSHIBA / WACOM AES stylus with 1 side switch				



Operation Frequency:

UNLICENSED NATIONAL INFORMATION INFRASTRUCTURE (U-NII)	
CHANNEL	MHz
36	5180
38	5190
40	5200
44	5220
46	5230
48	5240
52	5260
54	5270
56	5280
60	5300
62	5310
64	5320
100	5500
102	5510
104	5520
108	5540
110	5550
112	5560
116	5580
118	5590
120	5600
124	5620
126	5630
128	5640
132	5660
134	5670
136	5680
140	5700
149	5745
153	5765
157	5785
161	5805
165	5825

Remark: The sample selected for test was engineering sample that approximated to production product and was provided by manufacturer.



3. TEST METHODOLOGY

Both conducted and radiated testing was performed according to the procedures in ANSI C63.4: 2009 Radiated testing was performed at an antenna to EUT distance 3 meters.

The tests documented in this report were performed in accordance with ANSI C63.4: 2009 and FCC CFR 47 Part 15.207, 15.209 and 15.407, UNII: KDB 789033 D02, KDB 905462 D06, DFS: KDB 905462 D02/D03, RSS-GEN Issue 2, and RSS-210 Issue 8.

3.1 EUT CONFIGURATION

The EUT configuration for testing is installed for RF field strength measurement to meet the Commissions requirement, and is operated in a manner intended to generate the maximum emission in a continuous normal application.

3.2 EUT EXERCISE

The EUT is operated in the engineering mode to fix the Tx frequency for the purposes of measurement.

According to its specifications, the EUT must comply with the requirements of Section 15.407 under the FCC Rules Part 15 Subpart E.

3.3 GENERAL TEST PROCEDURES

Conducted Emissions

The EUT is placed on the turntable, which is positioned at 0.8 m above the ground plane. According to the requirements in Section 13.1.4.1 of ANSI C63.4, the conducted emission from the EUT is measured in the frequency range between 0.15 MHz and 30MHz, using the CISPR Quasi-Peak detector mode.

Radiated Emissions

The EUT is placed on the turntable, which is 0.8 m above the ground plane. The turntable is then rotated for 360 degrees to determine the proper orientation for the maximum emission level. The EUT is set 3m away from the receiving antenna, which is varied from 1m to 4m to find out the highest emission level. And, each emission is to be maximized by changing the horizontal and vertical polarization of the receiving antenna. In order to find out the maximum emissions, exploratory radiated emission measurements were made according to the requirements in Section 13.1.4.1 of ANSI C63.4: 2003.



3.4 FCC PART 15.205 RESTRICTED BANDS OF OPERATIONS

(a) Except as shown in paragraph (d) of this section, only spurious emissions are permitted in any of the frequency bands listed below:

MHz	MHz	MHz	GHz
0.090 - 0.110	16.42 - 16.423	399.9 - 410	4.5 - 5.15
¹ 0.495 - 0.505	16.69475 - 16.69525	608 - 614	5.35 - 5.46
2.1735 - 2.1905	16.80425 - 16.80475	960 - 1240	7.25 - 7.75
4.125 - 4.128	25.5 - 25.67	1300 - 1427	8.025 - 8.5
4.17725 - 4.17775	37.5 - 38.25	1435 - 1626.5	9.0 - 9.2
4.20725 - 4.20775	73 - 74.6	1645.5 - 1646.5	9.3 - 9.5
6.215 - 6.218	74.8 - 75.2	1660 - 1710	10.6 - 12.7
6.26775 - 6.26825	108 - 121.94	1718.8 - 1722.2	13.25 - 13.4
6.31175 - 6.31225	123 - 138	2200 - 2300	14.47 - 14.5
8.291 - 8.294	149.9 - 150.05	2310 - 2390	15.35 - 16.2
8.362 - 8.366	156.52475 -	2483.5 - 2500	17.7 - 21.4
8.37625 - 8.38675	156.52525	2655 - 2900	22.01 - 23.12
8.41425 - 8.41475	156.7 - 156.9	3260 - 3267	23.6 - 24.0
12.29 - 12.293	162.0125 - 167.17	3332 - 3339	31.2 - 31.8
12.51975 - 12.52025	167.72 - 173.2	3345.8 - 3358	36.43 - 36.5
12.57675 - 12.57725	240 - 285	3600 - 4400	(²)
13.36 - 13.41	322 - 335.4		

¹ Until February 1, 1999, this restricted band shall be 0.490-0.510 MHz.

² Above 38.6

(b) Except as provided in paragraphs (d) and (e), the field strength of emissions appearing within these frequency bands shall not exceed the limits shown in Section 15.209. At frequencies equal to or less than 1000 MHz, compliance with the limits in Section 15.209 shall be demonstrated using measurement instrumentation employing a CISPR quasi-peak detector. Above 1000 MHz, compliance with the emission limits in Section 15.209 shall be demonstrated based on the average value of the measured emissions. The provisions in Section 15.35 apply to these measurements.



3.5 DESCRIPTION OF TEST MODES

The EUT (Model: WT8PE-B) had been tested under operating condition.

The EUT is a 1x1 configuration spatial MIMO (1Tx & 1Rx) without beam forming function. The 1x1 configuration is implemented with three outside TX & RX chains

Software used to control the EUT for staying in continuous transmitting mode was programmed.

After verification, all tests were carried out with the worst case test modes as shown below except radiated spurious emission below 1GHz, which worst case was in normal link mode only.

UNII Band I:

IEEE 802.11a for 5180 ~ 5240MHz:

Channel Low (5180MHz), Channel Mid (5220MHz) and Channel High (5240MHz) with 6Mbps data rate were chosen for full testing.

IEEE 802.11n HT 20 MHz for 5180 ~ 5240MHz:

Channel Low (5180MHz), Channel Mid (5220MHz) and Channel High (5240MHz) with 6.5Mbps data rate were chosen for full testing.

IEEE 802.11n HT 40 MHz Channel for 5190 ~ 5230MHz:

Channel Low (5190MHz) and Channel High (5230MHz) with 13.5Mbps data rate were chosen for full testing.

UNII Band II:

IEEE 802.11a for 5260 ~ 5320MHz:

Channel Low (5260MHz), Channel Mid (5280MHz) and Channel High (5320MHz) with 6Mbps data rate were chosen for full testing.

IEEE 802.11n HT 20 MHz for 5260 ~ 5320MHz:

Channel Low (5260MHz), Channel Mid (5280MHz) and Channel High (5320MHz) with 6.5Mbps data rate were chosen for full testing.

IEEE 802.11n HT 40 MHz for 5270 ~ 5310MHz:

Channel Low (5270MHz) and Channel High (5310MHz) with 13.5Mbps data rate were chosen for full testing.

UNII Band III:

IEEE 802.11a for 5500 ~ 5700MHz:

Channel Low (5500MHz), Channel Mid (MHz) and Channel High (5700MHz) with 6Mbps data rate were chosen for full testing.

IEEE 802.11n HT 20 MHz for 5500 ~ 5700MHz:

Channel Low (5500MHz), Channel Mid (5580MHz) and Channel High (5700MHz) with 6.5Mbps data rate were chosen for full testing.

IEEE 802.11n HT 40 MHz for 5510 ~ 5670MHz:

Channel Low (5510MHz), Channel Mid (5550MHz) and Channel High (5670MHz) with 13.5Mbps data rate were chosen for full testing.

The field strength of spurious emission was measured in the following position: EUT stand-up position (Z axis), lie-down position (X, Y axis). The worst emission was found in lie-down position (Z axis) and the worst case was recorded.



4. INSTRUMENT CALIBRATION

4.1 MEASURING INSTRUMENT CALIBRATION

The measuring equipment, which was utilized in performing the tests documented herein, has been calibrated in accordance with the manufacturer's recommendations for utilizing calibration equipment, which is traceable to recognized national standards.

4.2 MEASUREMENT EQUIPMENT USED

Equipment Used for Emissions Measurement

Remark: Each piece of equipment is scheduled for calibration once a year and Loop Antenna is scheduled for calibration once three years.

Conducted Emissions Test Site				
Name of Equipment	Manufacturer	Model	Serial Number	Calibration Due
Spectrum Analyzer	Agilent	E4446A	MY43360131	03/19/2015
Power Meter	Anritsu	ML2495A	1012009	06/03/2015
Power Sensor	Anritsu	MA2411A	0917072	06/03/2015

3M Chamber Test Site				
Name of Equipment	Manufacturer	Model	Serial Number	Calibration Due
Spectrum Analyzer	Agilent	E4446A	US42510268	11/05/2014
EMI Test Receiver	R&S	ESCI	100064	02/27/2015
Pre-Amplifier	Mini-Circuits	ZFL-1000LN	SF350700823	01/11/2015
Pre-Amplifier	MITEQ	AFS44-00102650-42-10P-44	1415367	11/18/2014
Bilog Antenna	Sunol Sciences	JB3	A030105	10/01/2014
Horn Antenna	EMCO	3117	00055165	02/12/2015
Horn Antenna	EMCO	3116	2487	10/09/2014
Loop Antenna	EMCO	6502	8905/2356	06/08/2015
Turn Table	CCS	CC-T-1F	N/A	N.C.R
Antenna Tower	CCS	CC-A-1F	N/A	N.C.R
Controller	CCS	CC-C-1F	N/A	N.C.R
Site NSA	CCS	N/A	N/A	12/21/2014
Test S/W	EZ-EMC (CCS-3A1RE)			

Conducted Emission room # A				
Name of Equipment	Manufacturer	Model	Serial Number	Calibration Due
EMI Test Receiver	R&S	ESI	101203	09/12/2014
LISN	R&S	ESH3-Z5	848773/014	12/05/2014
Coaxial Cable	Commate	CFD300-NL	NA	12/05/2014
Test S/W	CCS-3A1-CE			



Dynamic Frequency Selection				
Name of Equipment	Manufacturer	Model	Serial Number	Calibration Due
Vector Signal Generator	R&S	SMU 200A	101480	12/04/2014
Spectrum Analyzer	R&S	FSU	100258	09/03/2014

4.3 MEASUREMENT UNCERTAINTY

PARAMETER	UNCERTAINTY
Powerline Conducted Emission	+/- 1.2159
3M Semi Anechoic Chamber / 30M~200M	+/- 4.0138
3M Semi Anechoic Chamber / 200M~1000M	+/- 3.9483
3M Semi Anechoic Chamber / 1G~8G	+/- 2.5975
3M Semi Anechoic Chamber / 8G~18G	+/- 2.6112
3M Semi Anechoic Chamber / 18G~26G	+/- 2.7389
3M Semi Anechoic Chamber / 26G~40G	+/- 2.9683

Remark: This uncertainty represents an expanded uncertainty expressed at approximately the 95% confidence level using a coverage factor of $k=2$.



5. FACILITIES AND ACCREDITATIONS

5.1 FACILITIES

All measurement facilities used to collect the measurement data are located at

No.199, Chunghsen Road, Hsintien City, Taipei Hsien, Taiwan, R.O.C.
Tel: 886-2-2217-0894 / Fax: 886-2-2217-1029

No.11, Wugong 6th Rd., Wugu Dist., New Taipei City 24891, Taiwan. (R.O.C.)
Tel: 886-2-2299-9720 / Fax: 886-2-2298-4045

No.81-1, Lane 210, Bade 2nd Rd., Luchu Hsiang, Taoyuan Hsien 338, Taiwan
Tel: 886-3-324-0332 / Fax: 886-3-324-5235

The sites are constructed in conformance with the requirements of ANSI C63.7, ANSI C63.4 and CISPR Publication 22.

5.2 EQUIPMENT

Radiated emissions are measured with one or more of the following types of linearly polarized antennas: tuned dipole, biconical, log periodic, bi-log, and/or ridged waveguide, horn. Spectrum analyzers with pre-selectors and quasi-peak detectors are used to perform radiated measurements.

Conducted emissions are measured with Line Impedance Stabilization Networks and EMI Test Receivers.

Calibrated wideband preamplifiers, coaxial cables, and coaxial attenuators are also used for making measurements.



All receiving equipment conforms to CISPR Publication 16-1, "Radio Interference Measuring Apparatus and Measurement Methods."

5.3 LABORATORY ACCREDITATIONS AND LISTING

The test facilities used to perform radiated and conducted emissions tests are accredited by American Association for Laboratory Accreditation Program for the specific scope accreditation under Lab Code: 0824-01 to perform Electromagnetic Interference tests according to FCC Part 15 and CISPR 22 requirements. In addition, the test facilities are listed with Industry Canada, Certification and Engineering Bureau, IC 2324G-1 for 3M Semi Anechoic Chamber A, 2324G-2 for 3M Semi Anechoic Chamber B.



5.4 TABLE OF ACCREDITATIONS AND LISTINGS

Country	Agency	Scope of Accreditation	Logo
USA	FCC	3M Semi Anechoic Chamber (FCC MRA: TW1039) to perform FCC Part 15 measurements	 FCC MRA: TW1039
Taiwan	TAF	LP0002, RTTE01, FCC Method-47 CFR Part 15 Subpart C, D, E, RSS-210, RSS-310 IDA TS SRD, AS/NZS 4268, AS/NZS 4771, TS 12.1 & 12.2, ETSI EN 300 440-1, ETSI EN 300 440-2, ETSI EN 300 328, ETSI EN 300 220-1, ETSI EN 300 220-2, ETSI EN 301 893, ETSI EN 301 489-1/3/7/17 FCC OET Bulletin 65 + Supplement C, EN 50360, EN 50361, EN 50371, RSS 102, EN 50383, EN 50385, EN 50392, IEC 62209, CNS 14958-1, CNS 14959 FCC Method -47 CFR Part 15 Subpart B IEC / EN 61000-3-2, IEC / EN 61000-3-3, IEC / EN 61000-4-2/3/4/5/6/8/11	 Testing Laboratory 1309
Canada	Industry Canada	3M Semi Anechoic Chamber (IC 2324G-1 / IC 2324G-2) to perform	 IC 2324G-1 IC 2324G-2

* No part of this report may be used to claim or imply product endorsement by A2LA or any agency of the US Government.



6. SETUP OF EQUIPMENT UNDER TEST

6.1 SETUP CONFIGURATION OF EUT

See test photographs attached in Appendix I for the actual connections between EUT and support equipment.

6.2 SUPPORT EQUIPMENT

No.	Device Type	Brand	Model	Series No.	FCC ID	Data Cable	Power Cord
1	Notebook PC	HP	dv6-1332TX	CNF9491GPS	PD9112BNHU	N/A	AC I/P: Unshielded, 1.8m DC O/P: Unshielded, 1.8m with a core
2	LCD Monitor	samsung	E1720NR	YDSHVEZ300001K	N/A	Shielded, 1.8m with 2 cores	Unshielded, 1.8m
3	USB Keyboard	Logitech	Y-U0009	820-003254	N/A	N/A	N/A
4	USB Mouse	Logitech	M-U0026	810-002147	N/A	N/A	N/A
5	Wireless N600 Gigabit	D-Link	DIR-826	QBQ91C6000056	KA2IR826LMO1	N/A	N/A

Remark:

1. All the equipment/cables were placed in the worst-case configuration to maximize the emission during the test.
2. Grounding was established in accordance with the manufacturer's requirements and conditions for the intended use.



7. APPLICABLE RULES

RSS-210 §2 General Certification Requirements and Specifications

RSS-210 §2.1 RSS-Gen Compliance

In addition to RSS-210, the requirements in RSS-Gen, *General Requirements and Information for the Certification of Radio Apparatus*, must be met.

RSS-210 §2.2 Emissions Falling Within Restricted Frequency Bands

Category I licence-exempt equipment is required to comply with the provisions in RSS-Gen with respect to emissions falling within restricted frequency bands. These restricted frequency bands are listed in RSS-Gen.

RSS-210 §2.3 Receivers

Category I equipment receivers for use with transmitters subject to RSS-210 must comply with the applicable requirements set out in RSS-Gen and be certified under RSS-210. Category II equipment receivers for use with transmitters subject to RSS-210 are exempt from certification, but are subject to compliance with RSS-Gen and RSS-310.

RSS-210 §2.5 General Field Strength Limits

RSS-Gen includes the general field strength limits of unwanted emissions, where applicable, for transmitters and receivers operating in accordance with the provisions specified in this standard. Unwanted emissions of transmitters and receivers are permitted to fall within the restricted bands listed in RSS-Gen, and including the TV bands, but fundamental emissions are prohibited in the restricted bands.

RSS-210 §2.5.1 Transmitters with Wanted Emissions that are Within the General Field Strength Limits

Whether or not their operation is addressed by published RSS standards, transmitters whose wanted and unwanted emissions are within the general field strength limits shown in RSS-Gen, they may operate in any of the frequency bands, other than the restricted bands listed in RSS-Gen and including the TV bands, and shall be certified under RSS-210. Under no conditions may the level of any unwanted emissions exceed the level of the fundamental emission.

Note: Devices operating below 490 kHz in which all emissions are at least 40 dB below the limit listed in RSS-Gen (*General Field Strength Limits for Transmitters at Frequencies below 30 MHz*) are Category II devices and are subject to RSS-310.



RSS-210 §2.7 Tables

RSS-210 §Annex 8: Frequency Hopping and Digital Modulation Systems Operating in the 902-928 MHz, 2400-2483.5 MHz, and 5725-5850 MHz Bands

This section applies to systems that employ frequency hopping (FH) and digital modulation technology in the 902-928 MHz, 2400-2483.5 MHz and 5725-5850 MHz bands. Systems in these bands may employ frequency hopping, digital modulation and or a combination (hybrid) of both techniques.

A frequency hopping system that synchronizes with another or several other systems (to avoid frequency collision among them) via off-air sensing or via connecting cables is not hopping randomly and therefore is not in compliance with RSS-210.

RSS-210 §A8.1 Frequency Hopping Systems

Frequency hopping systems are spread spectrum systems in which the carrier is modulated with coded information in a conventional manner causing a conventional spreading of the RF energy about the carrier frequency. The frequency of the carrier is not fixed but changes at fixed intervals under the direction of a coded sequence.

Frequency hopping systems are not required to employ all available hopping frequencies during each transmission. However, the system, consisting of both the transmitter and the receiver, must be designed to comply with all of the regulations in this section should the transmitter be presented with a continuous data (or information) stream.

Incorporation of intelligence into a frequency hopping system that enables it to recognize other users of the band and to avoid occupied frequencies is permitted, provided that the frequency hopping system does it individually, and independently chooses or adapts its hopset. The coordination of frequency hopping systems in any other manner for the express purpose of avoiding the simultaneous occupancy of individual hopping frequencies by multiple transmitters is not permitted.

The following applies to frequency hopping systems in each of the three bands.

(a) The bandwidth of a frequency hopping channel is the 20 dB emission bandwidth, measured with the hopping stopped. The system RF bandwidth is equal to the channel bandwidth multiplied by the number of channels in the hopset. The hopset shall be such that the near term distribution of frequencies appears random, with sequential hops randomly distributed in both direction and magnitude of change in the hopset while the long term distribution appears evenly distributed.



(b) Frequency hopping systems shall have hopping channel carrier frequencies separated by a minimum of 25 kHz or the 20 dB bandwidth of the hopping channel, whichever is greater. Alternatively, frequency hopping systems operating in the 2400-2483.5 MHz band may have hopping channel carrier frequencies that are separated by 25 kHz or two-thirds of the 20 dB bandwidth of the hopping channel, whichever is greater, provided the systems operate with an output power no greater than 0.125 W. The system receivers shall have input bandwidths that match the hopping channel bandwidths of their corresponding transmitters and shall shift frequencies in synchronization with the transmitted signals.

(d) Frequency hopping systems operating in the 2400-2483.5 MHz band shall use at least 15 hopping channels. The average time of occupancy on any channel shall not be greater than 0.4 seconds within a period of 0.4 seconds multiplied by the number of hopping channels employed. Transmissions on particular hopping frequencies may be avoided or suppressed provided that a minimum of 15 hopping channels are used.

RSS-210 §A8.2 Digital Modulation Systems

These include systems employing digital modulation techniques resulting in spectral characteristics similar to direct sequence systems. The following applies to all three bands.

RSS-210 §A8.4 Transmitter Output Power and e.i.r.p. Requirements

(4) For systems employing digital modulation techniques operating in the 902-928 MHz, 2400-2483.5 MHz and 5725-5850 MHz bands, the maximum peak conducted power shall not exceed 1 W. Except as provided in Section A8.4(5), the e.i.r.p. shall not exceed 4 W.

As an alternative to a peak power measurement, compliance can be based on a measurement of the maximum conducted output power (see RSS-Gen)

(5) Point-to-point systems in the bands 2400-2483.5 MHz and 5725-5850 MHz are permitted to have an e.i.r.p. higher than 4 W, provided that the higher e.i.r.p. is achieved by employing higher gain directional antennas and not higher transmitter output powers. Point-to-multipoint systems, omni-directional applications and multiple co-located transmitters transmitting the same information are prohibited from exceeding 4 W e.i.r.p. However, remote stations of point-to-multipoint systems shall be allowed to operate at greater than 4 W e.i.r.p. under the same conditions as for point-to-point systems.

Note: “Fixed, point-to-point operation”, excludes point-to-multipoint systems, omnidirectional applications and multiple co-located transmitters transmitting the same information.



RSS-210 §A8.5 Out-of-band Emissions

In any 100 kHz bandwidth outside the frequency band in which the spread spectrum or digitally modulated device is operating, the radio frequency power that is produced shall be at least 20 dB below that in the 100 kHz bandwidth within the band that contains the highest level of the desired power, based on either an RF conducted or a radiated measurement, provided the transmitter demonstrates compliance with the peak conducted power limits. If the transmitter complies with the conducted power limits based on the use of RMS averaging over a time interval, as permitted under section A8.4(4), the attenuation required shall be 30 dB instead of 20 dB. Attenuation below the general limits specified in Tables 2 and 3 is not required.

RSS-Gen §2 General Information

RSS-Gen §2.1.2 Category II Equipment

Category II equipment comprises radio devices where a standard has been prescribed but for which a TAC is not required, that is, equipment certification by Industry Canada or a Certification Body (CB) is not required (certification exempt), pursuant to subsection 4(3) of the Radiocommunication Act. The manufacturer or importer shall nevertheless ensure that the standards are complied with. A test report shall be available on request and the device shall be properly labelled.

RSS-Gen §2.2 Receivers

Receivers that are used for radiocommunication other than broadcasting are defined as Category I equipment or Category II equipment, subject to compliance with applicable Industry Canada standards.

Receivers shall be capable of operation only with transmitters for which RSSs are published. Receivers are classified as described in sections 2.2.1 and 2.2.2.

RSS-Gen §2.2.1 Category I Equipment Receivers

A receiver is classified as Category I equipment if it meets one of the following conditions:

- (a) a stand-alone receiver (see Note 1, below), which operates on any frequency in the band 30-960 MHz, and is used for the reception of signals in that frequency band from a transmitter classified as Category I equipment;
- (b) a Citizen's Band (CB) receiver (26.96-27.410 MHz);
- (c) a scanner receiver.

Note 1: A *stand-alone receiver* is defined as any receiver that is not permanently combined together with a transmitter in a single case (transceiver), in which it functions as the receiver component of the transceiver.

Receivers classified as Category I equipment shall comply with the limits for receiver spurious emissions set out in RSS-Gen; however, equipment certification is granted under the applicable RSS standard along with the associated transmitter classified as Category I equipment. Scanner receivers are covered under their own specific RSS.

RSS-Gen §2.2.2 Category II Equipment Receivers

A receiver is classified as Category II equipment if it does not meet any of the conditions of Section 2.2.1.

Category II receivers shall comply with the applicable testing, labelling and user manual requirements in RSS-310.



RSS-Gen §5.6 Exposure of Humans to RF Fields

Category I and Category II equipment shall comply with the applicable requirements of RSS-102.

RSS-Gen §6 Receiver Spurious Emission Standard

Receivers shall comply with the limits of spurious emissions set out in this section, measured over the frequency range determined in accordance with Section 4.10.

RSS-Gen §6.1 Radiated Limits

Radiated spurious emission measurements shall be performed with the receiver antenna connected to the receiver antenna terminals.

Spurious emissions from receivers shall not exceed the radiated limits shown in the table below:

RSS-Gen Table 2 - Spurious Emission Limits for Receivers

Frequency (MHz)	Field Strength microvolts/m at 3 metres
30-88	100
88-216	150
216-960	200
Above 960	500

*Measurements for compliance with limits in the above table may be performed at distances other than 3 metres, in accordance with Section 7.2.7.



RSS- Gen Table 3: Restricted Frequency Bands ^(Note)

MHz	MHz	MHz	MHz	GHz
0.090-0.110	8.37625-8.38675	--	1718.8-1722.2	9.0-9.2
--	8.41425-8.41475	156.52475-156.52525	2200-2300	9.3-9.5
2.1735-2.1905	12.29-12.293	156.7-156.9	2310-2390	10.6-12.7
3.020-3.026	12.51975-12.52025	--	--	13.25-13.4
4.125-4.128	12.57675-12.57725	--	2655-2900	14.47-14.5
4.17725-4.17775	13.36-13.41	240-285	3260-3267	15.35-16.2
4.20725-4.20775	16.42-16.423	322-335.4	3332-3339	17.7-21.4
5.677-5.683	16.69475-16.69525	399.9-410	3345.8-3358	22.01-23.12
6.215-6.218	16.80425-16.80475	608-614	3500-4400	23.6-24.0
6.26775-6.26825	25.5-25.67	960-1427	4500-5150	31.2-31.8
6.31175-6.31225	37.5-38.25	1435-1626.5	5350-5460	36.43-36.5
8.291-8.294	73-74.6; 74.8-75.2	1645.5-1646.5	7250-7750	Above 38.6
8.362-8.366	108-138	1660-1710	8025-8500	

Note: Certain frequency bands listed in Table 2 and above 38.6 GHz are designated for low-power licence-exempt applications. These frequency bands and the requirements that apply to the devices are set out in this Standard as well as RSS-310.

RSS- Gen Table 5: General Field Strength Limits for Transmitters at Frequencies Above 30 MHz

Frequency (MHz)	Field Strength (microvolt/m at 3 metres)
30-88	100
88-216	150
216-960	200
Above 960	500

Note: Transmitting devices are not permitted in Table 1 bands or, unless stated otherwise, in TV bands(54-72 MHz, 76-88 MHz, 174-216 MHz, 470-608 MHz and 614-806 MHz).



RSS- Gen Table 6: General Field Strength Limits for Transmitters at Frequencies Below 30 MHz (Transmit)

Frequency (fundamental or spurious)	Field Strength (microvolts/m)	Magnetic H-Field (microamperes/m)	Measurement Distance (metres)
9-490 kHz	2,400/F (F in kHz)	2,400/377F (F in Hz)	300
490-1.705 kHz	24,000/F (F in kHz)	24,000/377F (F in kHz)	30
1.705-30 MHz	30	N/A	30

Note: The emission limits for the bands 9-90 kHz and 110-490 kHz are based on measurements employing an average detector.



RSS-Gen §7.1.2 Transmitter Antenna

A transmitter can only be sold or operated with antennas with which it was approved. Transmitter may be approved with multiple antenna types. An antenna type comprises antennas having similar in-band and out-of-band radiation patterns. Testing shall be performed using the highest gain antenna of each combination of transmitter and antenna type for which approval is being sought, with the transmitter output power set at the maximum level. Any antenna of the same type having equal or lesser gain as an antenna that had been successfully tested with the transmitter, will also be considered approved with the transmitter, and may be used and marketed with the transmitter. For Category I transmitters, the manufacturer shall include with the application for certification a list of acceptable antenna types to be used with the transmitter.

When a measurement at the antenna connector is used to determine RF output power, the effective gain of the device's antenna shall be stated, based on measurement or on data from the antenna manufacturer.

For transmitters of RF output power of 10 milliwatts or less, only the portion of the antenna gain that is in excess of 6 dBi (6 dB above isotropic gain) shall be added to the measured RF output power to demonstrate compliance with the radiated power limits specified in the applicable standard. For transmitters of output power greater than 10 milliwatts, the total antenna gain shall be added to the measured RF output power to demonstrate compliance to the specified radiated power limits. User manuals for transmitters shall display the following notice in a conspicuous location:

Under Industry Canada regulations, this radio transmitter may only operate using an antenna of a type and maximum (or lesser) gain approved for the transmitter by Industry Canada. To reduce potential radio interference to other users, the antenna type and its gain should be so chosen that the equivalent isotropically radiated power (e.i.r.p.) is not more than that necessary for successful communication.

The above notice may be affixed to the device instead of displayed in the user manual.

User manuals for transmitters equipped with detachable antennas shall also contain the following notice in a conspicuous location:

This radio transmitter (identify the device by certification number, or model number if Category II) has been approved by Industry Canada to operate with the antenna types listed below with the maximum permissible gain and required antenna impedance for each antenna type indicated. Antenna types not included in this list, having a gain greater than the maximum gain indicated for that type, are strictly prohibited for use with this device.

Immediately following the above notice, the manufacturer shall provide a list of all antenna types approved for use with the transmitter, indicating the maximum permissible antenna gain (in dBi) and required impedance for each.



RSS-Gen §7.2.4 Transmitter and Receiver AC Power Lines Conducted Emission Limits

Except when the requirements applicable to a given device state otherwise, for any radio apparatus equipped to operate from the public utility AC power supply, either directly or indirectly (such as with a battery charger), the radio frequency voltage of emissions conducted back onto the AC power lines in the frequency range of 0.15 MHz to 30 MHz shall not exceed the limits shown in the table below. The more stringent limit applies at the frequency range boundaries.

The conducted emissions shall be measured with a 50 ohm/50 microhenry line impedance stabilization network (LISN).

RSS-Gen Table 4 – AC Power Line Conducted Emission Limits

Frequency Range (MHz)	Conducted limit (dBµV)	
	Quasi-peak	Average
0.15 to 0.5	66 to 56*	56 to 46*
0.5 to 5	56	46
5 to 30	60	50

**Decreases with the logarithm of the frequency.*



8. FCC PART 15 REQUIREMENTS & RSS 210 REQUIREMENTS

8.1 99% BANDWIDTH

Test Configuration

TEST PROCEDURE

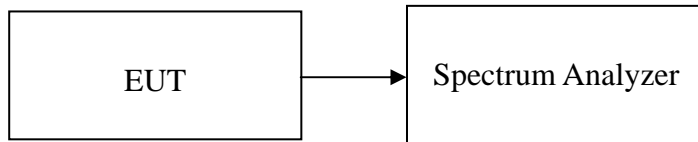

The resolution bandwidth shall be set to as close to 1% of the selected span as is possible without being below 1%. The video bandwidth shall be set to 3 times the resolution bandwidth. Video averaging is not permitted. Where practical, a sampling detector shall be used since a peak or peak hold.

TEST RESULTS

Test mode: IEEE 802.11a mode / 5180 ~ 5240MHz

Channel	Frequency (MHz)	Bandwidth (MHz)
Low	5180	16.6468
Mid	5220	16.6551
High	5240	16.6489

Test mode: IEEE 802.11n HT 20 MHz Channel mode / 5180 ~ 5240MHz

Channel	Frequency (MHz)	Bandwidth (MHz)
Low	5180	17.5564
Mid	5220	17.5981
High	5240	17.5508

Test mode: IEEE 802.11n HT 40 MHz Channel mode / 5190 ~ 5230MHz

Channel	Frequency (MHz)	Bandwidth (MHz)
Low	5190	36.0693
High	5230	36.0757



Test mode: IEEE 802.11a mode / 5260 ~ 5320MHz

Channel	Frequency (MHz)	Bandwidth (MHz)
Low	5260	16.6674
Mid	5280	16.6555
High	5320	16.6275

Test mode: IEEE 802.11n HT 20 MHz mode / 5260 ~ 5320MHz

Channel	Frequency (MHz)	Bandwidth (MHz)
Low	5260	17.5054
Mid	5280	17.5378
High	5320	17.6778

Test mode: IEEE 802.11n HT 40 MHz mode / 5270 ~ 5310MHz

Channel	Frequency (MHz)	Bandwidth (MHz)
Low	5270	36.0514
High	5310	36.0648

Test mode: IEEE 802.11a mode / 5500 ~ 5700MHz

Channel	Frequency (MHz)	Bandwidth (MHz)
Low	5500	16.6665
Mid	5580	16.6582
High	5700	16.7046

Test mode: IEEE 802.11n HT 20 MHz mode / 5500 ~ 5700MHz

Channel	Frequency (MHz)	Bandwidth (MHz)
Low	5500	17.5684
Mid	5580	17.5794
High	5700	17.5903

Test mode: IEEE 802.11n HT 40 MHz mode / 5510 ~ 5670MHz

Channel	Frequency (MHz)	Bandwidth (MHz)
Low	5510	35.9723
Mid	5550	36.0423
High	5670	35.9553



Test Plot

IEEE 802.11a mode / 5180 ~ 5240MHz

99% Bandwidth (CH Low)

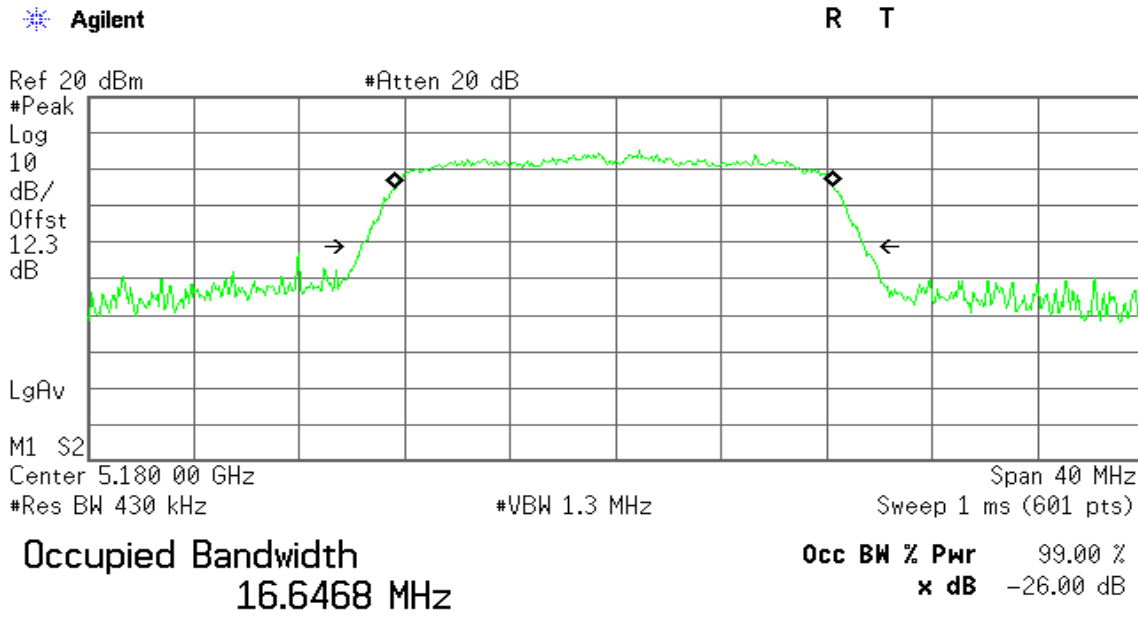

Transmit Freq Error -56.056 kHz

x dB Bandwidth 19.079 MHz

99% Bandwidth (CH Mid)

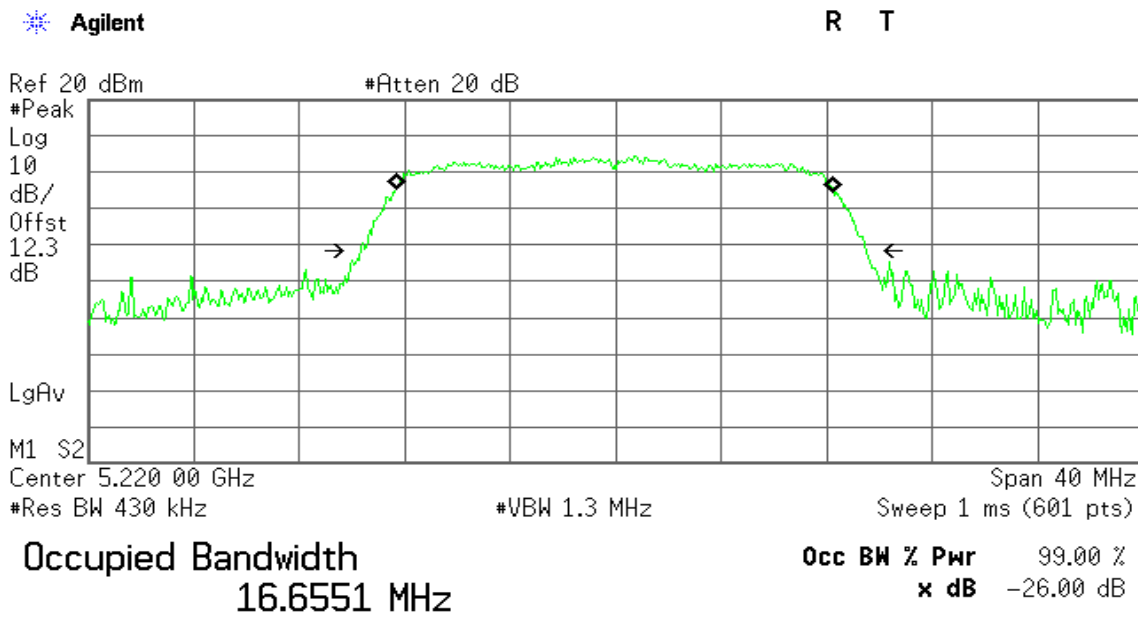

Transmit Freq Error -35.791 kHz

x dB Bandwidth 19.237 MHz



99% Bandwidth (CH High)

Agilent

R T

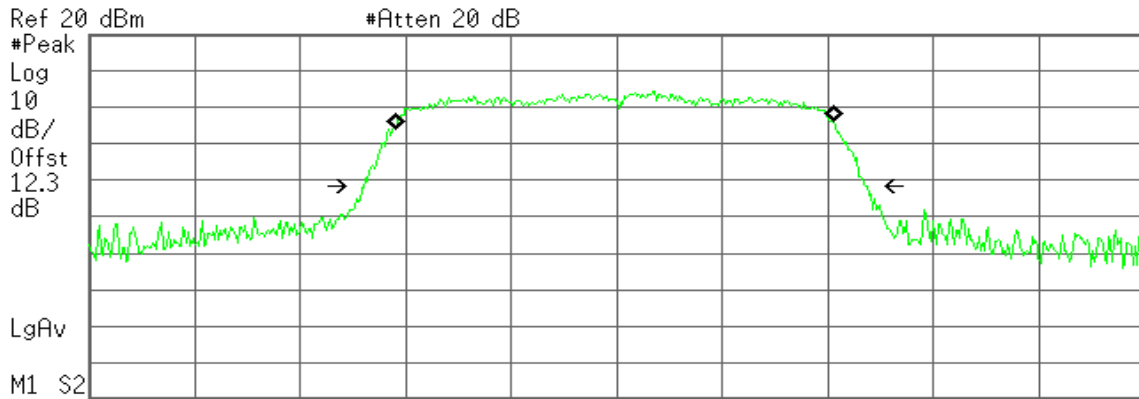

Ref 20 dBm #Peak
 Log 10 dB/ Offst 12.3 dB
 LgAv
 M1 S2
 Center 5.240 00 GHz Span 40 MHz
 #Res BW 430 kHz #VBW 1.3 MHz Sweep 1 ms (601 pts)

Occupied Bandwidth
16.6489 MHz

Occ BW % Pwr 99.00 %
x dB -26.00 dB

Transmit Freq Error -75.626 kHz
x dB Bandwidth 19.112 MHz

IEEE 802.11n HT 20 MHz mode / 5180 ~ 5240MHz

99% Bandwidth (CH Low)

Agilent

R T

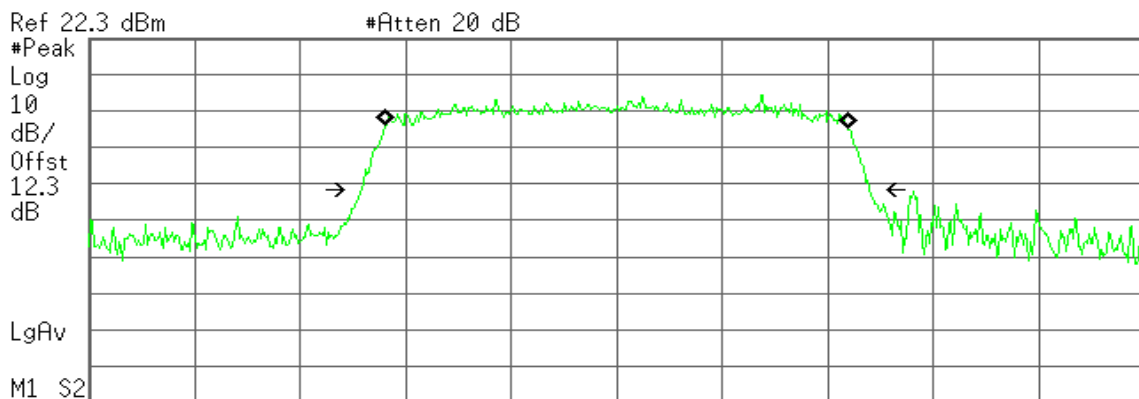

Ref 22.3 dBm #Peak
 Log 10 dB/ Offst 12.3 dB
 LgAv
 M1 S2
 Center 5.180 00 GHz Span 40 MHz
 #Res BW 430 kHz #VBW 1.3 MHz Sweep 1 ms (601 pts)

Occupied Bandwidth
17.5564 MHz

Occ BW % Pwr 99.00 %
x dB -26.00 dB

Transmit Freq Error -550.708 Hz
x dB Bandwidth 19.307 MHz



99% Bandwidth (CH Mid)

Agilent

R T

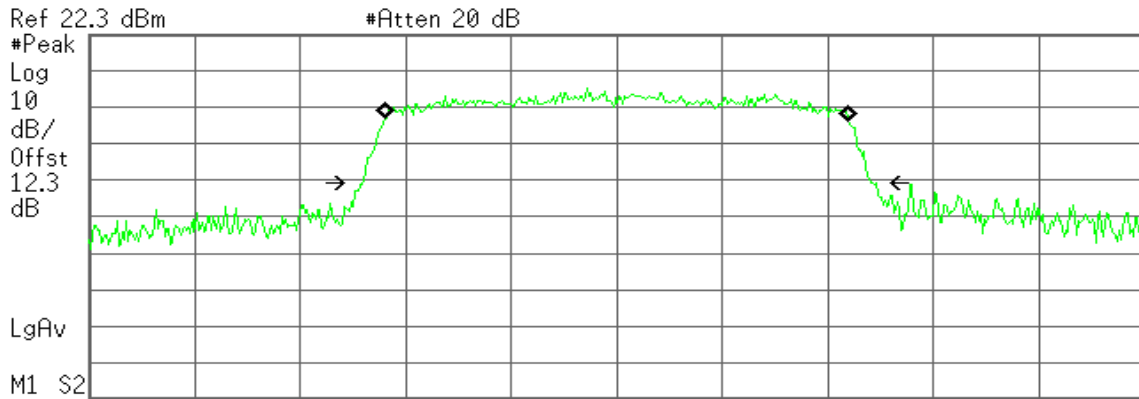

Center 5.220 00 GHz Span 40 MHz
#Res BW 430 kHz #VBW 1.3 MHz Sweep 1 ms (601 pts)

Occupied Bandwidth
17.5981 MHz

Occ BW % Pwr 99.00 %
x dB -26.00 dB

Transmit Freq Error 6.395 kHz
x dB Bandwidth 19.407 MHz

99% Bandwidth (CH High)

Agilent

R T

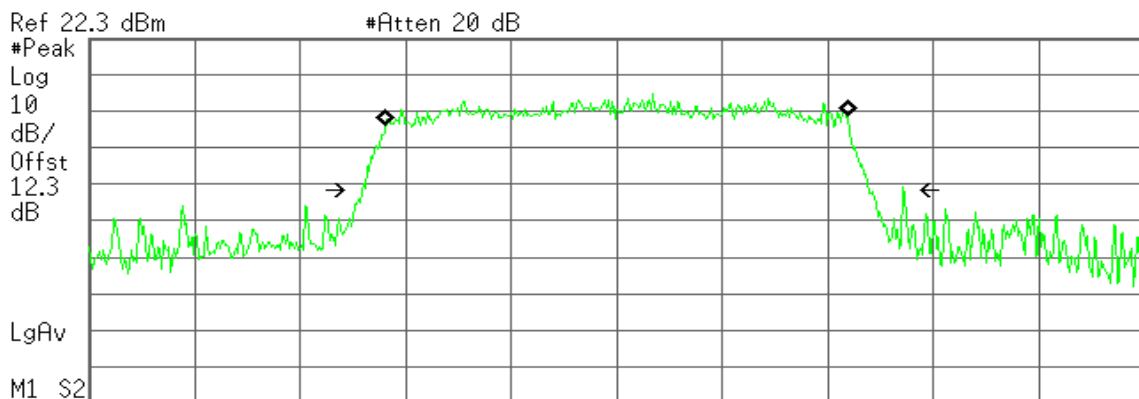

Center 5.240 00 GHz Span 40 MHz
#Res BW 430 kHz #VBW 1.3 MHz Sweep 1 ms (601 pts)

Occupied Bandwidth
17.5508 MHz

Occ BW % Pwr 99.00 %
x dB -26.00 dB

Transmit Freq Error 3.415 kHz
x dB Bandwidth 20.535 MHz



IEEE 802.11n HT 40 MHz mode / 5190 ~ 5230MHz

99% Bandwidth (CH Low)

Agilent

R T

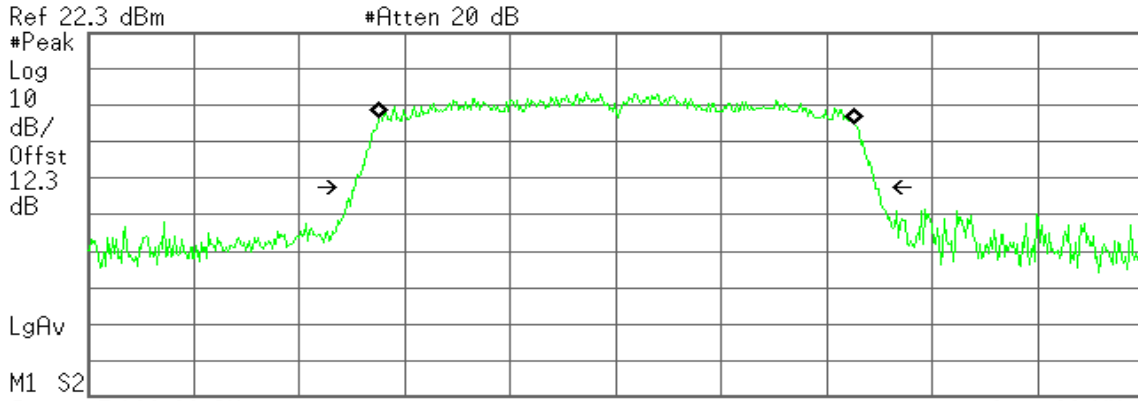

Occupied Bandwidth
36.0693 MHz

Occ BW % Pwr 99.00 %
x dB -26.00 dB

Transmit Freq Error 45.109 kHz
x dB Bandwidth 39.551 MHz

99% Bandwidth (CH High)

Agilent

R T

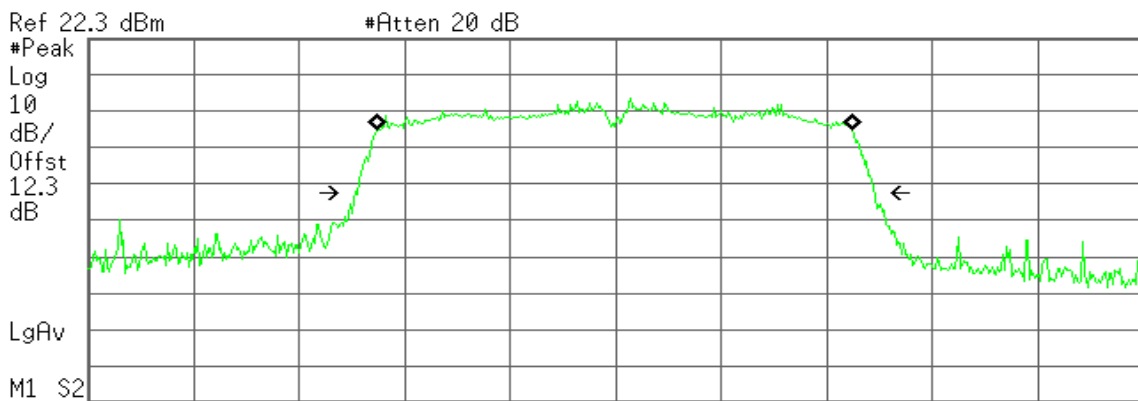

Occupied Bandwidth
36.0757 MHz

Occ BW % Pwr 99.00 %
x dB -26.00 dB

Transmit Freq Error -58.865 kHz
x dB Bandwidth 39.422 MHz



IEEE 802.11a mode / 5260 ~ 5320MHz

99% Bandwidth (CH Low)

Agilent

R T

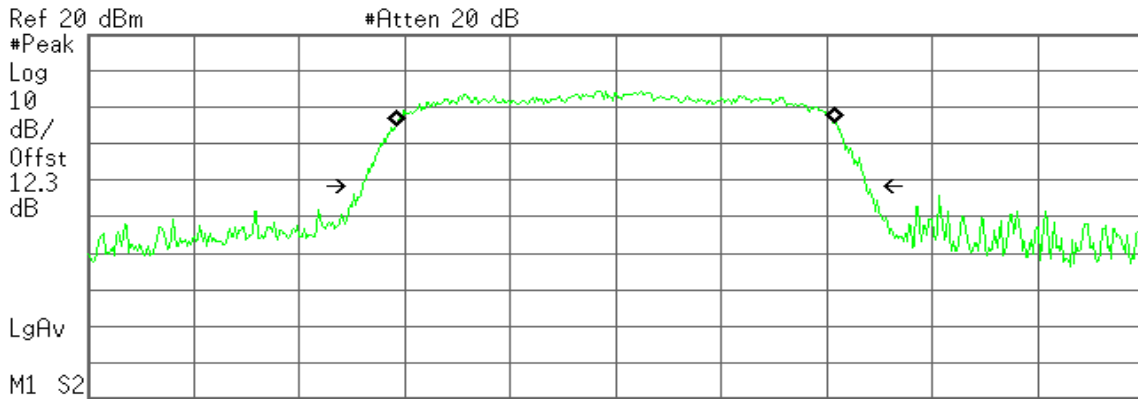

Center 5.260 00 GHz Span 40 MHz
#Res BW 430 kHz #VBW 1.3 MHz Sweep 1 ms (601 pts)

Occupied Bandwidth
16.6674 MHz

Occ BW % Pwr 99.00 %
x dB -26.00 dB

Transmit Freq Error -16.000 kHz
x dB Bandwidth 19.137 MHz

99% Bandwidth (CH Mid)

Agilent

R T

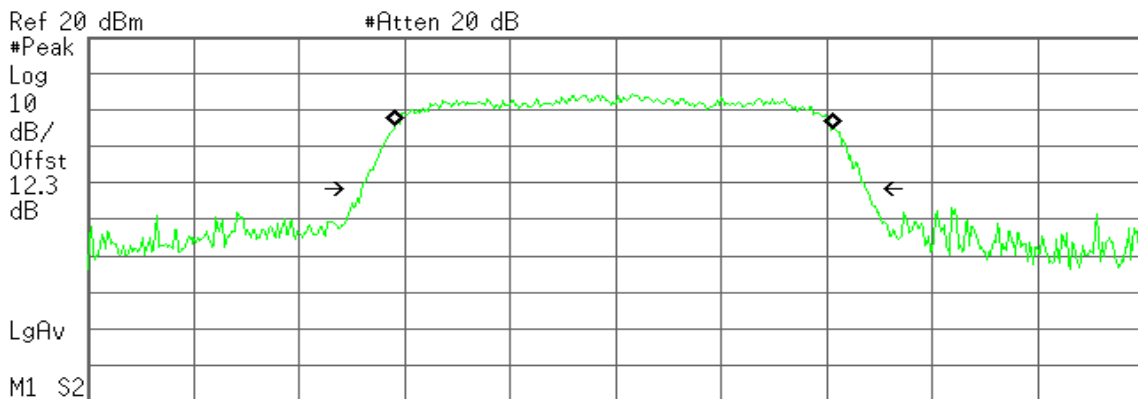

Center 5.280 00 GHz Span 40 MHz
#Res BW 430 kHz #VBW 1.3 MHz Sweep 1 ms (601 pts)

Occupied Bandwidth
16.6555 MHz

Occ BW % Pwr 99.00 %
x dB -26.00 dB

Transmit Freq Error -51.444 kHz
x dB Bandwidth 19.160 MHz



99% Bandwidth (CH High)

Agilent

R T

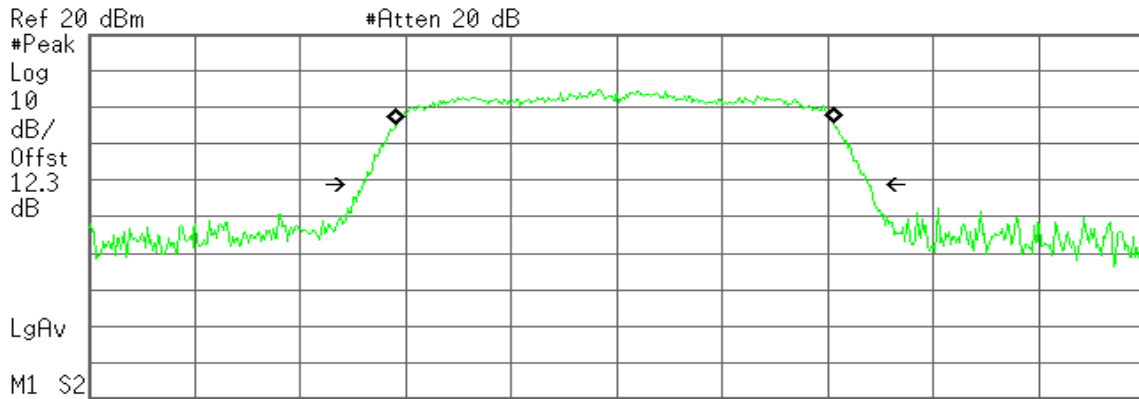

Ref 20 dBm #Peak
 Log 10 dB/Offst 12.3 dB
 LgAv
 M1 S2
 Center 5.320 00 GHz Span 40 MHz
 #Res BW 430 kHz #VBW 1.3 MHz Sweep 1 ms (601 pts)

Occupied Bandwidth
16.6275 MHz

Occ BW % Pwr 99.00 %
x dB -26.00 dB

Transmit Freq Error -56.711 kHz
x dB Bandwidth 19.216 MHz

IEEE 802.11n HT 20 MHz mode / 5260 ~ 5320MHz

99% Bandwidth (CH Low)

Agilent

R T

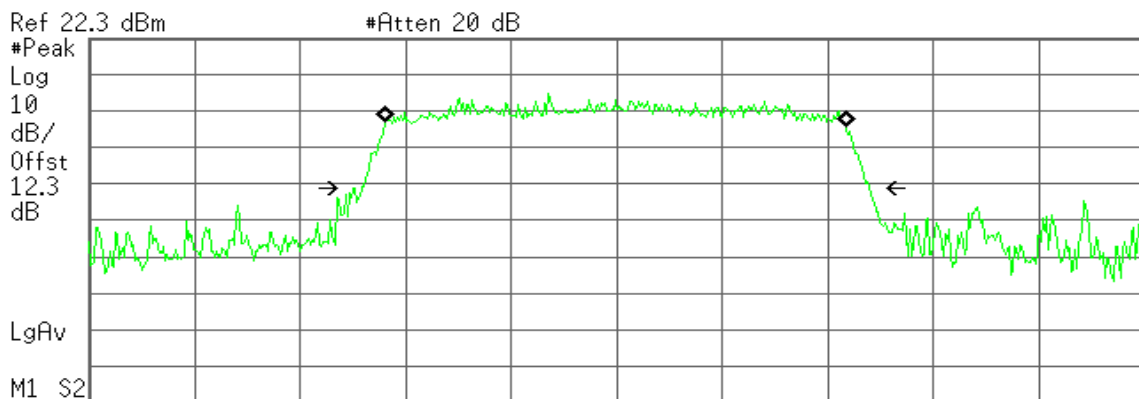

Ref 22.3 dBm #Peak
 Log 10 dB/Offst 12.3 dB
 LgAv
 M1 S2
 Center 5.260 00 GHz Span 40 MHz
 #Res BW 430 kHz #VBW 1.3 MHz Sweep 1 ms (601 pts)

Occupied Bandwidth
17.5054 MHz

Occ BW % Pwr 99.00 %
x dB -26.00 dB

Transmit Freq Error -41.261 kHz
x dB Bandwidth 19.549 MHz



99% Bandwidth (CH Mid)

Agilent

R T

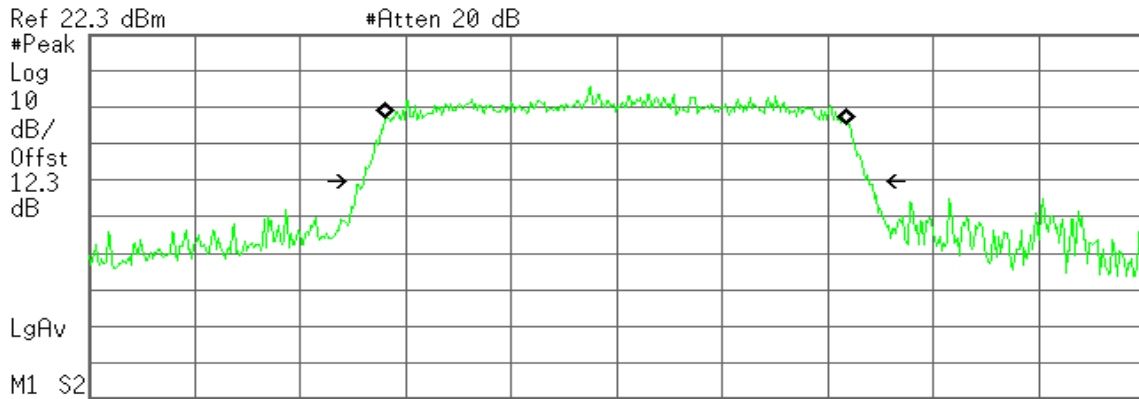

Center 5.280 00 GHz Span 40 MHz
 #Res BW 430 kHz #VBW 1.3 MHz Sweep 1 ms (601 pts)

Occupied Bandwidth
17.5378 MHz

Occ BW % Pwr 99.00 %
x dB -26.00 dB

Transmit Freq Error -21.028 kHz
x dB Bandwidth 19.179 MHz

99% Bandwidth (CH High)

Agilent

R T

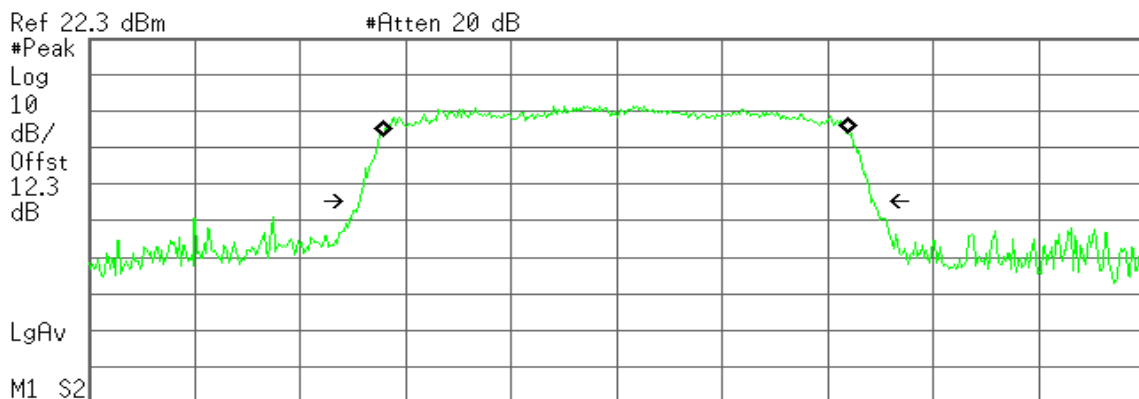

Center 5.320 00 GHz Span 40 MHz
 #Res BW 430 kHz #VBW 1.3 MHz Sweep 1 ms (601 pts)

Occupied Bandwidth
17.6778 MHz

Occ BW % Pwr 99.00 %
x dB -26.00 dB

Transmit Freq Error -31.596 kHz
x dB Bandwidth 19.493 MHz



IEEE 802.11n HT 40 MHz mode / 5270 ~ 5310MHz

99% Bandwidth (CH Low)

Agilent

R T

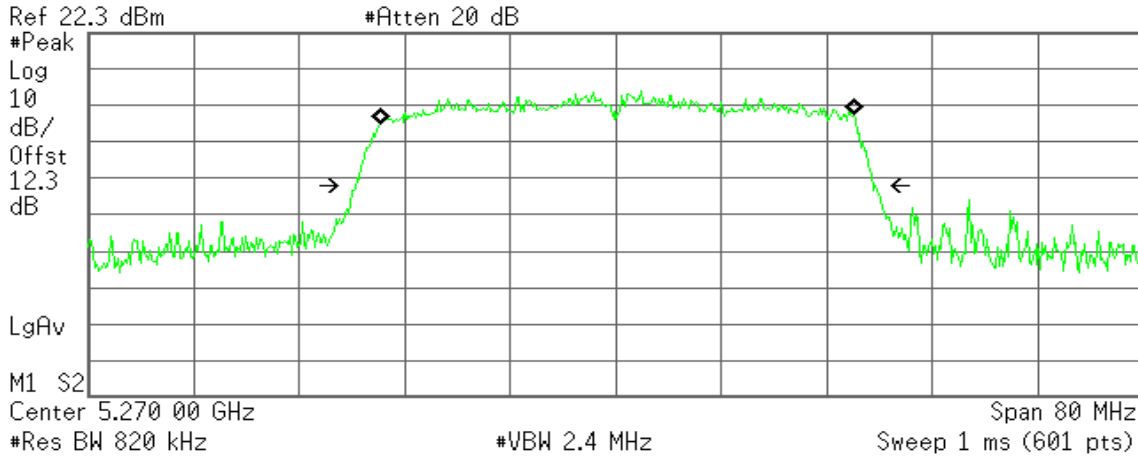

Occupied Bandwidth
36.0514 MHz

Occ BW % Pwr 99.00 %
x dB -26.00 dB

Transmit Freq Error 109.119 kHz
x dB Bandwidth 39.282 MHz

99% Bandwidth (CH High)

Agilent

R T

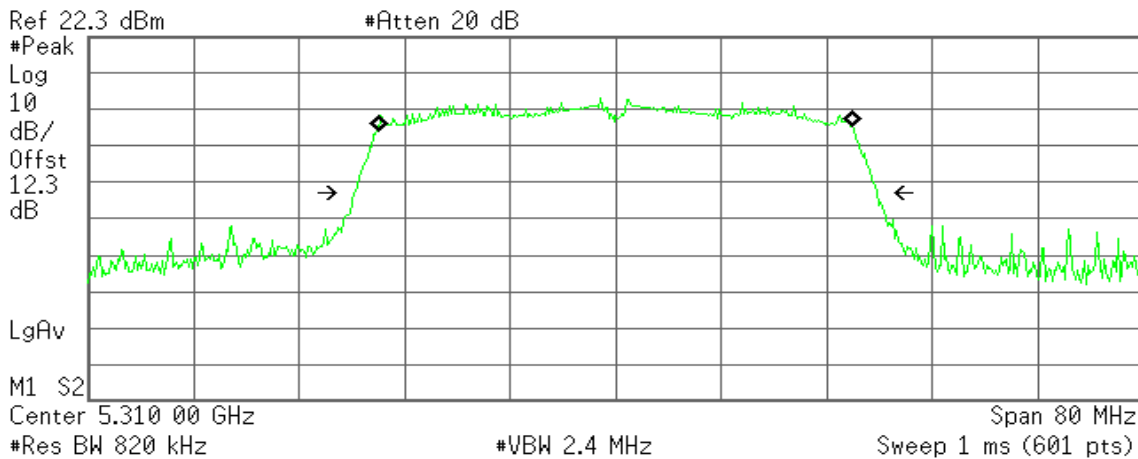

Occupied Bandwidth
36.0468 MHz

Occ BW % Pwr 99.00 %
x dB -26.00 dB

Transmit Freq Error -25.858 kHz
x dB Bandwidth 39.769 MHz



Test mode: IEEE 802.11a mode / 5500 ~ 5700MHz

99% Bandwidth (CH Low)

Agilent

R T

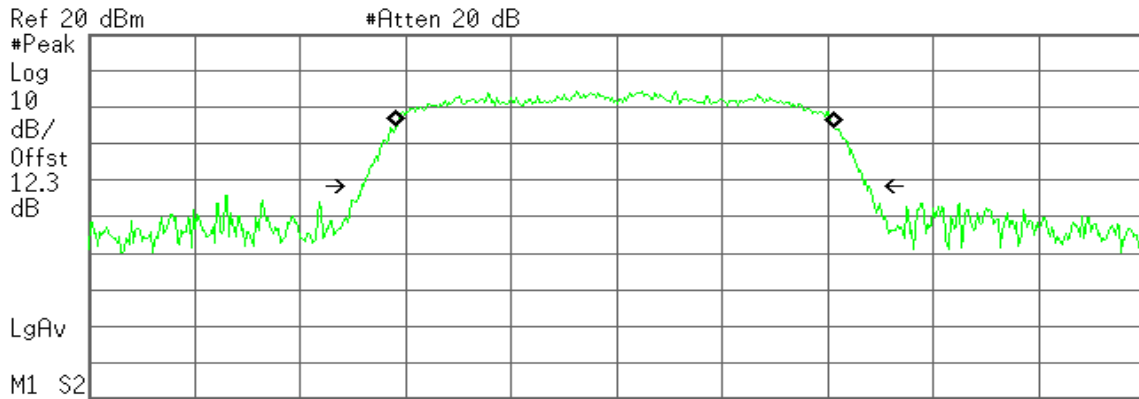

Center 5.500 00 GHz Span 40 MHz
 #Res BW 430 kHz #VBW 1.3 MHz Sweep 1 ms (601 pts)

Occupied Bandwidth
16.6665 MHz

Occ BW % Pwr 99.00 %
x dB -26.00 dB

Transmit Freq Error -52.572 kHz
x dB Bandwidth 19.176 MHz

99% Bandwidth (CH Mid)

Agilent

R T

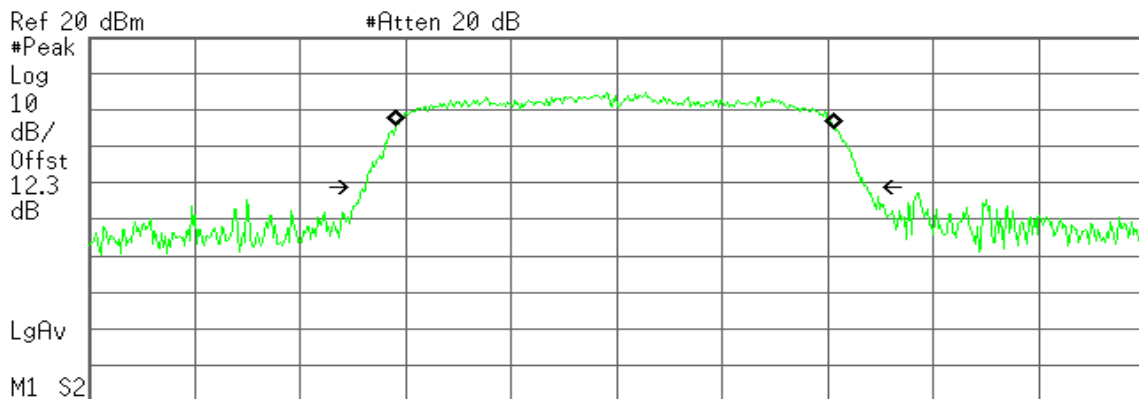

Center 5.580 00 GHz Span 40 MHz
 #Res BW 430 kHz #VBW 1.3 MHz Sweep 1 ms (601 pts)

Occupied Bandwidth
16.6582 MHz

Occ BW % Pwr 99.00 %
x dB -26.00 dB

Transmit Freq Error -44.441 kHz
x dB Bandwidth 19.015 MHz



99% Bandwidth (CH High)

Agilent

R T

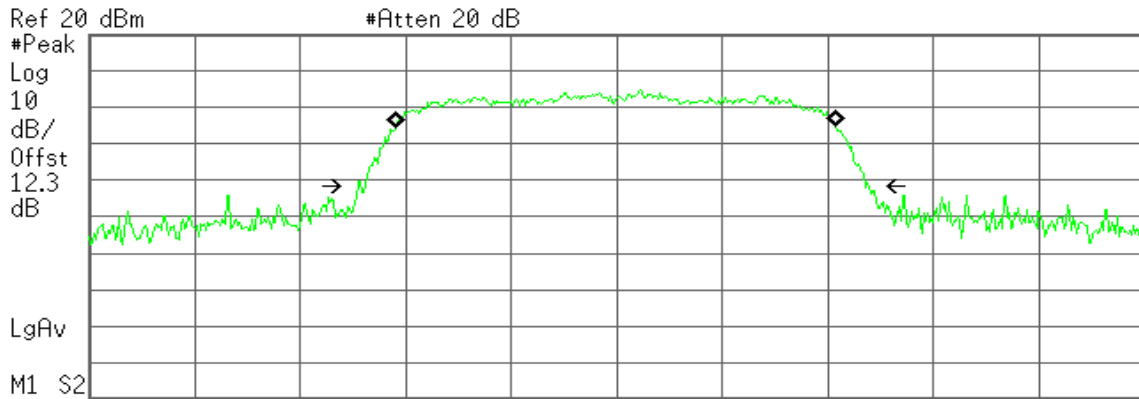

Ref 20 dBm #Atten 20 dB
 #Peak Log 10 dB/ Offst 12.3 dB
 LgAv
 M1 S2
 Center 5.700 00 GHz Span 40 MHz
 #Res BW 430 kHz #VBW 1.3 MHz Sweep 1 ms (601 pts)

Occupied Bandwidth
16.7046 MHz

Occ BW % Pwr 99.00 %
x dB -26.00 dB

Transmit Freq Error -32.336 kHz
x dB Bandwidth 19.397 MHz

IEEE 802.11n HT 20 MHz mode / 5500 ~ 5700MHz

99% Bandwidth (CH Low)

Agilent

R T

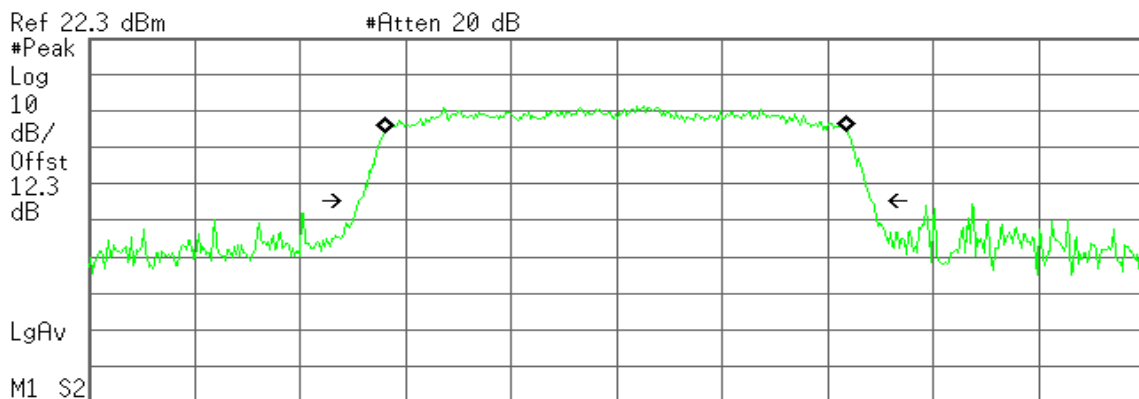

Ref 22.3 dBm #Atten 20 dB
 #Peak Log 10 dB/ Offst 12.3 dB
 LgAv
 M1 S2
 Center 5.500 00 GHz Span 40 MHz
 #Res BW 430 kHz #VBW 1.3 MHz Sweep 1 ms (601 pts)

Occupied Bandwidth
17.5684 MHz

Occ BW % Pwr 99.00 %
x dB -26.00 dB

Transmit Freq Error -24.989 kHz
x dB Bandwidth 19.453 MHz



99% Bandwidth (CH Mid)

Agilent

R T

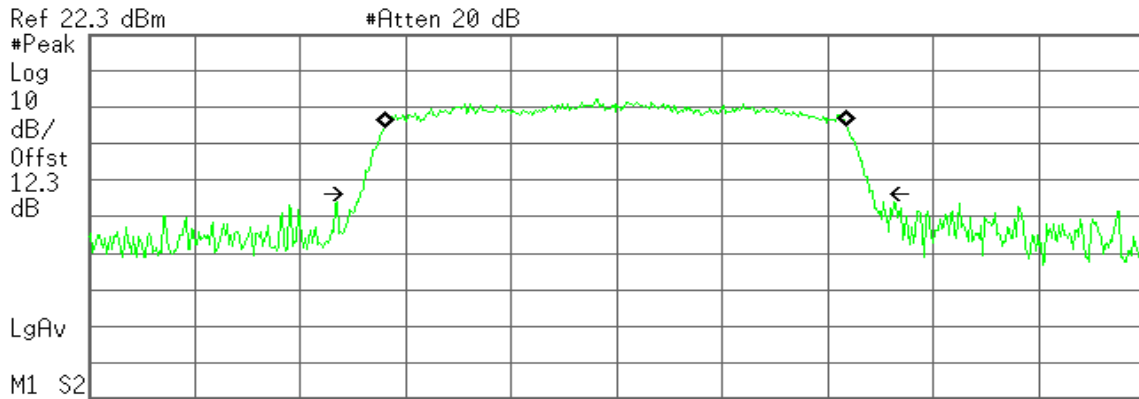

Center 5.580 00 GHz Span 40 MHz
 #Res BW 430 kHz #VBW 1.3 MHz Sweep 1 ms (601 pts)

Occupied Bandwidth
17.5794 MHz

Occ BW % Pwr 99.00 %
x dB -26.00 dB

Transmit Freq Error -25.899 kHz
x dB Bandwidth 19.489 MHz

99% Bandwidth (CH High)

Agilent

R T

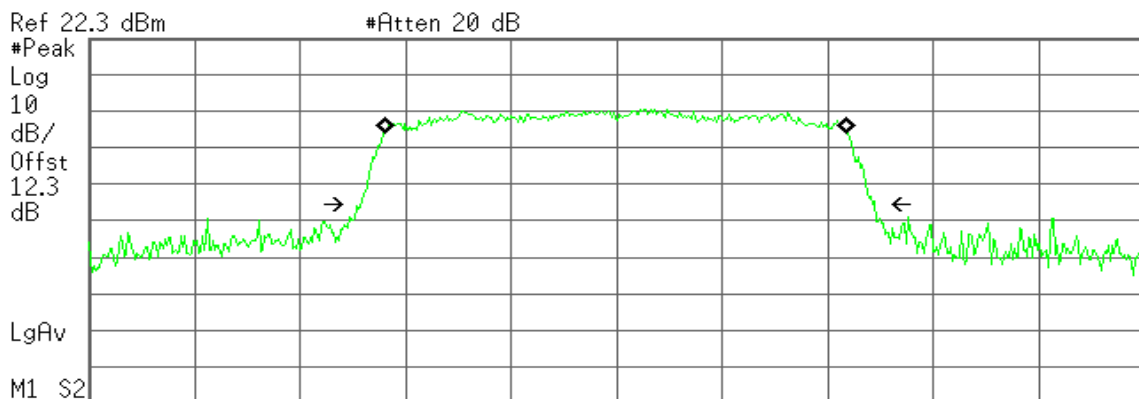

Center 5.700 00 GHz Span 40 MHz
 #Res BW 430 kHz #VBW 1.3 MHz Sweep 1 ms (601 pts)

Occupied Bandwidth
17.5903 MHz

Occ BW % Pwr 99.00 %
x dB -26.00 dB

Transmit Freq Error -31.888 kHz
x dB Bandwidth 19.521 MHz



IEEE 802.11n HT 40 MHz mode / 5510 ~ 5670MHz

99% Bandwidth (CH Low)

Agilent

R T

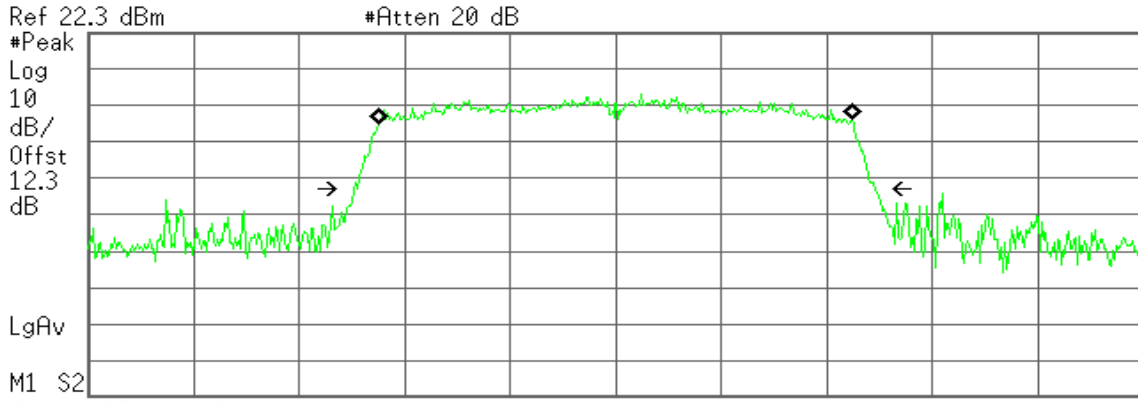

Center 5.510 00 GHz Span 80 MHz
 #Res BW 820 kHz #VBW 2.4 MHz Sweep 1 ms (601 pts)

Occupied Bandwidth
35.9723 MHz

Occ BW % Pwr 99.00 %
x dB -26.00 dB

Transmit Freq Error -23.701 kHz
x dB Bandwidth 39.579 MHz

99% Bandwidth (CH Mid)

Agilent

R T

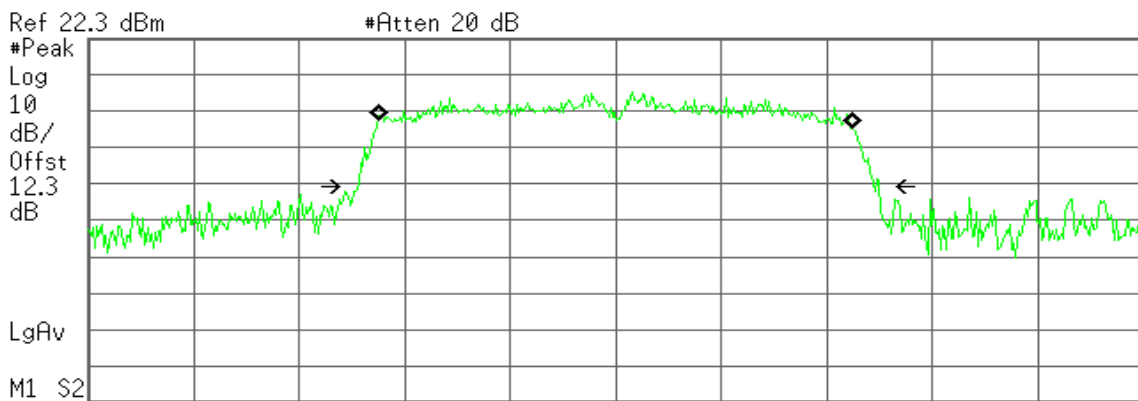

Center 5.550 00 GHz Span 80 MHz
 #Res BW 820 kHz #VBW 2.4 MHz Sweep 1 ms (601 pts)

Occupied Bandwidth
36.0423 MHz

Occ BW % Pwr 99.00 %
x dB -26.00 dB

Transmit Freq Error -44.667 kHz
x dB Bandwidth 39.582 MHz



99% Bandwidth (CH High)

Agilent

R T

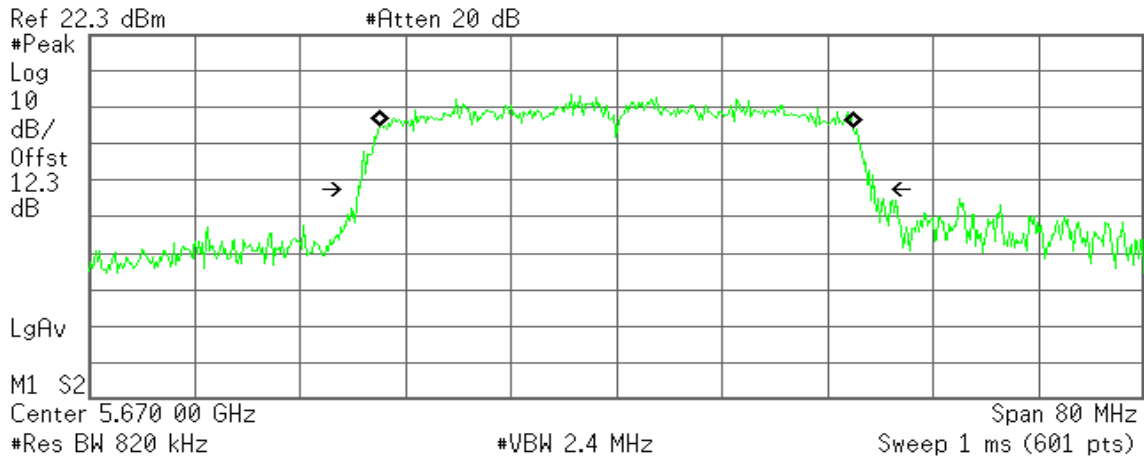

Occupied Bandwidth
35.9553 MHz

Occ BW % Pwr 99.00 %
x dB -26.00 dB

Transmit Freq Error -7.599 kHz
x dB Bandwidth 39.205 MHz



8.2 26 DB EMISSION BANDWIDTH

LIMIT

According to §15.303(c), for purposes of this subpart the emission bandwidth shall be determined by measuring the width of the signal between two points, one below the carrier center frequency and one above the carrier center frequency, that are 26 dB down relative to the maximum level of the modulated carrier. Compliance with the emissions limits is based on the use of measurement instrumentation employing a peak detector function with an instrument resolutions bandwidth approximately equal to 1.0 percent of the emission bandwidth of the device under measurement.

Test Configuration

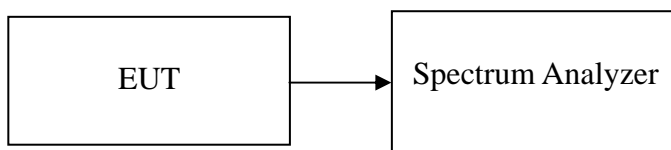

TEST PROCEDURE

1. Place the EUT on the table and set it in the transmitting mode.
2. Remove the antenna from the EUT and then connect a low-loss RF cable from the antenna port to the spectrum analyzer.
3. Set the spectrum analyzer as RBW > 1%EBW, VBW > RBW, Span >26dB bandwidth, and Sweep = auto.
4. Mark the peak frequency and -26dB (upper and lower) frequency.
5. Repeat until all the rest channels were investigated.

TEST RESULTS

No non-compliance noted



Test Data

Test mode: IEEE 802.11a mode / 5180 ~ 5240MHz

Channel	Frequency (MHz)	Bandwidth (B) (MHz)
Low	5180	19.079
Mid	5220	19.237
High	5240	19.112

Test mode: IEEE 802.11n HT 20 MHz mode / 5180 ~ 5240MHz

Channel	Frequency (MHz)	Bandwidth (B) (MHz)
Low	5180	19.307
Mid	5220	19.407
High	5240	20.535

Test mode: IEEE 802.11n HT 40 MHz mode / 5190 ~ 5230MHz

Channel	Frequency (MHz)	Bandwidth (B) (MHz)
Low	5190	39.551
High	5230	39.422

Test mode: IEEE 802.11a mode / 5260 ~ 5320MHz

Channel	Frequency (MHz)	Bandwidth (B) (MHz)
Low	5260	19.137
Mid	5280	19.160
High	5320	19.216

Test mode: IEEE 802.11n HT 20 MHz mode / 5260 ~ 5320MHz

Channel	Frequency (MHz)	Bandwidth (B) (MHz)
Low	5180	19.549
Mid	5260	19.179
High	5320	19.493

Test mode: IEEE 802.11n HT 40 MHz mode / 5270 ~ 5310MHz

Channel	Frequency (MHz)	Bandwidth (B) (MHz)
Low	5190	39.282
High	5310	39.769



Test mode: IEEE 802.11a mode / 5500 ~ 5700MHz

Channel	Frequency (MHz)	Bandwidth (MHz)
Low	5500	19.176
Mid	5580	19.015
High	5700	19.397

Test mode: IEEE 802.11n HT 20 MHz mode / 5500 ~ 5700MHz

Channel	Frequency (MHz)	Bandwidth (MHz)
Low	5500	19.453
Mid	5580	19.489
High	5700	19.521

Test mode: IEEE 802.11n HT 40 MHz mode / 5510 ~ 5670MHz

Channel	Frequency (MHz)	Bandwidth (MHz)
Low	5510	39.579
Mid	5550	39.582
High	5670	39.205



Test Plot

IEEE 802.11a for 5180 ~ 5240MHz

CH Low

Agilent

R T

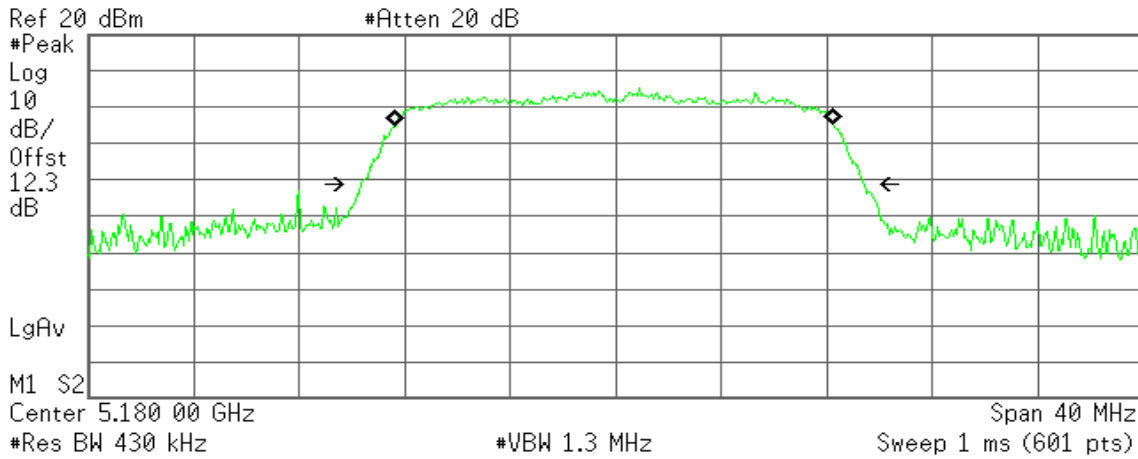

Occupied Bandwidth
16.6468 MHz

Occ BW % Pwr 99.00 %
x dB -26.00 dB

Transmit Freq Error -56.056 kHz
x dB Bandwidth 19.079 MHz

CH Mid

Agilent

R T

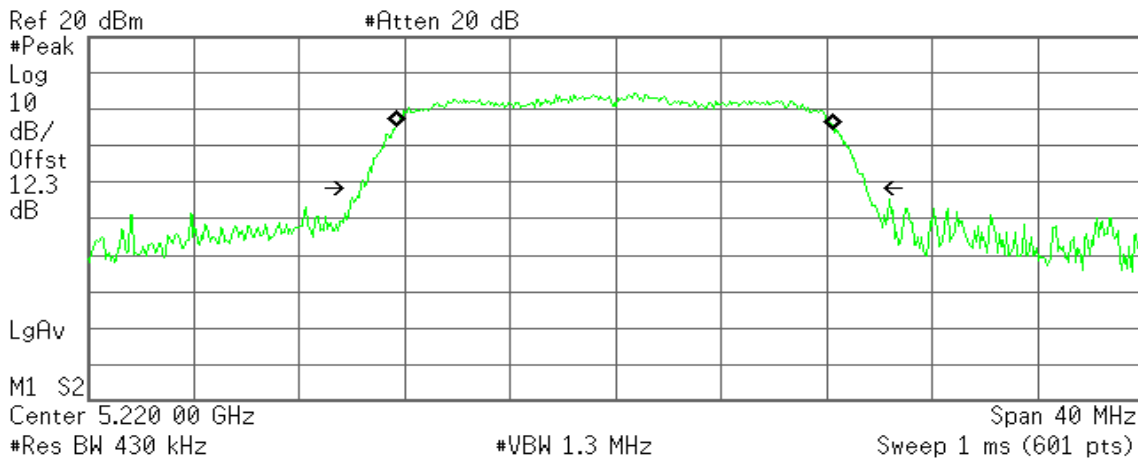

Occupied Bandwidth
16.6551 MHz

Occ BW % Pwr 99.00 %
x dB -26.00 dB

Transmit Freq Error -35.791 kHz
x dB Bandwidth 19.237 MHz



CH High

Agilent

R T

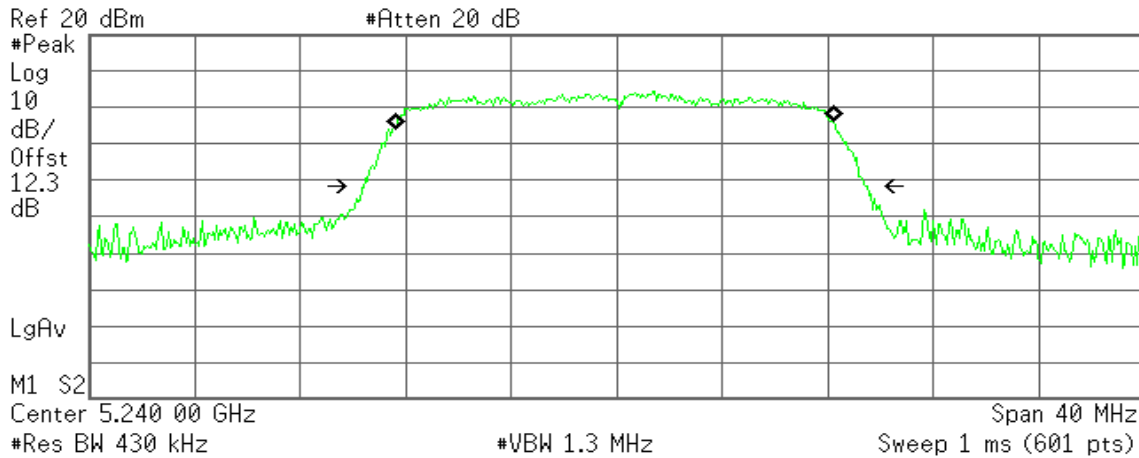

Occupied Bandwidth 16.6489 MHz

Occ BW % Pwr 99.00 %
x dB -26.00 dB

Transmit Freq Error -75.626 kHz
x dB Bandwidth 19.112 MHz

IEEE 802.11n HT 20 MHz mode / 5180 ~ 5240MHz

CH Low

Agilent

R T

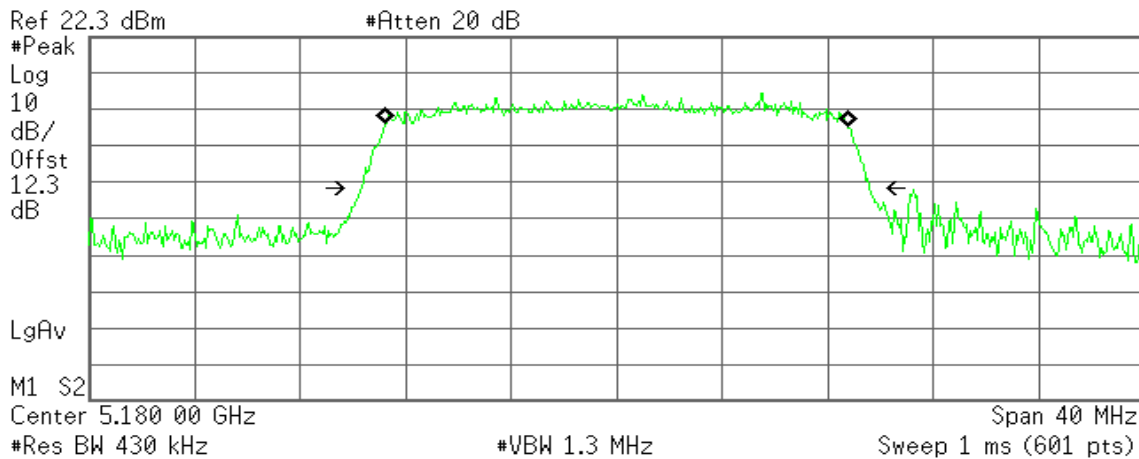

Occupied Bandwidth 17.5564 MHz

Occ BW % Pwr 99.00 %
x dB -26.00 dB

Transmit Freq Error -550.708 Hz
x dB Bandwidth 19.307 MHz



CH Mid

Agilent

R T

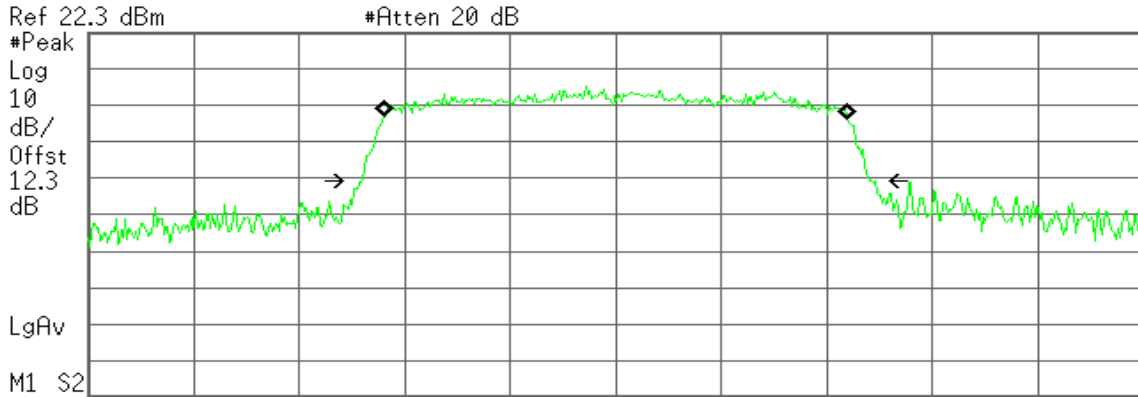

Center 5.220 00 GHz

Span 40 MHz

#Res BW 430 kHz

#VBW 1.3 MHz

Sweep 1 ms (601 pts)

Occupied Bandwidth
17.5981 MHz

Occ BW % Pwr 99.00 %
x dB -26.00 dB

Transmit Freq Error 6.395 kHz
x dB Bandwidth 19.407 MHz

CH High

Agilent

R T

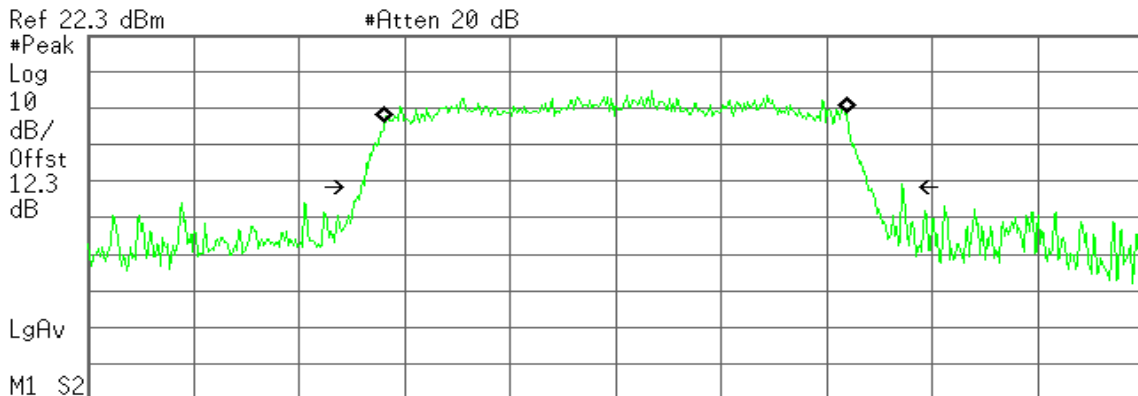

Center 5.240 00 GHz

Span 40 MHz

#Res BW 430 kHz

#VBW 1.3 MHz

Sweep 1 ms (601 pts)

Occupied Bandwidth
17.5508 MHz

Occ BW % Pwr 99.00 %
x dB -26.00 dB

Transmit Freq Error 3.415 kHz
x dB Bandwidth 20.535 MHz



IEEE 802.11n HT 40 MHz mode / 5190 ~ 5230MHz

CH Low

Agilent

R T

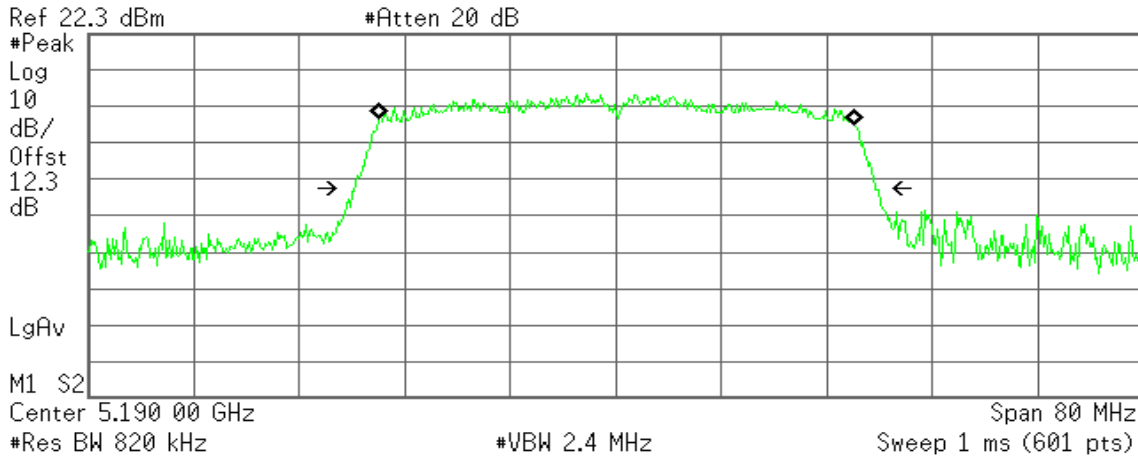

Occupied Bandwidth
36.0693 MHz

Occ BW % Pwr 99.00 %
x dB -26.00 dB

Transmit Freq Error 45.109 kHz
x dB Bandwidth 39.551 MHz

CH High

Agilent

R T

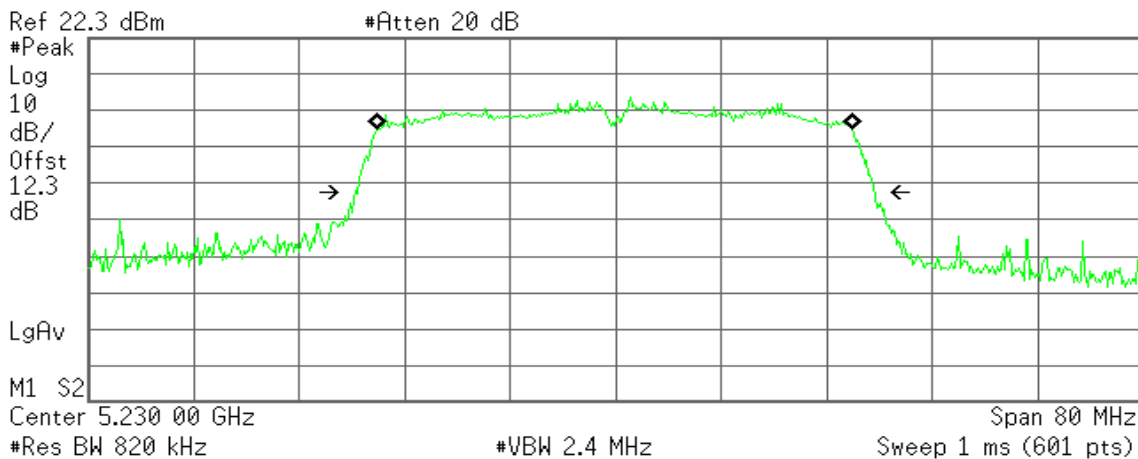

Occupied Bandwidth
36.0757 MHz

Occ BW % Pwr 99.00 %
x dB -26.00 dB

Transmit Freq Error -58.865 kHz
x dB Bandwidth 39.422 MHz



IEEE 802.11a mode / 5260 ~ 5320MHz

CH Low

Agilent

R T

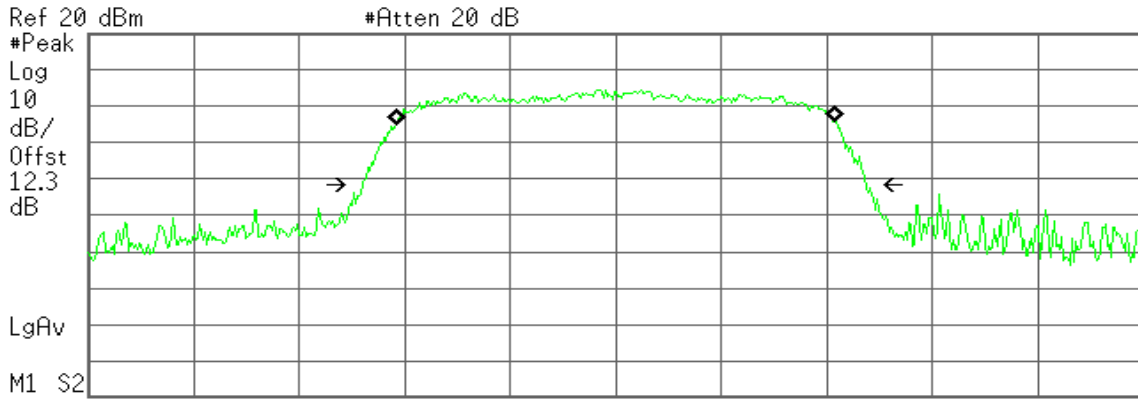

Center 5.260 00 GHz Span 40 MHz
 #Res BW 430 kHz #VBW 1.3 MHz Sweep 1 ms (601 pts)

Occupied Bandwidth
 16.6674 MHz

Occ BW % Pwr 99.00 %
x dB -26.00 dB

Transmit Freq Error -16.000 kHz
x dB Bandwidth 19.137 MHz

CH Mid

Agilent

R T

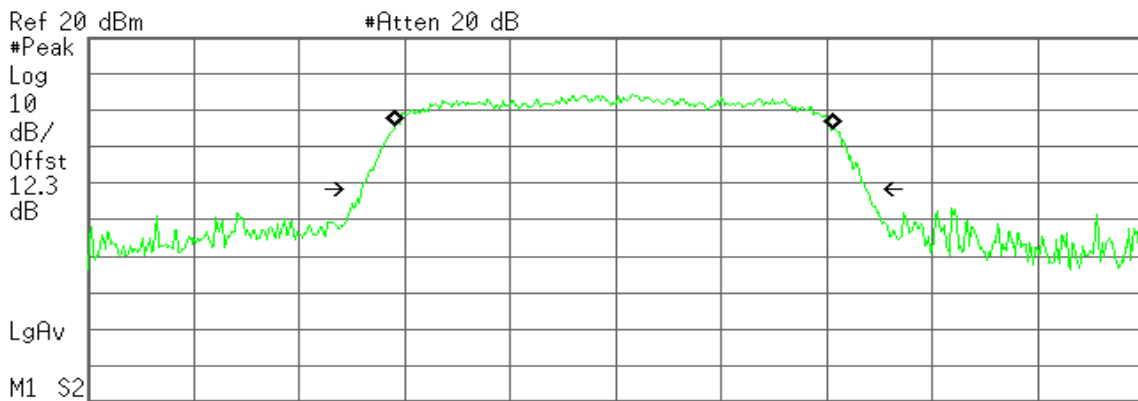

Center 5.280 00 GHz Span 40 MHz
 #Res BW 430 kHz #VBW 1.3 MHz Sweep 1 ms (601 pts)

Occupied Bandwidth
 16.6555 MHz

Occ BW % Pwr 99.00 %
x dB -26.00 dB

Transmit Freq Error -51.444 kHz
x dB Bandwidth 19.160 MHz



CH High

Agilent

R T

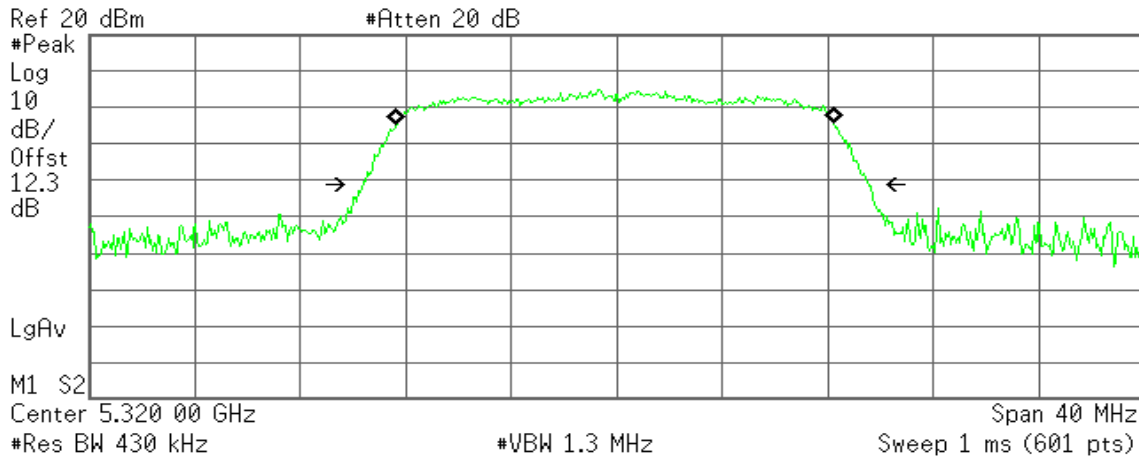

Occupied Bandwidth 16.6275 MHz

Occ BW % Pwr 99.00 %
x dB -26.00 dB

Transmit Freq Error -56.711 kHz
x dB Bandwidth 19.216 MHz

IEEE 802.11n HT 20 MHz mode / 5260 ~ 5320MHz

CH Low

Agilent

R T

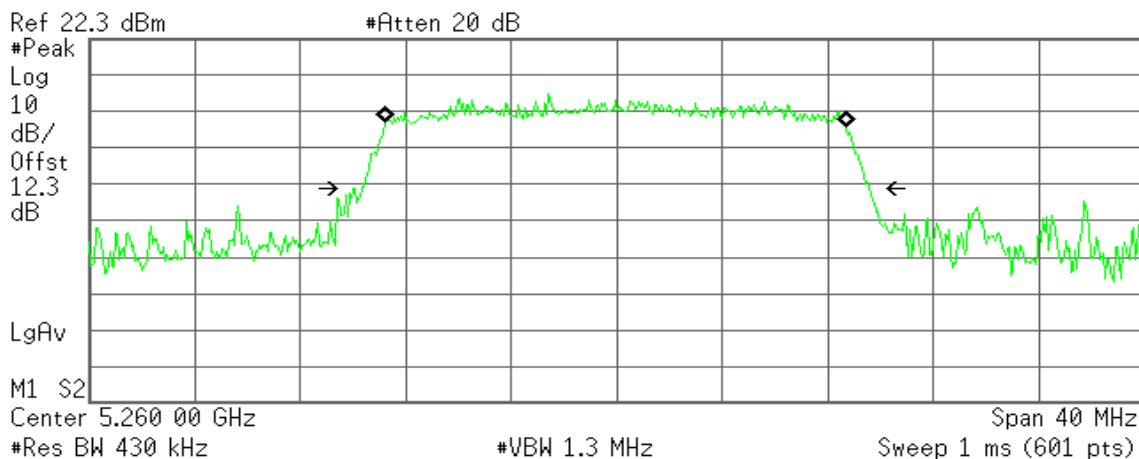

Occupied Bandwidth 17.5054 MHz

Occ BW % Pwr 99.00 %
x dB -26.00 dB

Transmit Freq Error -41.261 kHz
x dB Bandwidth 19.549 MHz



CH Mid

Agilent

R T

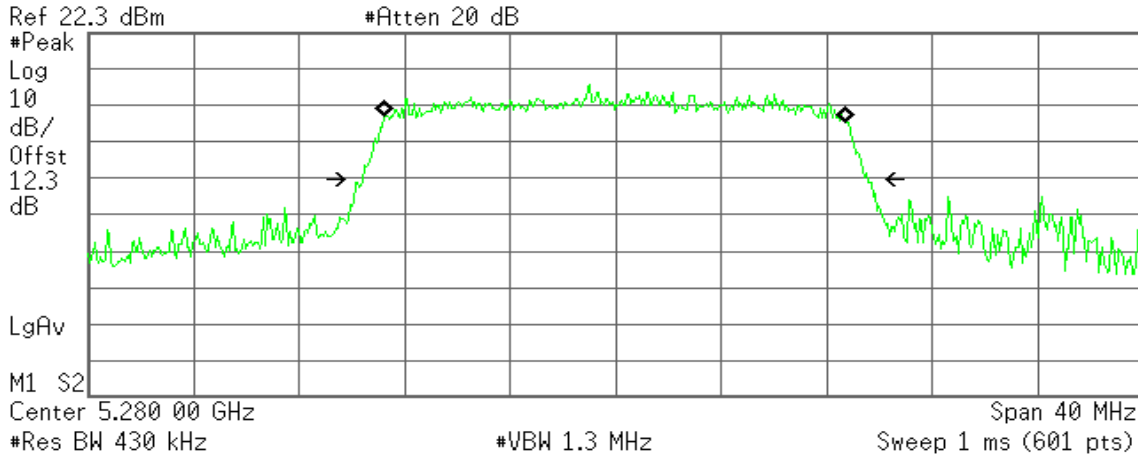

Occupied Bandwidth
17.5378 MHz

Occ BW % Pwr 99.00 %
x dB -26.00 dB

Transmit Freq Error -21.028 kHz
x dB Bandwidth 19.179 MHz

CH High

Agilent

R T

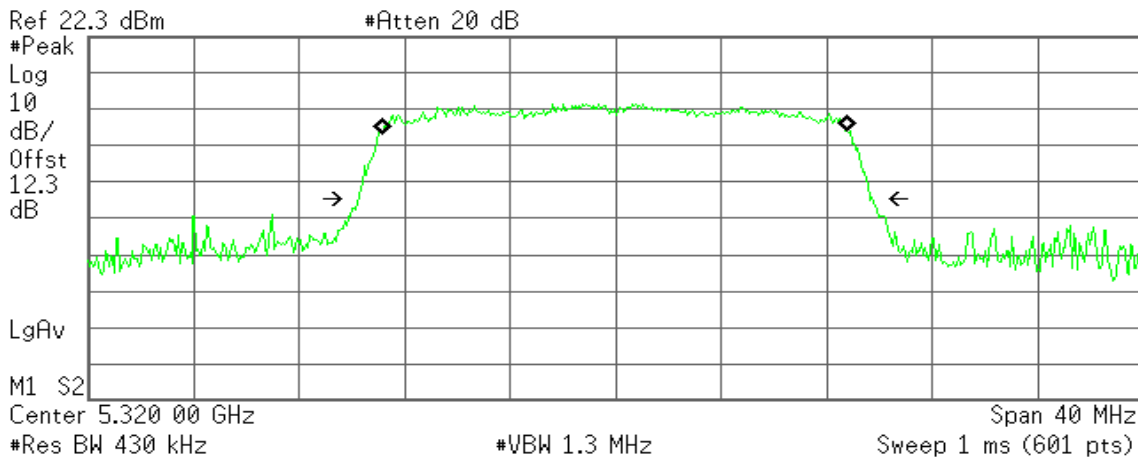

Occupied Bandwidth
17.6778 MHz

Occ BW % Pwr 99.00 %
x dB -26.00 dB

Transmit Freq Error -31.596 kHz
x dB Bandwidth 19.493 MHz



IEEE 802.11n HT 40 MHz mode / 5270 ~ 5310MHz

CH Low

Agilent

R T

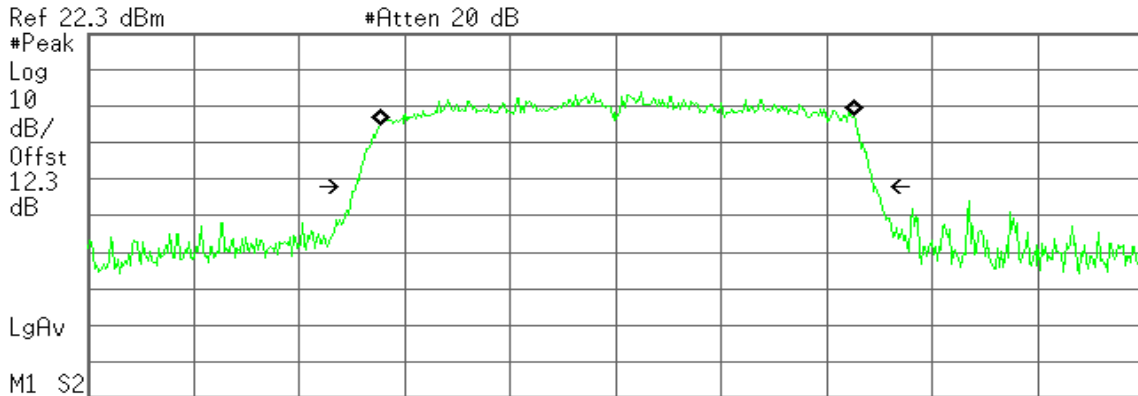

Ref 22.3 dBm #Atten 20 dB
 M1 S2
 Center 5.270 00 GHz Span 80 MHz
 #Res BW 820 kHz #VBW 2.4 MHz Sweep 1 ms (601 pts)

Occupied Bandwidth
36.0514 MHz

Occ BW % Pwr 99.00 %
x dB -26.00 dB

Transmit Freq Error 109.119 kHz
x dB Bandwidth 39.282 MHz

CH High

Agilent

R T

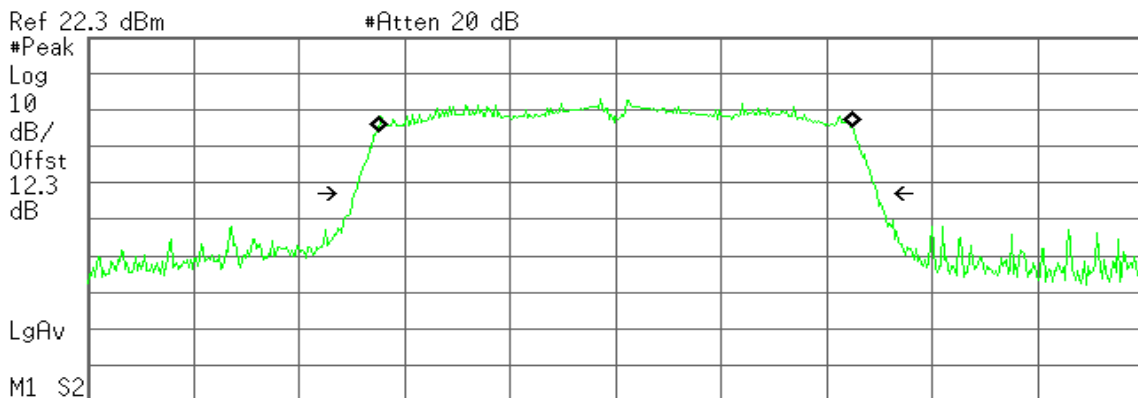

Ref 22.3 dBm #Atten 20 dB
 M1 S2
 Center 5.310 00 GHz Span 80 MHz
 #Res BW 820 kHz #VBW 2.4 MHz Sweep 1 ms (601 pts)

Occupied Bandwidth
36.0468 MHz

Occ BW % Pwr 99.00 %
x dB -26.00 dB

Transmit Freq Error -25.858 kHz
x dB Bandwidth 39.769 MHz



IEEE 802.11a mode / 5500 ~ 5700MHz

CH Low

Agilent

R T

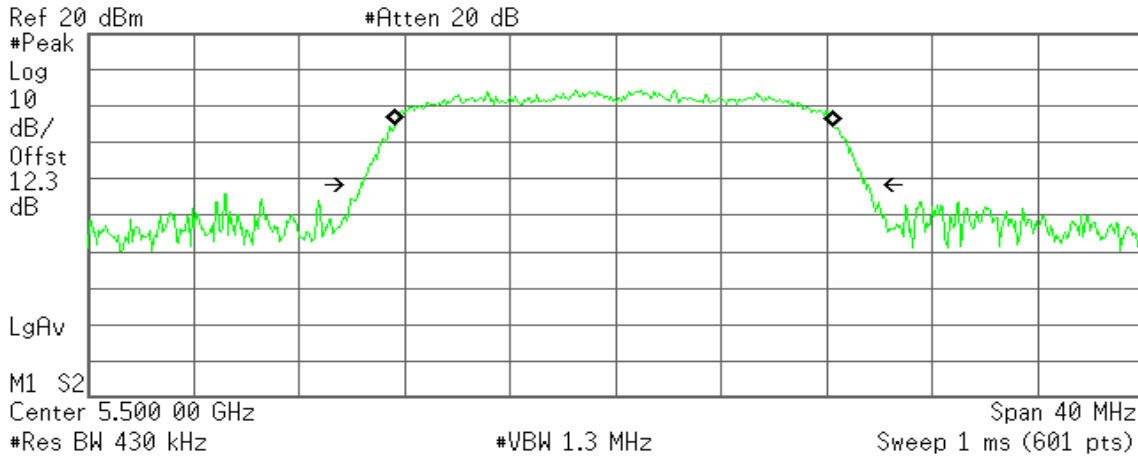

Occupied Bandwidth
16.6665 MHz

Occ BW % Pwr 99.00 %
x dB -26.00 dB

Transmit Freq Error -52.572 kHz
x dB Bandwidth 19.176 MHz

CH Mid

Agilent

R T

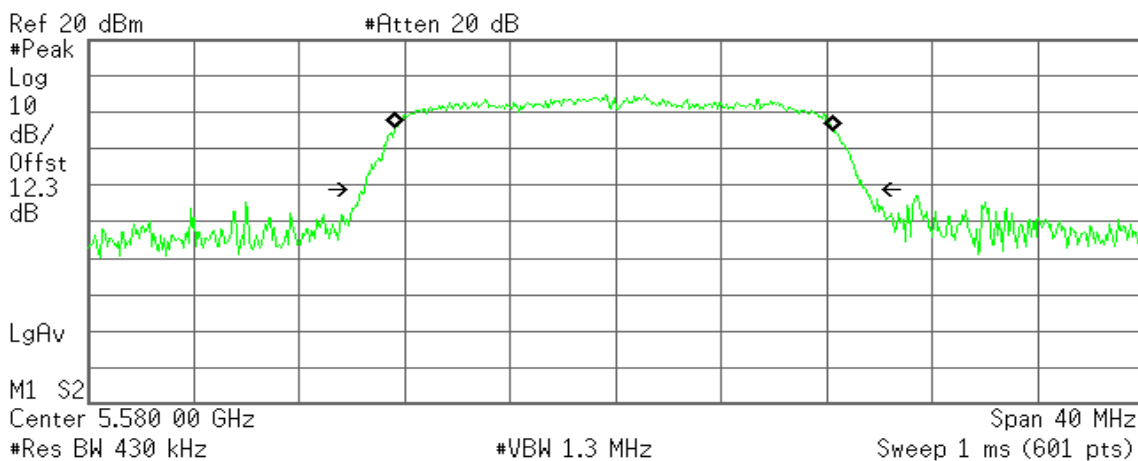

Occupied Bandwidth
16.6582 MHz

Occ BW % Pwr 99.00 %
x dB -26.00 dB

Transmit Freq Error -44.441 kHz
x dB Bandwidth 19.015 MHz



CH High

Agilent

R T

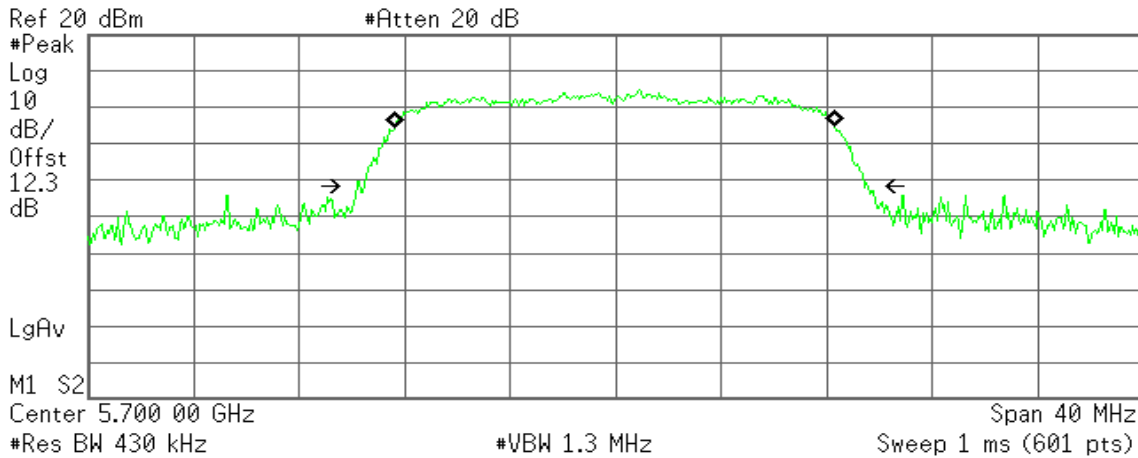

Occupied Bandwidth 16.7046 MHz

Occ BW % Pwr 99.00 %
x dB -26.00 dB

Transmit Freq Error -32.336 kHz
x dB Bandwidth 19.397 MHz

IEEE 802.11n HT 20 MHz mode / 5500 ~ 5700MHz

CH Low

Agilent

R T

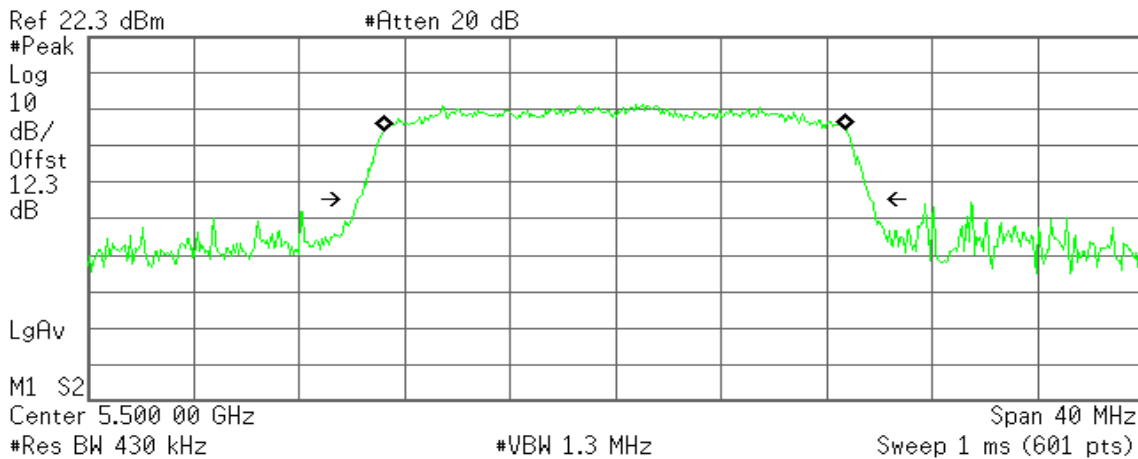

Occupied Bandwidth 17.5684 MHz

Occ BW % Pwr 99.00 %
x dB -26.00 dB

Transmit Freq Error -24.989 kHz
x dB Bandwidth 19.453 MHz



CH Mid

Agilent

R T

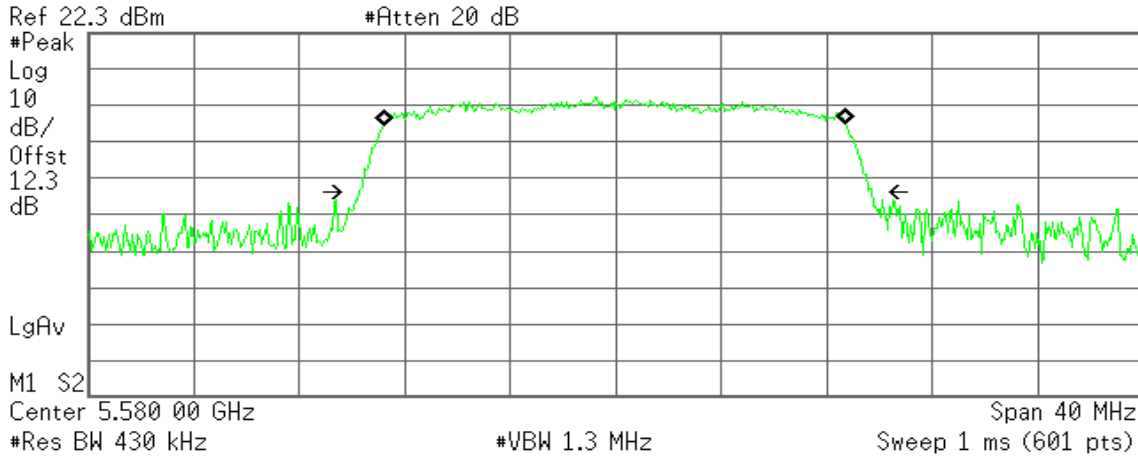

Occupied Bandwidth
17.5794 MHz

Occ BW % Pwr 99.00 %
x dB -26.00 dB

Transmit Freq Error -25.899 kHz
x dB Bandwidth 19.489 MHz

CH High

Agilent

R T

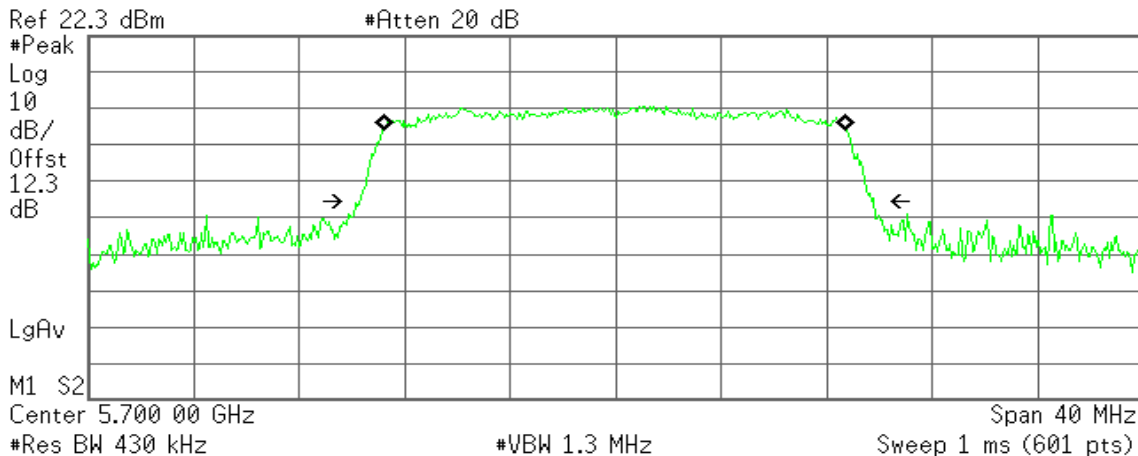

Occupied Bandwidth
17.5903 MHz

Occ BW % Pwr 99.00 %
x dB -26.00 dB

Transmit Freq Error -31.888 kHz
x dB Bandwidth 19.521 MHz



IEEE 802.11n HT 40 MHz mode / 5510 ~ 5670MHz

CH Low

Agilent

R T

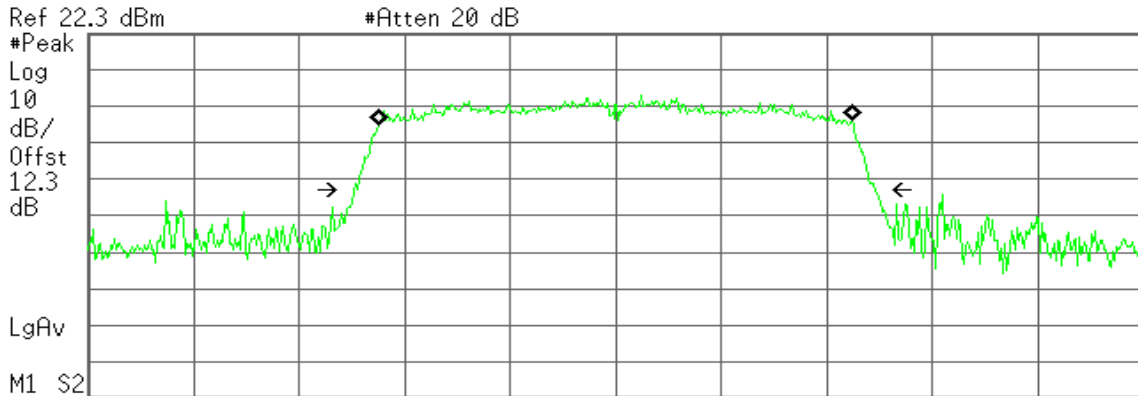

Center 5.510 00 GHz Span 80 MHz
 #Res BW 820 kHz #VBW 2.4 MHz Sweep 1 ms (601 pts)

Occupied Bandwidth
35.9723 MHz

Occ BW % Pwr 99.00 %
x dB -26.00 dB

Transmit Freq Error -23.701 kHz
x dB Bandwidth 39.579 MHz

CH Mid

Agilent

R T

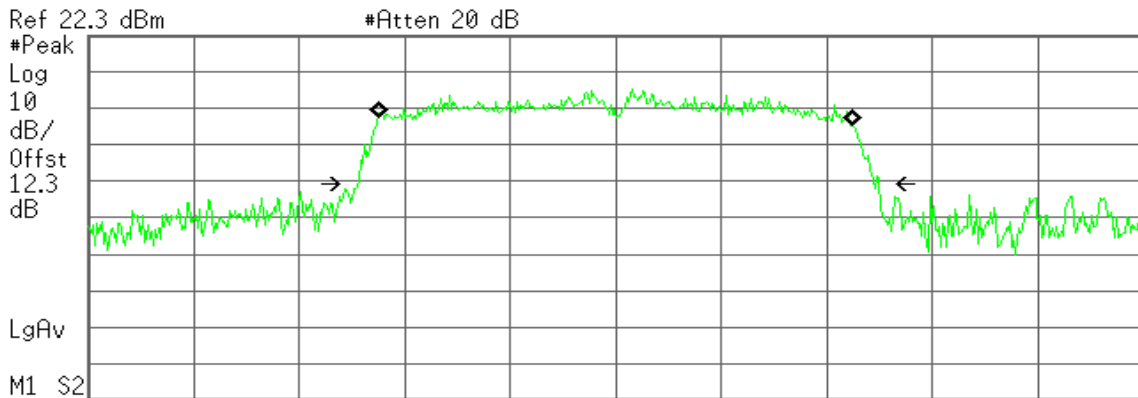

Center 5.550 00 GHz Span 80 MHz
 #Res BW 820 kHz #VBW 2.4 MHz Sweep 1 ms (601 pts)

Occupied Bandwidth
36.0423 MHz

Occ BW % Pwr 99.00 %
x dB -26.00 dB

Transmit Freq Error -44.667 kHz
x dB Bandwidth 39.582 MHz



CH High

Agilent

R T

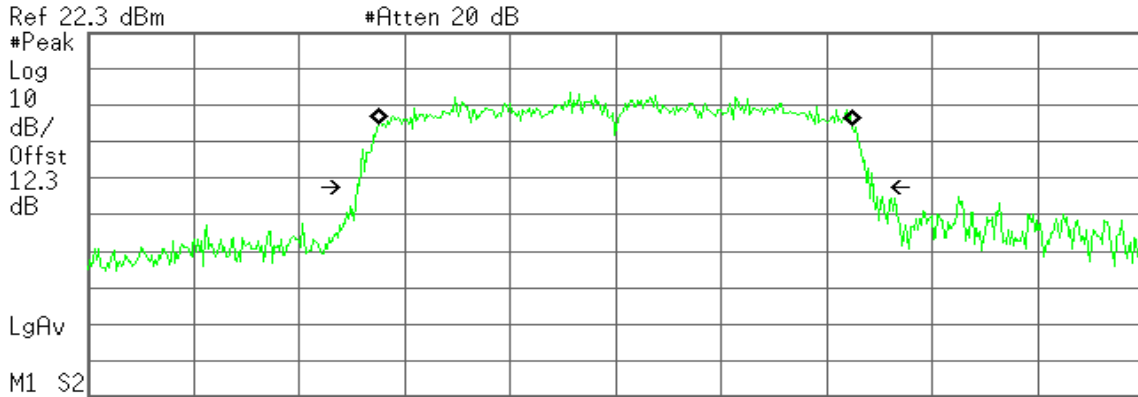

Center 5.670 00 GHz Span 80 MHz
 #Res BW 820 kHz #VBW 2.4 MHz Sweep 1 ms (601 pts)

Occupied Bandwidth
35.9553 MHz

Occ BW % Pwr 99.00 %
x dB -26.00 dB

Transmit Freq Error -7.599 kHz
x dB Bandwidth 39.205 MHz



8.3 MAXIMUM CONDUCTED OUTPUT POWER

LIMIT

According to §15.407(a),

- (1) For the band 5.15-5.25 GHz, the maximum conducted output power over the frequency band of operation shall not exceed the lesser of 50 mW or $4 \text{ dBm} + 10 \log B$, where B is the 26 dB emission bandwidth in MHz.
- (2) For the 5.25-5.35 GHz and 5.47-5.725 GHz bands, the maximum conducted output power over the frequency bands of operation shall not exceed the lesser of 250 mW or $11 \text{ dBm} + 10 \log B$, where B is the 26 dB emission bandwidth in MHz.

If transmitting antennas of directional gain greater than 6dBi are used, both the peak transmit power and the peak power spectral density shall be reduced by the amount in dB that the directional gain of the antenna exceeds 6dBi.

According to RSS-210 §A9.2,

- (1) For the band 5150-5250 MHz, the maximum equivalent isotropically radiated power (e.i.r.p.) shall not exceed 200 mW or $10 + 10 \text{ Log}_{10} B$, dBm, whichever power is less. B is the 99% emission bandwidth in MHz. The e.i.r.p. spectral density shall not exceed 10 dBm in any 1.0 MHz band.
- (2) For the band 5250-5350 MHz and 5470-5725 MHz, the maximum conducted output power shall not exceed 250 mW or $11 + 10 \text{ Log}_{10} B$, dBm, whichever power is less. The power spectral density shall not exceed 11 dBm in any 1.0 MHz band. The maximum e.i.r.p. shall not exceed 1.0 W or $17 + 10 \text{ Log}_{10} B$, dBm, whichever power is less. B is the 99% emission bandwidth in MHz.

In addition, devices with maximum e.i.r.p. greater than 500 mW shall implement TPC in order to have the capability to operate at least 6 dB below the maximum permitted e.i.r.p. of 1 W.

The peak power shall not exceed the limit as follow:



Specified Limit of the Peak Power

Test mode: IEEE 802.11a mode / 5180 ~ 5240MHz

Channel	Frequency (MHz)	26 dB Bandwidth (B) (MHz)	10 Log B (dB)	4 + 10 Log B (dBm)	Maximum Conducted Output Power Limit (dBm)
Low	5180	19.079	12.81	16.81	17.00
Mid	5220	19.237	12.84	16.84	17.00
High	5240	19.112	12.81	16.81	17.00

Test mode: IEEE 802.11n HT 20 MHz Channel mode / 5180 ~ 5240MHz

Channel	Frequency (MHz)	26 dB Bandwidth (B) (MHz)	10 Log B (dB)	4 + 10 Log B (dBm)	Maximum Conducted Output Power Limit (dBm)
Low	5180	19.307	12.86	16.86	17.00
Mid	5220	19.407	12.88	16.88	17.00
High	5240	20.535	13.12	17.12	17.00

Test mode: IEEE 802.11n HT 40 MHz mode / 5190 ~ 5230MHz

Channel	Frequency (MHz)	26 dB Bandwidth (B) (MHz)	10 Log B (dB)	4 + 10 Log B (dBm)	Maximum Conducted Output Power Limit (dBm)
Low	5190	39.551	15.97	19.97	17.00
High	5230	39.422	15.96	19.96	17.00



Test mode: IEEE 802.11a mode / 5260 ~ 5320MHz

Channel	Frequency (MHz)	26 dB Bandwidth (B) (MHz)	10 Log B (dB)	11 + 10 Log B (dBm)	Maximum Conducted Output Power Limit (dBm)
Low	5260	19.137	12.82	23.82	24.00
Mid	5280	19.160	12.82	23.82	24.00
High	5320	19.216	12.84	23.84	24.00

Test mode: IEEE 802.11n HT 20 MHz Channel mode / 5260 ~ 5320MHz

Channel	Frequency (MHz)	26 dB Bandwidth (B) (MHz)	10 Log B (dB)	11 + 10 Log B (dBm)	Maximum Conducted Output Power Limit (dBm)
Low	5260	19.549	12.91	23.91	24.00
Mid	5280	19.179	12.83	23.83	24.00
High	5320	19.493	12.90	23.90	24.00

Test mode: IEEE 802.11n HT 40 MHz mode / 5270 ~ 5310MHz

Channel	Frequency (MHz)	26 dB Bandwidth (B) (MHz)	10 Log B (dB)	11 + 10 Log B (dBm)	Maximum Conducted Output Power Limit (dBm)
Low	5270	39.282	15.94	26.94	24.00
High	5310	39.769	16.00	27.00	24.00

Test mode: IEEE 802.11a mode / 5500 ~ 5700MHz

Channel	Frequency (MHz)	26 dB Bandwidth (B) (MHz)	10 Log B (dB)	11 + 10 Log B (dBm)	Maximum Conducted Output Power Limit (dBm)
Low	5500	19.176	12.83	23.83	24.00
Mid	5580	19.015	12.79	23.79	24.00
High	5700	19.397	12.88	23.88	24.00

Test mode: IEEE 802.11n HT 20 MHz Channel mode/ 5500 ~ 5700MHz

Channel	Frequency (MHz)	26 dB Bandwidth (B) (MHz)	10 Log B (dB)	11 + 10 Log B (dBm)	Maximum Conducted Output Power Limit (dBm)
Low	5500	19.453	12.89	23.89	24.00
Mid	5580	19.489	12.90	23.90	24.00
High	5700	19.521	12.91	23.91	24.00

Test mode: IEEE 802.11n HT 40 MHz mode / 5510 ~ 5670MHz

Channel	Frequency (MHz)	26 dB Bandwidth (B) (MHz)	10 Log B (dB)	11 + 10 Log B (dBm)	Maximum Conducted Output Power Limit (dBm)
Low	5510	39.579	15.97	26.97	24.00
Mid	5550	39.582	15.97	26.97	24.00
High	5670	39.205	15.93	26.93	24.00



Test Configuration

The EUT was connected to a spectrum analyzer through a 50Ω RF cable.

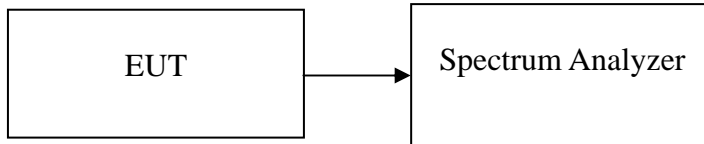

TEST PROCEDURE

Set span to encompass the entire emission bandwidth (EBW) of the signal.

Set RBW = 1 MHz / Set VBW = 3 MHz.

Use sample detector mode if bin width (i.e., span/number of points in spectrum display) < 0.5 RBW. Otherwise use peak detector mode. Use a video trigger with the trigger level set to enable triggering only on full power pulses. Transmitter must operate at full control power for entire sweep of every sweep. If the device transmits continuously, with no off intervals or reduced power intervals, the trigger may be set to “free run”. Trace average 100 traces in power averaging mode. Compute power by integrating the spectrum across the 26 dB EBW of the signal. The integration can be performed using the spectrum analyzer’s band power measurement function with band limits set equal to the EBW band edges or by summing power levels in each 1 MHz band in linear power terms. The 1 MHz band power levels to be summed can be obtained by averaging, in linear power terms, power levels in each frequency bin across the 1 MHz.

TEST RESULTS

No non-compliance noted



Test Data

Test mode: IEEE 802.11a mode / 5180 ~ 5240MHz

Channel	Frequency (MHz)	Maximum Conducted Output Power (dBm)	Limit (dBm)
Low	5180	11.50	17.00
Mid	5220	11.40	17.00
High	5240	11.50	17.00

Test mode: IEEE 802.11n HT 20 MHz Channel mode / 5180 ~ 5240MHz

Channel	Frequency (MHz)	Maximum Conducted Output Power (dBm)	Limit (dBm)
Low	5180	11.40	17.00
Mid	5220	11.30	17.00
High	5240	11.40	17.00

Test mode: IEEE 802.11n HT 40 MHz mode / 5190 ~ 5230MHz

Channel	Frequency (MHz)	Maximum Conducted Output Power (dBm)	Limit (dBm)
Low	5190	9.70	17.00
High	5230	9.70	17.00

Test mode: IEEE 802.11a mode / 5260 ~ 5320MHz

Channel	Frequency (MHz)	Maximum Conducted Output Power (dBm)	Limit (dBm)
Low	5260	11.40	24.00
Mid	5280	11.40	24.00
High	5320	11.40	24.00

Test mode: IEEE 802.11n HT 20 MHz Channel mode / 5260 ~ 5320MHz

Channel	Frequency (MHz)	Maximum Conducted Output Power (dBm)	Limit (dBm)
Low	5260	11.20	24.00
Mid	5280	11.20	24.00
High	5320	11.10	24.00

Test mode: IEEE 802.11n HT 40 MHz mode / 5270 ~ 5310MHz

Channel	Frequency (MHz)	Maximum Conducted Output Power (dBm)	Limit (dBm)
Low	5270	9.50	24.00
High	5310	9.50	24.00



Test mode: IEEE 802.11a mode / 5500 ~ 5700MHz

Channel	Frequency (MHz)	Maximum Conducted Output Power (dBm)	Limit (dBm)
Low	5500	11.20	24.00
Mid	5580	11.00	24.00
High	5700	11.30	24.00

Test mode: IEEE 802.11n HT 20 MHz Channel mode / 5500 ~ 5700MHz

Channel	Frequency (MHz)	Maximum Conducted Output Power (dBm)	Limit (dBm)
Low	5500	11.10	24.00
Mid	5580	10.90	24.00
High	5700	11.20	24.00

Test mode: IEEE 802.11n HT 40 MHz mode / 5510 ~ 5670MHz

Channel	Frequency (MHz)	Maximum Conducted Output Power (dBm)	Limit (dBm)
Low	5510	8.80	24.00
Mid	5550	9.60	24.00
High	5670	9.60	24.00

Remark: Total Output Power (w) = Chain 0 (10^(Output Power /10)/1000) + Chain 1 (10^(Output Power /10)/1000)



8.4 BAND EDGES MEASUREMENT

LIMIT

According to §15.407(b) & RSS-210 §A8.5,

- (1) The provisions of Section 15.205 of this part apply to intentional radiators operating under this section.
- (2) When measuring the emission limits, the nominal carrier frequency shall be adjusted as close to the upper and lower frequency block edges as the design of the equipment permits.

Test Configuration

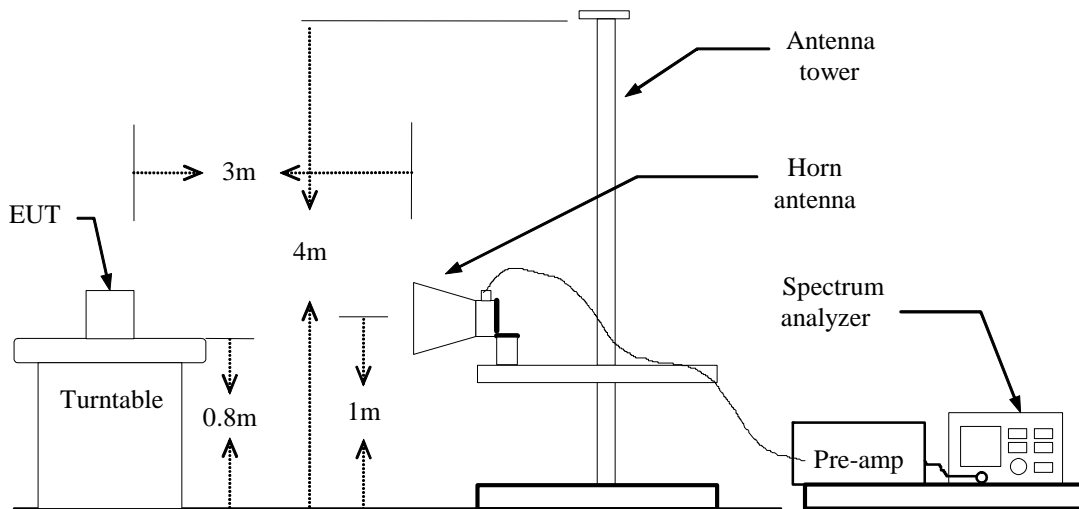

TEST PROCEDURE

1. The EUT is placed on a turntable, which is 0.8m above the ground plane.
2. The turntable shall be rotated for 360 degrees to determine the position of maximum emission level.
3. EUT is set 3m away from the receiving antenna, which is varied from 1m to 4m to find out the highest emission.
4. Set the spectrum analyzer in the following setting in order to capture the lower and upper band-edges of the emission:
 - (a) PEAK: RBW=VBW=1MHz / Sweep=AUTO
 - (b) AVERAGE: RBW=1MHz / VBW=300Hz / Sweep=AUTO
5. Repeat the procedures until all the PEAK and AVERAGE versus POLARIZATION are measured.

TEST RESULTS

Refer to attach spectrum analyzer data chart.



Band Edges (IEEE 802.11a mode / 5180 MHz)

Detector mode: Peak

Polarity: Vertical

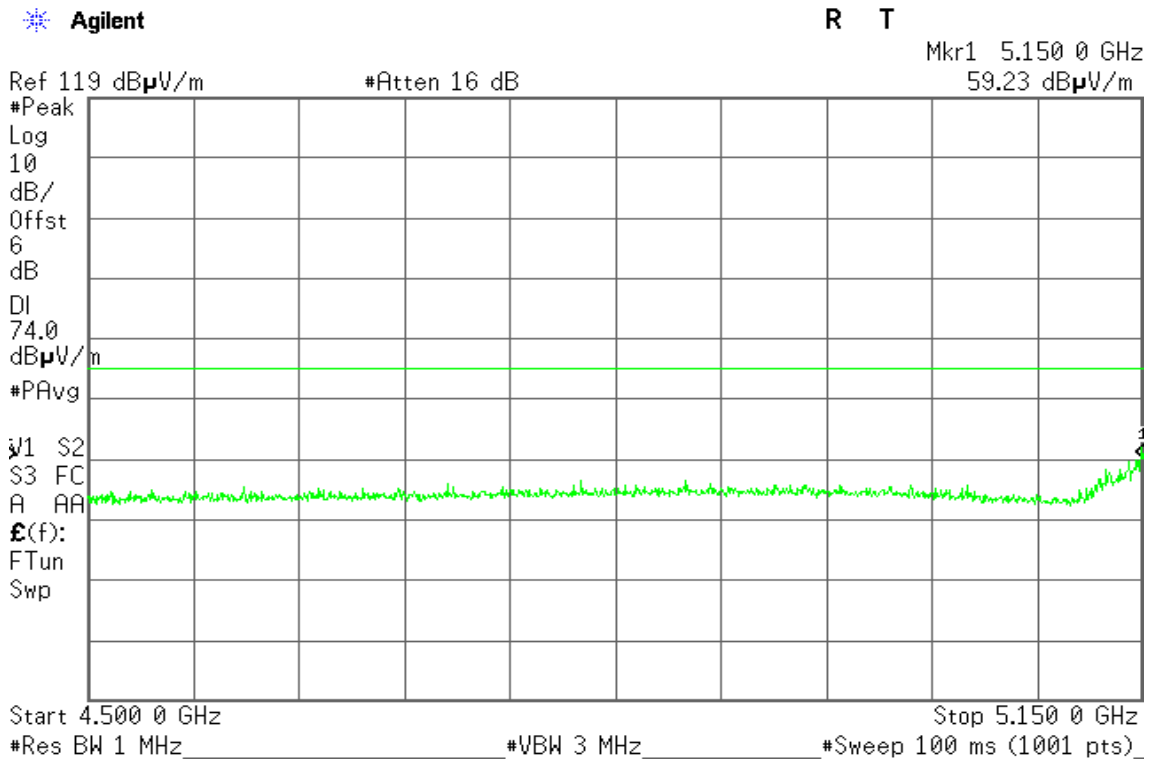

Detector mode: Average

Polarity: Vertical

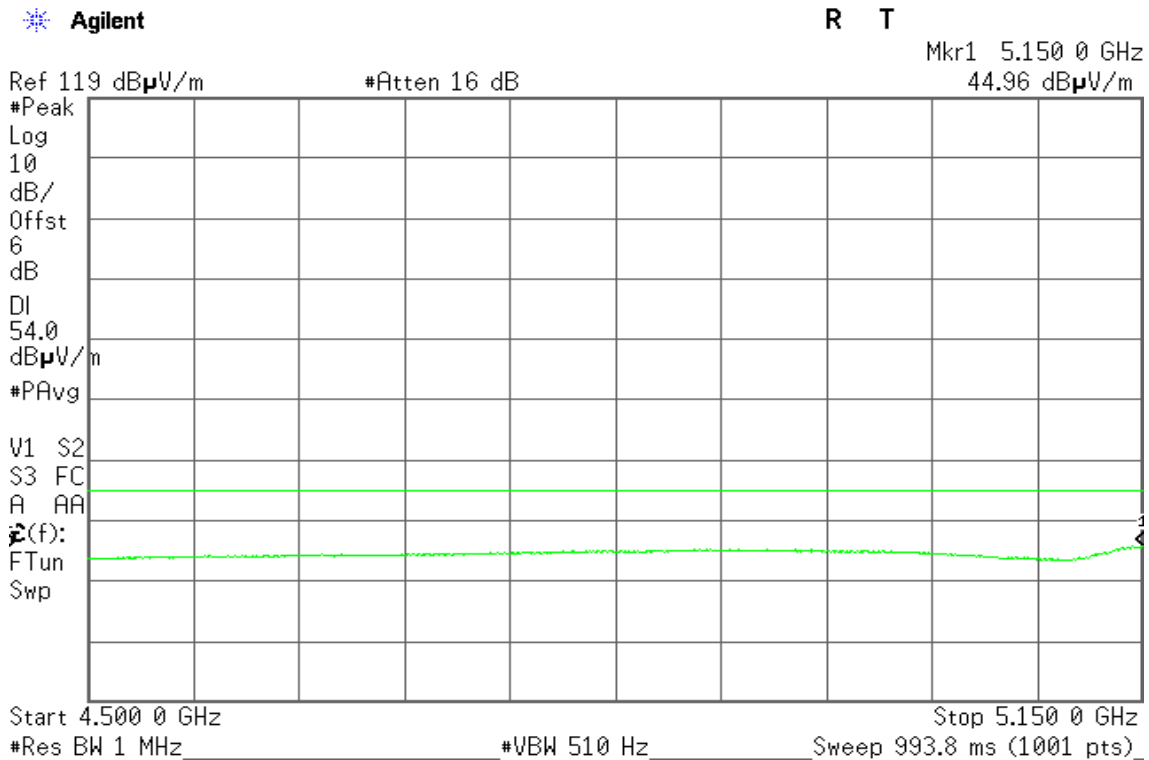



Detector mode: Peak

Polarity: Horizontal

Agilent

R T

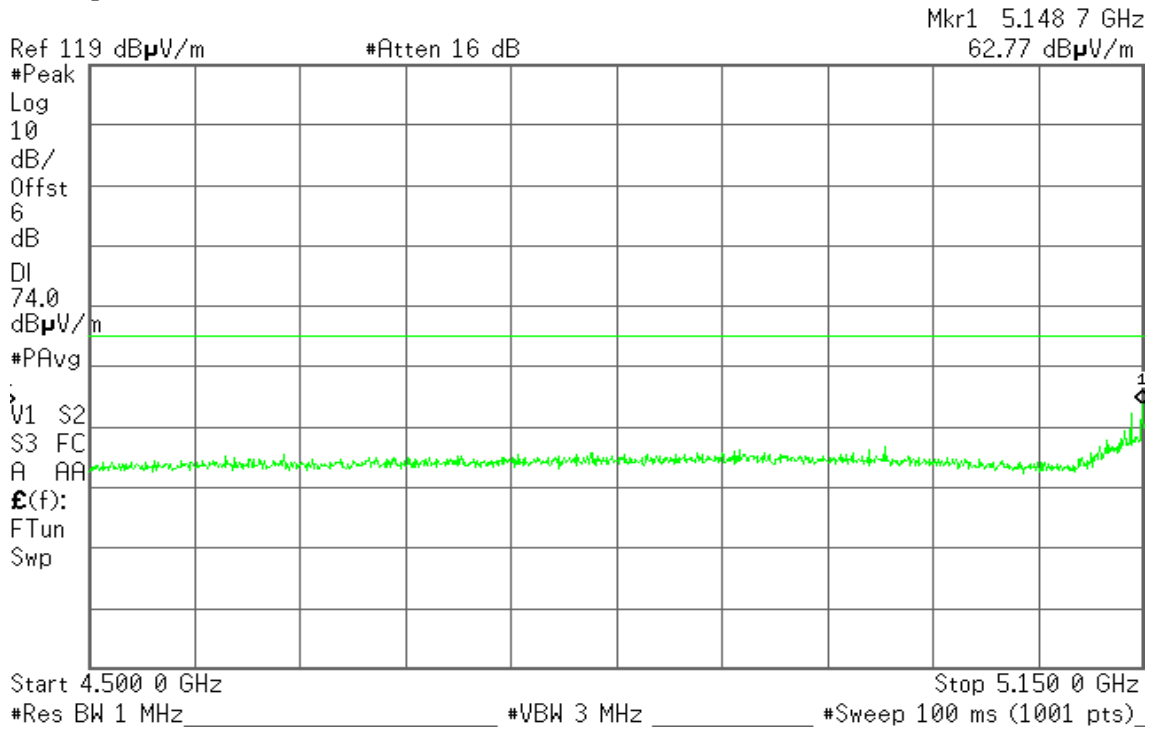

Detector mode: Average

Polarity: Horizontal

Agilent

R T

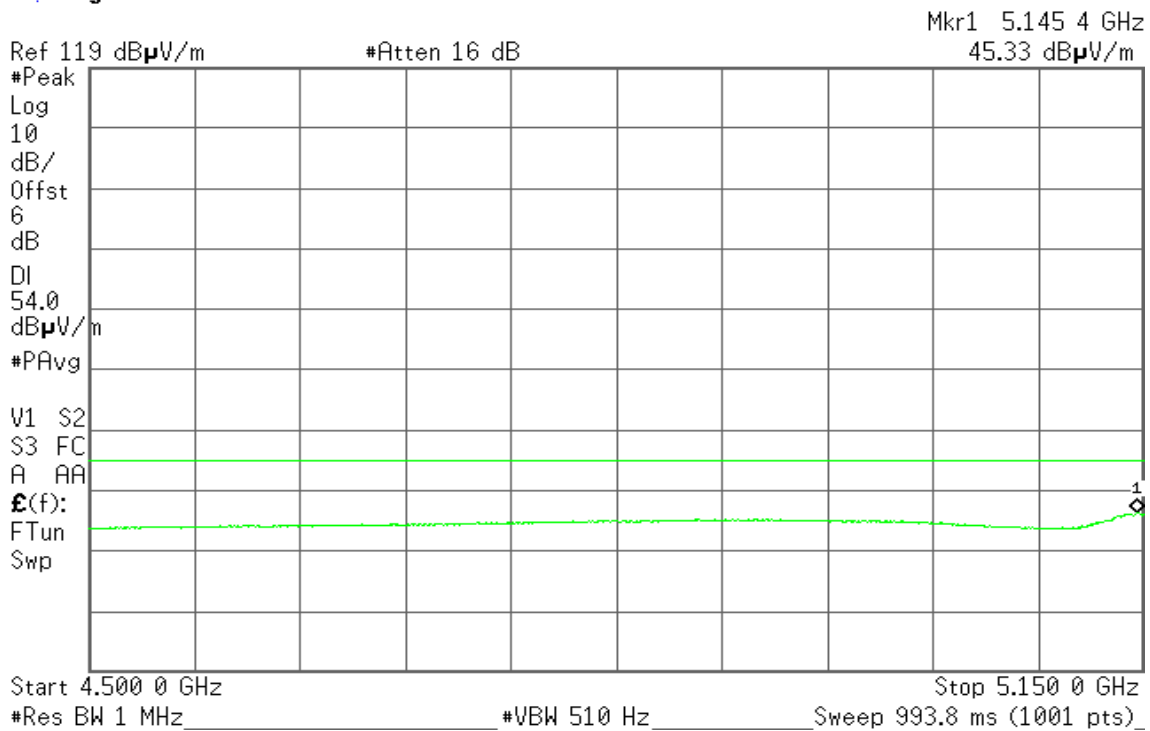



Band Edges (IEEE 802.11a mode / 5320 MHz)

Detector mode: Peak

Polarity: Vertical

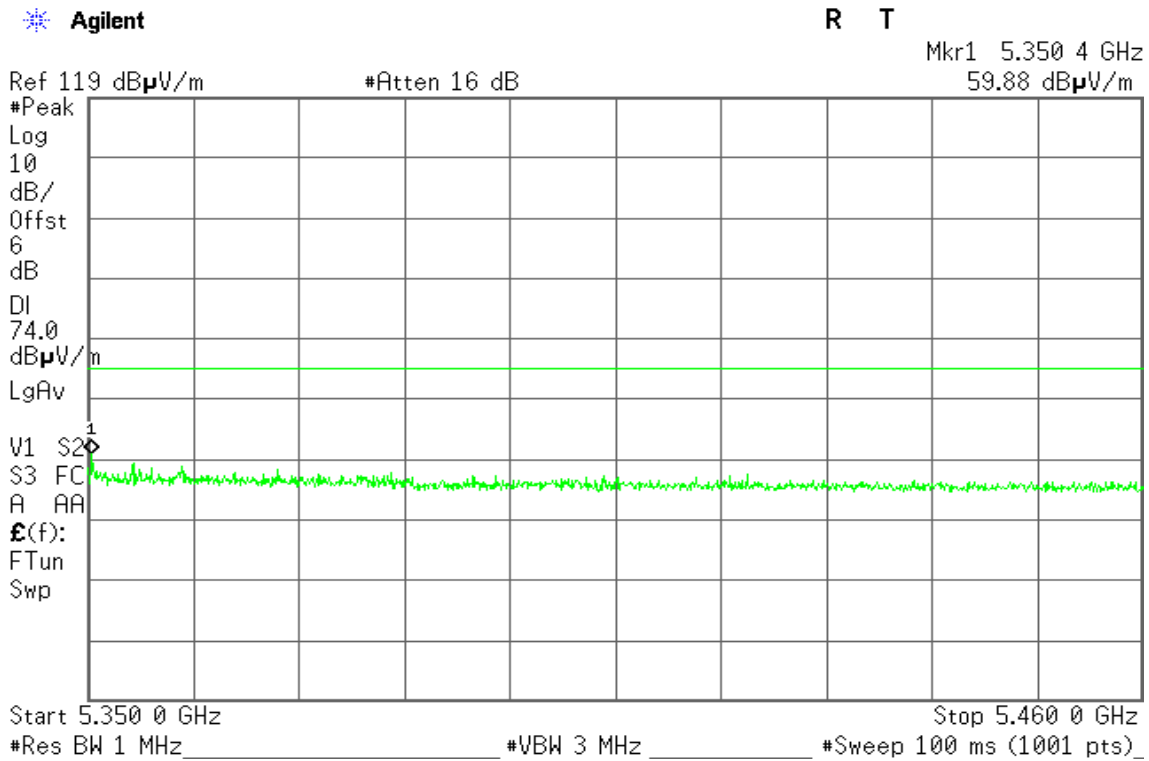

Detector mode: Average

Polarity: Vertical

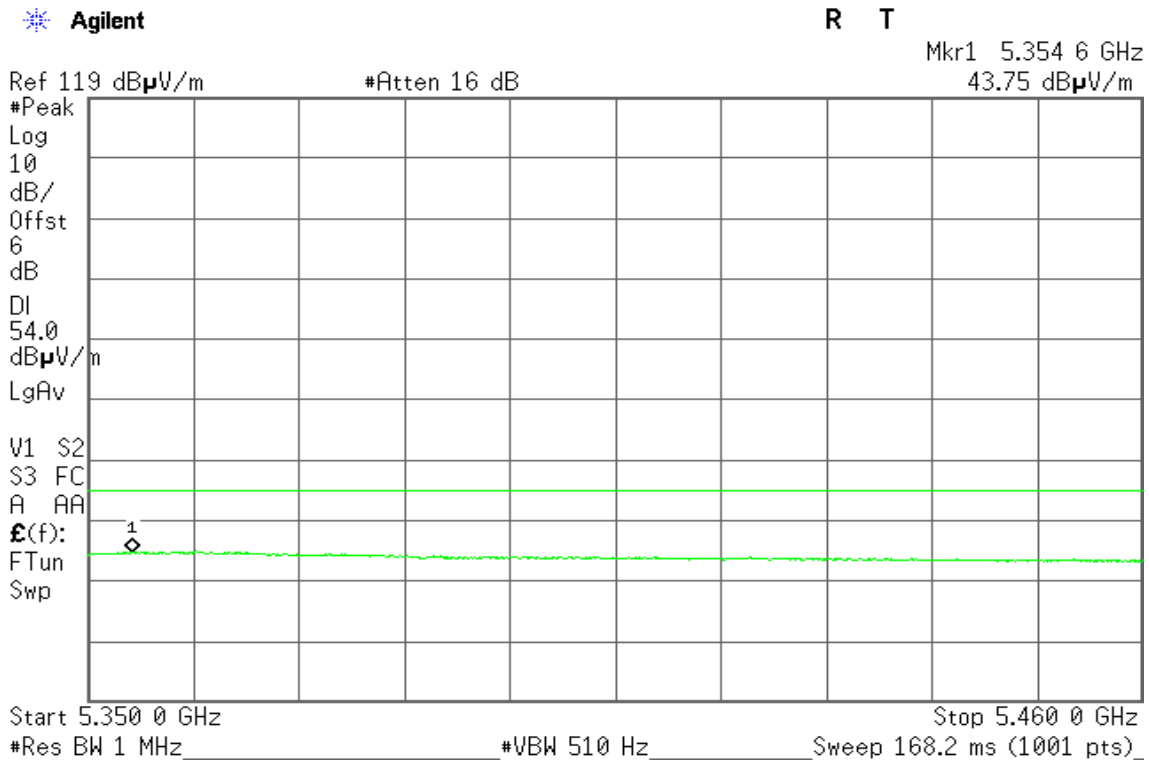



Detector mode: Peak

Polarity: Horizontal

Agilent

R T

Mkr1 5.350 1 GHz
67.82 dBµV/m

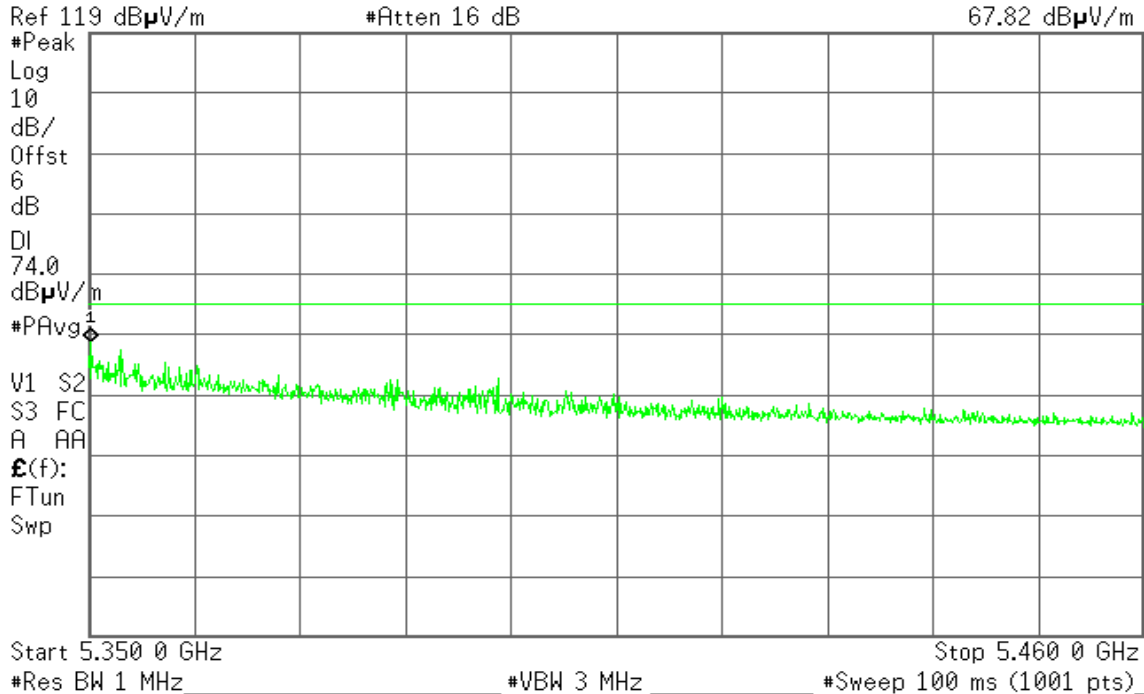

Detector mode: Average

Polarity: Horizontal

Agilent

R T

Mkr1 5.359 1 GHz
50.10 dBµV/m

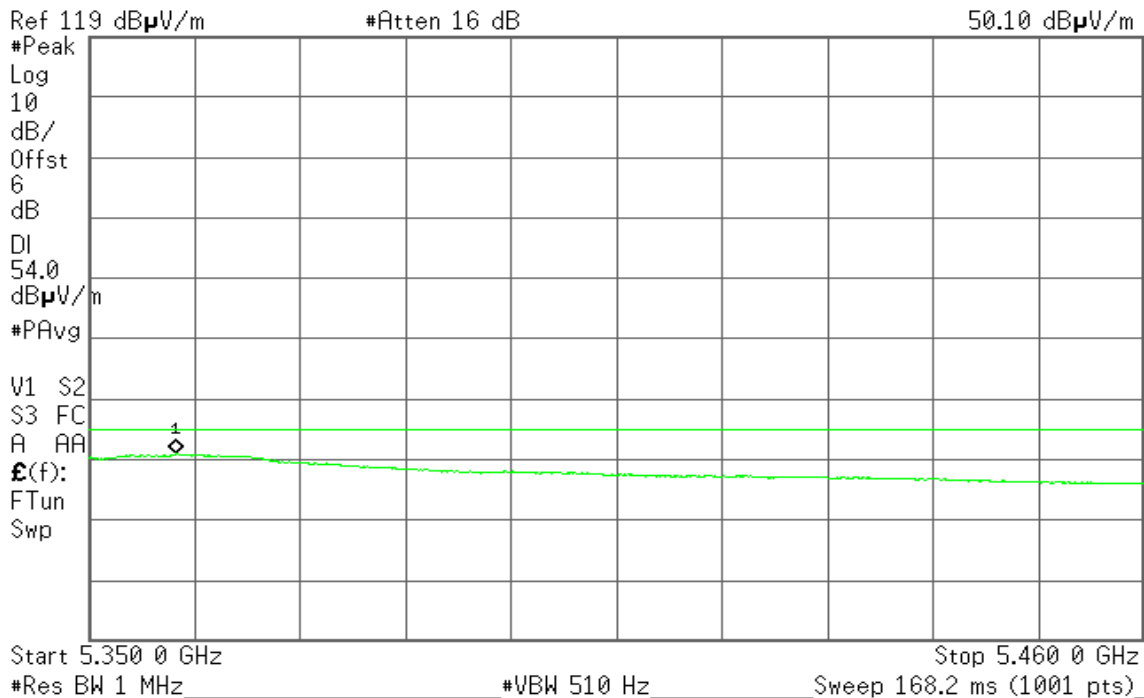



Band Edges (IEEE 802.11n HT 20 MHz Channel mode / 5180 MHz)

Detector mode: Peak

Polarity: Vertical

Agilent

R T

Mkr1 5.143 5 GHz
60.29 dBµV/m

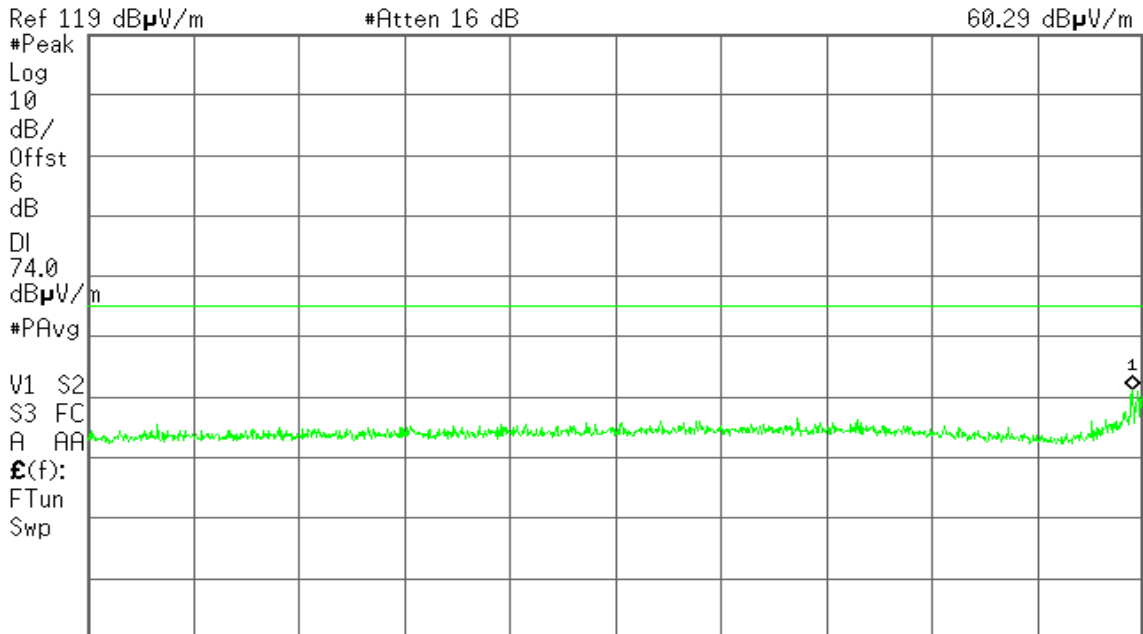

Start 4.500 0 GHz Stop 5.150 0 GHz
#Res BW 1 MHz #VBW 3 MHz #Sweep 100 ms (1001 pts)

Detector mode: Average

Polarity: Vertical

Agilent

R T

Mkr1 5.137 0 GHz
49.08 dBµV/m

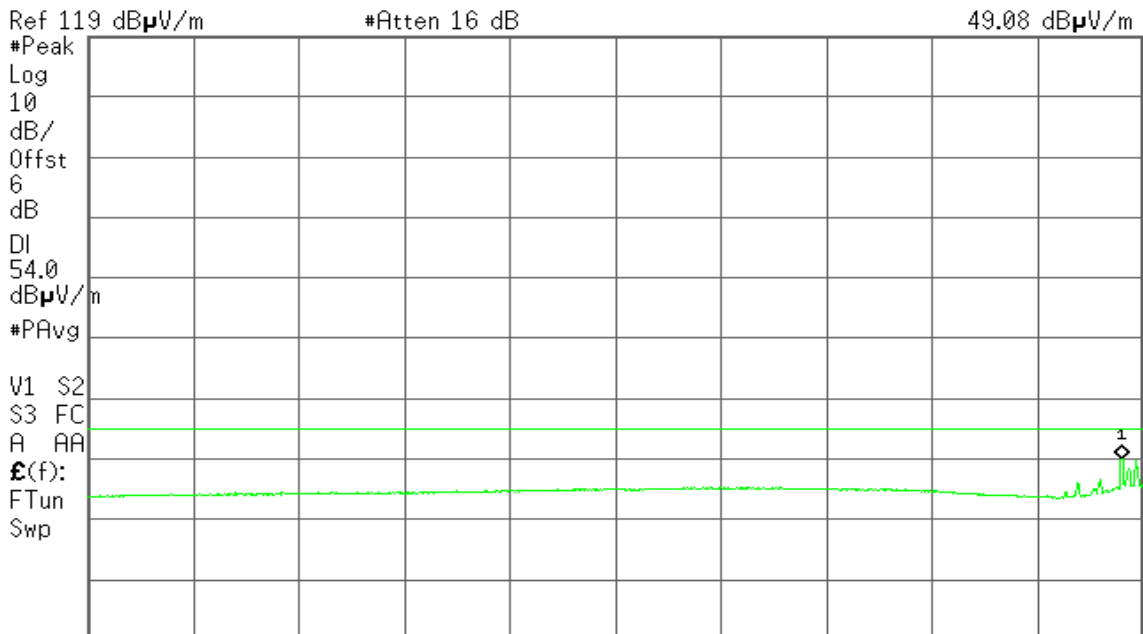

Start 4.500 0 GHz Stop 5.150 0 GHz
#Res BW 1 MHz #VBW 560 Hz Sweep 905.1 ms (1001 pts)



Detector mode: Peak

Polarity: Horizontal

Agilent

R T

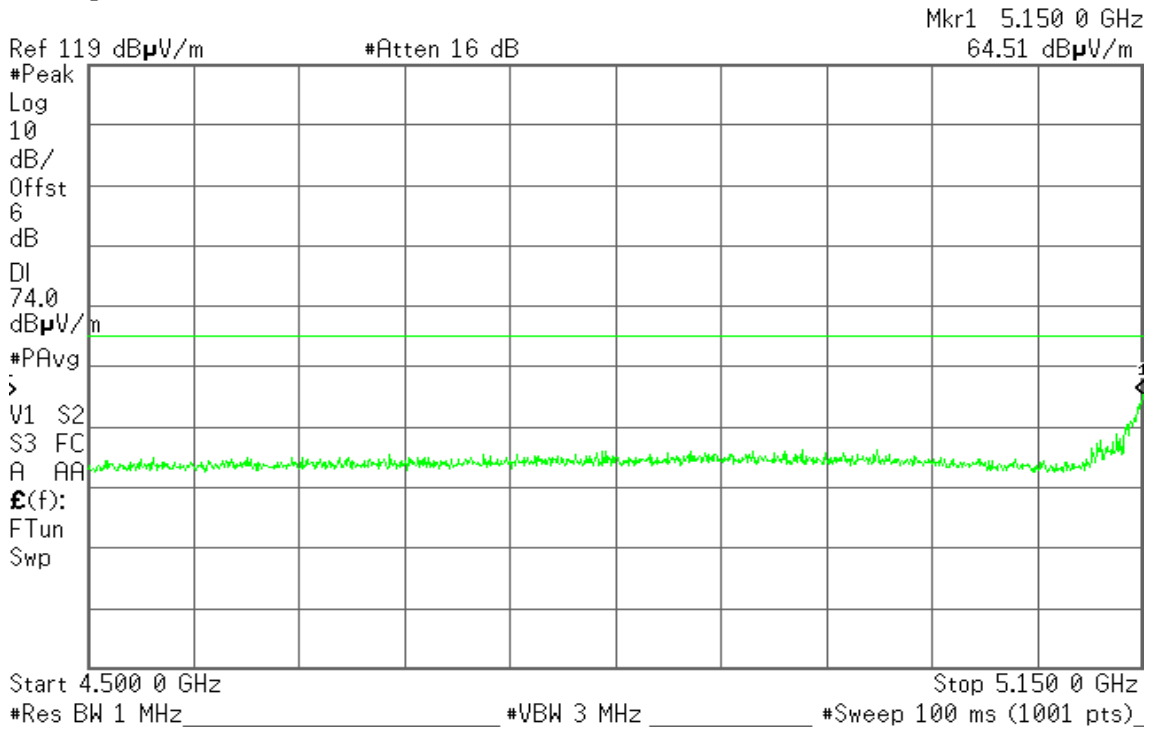

Detector mode: Average

Polarity: Horizontal

Agilent

R T

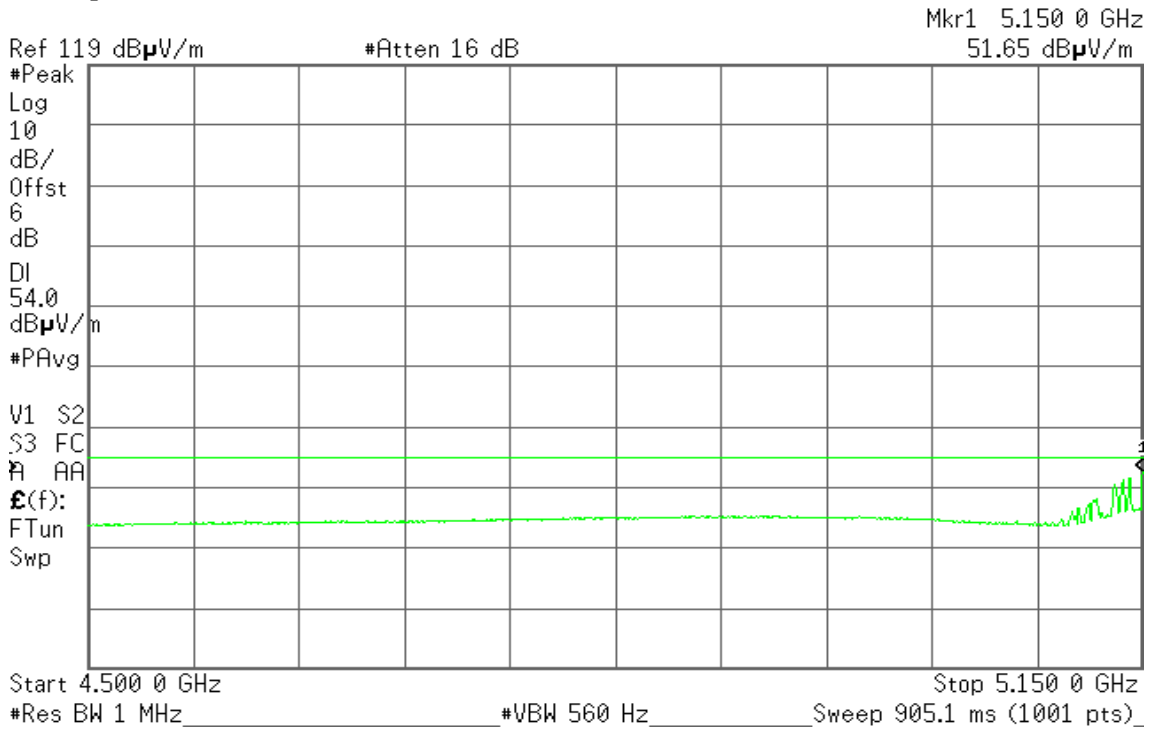



Band Edges (IEEE 802.11n HT 20 MHz Channel mode / 5320 MHz)

Detector mode: Peak

Polarity: Vertical

Agilent

R T

Mkr1 5.351 0 GHz
66.32 dBµV/m

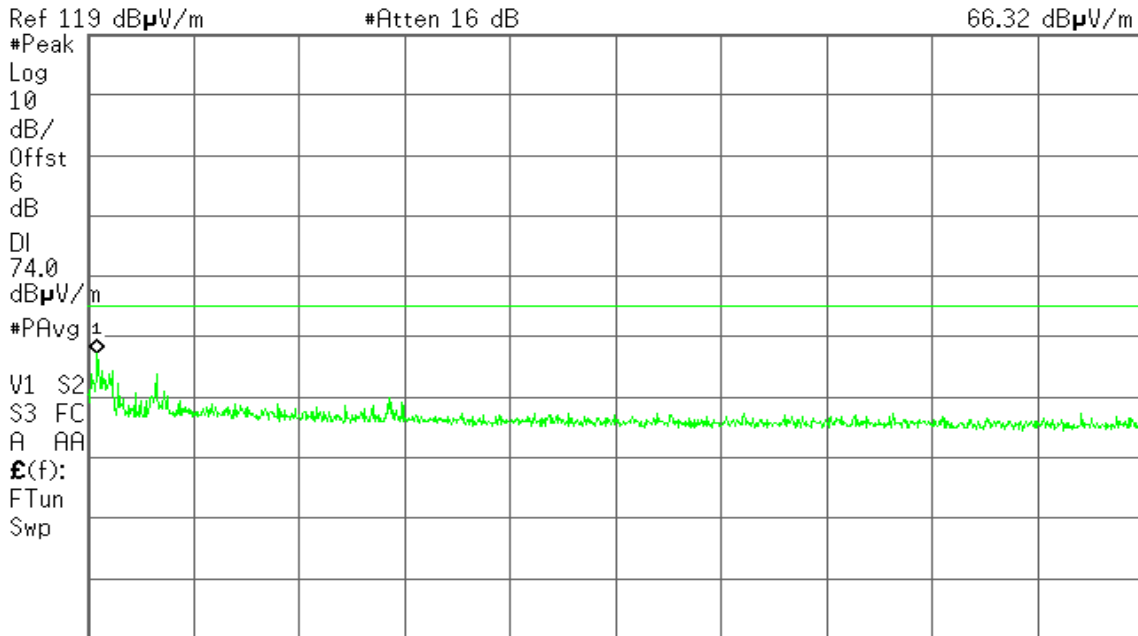

Start 5.350 0 GHz Stop 5.460 0 GHz
#Res BW 1 MHz #VBW 3 MHz #Sweep 100 ms (1001 pts)

Detector mode: Average

Polarity: Vertical

Agilent

R T

Mkr1 5.350 7 GHz
52.38 dBµV/m

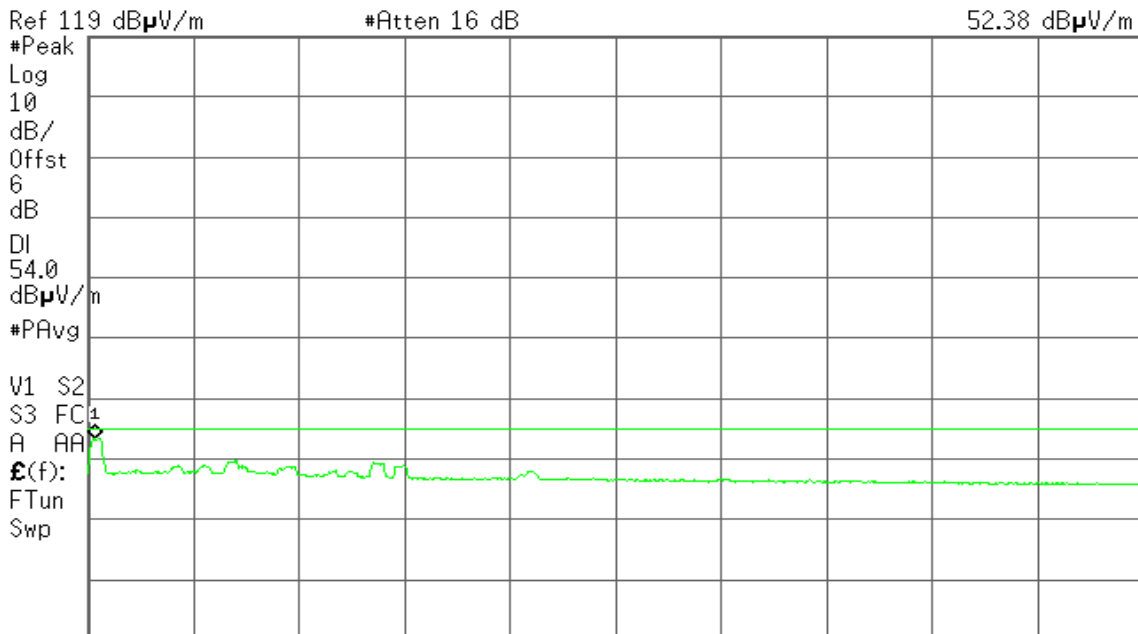

Start 5.350 0 GHz Stop 5.460 0 GHz
#Res BW 1 MHz #VBW 560 Hz Sweep 153.2 ms (1001 pts)



Detector mode: Peak

Polarity: Horizontal

Agilent

R T

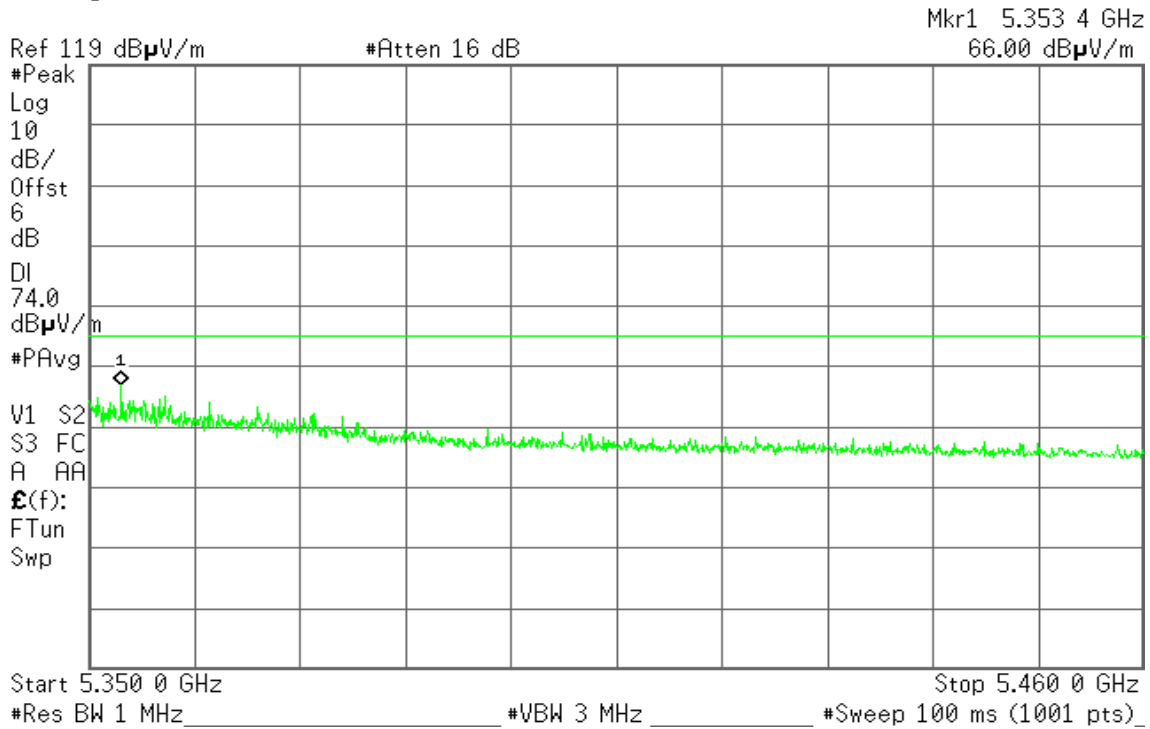

Detector mode: Average

Polarity: Horizontal

Agilent

R T

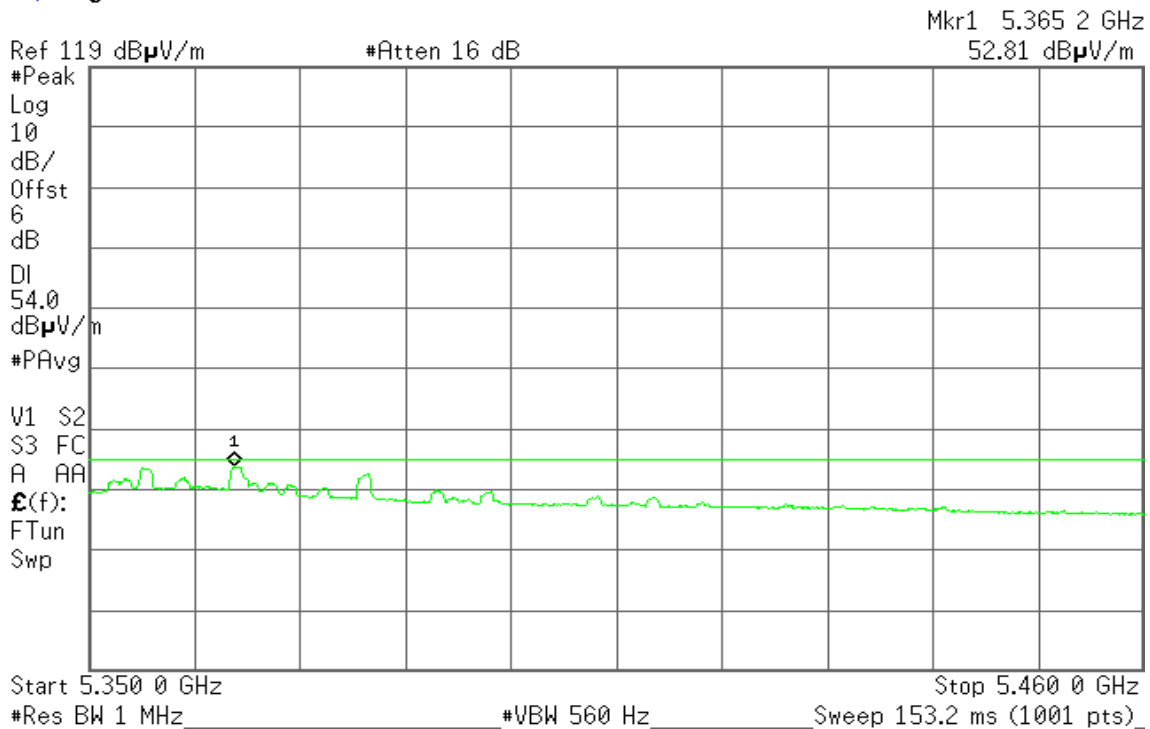



Band Edges (IEEE 802.11n HT 40 MHz mode / 5190 MHz)

Detector mode: Peak

Polarity: Vertical

Agilent

R T

Mkr1 5.149 4 GHz
65.51 dBµV/m

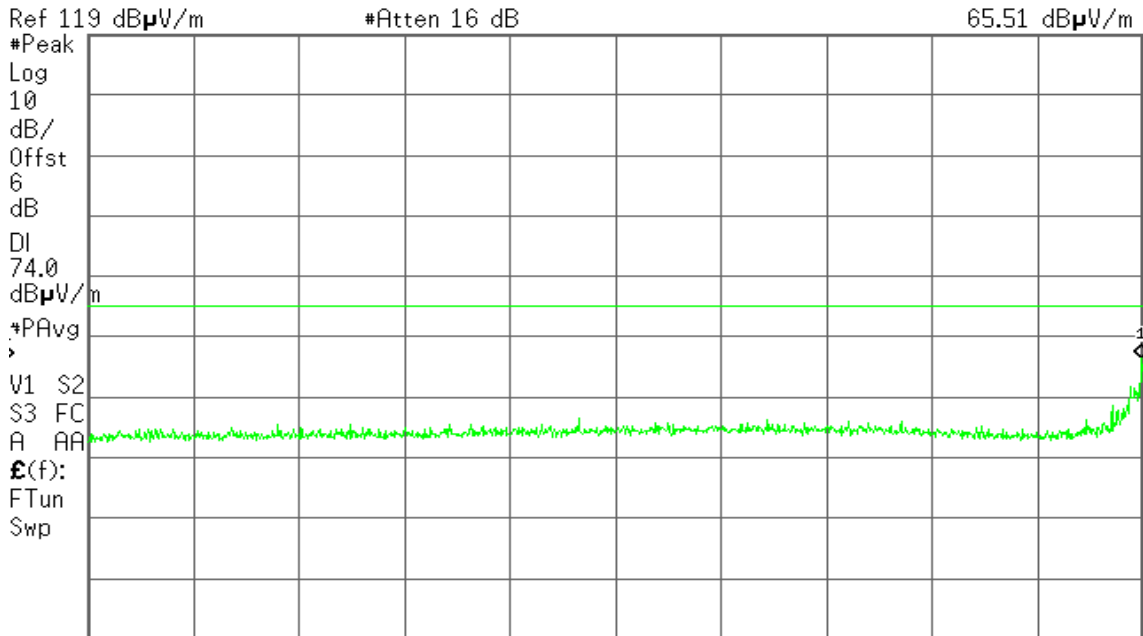

Start 4.500 0 GHz Stop 5.150 0 GHz
#Res BW 1 MHz #VBW 3 MHz #Sweep 100 ms (1001 pts)

Detector mode: Average

Polarity: Vertical

Agilent

R T

Mkr1 5.150 0 GHz
50.41 dBµV/m

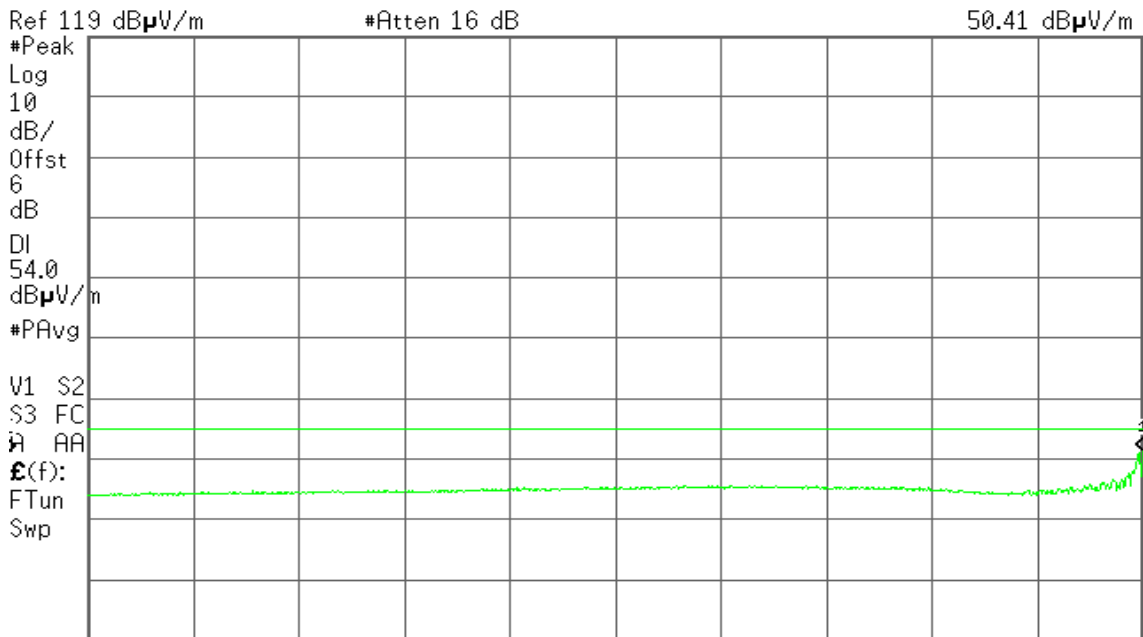

Start 4.500 0 GHz Stop 5.150 0 GHz
#Res BW 1 MHz #VBW 1.1 kHz Sweep 460.8 ms (1001 pts)



Detector mode: Peak

Polarity: Horizontal

Agilent

R T

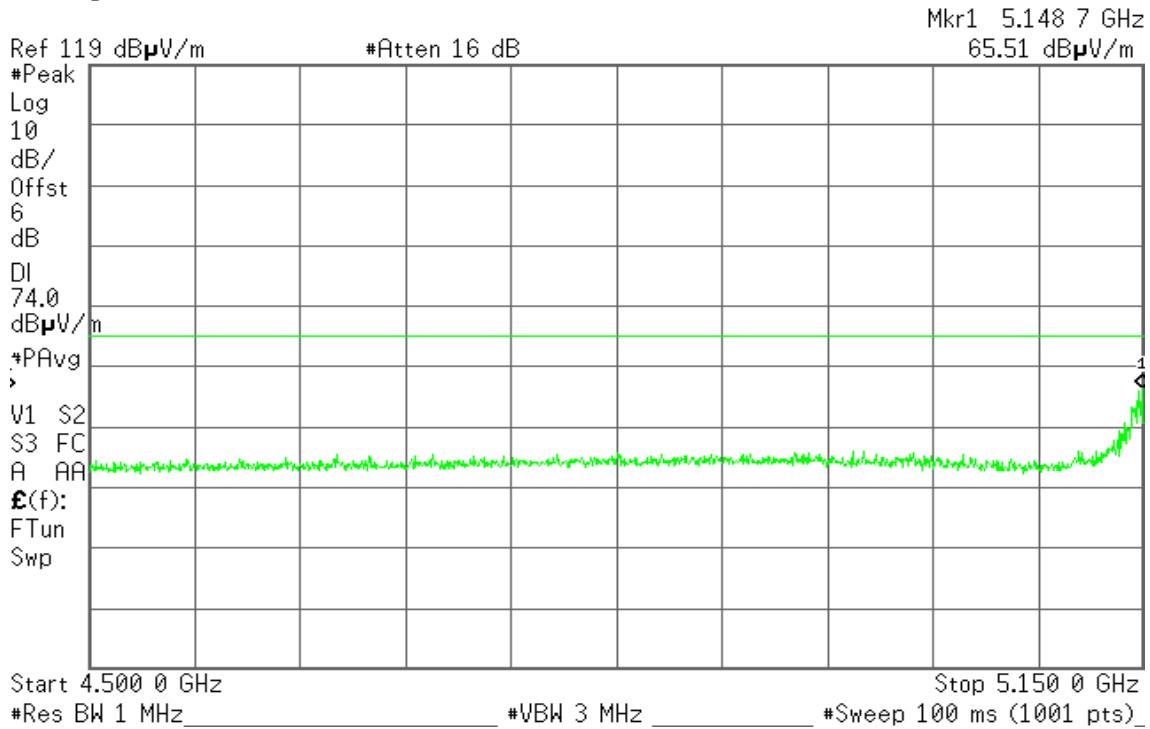

Detector mode: Average

Polarity: Horizontal

Agilent

R T

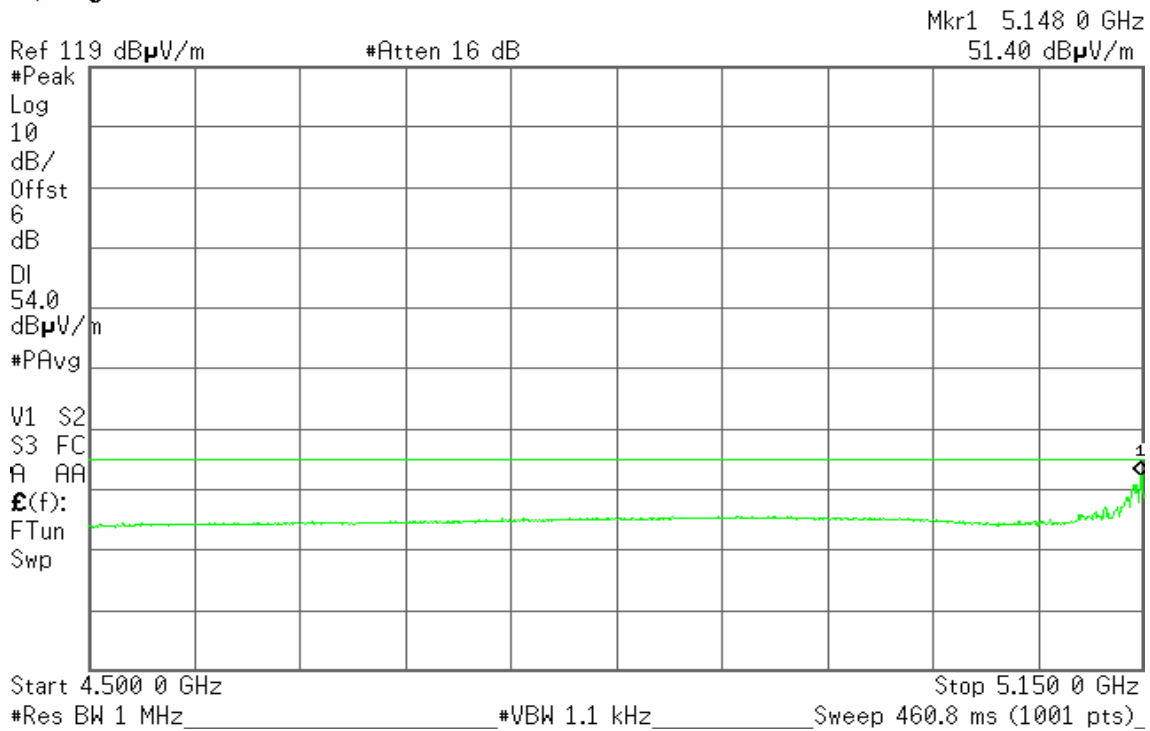



Band Edges (IEEE 802.11n HT 40 MHz mode / CH 5310 MHz)

Detector mode: Peak

Polarity: Vertical

Agilent

R T

Mkr1 5.352 6 GHz
64.42 dBµV/m

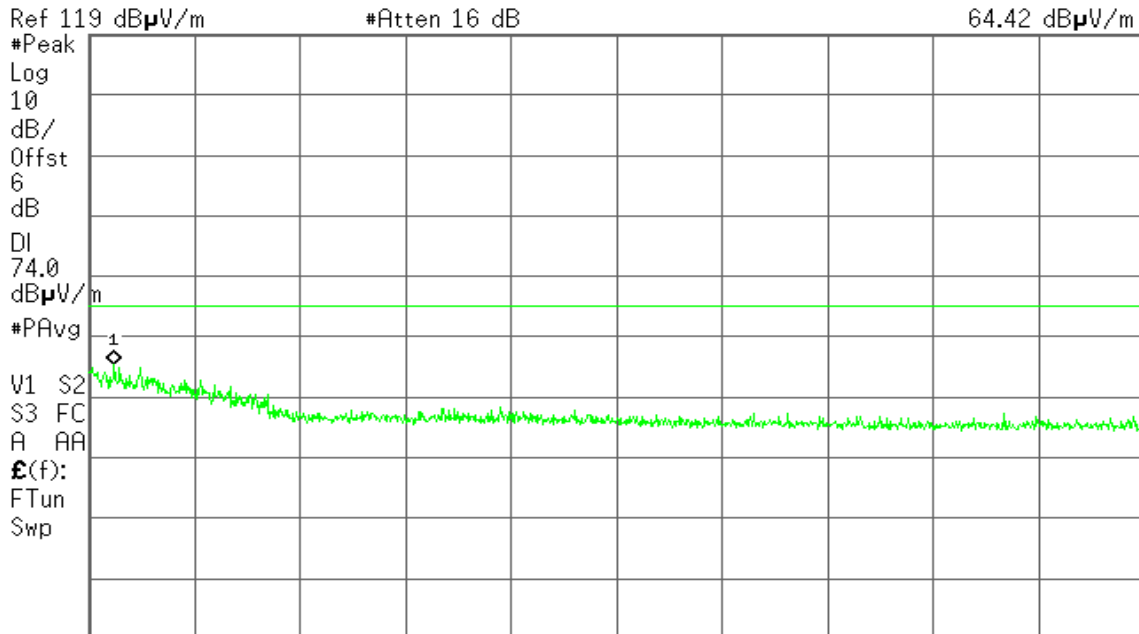

Start 5.350 0 GHz Stop 5.460 0 GHz
#Res BW 1 MHz #VBW 3 MHz #Sweep 100 ms (1001 pts)

Detector mode: Average

Polarity: Vertical

Agilent

R T

Mkr1 5.350 7 GHz
48.44 dBµV/m

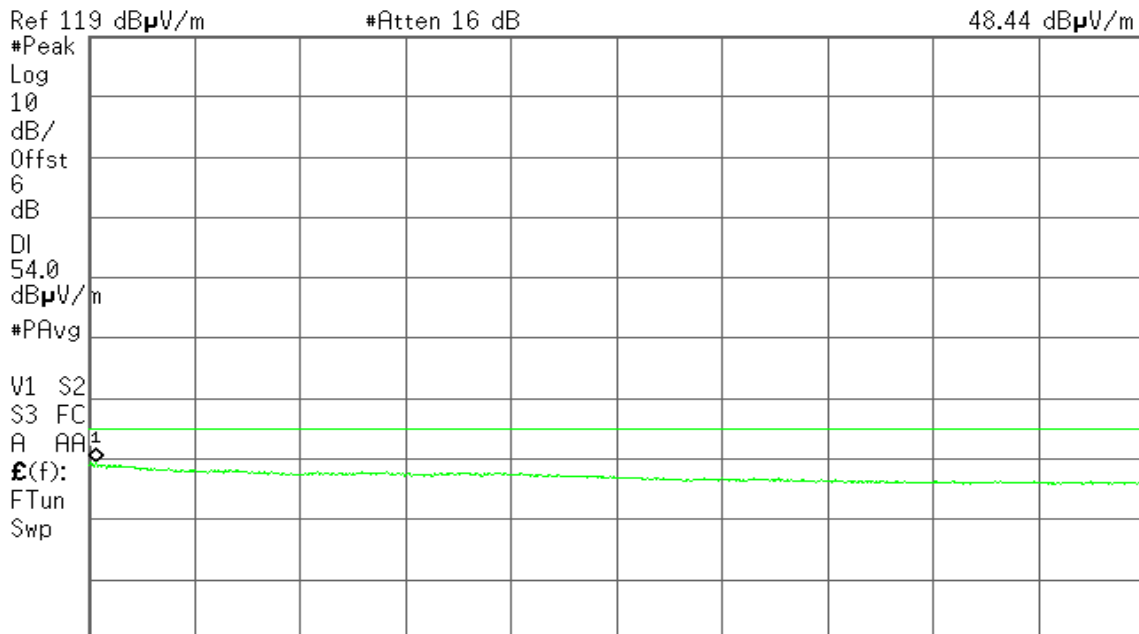

Start 5.350 0 GHz Stop 5.460 0 GHz
#Res BW 1 MHz #VBW 1.1 kHz Sweep 78 ms (1001 pts)



Detector mode: Peak

Polarity: Horizontal

Agilent

R T

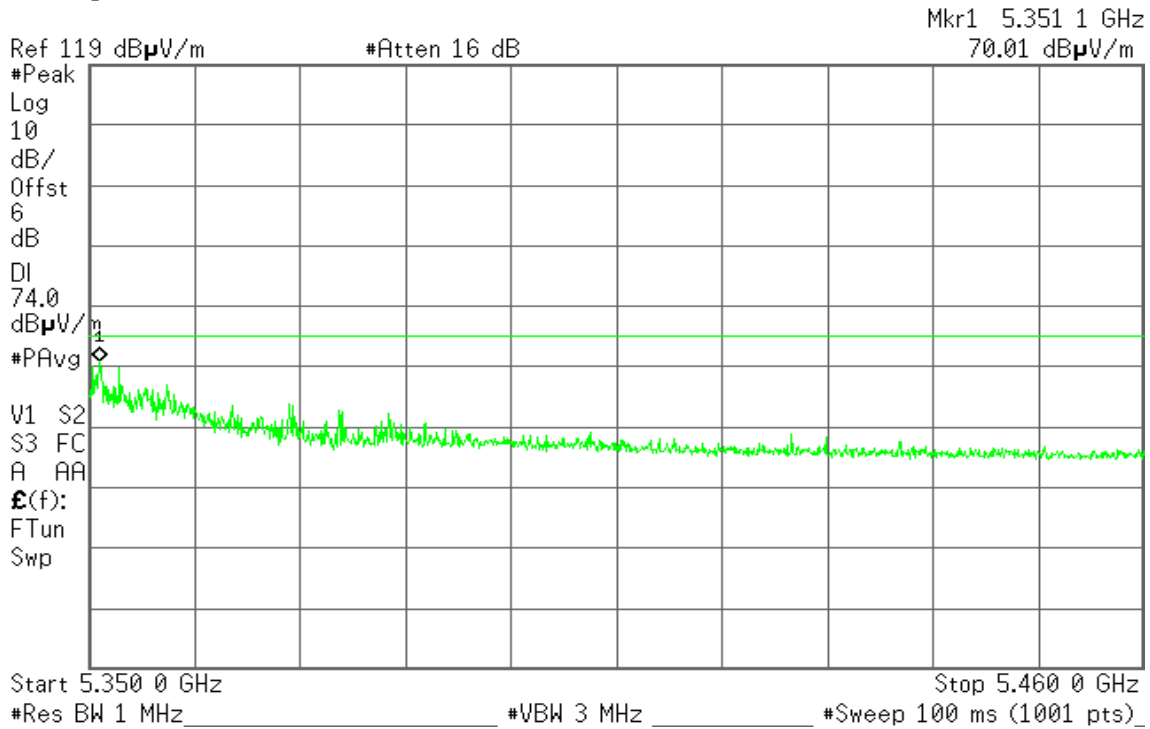

Detector mode: Average

Polarity: Horizontal

Agilent

R T

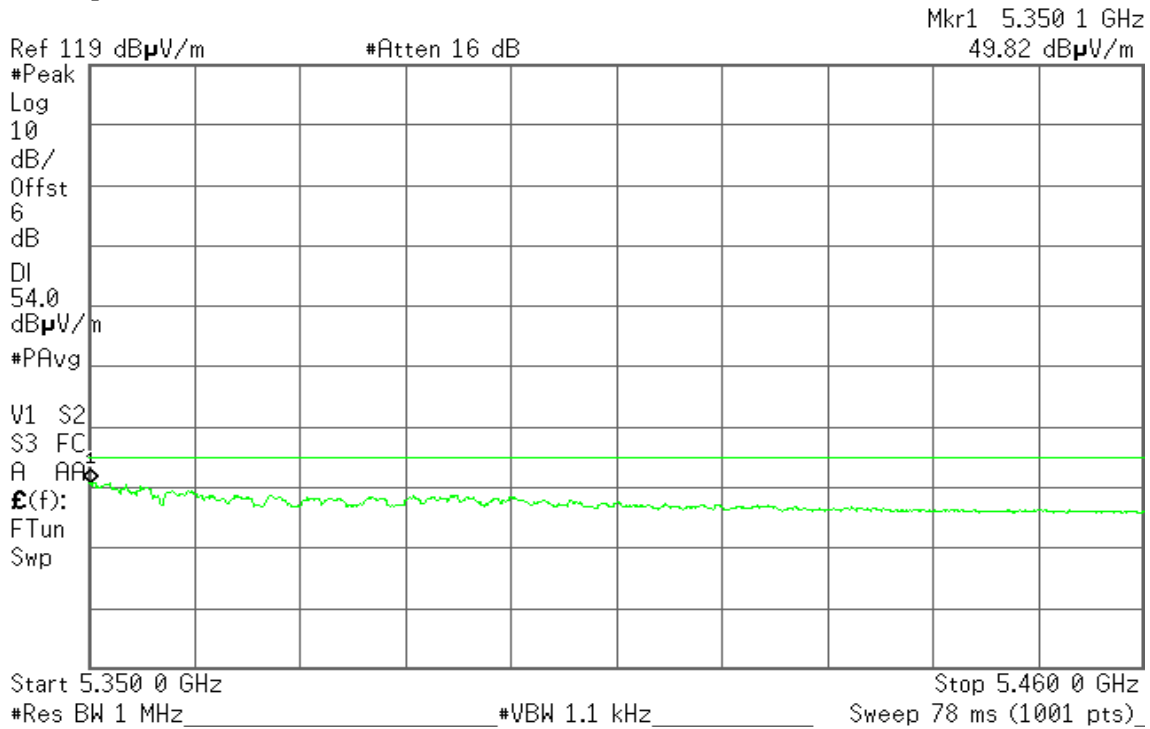



8.5 PEAK POWER SPECTRAL DENSITY

LIMIT

According to §15.407(a)

- (1) For the band 5.15-5.25 GHz, the peak power spectral density shall not exceed 4dBm in any 1MHz band.
- (2) For the band 5.25-5.35 GHz, the peak power spectral density shall not exceed 11dBm in any 1MHz band.

According to RSS-210 §A9.2,

- (1) The e.i.r.p. spectral density shall not exceed 10 dBm in any 1.0 MHz band.
- (2) The power spectral density shall not exceed 11 dBm in any 1.0 MHz band.

If transmitting antennas of directional gain greater than 6dBi are used, both the peak transmit power and the peak power spectral density shall be reduced by the amount in dB that the directional gain of the antenna exceeds 6dBi.

Test Configuration

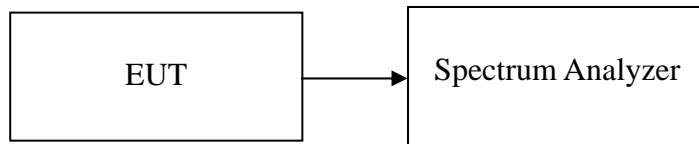

TEST PROCEDURE

1. Place the EUT on the table and set it in transmitting mode.
Remove the antenna from the EUT and then connect a low loss RF cable from the antenna port to the spectrum analyzer.
2. Set the spectrum analyzer as RBW = 1MHz, VBW = 3MHz, Span = Sweep= AUTO
3. Record the max. reading.
4. Repeat the above procedure until the measurements for all frequencies are completed

TEST RESULTS

No non-compliance noted



Test Data

Test mode: IEEE 802.11a mode / 5180 ~ 5240MHz

Channel	Frequency (MHz)	PPSD (dBm)	Limit (dBm)	Result
Low	5180	-0.31	11.00	PASS
Mid	5220	-0.30	11.00	PASS
High	5240	-0.40	11.00	PASS

Test mode: IEEE 802.11n HT 20 MHz Channel mode / 5180 ~ 5240MHz

Channel	Frequency (MHz)	PPSD (dBm)	Limit (dBm)	Result
Low	5180	0.73	11.00	PASS
Mid	5220	0.95	11.00	PASS
High	5240	0.58	11.00	PASS

Test mode: IEEE 802.11n HT 40 MHz mode / 5190 ~ 5230MHz

Channel	Frequency (MHz)	PPSD (dBm)	Limit (dBm)	Result
Low	5190	-4.35	11.00	PASS
High	5230	-3.81	11.00	PASS

Remark: Total PPSD (dBm) = $10 * \text{LOG}(10^{(\text{Chain 0 PPSD} / 10)} + 10^{(\text{Chain 1 PPSD} / 10)})$



Test mode: IEEE 802.11a mode/ 5260 ~ 5320MHz

Channel	Frequency (MHz)	PPSD (dBm)	Limit (dBm)	Result
Low	5260	-0.25	11.00	PASS
Mid	5280	-0.34	11.00	PASS
High	5320	-0.25	11.00	PASS

Test mode: IEEE 802.11n HT 20 MHz Channel mode / 5260 ~ 5320MHz

Channel	Frequency (MHz)	PPSD (dBm)	Limit (dBm)	Result
Low	5260	0.85	11.00	PASS
Mid	5280	0.40	11.00	PASS
High	5320	0.84	11.00	PASS

Test mode: IEEE 802.11n HT 40 MHz mode / 5270 ~ 5310MHz

Channel	Frequency (MHz)	PPSD (dBm)	Limit (dBm)	Result
Low	5270	-3.93	11.00	PASS
High	5310	-4.03	11.00	PASS

Remark: Total PPSD (dBm) = $10 * \text{LOG}(10^{(\text{Chain 0 PPSD} / 10)} + 10^{(\text{Chain 1 PPSD} / 10)})$



Test mode: IEEE 802.11a mode / 5500 ~ 5700MHz

Channel	Frequency (MHz)	PPSD (dBm)	Limit (dBm)	Result
Low	5500	-0.17	11.00	PASS
Mid	5580	0.12	11.00	PASS
High	5700	-0.50	11.00	PASS

Test mode: IEEE 802.11n HT 20 MHz Channel mode / 5500 ~ 5700MHz

Channel	Frequency (MHz)	PPSD (dBm)	Limit (dBm)	Result
Low	5500	-0.94	11.00	PASS
Mid	5580	-0.43	11.00	PASS
High	5700	0.60	11.00	PASS

Test mode: IEEE 802.11n HT 40 MHz mode / 5510 ~ 5670MHz

Channel	Frequency (MHz)	PPSD (dBm)	Limit (dBm)	Result
Low	5510	-4.10	11.00	PASS
Mid	5550	-3.88	11.00	PASS
High	5670	-3.31	11.00	PASS

Remark: Total PPSD (dBm) = $10 * \text{LOG}(10^{(\text{Chain 0 PPSD} / 10)} + 10^{(\text{Chain 1 PPSD} / 10)})$



Test Plot
IEEE 802.11a mode / 5180 ~ 5240MHz

CH Low

Agilent

R T

Mkr1 5.180 87 GHz
-0.31 dBm

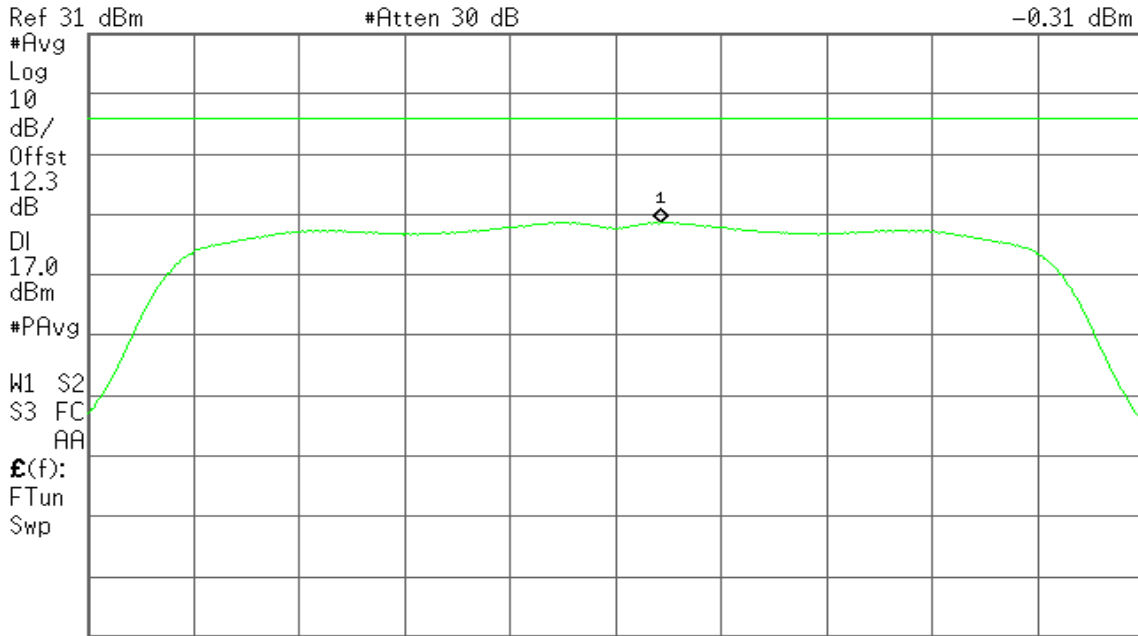

Center 5.180 00 GHz Span 20 MHz
#Res BW 1 MHz #VBW 3 MHz #Sweep 6 s (601 pts)

CH Mid

Agilent

R T

Mkr1 5.220 83 GHz
-0.30 dBm

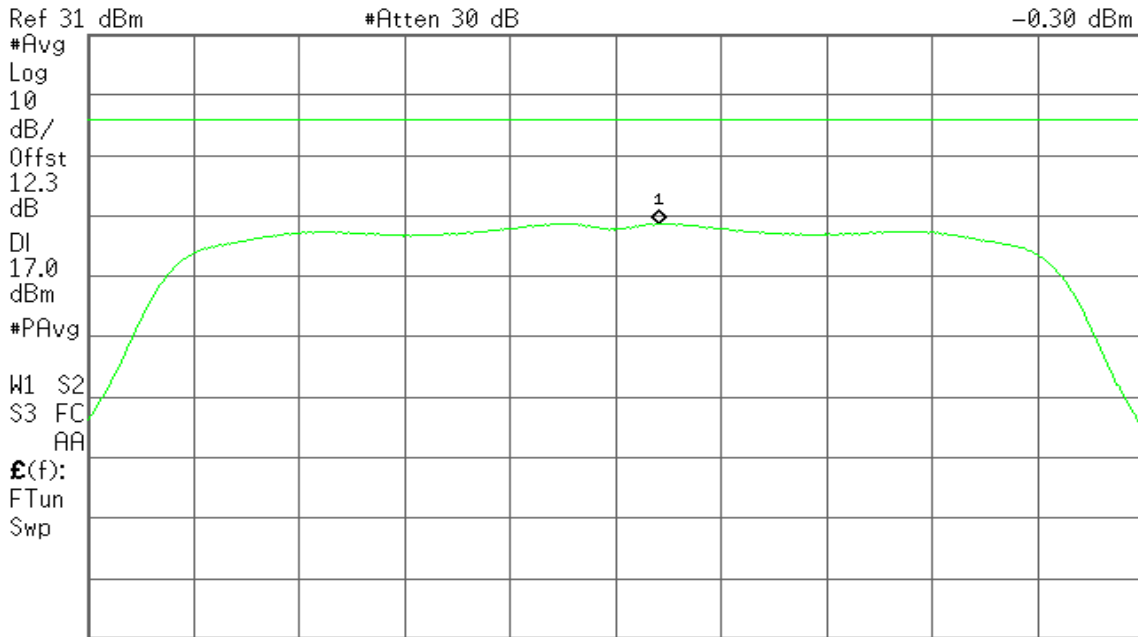

Center 5.220 00 GHz Span 20 MHz
#Res BW 1 MHz #VBW 3 MHz #Sweep 6 s (601 pts)



CH High

Agilent

R T

Mkr1 5.240 87 GHz
-0.40 dBm

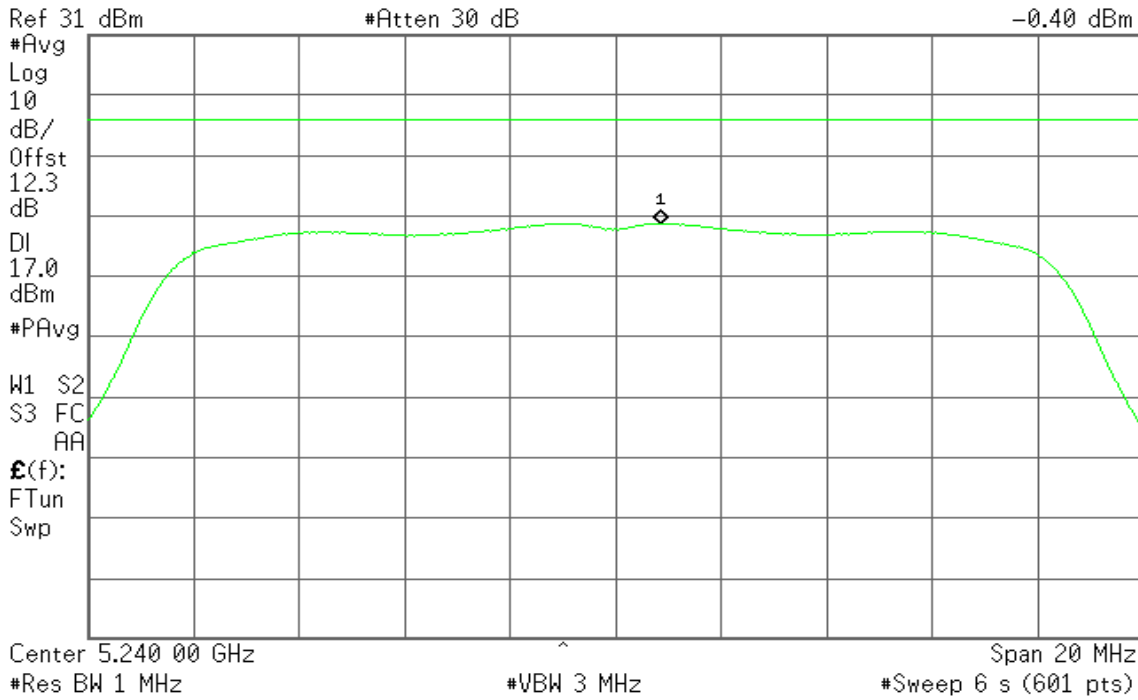

IEEE 802.11n HT 20 MHz Channel mode / 5180 ~ 5240MHz

CH Low

Agilent

R T

Mkr1 5.178 93 GHz
0.73 dBm

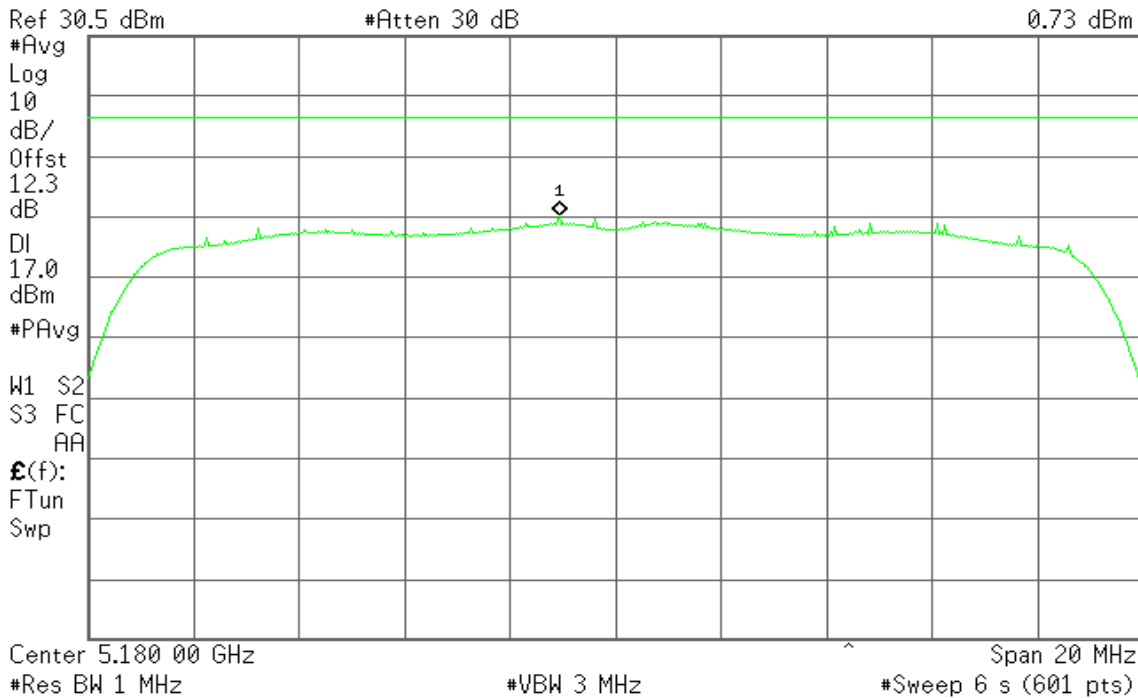



CH Mid

Agilent

R T

Mkr1 5.218 97 GHz
0.95 dBm

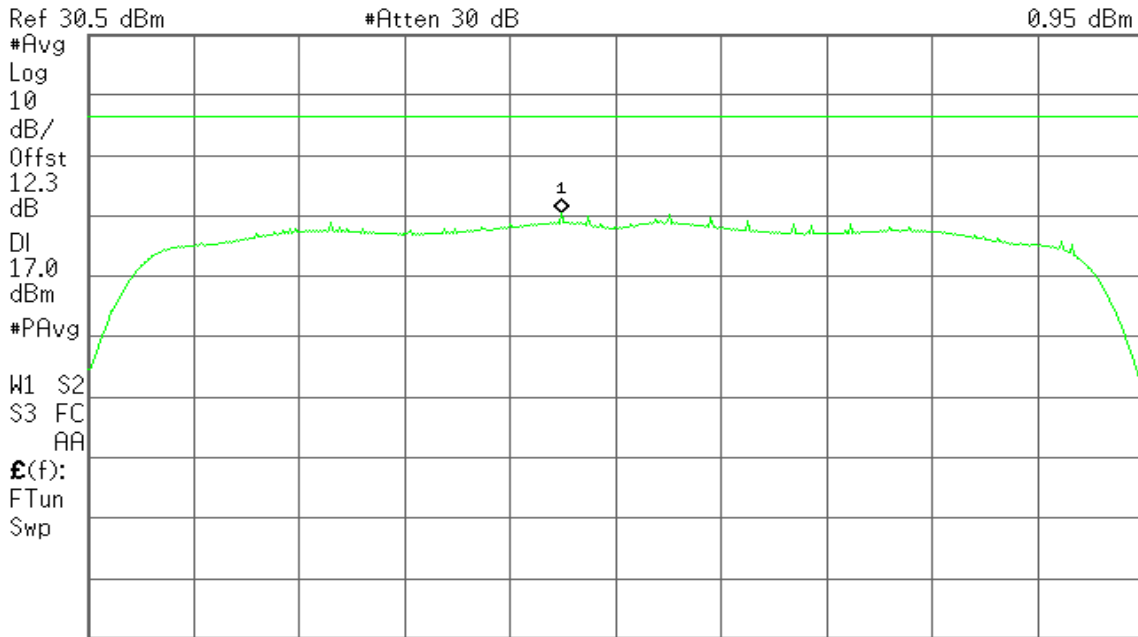

Center 5.220 00 GHz Span 20 MHz
#Res BW 1 MHz #VBW 3 MHz #Sweep 6 s (601 pts)

CH High

Agilent

R T

Mkr1 5.238 40 GHz
0.58 dBm

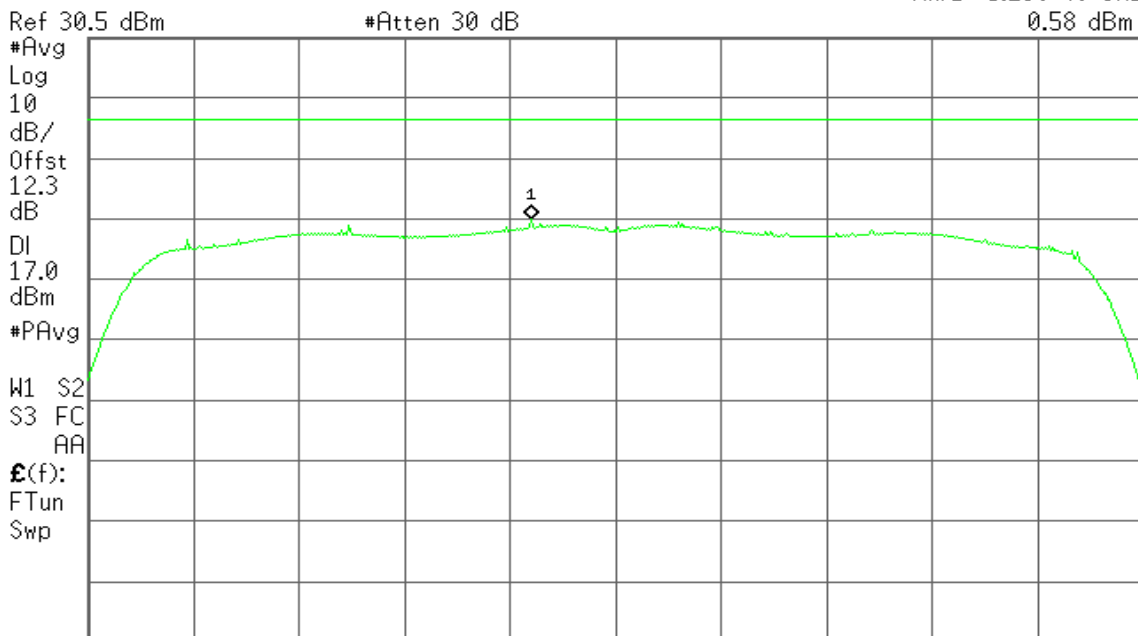

Center 5.240 00 GHz Span 20 MHz
#Res BW 1 MHz #VBW 3 MHz #Sweep 6 s (601 pts)



IEEE 802.11n HT 40 MHz mode / 5190 ~ 5230MHz

CH Low

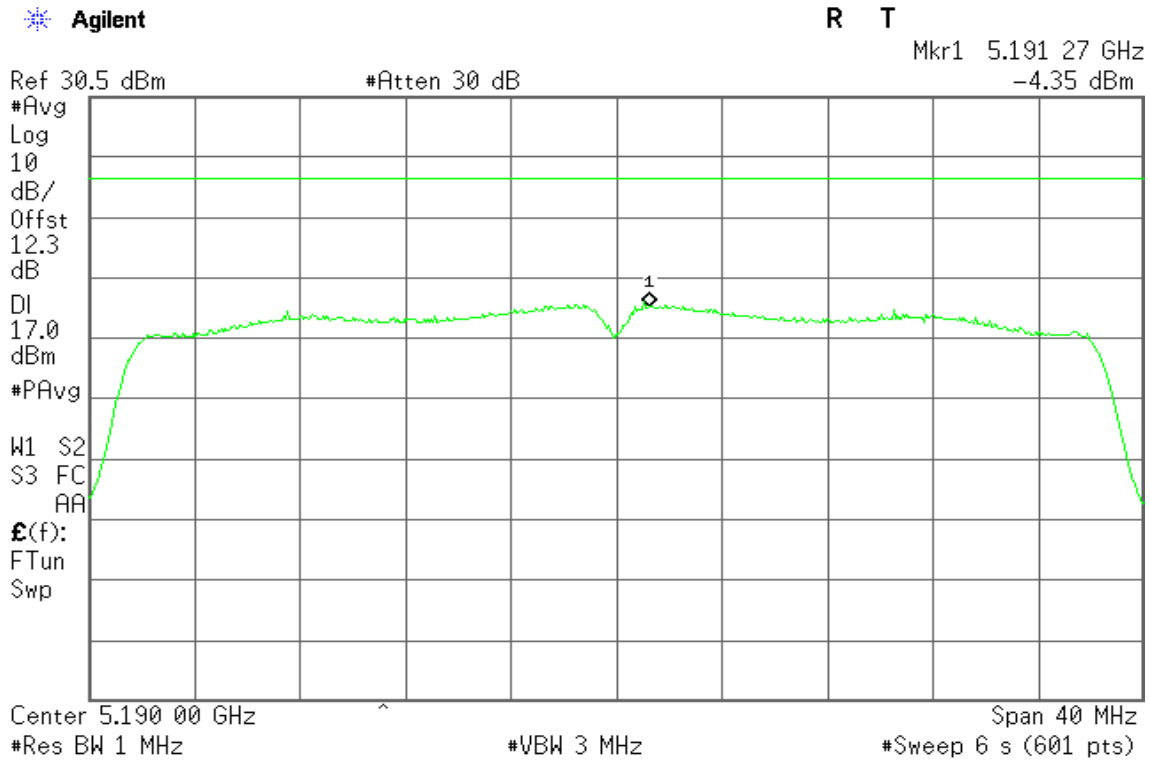

CH High

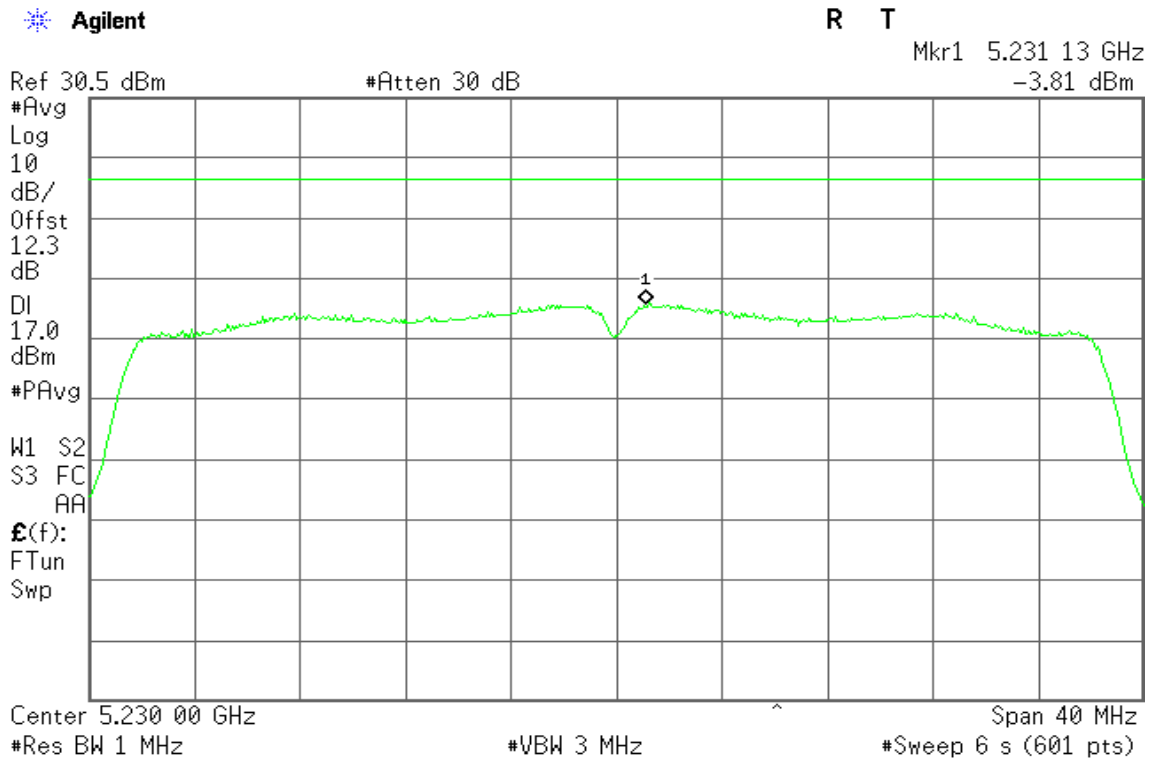



IEEE 802.11a mode / 5260 ~ 5320MHz

CH Low

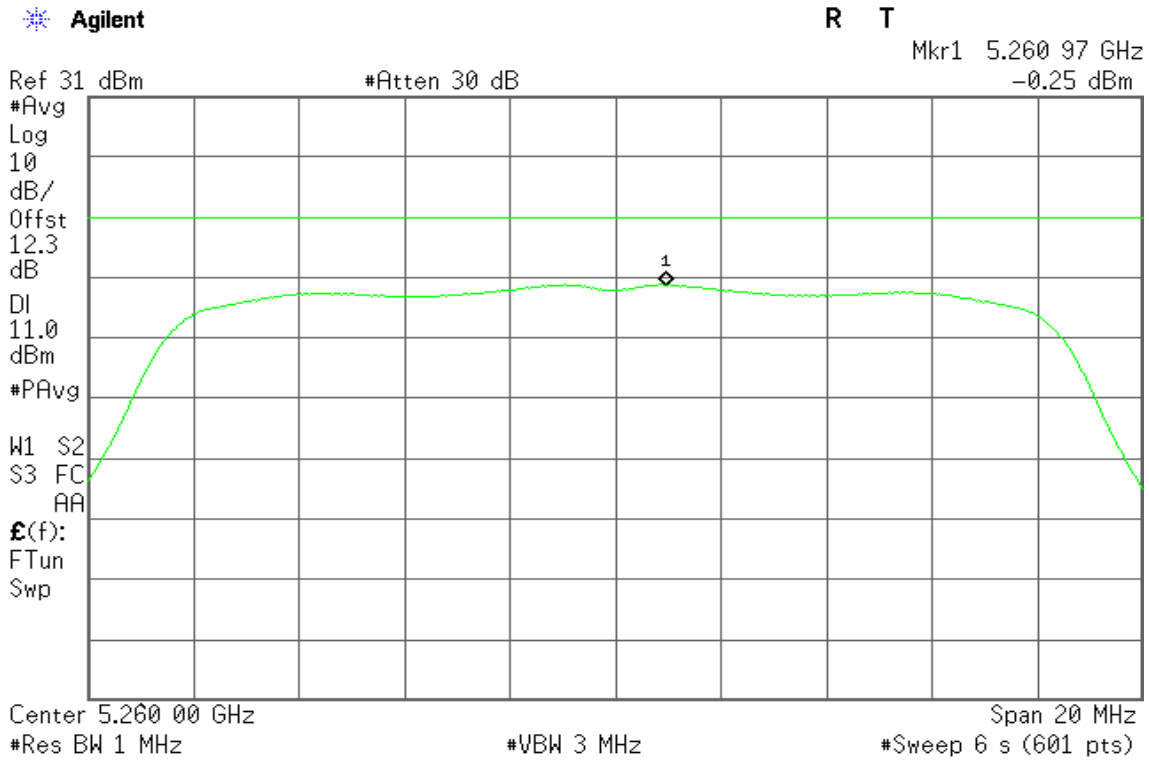

CH Mid

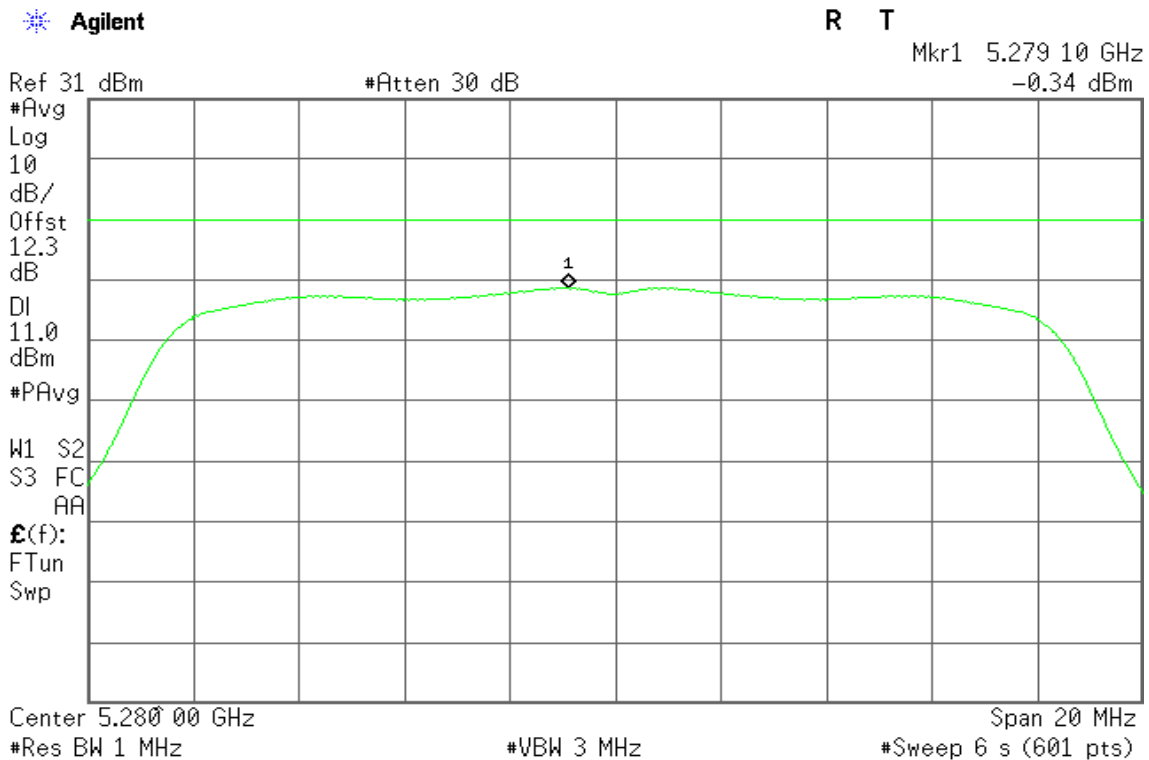



CH High

Agilent

R T

Mkr1 5.319 10 GHz
-0.25 dBm

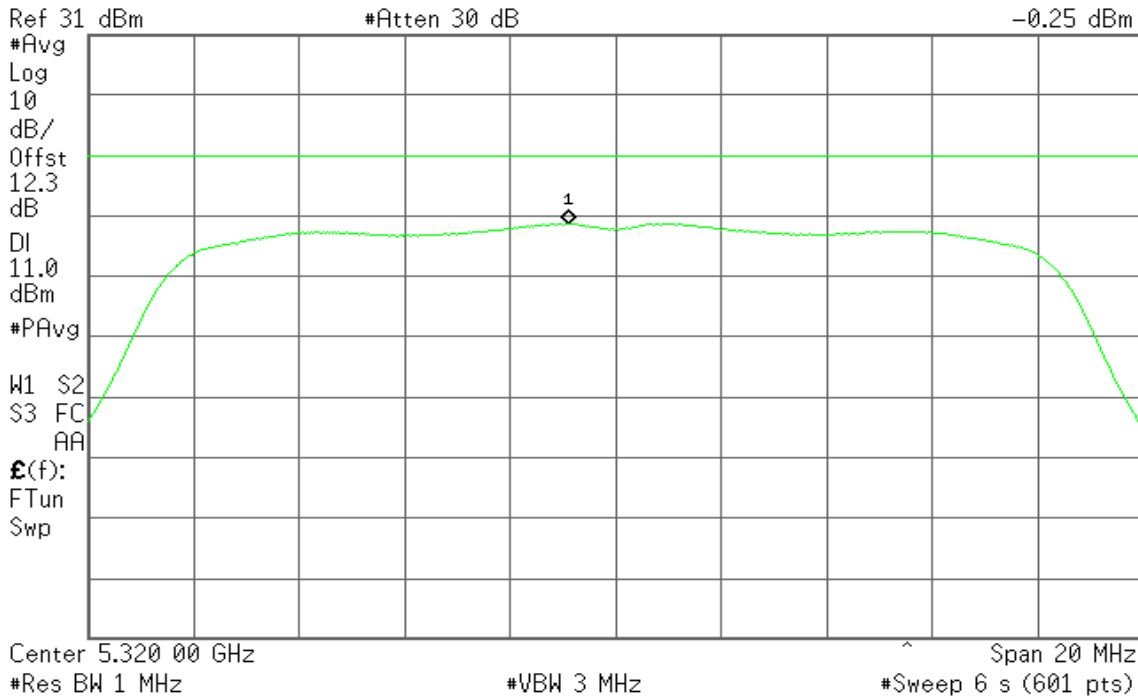

IEEE 802.11n HT 20 MHz Channel mode / 5260 ~ 5320MHz

CH Low

Agilent

R T

Mkr1 5.261 07 GHz
0.85 dBm

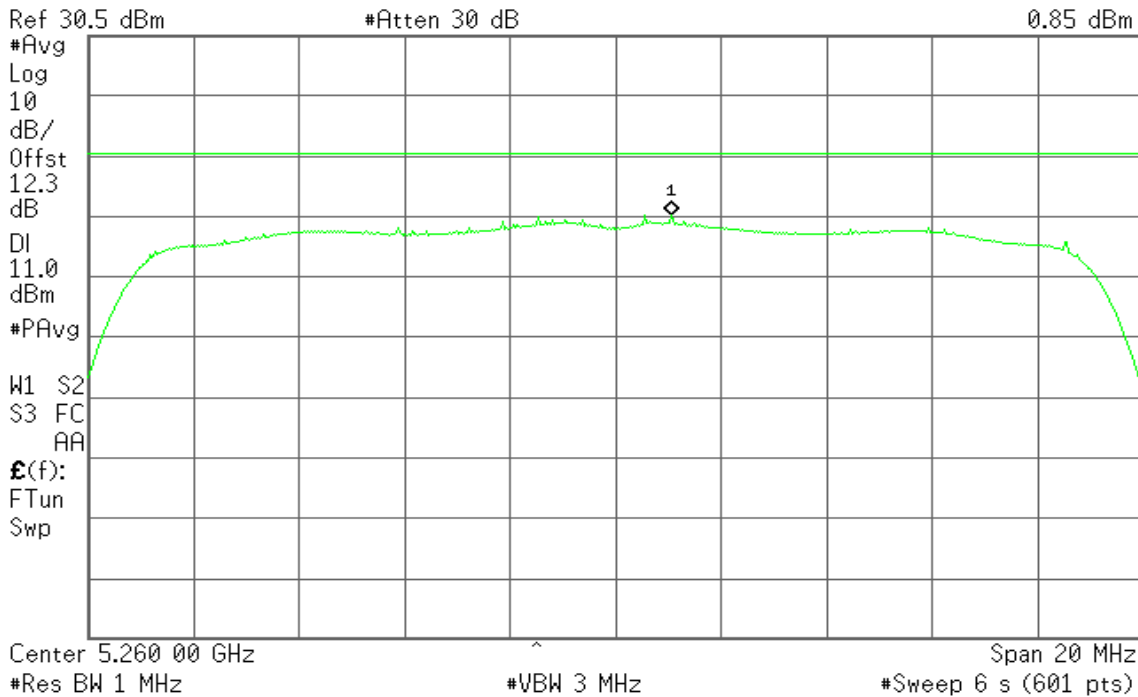



CH Mid

Agilent

R T

Mkr1 5.278 80 GHz
0.40 dBm

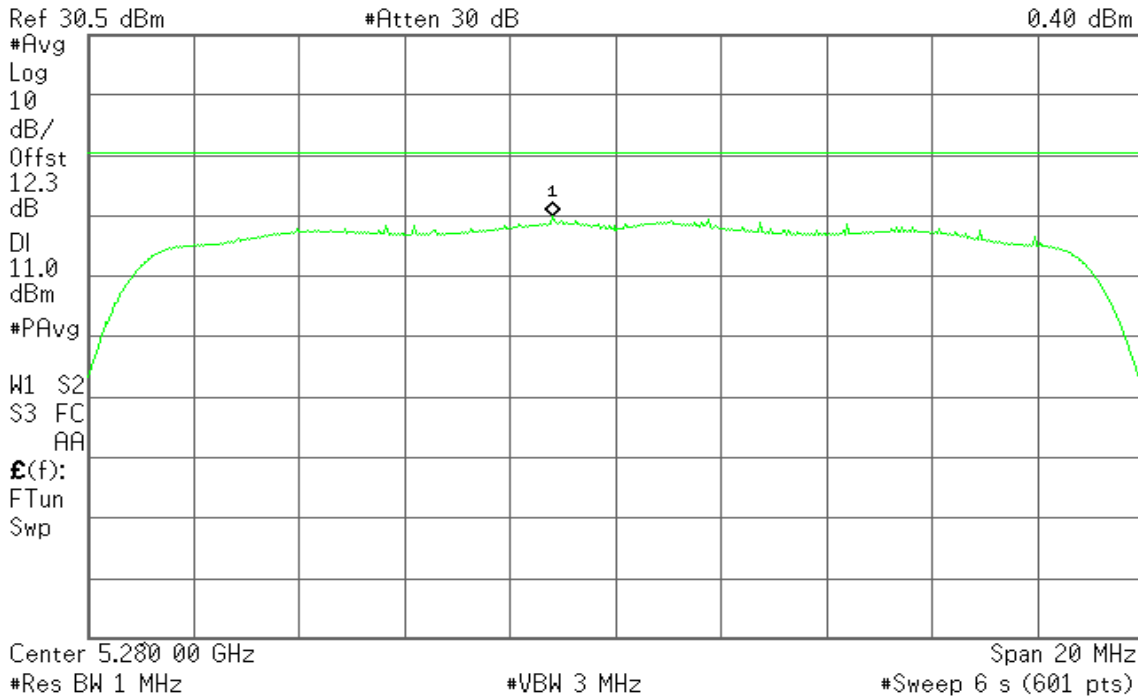

CH High

Agilent

R T

Mkr1 5.319 17 GHz
0.84 dBm

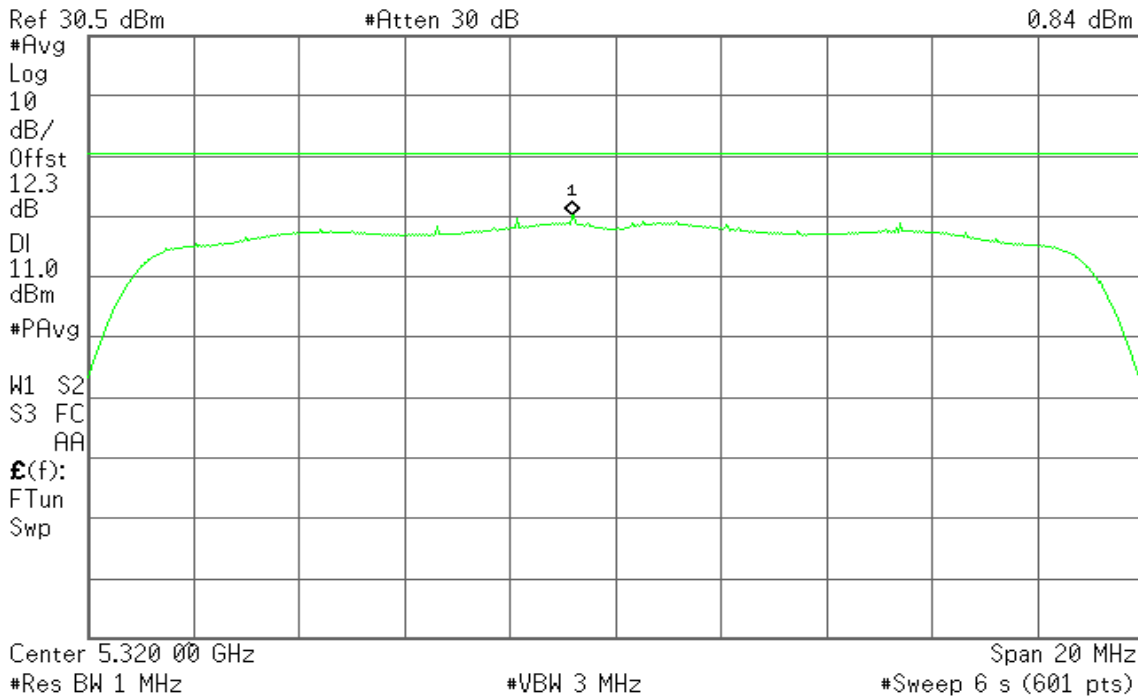



IEEE 802.11n HT 40 MHz mode / 5270 ~ 5310MHz

CH Low

Agilent

R T

Mkr1 5.271 53 GHz
-3.93 dBm

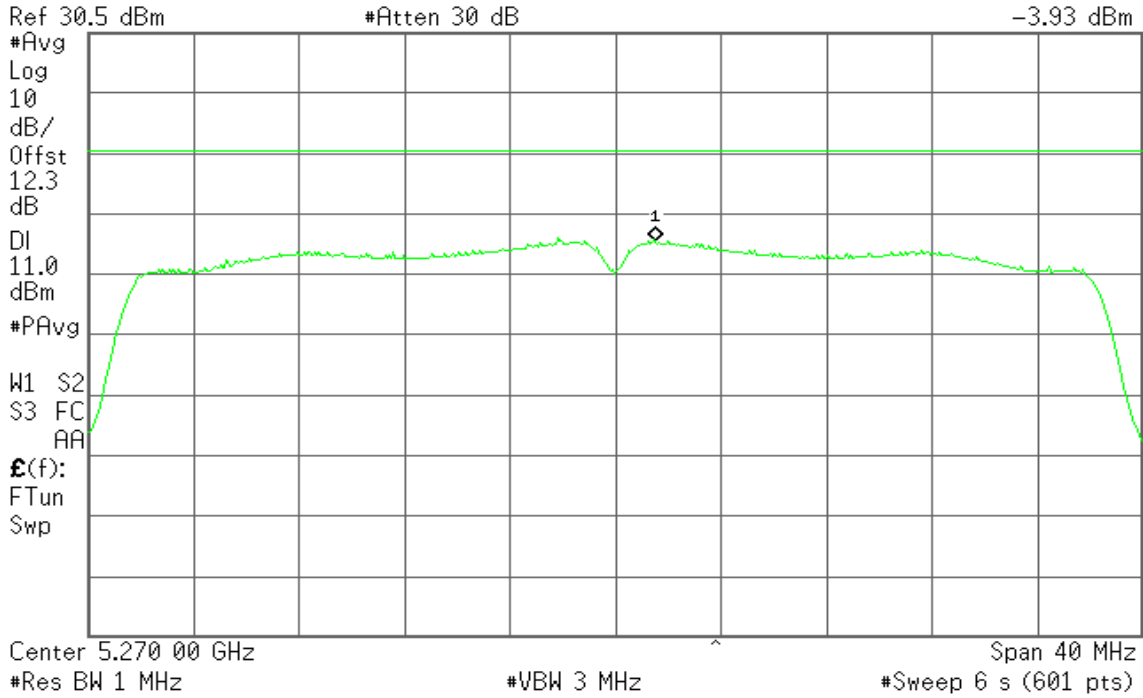

CH High

Agilent

R T

Mkr1 5.308 40 GHz
-4.03 dBm

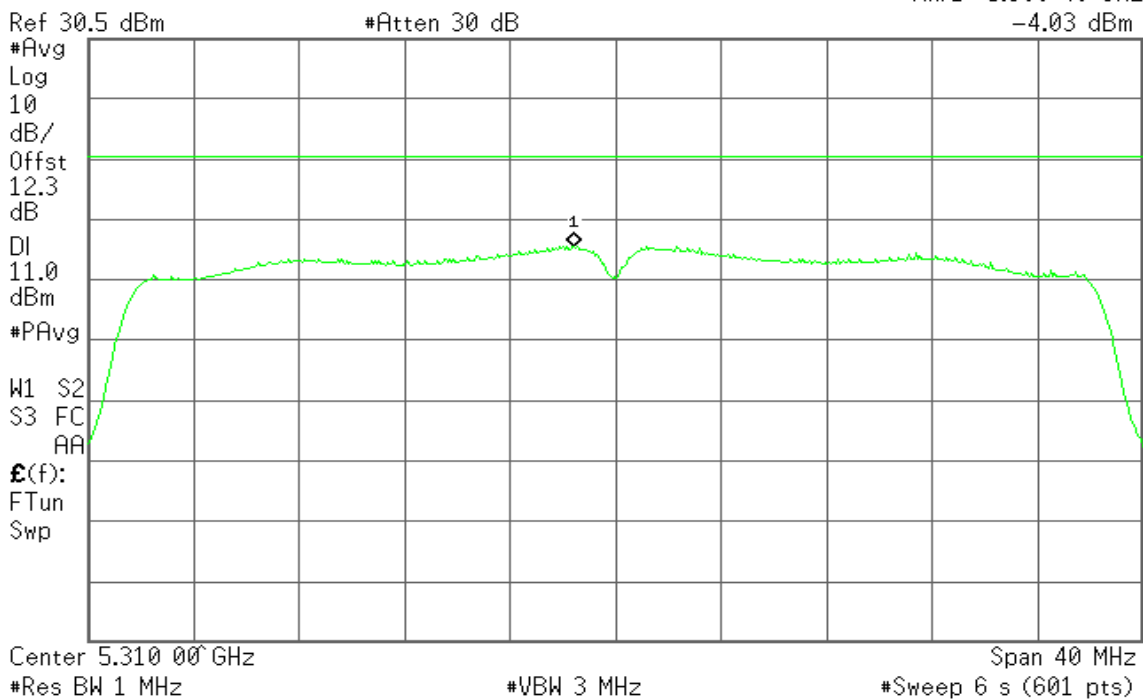



Test mode: IEEE 802.11a mode / 5500 ~ 5700MHz

CH Low

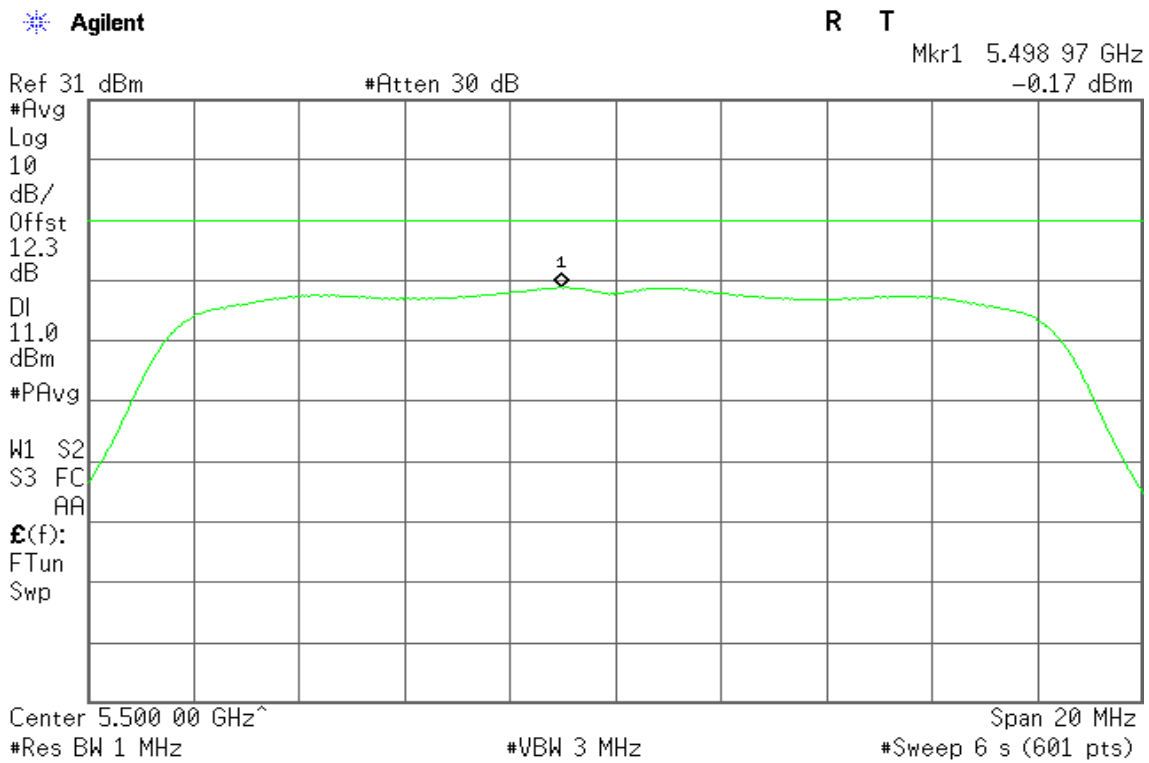

CH Mid

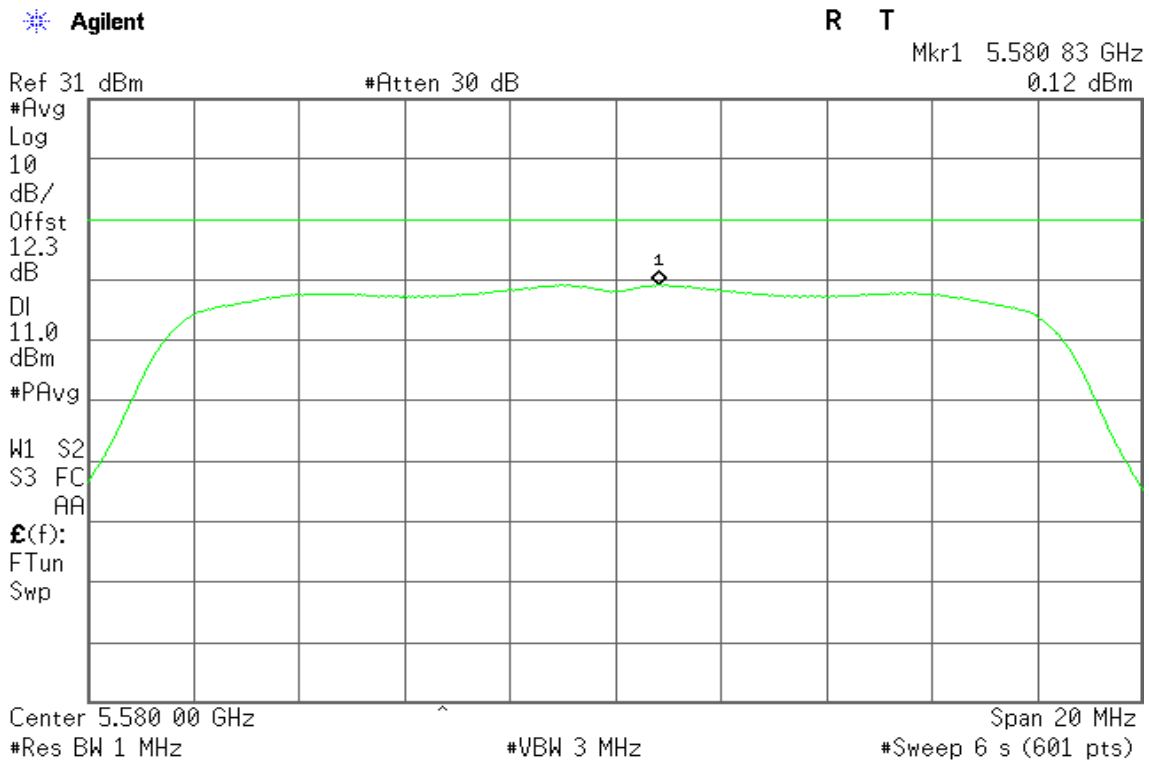



CH High

Agilent

R T

Mkr1 5.699 03 GHz
-0.50 dBm

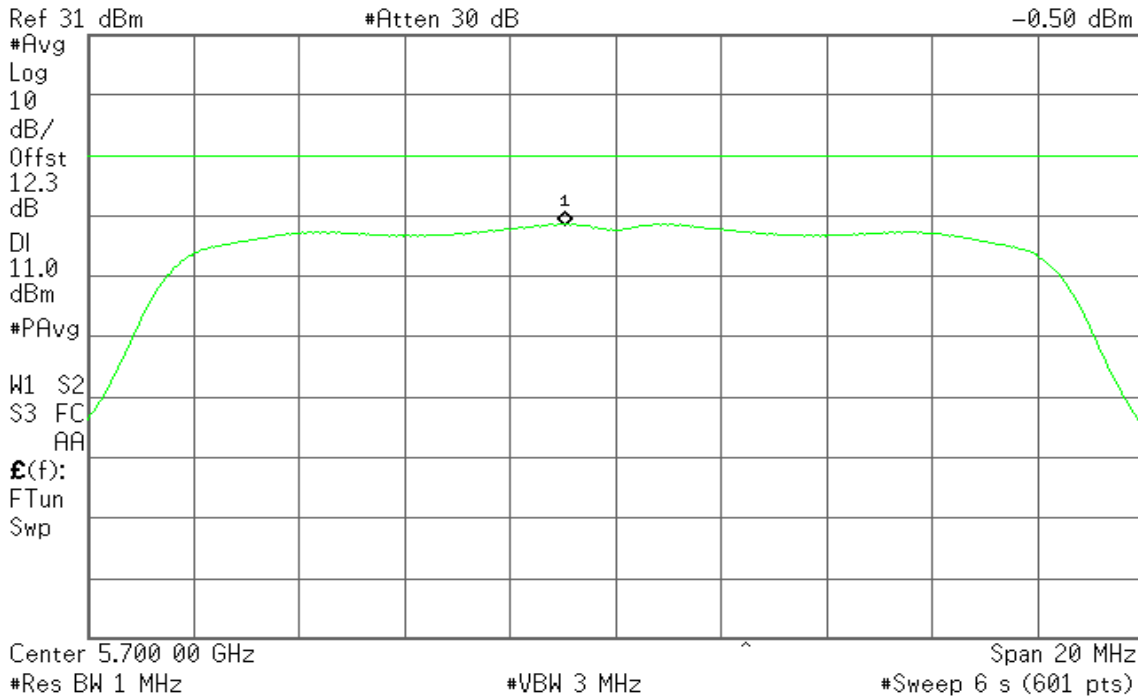

IEEE 802.11n HT 20 MHz Channel mode / 5500 ~ 5700MHz

CH Low

Agilent

R T

Mkr1 5.498 33 GHz
-0.94 dBm

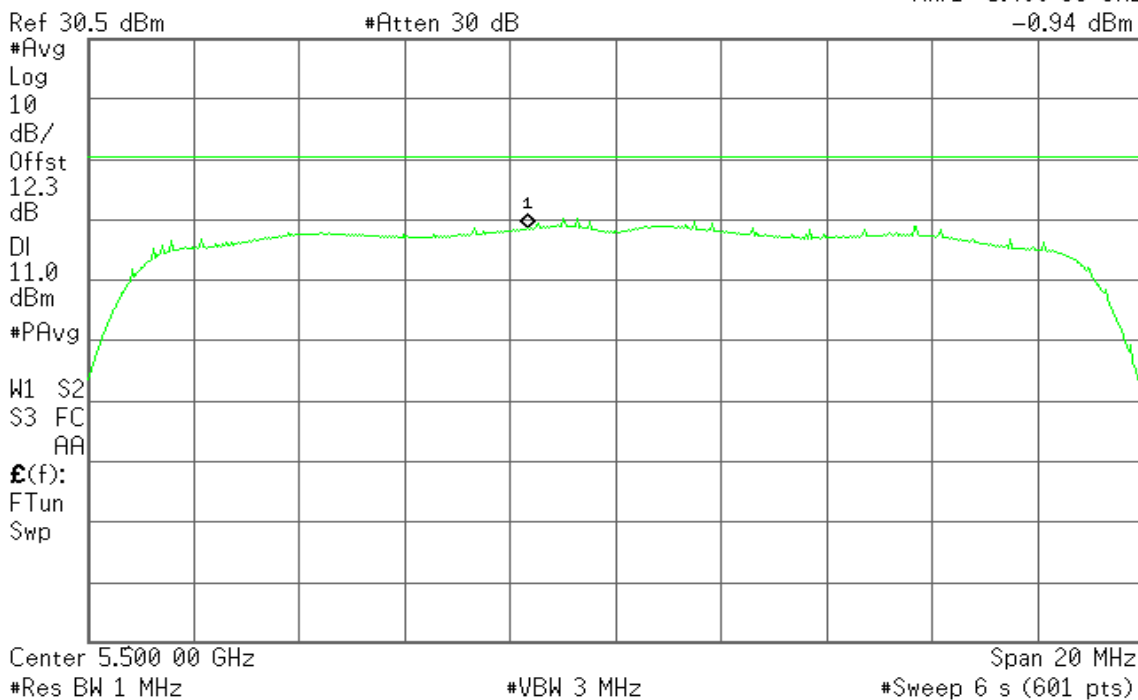



CH Mid

Agilent

R T

Mkr1 5.580 63 GHz
-0.43 dBm

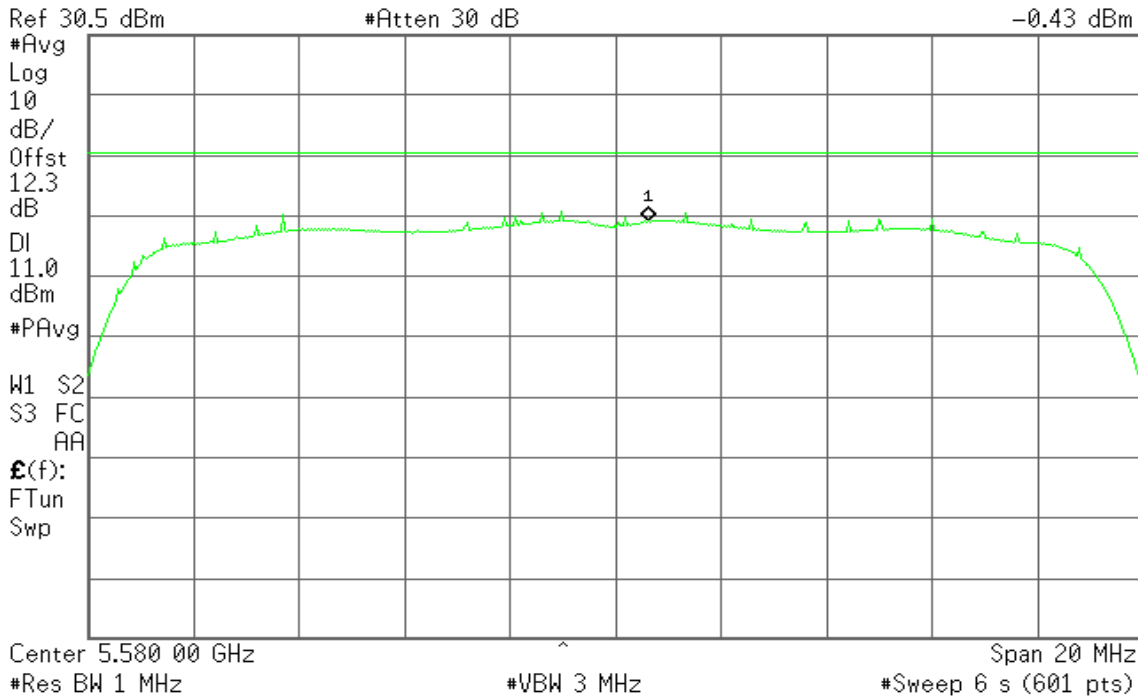

CH High

Agilent

R T

Mkr1 5.699 43 GHz
0.60 dBm

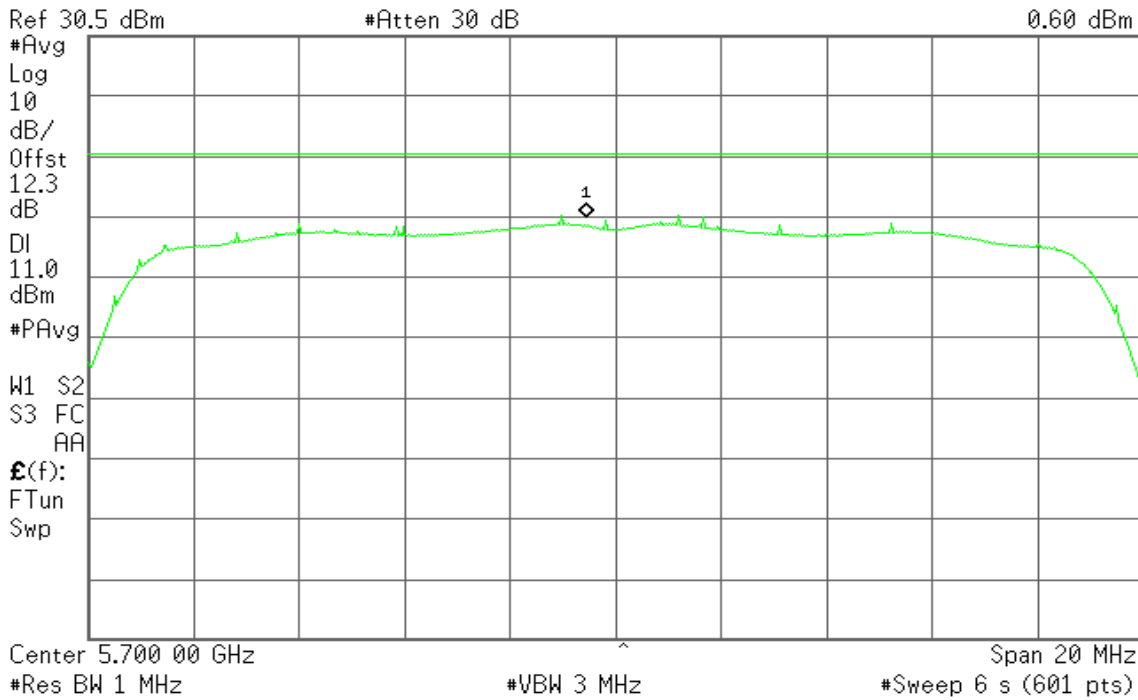



IEEE 802.11n HT 40 MHz mode / 5510 ~ 5670MHz

CH Low

Agilent

R T

Mkr1 5.511 07 GHz
-4.10 dBm

Ref 30.5 dBm

#Atten 30 dB

#Avg
Log
10
dB/
Offst
12.3
dB
DI
11.0
dBm
#PAvg
W1 S2
S3 FC
AA
£(f):
FTun
Swp

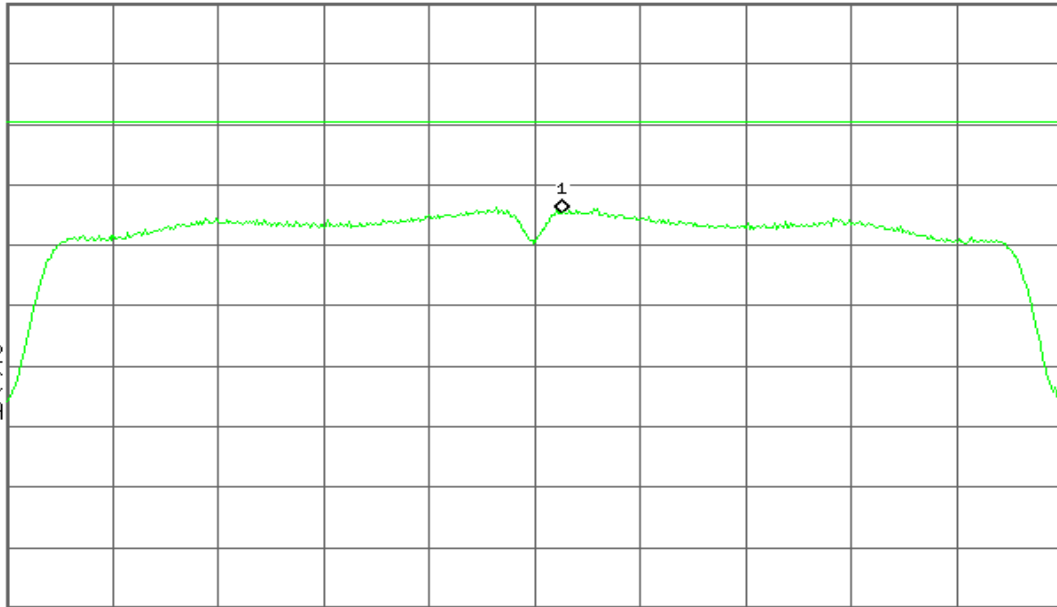

Center 5.510 00 GHz

#Res BW 1 MHz

#VBW 3 MHz

Span 40 MHz

#Sweep 6 s (601 pts)

CH Mid

Agilent

R T

Mkr1 5.552 13 GHz
-3.88 dBm

Ref 30.5 dBm

#Atten 30 dB

#Avg
Log
10
dB/
Offst
12.3
dB
DI
11.0
dBm
#PAvg
W1 S2
S3 FC
AA
£(f):
FTun
Swp

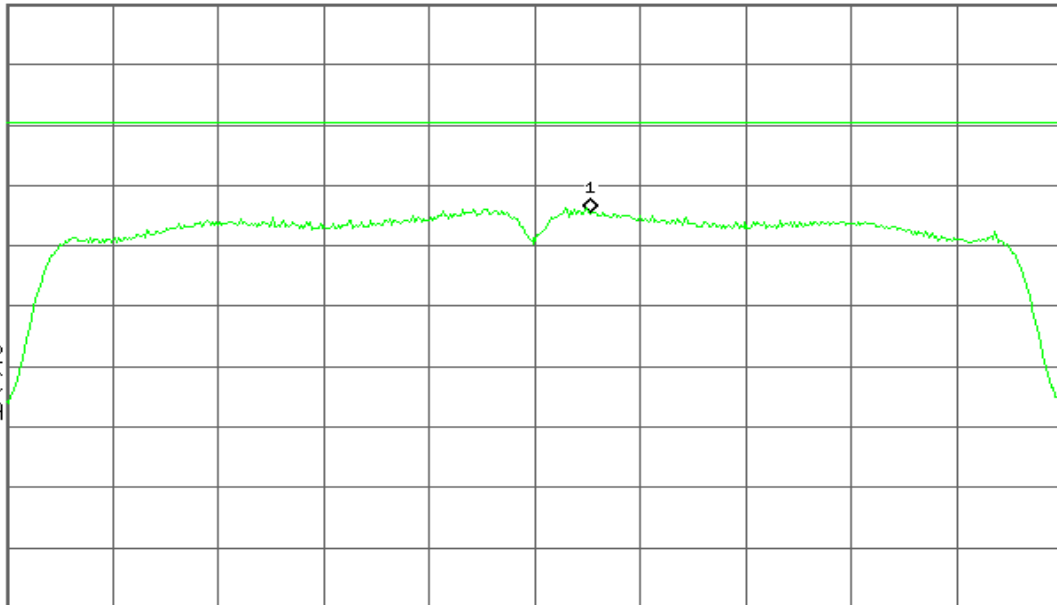

Center 5.550 00 GHz

#Res BW 1 MHz

#VBW 3 MHz

Span 40 MHz

#Sweep 6 s (601 pts)



CH High

Agilent

R T

Mkr1 5.671 73 GHz
-3.31 dBm

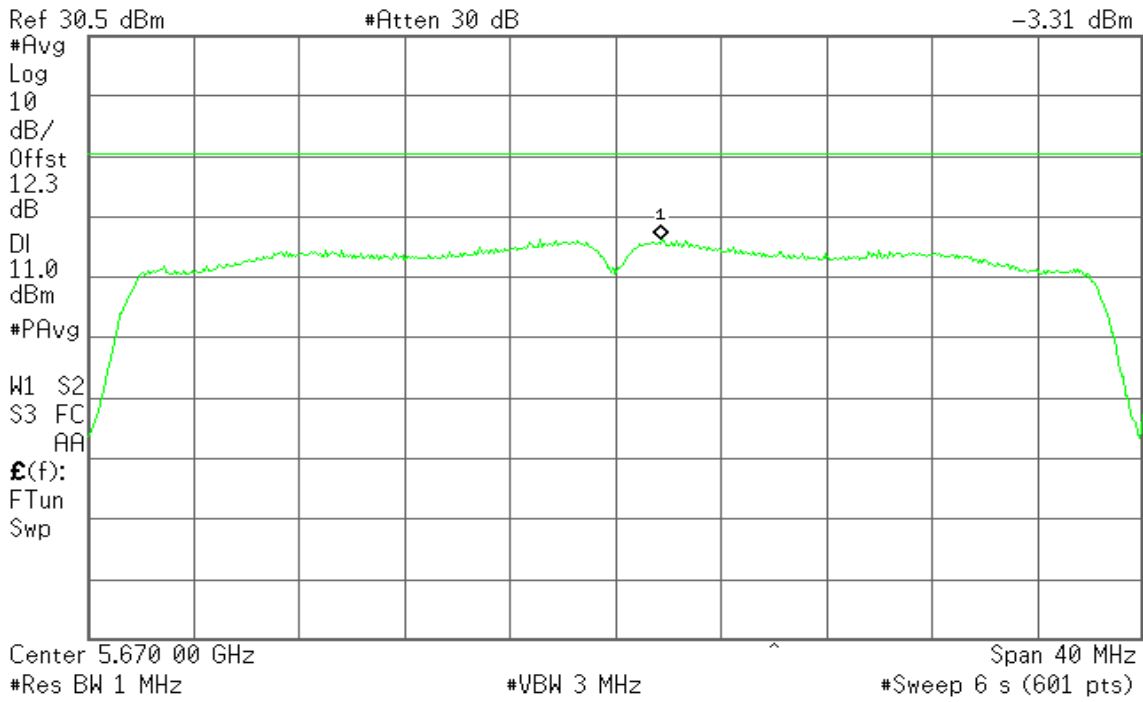



8.6 RADIATED UNDESIRABLE EMISSION

1. According to §15.209(a) & RSS-210 §A9.3, except as provided elsewhere in this Subpart, the emissions from an intentional radiator shall not exceed the field strength levels specified in the following table:

Frequency (MHz)	Field Strength (µV/m)	Measurement Distance (m)
30-88	100*	3
88-216	150*	3
216-960	200*	3
Above 960	500	3

Remark: Except as provided in paragraph (g), fundamental emissions from intentional radiators operating under this Section shall not be located in the frequency bands 54-72 MHz, 76-88 MHz, 174-216 MHz or 470-806 MHz. However, operation within these frequency bands is permitted under other sections of this Part, e.g., Sections 15.231 and 15.241.

2. In the emission table above, the tighter limit applies at the band edges.

Frequency (MHz)	Field Strength (µV/m at 3-meter)	Field Strength (dBµV/m at 3-meter)
30-88	100	40
88-216	150	43.5
216-960	200	46
Above 960	500	54



Test Configuration

9kHz ~ 30MHz

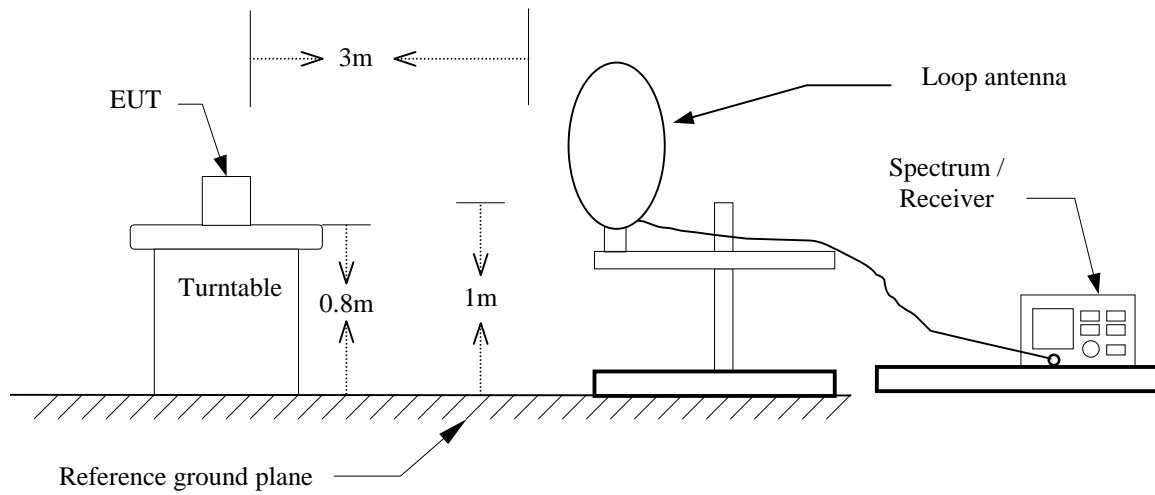

30MHz ~ 1GHz

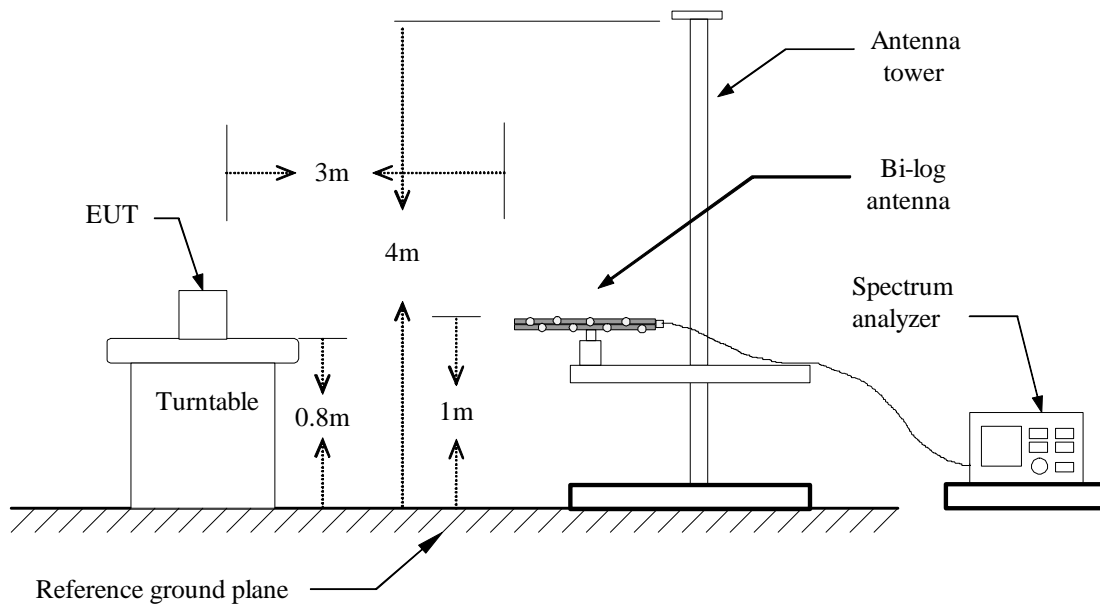



Above 1 GHz

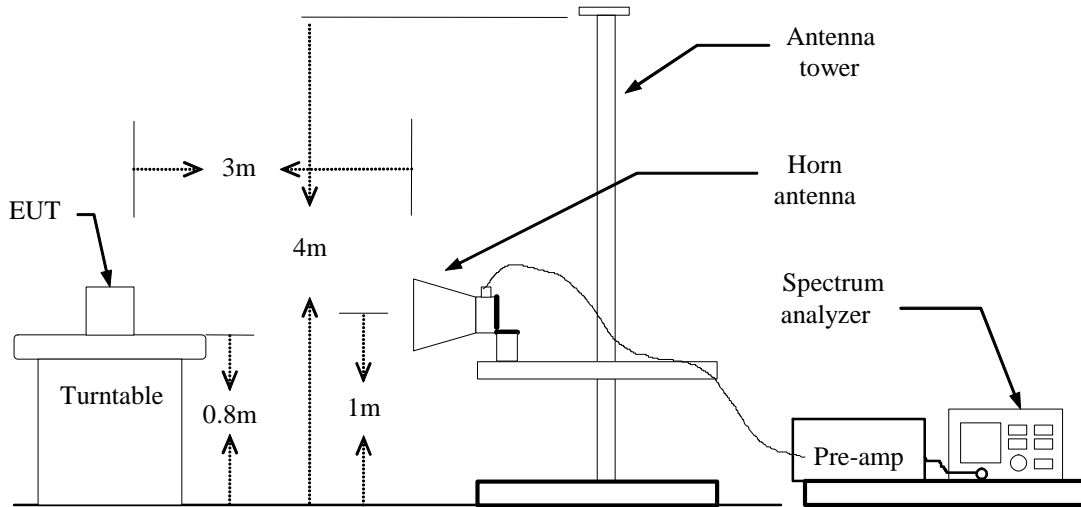



TEST PROCEDURE

1. The EUT is placed on a turntable, which is 0.8m above ground plane.
2. The turntable shall be rotated for 360 degrees to determine the position of maximum emission level.
3. EUT is set 3m away from the receiving antenna, which is varied from 1m to 4m to find out the highest emissions.
4. Maximum procedure was performed on the six highest emissions to ensure EUT compliance.
5. And also, each emission was to be maximized by changing the polarization of receiving antenna both horizontal and vertical.
6. Set the spectrum analyzer in the following setting as:

Below 1GHz:

RBW=100kHz / VBW=300kHz / Sweep=AUTO

Above 1GHz:

(a) PEAK: RBW=VBW=1MHz / Sweep=AUTO

(b) AVERAGE: RBW=1MHz / VBW=300Hz / Sweep=AUTO

7. Repeat above procedures until the measurements for all frequencies are complete.



Below 1 GHz

Operation Mode: Normal Link

Test Date: August 3, 2014

Temperature: 27°C

Tested by: Andy Shi

Humidity: 53% RH

Polarity: Ver. / Hor.

Frequency (MHz)	Reading (dBuV)	Correction Factor (dB/m)	Result (dBuV/m)	Limit (dBuV/m)	Margin (dB)	Remark	Ant.Pol. (H/V)
79.4700	52.33	-23.05	29.28	40.00	-10.72	Peak	V
119.2400	47.23	-17.50	29.73	43.50	-13.77	Peak	V
243.4000	35.67	-18.54	17.13	46.00	-28.87	Peak	V
448.0700	35.14	-12.71	22.43	46.00	-23.57	Peak	V
609.0900	32.43	-10.29	22.14	46.00	-23.86	Peak	V
723.5500	35.48	-8.36	27.12	46.00	-18.88	Peak	V
30.0000	38.56	-9.87	28.69	40.00	-11.31	Peak	H
81.4100	51.44	-23.12	28.32	40.00	-11.68	Peak	H
207.5100	47.71	-18.08	29.63	43.50	-13.87	Peak	H
422.8500	47.27	-13.40	33.87	46.00	-12.13	Peak	H
666.3200	32.56	-9.14	23.42	46.00	-22.58	Peak	H
731.3100	39.45	-8.22	31.23	46.00	-14.77	Peak	H

Remark:

- 1 Measuring frequencies from 30 MHz to the 1GHz.
- 2 Radiated emissions measured in frequency range from 30 MHz to 1000MHz were made with an instrument using peak/quasi-peak detector mode.
- 3 Quasi-peak test would be performed if the peak result were greater than the quasi-peak limit or as required by the applicant.
- 4 Measurements above show only up to 6 maximum emissions noted, or would be lesser, with " N/A " remark, if no specific emissions from the EUT are recorded (ie: margin>20dB from the applicable limit) and considered that's already beyond the background noise floor.
- 5 Margin (dB) = Remark result (dBuV/m) – Quasi-peak limit (dBuV/m).



Above 1 GHz

Operation Mode: Tx / IEEE 802.11a mode / 5180 ~ 5240MHz / CH Low **Test Date:** July 28, 2014

Temperature: 27°C **Tested by:** Andy Shi

Humidity: 53% RH **Polarity:** Ver. / Hor.

Frequency (MHz)	Reading (dBuV)	Correction (dB/m)	Result (dBuV/m)	Limit (dBuV/m)	Margin (dB)	Remark	Ant.Pol. (H/V)
3191.000	52.29	-1.65	50.64	74.00	-23.36	peak	V
N/A							
3870.000	50.23	0.67	50.90	74.00	-23.10	peak	H
N/A							

Remark:

1. Measuring frequencies from 1 GHz to the 10th harmonic of highest fundamental frequency.
2. Radiated emissions measured in frequency above 1000MHz were made with an instrument using peak/average detector mode.
3. Average test would be performed if the peak result were greater than the average limit.
4. Data of measurement within this frequency range shown “ --- ” in the table above means the reading of emissions are attenuated more than 20dB below the permissible limits or the field strength is too small to be measured.
5. Measurements above show only up to 6 maximum emissions noted, or would be lesser, with “ N/A ” remark, if no specific emissions from the EUT are recorded (ie: margin>20dB from the applicable limit) and considered that's already beyond the background noise floor.
6. Margin (dB) = Remark result (dBuV/m) – Average limit (dBuV/m).



Operation Mode: Tx / IEEE 802.11a mode / 5180 ~ 5240MHz / CH Mid **Test Date:** July 29, 2014
Temperature: 27°C **Tested by:** Andy Shi
Humidity: 53% RH **Polarity:** Ver. / Hor.

Frequency (MHz)	Reading (dBuV)	Correction (dB/m)	Result (dBuV/m)	Limit (dBuV/m)	Margin (dB)	Remark	Ant.Pol. (H/V)
3744.000	50.01	0.13	50.14	74.00	-23.86	peak	V
N/A							
3436.000	51.23	-1.06	50.17	74.00	-23.83	peak	H
N/A							

Remark:

1. Measuring frequencies from 1 GHz to the 10th harmonic of highest fundamental frequency.
2. Radiated emissions measured in frequency above 1000MHz were made with an instrument using peak/average detector mode.
3. Average test would be performed if the peak result were greater than the average limit.
4. Data of measurement within this frequency range shown “ --- ” in the table above means the reading of emissions are attenuated more than 20dB below the permissible limits or the field strength is too small to be measured.
5. Measurements above show only up to 6 maximum emissions noted, or would be lesser, with “ N/A ” remark, if no specific emissions from the EUT are recorded (ie: margin>20dB from the applicable limit) and considered that's already beyond the background noise floor.
6. Margin (dB) = Remark result (dBuV/m) – Average limit (dBuV/m).



Operation Mode: Tx / IEEE 802.11a mode / 5180 ~ 5240MHz / CH High

Test Date: July 29, 2014

Temperature: 27°C

Tested by: Andy Shi

Humidity: 53% RH

Polarity: Ver. / Hor.

Frequency (MHz)	Reading (dBuV)	Correction (dB/m)	Result (dBuV/m)	Limit (dBuV/m)	Margin (dB)	Remark	Ant.Pol. (H/V)
3296.000	52.47	-1.40	51.07	74.00	-22.93	peak	V
N/A							
3464.000	50.48	-1.00	49.48	74.00	-24.52	peak	H
N/A							

Remark:

1. Measuring frequencies from 1 GHz to the 10th harmonic of highest fundamental frequency.
2. Radiated emissions measured in frequency above 1000MHz were made with an instrument using peak/average detector mode.
3. Average test would be performed if the peak result were greater than the average limit.
4. Data of measurement within this frequency range shown " --- " in the table above means the reading of emissions are attenuated more than 20dB below the permissible limits or the field strength is too small to be measured.
5. Measurements above show only up to 6 maximum emissions noted, or would be lesser, with " N/A " remark, if no specific emissions from the EUT are recorded (ie: margin>20dB from the applicable limit) and considered that's already beyond the background noise floor.
6. Margin (dB) = Remark result (dBuV/m) – Average limit (dBuV/m).



Operation Mode: Tx / IEEE 802.11n HT 20 MHz Channel mode / 5180 ~ 5240MHz / CH Low
Temperature: 27°C
Humidity: 53% RH

Test Date: July 29, 2014
Tested by: Andy Shi
Polarity: Ver. / Hor.

Frequency (MHz)	Reading (dBuV)	Correction (dB/m)	Result (dBuV/m)	Limit (dBuV/m)	Margin (dB)	Remark	Ant.Pol. (H/V)
4185.000	50.40	1.93	52.33	74.00	-21.67	peak	V
N/A							
4213.000	50.04	2.04	52.08	74.00	-21.92	peak	H
N/A							

Remark:

1. Measuring frequencies from 1 GHz to the 10th harmonic of highest fundamental frequency.
2. Radiated emissions measured in frequency above 1000MHz were made with an instrument using peak/average detector mode.
3. Average test would be performed if the peak result were greater than the average limit.
4. Data of measurement within this frequency range shown " --- " in the table above means the reading of emissions are attenuated more than 20dB below the permissible limits or the field strength is too small to be measured.
5. Measurements above show only up to 6 maximum emissions noted, or would be lesser, with " N/A " remark, if no specific emissions from the EUT are recorded (ie: margin>20dB from the applicable limit) and considered that's already beyond the background noise floor.
6. Margin (dB) = Remark result (dBuV/m) – Average limit (dBuV/m).



Operation Mode: Tx / IEEE 802.11n HT 20 MHz Channel mode / 5180 ~ 5240MHz / CH Mid
Temperature: 27°C
Humidity: 53% RH

Test Date: July 29, 2014
Tested by: Andy Shi
Polarity: Ver. / Hor.

Frequency (MHz)	Reading (dBuV)	Correction (dB/m)	Result (dBuV/m)	Limit (dBuV/m)	Margin (dB)	Remark	Ant.Pol. (H/V)
3310.000	51.65	-1.37	50.28	74.00	-23.72	peak	V
N/A							
3373.000	51.72	-1.21	50.51	74.00	-23.49	peak	H
N/A							

Remark:

1. Measuring frequencies from 1 GHz to the 10th harmonic of highest fundamental frequency.
2. Radiated emissions measured in frequency above 1000MHz were made with an instrument using peak/average detector mode.
3. Average test would be performed if the peak result were greater than the average limit.
4. Data of measurement within this frequency range shown " --- " in the table above means the reading of emissions are attenuated more than 20dB below the permissible limits or the field strength is too small to be measured.
5. Measurements above show only up to 6 maximum emissions noted, or would be lesser, with " N/A " remark, if no specific emissions from the EUT are recorded (ie: margin>20dB from the applicable limit) and considered that's already beyond the background noise floor.
6. Margin (dB) = Remark result (dBuV/m) – Average limit (dBuV/m).



Operation Mode: Tx / IEEE 802.11n HT 20 MHz Channel mode / 5180 ~ 5240MHz / CH High **Test Date:** July 29, 2014
Temperature: 27°C **Tested by:** Andy Shi
Humidity: 53% RH **Polarity:** Ver. / Hor.

Frequency (MHz)	Reading (dBuV)	Correction (dB/m)	Result (dBuV/m)	Limit (dBuV/m)	Margin (dB)	Remark	Ant.Pol. (H/V)
3723.000	50.52	0.04	50.56	74.00	-23.44	peak	V
N/A							
3373.000	51.43	-1.21	50.22	74.00	-23.78	peak	H
N/A							

Remark:

1. Measuring frequencies from 1 GHz to the 10th harmonic of highest fundamental frequency.
2. Radiated emissions measured in frequency above 1000MHz were made with an instrument using peak/average detector mode.
3. Average test would be performed if the peak result were greater than the average limit.
4. Data of measurement within this frequency range shown " --- " in the table above means the reading of emissions are attenuated more than 20dB below the permissible limits or the field strength is too small to be measured.
5. Measurements above show only up to 6 maximum emissions noted, or would be lesser, with " N/A " remark, if no specific emissions from the EUT are recorded (ie: margin>20dB from the applicable limit) and considered that's already beyond the background noise floor.
6. Margin (dB) = Remark result (dBuV/m) – Average limit (dBuV/m).



Operation Mode: Tx / IEEE 802.11n HT 40 MHz mode / 5190 ~ 5230MHz / CH Low **Test Date:** July 29, 2014
Temperature: 27°C **Tested by:** Andy Shi
Humidity: 53% RH **Polarity:** Ver. / Hor.

Frequency (MHz)	Reading (dBuV)	Correction (dB/m)	Result (dBuV/m)	Limit (dBuV/m)	Margin (dB)	Remark	Ant.Pol. (H/V)
3268.000	52.07	-1.47	50.60	74.00	-23.40	peak	V
N/A							
4094.000	50.86	1.59	52.45	74.00	-21.55	peak	H
N/A							

Remark:

1. Measuring frequencies from 1 GHz to the 10th harmonic of highest fundamental frequency.
2. Radiated emissions measured in frequency above 1000MHz were made with an instrument using peak/average detector mode.
3. Average test would be performed if the peak result were greater than the average limit.
4. Data of measurement within this frequency range shown “ --- ” in the table above means the reading of emissions are attenuated more than 20dB below the permissible limits or the field strength is too small to be measured.
5. Measurements above show only up to 6 maximum emissions noted, or would be lesser, with “ N/A ” remark, if no specific emissions from the EUT are recorded (ie: margin>20dB from the applicable limit) and considered that's already beyond the background noise floor.
6. Margin (dB) = Remark result (dBuV/m) – Average limit (dBuV/m).



Operation Mode: Tx / IEEE 802.11n HT 40 MHz mode / 5190 ~ 5230MHz / CH High **Test Date:** July 29, 2014
Temperature: 27°C **Tested by:** Andy Shi
Humidity: 53% RH **Polarity:** Ver. / Hor.

Frequency (MHz)	Reading (dBuV)	Correction (dB/m)	Result (dBuV/m)	Limit (dBuV/m)	Margin (dB)	Remark	Ant.Pol. (H/V)
4164.000	49.95	1.85	51.80	74.00	-22.20	peak	V
N/A							
3345.000	51.56	-1.28	50.28	74.00	-23.72	peak	H
N/A							

Remark:

1. Measuring frequencies from 1 GHz to the 10th harmonic of highest fundamental frequency.
2. Radiated emissions measured in frequency above 1000MHz were made with an instrument using peak/average detector mode.
3. Average test would be performed if the peak result were greater than the average limit.
4. Data of measurement within this frequency range shown " --- " in the table above means the reading of emissions are attenuated more than 20dB below the permissible limits or the field strength is too small to be measured.
5. Measurements above show only up to 6 maximum emissions noted, or would be lesser, with " N/A " remark, if no specific emissions from the EUT are recorded (ie: margin>20dB from the applicable limit) and considered that's already beyond the background noise floor.
6. Margin (dB) = Remark result (dBuV/m) – Average limit (dBuV/m).



Operation Mode: Tx / IEEE 802.11a mode / 5260 ~ 5320MHz / CH Low **Test Date:** July 29, 2014
Temperature: 27°C **Tested by:** Andy Shi
Humidity: 53% RH **Polarity:** Ver. / Hor.

Frequency (MHz)	Reading (dBuV)	Correction (dB/m)	Result (dBuV/m)	Limit (dBuV/m)	Margin (dB)	Remark	Ant.Pol. (H/V)
4045.000	50.22	1.40	51.62	74.00	-22.38	peak	V
N/A							
3072.000	51.21	-1.94	49.27	74.00	-24.73	peak	H
N/A							

Remark:

1. Measuring frequencies from 1 GHz to the 10th harmonic of highest fundamental frequency.
2. Radiated emissions measured in frequency above 1000MHz were made with an instrument using peak/average detector mode.
3. Average test would be performed if the peak result were greater than the average limit.
4. Data of measurement within this frequency range shown " --- " in the table above means the reading of emissions are attenuated more than 20dB below the permissible limits or the field strength is too small to be measured.
5. Measurements above show only up to 6 maximum emissions noted, or would be lesser, with " N/A " remark, if no specific emissions from the EUT are recorded (ie: margin>20dB from the applicable limit) and considered that's already beyond the background noise floor.
6. Margin (dB) = Remark result (dBuV/m) – Average limit (dBuV/m).



Operation Mode: Tx / IEEE 802.11a mode / 5260 ~ 5320MHz / CH Mid **Test Date:** July 29, 2014
Temperature: 27°C **Tested by:** Andy Shi
Humidity: 53% RH **Polarity:** Ver. / Hor.

Frequency (MHz)	Reading (dBuV)	Correction (dB/m)	Result (dBuV/m)	Limit (dBuV/m)	Margin (dB)	Remark	Ant.Pol. (H/V)
3597.000	50.68	-0.49	50.19	74.00	-23.81	peak	V
N/A							
3401.000	52.19	-1.15	51.04	74.00	-22.96	peak	H
N/A							

Remark:

1. Measuring frequencies from 1 GHz to the 10th harmonic of highest fundamental frequency.
2. Radiated emissions measured in frequency above 1000MHz were made with an instrument using peak/average detector mode.
3. Average test would be performed if the peak result were greater than the average limit.
4. Data of measurement within this frequency range shown " --- " in the table above means the reading of emissions are attenuated more than 20dB below the permissible limits or the field strength is too small to be measured.
5. Measurements above show only up to 6 maximum emissions noted, or would be lesser, with " N/A " remark, if no specific emissions from the EUT are recorded (ie: margin>20dB from the applicable limit) and considered that's already beyond the background noise floor.
6. Margin (dB) = Remark result (dBuV/m) – Average limit (dBuV/m).



Operation Mode: Tx / IEEE 802.11a mode / 5260 ~ 5320MHz / CH High **Test Date:** July 29, 2014
Temperature: 27°C **Tested by:** Andy Shi
Humidity: 53% RH **Polarity:** Ver. / Hor.

Frequency (MHz)	Reading (dBuV)	Correction (dB/m)	Result (dBuV/m)	Limit (dBuV/m)	Margin (dB)	Remark	Ant.Pol. (H/V)
4108.000	50.12	1.64	51.76	74.00	-22.24	peak	V
N/A							
3261.000	52.15	-1.48	50.67	74.00	-23.33	peak	H
N/A							

Remark:

1. Measuring frequencies from 1 GHz to the 10th harmonic of highest fundamental frequency.
2. Radiated emissions measured in frequency above 1000MHz were made with an instrument using peak/average detector mode.
3. Average test would be performed if the peak result were greater than the average limit.
4. Data of measurement within this frequency range shown " --- " in the table above means the reading of emissions are attenuated more than 20dB below the permissible limits or the field strength is too small to be measured.
5. Measurements above show only up to 6 maximum emissions noted, or would be lesser, with " N/A " remark, if no specific emissions from the EUT are recorded (ie: margin>20dB from the applicable limit) and considered that's already beyond the background noise floor.
6. Margin (dB) = Remark result (dBuV/m) – Average limit (dBuV/m).



Operation Mode: Tx / IEEE 802.11n HT 20 MHz Channel mode / 5260 ~ 5320MHz / CH Low
Temperature: 27°C
Humidity: 53% RH

Test Date: July 29, 2014
Tested by: Andy Shi
Polarity: Ver. / Hor.

Table with 8 columns: Frequency (MHz), Reading (dBuV), Correction (dB/m), Result (dBuV/m), Limit (dBuV/m), Margin (dB), Remark, Ant.Pol. (H/V). It contains two main data rows for frequencies 3877.000 and 4234.000, with 'N/A' entries for other frequencies.

Remark:

- 1. Measuring frequencies from 1 GHz to the 10th harmonic of highest fundamental frequency.
2. Radiated emissions measured in frequency above 1000MHz were made with an instrument using peak/average detector mode.
3. Average test would be performed if the peak result were greater than the average limit.
4. Data of measurement within this frequency range shown " --- " in the table above means the reading of emissions are attenuated more than 20dB below the permissible limits or the field strength is too small to be measured.
5. Measurements above show only up to 6 maximum emissions noted, or would be lesser, with " N/A " remark, if no specific emissions from the EUT are recorded (ie: margin>20dB from the applicable limit) and considered that's already beyond the background noise floor.
6. Margin (dB) = Remark result (dBuV/m) - Average limit (dBuV/m).



Operation Mode: Tx / IEEE 802.11n HT 20 MHz Channel mode / 5260 ~ 5320MHz / CH Mid
Temperature: 27°C
Humidity: 53% RH

Test Date: July 29, 2014
Tested by: Andy Shi
Polarity: Ver. / Hor.

Frequency (MHz)	Reading (dBuV)	Correction (dB/m)	Result (dBuV/m)	Limit (dBuV/m)	Margin (dB)	Remark	Ant.Pol. (H/V)
3835.000	49.56	0.52	50.08	74.00	-23.92	peak	V
N/A							
3261.000	51.95	-1.48	50.47	74.00	-23.53	peak	H
N/A							

Remark:

1. Measuring frequencies from 1 GHz to the 10th harmonic of highest fundamental frequency.
2. Radiated emissions measured in frequency above 1000MHz were made with an instrument using peak/average detector mode.
3. Average test would be performed if the peak result were greater than the average limit.
4. Data of measurement within this frequency range shown " --- " in the table above means the reading of emissions are attenuated more than 20dB below the permissible limits or the field strength is too small to be measured.
5. Measurements above show only up to 6 maximum emissions noted, or would be lesser, with " N/A " remark, if no specific emissions from the EUT are recorded (ie: margin>20dB from the applicable limit) and considered that's already beyond the background noise floor.
6. Margin (dB) = Remark result (dBuV/m) – Average limit (dBuV/m).



Operation Mode: Tx / IEEE 802.11n HT 20 MHz Channel mode / 5260 ~ 5320MHz / CH High **Test Date:** July 29, 2014
Temperature: 27°C **Tested by:** Andy Shi
Humidity: 53% RH **Polarity:** Ver. / Hor.

Frequency (MHz)	Reading (dBuV)	Correction (dB/m)	Result (dBuV/m)	Limit (dBuV/m)	Margin (dB)	Remark	Ant.Pol. (H/V)
3989.000	50.59	1.18	51.77	74.00	-22.23	peak	V
N/A							
4066.000	50.22	1.48	51.70	74.00	-22.30	peak	H
N/A							

Remark:

1. Measuring frequencies from 1 GHz to the 10th harmonic of highest fundamental frequency.
2. Radiated emissions measured in frequency above 1000MHz were made with an instrument using peak/average detector mode.
3. Average test would be performed if the peak result were greater than the average limit.
4. Data of measurement within this frequency range shown " --- " in the table above means the reading of emissions are attenuated more than 20dB below the permissible limits or the field strength is too small to be measured.
5. Measurements above show only up to 6 maximum emissions noted, or would be lesser, with " N/A " remark, if no specific emissions from the EUT are recorded (ie: margin>20dB from the applicable limit) and considered that's already beyond the background noise floor.
6. Margin (dB) = Remark result (dBuV/m) – Average limit (dBuV/m).



Operation Mode: Tx / IEEE 802.11n HT 40 MHz mode / 5270 ~ 5310MHz / CH Low **Test Date:** July 29, 2014
Temperature: 27°C **Tested by:** Andy Shi
Humidity: 53% RH **Polarity:** Ver. / Hor.

Frequency (MHz)	Reading (dBuV)	Correction (dB/m)	Result (dBuV/m)	Limit (dBuV/m)	Margin (dB)	Remark	Ant.Pol. (H/V)
4080.000	50.42	1.53	51.95	74.00	-22.05	peak	V
N/A							
3184.000	51.90	-1.67	50.23	74.00	-23.77	peak	H
N/A							

Remark:

1. Measuring frequencies from 1 GHz to the 10th harmonic of highest fundamental frequency.
2. Radiated emissions measured in frequency above 1000MHz were made with an instrument using peak/average detector mode.
3. Average test would be performed if the peak result were greater than the average limit.
4. Data of measurement within this frequency range shown “ --- ” in the table above means the reading of emissions are attenuated more than 20dB below the permissible limits or the field strength is too small to be measured.
5. Measurements above show only up to 6 maximum emissions noted, or would be lesser, with “ N/A ” remark, if no specific emissions from the EUT are recorded (ie: margin>20dB from the applicable limit) and considered that's already beyond the background noise floor.
6. Margin (dB) = Remark result (dBuV/m) – Average limit (dBuV/m).



Operation Mode: Tx / IEEE 802.11n HT 40 MHz mode / 5270 ~ 5310MHz / CH High **Test Date:** July 29, 2014
Temperature: 27°C **Tested by:** Andy Shi
Humidity: 53% RH **Polarity:** Ver. / Hor.

Frequency (MHz)	Reading (dBuV)	Correction (dB/m)	Result (dBuV/m)	Limit (dBuV/m)	Margin (dB)	Remark	Ant.Pol. (H/V)
4136.000	50.13	1.74	51.87	74.00	-22.13	peak	V
N/A							
3226.000	52.04	-1.57	50.47	74.00	-23.53	peak	H
N/A							

Remark:

1. Measuring frequencies from 1 GHz to the 10th harmonic of highest fundamental frequency.
2. Radiated emissions measured in frequency above 1000MHz were made with an instrument using peak/average detector mode.
3. Average test would be performed if the peak result were greater than the average limit.
4. Data of measurement within this frequency range shown " --- " in the table above means the reading of emissions are attenuated more than 20dB below the permissible limits or the field strength is too small to be measured.
5. Measurements above show only up to 6 maximum emissions noted, or would be lesser, with " N/A " remark, if no specific emissions from the EUT are recorded (ie: margin>20dB from the applicable limit) and considered that's already beyond the background noise floor.
6. Margin (dB) = Remark result (dBuV/m) – Average limit (dBuV/m).



Operation Mode: Tx / IEEE 802.11a mode / 5500 ~ 5700MHz / CH Low **Test Date:** July 29, 2014
Temperature: 27°C **Tested by:** Andy Shi
Humidity: 53% RH **Polarity:** Ver. / Hor.

Frequency (MHz)	Reading (dBuV)	Correction (dB/m)	Result (dBuV/m)	Limit (dBuV/m)	Margin (dB)	Remark	Ant.Pol. (H/V)
4136.000	50.12	1.74	51.86	74.00	-22.14	peak	V
N/A							
4129.000	50.42	1.72	52.14	74.00	-21.86	peak	H
N/A							

Remark:

1. Measuring frequencies from 1 GHz to the 10th harmonic of highest fundamental frequency.
2. Radiated emissions measured in frequency above 1000MHz were made with an instrument using peak/average detector mode.
3. Average test would be performed if the peak result were greater than the average limit or as required by the applicant.
4. Data of measurement within this frequency range shown “ --- ” in the table above means the reading of emissions are attenuated more than 20dB below the permissible limits or the field strength is too small to be measured.
5. Measurements above show only up to 6 maximum emissions noted, or would be lesser, with “ N/A ” remark, if no specific emissions from the EUT are recorded (ie: margin>20dB from the applicable limit) and considered that's already beyond the background noise floor.
6. Margin (dB) = Remark result (dBuV/m) – Average limit (dBuV/m).



Operation Mode: Tx / IEEE 802.11a mode / 5500 ~ 5700MHz /CH Mid **Test Date:** July 29, 2014
Temperature: 27°C **Tested by:** Andy Shi
Humidity: 53% RH **Polarity:** Ver. / Hor.

Frequency (MHz)	Reading (dBuV)	Correction (dB/m)	Result (dBuV/m)	Limit (dBuV/m)	Margin (dB)	Remark	Ant.Pol. (H/V)
4150.000	49.61	1.80	51.41	74.00	-22.59	peak	V
N/A							
3254.000	52.75	-1.50	51.25	74.00	-22.75	peak	H
N/A							

Remark:

1. Measuring frequencies from 1 GHz to the 10th harmonic of highest fundamental frequency.
2. Radiated emissions measured in frequency above 1000MHz were made with an instrument using peak/average detector mode.
3. Average test would be performed if the peak result were greater than the average limit or as required by the applicant.
4. Data of measurement within this frequency range shown “ --- ” in the table above means the reading of emissions are attenuated more than 20dB below the permissible limits or the field strength is too small to be measured.
5. Measurements above show only up to 6 maximum emissions noted, or would be lesser, with “ N/A ” remark, if no specific emissions from the EUT are recorded (ie: margin>20dB from the applicable limit) and considered that's already beyond the background noise floor.
6. Margin (dB) = Remark result (dBuV/m) – Average limit (dBuV/m).



Operation Mode: Tx / IEEE 802.11a mode / 5500 ~ 5700MHz / CH High **Test Date:** July 29, 2014
Temperature: 27°C **Tested by:** Andy Shi
Humidity: 53% RH **Polarity:** Ver. / Hor.

Frequency (MHz)	Reading (dBuV)	Correction (dB/m)	Result (dBuV/m)	Limit (dBuV/m)	Margin (dB)	Remark	Ant.Pol. (H/V)
4262.000	49.23	2.22	51.45	74.00	-22.55	peak	V
N/A							
3688.000	50.08	-0.11	49.97	74.00	-24.03	peak	H
N/A							

Remark:

1. Measuring frequencies from 1 GHz to the 10th harmonic of highest fundamental frequency.
2. Radiated emissions measured in frequency above 1000MHz were made with an instrument using peak/average detector mode.
3. Average test would be performed if the peak result were greater than the average limit or as required by the applicant.
4. Data of measurement within this frequency range shown “ --- ” in the table above means the reading of emissions are attenuated more than 20dB below the permissible limits or the field strength is too small to be measured.
5. Measurements above show only up to 6 maximum emissions noted, or would be lesser, with “ N/A ” remark, if no specific emissions from the EUT are recorded (ie: margin>20dB from the applicable limit) and considered that's already beyond the background noise floor.
6. Margin (dB) = Remark result (dBuV/m) – Average limit (dBuV/m).



Operation Mode: Tx / IEEE 802.11n HT 20 MHz Channel mode / 5500 ~ 5700MHz / CH Low
Temperature: 27°C
Humidity: 53% RH

Test Date: July 29, 2014
Tested by: Andy Shi
Polarity: Ver. / Hor.

Frequency (MHz)	Reading (dBuV)	Correction (dB/m)	Result (dBuV/m)	Limit (dBuV/m)	Margin (dB)	Remark	Ant.Pol. (H/V)
3163.000	52.18	-1.72	50.46	74.00	-23.54	peak	V
N/A							
3898.000	50.93	0.79	51.72	74.00	-22.28	peak	H
N/A							

Remark:

1. Measuring frequencies from 1 GHz to the 10th harmonic of highest fundamental frequency.
2. Radiated emissions measured in frequency above 1000MHz were made with an instrument using peak/average detector mode.
3. Average test would be performed if the peak result were greater than the average limit or as required by the applicant.
4. Data of measurement within this frequency range shown “ --- ” in the table above means the reading of emissions are attenuated more than 20dB below the permissible limits or the field strength is too small to be measured.
5. Measurements above show only up to 6 maximum emissions noted, or would be lesser, with “ N/A ” remark, if no specific emissions from the EUT are recorded (ie: margin>20dB from the applicable limit) and considered that's already beyond the background noise floor.
6. Margin (dB) = Remark result (dBuV/m) – Average limit (dBuV/m).



Operation Mode: Tx / IEEE 802.11n HT 20 MHz Channel mode / 5500 ~ 5700MHz / CH Mid
Temperature: 27°C
Humidity: 53% RH

Test Date: July 29, 2014
Tested by: Andy Shi
Polarity: Ver. / Hor.

Frequency (MHz)	Reading (dBuV)	Correction (dB/m)	Result (dBuV/m)	Limit (dBuV/m)	Margin (dB)	Remark	Ant.Pol. (H/V)
3968.000	50.00	1.09	51.09	74.00	-22.91	peak	V
N/A							
4010.000	49.85	1.27	51.12	74.00	-22.88	peak	H
N/A							

Remark:

1. Measuring frequencies from 1 GHz to the 10th harmonic of highest fundamental frequency.
2. Radiated emissions measured in frequency above 1000MHz were made with an instrument using peak/average detector mode.
3. Average test would be performed if the peak result were greater than the average limit or as required by the applicant.
4. Data of measurement within this frequency range shown “ --- ” in the table above means the reading of emissions are attenuated more than 20dB below the permissible limits or the field strength is too small to be measured.
5. Measurements above show only up to 6 maximum emissions noted, or would be lesser, with “ N/A ” remark, if no specific emissions from the EUT are recorded (ie: margin>20dB from the applicable limit) and considered that's already beyond the background noise floor.
6. Margin (dB) = Remark result (dBuV/m) – Average limit (dBuV/m).



Operation Mode: Tx / IEEE 802.11n HT 20 MHz Channel mode / 5500 ~ 5700MHz / CH High

Test Date: July 29, 2014

Temperature: 27°C

Tested by: Andy Shi

Humidity: 53% RH

Polarity: Ver. / Hor.

Frequency (MHz)	Reading (dBuV)	Correction (dB/m)	Result (dBuV/m)	Limit (dBuV/m)	Margin (dB)	Remark	Ant.Pol. (H/V)
4010.000	49.94	1.27	51.21	74.00	-22.79	peak	V
N/A							
3338.000	51.43	-1.30	50.13	74.00	-23.87	peak	H
N/A							

Remark:

1. Measuring frequencies from 1 GHz to the 10th harmonic of highest fundamental frequency.
2. Radiated emissions measured in frequency above 1000MHz were made with an instrument using peak/average detector mode.
3. Average test would be performed if the peak result were greater than the average limit or as required by the applicant.
4. Data of measurement within this frequency range shown “ --- ” in the table above means the reading of emissions are attenuated more than 20dB below the permissible limits or the field strength is too small to be measured.
5. Measurements above show only up to 6 maximum emissions noted, or would be lesser, with “ N/A ” remark, if no specific emissions from the EUT are recorded (ie: margin>20dB from the applicable limit) and considered that's already beyond the background noise floor.
6. Margin (dB) = Remark result (dBuV/m) – Average limit (dBuV/m).



Operation Mode: Tx / IEEE 802.11n HT 40 MHz mode / 5510 ~ 5670MHz / CH Low **Test Date:** July 29, 2014
Temperature: 27°C **Tested by:** Andy Shi
Humidity: 53% RH **Polarity:** Ver. / Hor.

Frequency (MHz)	Reading (dBuV)	Correction (dB/m)	Result (dBuV/m)	Limit (dBuV/m)	Margin (dB)	Remark	Ant.Pol. (H/V)
2512.000	49.90	-3.10	46.80	74.00	-27.20	peak	V
N/A							
4402.000	49.40	2.75	52.15	74.00	-21.85	peak	H
N/A							

Remark:

1. Measuring frequencies from 1 GHz to the 10th harmonic of highest fundamental frequency.
2. Radiated emissions measured in frequency above 1000MHz were made with an instrument using peak/average detector mode.
3. Average test would be performed if the peak result were greater than the average limit or as required by the applicant.
4. Data of measurement within this frequency range shown “ --- ” in the table above means the reading of emissions are attenuated more than 20dB below the permissible limits or the field strength is too small to be measured.
5. Measurements above show only up to 6 maximum emissions noted, or would be lesser, with “ N/A ” remark, if no specific emissions from the EUT are recorded (ie: margin>20dB from the applicable limit) and considered that's already beyond the background noise floor.
6. Margin (dB) = Remark result (dBuV/m) – Average limit (dBuV/m).



Operation Mode: Tx / IEEE 802.11n HT 40 MHz mode / 5510 ~ 5670MHz / CH Mid **Test Date:** July 29, 2014
Temperature: 27°C **Tested by:** Andy Shi
Humidity: 53% RH **Polarity:** Ver. / Hor.

Frequency (MHz)	Reading (dBuV)	Correction (dB/m)	Result (dBuV/m)	Limit (dBuV/m)	Margin (dB)	Remark	Ant.Pol. (H/V)
4052.000	50.21	1.43	51.64	74.00	-22.36	peak	V
N/A							
3415.000	51.58	-1.11	50.47	74.00	-23.53	peak	H
N/A							

Remark:

1. Measuring frequencies from 1 GHz to the 10th harmonic of highest fundamental frequency.
2. Radiated emissions measured in frequency above 1000MHz were made with an instrument using peak/average detector mode.
3. Average test would be performed if the peak result were greater than the average limit or as required by the applicant.
4. Data of measurement within this frequency range shown “ --- ” in the table above means the reading of emissions are attenuated more than 20dB below the permissible limits or the field strength is too small to be measured.
5. Measurements above show only up to 6 maximum emissions noted, or would be lesser, with “ N/A ” remark, if no specific emissions from the EUT are recorded (ie: margin>20dB from the applicable limit) and considered that's already beyond the background noise floor.
6. Margin (dB) = Remark result (dBuV/m) – Average limit (dBuV/m).



Operation Mode: Tx / IEEE 802.11n HT 40 MHz mode / 5510 ~ 5670MHz / CH High **Test Date:** July 29, 2014
Temperature: 27°C **Tested by:** Andy Shi
Humidity: 53% RH **Polarity:** Ver. / Hor.

Frequency (MHz)	Reading (dBuV)	Correction (dB/m)	Result (dBuV/m)	Limit (dBuV/m)	Margin (dB)	Remark	Ant.Pol. (H/V)
4339.000	50.67	2.51	53.18	74.00	-20.82	peak	V
N/A							
3275.000	51.90	-1.45	50.45	74.00	-23.55	peak	H
N/A							

Remark:

1. Measuring frequencies from 1 GHz to the 10th harmonic of highest fundamental frequency.
2. Radiated emissions measured in frequency above 1000MHz were made with an instrument using peak/average detector mode.
3. Average test would be performed if the peak result were greater than the average limit or as required by the applicant.
4. Data of measurement within this frequency range shown “ --- ” in the table above means the reading of emissions are attenuated more than 20dB below the permissible limits or the field strength is too small to be measured.
5. Measurements above show only up to 6 maximum emissions noted, or would be lesser, with “ N/A ” remark, if no specific emissions from the EUT are recorded (ie: margin>20dB from the applicable limit) and considered that's already beyond the background noise floor.
6. Margin (dB) = Remark result (dBuV/m) – Average limit (dBuV/m).



8.7 POWERLINE CONDUCTED EMISSIONS

LIMIT

According to §15.207(a) & RSS-Gen §7.2.4, except as shown in paragraphs (b) and (c) of this section, for an intentional radiator that is designed to be connected to the public utility (AC) power line, the radio frequency voltage that is conducted back onto the AC power line on any frequency or frequencies within the band 150 kHz to 30 MHz shall not exceed the limits in the following table, as measured using a 50 μ H/50 ohms line impedance stabilization network (LISN). Compliance with the provisions of this paragraph shall be based on the measurement of the radio frequency voltage between each power line and ground at the power terminal. The lower limit applies at the boundary between the frequency ranges.

Frequency Range (MHz)	Limits (dB μ V)	
	Quasi-peak	Average
0.15 to 0.50	66 to 56*	56 to 46*
0.50 to 5	56	46
5 to 30	60	50

* Decreases with the logarithm of the frequency.

Test Configuration

See test photographs attached in Appendix II for the actual connections between EUT and support equipment.

TEST PROCEDURE

1. The EUT was placed on a table, which is 0.8m above ground plane.
2. Maximum procedure was performed on the six highest emissions to ensure EUT compliance.
3. Repeat above procedures until all frequency measured were complete.



TEST RESULTS

The initial step in collecting conducted data is a spectrum analyzer peak scan of the measurement range. Significant peaks are then marked as shown on the following data page, and these signals are then quasi-peaked.

Test Data

Operation Mode: Normal Link **Test Date:** July 30, 2014
Temperature: 26°C **Tested by:** Ali Shu
Humidity: 60% RH

Freq. (MHz)	QP Reading (dBuV)	AV Reading (dBuV)	Corr. factor (dB)	QP Result (dBuV)	AV Result (dBuV)	QP Limit (dBuV)	AV Limit (dBuV)	QP Margin (dB)	AV Margin (dB)	Note
0.1659	32.69	20.47	0.19	32.88	20.66	65.16	55.16	-32.28	-34.50	L1
0.2773	30.52	22.53	0.19	30.71	22.72	60.90	50.90	-30.19	-28.18	L1
0.4761	36.28	31.11	0.20	36.48	31.31	56.41	46.41	-19.93	-15.10	L1
0.6683	40.90	27.70	0.20	41.10	27.90	56.00	46.00	-14.90	-18.10	L1
2.4476	29.03	22.71	0.15	29.18	22.86	56.00	46.00	-26.82	-23.14	L1
6.2189	18.62	12.08	0.30	18.92	12.38	60.00	50.00	-41.08	-37.62	L1
0.2773	32.73	22.90	0.10	32.83	23.00	60.90	50.90	-28.07	-27.90	L2
0.4215	38.76	26.95	0.10	38.86	27.05	57.42	47.42	-18.56	-20.37	L2
0.5074	37.07	25.94	0.10	37.17	26.04	56.00	46.00	-18.83	-19.96	L2
0.7960	32.04	22.11	0.10	32.14	22.21	56.00	46.00	-23.86	-23.79	L2
1.0766	32.78	22.92	0.09	32.87	23.01	56.00	46.00	-23.13	-22.99	L2
2.5133	32.73	23.49	0.00	32.73	23.49	56.00	46.00	-23.27	-22.51	L2

Remark:

1. Measuring frequencies from 0.15 MHz to 30MHz.
2. The emissions measured in frequency range from 0.15 MHz to 30MHz were made with an instrument using Quasi-peak detector and average detector.
3. The IF bandwidth of SPA between 0.15MHz to 30MHz was 10kHz; the IF bandwidth of Test Receiver between 0.15MHz to 30MHz was 9kHz;
4. L1 = Line One (Live Line) / L2 = Line Two (Neutral Line)



Test Plots

Conducted emissions (Line 1)

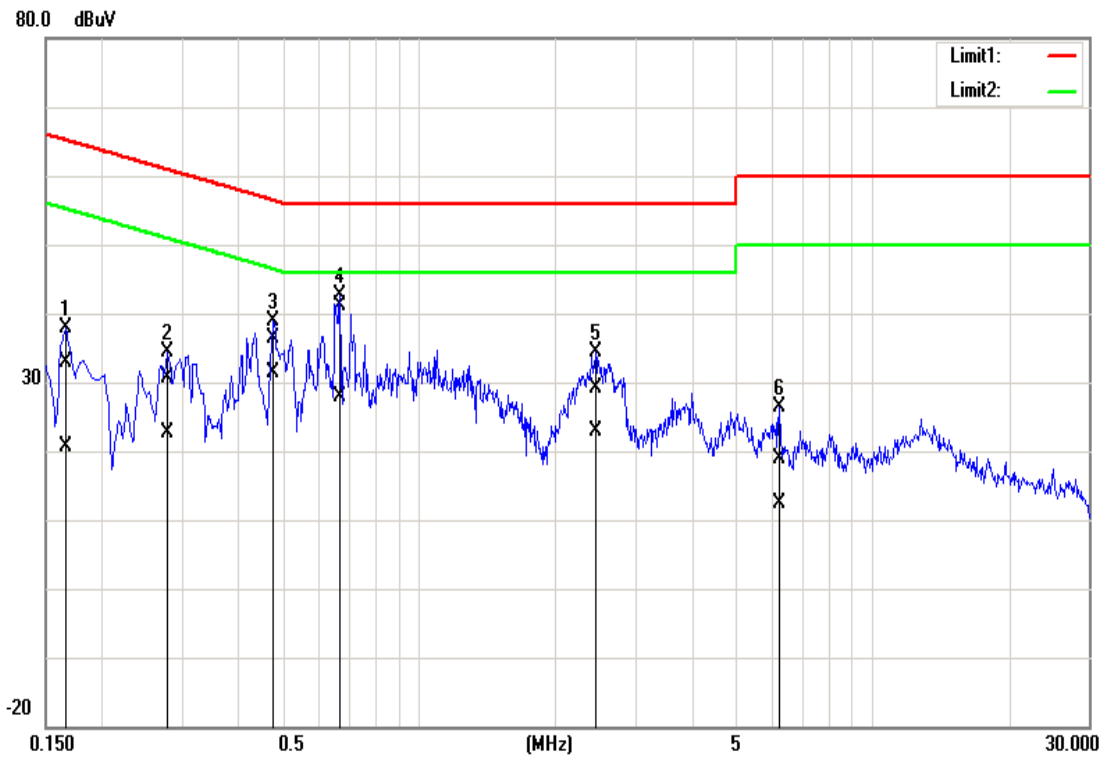

Conducted emissions (Line 2)

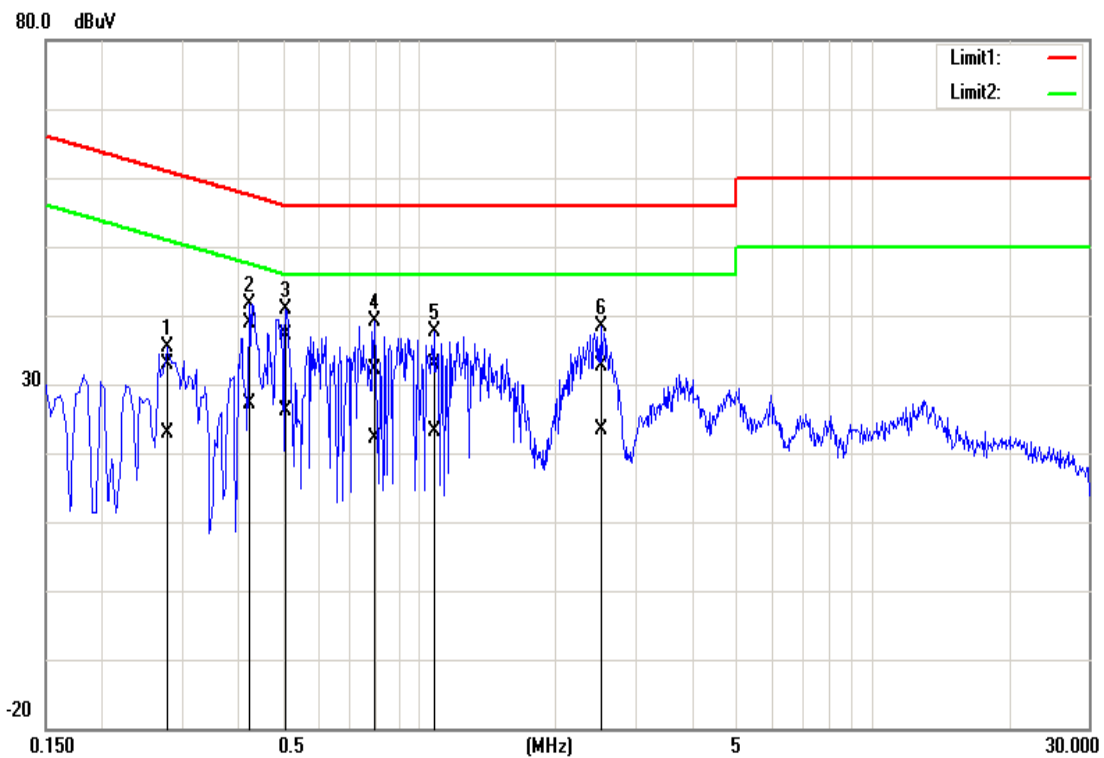



8.8 FREQUENCY STABILITY

LIMIT

According to §15.407(g) & RSS-210 §A9.5(5), manufacturers of U-NII devices are responsible for ensuring frequency stability such that an emission is maintained within the band of operation under all conditions of normal operation as specified in the operational description.

Test Configuration

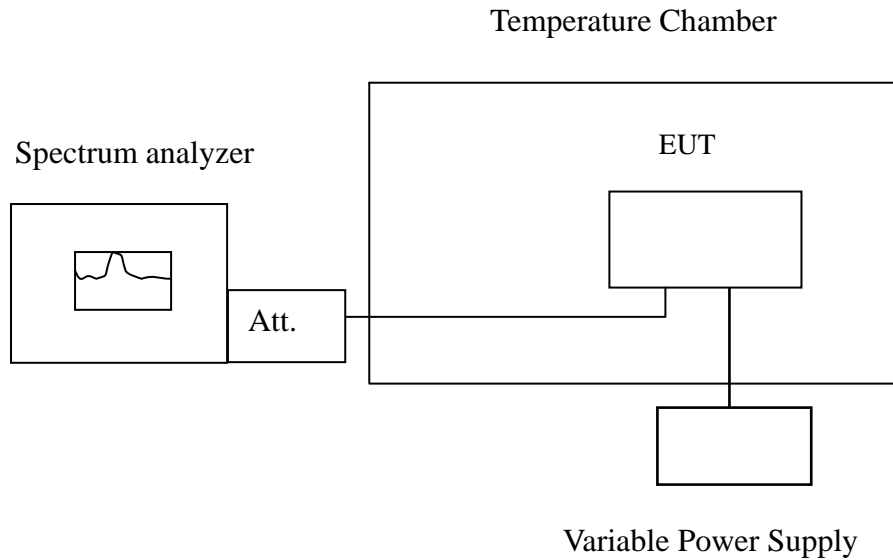

Remark: Measurement setup for testing on Antenna connector



TEST PROCEDURE

The equipment under test was connected to an external AC or DC power supply and input rated voltage. RF output was connected to a frequency counter or spectrum analyzer via feed through attenuators. The EUT was placed inside the temperature chamber. Set the spectrum analyzer RBW low enough to obtain the desired frequency resolution and measure EUT 20°C operating frequency as reference frequency. Turn EUT off and set the chamber temperature to -20°C. After the temperature stabilized for approximately 30 minutes recorded the frequency. Repeat step measure with 10°C increased per stage until the highest temperature of +50°C reached.

TEST RESULTS

No non-compliance noted.

IEEE 802.11a mode / 5180 ~ 5240 MHz:

CH Low

Operating Frequency: 5180 MHz				
Environment Temperature (°C)	Voltage (V)	Measured Frequency (MHz)	Limit Range	Test Result
50	120	5180.020104	5150~5250	Pass
40	120	5179.987766	5150~5250	Pass
30	120	5179.997730	5150~5250	Pass
20	120	5179.984576	5150~5250	Pass
10	120	5179.991943	5150~5250	Pass
0	120	5179.981198	5150~5250	Pass
-10	120	5179.989819	5150~5250	Pass
-20	120	5180.020049	5150~5250	Pass

Operating Frequency: 5180 MHz				
Environment Temperature (°C)	Voltage (V)	Measured Frequency (MHz)	Limit Range	Test Result
20	102	5180.009305	5150~5250	Pass
	120	5179.988074	5150~5250	Pass
	138	5179.993741	5150~5250	Pass



CH Mid

Operating Frequency: 5220 MHz				
Environment Temperature (°C)	Voltage (V)	Measured Frequency (MHz)	Limit Range	Test Result
50	120	5219.993423	5150~5250	Pass
40	120	5220.018235	5150~5250	Pass
30	120	5220.019894	5150~5250	Pass
20	120	5219.990907	5150~5250	Pass
10	120	5220.011520	5150~5250	Pass
0	120	5220.009819	5150~5250	Pass
-10	120	5220.019969	5150~5250	Pass
-20	120	5219.971158	5150~5250	Pass

Operating Frequency: 5220 MHz				
Environment Temperature (°C)	Voltage (V)	Measured Frequency (MHz)	Limit Range	Test Result
20	102	5219.979374	5150~5250	Pass
	120	5219.99823	5150~5250	Pass
	138	5219.979972	5150~5250	Pass



CH High

Operating Frequency: 5240 MHz				
Environment Temperature (°C)	Voltage (V)	Measured Frequency (MHz)	Limit Range	Test Result
50	120	5240.012832	5150~5250	Pass
40	120	5239.995955	5150~5250	Pass
30	120	5240.017236	5150~5250	Pass
20	120	5240.008079	5150~5250	Pass
10	120	5240.017778	5150~5250	Pass
0	120	5240.017268	5150~5250	Pass
-10	120	5240.000824	5150~5250	Pass
-20	120	5239.997129	5150~5250	Pass

Operating Frequency: 5240 MHz				
Environment Temperature (°C)	Voltage (V)	Measured Frequency (MHz)	Limit Range	Test Result
20	102	5240.009828	5150~5250	Pass
	120	5240.01211	5150~5250	Pass
	138	5240.012567	5150~5250	Pass



IEEE 802.11n HT 20 MHz Channel mode / 5180 ~ 5240 MHz:

CH Low

Operating Frequency: 5180 MHz				
Environment Temperature (°C)	Voltage (V)	Measured Frequency (MHz)	Limit Range	Test Result
50	120	5180.006147	5150~5250	Pass
40	120	5180.019597	5150~5250	Pass
30	120	5179.995414	5150~5250	Pass
20	120	5179.989217	5150~5250	Pass
10	120	5180.019318	5150~5250	Pass
0	120	5179.970801	5150~5250	Pass
-10	120	5179.992900	5150~5250	Pass
-20	120	5180.014787	5150~5250	Pass

Operating Frequency: 5180 MHz				
Environment Temperature (°C)	Voltage (V)	Measured Frequency (MHz)	Limit Range	Test Result
20	102	5180.013539	5150~5250	Pass
	120	5179.976992	5150~5250	Pass
	138	5179.991152	5150~5250	Pass



CH Mid

Operating Frequency: 5220 MHz				
Environment Temperature (°C)	Voltage (V)	Measured Frequency (MHz)	Limit Range	Test Result
50	120	5219.976264	5150~5250	Pass
40	120	5220.018765	5150~5250	Pass
30	120	5220.020539	5150~5250	Pass
20	120	5219.973571	5150~5250	Pass
10	120	5220.006648	5150~5250	Pass
0	120	5220.003141	5150~5250	Pass
-10	120	5219.976759	5150~5250	Pass
-20	120	5219.980728	5150~5250	Pass

Operating Frequency: 5220 MHz				
Environment Temperature (°C)	Voltage (V)	Measured Frequency (MHz)	Limit Range	Test Result
20	102	5219.998922	5150~5250	Pass
	120	5220.000812	5150~5250	Pass
	138	5219.973485	5150~5250	Pass



CH High

Operating Frequency: 5240 MHz				
Environment Temperature (°C)	Voltage (V)	Measured Frequency (MHz)	Limit Range	Test Result
50	120	5239.984396	5150~5250	Pass
40	120	5239.985628	5150~5250	Pass
30	120	5239.995997	5150~5250	Pass
20	120	5239.981515	5150~5250	Pass
10	120	5239.971908	5150~5250	Pass
0	120	5240.002985	5150~5250	Pass
-10	120	5240.008241	5150~5250	Pass
-20	120	5240.004747	5150~5250	Pass

Operating Frequency: 5240 MHz				
Environment Temperature (°C)	Voltage (V)	Measured Frequency (MHz)	Limit Range	Test Result
20	102	5239.993639	5150~5250	Pass
	120	5240.017174	5150~5250	Pass
	138	5240.000591	5150~5250	Pass



IEEE 802.11n HT 40 MHz mode / 5190 ~ 5230 MHz:

CH Low

Operating Frequency: 5190 MHz				
Environment Temperature (°C)	Voltage (V)	Measured Frequency (MHz)	Limit Range	Test Result
50	120	5189.991421	5150~5250	Pass
40	120	5189.973223	5150~5250	Pass
30	120	5189.989479	5150~5250	Pass
20	120	5190.011310	5150~5250	Pass
10	120	5189.998409	5150~5250	Pass
0	120	5189.997165	5150~5250	Pass
-10	120	5190.015223	5150~5250	Pass
-20	120	5189.994804	5150~5250	Pass

Operating Frequency: 5190 MHz				
Environment Temperature (°C)	Voltage (V)	Measured Frequency (MHz)	Limit Range	Test Result
20	102	5189.989633	5150~5250	Pass
	120	5189.980552	5150~5250	Pass
	138	5190.006414	5150~5250	Pass



CH High

Operating Frequency: 5230 MHz				
Environment Temperature (°C)	Voltage (V)	Measured Frequency (MHz)	Limit Range	Test Result
50	120	5229.995033	5150~5250	Pass
40	120	5230.010374	5150~5250	Pass
30	120	5230.011147	5150~5250	Pass
20	120	5229.988902	5150~5250	Pass
10	120	5229.973942	5150~5250	Pass
0	120	5229.978400	5150~5250	Pass
-10	120	5230.018273	5150~5250	Pass
-20	120	5229.998394	5150~5250	Pass

Operating Frequency: 5230 MHz				
Environment Temperature (°C)	Voltage (V)	Measured Frequency (MHz)	Limit Range	Test Result
20	102	5230.012155	5150~5250	Pass
	120	5229.988561	5150~5250	Pass
	138	5229.971844	5150~5250	Pass



IEEE 802.11a mode / 5260 ~ 5320 MHz:

CH Low

Operating Frequency: 5260 MHz				
Environment Temperature (°C)	Voltage (V)	Measured Frequency (MHz)	Limit Range	Test Result
50	120	5259.977796	5250~5350	Pass
40	120	5259.999193	5250~5350	Pass
30	120	5259.979789	5250~5350	Pass
20	120	5259.970242	5250~5350	Pass
10	120	5259.978071	5250~5350	Pass
0	120	5259.984633	5250~5350	Pass
-10	120	5260.010392	5250~5350	Pass
-20	120	5260.020681	5250~5350	Pass

Operating Frequency: 5260 MHz				
Environment Temperature (°C)	Voltage (V)	Measured Frequency (MHz)	Limit Range	Test Result
20	102	5260.020852	5250~5350	Pass
	120	5260.018477	5250~5350	Pass
	138	5260.004532	5250~5350	Pass



CH Mid

Operating Frequency: 5280 MHz				
Environment Temperature (°C)	Voltage (V)	Measured Frequency (MHz)	Limit Range	Test Result
50	120	5279.989248	5250~5350	Pass
40	120	5280.006516	5250~5350	Pass
30	120	5280.004454	5250~5350	Pass
20	120	5280.014902	5250~5350	Pass
10	120	5279.991524	5250~5350	Pass
0	120	5280.017403	5250~5350	Pass
-10	120	5280.011392	5250~5350	Pass
-20	120	5279.995779	5250~5350	Pass

Operating Frequency: 5280 MHz				
Environment Temperature (°C)	Voltage (V)	Measured Frequency (MHz)	Limit Range	Test Result
20	102	5279.970423	5250~5350	Pass
	120	5280.015976	5250~5350	Pass
	138	5279.998203	5250~5350	Pass



CH High

Operating Frequency: 5320 MHz				
Environment Temperature (°C)	Voltage (V)	Measured Frequency (MHz)	Limit Range	Test Result
50	120	5319.996652	5250~5350	Pass
40	120	5320.002152	5250~5350	Pass
30	120	5319.990892	5250~5350	Pass
20	120	5319.984559	5250~5350	Pass
10	120	5319.984471	5250~5350	Pass
0	120	5320.016849	5250~5350	Pass
-10	120	5319.975508	5250~5350	Pass
-20	120	5320.001752	5250~5350	Pass

Operating Frequency: 5320 MHz				
Environment Temperature (°C)	Voltage (V)	Measured Frequency (MHz)	Limit Range	Test Result
20	102	5319.990078	5250~5350	Pass
	120	5319.995155	5250~5350	Pass
	138	5320.014646	5250~5350	Pass



IEEE 802.11n HT 20 MHz Channel mode / 5260 ~ 5320 MHz:

CH Low

Operating Frequency: 5260 MHz				
Environment Temperature (°C)	Voltage (V)	Measured Frequency (MHz)	Limit Range	Test Result
50	120	5259.977367	5250~5350	Pass
40	120	5259.970261	5250~5350	Pass
30	120	5260.020446	5250~5350	Pass
20	120	5259.988203	5250~5350	Pass
10	120	5259.971438	5250~5350	Pass
0	120	5260.001006	5250~5350	Pass
-10	120	5260.012175	5250~5350	Pass
-20	120	5260.014832	5250~5350	Pass

Operating Frequency: 5260 MHz				
Environment Temperature (°C)	Voltage (V)	Measured Frequency (MHz)	Limit Range	Test Result
20	102	5260.015407	5250~5350	Pass
	120	5259.986289	5250~5350	Pass
	138	5259.99885	5250~5350	Pass



CH Mid

Operating Frequency: 5280 MHz				
Environment Temperature (°C)	Voltage (V)	Measured Frequency (MHz)	Limit Range	Test Result
50	120	5279.987275	5250~5350	Pass
40	120	5279.981010	5250~5350	Pass
30	120	5279.982632	5250~5350	Pass
20	120	5280.005165	5250~5350	Pass
10	120	5279.991405	5250~5350	Pass
0	120	5279.981599	5250~5350	Pass
-10	120	5279.972985	5250~5350	Pass
-20	120	5279.973194	5250~5350	Pass

Operating Frequency: 5280 MHz				
Environment Temperature (°C)	Voltage (V)	Measured Frequency (MHz)	Limit Range	Test Result
20	102	5279.994996	5250~5350	Pass
	120	5279.990224	5250~5350	Pass
	138	5279.986353	5250~5350	Pass



CH High

Operating Frequency: 5320 MHz				
Environment Temperature (°C)	Voltage (V)	Measured Frequency (MHz)	Limit Range	Test Result
50	120	5320.018371	5250~5350	Pass
40	120	5320.012155	5250~5350	Pass
30	120	5320.020088	5250~5350	Pass
20	120	5319.982222	5250~5350	Pass
10	120	5320.017559	5250~5350	Pass
0	120	5319.977793	5250~5350	Pass
-10	120	5320.002336	5250~5350	Pass
-20	120	5319.994341	5250~5350	Pass

Operating Frequency: 5320 MHz				
Environment Temperature (°C)	Voltage (V)	Measured Frequency (MHz)	Limit Range	Test Result
20	102	5320.017738	5250~5350	Pass
	120	5319.979097	5250~5350	Pass
	138	5320.001219	5250~5350	Pass



IEEE 802.11n HT 40 MHz mode / 5270 ~ 5310 MHz:

CH Low

Operating Frequency: 5270 MHz				
Environment Temperature (°C)	Voltage (V)	Measured Frequency (MHz)	Limit Range	Test Result
50	120	5269.976766	5250~5350	Pass
40	120	5269.975979	5250~5350	Pass
30	120	5269.974322	5250~5350	Pass
20	120	5269.987208	5250~5350	Pass
10	120	5269.973175	5250~5350	Pass
0	120	5270.018321	5250~5350	Pass
-10	120	5269.973693	5250~5350	Pass
-20	120	5269.999056	5250~5350	Pass

Operating Frequency: 5270 MHz				
Environment Temperature (°C)	Voltage (V)	Measured Frequency (MHz)	Limit Range	Test Result
20	102	5270.016063	5250~5350	Pass
	120	5269.974187	5250~5350	Pass
	138	5269.982781	5250~5350	Pass



CH High

Operating Frequency: 5310 MHz				
Environment Temperature (°C)	Voltage (V)	Measured Frequency (MHz)	Limit Range	Test Result
50	120	5309.988797	5250~5350	Pass
40	120	5310.006620	5250~5350	Pass
30	120	5309.988505	5250~5350	Pass
20	120	5309.996473	5250~5350	Pass
10	120	5309.973921	5250~5350	Pass
0	120	5310.014221	5250~5350	Pass
-10	120	5310.001002	5250~5350	Pass
-20	120	5309.992408	5250~5350	Pass

Operating Frequency: 5310 MHz				
Environment Temperature (°C)	Voltage (V)	Measured Frequency (MHz)	Limit Range	Test Result
20	102	5310.017732	5250~5350	Pass
	120	5309.99494	5250~5350	Pass
	138	5310.003025	5250~5350	Pass



IEEE 802.11a mode / 5500 ~ 5700 MHz:

CH Low

Operating Frequency: 5500 MHz				
Environment Temperature (°C)	Voltage (V)	Measured Frequency (MHz)	Limit Range	Test Result
50	120	5499.974858	5470~5725	Pass
40	120	5500.008383	5470~5725	Pass
30	120	5500.016149	5470~5725	Pass
20	120	5499.977047	5470~5725	Pass
10	120	5500.014790	5470~5725	Pass
0	120	5500.019493	5470~5725	Pass
-10	120	5499.992169	5470~5725	Pass
-20	120	5499.977638	5470~5725	Pass

Operating Frequency: 5500 MHz				
Environment Temperature (°C)	Voltage (V)	Measured Frequency (MHz)	Limit Range	Test Result
20	102	5499.983496	5470~5725	Pass
	120	5500.004656	5470~5725	Pass
	138	5500.016716	5470~5725	Pass



CH Mid

Operating Frequency: 5580 MHz				
Environment Temperature (°C)	Voltage (V)	Measured Frequency (MHz)	Limit Range	Test Result
50	120	5579.984700	5470~5725	Pass
40	120	5579.985470	5470~5725	Pass
30	120	5580.011939	5470~5725	Pass
20	120	5580.002837	5470~5725	Pass
10	120	5579.998029	5470~5725	Pass
0	120	5579.992872	5470~5725	Pass
-10	120	5579.999101	5470~5725	Pass
-20	120	5580.007795	5470~5725	Pass

Operating Frequency: 5580 MHz				
Environment Temperature (°C)	Voltage (V)	Measured Frequency (MHz)	Limit Range	Test Result
20	102	5579.986328	5470~5725	Pass
	120	5579.991296	5470~5725	Pass
	138	5579.976506	5470~5725	Pass



CH High

Operating Frequency: 5700 MHz				
Environment Temperature (°C)	Voltage (V)	Measured Frequency (MHz)	Limit Range	Test Result
50	120	5700.007189	5470~5725	Pass
40	120	5699.984735	5470~5725	Pass
30	120	5699.999188	5470~5725	Pass
20	120	5699.996283	5470~5725	Pass
10	120	5700.004573	5470~5725	Pass
0	120	5699.999344	5470~5725	Pass
-10	120	5700.007253	5470~5725	Pass
-20	120	5699.973578	5470~5725	Pass

Operating Frequency: 5700 MHz				
Environment Temperature (°C)	Voltage (V)	Measured Frequency (MHz)	Limit Range	Test Result
20	102	5700.016076	5470~5725	Pass
	120	5700.019676	5470~5725	Pass
	138	5700.010681	5470~5725	Pass



IEEE 802.11n HT 20 MHz Channel mode / 5500 ~ 5700 MHz:

CH Low

Operating Frequency: 5500 MHz				
Environment Temperature (°C)	Voltage (V)	Measured Frequency (MHz)	Limit Range	Test Result
50	120	5500.000371	5470~5725	Pass
40	120	5500.014533	5470~5725	Pass
30	120	5500.011132	5470~5725	Pass
20	120	5499.991335	5470~5725	Pass
10	120	5499.979698	5470~5725	Pass
0	120	5499.971648	5470~5725	Pass
-10	120	5499.983358	5470~5725	Pass
-20	120	5499.977317	5470~5725	Pass

Operating Frequency: 5500 MHz				
Environment Temperature (°C)	Voltage (V)	Measured Frequency (MHz)	Limit Range	Test Result
20	102	5500.015088	5470~5725	Pass
	120	5499.981943	5470~5725	Pass
	138	5500.015559	5470~5725	Pass



CH Mid

Operating Frequency: 5580 MHz				
Environment Temperature (°C)	Voltage (V)	Measured Frequency (MHz)	Limit Range	Test Result
50	120	5580.020263	5470~5725	Pass
40	120	5580.004266	5470~5725	Pass
30	120	5579.984206	5470~5725	Pass
20	120	5580.008231	5470~5725	Pass
10	120	5579.990285	5470~5725	Pass
0	120	5579.971674	5470~5725	Pass
-10	120	5579.994650	5470~5725	Pass
-20	120	5579.984673	5470~5725	Pass

Operating Frequency: 5580 MHz				
Environment Temperature (°C)	Voltage (V)	Measured Frequency (MHz)	Limit Range	Test Result
20	102	5580.020397	5470~5725	Pass
	120	5580.01871	5470~5725	Pass
	138	5580.009433	5470~5725	Pass



CH High

Operating Frequency: 5700 MHz				
Environment Temperature (°C)	Voltage (V)	Measured Frequency (MHz)	Limit Range	Test Result
50	120	5699.973001	5470~5725	Pass
40	120	5699.972084	5470~5725	Pass
30	120	5700.001091	5470~5725	Pass
20	120	5699.983979	5470~5725	Pass
10	120	5699.974522	5470~5725	Pass
0	120	5699.970794	5470~5725	Pass
-10	120	5699.983909	5470~5725	Pass
-20	120	5699.987813	5470~5725	Pass

Operating Frequency: 5700 MHz				
Environment Temperature (°C)	Voltage (V)	Measured Frequency (MHz)	Limit Range	Test Result
20	102	5699.995655	5470~5725	Pass
	120	5699.987276	5470~5725	Pass
	138	5700.002888	5470~5725	Pass



IEEE 802.11n HT 40 MHz mode / 5510 ~ 5670 MHz:

CH Low

Operating Frequency: 5510 MHz				
Environment Temperature (°C)	Voltage (V)	Measured Frequency (MHz)	Limit Range	Test Result
50	120	5510.013959	5470~5725	Pass
40	120	5509.984729	5470~5725	Pass
30	120	5510.002454	5470~5725	Pass
20	120	5510.006051	5470~5725	Pass
10	120	5509.978877	5470~5725	Pass
0	120	5510.000168	5470~5725	Pass
-10	120	5509.984057	5470~5725	Pass
-20	120	5509.987724	5470~5725	Pass

Operating Frequency: 5510 MHz				
Environment Temperature (°C)	Voltage (V)	Measured Frequency (MHz)	Limit Range	Test Result
20	102	5509.979617	5470~5725	Pass
	120	5509.986712	5470~5725	Pass
	138	5509.973903	5470~5725	Pass



CH Mid

Operating Frequency: 5550 MHz				
Environment Temperature (°C)	Voltage (V)	Measured Frequency (MHz)	Limit Range	Test Result
50	120	5549.978433	5470~5725	Pass
40	120	5549.976326	5470~5725	Pass
30	120	5549.991231	5470~5725	Pass
20	120	5549.991485	5470~5725	Pass
10	120	5549.972870	5470~5725	Pass
0	120	5550.016239	5470~5725	Pass
-10	120	5549.977293	5470~5725	Pass
-20	120	5549.972741	5470~5725	Pass

Operating Frequency: 5550 MHz				
Environment Temperature (°C)	Voltage (V)	Measured Frequency (MHz)	Limit Range	Test Result
20	102	5549.972453	5470~5725	Pass
	120	5549.977937	5470~5725	Pass
	138	5549.987252	5470~5725	Pass



CH High

Operating Frequency: 5670 MHz				
Environment Temperature (°C)	Voltage (V)	Measured Frequency (MHz)	Limit Range	Test Result
50	120	5670.008282	5470~5725	Pass
40	120	5670.011574	5470~5725	Pass
30	120	5670.015518	5470~5725	Pass
20	120	5669.975314	5470~5725	Pass
10	120	5670.008258	5470~5725	Pass
0	120	5670.017008	5470~5725	Pass
-10	120	5669.998275	5470~5725	Pass
-20	120	5669.980420	5470~5725	Pass

Operating Frequency: 5670 MHz				
Environment Temperature (°C)	Voltage (V)	Measured Frequency (MHz)	Limit Range	Test Result
20	102	5669.988519	5470~5725	Pass
	120	5670.014612	5470~5725	Pass
	138	5670.020029	5470~5725	Pass



8.9 DYNAMIC FREQUENCY SELECTION

LIMIT

According to §15.407 (h) and FCC 06-96 appendix “compliance measurement procedures for unlicensed-national information infrastructure devices operating in the 5250-5350 MHz and 5470-5725 MHz bands incorporating dynamic frequency selection”.

Remark: IC RSS-210 §A9.5 is closely harmonized with FCC Part 15 DFS rules.

Table 1: Applicability of DFS requirements prior to use of a channel

Requirement	Operational Mode		
	Master	Client (without radar detection)	Client(with radar detection)
Non-Occupancy Period	Yes	Not required	Yes
DFS Detection Threshold	Yes	Not required	Yes
Channel Availability Check Time	Yes	Not required	Not required
Uniform Spreading	Yes	Not required	Not required

Table 2: Applicability of DFS requirements during normal operation

Requirement	Operational Mode		
	Master	Client (without radar detection)	Client(with radar detection)
DFS Detection Threshold	Yes	Not required	Yes
Channel Closing Transmission Time	Yes	Yes	Yes
Channel Move Time	Yes	Yes	Yes

Table 3: Interference Threshold values, Master or Client incorporating In-Service

Maximum Transmit Power	Value (see note)
≥200 Milliwatt	-64 dBm
< 200 Milliwatt	-62 dBm

Note 1: This is the level at the input of the receiver assuming a 0 dBi receive antenna.

Note 2: Throughout these test procedures an additional 1 dB has been added to the amplitude of the test transmission waveforms to account for variations in measurement equipment. This will ensure that the test signal is at or above the detection threshold level to trigger a DFS response.



Table 4: DFS Response requirement values

Parameter	Value
Non-occupancy period	30 minutes
Channel Availability Check Time	60 seconds
Channel Move Time	10 seconds
Channel Closing Transmission Time	200 milliseconds + approx. 60 milliseconds over remaining 10 second period

The instant that the Channel Move Time and the Channel Closing Transmission Time begins is as follows:

- For the Short pulse radar Test Signals this instant is the end of the Burst.
- For the Frequency Hopping radar Test Signal, this instant is the end of the last radar burst generated.
- For the Long Pulse radar Test Signal this instant is the end of the 12 second period defining the radar transmission.

The Channel Closing Transmission Time is comprised of 200 milliseconds starting at the beginning of the Channel Move Time plus any additional intermittent control signals required to facilitate channel changes (an aggregate of approximately 60 milliseconds) during the remainder of the 10 second period. The aggregate duration of control signals will not count quiet periods in between transmissions.

Table 5 – Short Pulse Radar Test Waveforms

Radar Type	Pulse Width (Microseconds)	PRI (Microseconds)	Pulses	Minimum Percentage of Successful Detection	Minimum Trials
1	1	1428	18	60%	30
2	1-5	150-230	23-29	60%	30
3	6-10	200-500	16-18	60%	30
4	11-20	200-500	12-16	60%	30
Aggregate (Radar Types 1-4)				80%	120

Table 6 – Long Pulse Radar Test Signal

Radar Waveform	Bursts	Pulses per Burst	Pulse Width (µsec)	Chirp Width (µsec)	PRI (µsec)	Minimum Percentage of Successful Detection	Minimum Trials
5	8-20	1-3	50-100	5-20	1000-2000	80%	30

Table 7 – Frequency Hopping Radar Test Signal

Radar Waveform	Pulse Width (µsec)	PRI (µsec)	Burst Length (ms)	Pulses Per Hop	Hopping Rate (kHz)	Minimum Percentage of Successful Detection	Minimum Trials
6	1	333	300	9	0.33	70%	30



DESCRIPTION OF EUT

Overview Of EUT With Respect To §15.407 (H) Requirements

The firmware installed in the EUT during testing was:

Firmware Rev: 20.20.2960.18

The EUT operates over the 5250-5350 MHz range as a Client Device that does not have radar detection capability.

The antenna assembly utilized with the EUT has a gain of 0.8 dBi.

The EUT uses one transmitter connected to two 50-ohm coaxial antenna ports via a diversity switch. Only one antenna port is connected to the test system since the EUT has one antenna only.

The Slave device associated with the EUT during these tests does not have radar detection capability.

WLAN traffic is generated by streaming the video file TestFile.mp2 “6 ½ Magic Hours” from the Master to the Slave in full motion video mode using the media player with the V2.61 Codec package.

TPC is not required since the maximum EIRP is less than 500 mW (27 dBm).

The EUT utilizes the 802.11a architecture, with a nominal channel bandwidth of 20 MHz.

The Master Device is a Cisco Aironet 802.11a/b/g Access Point, FCC ID: LDK102056.

The rated output power of the Master unit is < 23dBm (EIRP). Therefore the required interference threshold level is -62 dBm. After correction for antenna gain and procedural adjustments, the required conducted threshold at the antenna port is $-62 + 5 = -57$ dBm.

The calibrated conducted DFS Detection Threshold level is set to -62 dBm. The tested level is lower than the required level hence it provides margin to the limit.

Manufacturer’s Statement Regarding Uniform Channel Spreading

The end product implements an automatic channel selection feature at startup such that operation commences on channels distributed across the entire set of allowed 5GHz channels. This feature will ensure uniform spreading is achieved while avoiding non-allowed channels due to prior radar events.



TEST AND MEASUREMENT SYSTEM

System Overview

The measurement system is based on a conducted test method.

The short pulse and long pulse signal generating system utilizes the NTIA software. The Vector Signal Generator has been validated by the NTIA. The hopping signal generating system utilizes the CCS simulated hopping method and system, which has been validated by the DoD, FCC and NTIA. The software selects waveform parameters from within the bounds of the signal type on a random basis using uniform distribution.

The short pulse types 2, 3 and 4, and the long pulse type 5 parameters are randomized at run-time.

The hopping type 6 pulse parameters are fixed while the hopping sequence is based on the August 2005 NTIA Hopping Frequency List. The initial starting point randomized at run-time and each subsequent starting point is incremented by 475. Each frequency in the 100-length segment is compared to the boundaries of the EUT Detection Bandwidth and the software creates a hopping burst pattern in accordance with Section 7.4.1.3 Method #2 Simulated Frequency Hopping Radar Waveform Generating Subsystem of FCC 06-96 APPENDIX. The frequency of the signal generator is incremented in 1 MHz steps from FL to FH for each successive trial. This incremental sequence is repeated as required to generate a minimum of 30 total trials and to maintain a uniform frequency distribution over the entire Detection Bandwidth.

The signal monitoring equipment consists of a spectrum analyzer set to display 8001 bins on the horizontal axis. The time-domain resolution is 2 msec / bin with a 16 second sweep time, meeting the 10 second short pulse reporting criteria. The aggregate ON time is calculated by multiplying the number of bins above a threshold during a particular observation period by the dwell time per bin, with the analyzer set to peak detection and max hold. The time-domain resolution is 3 msec / bin with a 24 second sweep time, meeting the 22 second long pulse reporting criteria and allowing a minimum of 10 seconds after the end of the long pulse waveform.

Should multiple RF ports be utilized for the Master and/or Slave devices (for example, for diversity or MIMO implementations), 50 ohm termination would be removed from the splitter so that connection can be established between splitter and the Master and/or Slave devices.

Conducted Method System Block Diagram

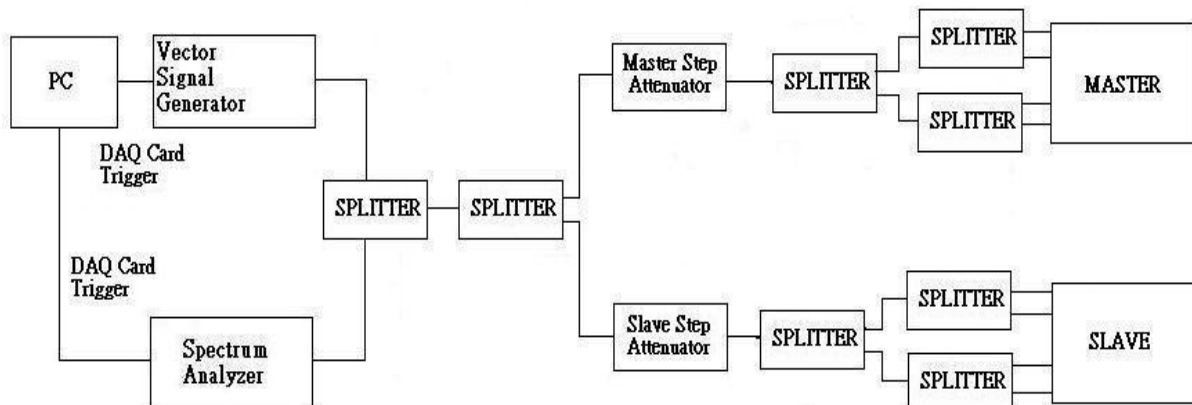



System Calibration

Connect the spectrum analyzer to the test system in place of the master device. Set the signal generator to CW mode. Adjust the amplitude of the signal generator to yield a measured level of -62 dBm on the spectrum analyzer.

Without changing any of the instrument settings, reconnect the spectrum analyzer to the Common port of the Spectrum Analyzer Combiner/Divider and connect a 50 ohm load to the Master Device port of the test system.

Measure the amplitude and calculate the difference from -62 dBm. Adjust the Reference Level Offset of the spectrum analyzer to this difference. Confirm that the signal is displayed at -62 dBm. Readjust the RBW and VBW to 3 MHz, set the span to 10 MHz, and confirm that the signal is still displayed at -62 dBm.

The spectrum analyzer displays the level of the signal generator as received at the antenna ports of the Master Device. The interference detection threshold may be varied from the calibrated value of -62 dBm and the spectrum analyzer will still indicate the level as received by the Master Device.

Set the signal generator to produce a radar waveform, trigger a burst manually and measure the level on the spectrum analyzer. Readjust the amplitude of the signal generator as required so that the peak level of the waveform is at a displayed level equal to the required or desired interference detection threshold. Separate signal generator amplitude settings are determined as required for each radar type.

Adjustment Of Displayed Traffic Level

Establish a link between the Master and Slave, adjusting the Link Step Attenuator as needed to provide a suitable received level at the Master and Slave devices. Stream the video test file to generate WLAN traffic. Confirm that the WLAN traffic level, as displayed on the spectrum analyzer, is at lower amplitude than the radar detection threshold. Confirm that the displayed traffic is from the Master Device. For Master Device testing confirm that the displayed traffic does not include Slave Device traffic. For Slave Device testing confirm that the displayed traffic does not include Master Device traffic.

If a different setting of the Master Step Attenuator is required to meet the above conditions, perform a new System Calibration for the new Master Step Attenuator setting.



Test Setup

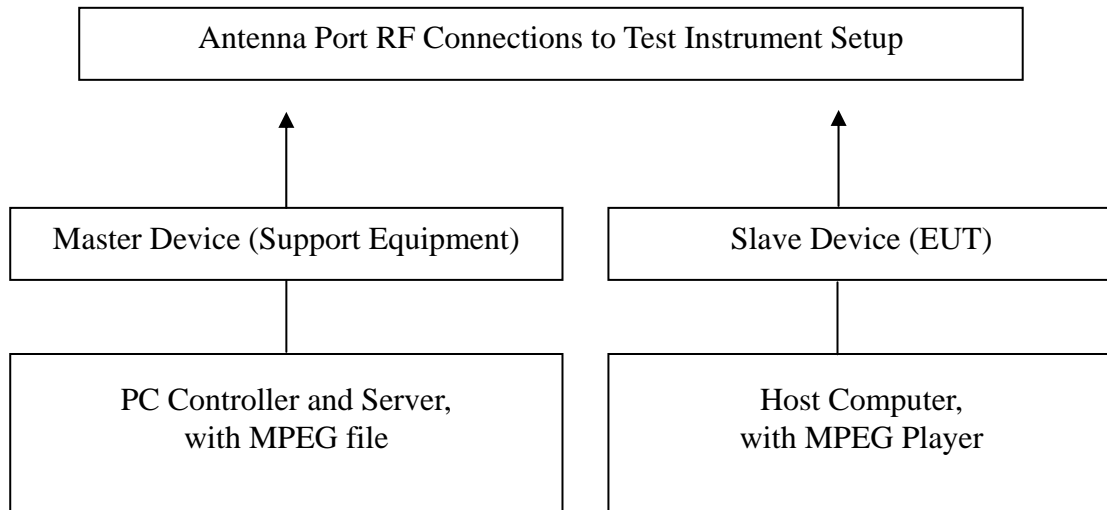

TEST RESULTS

No non-compliance noted



Test Plot

PLOTS OF RADAR WAVEFORMS

Sample of Short Pulse Radar Type 1

Agilent

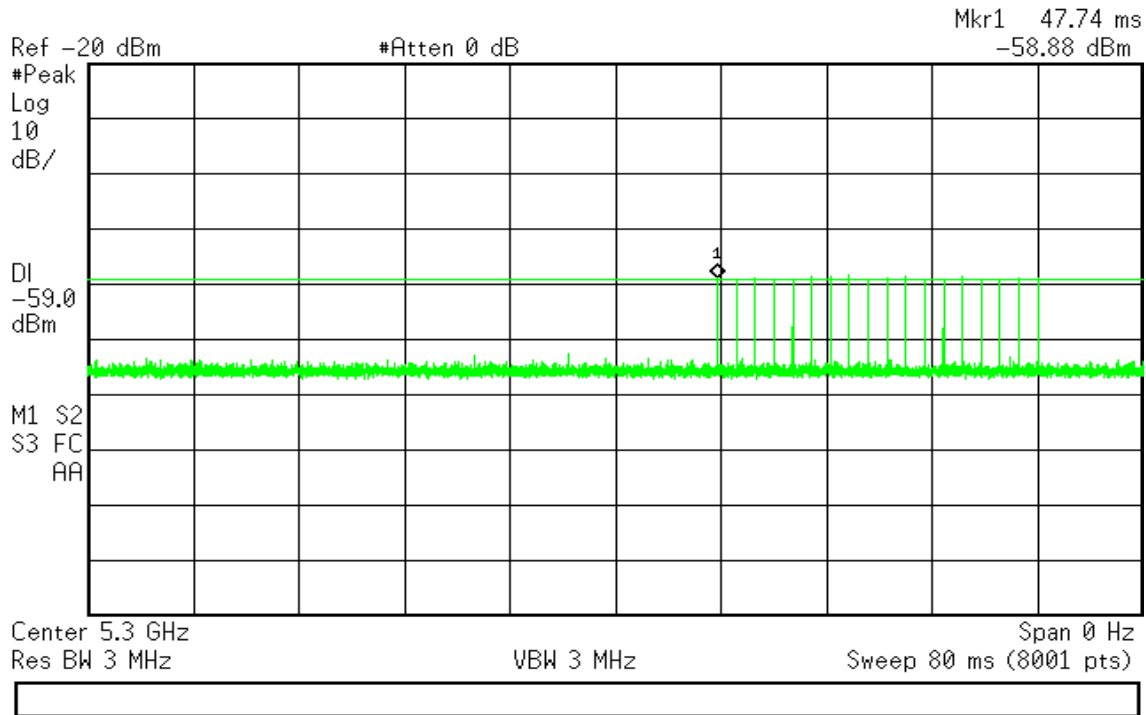

Sample of Short Pulse Radar Type 2

Agilent

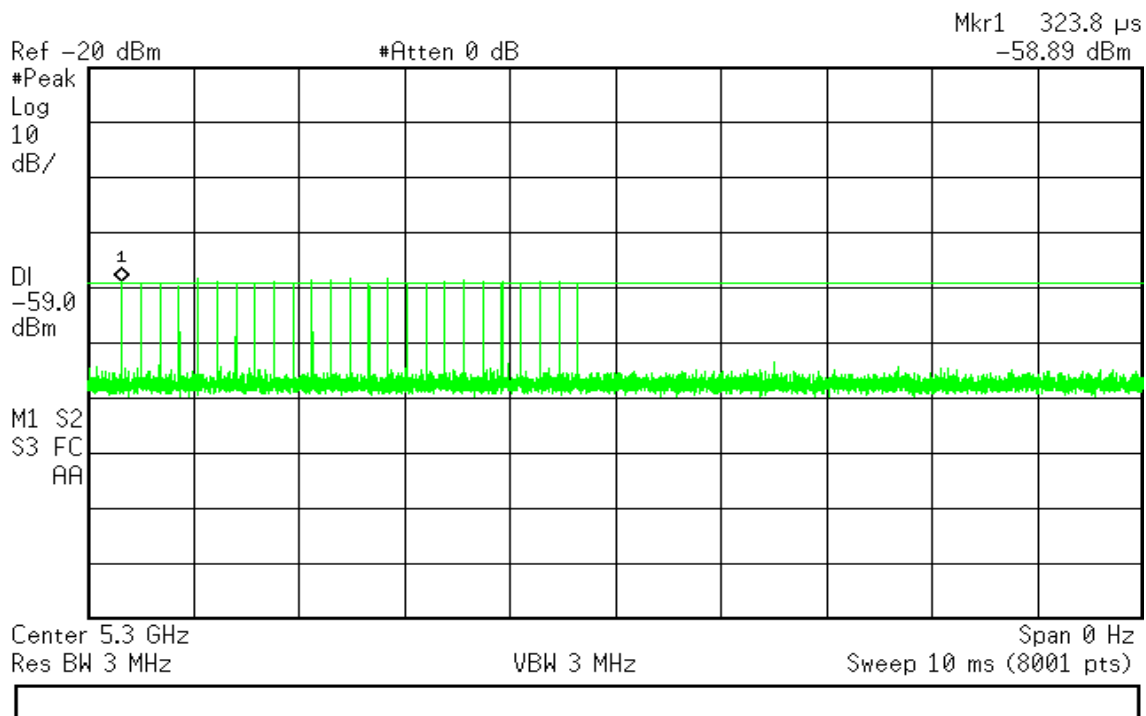



Sample of Short Pulse Radar Type 3

Agilent

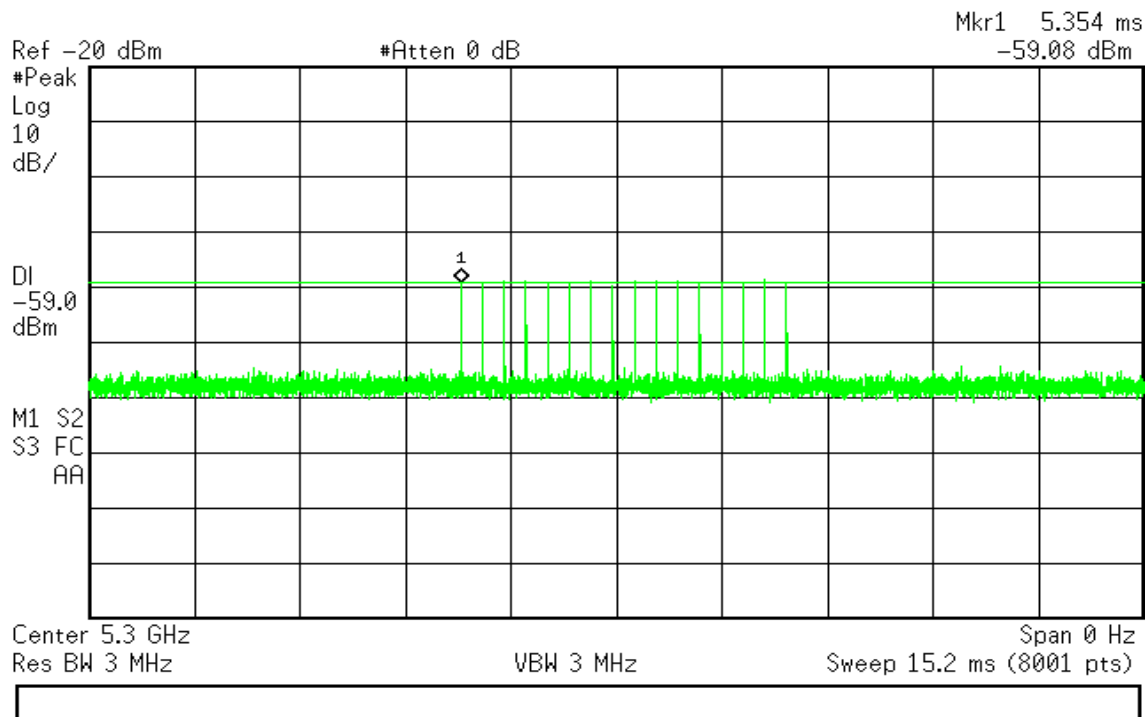

Sample of Short Pulse Radar Type 4

Agilent

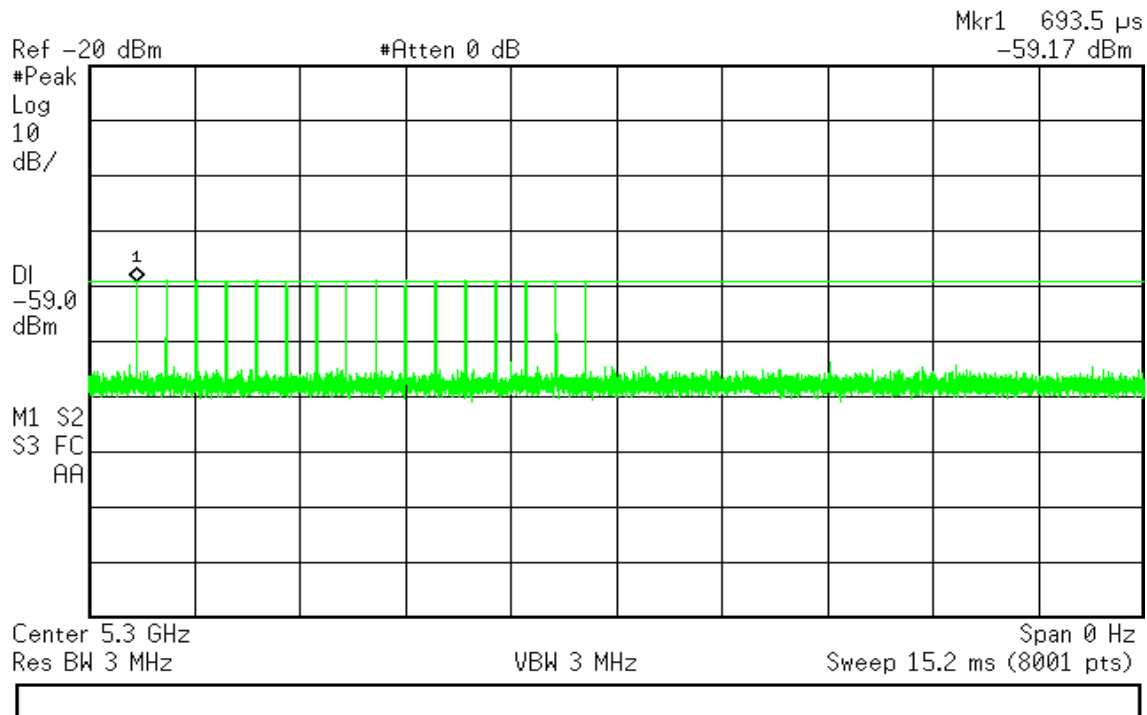



Sample of Long Pulse Radar Type 5

Agilent

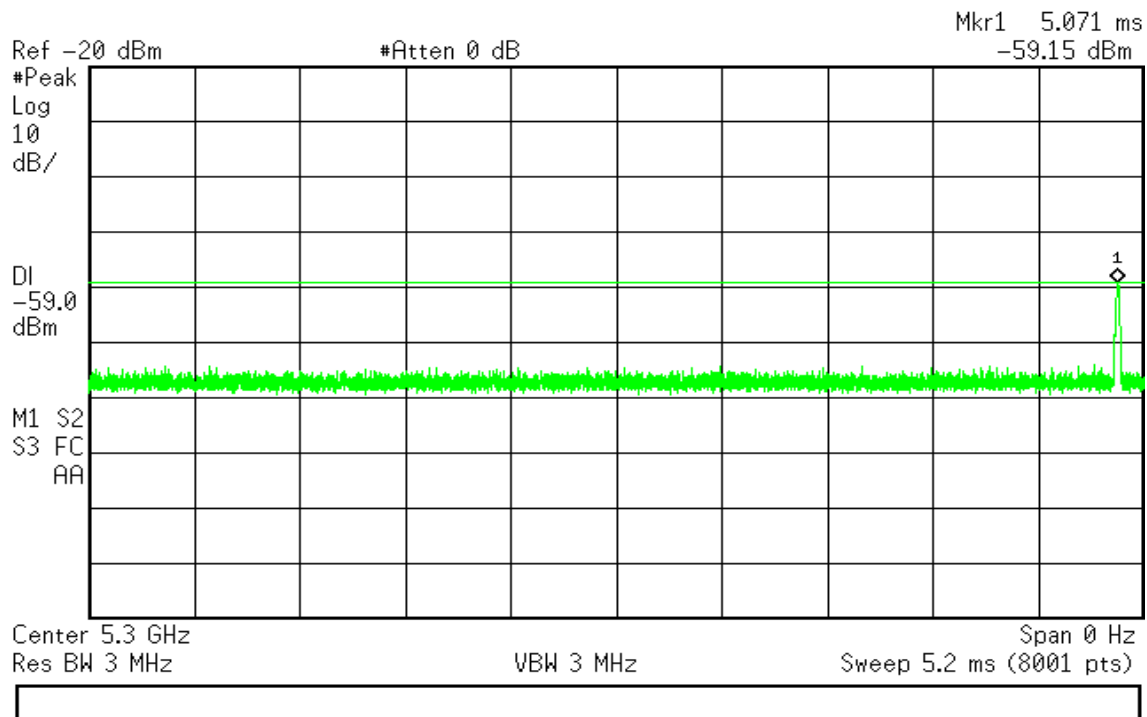

Sample of Frequency Hopping Radar Type 6

Agilent

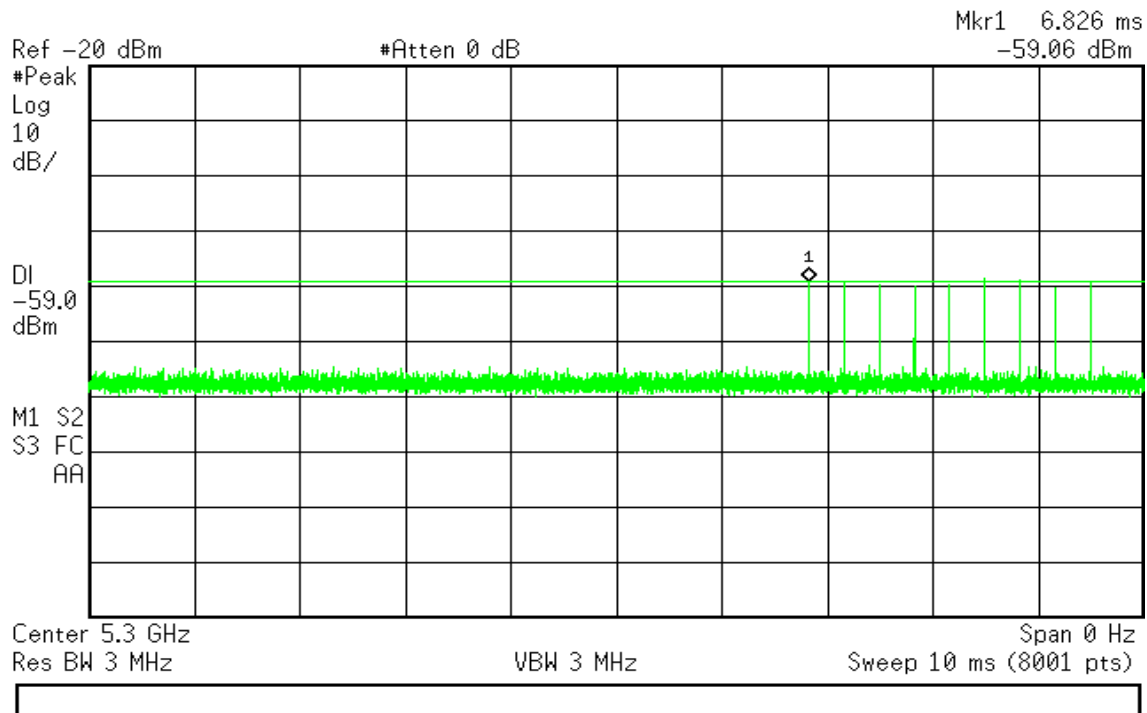



Plot of WLAN Traffic from Slave

IEEE 802.11n HT 20 MHz mode

Agilent 21:40:17

T

Mkr1 712.5 ms
-45.52 dBm

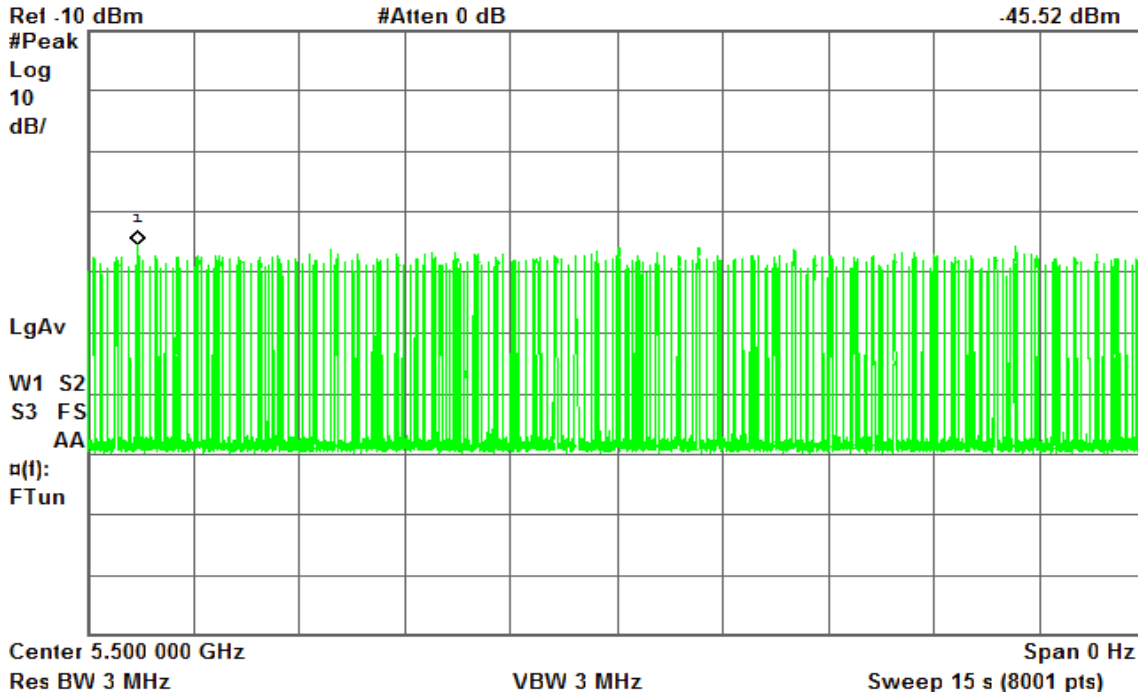

IEEE 802.11n HT 40 MHz mode

Agilent 20:56:52

T

Mkr1 5.168 s
-52.19 dBm

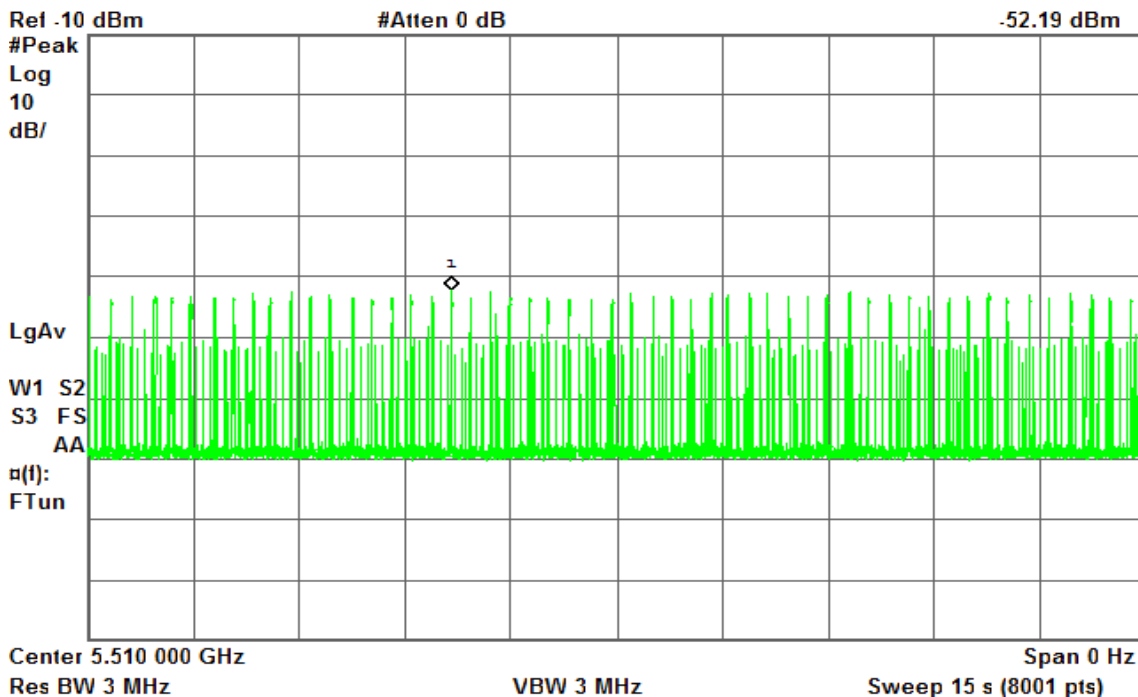



TEST CHANNEL AND METHOD

All tests were performed at a channel center frequency of 5300 MHz utilizing a conducted test method.

CHANNEL MOVE TIME AND CHANNEL CLOSING TRANSMISSION TIME

GENERAL REPORTING NOTES

The reference marker is set at the end of last radar pulse.

The delta marker is set at the end of the last WLAN transmission following the radar pulse. This delta is the channel move time.

The aggregate channel closing transmission time is calculated as follows:

Aggregate Transmission Time =

(Number of analyzer bins showing transmission) * (dwell time per bin)

The observation period over which the aggregate time is calculated

Begins at (Reference Marker + 200 msec) and

Ends no earlier than (Reference Marker + 10 sec).



LOW BAND RESULTS

Bandwidth 20 MHz Mode

Type 1 Channel Move Time Results

No non-compliance noted.

Channel Move Time (s)	Limit (s)
0.7694	10

Agilent 22:17:46 Jul 30, 2014

R T

Δ Mkr2 769.4 ms
-13.07 dB

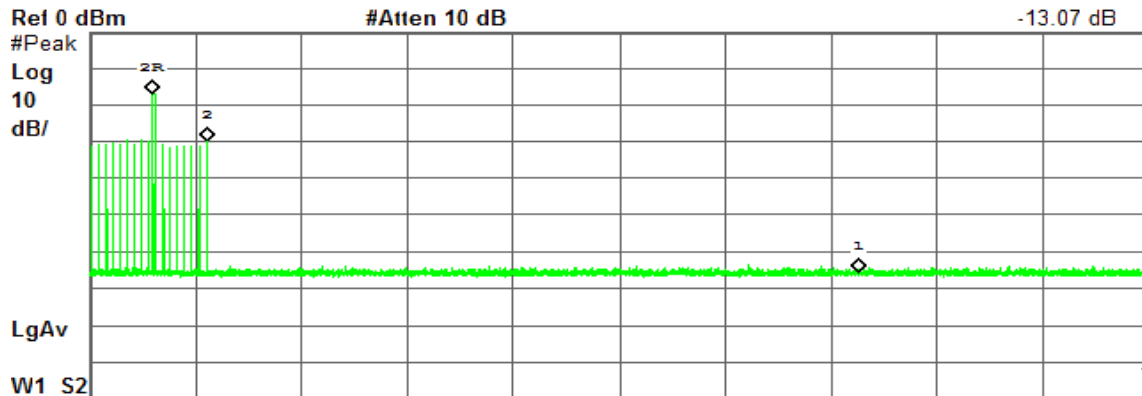

Center 5.300 000 GHz Span 0 Hz
 Res BW 3 MHz VBW 3 MHz Sweep 15 s (8001 pts)

Marker	Trace	Type	X Axis	Amplitude
1R	(1)	Time	885 ms	-16.87 dBm
1Δ	(1)	Time	10 s	-48.84 dB
2R	(1)	Time	885 ms	-16.87 dBm
2Δ	(1)	Time	769.4 ms	-13.07 dB



Type 5 Channel Move Time Results

No non-compliance noted.

Channel Move Time (s)	Limit (s)
0	10

Agilent 14:01:56 Aug 1, 2014

T

Δ Mkr2 0 s
0.00 dB

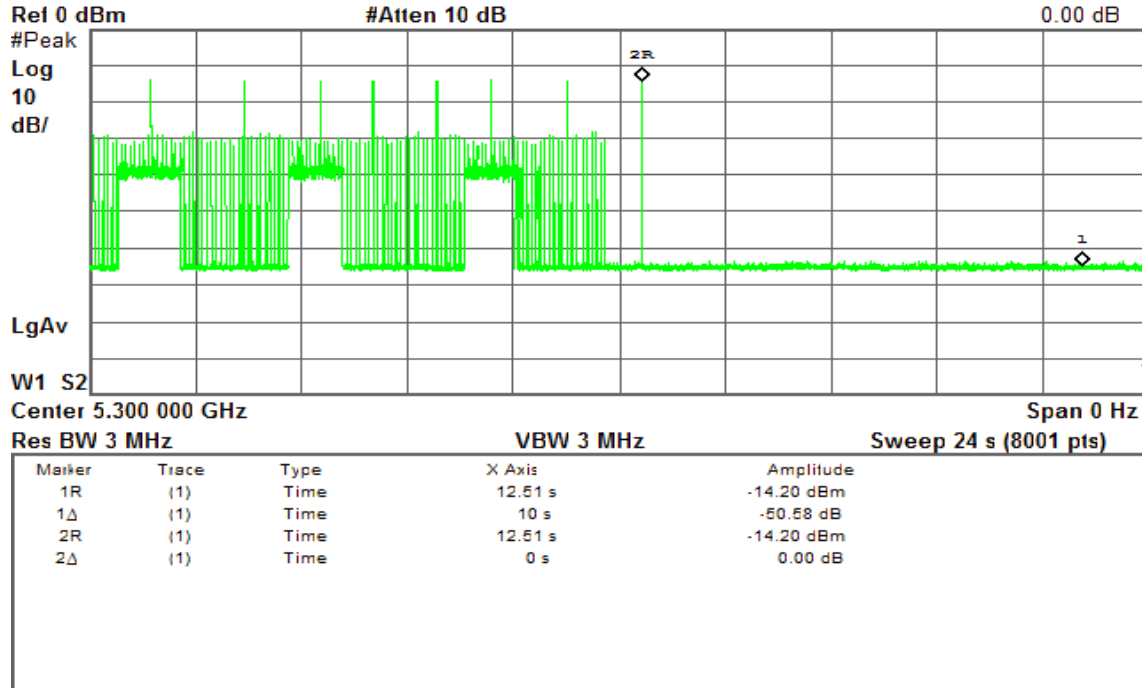



Bandwidth 20 MHz Mode

Type 1 Channel Closing Transmission Time Results

No non-compliance noted.

For R1

Aggregate Transmission Time (ms)	Limit (ms)	Margin (ms)
13.12	60	-46.88

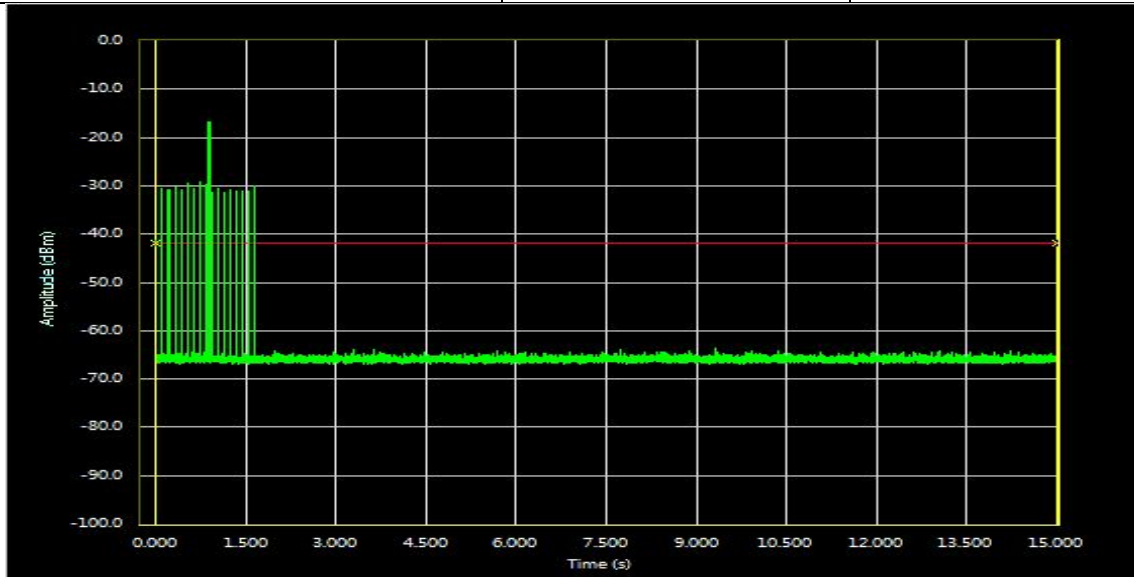

Threshold: -41.92

T1: 0.000 -41.92

T2: 15.000 -41.92

Time Per Bin (ms): 1.87

Bins Above: 33

Aggregate Time Above Threshold Between T1 and T2 (ms): 61.87

Print Screen

Exit

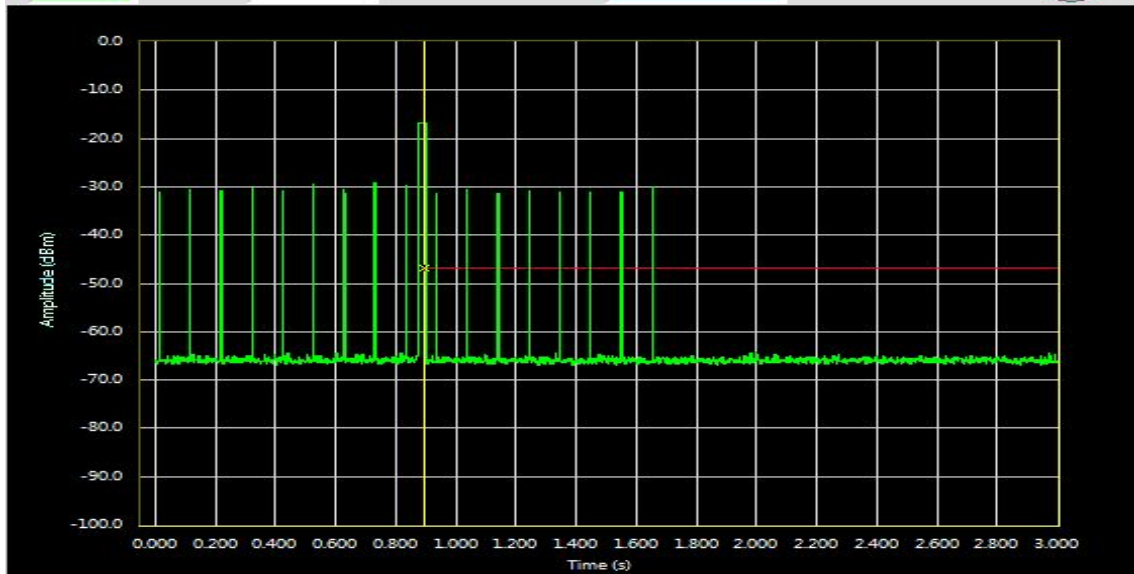

Threshold: -46.92

T1: 0.894 -46.92

T2: 15.000 -46.92

Time Per Bin (ms): 1.87

Bins Above: 11

Aggregate Time Above Threshold Between T1 and T2 (ms): 20.62

Print Screen

Exit

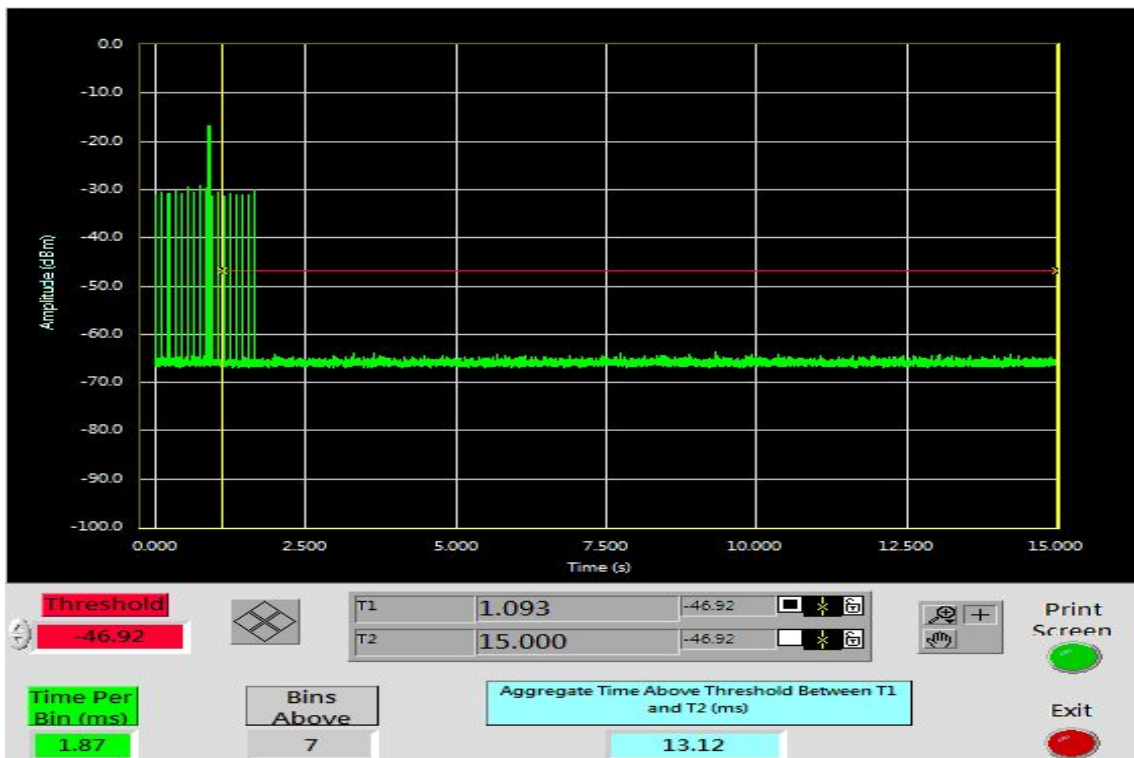
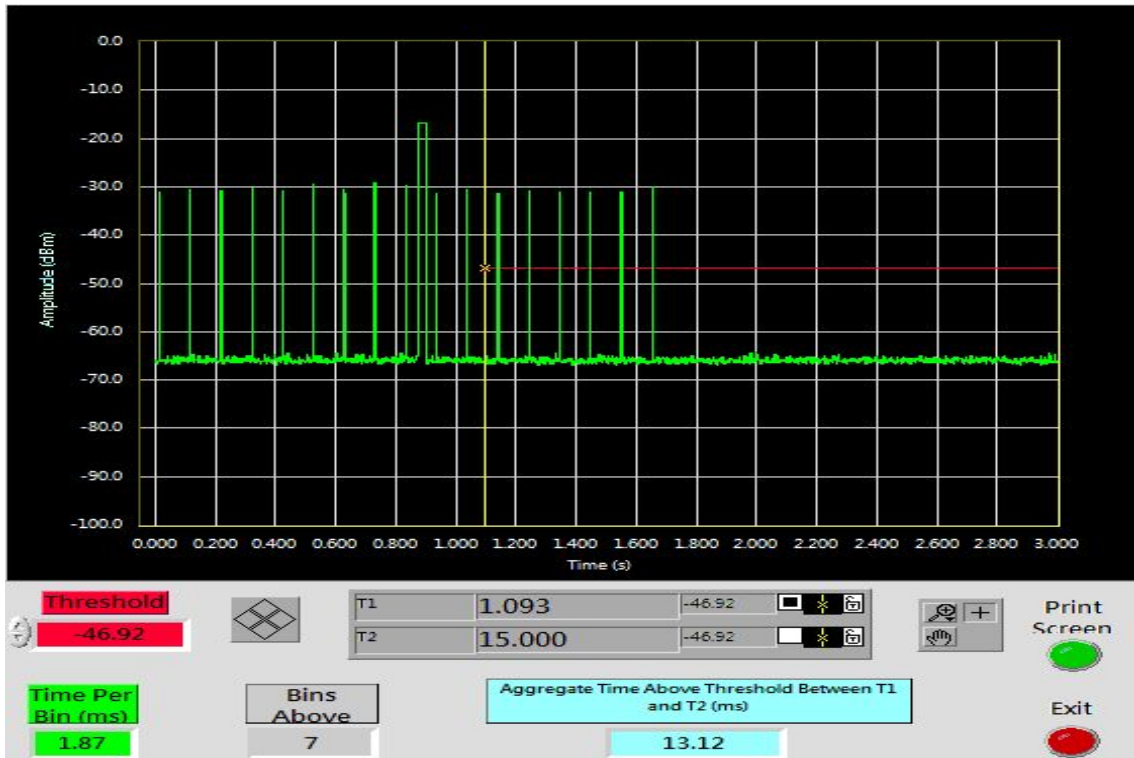



For R5

Aggregate Transmission Time (ms)	Limit (ms)	Margin (ms)
0	60	-60

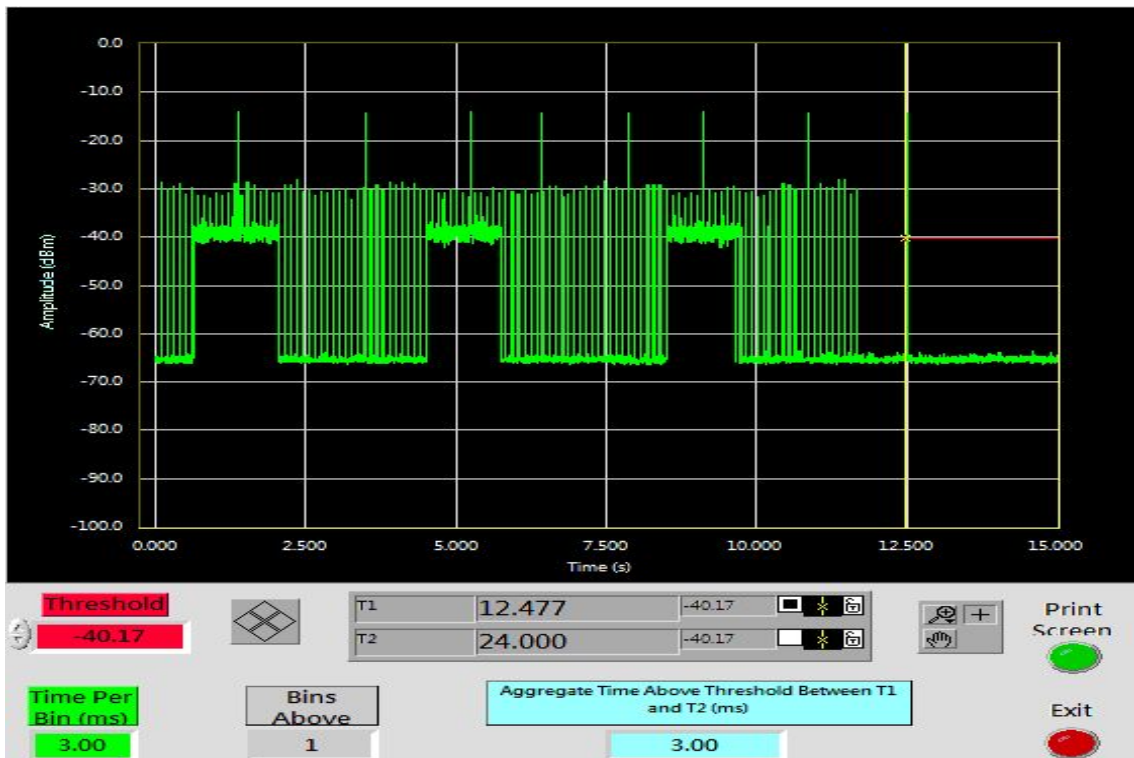
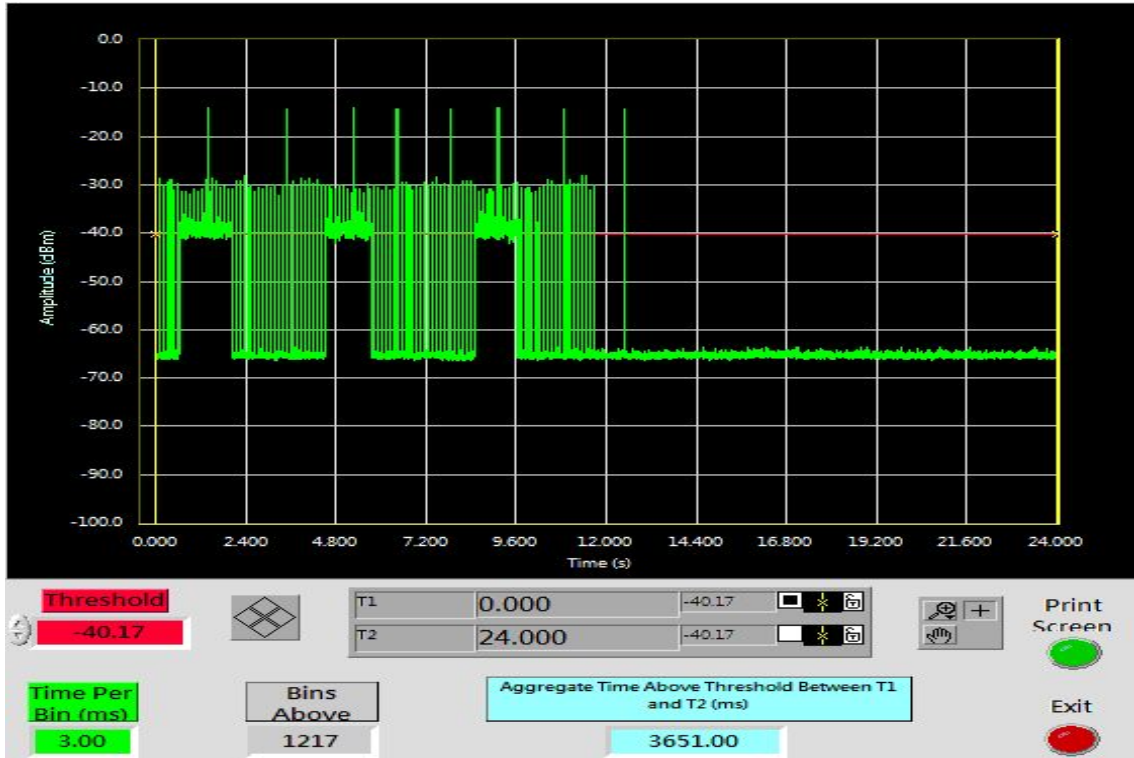

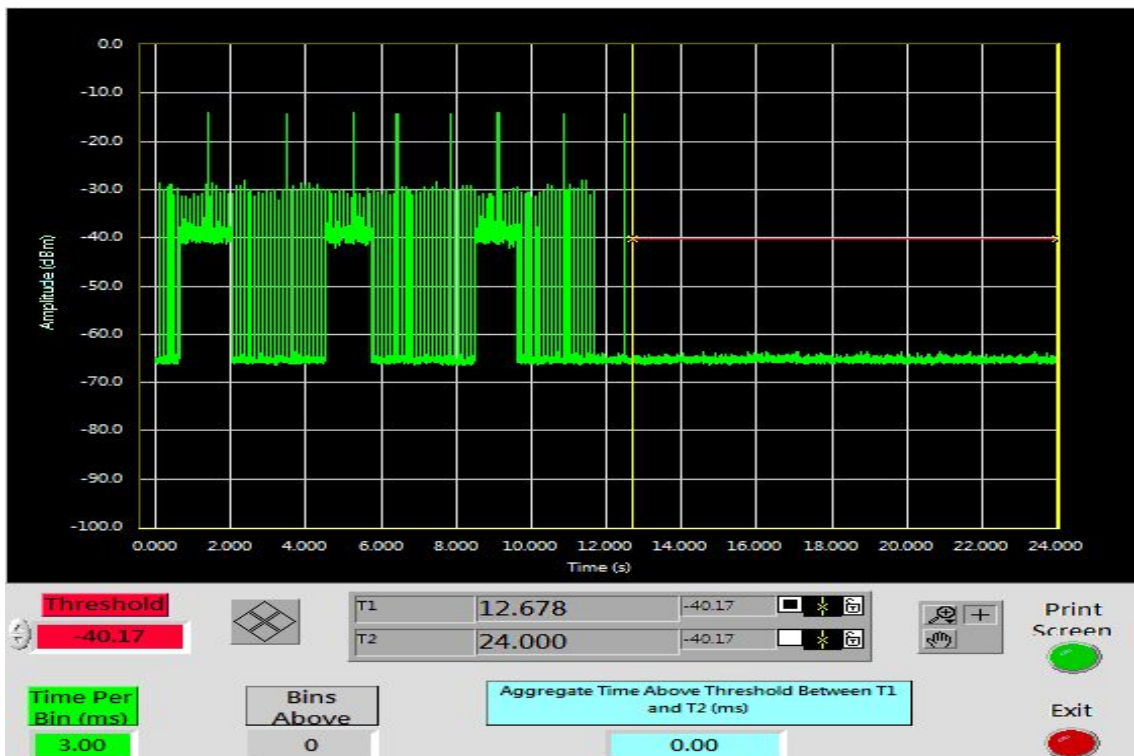
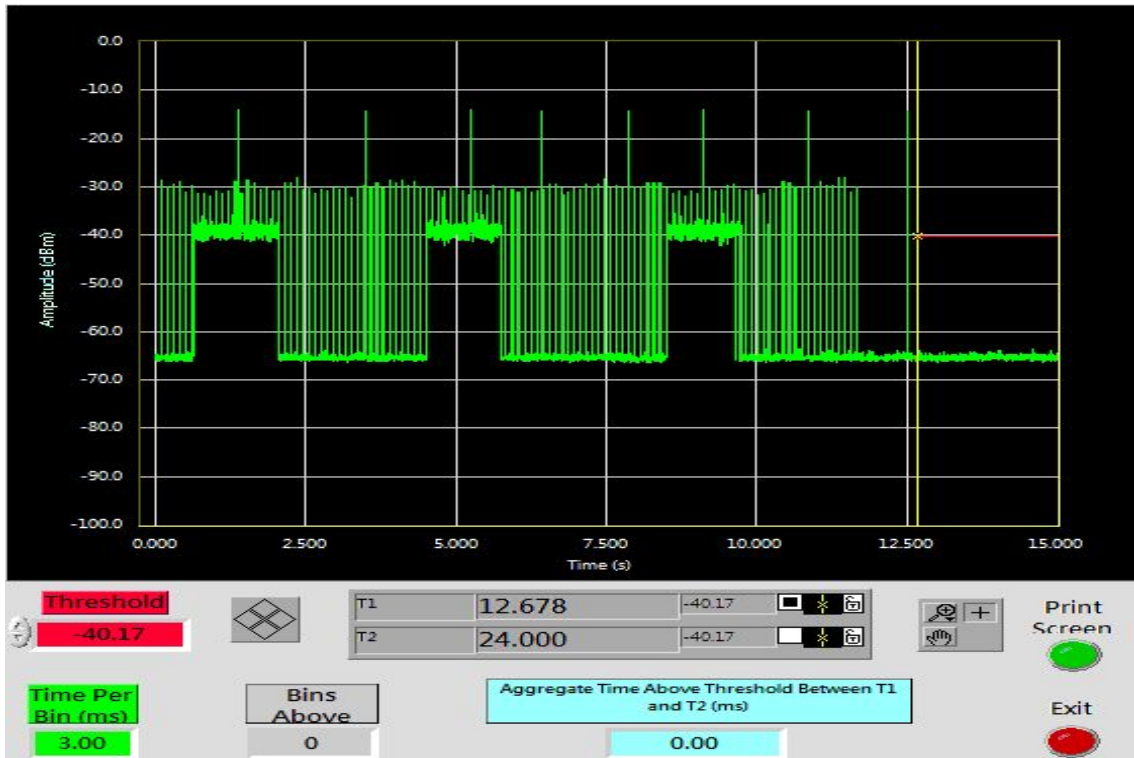



Bandwidth 40 MHz Mode

Type 1 Channel Move Time Results

No non-compliance noted.

Channel Move Time (s)	Limit (s)
0.7581	10

Agilent 23:52:29 Jul 30, 2014

R T

Δ Mkr2 758.1 ms
-31.93 dB

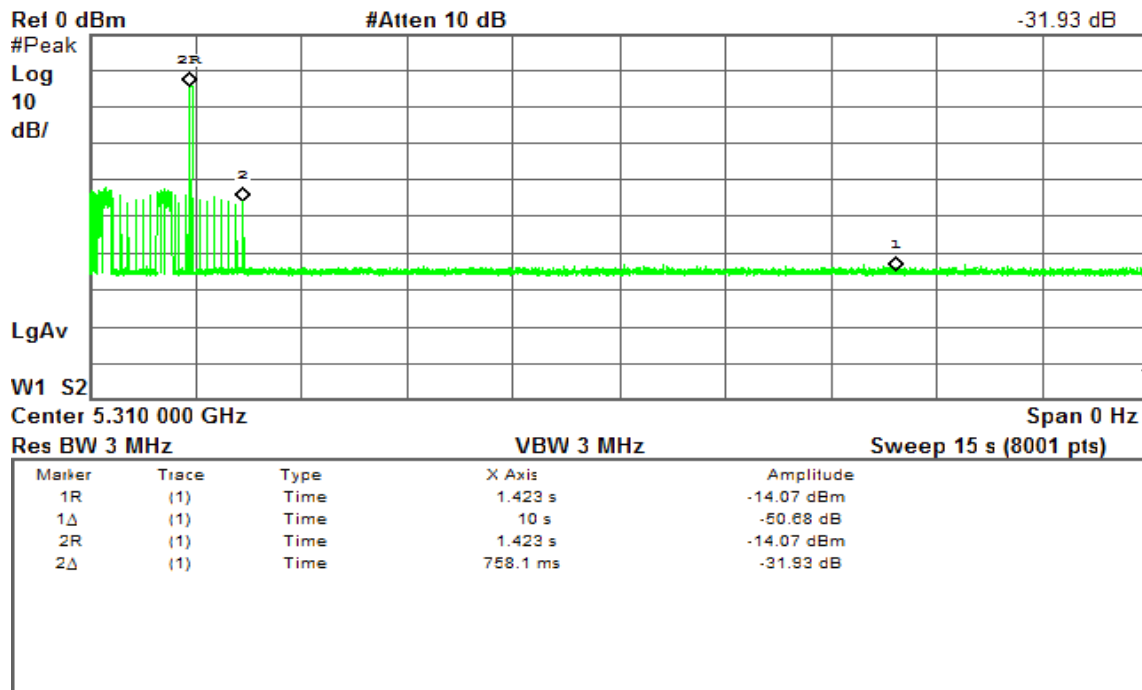



Type 5 Channel Move Time Results

No non-compliance noted.

Channel Move Time (s)	Limit (s)
0	10

Agilent 13:35:09 Aug 1, 2014

T

Δ Mkr2 0 s
0.00 dB

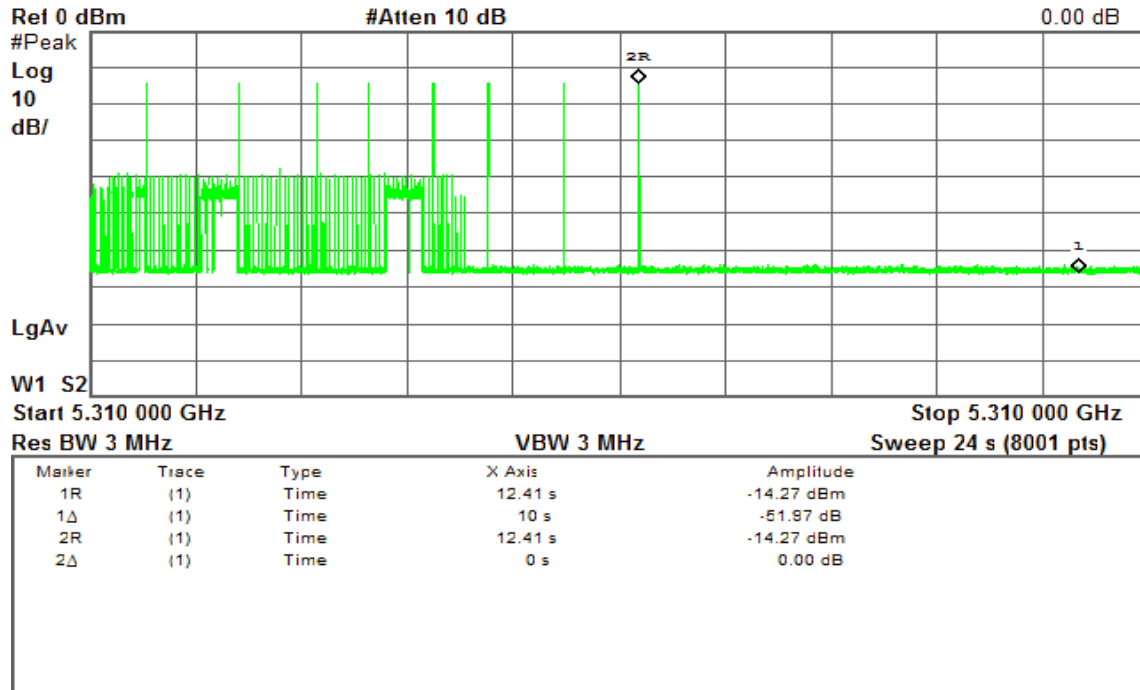



Bandwidth 40 MHz Mode

Type 1 Channel Closing Transmission Time Results

No non-compliance noted.

For R1

Aggregate Transmission Time (ms)	Limit (ms)	Margin (ms)
0	60	-60

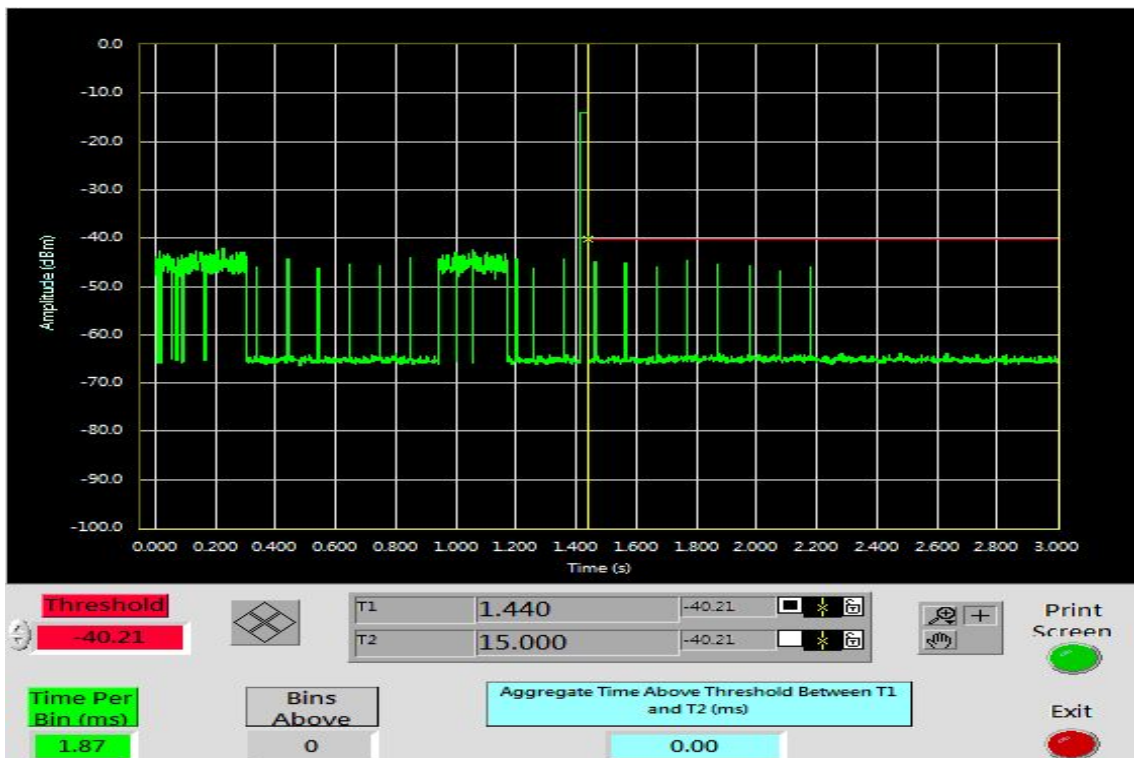
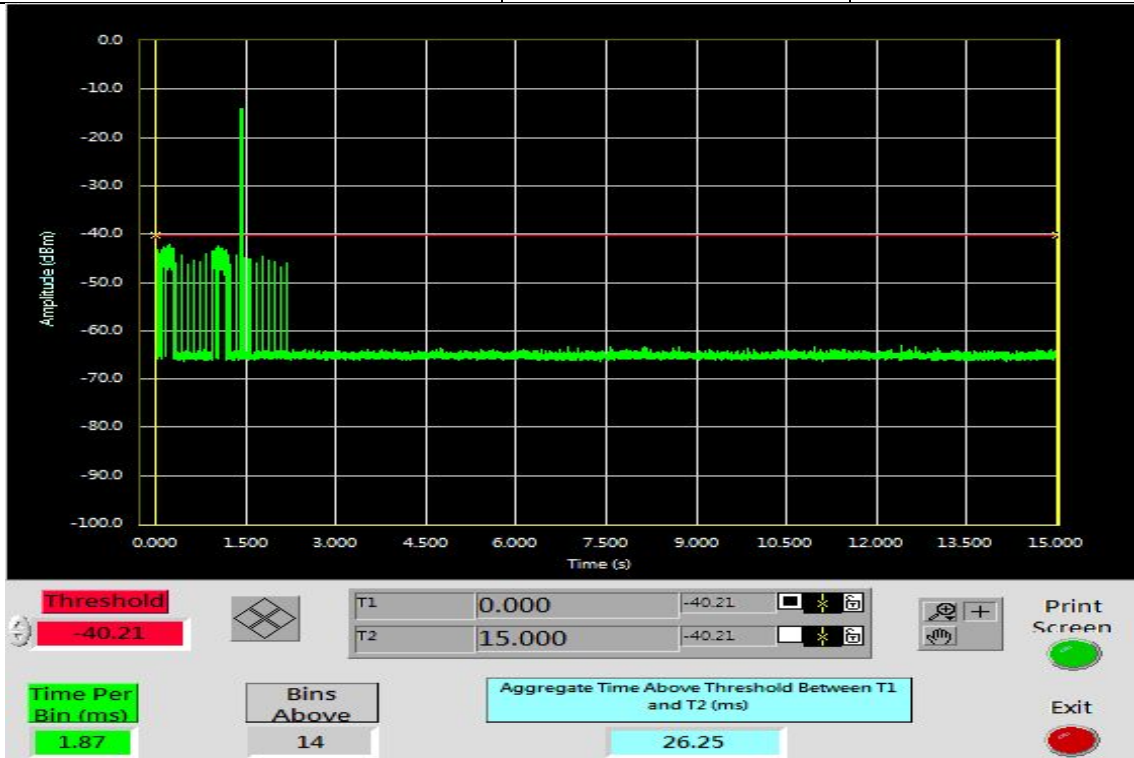

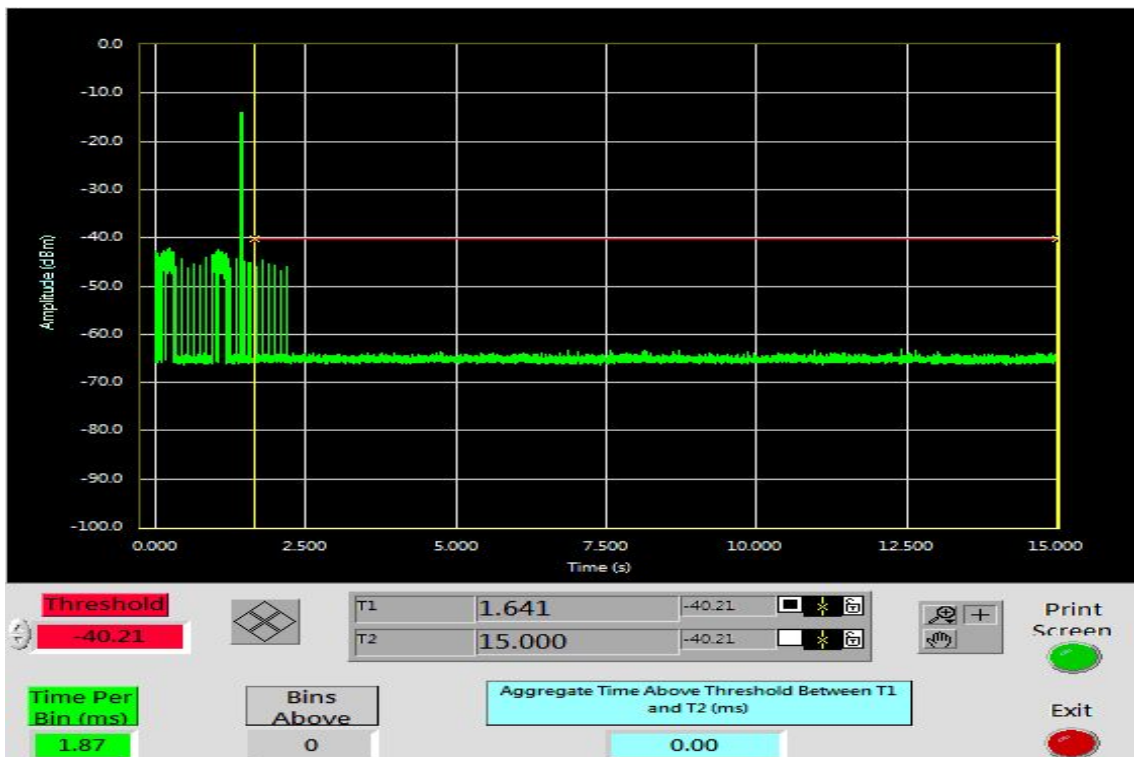
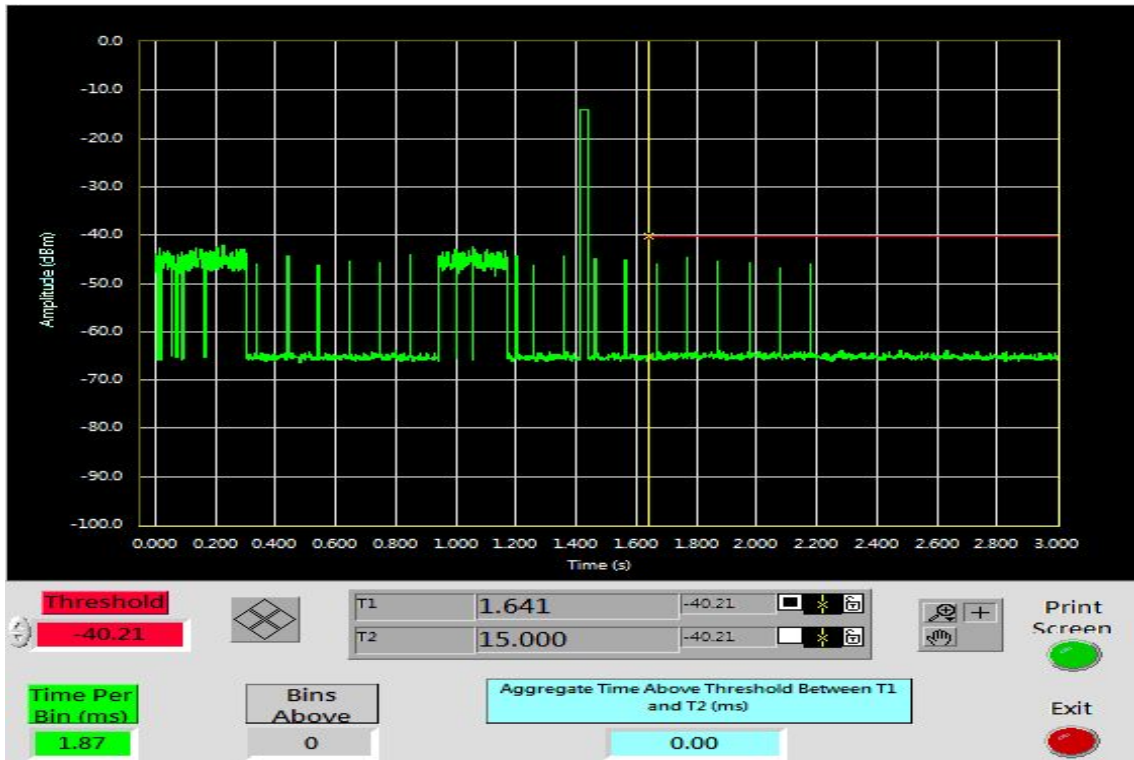



For R5

Aggregate Transmission Time (ms)	Limit (ms)	Margin (ms)
0	60	-60

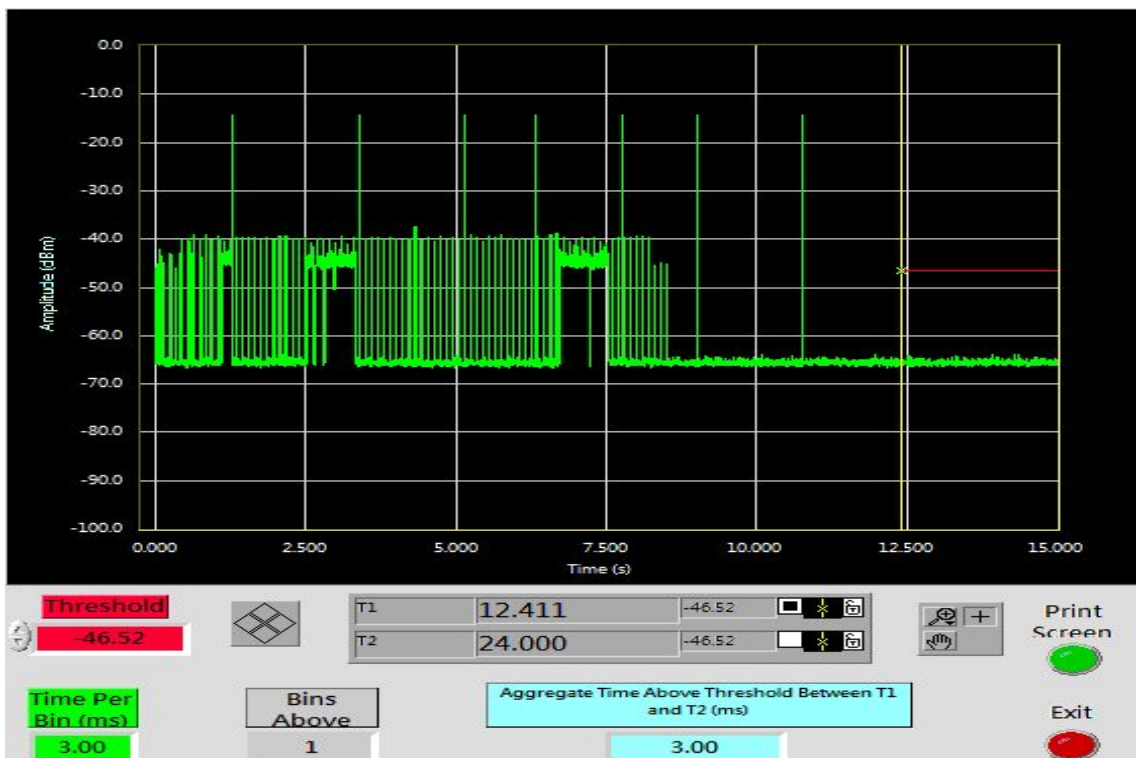
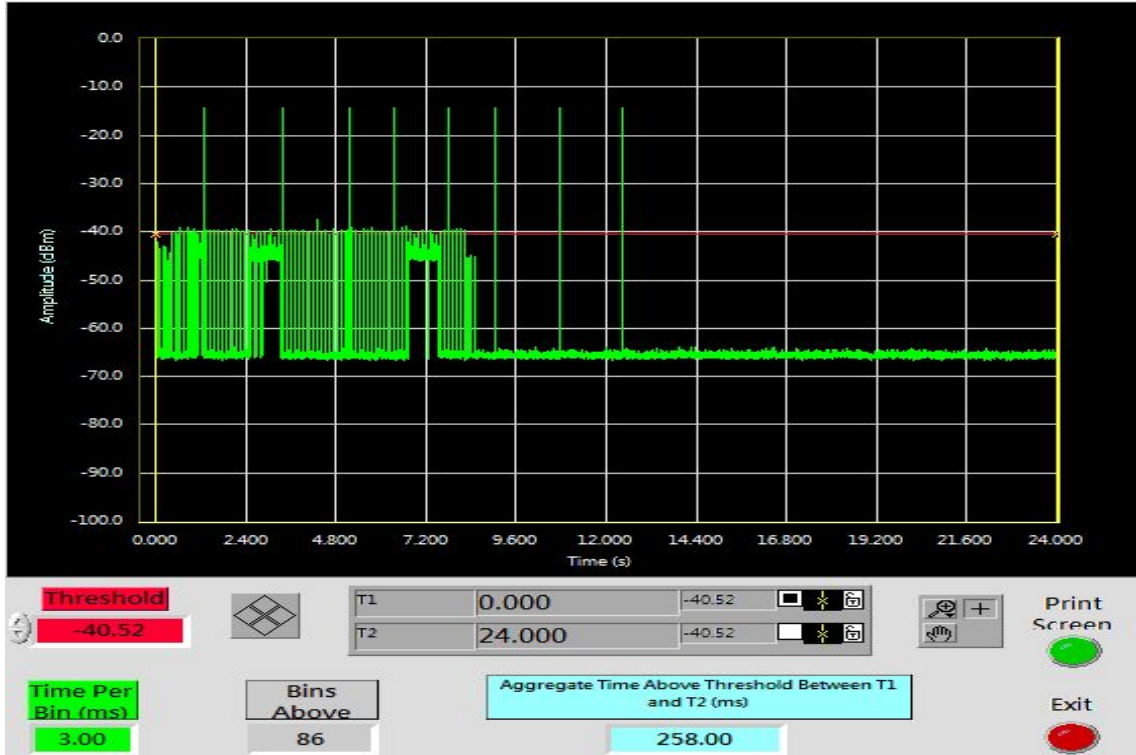

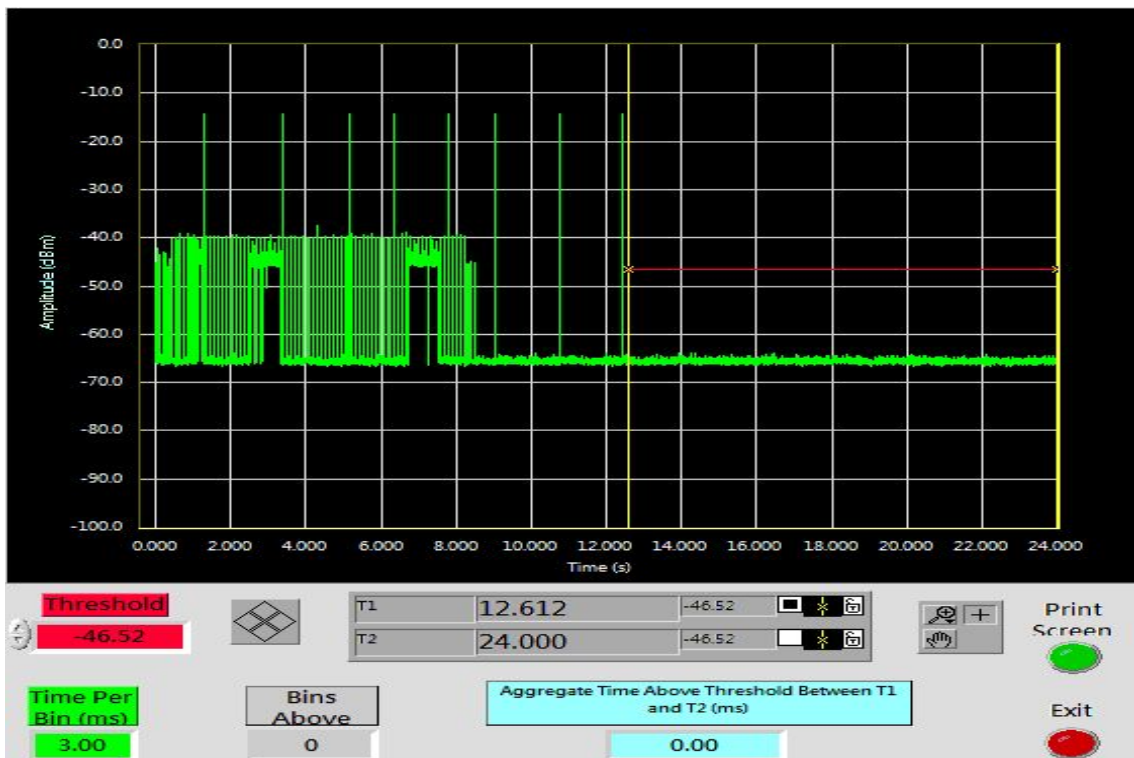
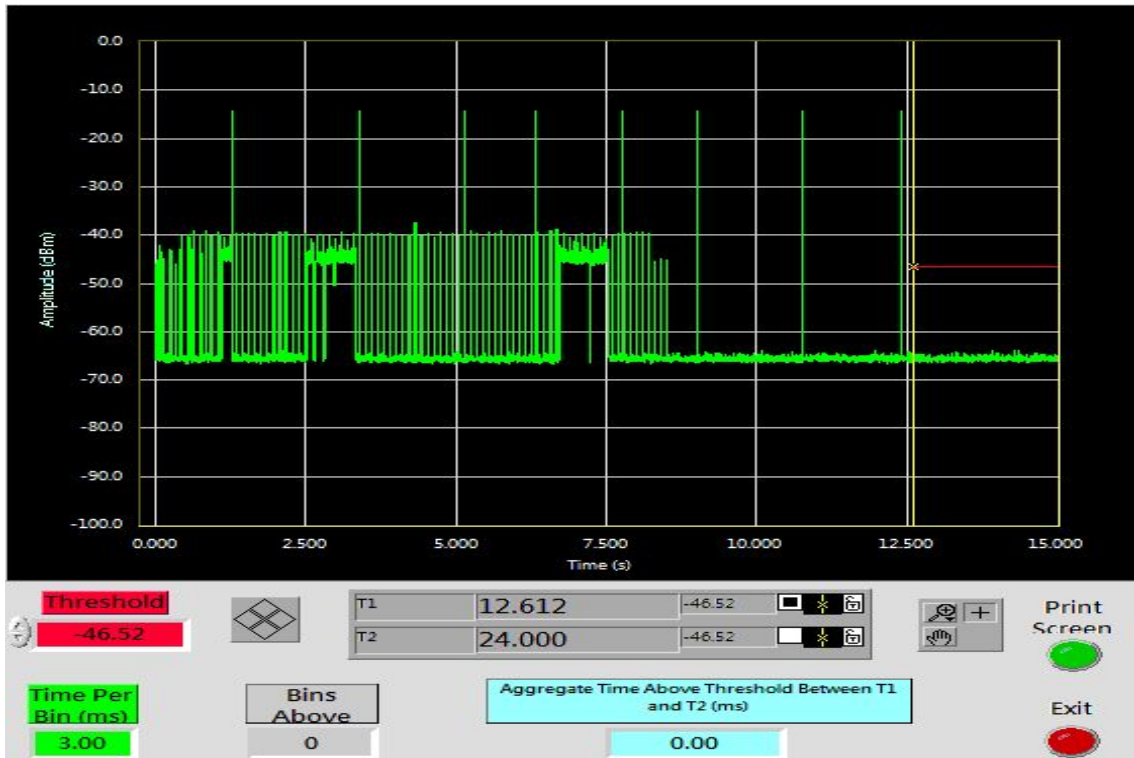



HIGH BAND RESULTS

Bandwidth 20 MHz Mode

Type 1 Channel Move Time Results

No non-compliance noted.

Channel Move Time (s)	Limit (s)
0.775	10

Agilent 23:30:59 Jul 30, 2014

R T

Δ Mkr2 775 ms
-18.44 dB

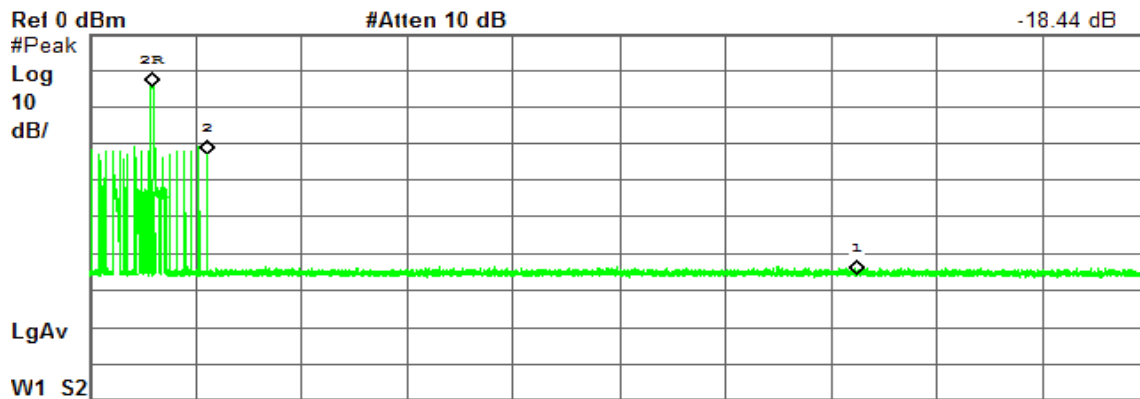

Center 5.500 000 GHz Span 0 Hz
 Res BW 3 MHz VBW 3 MHz Sweep 15 s (8001 pts)

Marker	Trace	Type	X Axis	Amplitude
1R	(1)	Time	877.5 ms	-14.42 dBm
1Δ	(1)	Time	10 s	-51.49 dB
2R	(1)	Time	877.5 ms	-14.42 dBm
2Δ	(1)	Time	775 ms	-18.44 dB



Type 5 Channel Move Time Results

No non-compliance noted.

Channel Move Time (s)	Limit (s)
0	10

Agilent 14:23:19 Aug 1, 2014

T

Δ Mkr2 0 s
0.00 dB

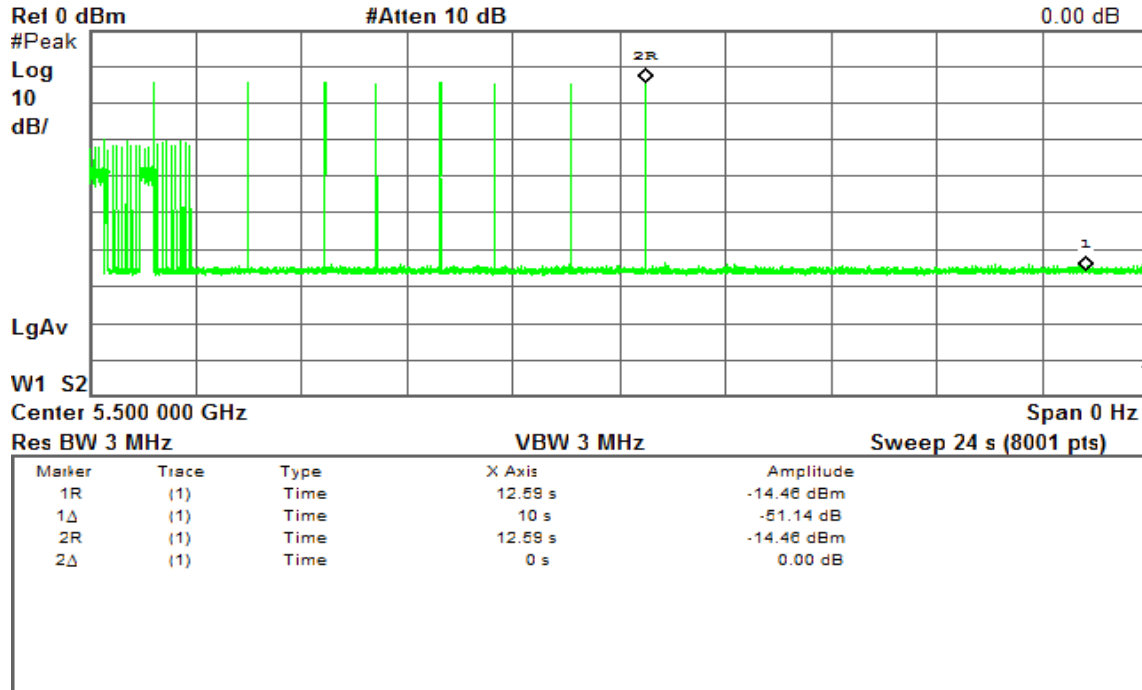



Bandwidth 20 MHz Mode

Type 1 Channel Closing Transmission Time Results

No non-compliance noted.

For R1

Aggregate Transmission Time (ms)	Limit (ms)	Margin (ms)
15	60	-45

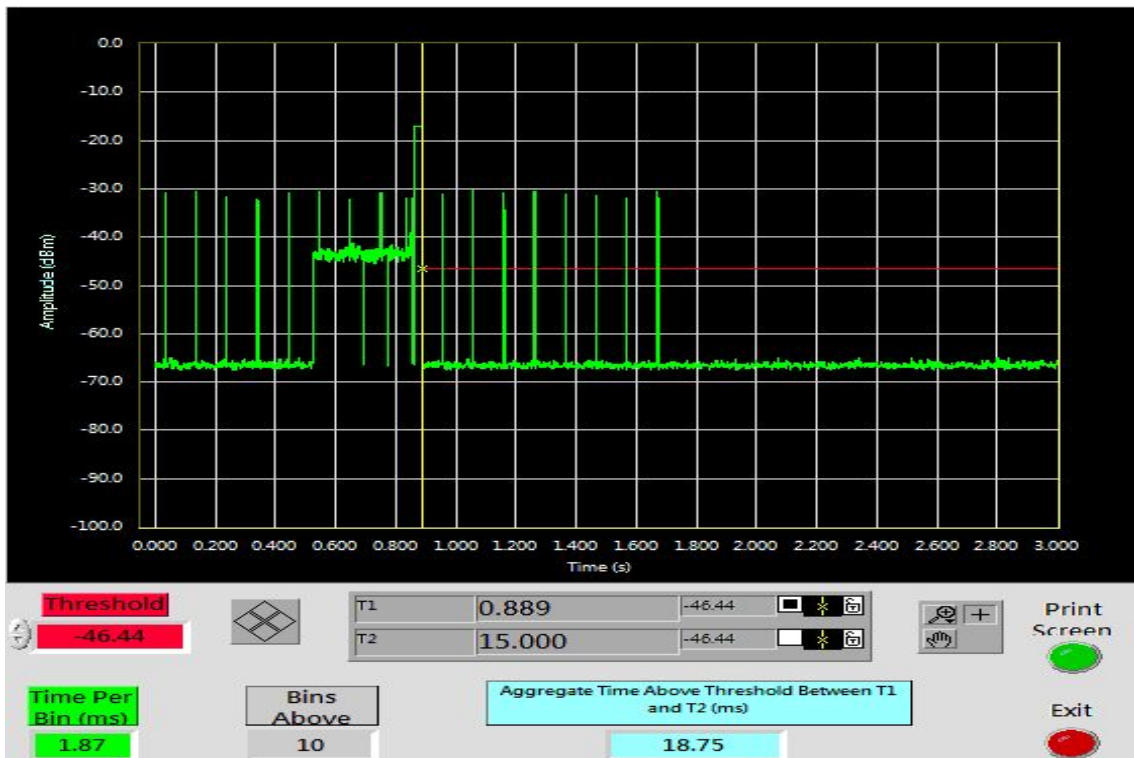
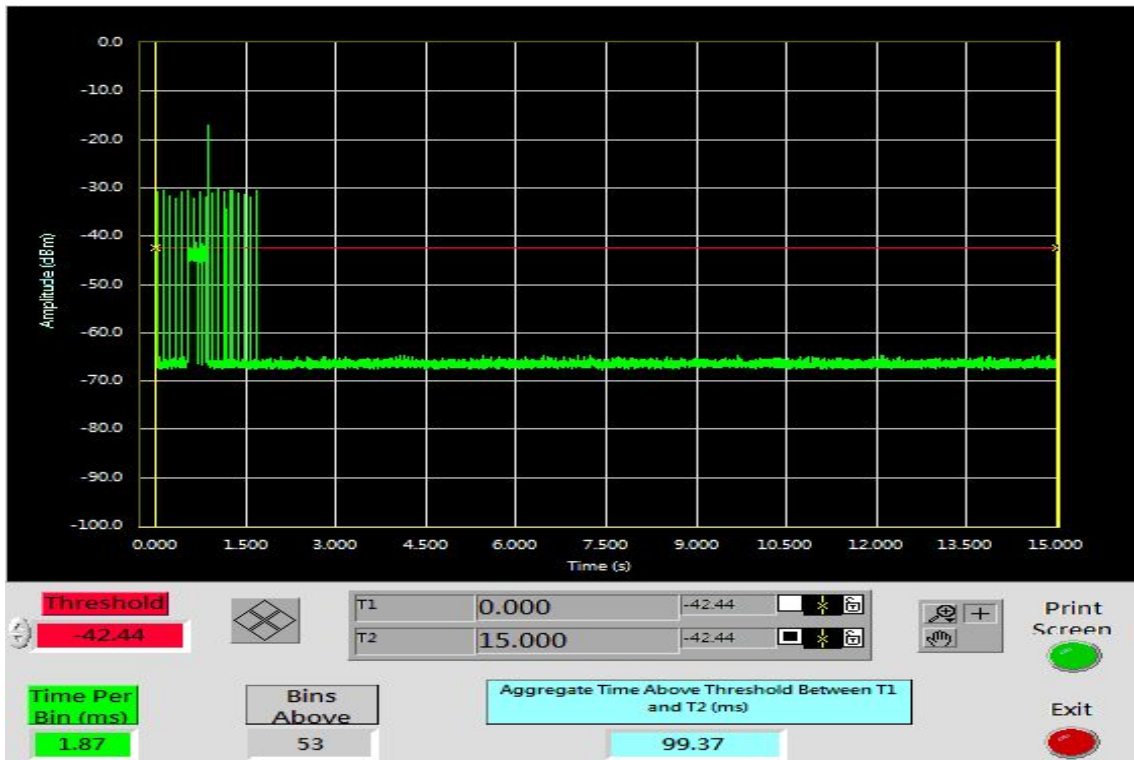

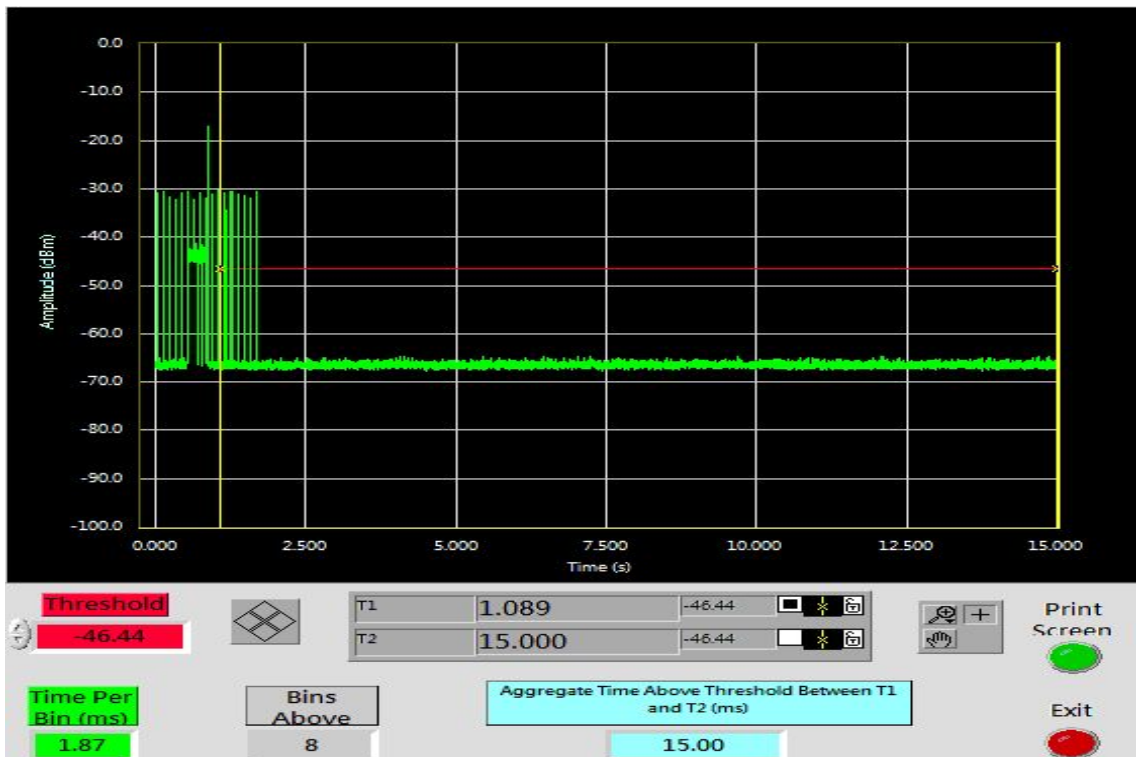
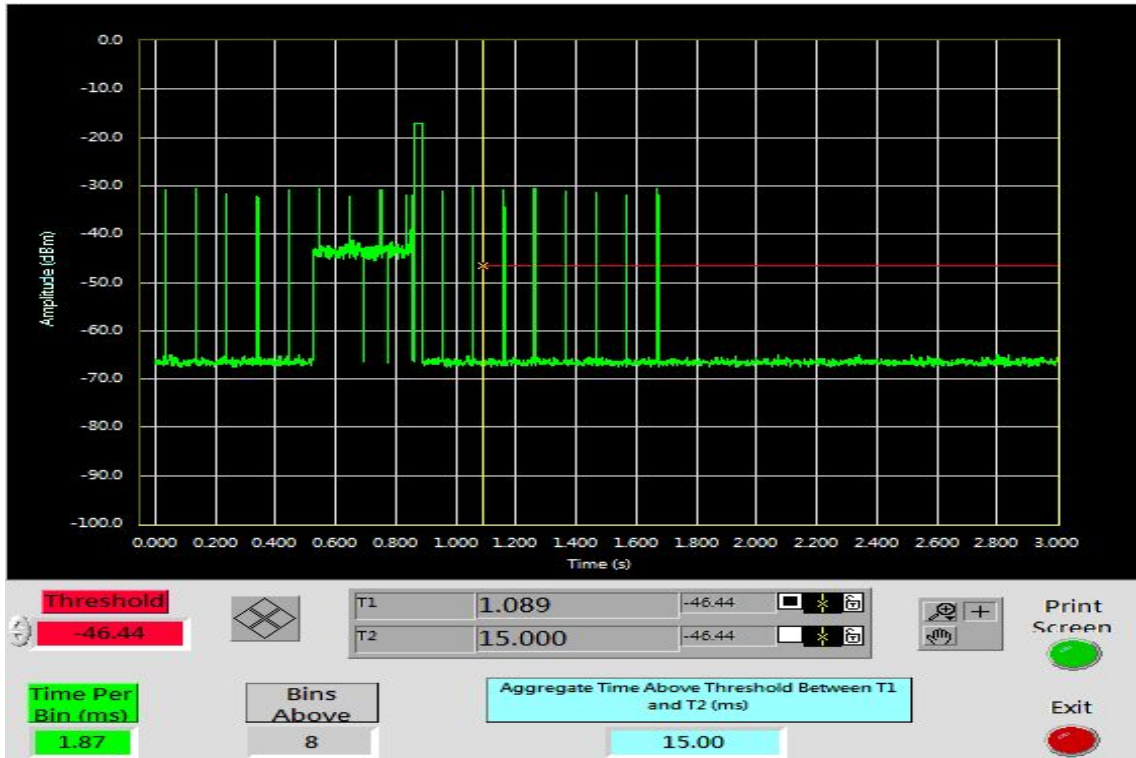



For R5

Aggregate Transmission Time (ms)	Limit (ms)	Margin (ms)
0	60	-60

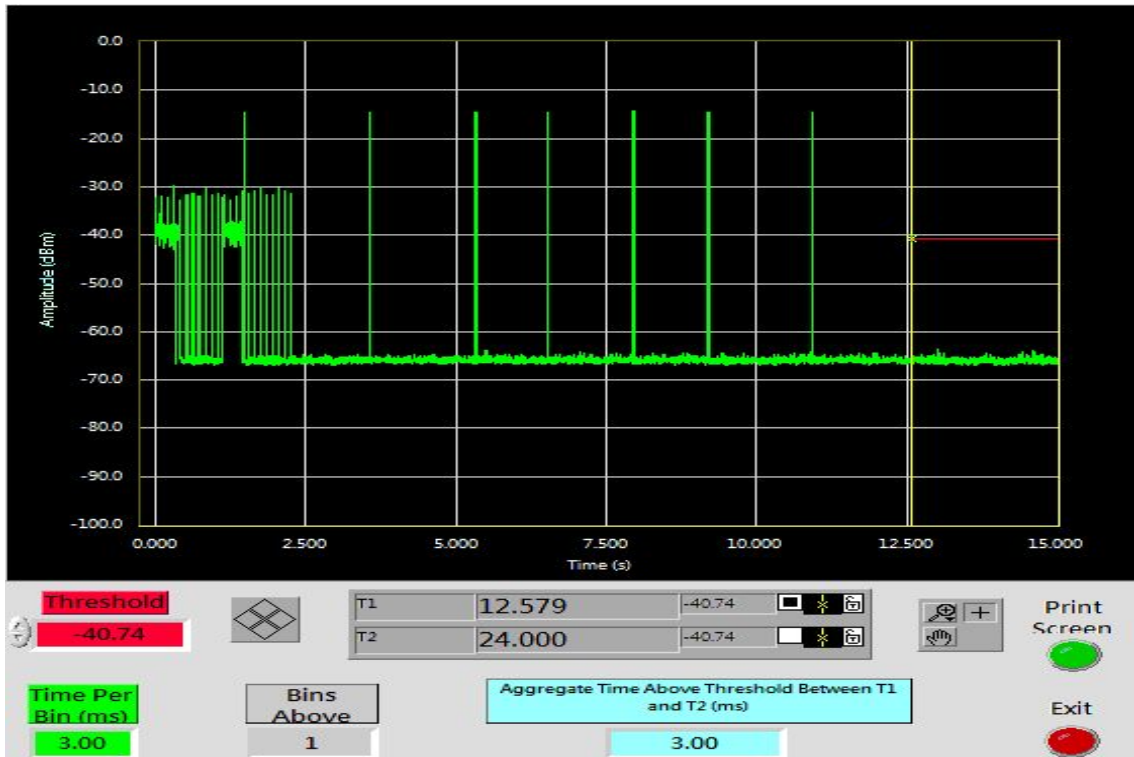
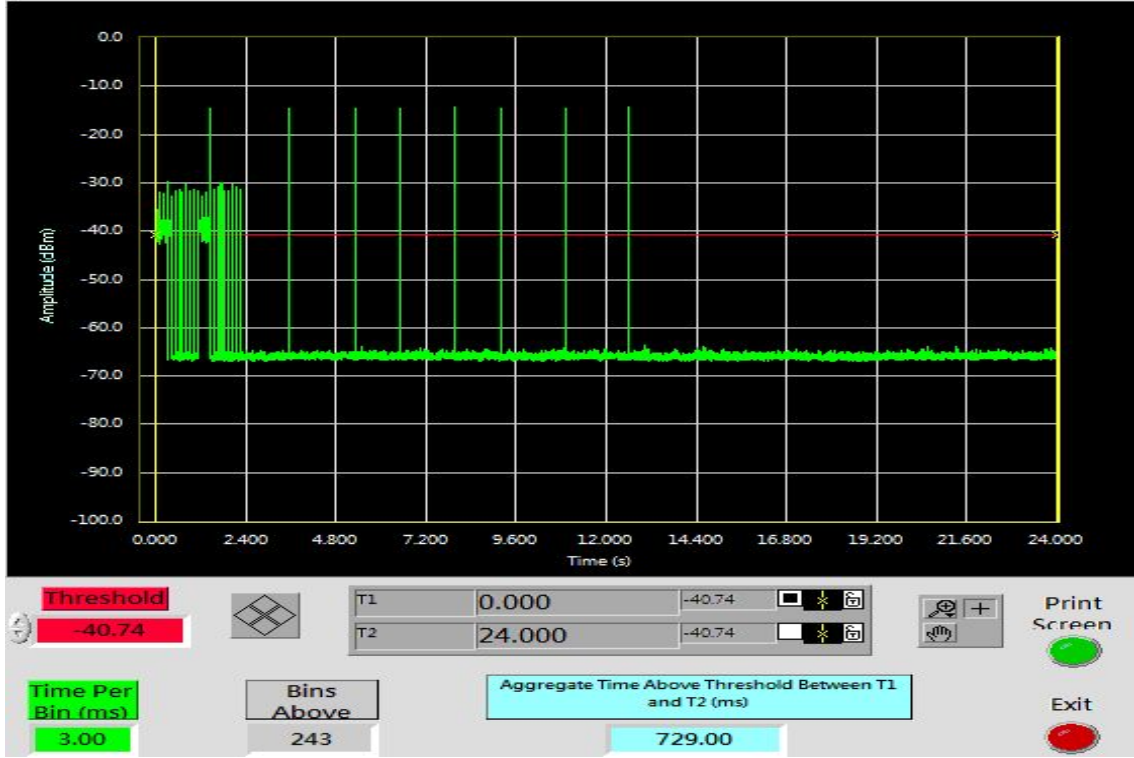

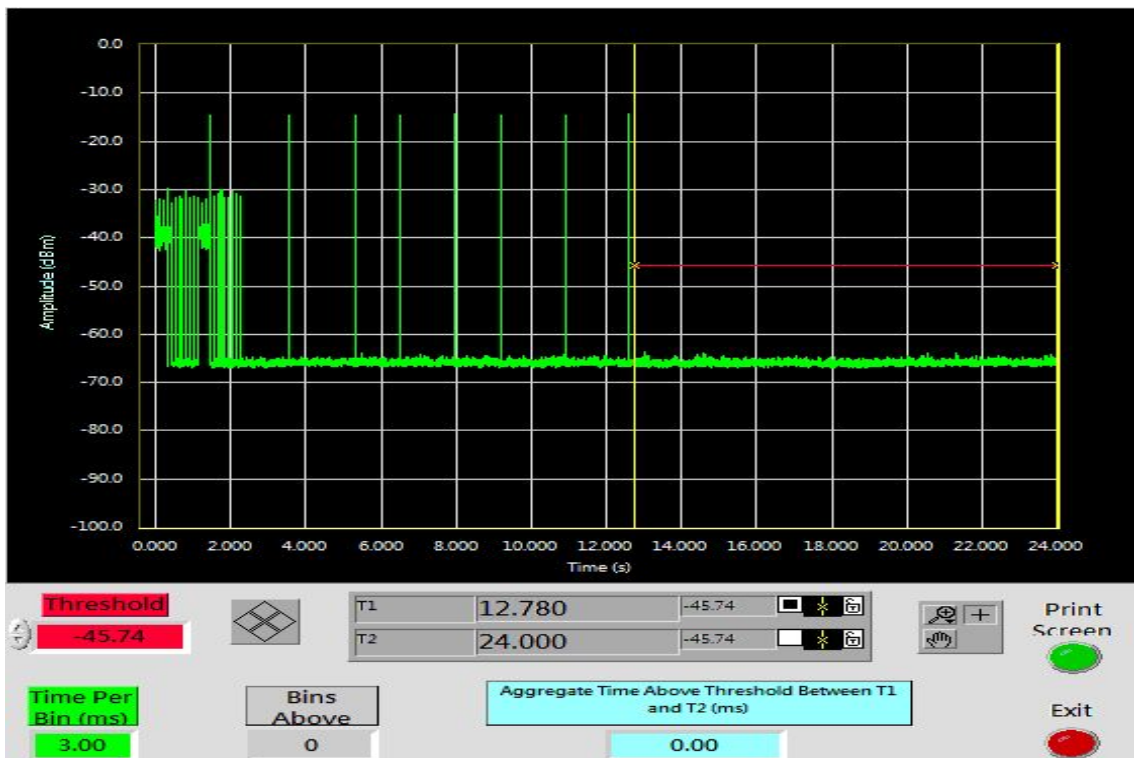
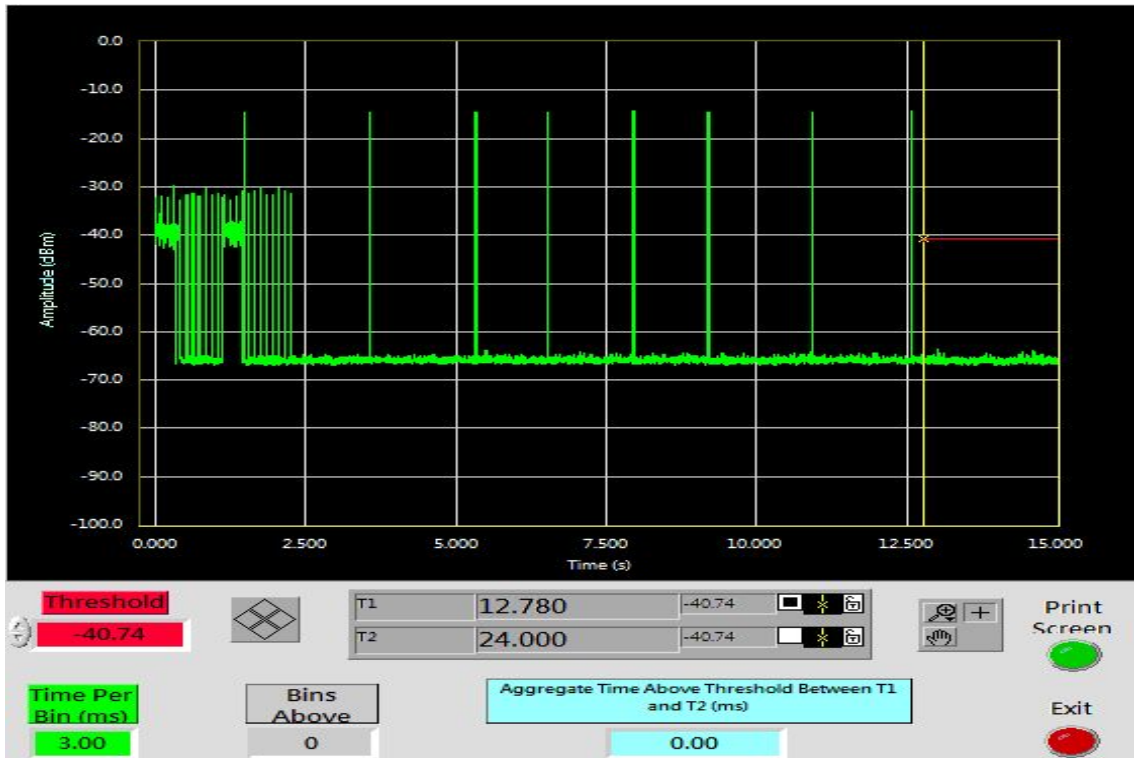



Bandwidth 40 MHz Mode

Type 1 Channel Move Time Results

No non-compliance noted.

Channel Move Time (s)	Limit (s)
0.7806	10

Agilent 23:43:11 Jul 30, 2014

R T

Δ Mkr2 780.6 ms
-27.10 dB

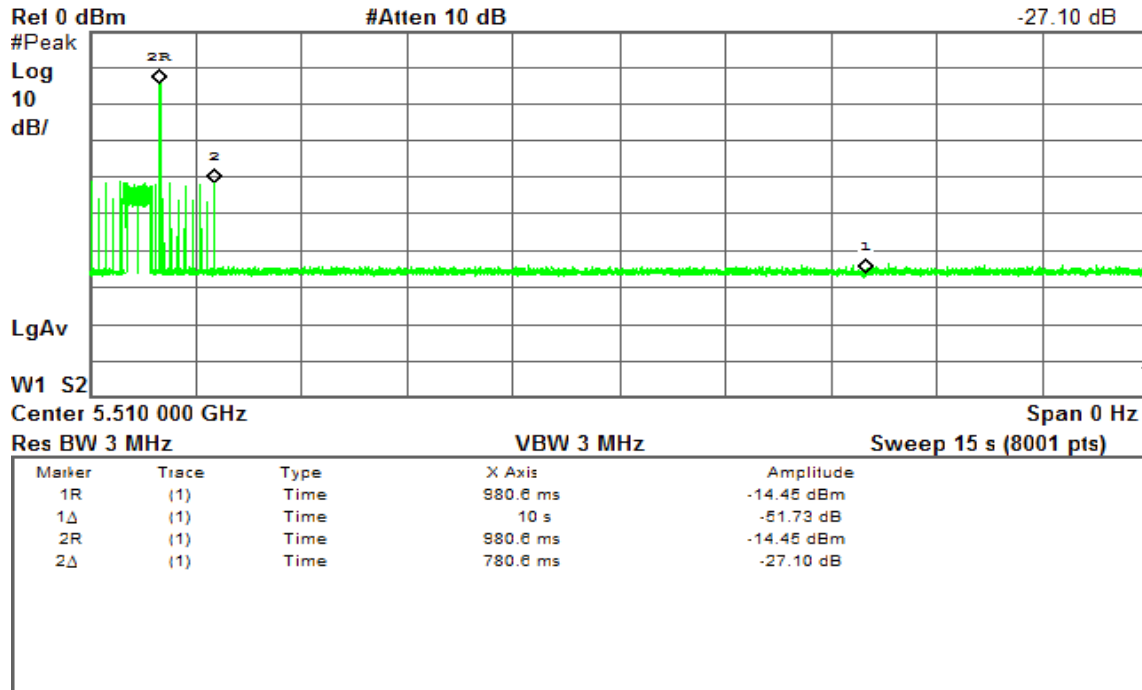



Type 5 Channel Move Time Results

No non-compliance noted.

Channel Move Time (s)	Limit (s)
0	10

Agilent 13:46:35 Aug 1, 2014

T

Δ Mkr2 0 s
0.00 dB

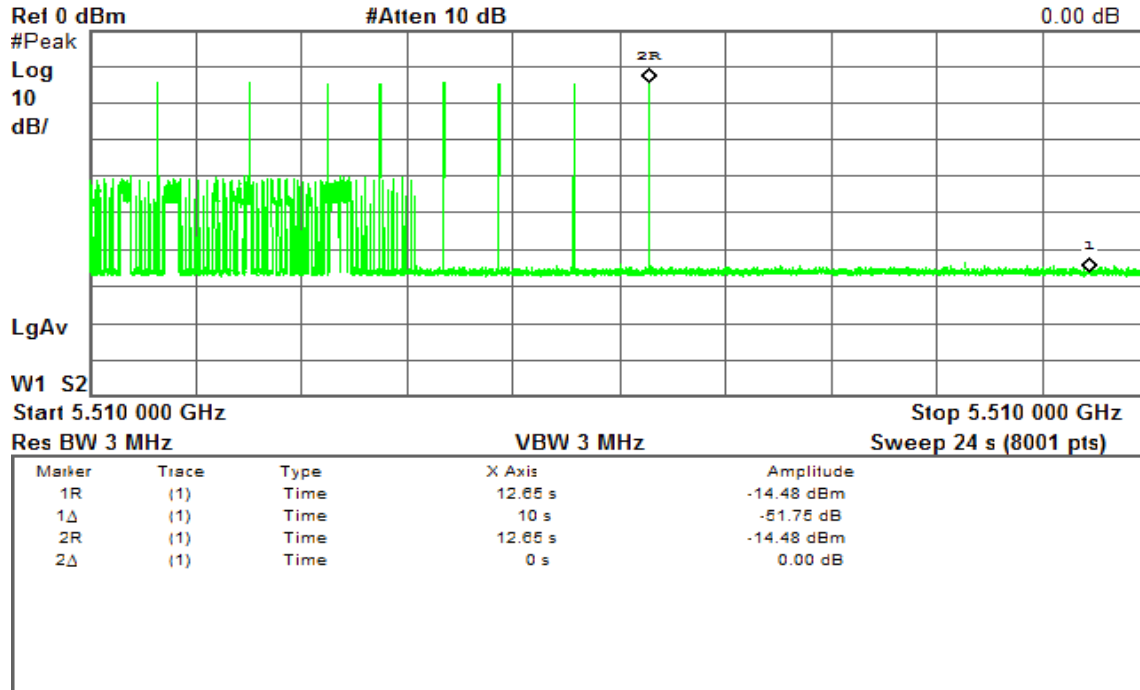



Bandwidth 40 MHz Mode

Type 1 Channel Closing Transmission Time Results

No non-compliance noted.

For R1

Aggregate Transmission Time (ms)	Limit (ms)	Margin (ms)
13.12	60	-47.88

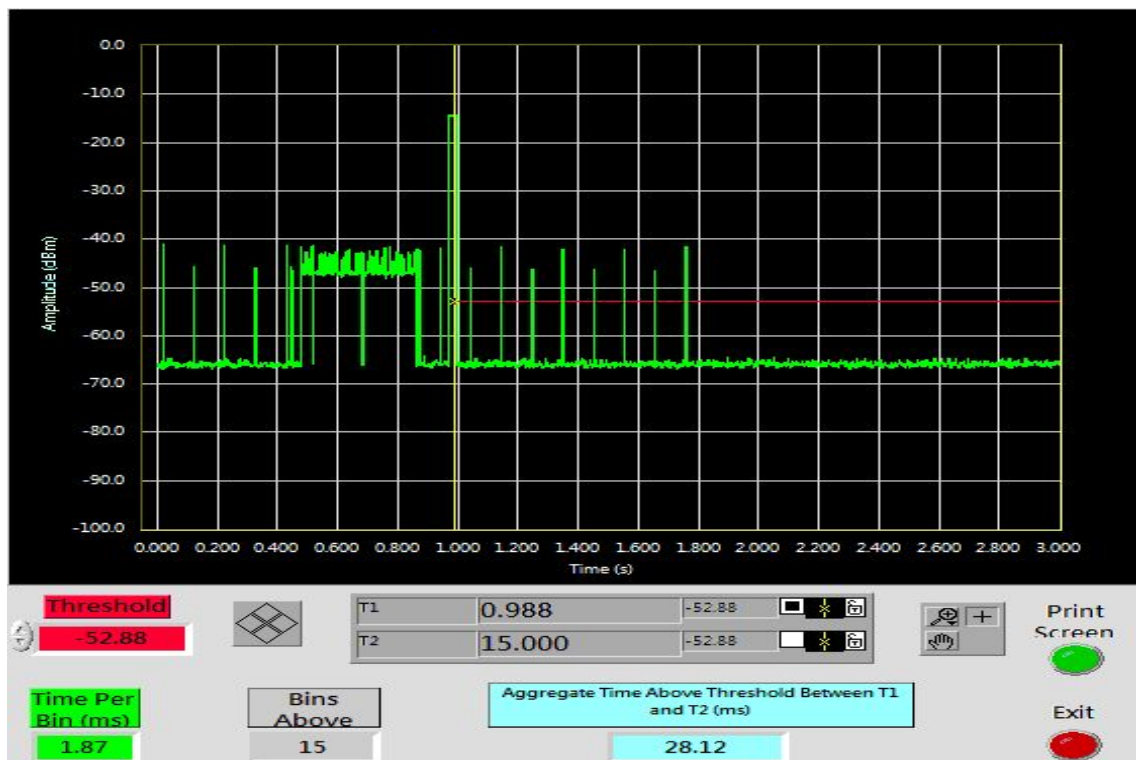
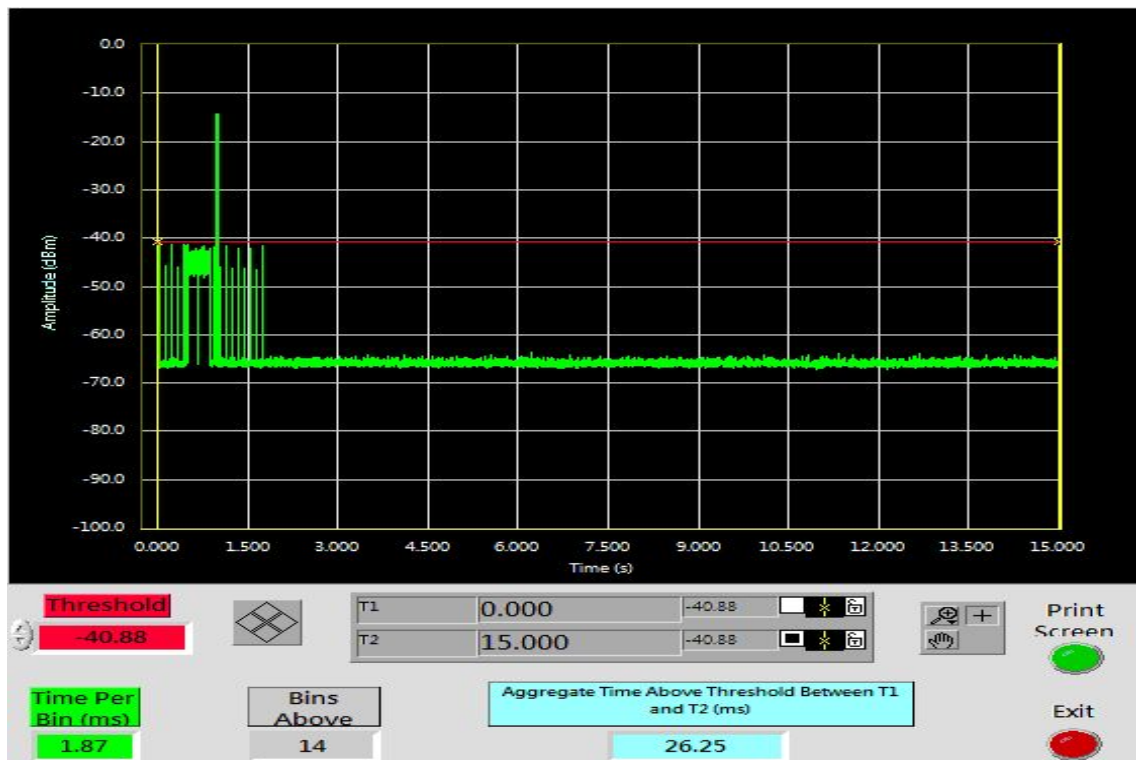

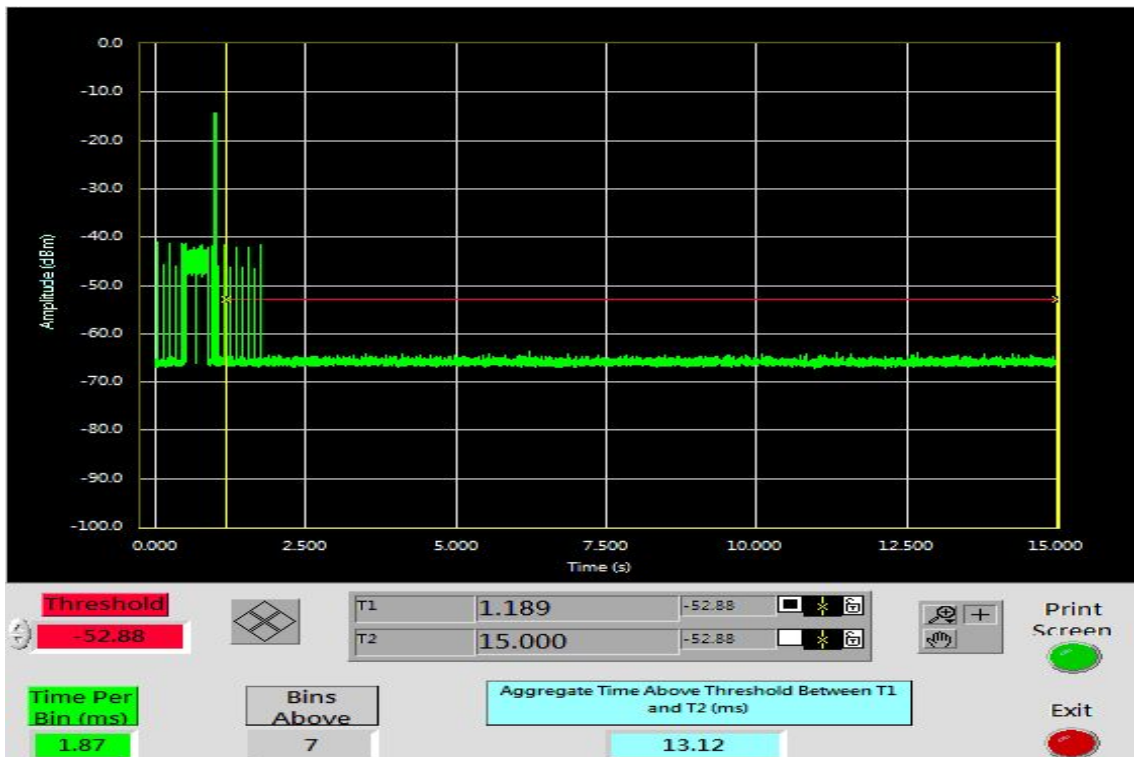
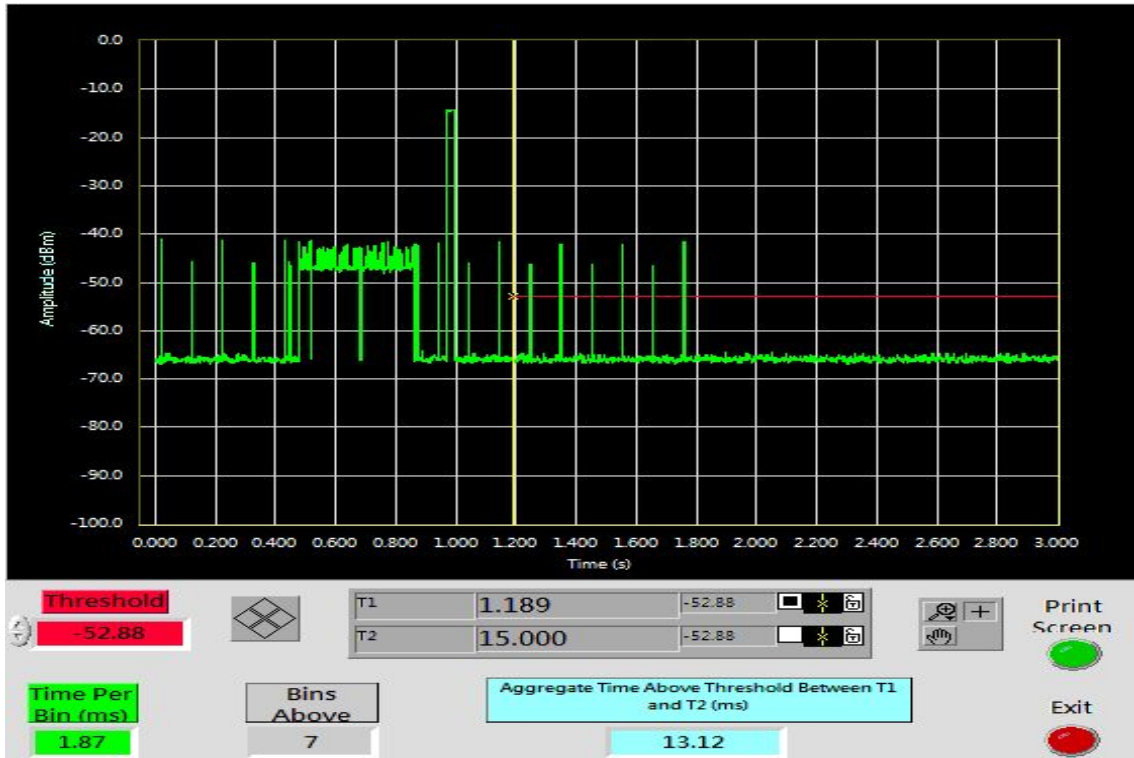



For R5

Aggregate Transmission Time (ms)	Limit (ms)	Margin (ms)
0	60	-60

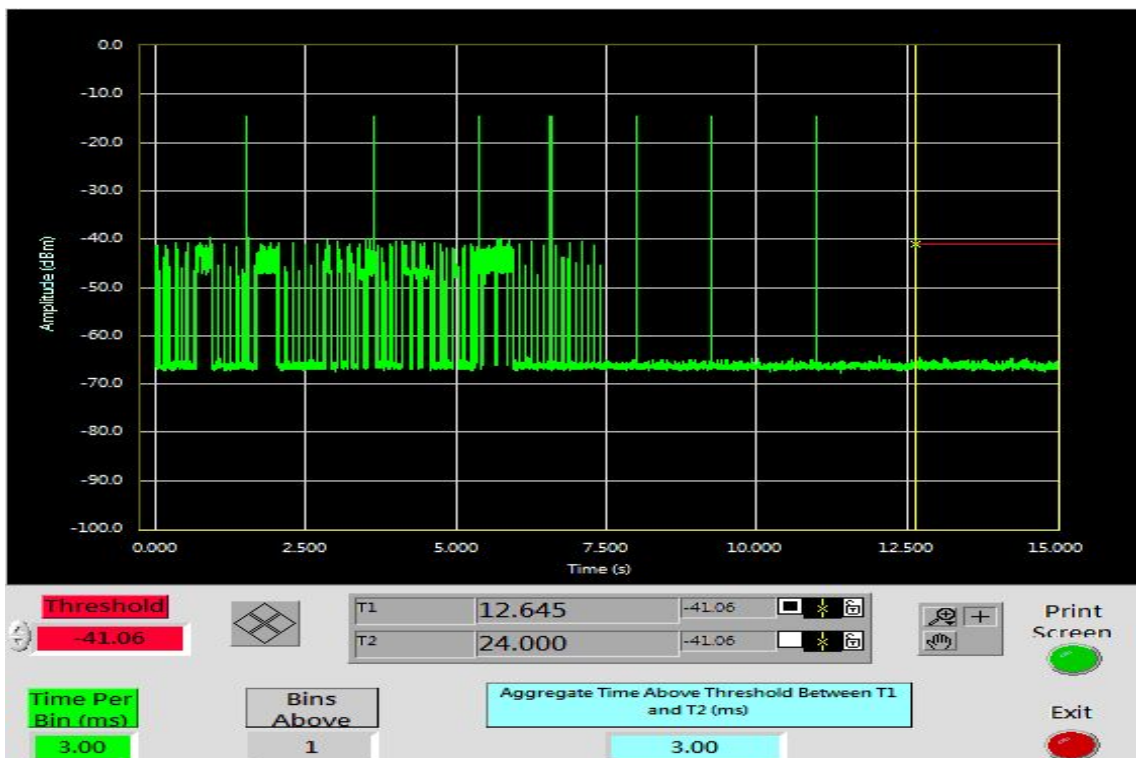
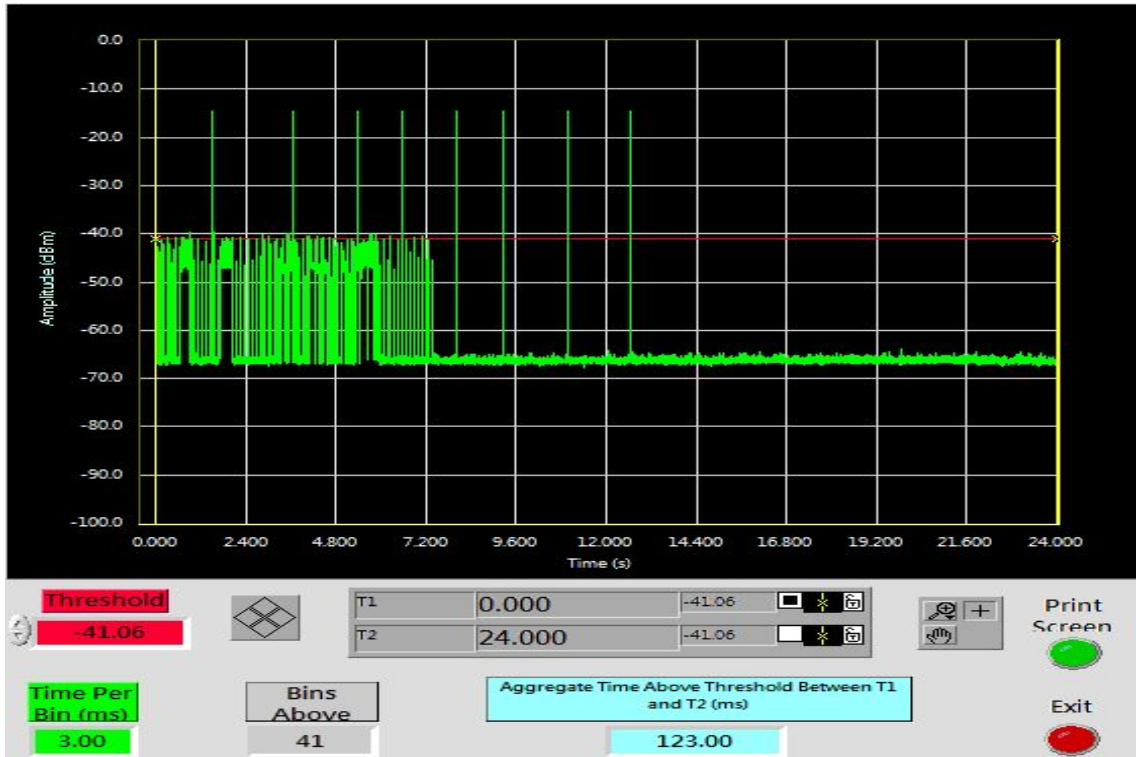

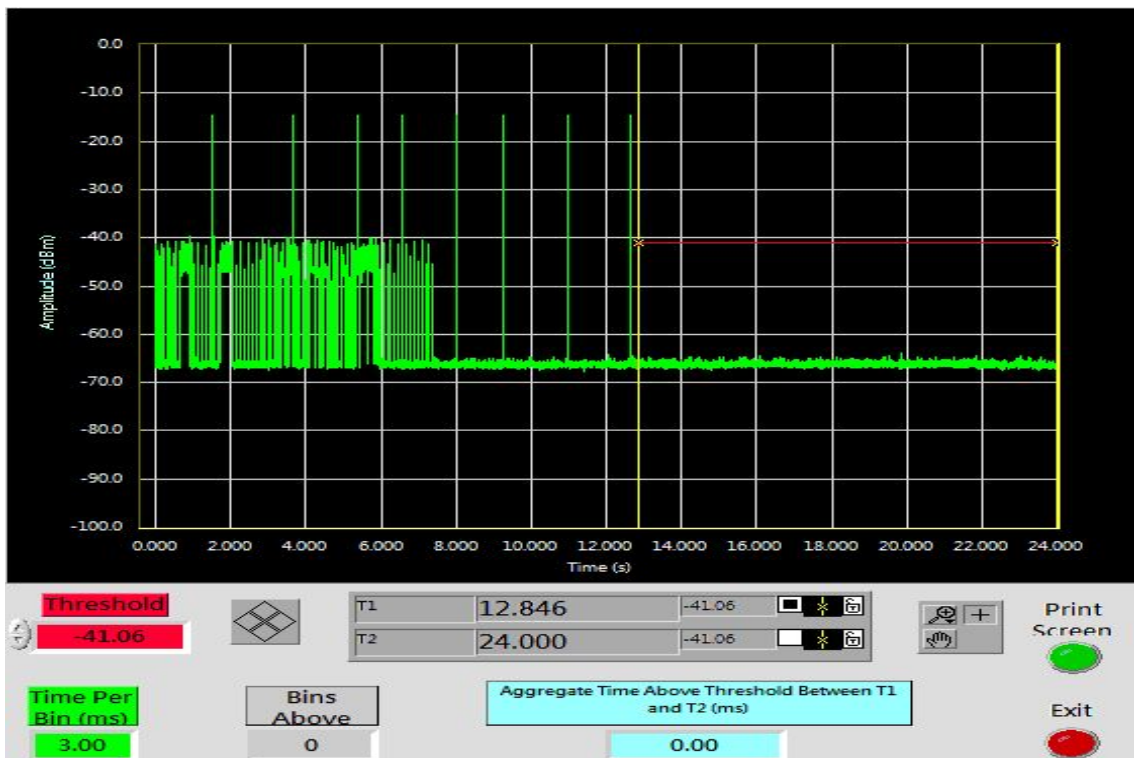
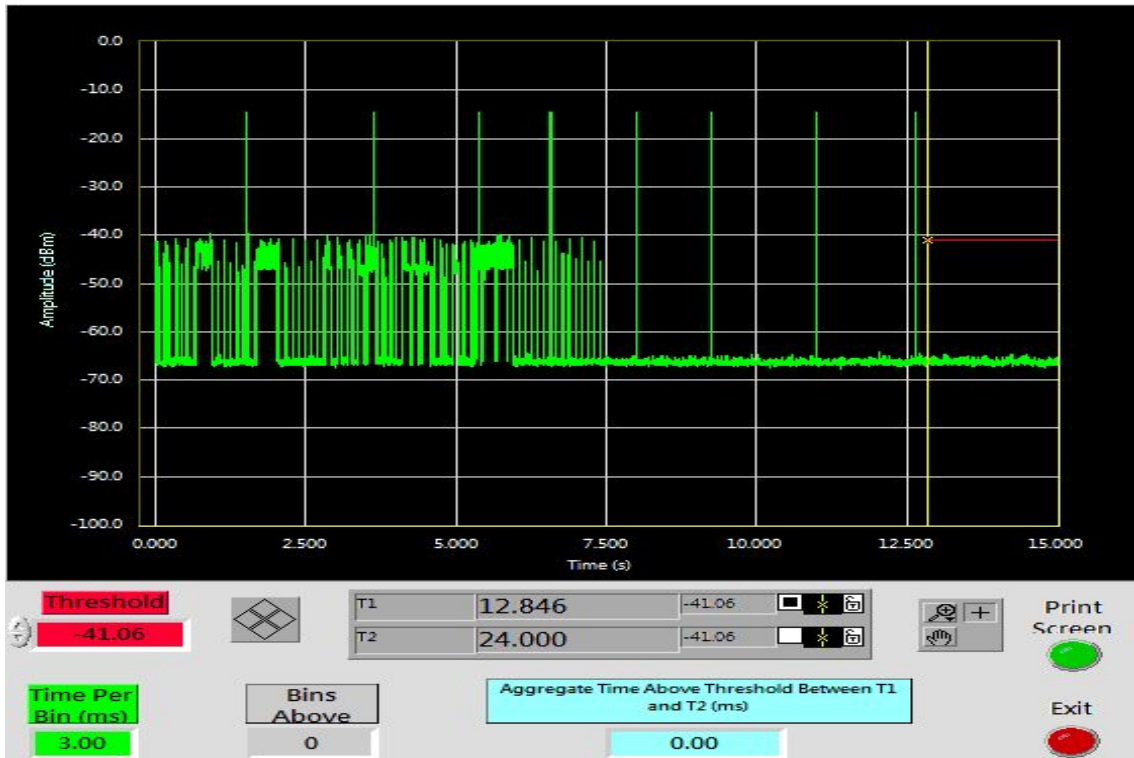



NON-OCCUPANCY PERIOD

LOW BAND RESULTS / Bandwidth 20 MHz Mode

Type 1 Non-Occupancy Period Test Results

No non-compliance noted.

No EUT transmissions were observed on the test channel during the 30 minute observation time.

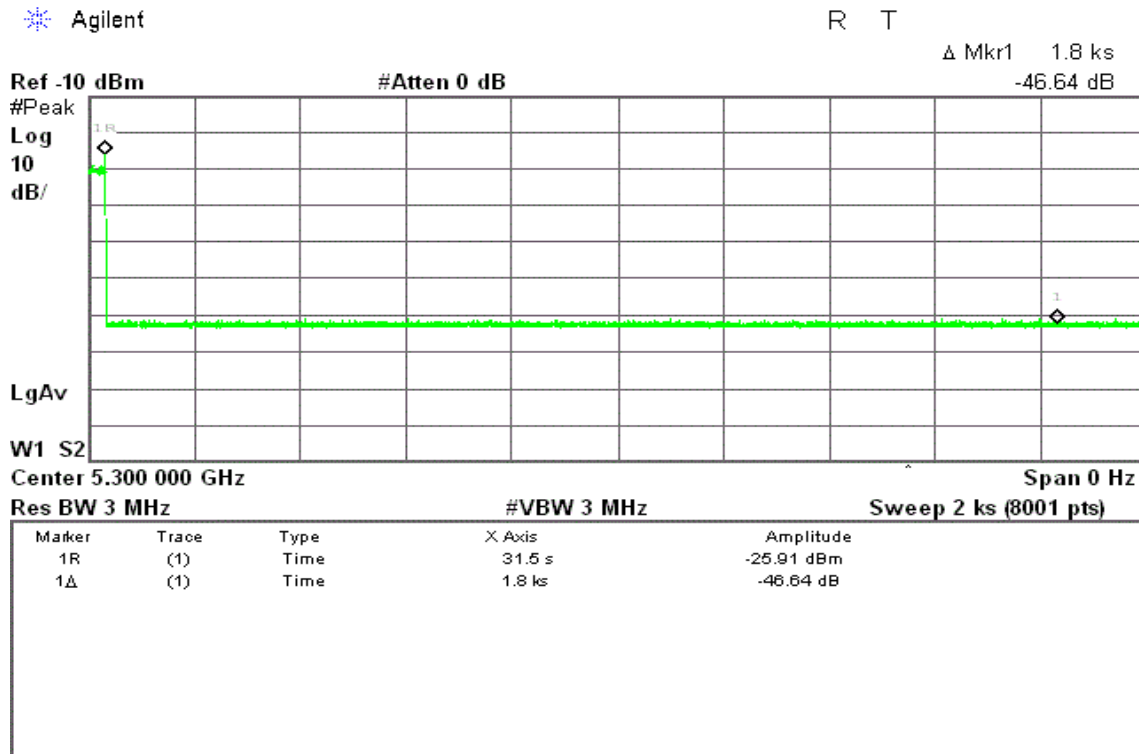



LOW BAND RESULTS / Bandwidth 40 MHz Mode

Type 1 Non-Occupancy Period Test Results

No non-compliance noted.

No EUT transmissions were observed on the test channel during the 30 minute observation time.

Agilent

T

Δ Mkr1 1.8 ks

-50.08 dB

Ref -10 dBm

#Atten 0 dB

#Peak

Log

10

dB/

LgAv

W1 S2

Center 5.310 000 GHz

Span 0 Hz

Res BW 3 MHz

#VBW 3 MHz

Sweep 2 ks (8001 pts)

Marker	Trace	Type	X Axis	Amplitude
1R	(1)	Time	23.6 s	-25.24 dBm
1Δ	(1)	Time	1.8 ks	-50.08 dB



HIGH BAND RESULTS / Bandwidth 20 MHz Mode

Type 1 Non-Occupancy Period Test Results

No non-compliance noted.

No EUT transmissions were observed on the test channel during the 30 minute observation time.

Agilent

T

Δ Mkr1 1.8 ks

Ref -10 dBm

#Atten 0 dB

-48.28 dB

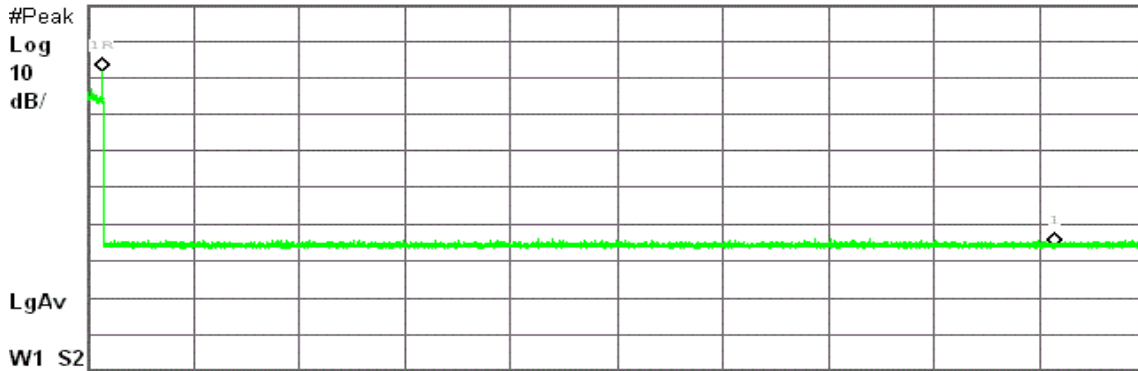

Center 5.500 000 GHz

Span 0 Hz

Res BW 3 MHz

#VBW 3 MHz

Sweep 2 ks (8001 pts)

Marker	Trace	Type	X Axis	Amplitude
1R	(1)	Time	28.5 s	-28.08 dBm
1Δ	(1)	Time	1.8 ks	-48.28 dB



HIGH BAND RESULTS / Bandwidth 40 MHz Mode

Type 1 Non-Occupancy Period Test Results

No non-compliance noted.

No EUT transmissions were observed on the test channel during the 30 minute observation time.

Agilent

T

Δ Mkr1 1.8 ks

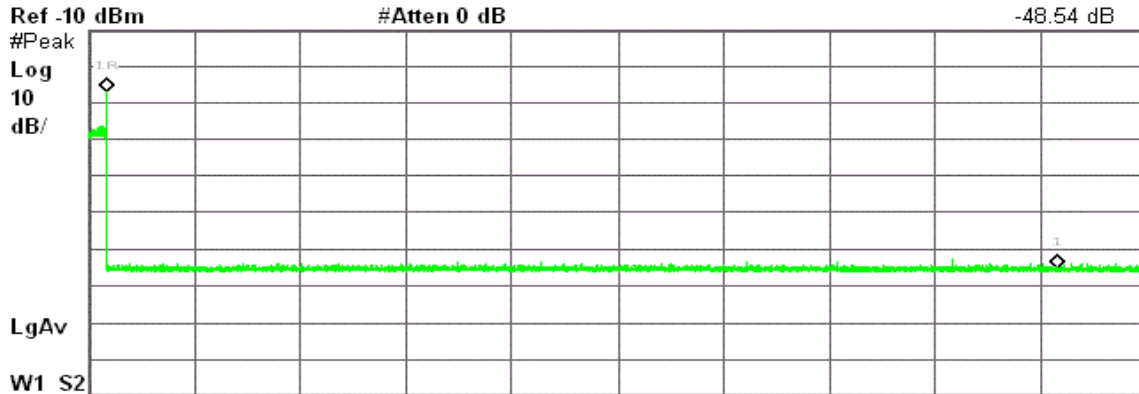

Center 5.510 000 GHz Span 0 Hz

Res BW 3 MHz VBW 3 MHz Sweep 2 ks (8001 pts)

Marker	Trace	Type	X Axis	Amplitude
1R	(1)	Time	32.25 s	-26.95 dBm
1Δ	(1)	Time	1.8 ks	-48.54 dB