



**FCC 47 CFR PART 15 SUBPART C &  
INDUSTRY CANADA RSS-210**

**TEST REPORT**

**For**

**Tablet Computer**

**FCC Model: WT10-A, WT10-B**

**IC Mode: WT10-A**

**Trade Name: TOSHIBA**

*Issued to*

**Pegatron Corporation**

**5F, NO. 76, LIGONG ST., BEITOU DISTRICT, TAIPEI CITY 112, TAIWAN (R.O.C.)**

*Issued by*

**Compliance Certification Services Inc.**

**No.11, Wugong 6th Rd., Wugu Dist.,**

**New Taipei City 24891, Taiwan. (R.O.C.)**

**<http://www.ccsrf.com>**

**[service@ccsrf.com](mailto:service@ccsrf.com)**

**Issued Date: May 8, 2014**



---

*Note: This report shall not be reproduced except in full, without the written approval of Compliance Certification Services Inc. This document may be altered or revised by Compliance Certification Services Inc. personnel only, and shall be noted in the revision section of the document.*



**Revision History**

Rev.	Issue Date	Revisions	Effect Page	Revised By
00	May 8, 2014	Initial Issue	ALL	Becca Chen



## TABLE OF CONTENTS

1. TEST RESULT CERTIFICATION .....	4
2. EUT DESCRIPTION .....	5
3. TEST METHODOLOGY .....	6
3.1 EUT CONFIGURATION .....	6
3.2 EUT EXERCISE.....	6
3.3 GENERAL TEST PROCEDURES .....	6
3.4 FCC PART 15.205 RESTRICTED BANDS OF OPERATIONS .....	7
3.5 DESCRIPTION OF TEST MODES .....	8
4. INSTRUMENT CALIBRATION .....	9
4.1 MEASURING INSTRUMENT CALIBRATION.....	9
4.2 MEASUREMENT EQUIPMENT USED .....	9
4.3 MEASUREMENT UNCERTAINTY.....	10
5. FACILITIES AND ACCREDITATIONS .....	11
5.1 FACILITIES .....	11
5.2 EQUIPMENT .....	11
5.3 TABLE OF ACCREDITATIONS AND LISTINGS .....	12
6. SETUP OF EQUIPMENT UNDER TEST .....	13
6.1 SETUP CONFIGURATION OF EUT .....	13
6.2 SUPPORT EQUIPMENT .....	13
7. FCC PART 15.247 REQUIREMENTS & RSS 210 REQUIREMENTS .....	14
7.1 99% BANDWIDTH .....	14
7.2 20 DB BANDWIDTH .....	19
7.3 PEAK POWER .....	26
7.4 AVERAGE POWER .....	27
7.5 BAND EDGES MEASUREMENT .....	28
7.6 FREQUENCY SEPARATION.....	47
7.7 NUMBER OF HOPPING FREQUENCY .....	50
7.8 TIME OF OCCUPANCY (DWELL TIME) .....	55
7.9 SPURIOUS EMISSIONS .....	64
7.10 POWERLINE CONDUCTED EMISSIONS.....	82
APPENDIX II PHOTOGRAPHS OF TEST SETUP.....	85
APPENDIX 1 - PHOTOGRAPHS OF EUT	



# 1. TEST RESULT CERTIFICATION

**Applicant:** Pegatron Corporation  
 5F, NO. 76, LIGONG ST., BEITOU DISTRICT, TAIPEI CITY  
 112, TAIWAN (R.O.C.)

**Manufacturer:** Toshiba Corporation  
 1-1, Shibaura 1-Chome, Minato-Ku, Tokyo, 105-8001, Japan

**Equipment Under Test:** Tablet Computer

**Trade Name:** TOSHIBA

**FCC Model:** WT10-A, WT10-B

**IC Model:** WT10-A

**Date of Test:** April 28 ~ May 2, 2014

APPLICABLE STANDARDS	
STANDARD	TEST RESULT
FCC 47 CFR Part 15 Subpart C Industry Canada RSS-210 Issue 8 Annex 8 Industry Canada RSS-GEN Issue 3	No non-compliance noted

### We hereby certify that:

The above equipment was tested by Compliance Certification Services Inc. The test data, data evaluation, test procedures, and equipment configurations shown in this report were made in accordance with the procedures given in **ANSI C63.4: 2009** and the energy emitted by the sample EUT tested as described in this report is in compliance with the requirements set forth in the above standards. The test results of this report relate only to the tested sample EUT identified in this report.

Approved by:

Reviewed by:

---

Miller Lee  
 Section Manager  
 Compliance Certification Services Inc.

---

Angel Cheng  
 Section Manager  
 Compliance Certification Services Inc.



## 2. EUT DESCRIPTION

<b>Product</b>	Tablet Computer
<b>Trade Name</b>	TOSHIBA
<b>FCC Model Number</b>	WT10-A, WT10-B
<b>IC Model Number</b>	WT10-A
<b>Model Discrepancy</b>	N/A
<b>Received Date</b>	April 21, 2014
<b>EUT Power Rating</b>	1. Power from Adaptor Chicony / W12-010N3A I/P: 100-240Vac, 50/60Hz, 0.3A O/P: 5Vdc, 2.0A 2. Powered from host device via USB Cable 3. Power from Battery LG (Trademark: Toshiba) / PA5204U-1BRS Rating: 3.75V 5820mAh
<b>Frequency Range</b>	2402 ~ 2480 MHz
<b>Transmit Power</b>	6.38 dBm
<b>Modulation Technique</b>	GFSK for 1Mbps; $\pi/4$ -DQPSK for 2Mbps; 8DPSK for 3Mbps
<b>Number of Channels</b>	79 Channels
<b>Antenna Specification</b>	ACXC / Chip Antenna P/N: AT5020-B2R8HAAT/LF Gain: 2.629 dBi

**Remark:**

1. The sample selected for test was engineering sample that approximated to production product and was provided by manufacturer.
2. This submittal(s) (test report) is intended for FCC&IC ID: **VUIPDAWT10-A & 7582A-PDAWT10-A** filing to comply with FCC Part 15C, Section 15.207, 15.209 and IC RSS-210 & RSS-GEN.



### 3. TEST METHODOLOGY

The tests documented in this report were performed in accordance with ANSI C63.4: 2009 and FCC CFR 47 Part 15.207, 15.209, 15.247 and DA00-705.

The tests documented in this report were performed in accordance with IC RSS-210, IC RSS-Gen, IC RSS-102, and ANSI C63.4.

This submittal(s) (test report) is intended for IC Certification with Industry Canada RSS-210.

#### 3.1 EUT CONFIGURATION

The EUT configuration for testing is installed on RF field strength measurement to meet the Commissions requirement and operating in a manner that intends to maximize its emission characteristics in a continuous normal application.

#### 3.2 EUT EXERCISE

The EUT was operated in the engineering mode to fix the TX frequency that was for the purpose of the measurements.

According to its specifications, the EUT must comply with the requirements of the Section 15.207, 15.209 and 15.247 under the FCC Rules Part 15 Subpart C.

The tests documented in this report were performed in accordance with IC RSS-210, IC RSS-Gen, IC RSS-102, and ANSI C63.4: 2009.

#### 3.3 GENERAL TEST PROCEDURES

##### Conducted Emissions

The EUT is placed on the turntable, which is 0.8 m above ground plane. According to the requirements in Section 13.1.4.1 of ANSI C63.4 Conducted emissions from the EUT measured in the frequency range between 0.15 MHz and 30MHz using CISPR Quasi-peak and average detector modes.

##### Radiated Emissions

The EUT is placed on a turn table, which is 0.8 m above ground plane. The turntable shall rotate 360 degrees to determine the position of maximum emission level. EUT is set 3m away from the receiving antenna, which varied from 1m to 4m to find out the highest emission. And also, each emission was to be maximized by changing the polarization of receiving antenna both horizontal and vertical. In order to find out the maximum emissions, exploratory radiated emission measurements were made according to the requirements in Section 13.1.4.1 of ANSI C63.4: 2009.



### 3.4 FCC PART 15.205 RESTRICTED BANDS OF OPERATIONS

(a) Except as shown in paragraph (d) of this section, only spurious emissions are permitted in any of the frequency bands listed below:

MHz	MHz	MHz	GHz
0.090 - 0.110	16.42 - 16.423	399.9 - 410	4.5 - 5.15
<sup>1</sup> 0.495 - 0.505	16.69475 - 16.69525	608 - 614	5.35 - 5.46
2.1735 - 2.1905	16.80425 - 16.80475	960 - 1240	7.25 - 7.75
4.125 - 4.128	25.5 - 25.67	1300 - 1427	8.025 - 8.5
4.17725 - 4.17775	37.5 - 38.25	1435 - 1626.5	9.0 - 9.2
4.20725 - 4.20775	73 - 74.6	1645.5 - 1646.5	9.3 - 9.5
6.215 - 6.218	74.8 - 75.2	1660 - 1710	10.6 - 12.7
6.26775 - 6.26825	108 - 121.94	1718.8 - 1722.2	13.25 - 13.4
6.31175 - 6.31225	123 - 138	2200 - 2300	14.47 - 14.5
8.291 - 8.294	149.9 - 150.05	2310 - 2390	15.35 - 16.2
8.362 - 8.366	156.52475 -	2483.5 - 2500	17.7 - 21.4
8.37625 - 8.38675	156.52525	2655 - 2900	22.01 - 23.12
8.41425 - 8.41475	156.7 - 156.9	3260 - 3267	23.6 - 24.0
12.29 - 12.293	162.0125 - 167.17	3332 - 3339	31.2 - 31.8
12.51975 - 12.52025	167.72 - 173.2	3345.8 - 3358	36.43 - 36.5
12.57675 - 12.57725	240 - 285	3600 - 4400	( <sup>2</sup> )
13.36 - 13.41	322 - 335.4		

<sup>1</sup> Until February 1, 1999, this restricted band shall be 0.490-0.510 MHz.

<sup>2</sup> Above 38.6

(b) Except as provided in paragraphs (d) and (e), the field strength of emissions appearing within these frequency bands shall not exceed the limits shown in Section 15.209. At frequencies equal to or less than 1000 MHz, compliance with the limits in Section 15.209 shall be demonstrated using measurement instrumentation employing a CISPR quasi-peak detector. Above 1000 MHz, compliance with the emission limits in Section 15.209 shall be demonstrated based on the average value of the measured emissions. The provisions in Section 15.35 apply to these measurements.



### 3.5 DESCRIPTION OF TEST MODES

The EUT (model: WT10-A, WT10-B) is a 1x1 802.11abgn+ BT combo card module. WLAN and Bluetooth cannot transmit simultaneously.

Test program used to control the EUT for staying in continuous transmitting mode was programmed.

After verification, all tests were carried out with the worst case test modes as shown below except radiated spurious emission below 1GHz and power line conducted emissions below 30MHz, which worst case was in normal link mode only.

Channel Low (2402MHz), Mid (2441MHz) and High (2480MHz) with 1Mbps data rate was chosen for full testing.

During the preliminary test, GFSK,  $\pi/4$ -QPSK & 8DPSK with DH1 were pre-tested and found that 8DPSK emits the highest output power. Then the tests were carried on with DH1 compare to DH3 & DH5 and found that 8DPSK with DH5 emit the highest output power, and therefore had been tested under operating condition.

Following channels were selected for the radiated emission testing only as listed below:

Tested Channel	Modulation Type	Packet Type	Date Rate
Low, Mid, High	GFSK	DH 5	1
Low, Mid, High	8DPSK	DH 5	3





## 4. INSTRUMENT CALIBRATION

### 4.1 MEASURING INSTRUMENT CALIBRATION

The measuring equipment, which was utilized in performing the tests documented herein, has been calibrated in accordance with the manufacturer's recommendations for utilizing calibration equipment, which is traceable to recognized national standards.

### 4.2 MEASUREMENT EQUIPMENT USED

#### Equipment Used for Emissions Measurement

*Remark: Each piece of equipment is scheduled for calibration once a year and Loop Antenna is scheduled for calibration once three years.*

Conducted Emissions Test Site				
Name of Equipment	Manufacturer	Model	Serial Number	Calibration Due
Spectrum Analyzer	Agilent	E4446A	MY43360131	03/19/2015
Power Meter	Anritsu	ML2495A	1012009	06/04/2014
Power Sensor	Anritsu	MA2411A	0917072	06/04/2014

Wugu 966 Chamber A				
Name of Equipment	Manufacturer	Model	Serial Number	Calibration Due
Spectrum Analyzer	Agilent	E4446A	US42510268	11/05/2014
EMI Test Receiver	R&S	ESCI	100064	02/27/2015
Pre-Amplifier	Mini-Circuits	ZFL-1000LN	SF350700823	01/11/2015
Pre-Amplifier	MITEQ	AFS44-00102650-42-10P-44	1415367	11/18/2014
Bilog Antenna	Sunol Sciences	JB3	A030105	10/01/2014
Horn Antenna	EMCO	3117	00055165	02/12/2015
Horn Antenna	EMCO	3116	2487	10/09/2014
Loop Antenna	EMCO	6502	8905/2356	06/09/2014
Turn Table	CCS	CC-T-1F	N/A	N.C.R
Antenna Tower	CCS	CC-A-1F	N/A	N.C.R
Controller	CCS	CC-C-1F	N/A	N.C.R
Site NSA	CCS	N/A	N/A	12/21/2014
Test S/W	EZ-EMC (CCS-3A1RE)			

Conducted Emission room #A				
Name of Equipment	Manufacturer	Model	Serial Number	Calibration Due
EMI Test Receiver	R&S	ESI	101203	09/12/2014
LISN	R&S	ESH3-Z5	848773/014	12/05/2014
Coaxial Cable	Commate	CFD300-NL	NA	12/05/2014
Test S/W	CCS-3A1-CE			



### 4.3 MEASUREMENT UNCERTAINTY

PARAMETER	UNCERTAINTY
Powerline Conducted Emission	+/- 1.2159
3M Semi Anechoic Chamber / 30M~200M	+/- 4.0138
3M Semi Anechoic Chamber / 200M~1000M	+/- 3.9483
3M Semi Anechoic Chamber / 1G~8G	+/- 2.5975
3M Semi Anechoic Chamber / 8G~18G	+/- 2.6112
3M Semi Anechoic Chamber / 18G~26G	+/- 2.7389
3M Semi Anechoic Chamber / 26G~40G	+/- 2.9683

**Remark:** This uncertainty represents an expanded uncertainty expressed at approximately the 95% confidence level using a coverage factor of  $k=2$ .



## **5. FACILITIES AND ACCREDITATIONS**

### **5.1 FACILITIES**

All measurement facilities used to collect the measurement data are located at

No.199, Chunghsen Road, Hsintien City, Taipei Hsien, Taiwan, R.O.C.

Tel: 886-2-2217-0894 / Fax: 886-2-2217-1029

No.11, Wugong 6th Rd., Wugu Dist., New Taipei City 24891, Taiwan. (R.O.C.)

Tel: 886-2-2299-9720 / Fax: 886-2-2298-4045

No.81-1, Lane 210, Bade 2nd Rd., Lujhu Township, Taoyuan County 33841, TAIWAN, R.O.C.

Tel: 886-3-324-0332 / Fax: 886-3-324-5235

The sites are constructed in conformance with the requirements of ANSI C63.7, ANSI C63.4 and CISPR Publication 22.

### **5.2 EQUIPMENT**

Radiated emissions are measured with one or more of the following types of linearly polarized antennas: tuned dipole, biconical, log periodic, bi-log, and/or ridged waveguide, horn. Spectrum analyzers with pre-selectors and quasi-peak detectors are used to perform radiated measurements.



Conducted emissions are measured with Line Impedance Stabilization Networks and EMI Test Receivers.

Calibrated wideband preamplifiers, coaxial cables, and coaxial attenuators are also used for making measurements.

All receiving equipment conforms to CISPR Publication 16-1, "Radio Interference Measuring Apparatus and Measurement Methods."



### 5.3 TABLE OF ACCREDITATIONS AND LISTINGS

Country	Agency	Scope of Accreditation	Logo
USA	FCC	3M Semi Anechoic Chamber (FCC MRA: TW1039) to perform FCC Part 15 measurements	 FCC MRA: TW1039
Taiwan	TAF	LP0002, RTTE01, FCC Method-47 CFR Part 15 Subpart C, D, E, RSS-210, RSS-310 IDA TS SRD, AS/NZS 4268, AS/NZS 4771, TS 12.1 & 12.2, ETSI EN 300 440-1, ETSI EN 300 440-2, ETSI EN 300 328, ETSI EN 300 220-1, ETSI EN 300 220-2, ETSI EN 301 893, ETSI EN 301 489-1/3/7/17 FCC OET Bulletin 65 + Supplement C, EN 50360, EN 50361, EN 50371, RSS 102, EN 50383, EN 50385, EN 50392, IEC 62209, CNS 14958-1, CNS 14959 FCC Method -47 CFR Part 15 Subpart B IEC / EN 61000-3-2, IEC / EN 61000-3-3, IEC / EN 61000-4-2/3/4/5/6/8/11	 Testing Laboratory 1309
Canada	Industry Canada	3M Semi Anechoic Chamber (IC 2324G-1 / IC 2324G-2) to perform	 IC 2324G-1 IC 2324G-2

\* No part of this report may be used to claim or imply product endorsement by A2LA or any agency of the US Government.



## 6. SETUP OF EQUIPMENT UNDER TEST

### 6.1 SETUP CONFIGURATION OF EUT

See test photographs attached in Appendix II for the actual connections between EUT and support equipment.

### 6.2 SUPPORT EQUIPMENT

No.	Device Type	Brand	Model	Series No.	FCC ID	Data Cable	Power Cord
	N/A						

**Remark:**

1. *All the equipment/cables were placed in the worst-case configuration to maximize the emission during the test.*
2. *Grounding was established in accordance with the manufacturer's requirements and conditions for the intended use.*



## 7. FCC PART 15.247 REQUIREMENTS & RSS 210 REQUIREMENTS

### 7.1 99% BANDWIDTH

#### Test Configuration

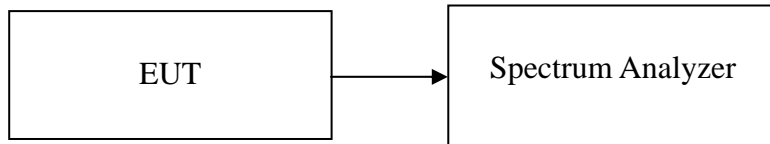

#### TEST PROCEDURE

The resolution bandwidth shall be set to as close to 1% of the selected span as is possible without being below 1%. The video bandwidth shall be set to 3 times the resolution bandwidth. Video averaging is not permitted. Where practical, a sampling detector shall be used since a peak or, peak hold.

#### TEST RESULTS

*No non-compliance noted.*

#### Test Data

##### For GFSK

Channel	Frequency (MHz)	99% Bandwidth (kHz)
Low	2402	867.8944
Mid	2441	891.8481
High	2480	884.0084

##### For 8DPSK

Channel	Frequency (MHz)	99% Bandwidth (MHz)
Low	2402	1.1710
Mid	2441	1.1750
High	2480	1.1745



**Test Plot**

**For GFSK / DH5**

**99% Bandwidth (CH Low)**

Agilent

R L

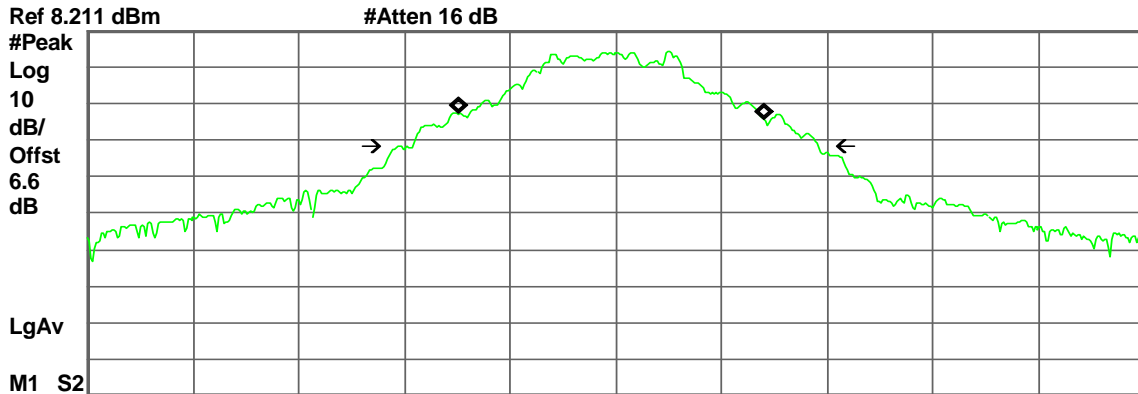

Center 2.402 000 GHz Span 3 MHz  
 #Res BW 30 kHz #VBW 100 kHz Sweep 3.2 ms (601 pts)

Occupied Bandwidth

867.8944 kHz

Occ BW % Pwr 99.00 %  
 x dB -26.00 dB

Transmit Freq Error -13.198 kHz  
 x dB Bandwidth 1.195 MHz

**99% Bandwidth (CH Mid)**

Agilent

R L

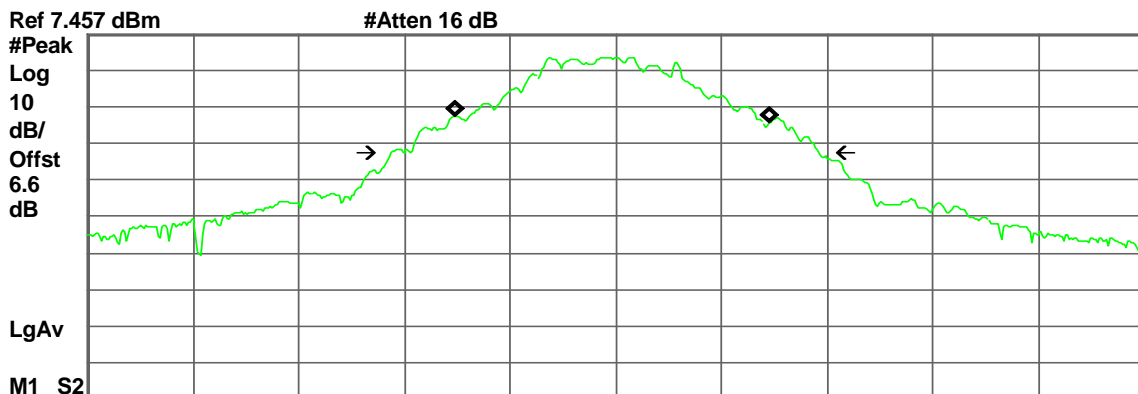

Center 2.441 000 GHz Span 3 MHz  
 #Res BW 30 kHz #VBW 100 kHz Sweep 3.2 ms (601 pts)

Occupied Bandwidth

891.8481 kHz

Occ BW % Pwr 99.00 %  
 x dB -26.00 dB

Transmit Freq Error -10.380 kHz  
 x dB Bandwidth 1.210 MHz



### 99% Bandwidth (CH High)

Agilent

R L

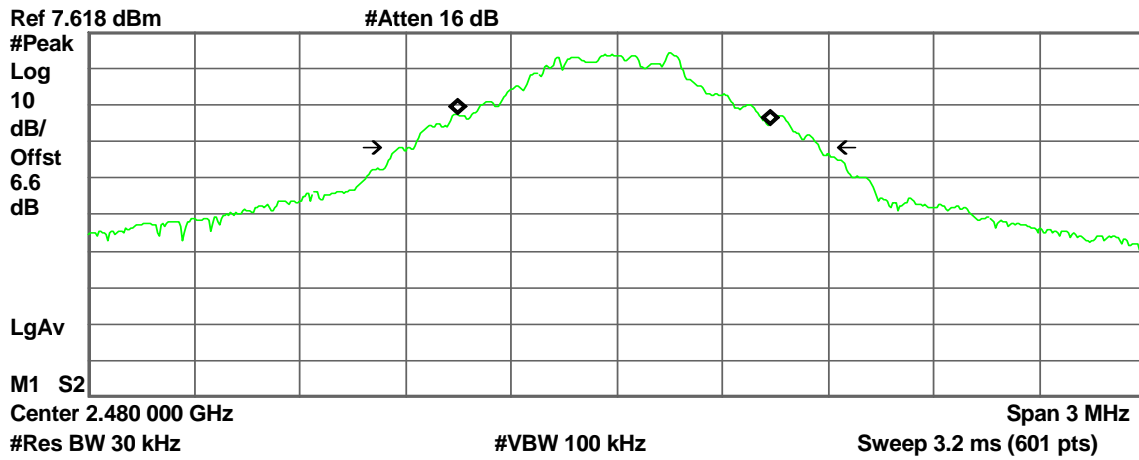

Occupied Bandwidth  
884.0084 kHz

Occ BW % Pwr 99.00 %  
x dB -26.00 dB

Transmit Freq Error -9.352 kHz  
x dB Bandwidth 1.192 MHz





### For 8DPSK / DH5

### 99% Bandwidth (CH Low)

Agilent

R L

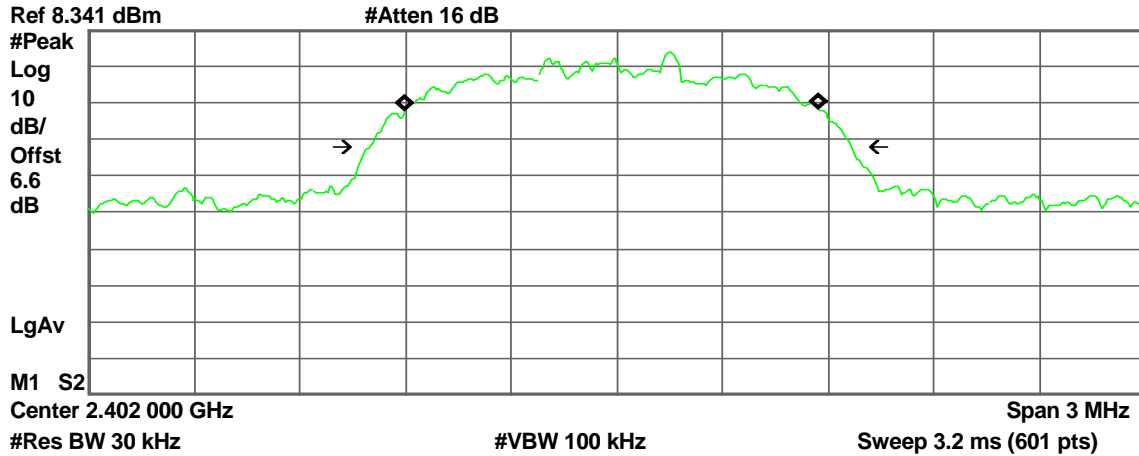

Occupied Bandwidth  
1.1710 MHz

Occ BW % Pwr 99.00 %  
x dB -26.00 dB

Transmit Freq Error -15.826 kHz  
x dB Bandwidth 1.372 MHz

### 99% Bandwidth (CH Mid)

Agilent

R L

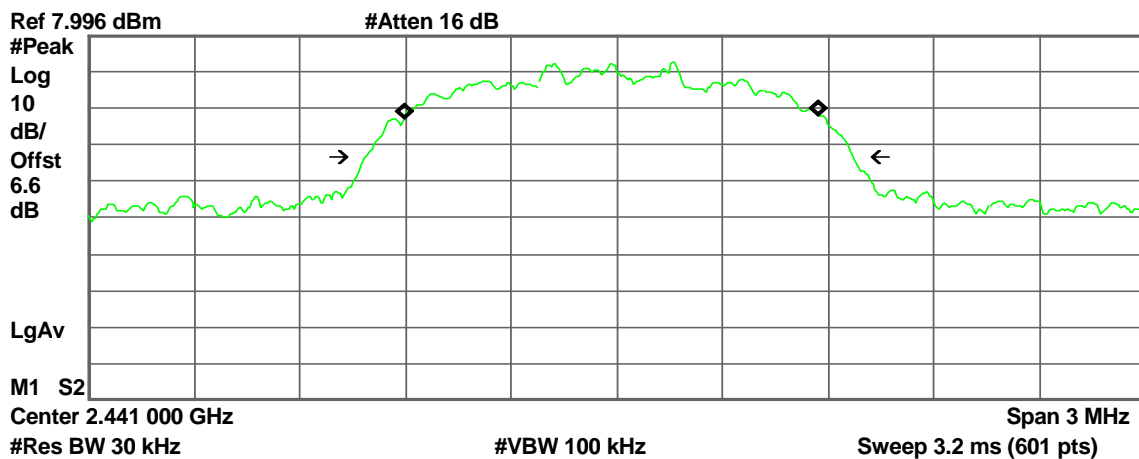

Occupied Bandwidth  
1.1750 MHz

Occ BW % Pwr 99.00 %  
x dB -26.00 dB

Transmit Freq Error -16.669 kHz  
x dB Bandwidth 1.389 MHz



### 99% Bandwidth (CH High)

Agilent

R L

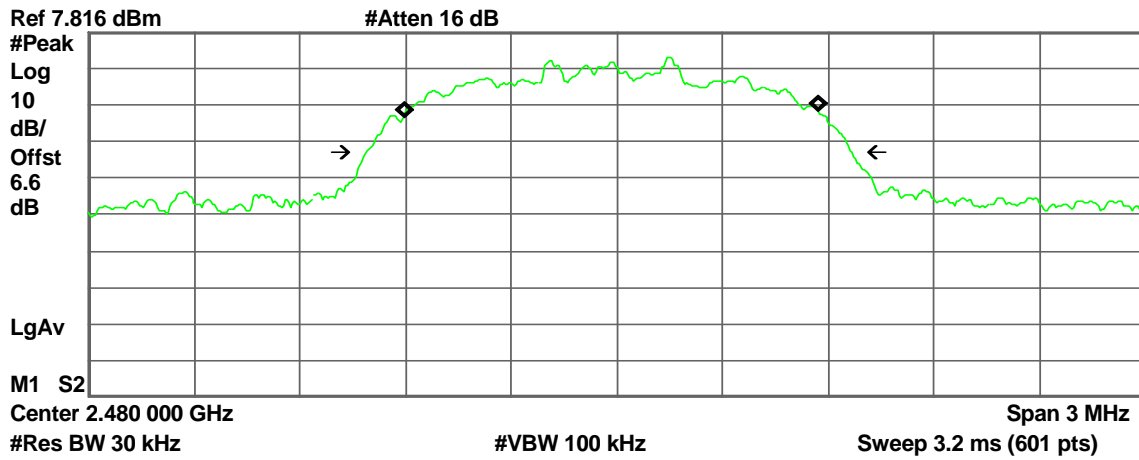

Occupied Bandwidth  
1.1745 MHz

Occ BW % Pwr 99.00 %  
x dB -26.00 dB

Transmit Freq Error -18.673 kHz  
x dB Bandwidth 1.378 MHz



## 7.2 20 DB BANDWIDTH

### LIMIT

None; for reporting purposes only.

### Test Configuration

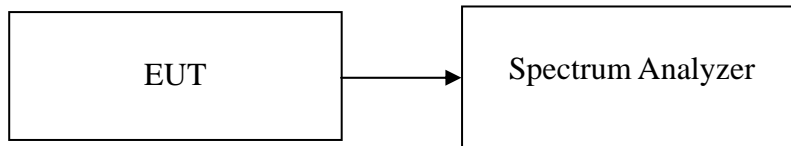

### TEST PROCEDURE

1. Place the EUT on the table and set it in the transmitting mode.
2. Remove the antenna from the EUT and then connect a low loss RF cable from the antenna port to the spectrum analyzer.
3. Set the spectrum analyzer as RBW=30 kHz, VBW = 100 kHz, Sweep = 3.2 ms.
4. Mark the peak frequency and 20dB (upper and lower) frequency.
5. Repeat until all the rest channels are investigated.

### TEST RESULTS

*No non-compliance noted.*

#### Test Data

##### **For GFSK / DH5**

Channel	Frequency (MHz)	20dB Bandwidth (MHz)
Low	2402	1.035
Mid	2441	1.035
High	2480	0.97

##### **For 8DPSK / DH5**

Channel	Frequency (MHz)	20dB Bandwidth (MHz)
Low	2402	1.305
Mid	2441	1.31
High	2480	1.3



**Test Plot**

**For GFSK / DH5**

**20dB Bandwidth (CH Low)**

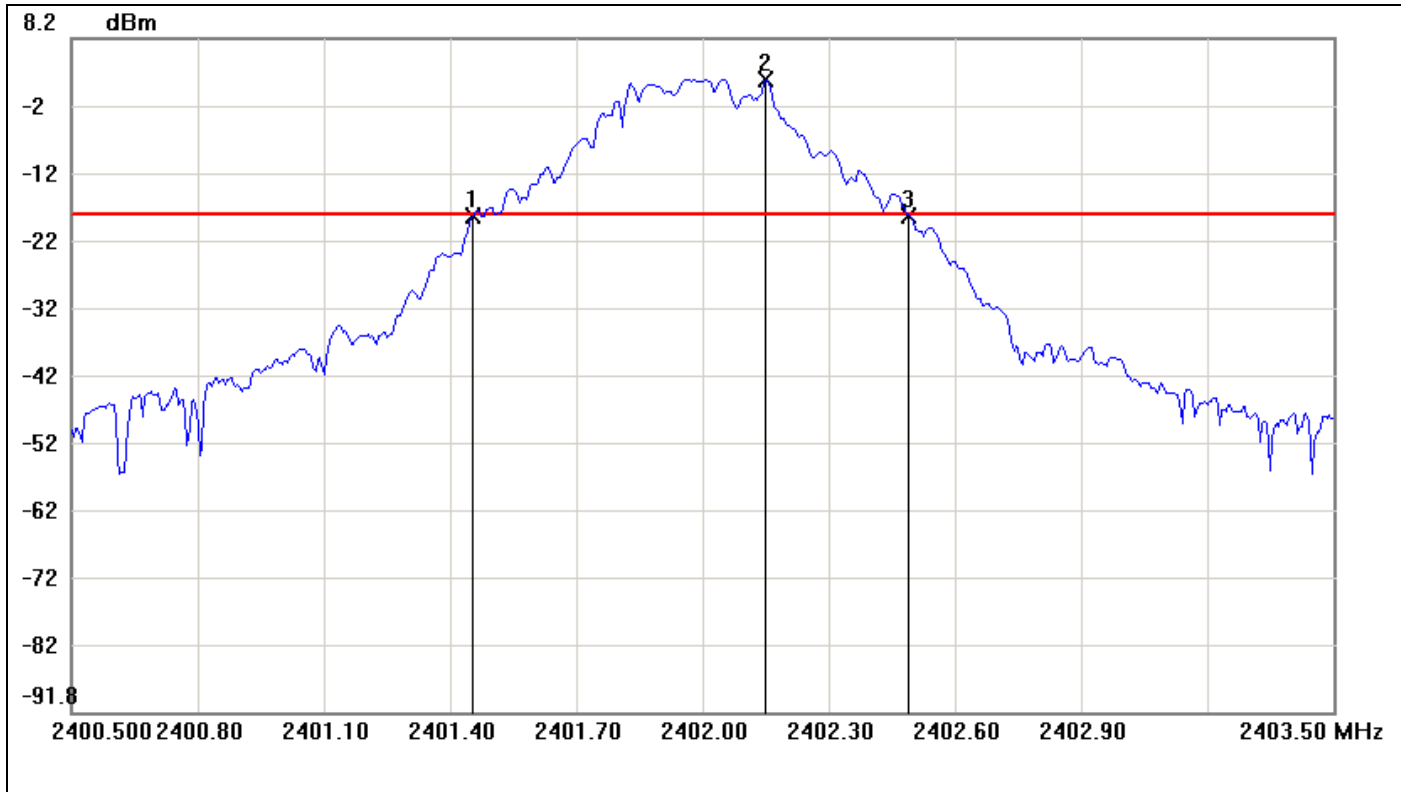

No.	Frequency(MHz)	Result(dBm)	Limit(dBm)	Margin(dBm)
1	2401.4550	-18.06	-17.83	-0.23
2	2402.1500	2.17	-17.83	20.00
3	2402.4900	-18.04	-17.83	-0.21

No.		$\Delta$ Frequency(MHz)	$\Delta$ Level(dB)
1	mk3-mk1	1.035	0.02



20dB Bandwidth (CH Mid)

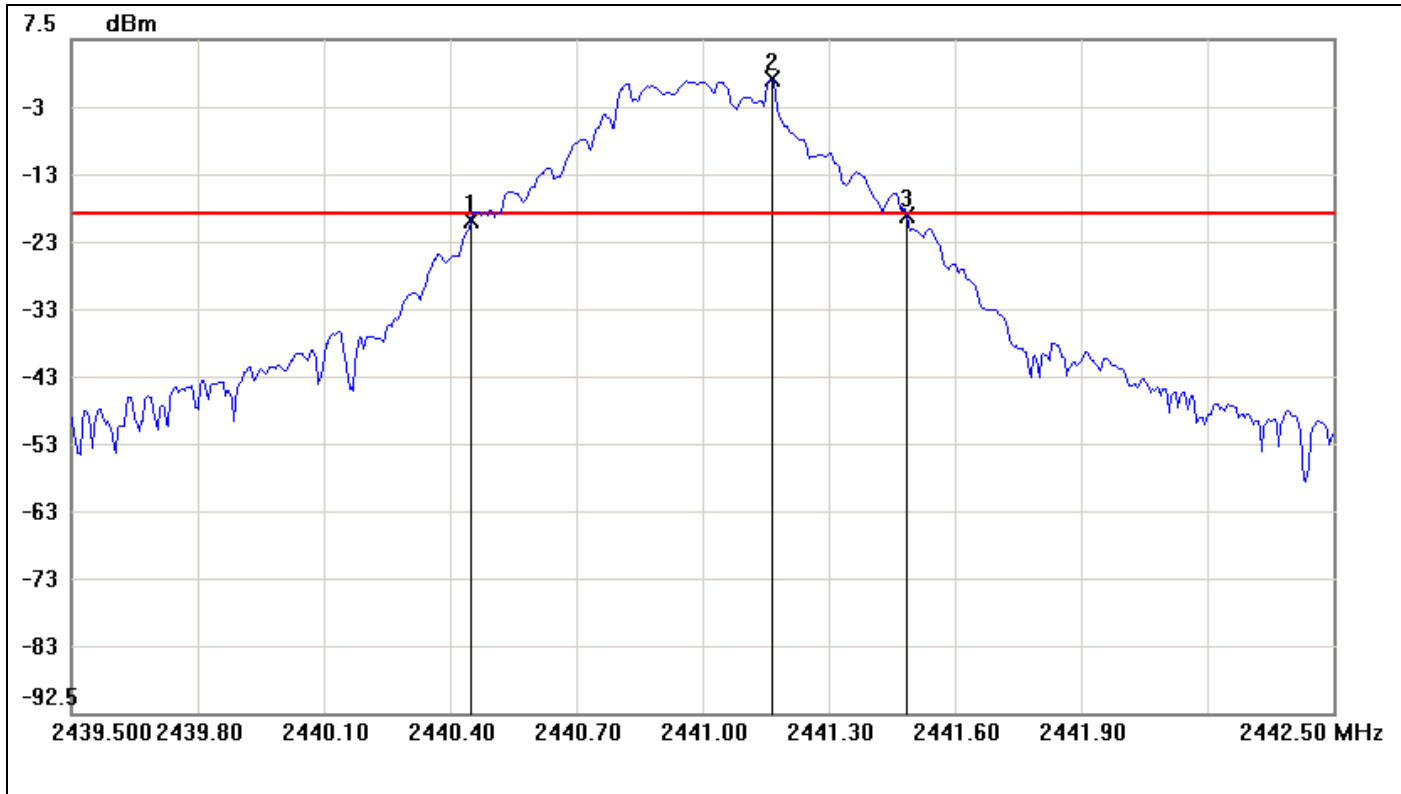

No.	Frequency(MHz)	Result(dBm)	Limit(dBm)	Margin(dBm)
1	2440.4500	-19.47	-18.40	-1.07
2	2441.1650	1.60	-18.40	20.00
3	2441.4850	-18.67	-18.40	-0.27

No.		$\Delta$ Frequency(MHz)	$\Delta$ Level(dB)
1	mk3-mk1	1.035	0.8



20dB Bandwidth (CH High)

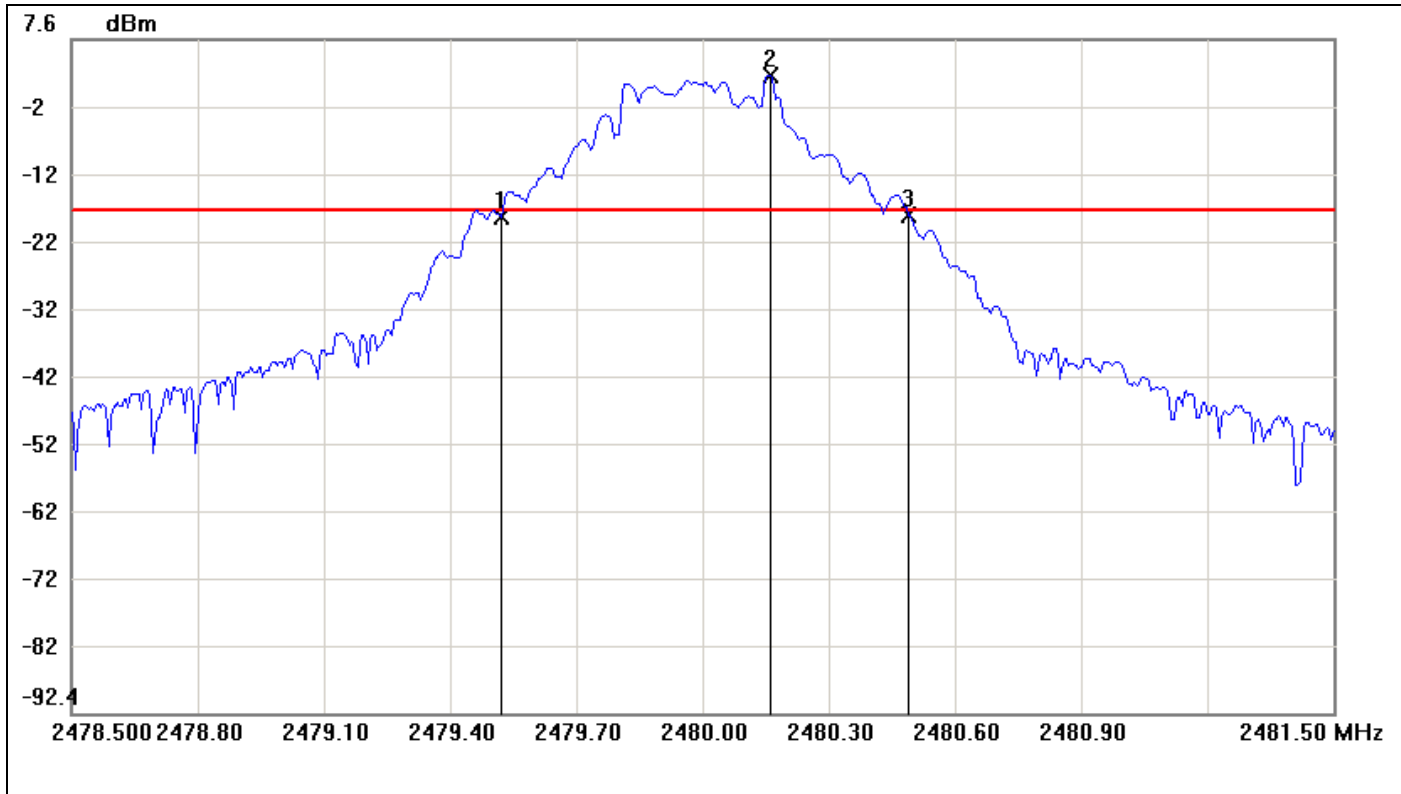

No.	Frequency(MHz)	Result(dBm)	Limit(dBm)	Margin(dBm)
1	2479.5200	-18.77	-17.65	-1.12
2	2480.1600	2.35	-17.65	20.00
3	2480.4900	-18.55	-17.65	-0.90

No.		$\Delta$ Frequency(MHz)	$\Delta$ Level(dB)
1	mk3-mk1	0.97	0.22



For 8DPSK / DH5

20dB Bandwidth (CH Low)

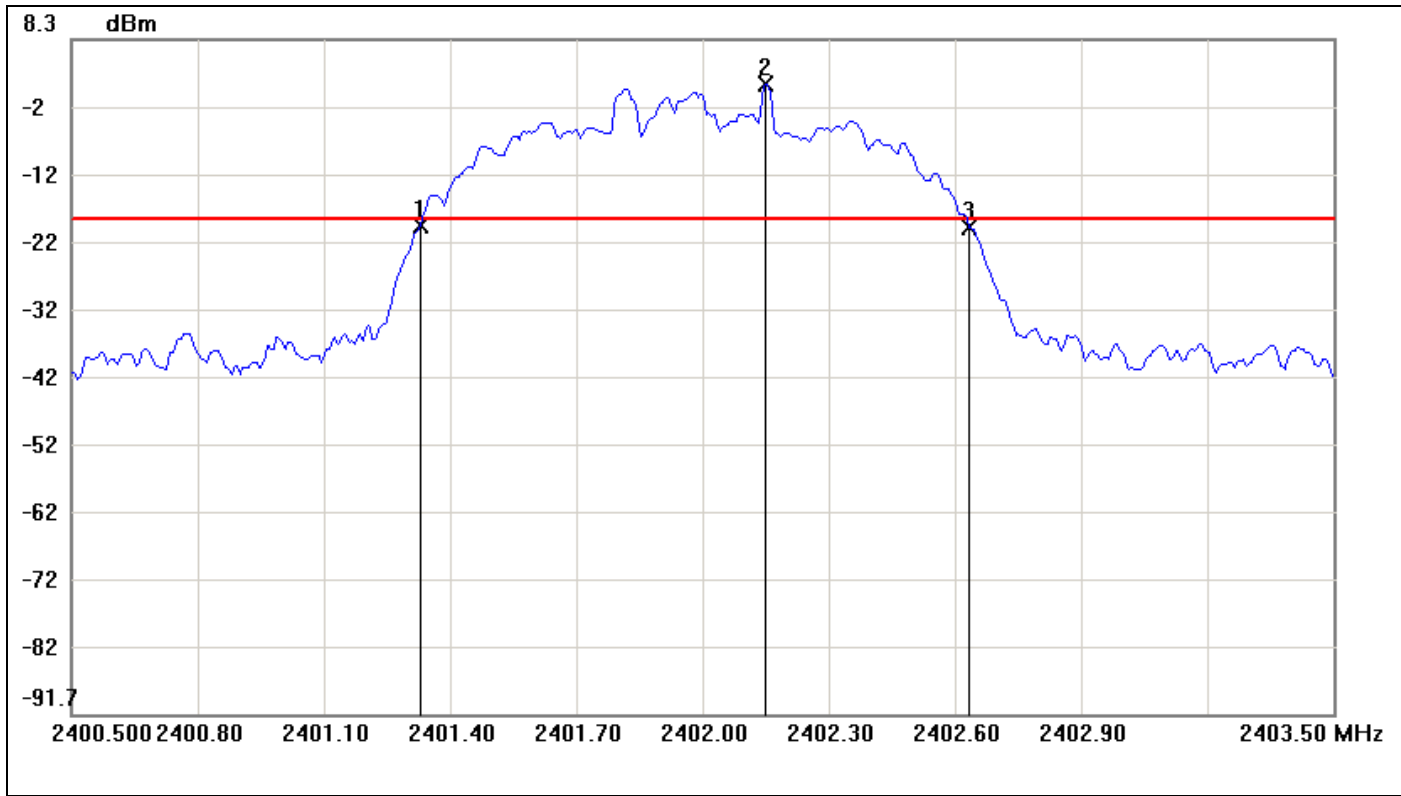

No.	Frequency(MHz)	Result(dBm)	Limit(dBm)	Margin(dBm)
1	2401.3300	-19.36	-18.20	-1.16
2	2402.1500	1.80	-18.20	20.00
3	2402.6350	-19.44	-18.20	-1.24

No.		$\Delta$ Frequency(MHz)	$\Delta$ Level(dB)
1	mk3-mk1	1.305	-0.08



20dB Bandwidth (CH Mid)

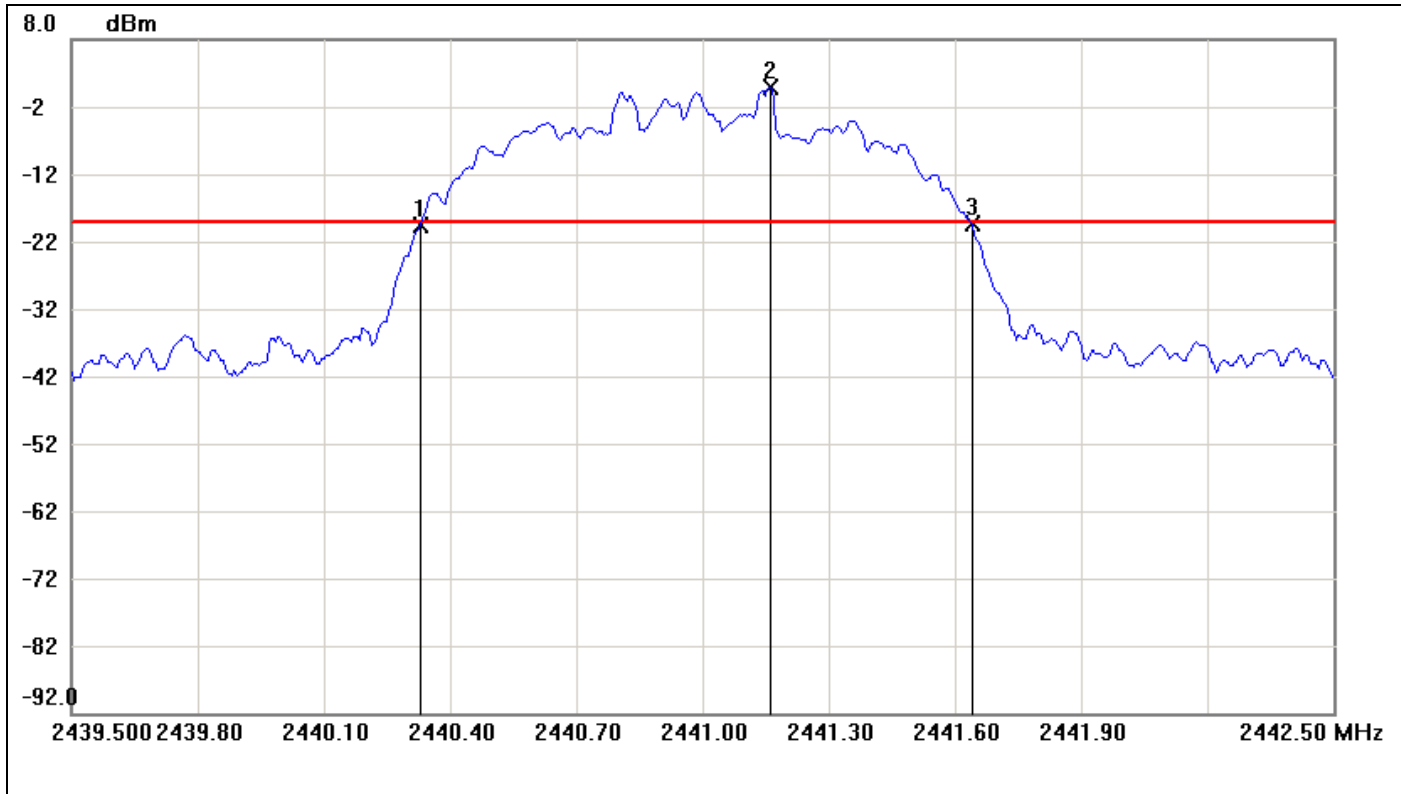

No.	Frequency(MHz)	Result(dBm)	Limit(dBm)	Margin(dBm)
1	2440.3300	-19.58	-19.16	-0.42
2	2441.1600	0.84	-19.16	20.00
3	2441.6400	-19.29	-19.16	-0.13

No.		$\Delta$ Frequency(MHz)	$\Delta$ Level(dB)
1	mk3-mk1	1.31	0.29





**20dB Bandwidth (CH High)**

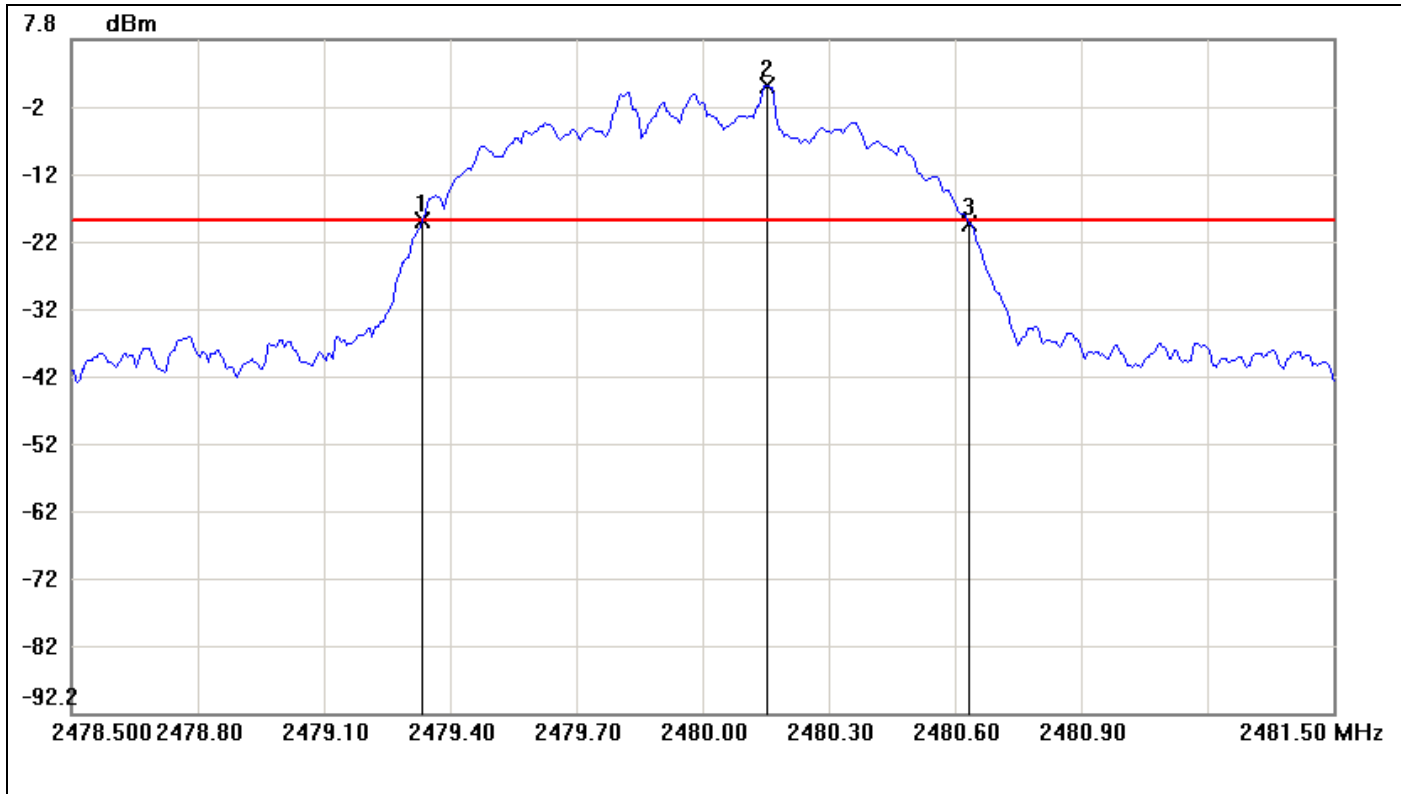

No.	Frequency(MHz)	Result(dBm)	Limit(dBm)	Margin(dBm)
1	2479.3350	-19.04	-18.97	-0.07
2	2480.1550	1.03	-18.97	20.00
3	2480.6350	-19.51	-18.97	-0.54

No.		$\Delta$ Frequency(MHz)	$\Delta$ Level(dB)
1	mk3-mk1	1.3	-0.47



### 7.3 PEAK POWER

#### LIMIT

The maximum peak output power of the intentional radiator shall not exceed the following:

1. According to §15.247(a)(1) & RSS-210 §A8.4(2), Frequency hopping systems shall have hopping channel carrier frequencies separated by a minimum of 25 kHz or the 20 dB bandwidth of the hopping channel, whichever is greater. Alternatively, frequency hopping systems operating in the 2400-2483.5 MHz band may have hopping channel carrier frequencies that are separated by 25 kHz or two-thirds of the 20 dB bandwidth of the hopping channel, whichever is greater, provided the systems operate with an output power no greater than 125 mW.
2. According to §15.247(b)(3) & RSS 210 §A8.4(4), for systems using digital modulation in the bands of 902-928 MHz, 2400-2483.5 MHz, and 5725-5850 MHz: 1 Watt.

#### Test Configuration

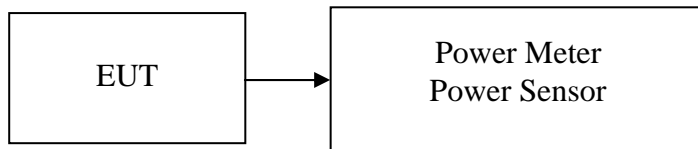

#### TEST PROCEDURE

The transmitter output is connected to the Power Meter. The Power Meter is set to the peak power detection.

#### TEST RESULTS

*No non-compliance noted.*

#### Test Data

##### **For GFSK / DH5**

Channel	Frequency (MHz)	Output Power (dBm)	Output Power (W)	Limit (W)	Result
Low	2402	4.81	0.0030	0.125	PASS
Mid	2441	4.46	0.0028		PASS
High	2480	4.27	0.0027		PASS

##### **For 8DPSK / DH5**

Channel	Frequency (MHz)	Output Power (dBm)	Output Power (W)	Limit (W)	Result
Low	2402	6.38	0.0043	0.125	PASS
Mid	2441	6.03	0.0040		PASS
High	2480	5.86	0.0039		PASS



### 7.4 AVERAGE POWER

#### LIMIT

None; for reporting purposes only.

#### Test Configuration

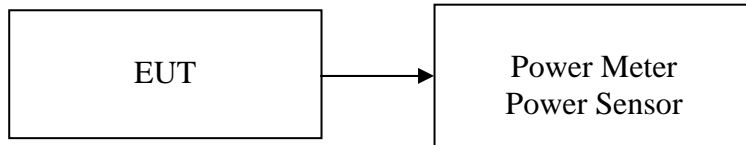

#### TEST PROCEDURE

The transmitter output is connected to the Power Meter. The Power Meter is set to the Average power detection.

#### TEST RESULTS

*No non-compliance noted*

##### Test Data

##### **For GFSK / DH5**

Channel	Frequency (MHz)	Output Power (dBm)	Output Power (W)	Limit (W)	Result
Low	2402	3.46	0.0022	0.125	PASS
Mid	2441	3.03	0.0020		PASS
High	2480	2.75	0.0019		PASS

##### **For 8DPSK / DH5**

Channel	Frequency (MHz)	Output Power (dBm)	Output Power (W)	Limit (W)	Result
Low	2402	2.68	0.0019	0.125	PASS
Mid	2441	2.24	0.0017		PASS
High	2480	1.97	0.0016		PASS



## **7.5 BAND EDGES MEASUREMENT**

### **LIMIT**

According to §15.247(d), in any 100 kHz bandwidth outside the frequency band in which the spread spectrum or digitally modulated intentional radiator is operating, the radio frequency power that is produced by the intentional radiator shall be at least 20 dB below that in the 100 kHz bandwidth within the band that contains the highest level of the desired power, based on either an RF conducted or a radiated measurement, provided the transmitter demonstrates compliance with the peak conducted power limits. If the transmitter complies with the conducted power limits based on the use of RMS averaging over a time interval, as permitted under paragraph (b)(3) of this section, the attenuation required under this paragraph shall be 30 dB instead of 20 dB. Attenuation below the general limits specified in §15.209(a) is not required. In addition, radiated emissions which fall in the restricted bands, as defined in §15.205(a), must also comply with the radiated emission limits specified in §15.209(a) (see §15.205(c)).

According to RSS-210 §A8.5, in any 100 kHz bandwidth outside the frequency band in which the spread spectrum or digitally modulated device is operating, the radio frequency power that is produced shall be at least 20 dB below that in the 100 kHz bandwidth within the band that contains the highest level of the desired power, based on either an RF conducted or a radiated measurement, provided the transmitter demonstrates compliance with the peak conducted power limits. If the transmitter complies with the conducted power limits based on the use of RMS averaging over a time interval, as permitted under section A8.4(4), the attenuation required shall be 30 dB instead of 20 dB. Attenuation below the general limits specified in Tables 2 and 3 is not required. In addition, radiated emissions which fall in the restricted bands of Table 1 must also comply with the radiated emission limits specified in Tables 2 and 3.



### Test Configuration

#### For Radiated

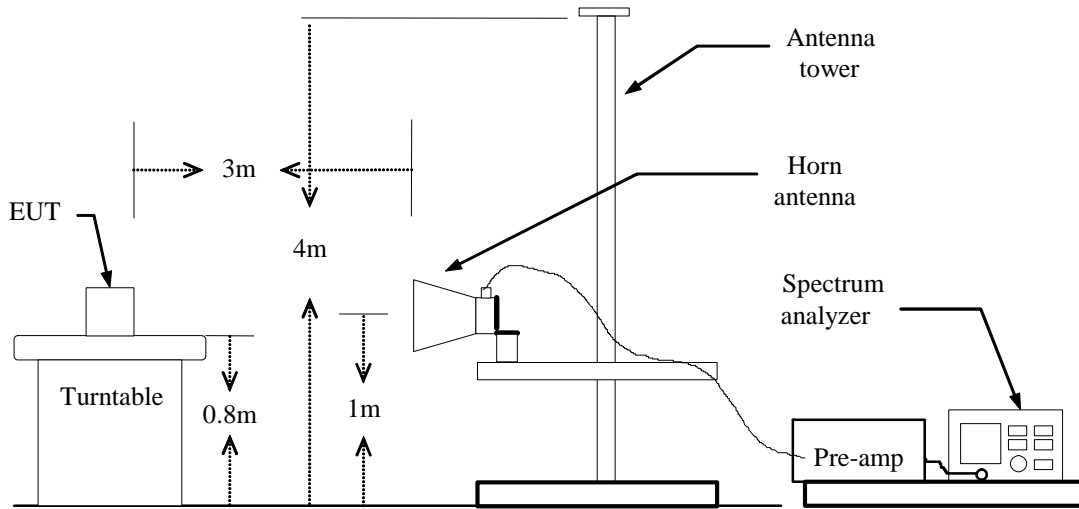

#### For Conducted

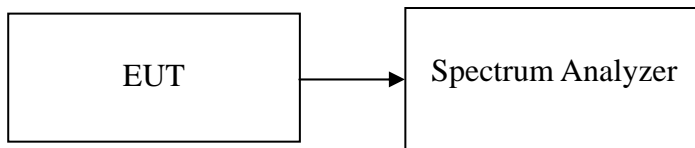



## **TEST PROCEDURE**

### **For Radiated**

1. The EUT is placed on a turntable, which is 0.8m above the ground plane.
2. The turntable shall be rotated for 360 degrees to determine the position of maximum emission level.
3. EUT is set 3m away from the receiving antenna, which is varied from 1m to 4m to find out the highest emission.
4. Set the spectrum analyzer in the following setting in order to capture the lower and upper band-edges of the emission:
  - (a) PEAK: RBW=1MHz / VBW=3MHz / Sweep=AUTO
  - (b) AVERAGE: RBW=1MHz / VBW=300Hz / Sweep=AUTO
5. Repeat the procedures until all the PEAK and AVERAGE versus POLARIZATION are measured.

### **For Conducted**

Conducted RF measurements of the transmitter output were made to confirm that the EUT antenna port conducted emissions meet the specified limit and to identify any spurious signals that require further investigation or measurements on the radiated emissions site.

The transmitter output is connected to the spectrum analyzer. The resolution bandwidth is set to 300 kHz. The video bandwidth is set to 300 kHz.

## **TEST RESULTS**

Refer to attach spectrum analyzer data chart.



For GFSK / DH5

Band Edges (CH Low)

Detector mode: Peak

Polarity: Vertical

Agilent

R T

Mkr1 2.386 16 GHz  
48.44 dBµV/m

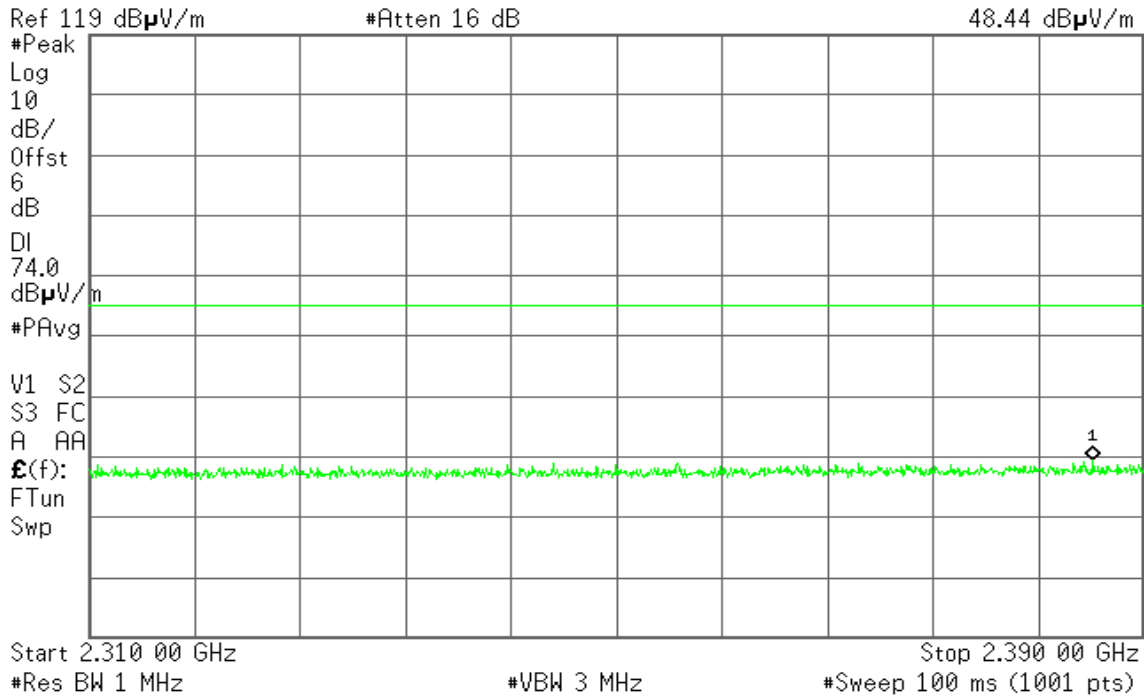

Detector mode: Average

Polarity: Vertical

Agilent

R T

Mkr1 2.390 00 GHz  
36.70 dBµV/m

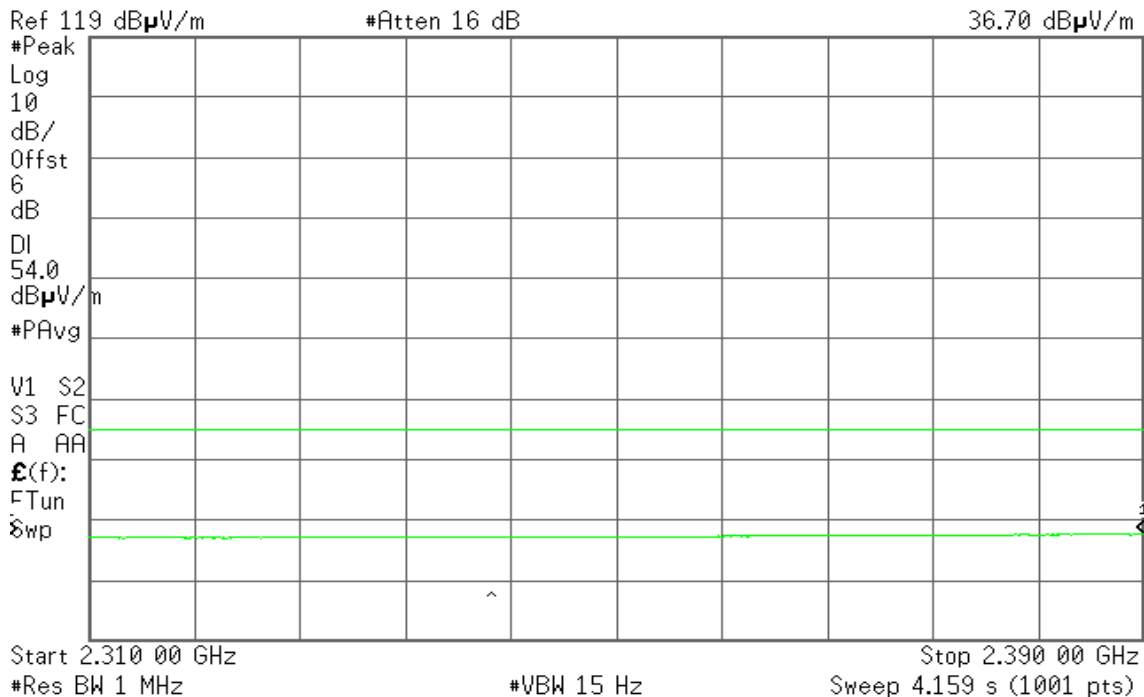



Detector mode: Peak

Polarity: Horizontal

Agilent

R T

Mkr1 2.362 08 GHz  
53.99 dB $\mu$ V/m

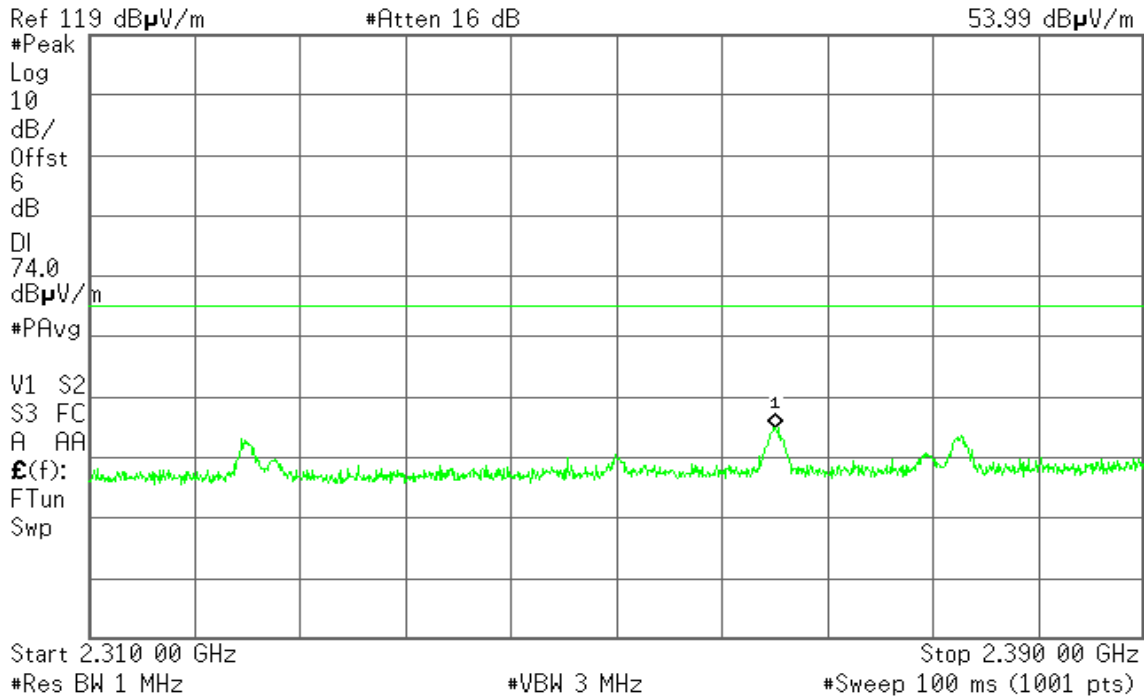

Detector mode: Average

Polarity: Horizontal

Agilent

R T

Mkr1 2.362 00 GHz  
48.21 dB $\mu$ V/m

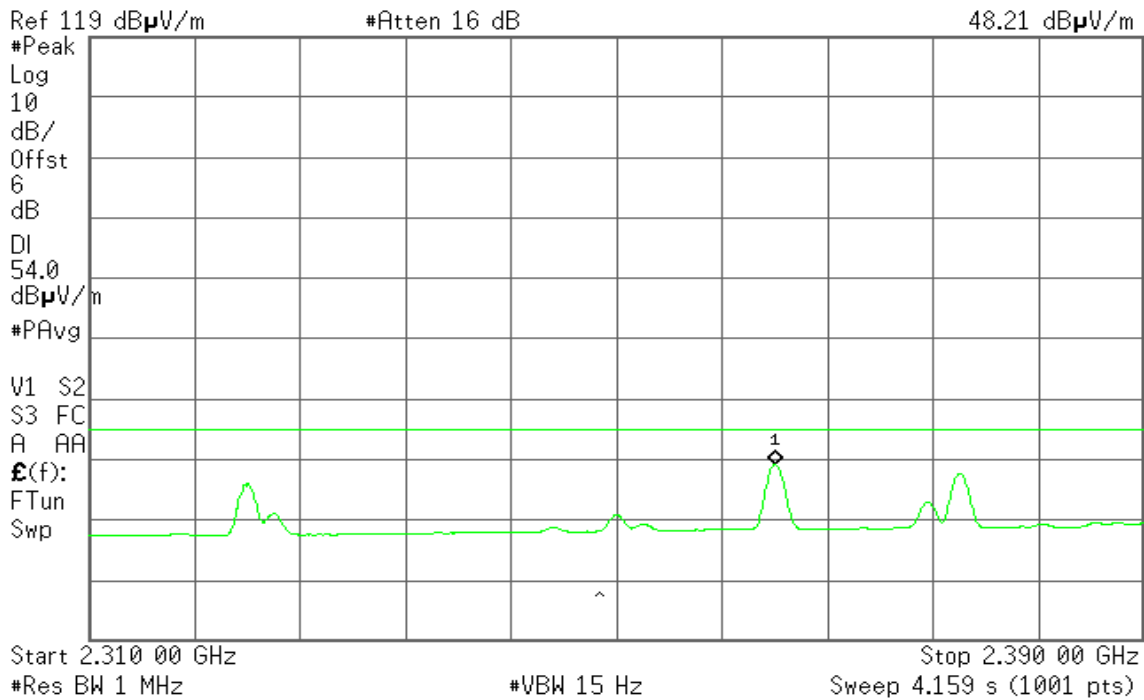





Band Edges (CH High)

Detector mode: Peak

Polarity: Vertical

Agilent

R T

Mkr1 2.488 76 GHz

49.82 dBµV/m

Ref 119 dBµV/m

#Atten 16 dB

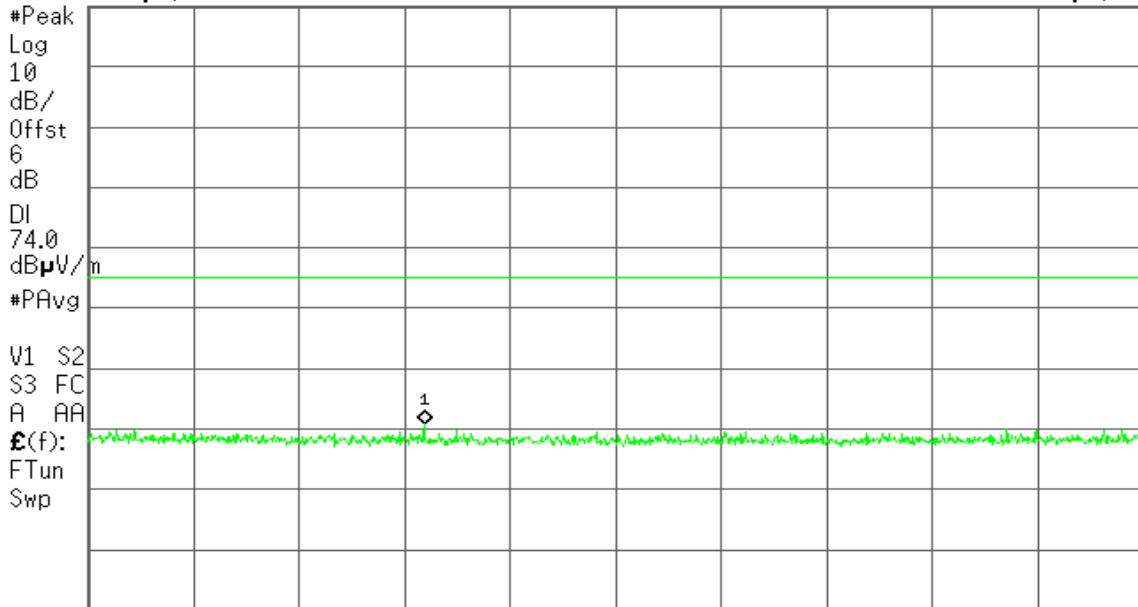

Start 2.483 50 GHz

#Res BW 1 MHz

#VBW 3 MHz

Stop 2.500 00 GHz

#Sweep 100 ms (1001 pts)

Detector mode: Average

Polarity: Vertical

Agilent

R T

Mkr1 2.483 50 GHz

37.70 dBµV/m

Ref 119 dBµV/m

#Atten 16 dB



Start 2.483 50 GHz

#Res BW 1 MHz

#VBW 15 Hz

Stop 2.500 00 GHz

Sweep 857.7 ms (1001 pts)



Detector mode: Peak

Polarity: Horizontal

Agilent

R T

Mkr1 2.483 90 GHz  
51.06 dBµV/m

Ref 119 dBµV/m

#Atten 16 dB

#Peak

Log

10

dB/

Offst

6

dB

DI

74.0

dBµV/m

#PAvg

V1 S2

S3 FC

A AA

£(f):

FTun

Swp

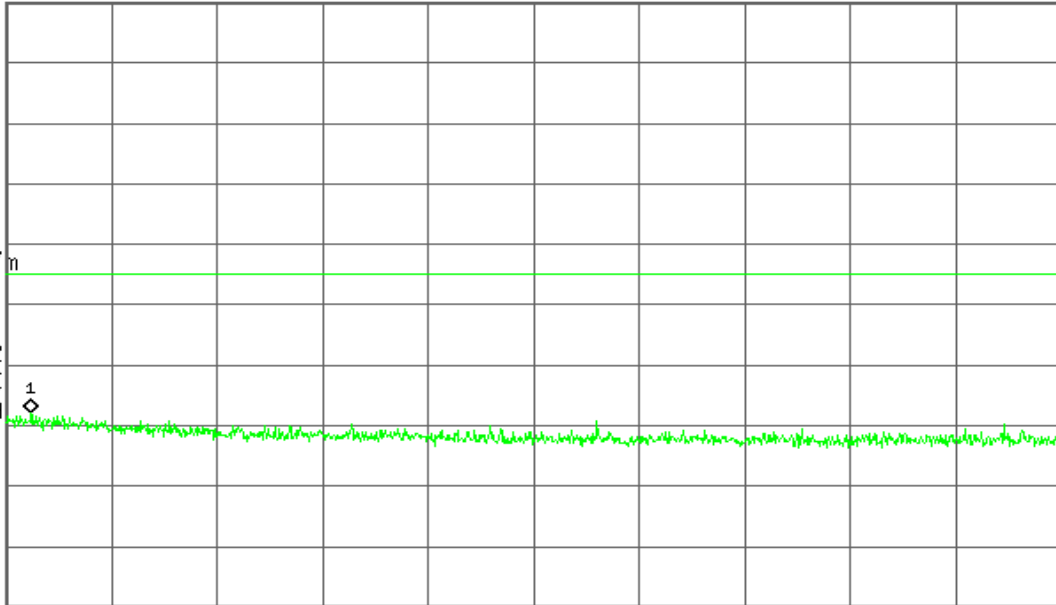

Start 2.483 50 GHz

#Res BW 1 MHz

#VBW 3 MHz

Stop 2.500 00 GHz

#Sweep 100 ms (1001 pts)

Detector mode: Average

Polarity: Horizontal

Agilent

R T

Mkr1 2.483 50 GHz  
41.02 dBµV/m

Ref 119 dBµV/m

#Atten 16 dB

#Peak

Log

10

dB/

Offst

6

dB

DI

54.0

dBµV/m

#PAvg

M1 S2

S3 FC

A AA

£(f):

FTun

Swp



Start 2.483 50 GHz

#Res BW 1 MHz

#VBW 15 Hz

Stop 2.500 00 GHz

Sweep 857.7 ms (1001 pts)



For 8DPSK / DH5

Band Edges (CH Low)

Detector mode: Peak

Polarity: Vertical

Agilent

R T

Mkr1 2.322 88 GHz  
49.65 dBµV/m

Ref 119 dBµV/m

#Atten 16 dB

#Peak

Log

10

dB/

Offst

6

dB

DI

74.0

dBµV/m

#PAvg

V1 S2

S3 FC

A AA

£(f):

FTun

Swp

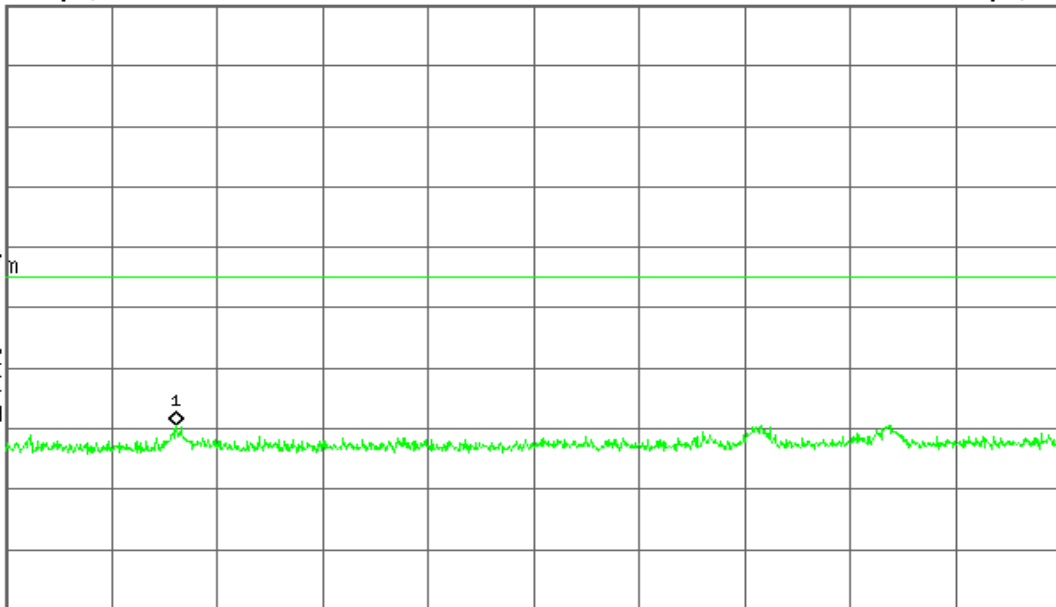

Start 2.310 00 GHz

Stop 2.390 00 GHz

#Res BW 1 MHz

#VBW 3 MHz

#Sweep 100 ms (1001 pts)

Detector mode: Average

Polarity: Vertical

Agilent

R T

Mkr1 2.366 96 GHz  
40.42 dBµV/m

Ref 119 dBµV/m

#Atten 16 dB

#Peak

Log

10

dB/

Offst

6

dB

DI

54.0

dBµV/m

#PAvg

V1 S2

S3 FC

A AA

£(f):

FTun

Swp

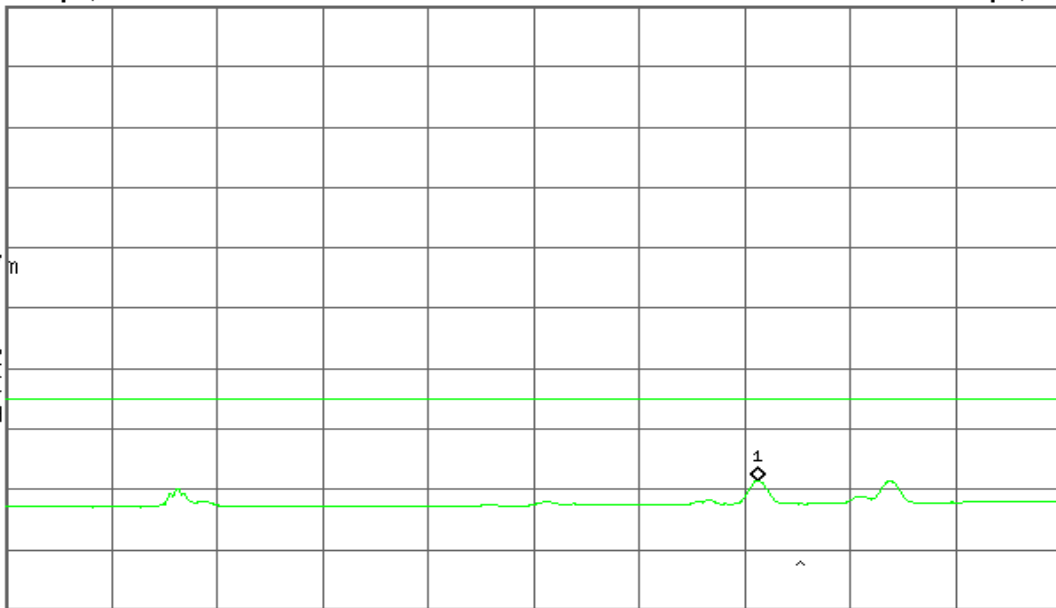

Start 2.310 00 GHz

Stop 2.390 00 GHz

#Res BW 1 MHz

#VBW 15 Hz

Sweep 4.159 s (1001 pts)



Detector mode: Peak

Polarity: Horizontal

Agilent

R T

Mkr1 2.367 36 GHz  
53.47 dBµV/m

Ref 119 dBµV/m

#Atten 16 dB

#Peak

Log

10

dB/

Offst

6

dB

DI

74.0

dBµV/m

#PAvg

V1 S2

S3 FC

A AA

£(f):

FTun

Swp

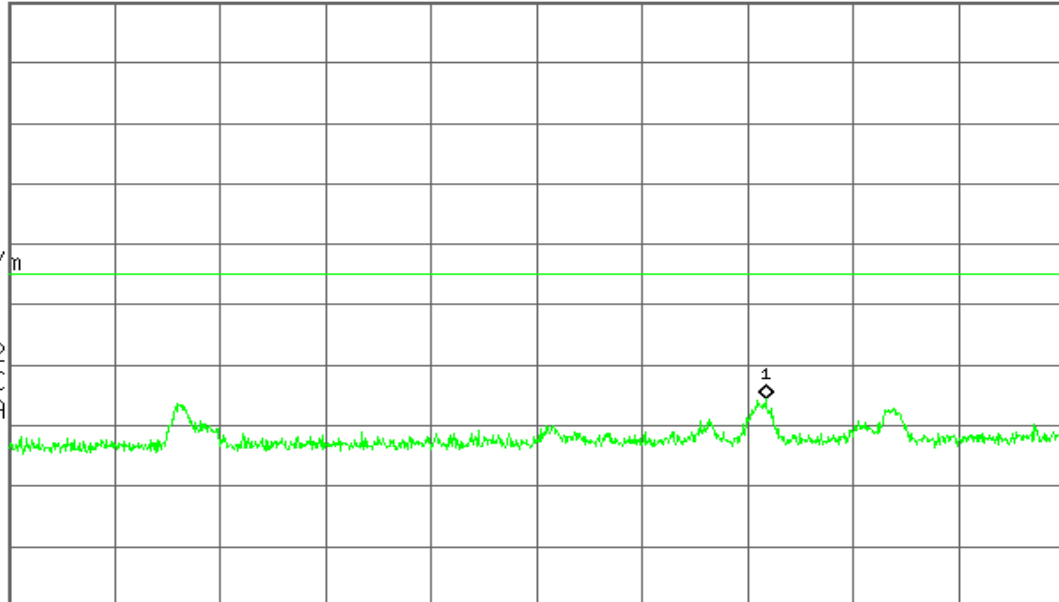

Start 2.310 00 GHz

Stop 2.390 00 GHz

#Res BW 1 MHz

#VBW 3 MHz

#Sweep 100 ms (1001 pts)

Detector mode: Average

Polarity: Horizontal

Agilent

R T

Mkr1 2.367 04 GHz  
46.59 dBµV/m

Ref 119 dBµV/m

#Atten 16 dB

#Peak

Log

10

dB/

Offst

6

dB

DI

54.0

dBµV/m

#PAvg

V1 S2

S3 FC

A AA

£(f):

FTun

Swp

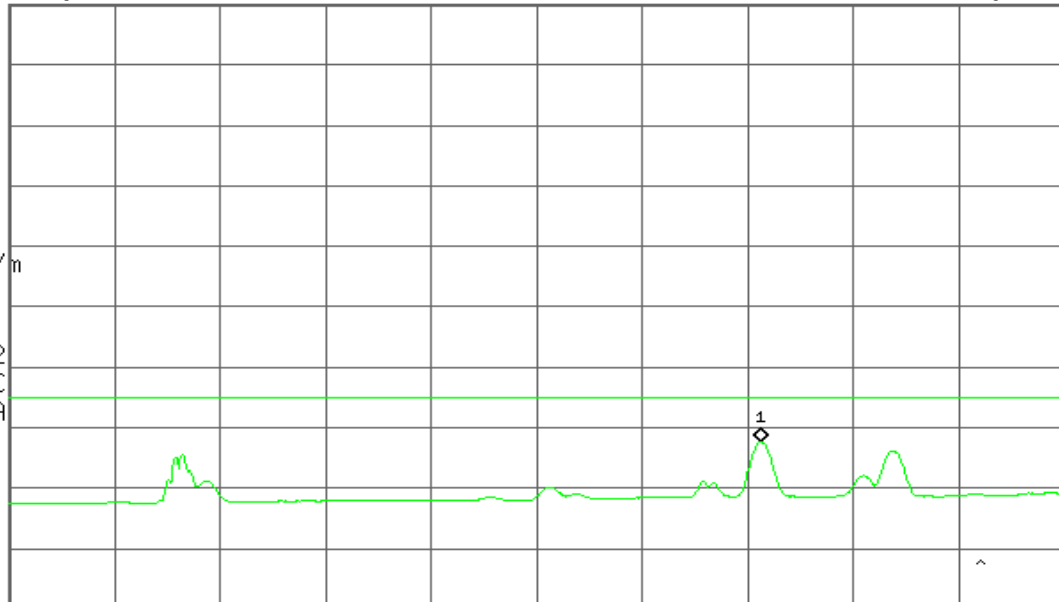

Start 2.310 00 GHz

Stop 2.390 00 GHz

#Res BW 1 MHz

#VBW 15 Hz

Sweep 4.159 s (1001 pts)



### Band Edges (CH High)

Detector mode: Peak

Polarity: Vertical

Agilent

R T

Mkr1 2.483 58 GHz

48.68 dB $\mu$ V/m

Ref 119 dB $\mu$ V/m

#Atten 16 dB

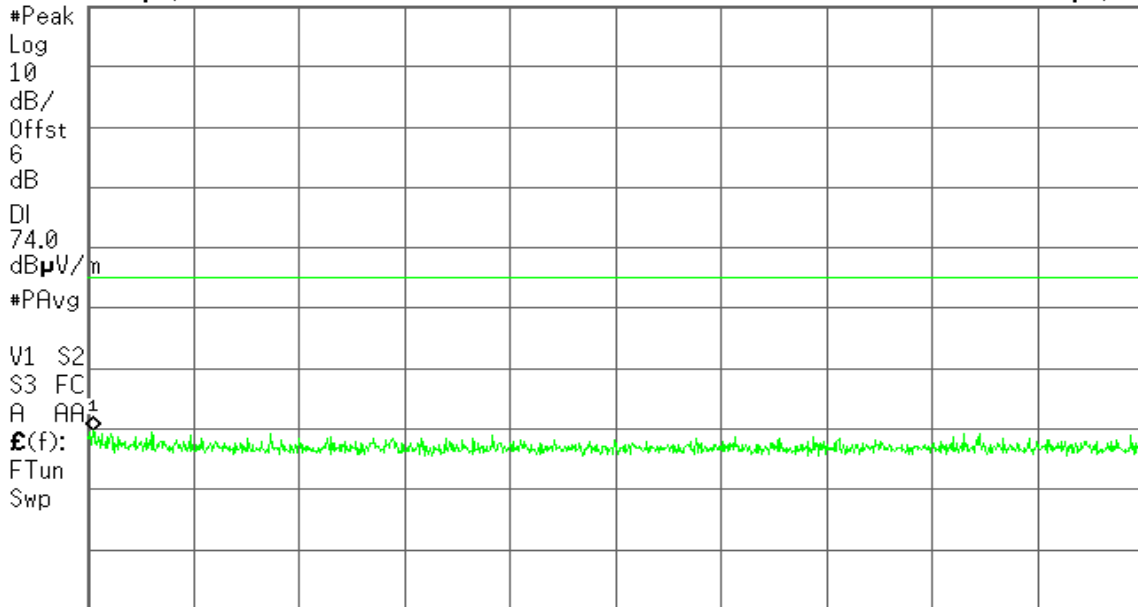

Start 2.483 50 GHz

#Res BW 1 MHz

#VBW 3 MHz

Stop 2.500 00 GHz

#Sweep 100 ms (1001 pts)

### Detector mode: Average

Polarity: Vertical

Agilent

R T

Mkr1 2.483 50 GHz

38.02 dB $\mu$ V/m

Ref 119 dB $\mu$ V/m

#Atten 16 dB



Start 2.483 50 GHz

#Res BW 1 MHz

#VBW 15 Hz

Stop 2.500 00 GHz

#Sweep 874 ms (1001 pts)



Detector mode: Peak

Polarity: Horizontal

Agilent

R T

Mkr1 2.483 52 GHz  
52.43 dBµV/m

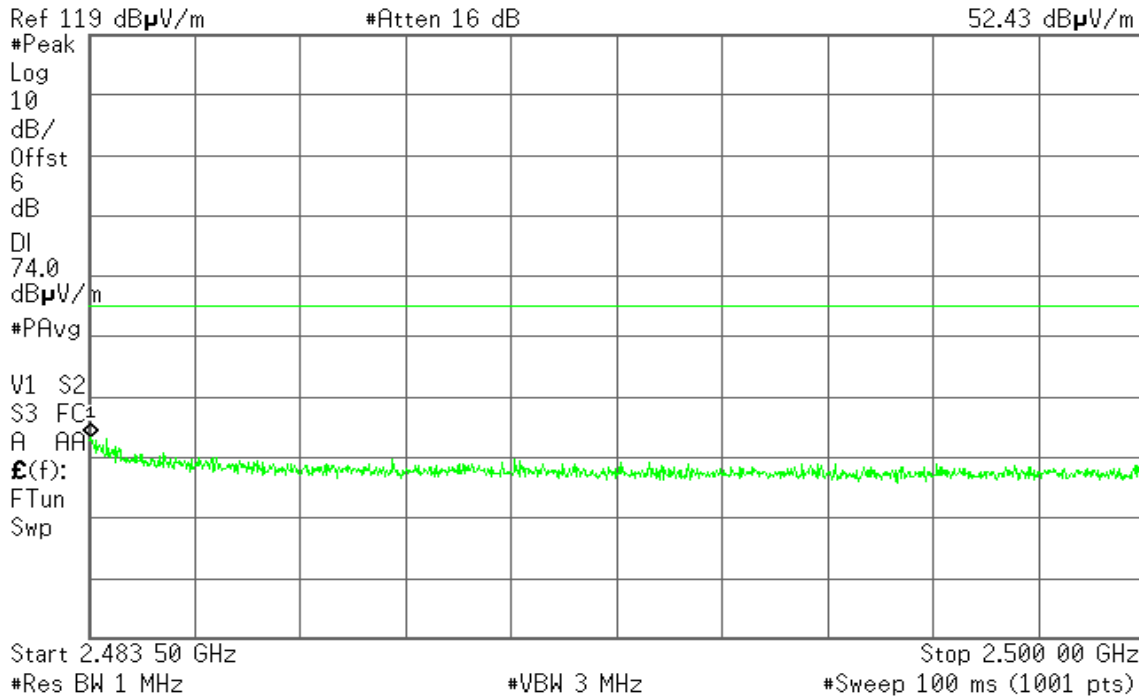

Detector mode: Average

Polarity: Horizontal

Agilent

R T

Mkr1 2.483 50 GHz  
40.82 dBµV/m

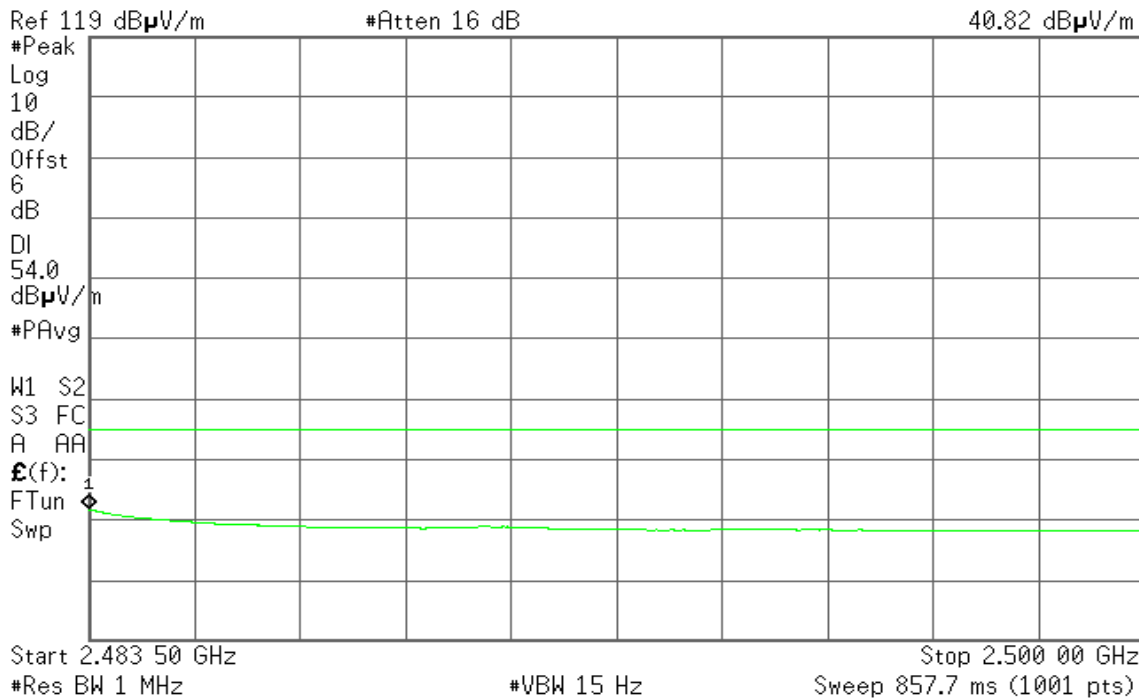



### GFSK

#### Band Edges (CH Low)

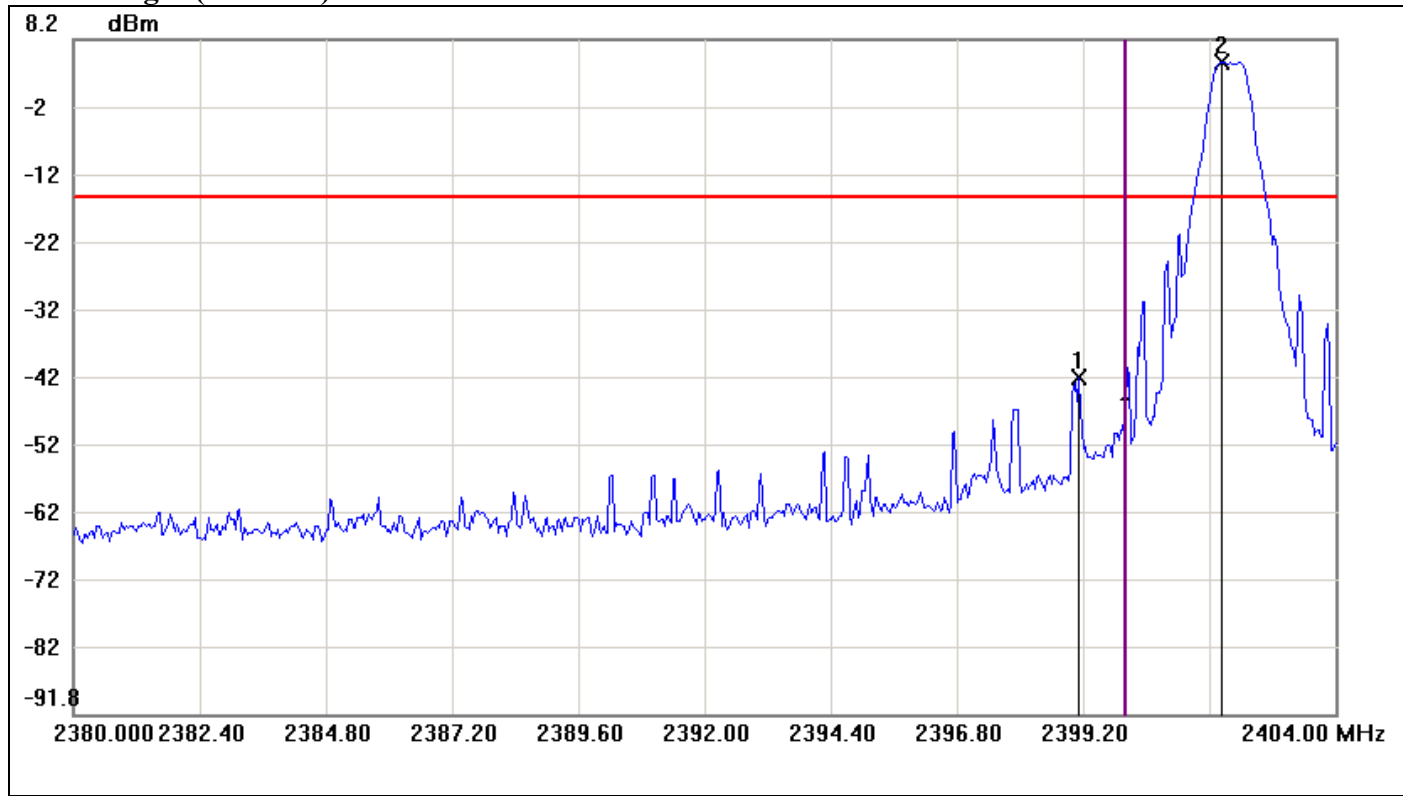

No.	Frequency(MHz)	Result(dBm)	Limit(dBm)	Margin(dBm)
1	2399.1200	-41.87	-15.05	-26.82
2	2401.8400	4.95	-15.05	20.00



**Band Edges (CH High)**

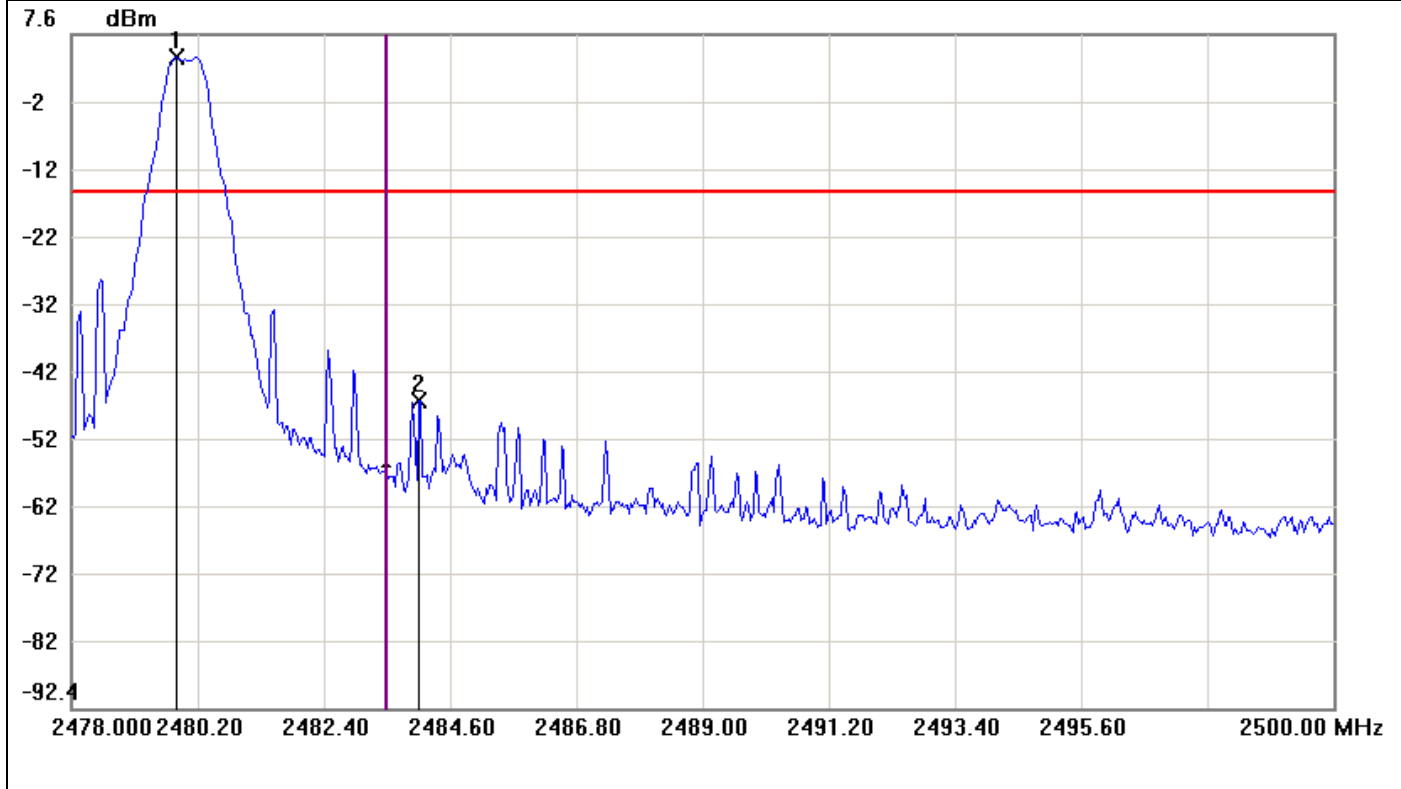

No.	Frequency(MHz)	Result(dBm)	Limit(dBm)	Margin(dBm)
1	2479.8333	4.12	-15.88	20.00
2	2484.0500	-46.87	-15.88	-30.99





### Hopping Mode (CH Low)

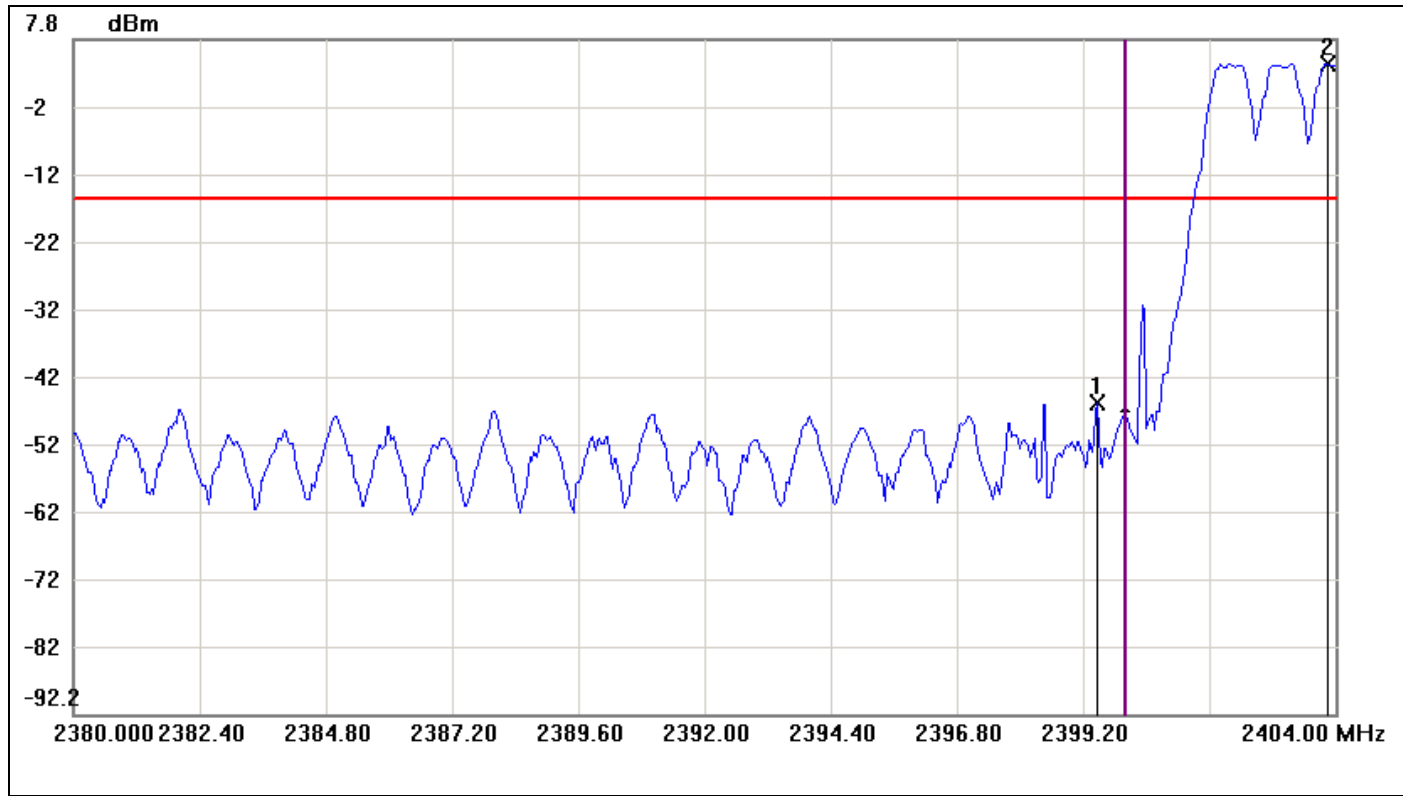

No.	Frequency(MHz)	Result(dBm)	Limit(dBm)	Margin(dBm)
1	2399.4800	-46.13	-15.83	-30.30
2	2403.8400	4.17	-15.83	20.00



(CH High)

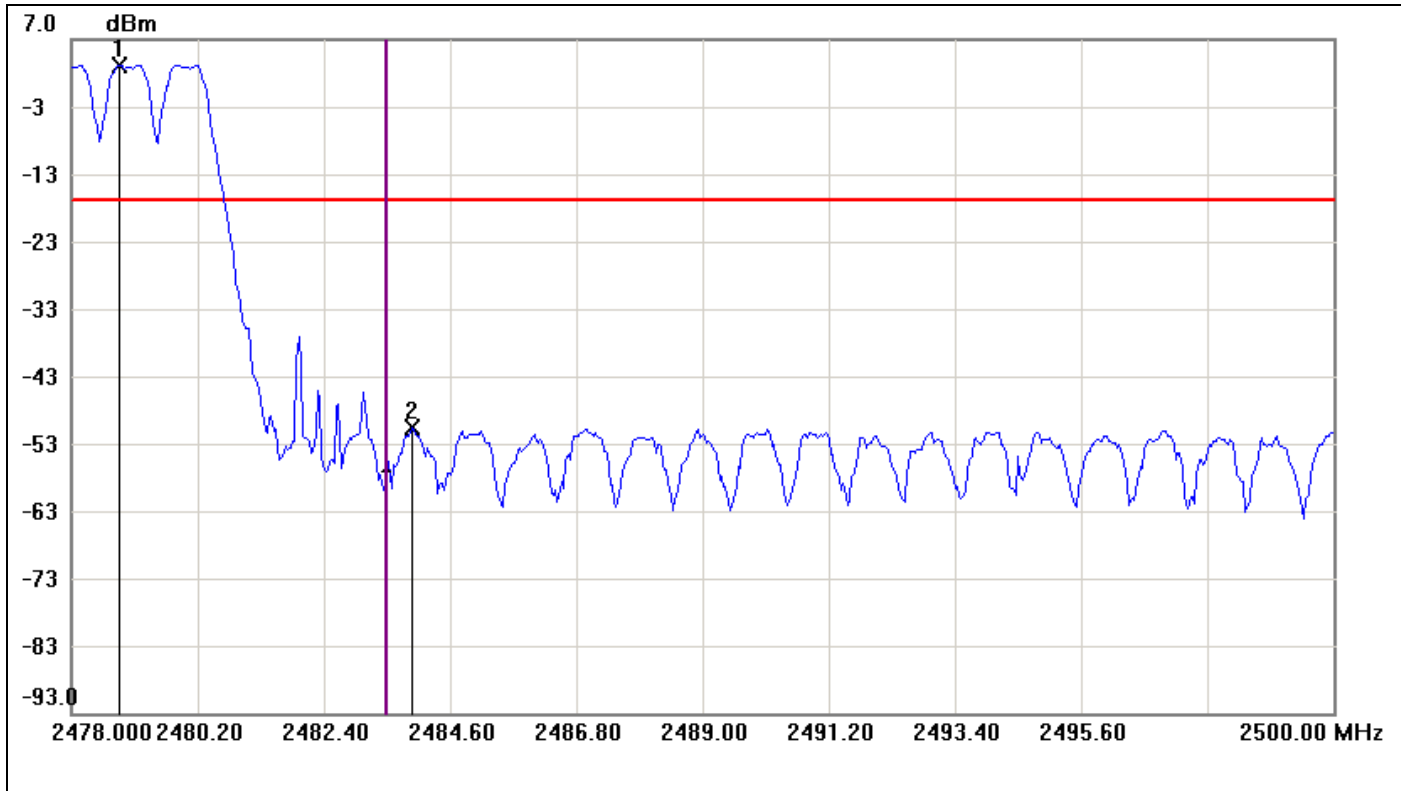

No.	Frequency(MHz)	Result(dBm)	Limit(dBm)	Margin(dBm)
1	2478.8433	3.27	-16.73	20.00
2	2483.9400	-50.58	-16.73	-33.85



### 8DPSK

#### Band Edges (CH Low)

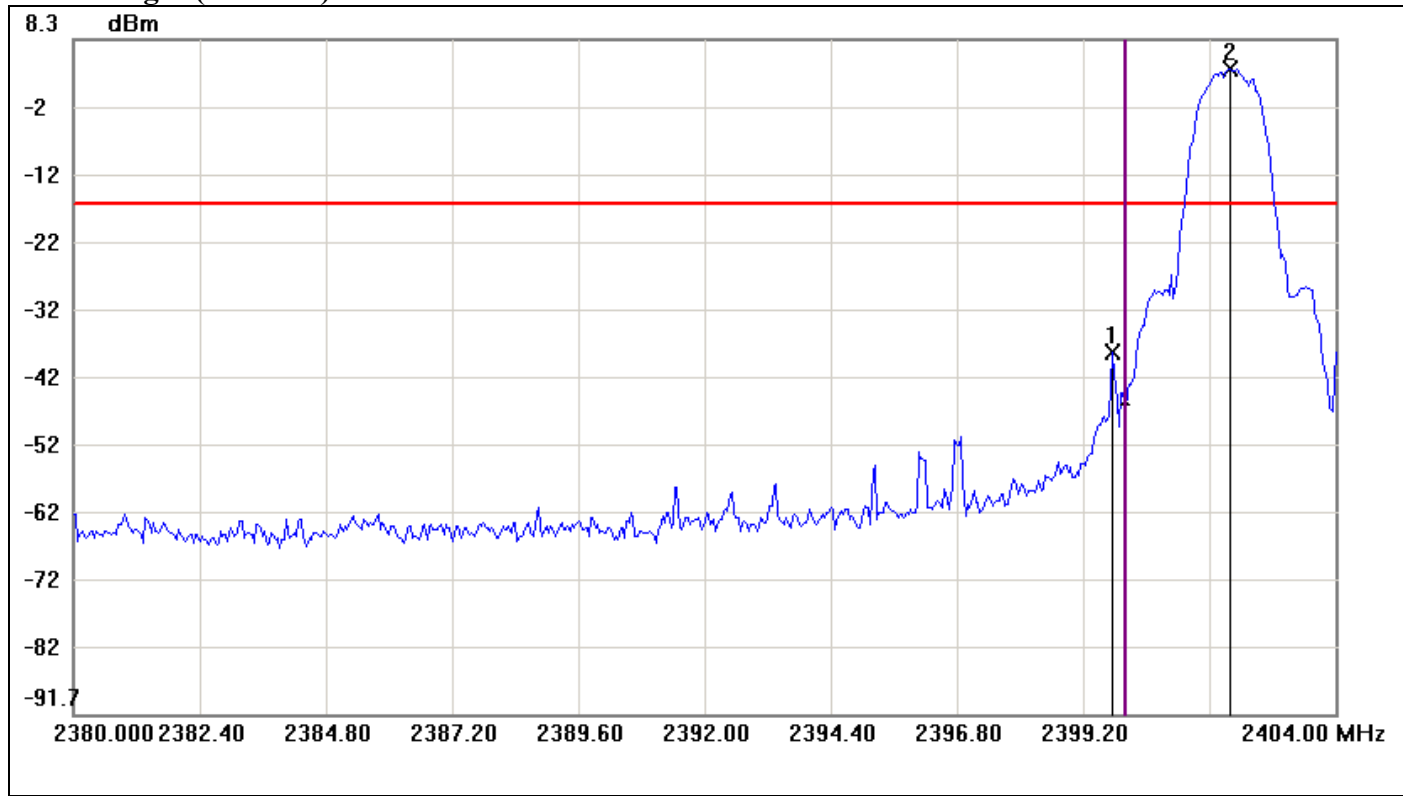

No.	Frequency(MHz)	Result(dBm)	Limit(dBm)	Margin(dBm)
1	2399.7600	-38.21	-16.13	-22.08
2	2402.0000	3.87	-16.13	20.00



### Band Edges (CH High)

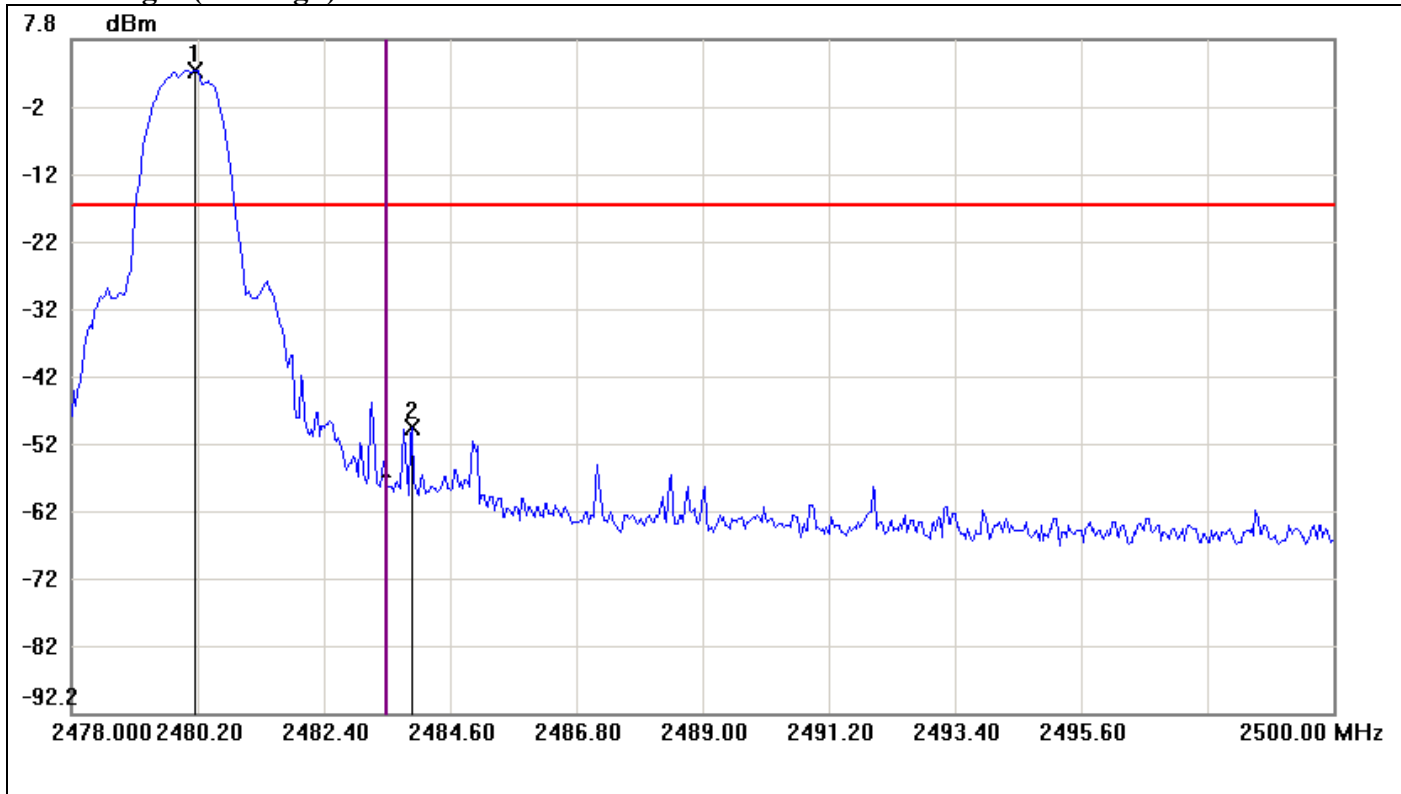

No.	Frequency(MHz)	Result(dBm)	Limit(dBm)	Margin(dBm)
1	2480.1633	3.18	-16.82	20.00
2	2483.9400	-49.77	-16.82	-32.95



### Hopping Mode (CH Low)

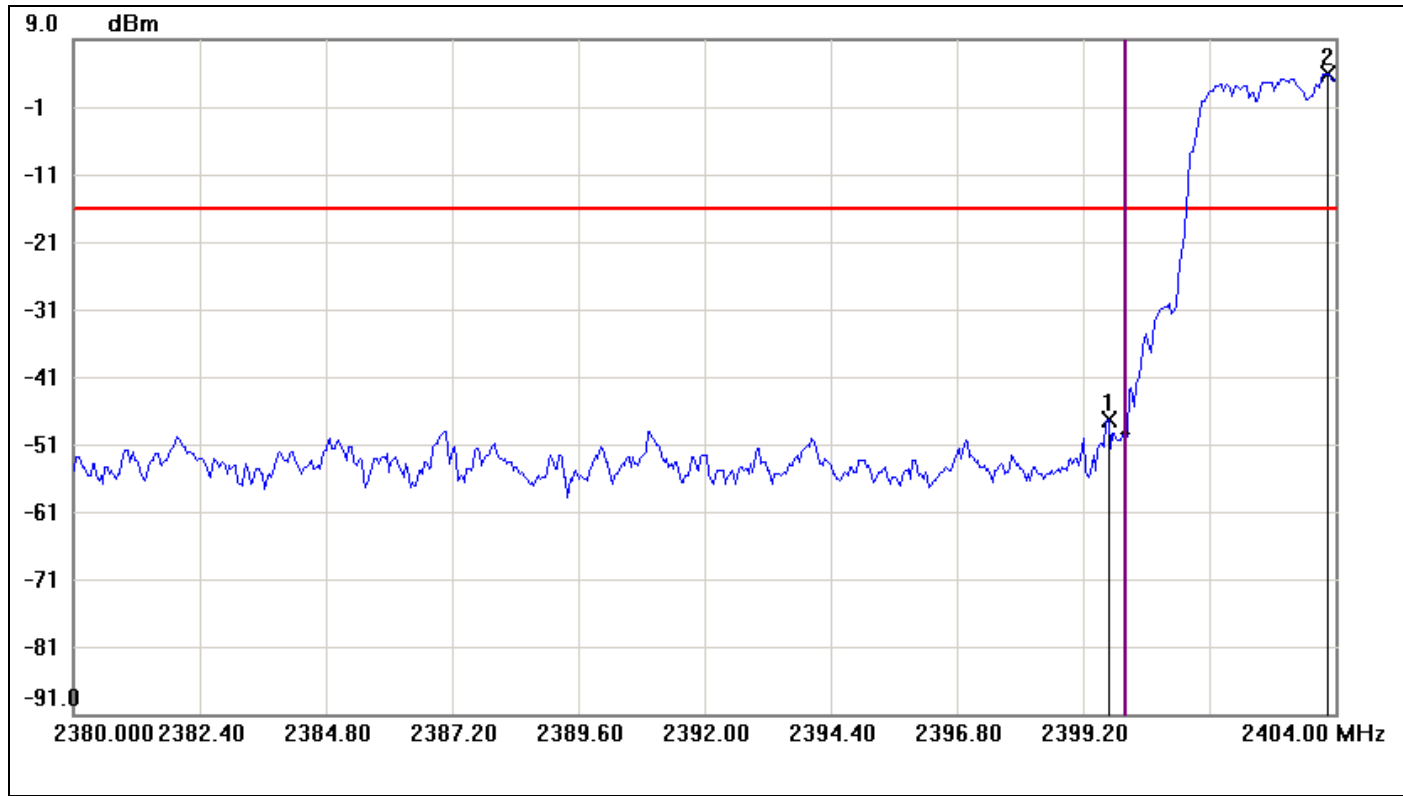

No.	Frequency(MHz)	Result(dBm)	Limit(dBm)	Margin(dBm)
1	2399.6800	-47.28	-16.01	-31.27
2	2403.8400	3.99	-16.01	20.00



(CH High)

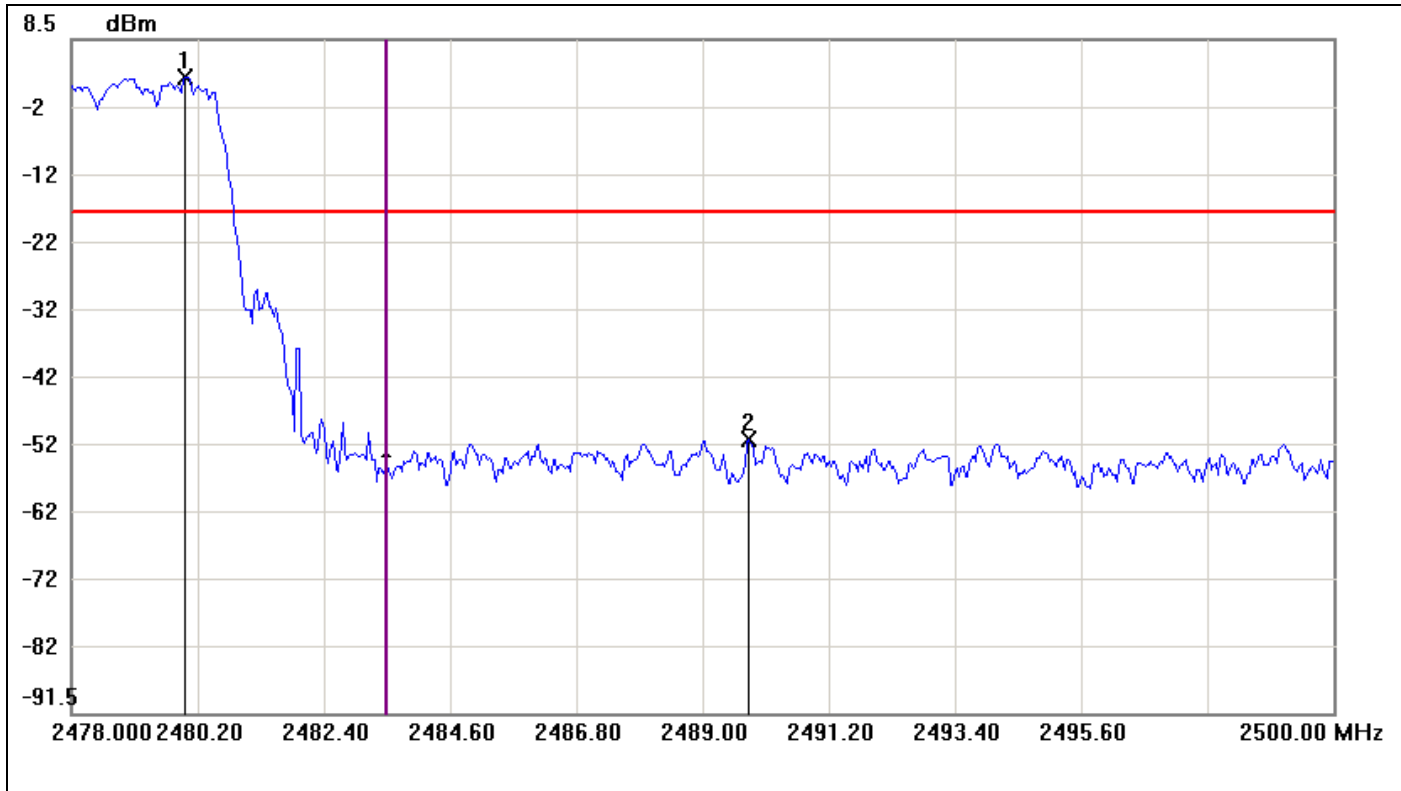

No.	Frequency(MHz)	Result(dBm)	Limit(dBm)	Margin(dBm)
1	2479.9800	2.98	-17.02	20.00
2	2489.8067	-50.94	-17.02	-33.92



## 7.6 FREQUENCY SEPARATION

### LIMIT

According to §15.247(a)(1) & RSS-210 §A8.1 (2), Frequency hopping systems shall have hopping channel carrier frequencies separated by a minimum of 25 kHz or the 20 dB bandwidth of the hopping channel, whichever is greater. Alternatively, frequency hopping systems operating in the 2400-2483.5 MHz band may have hopping channel carrier frequencies that are separated by 25 kHz or two-thirds of the 20 dB bandwidth of the hopping channel, whichever is greater, provided the systems operate with an output power no greater than 125 mW.

### Test Configuration

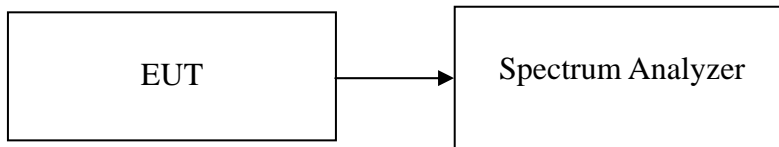

### TEST PROCEDURE

1. Place the EUT on the table and set it in transmitting mode.
2. Remove the antenna from the EUT and then connect a low loss RF cable from the antenna port to the spectrum analyzer.
3. Set center frequency of spectrum analyzer = middle of hopping channel.
4. Set the spectrum analyzer as RBW = 30kHz, VBW = 100kHz, Sweep = 3.2 ms.
5. Max hold, mark 3 peaks of hopping channel and record the 3 peaks frequency.

### TEST RESULTS

*No non-compliance noted*

#### Test Data

##### **For GFSK / DH5**

Channel Separation (MHz)	two-thirds of the 20 dB bandwidth	Channel Separation Limit	Result
1.07	0.69	>two-thirds of the 20 dB bandwidth	Pass

##### **For 8DPSK / DH5**

Channel Separation (MHz)	two-thirds of the 20 dB bandwidth	Channel Separation Limit	Result
1.115	0.8733	>two-thirds of the 20 dB bandwidth	Pass



**Test Plot**

**For GFSK / DH5**

**Measurement of Channel Separation**

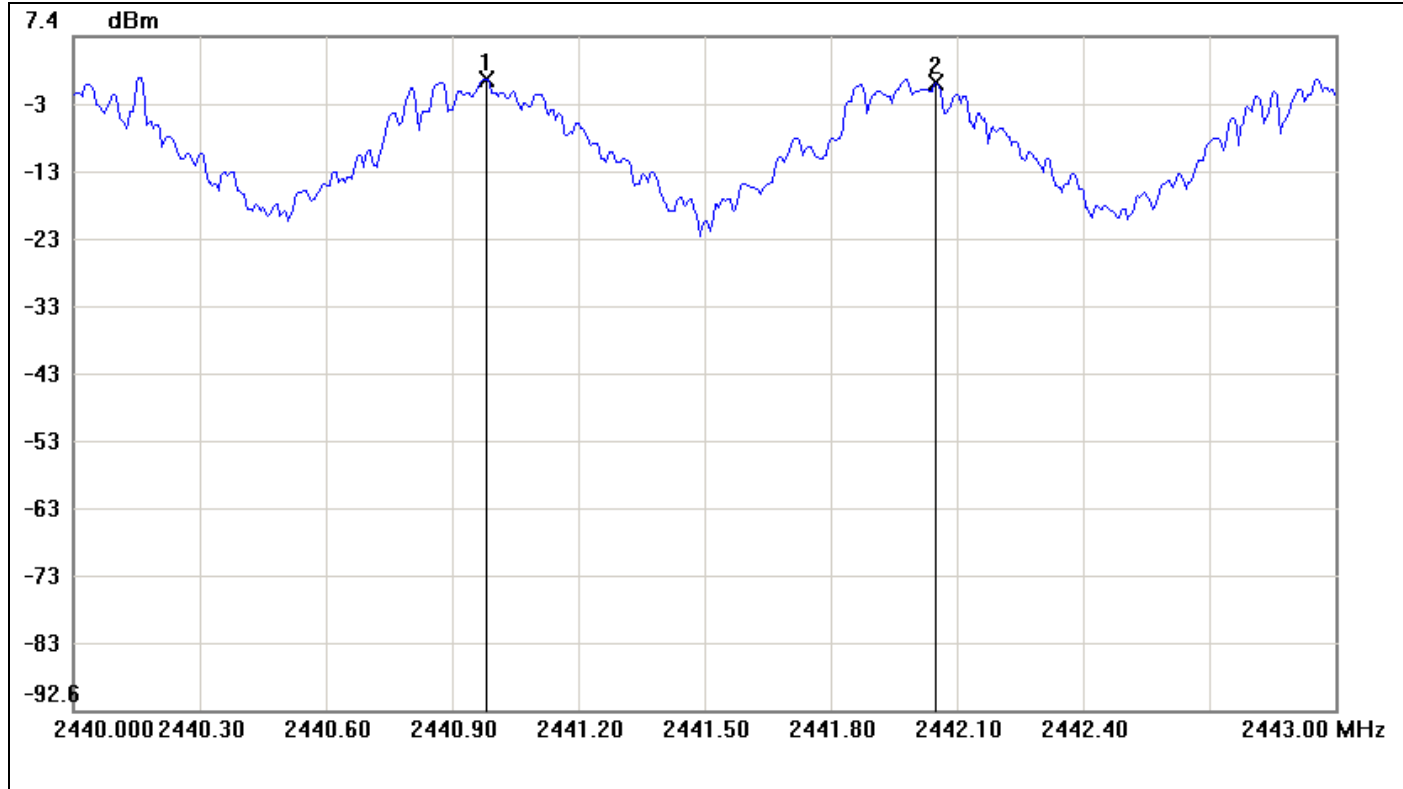

No.	Frequency(MHz)	Result(dBm)	Limit(dBm)	Margin(dBm)
1	2440.9800	1.15		
2	2442.0500	0.48		

No.		$\Delta$ Frequency(MHz)	$\Delta$ Level(dB)
1	mk2-mk1	1.07	-0.67





For 8DPSK / DH5

**Measurement of Channel Separation**

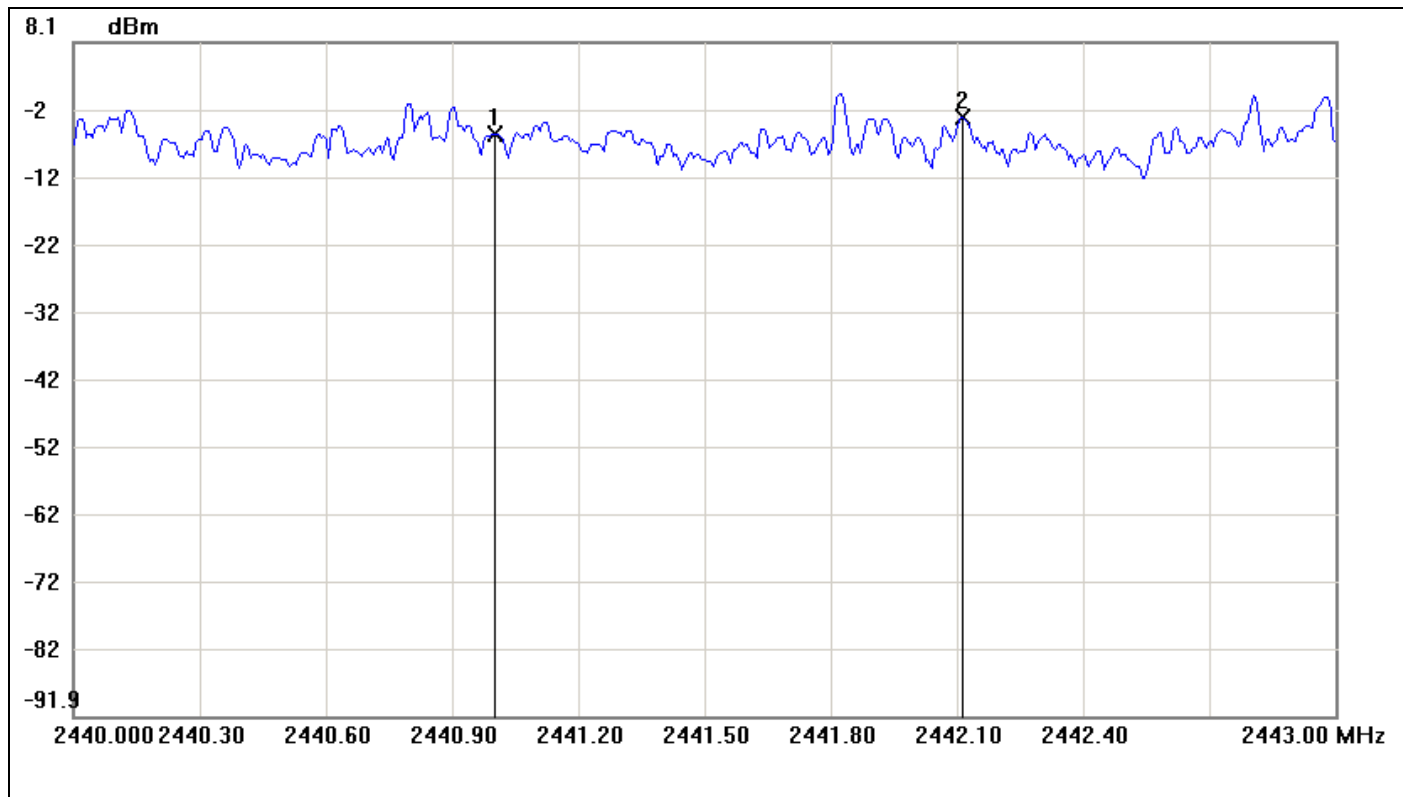

No.	Frequency(MHz)	Result(dBm)	Limit(dBm)	Margin(dBm)
1	2441.0000	-5.44		
2	2442.1150	-3.08		

No.		$\Delta$ Frequency(MHz)	$\Delta$ Level(dB)
1	mk2-mk1	1.115	2.36



## 7.7 NUMBER OF HOPPING FREQUENCY

### LIMIT

According to §15.247(a)(1)(ii), Frequency hopping systems operating in the 2400MHz-2483.5 MHz bands shall use at least 75 hopping frequencies.

According to §15.247(a)(1)(iii) & RSS-210 §A8.1(4), Frequency hopping systems operating in the 2400MHz-2483.5 MHz bands shall use at least 15 hopping frequencies.

### Test Configuration

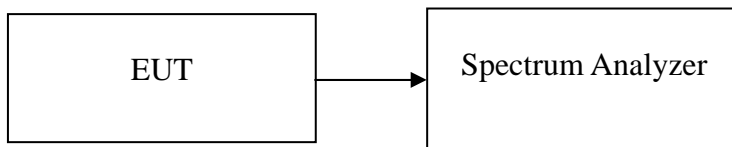

### TEST PROCEDURE

1. Place the EUT on the table and set it in transmitting mode.
2. Remove the antenna from the EUT and then connect a low loss RF cable from the antenna port to the spectrum analyzer.
3. Set spectrum analyzer Start=2400MHz, Stop = 2430.5MHz, Sweep = auto  
Start=2430.5MHz, Stop = 2460.5MHz, Sweep = auto and Start=2460.5MHz, Stop = 2485.5MHz, Sweep = auto.
4. Set the spectrum analyzer as RBW, VBW=510kHz.
5. Max hold, view and count how many channel in the band.

### TEST RESULTS

*No non-compliance noted*

#### Test Data

Result (No. of CH)	Limit (No. of CH)	Result
79	>15	PASS



**Test Plot**

**For GFSK**

**Channel Number**

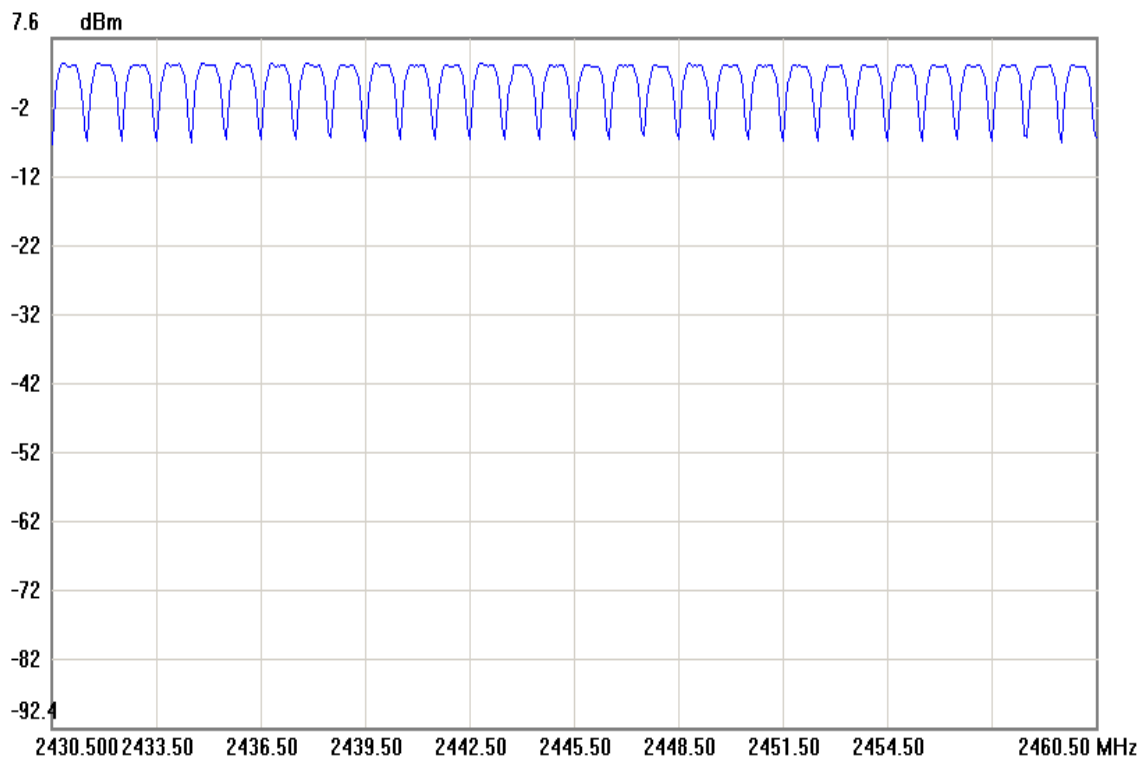
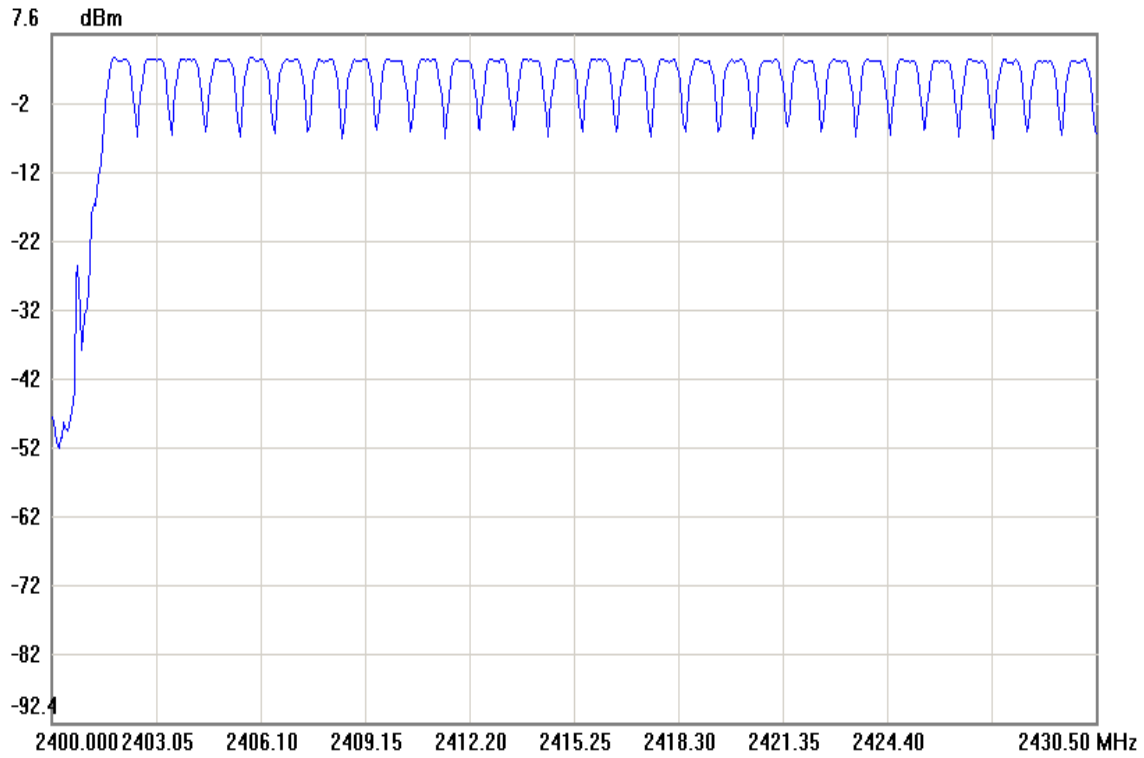

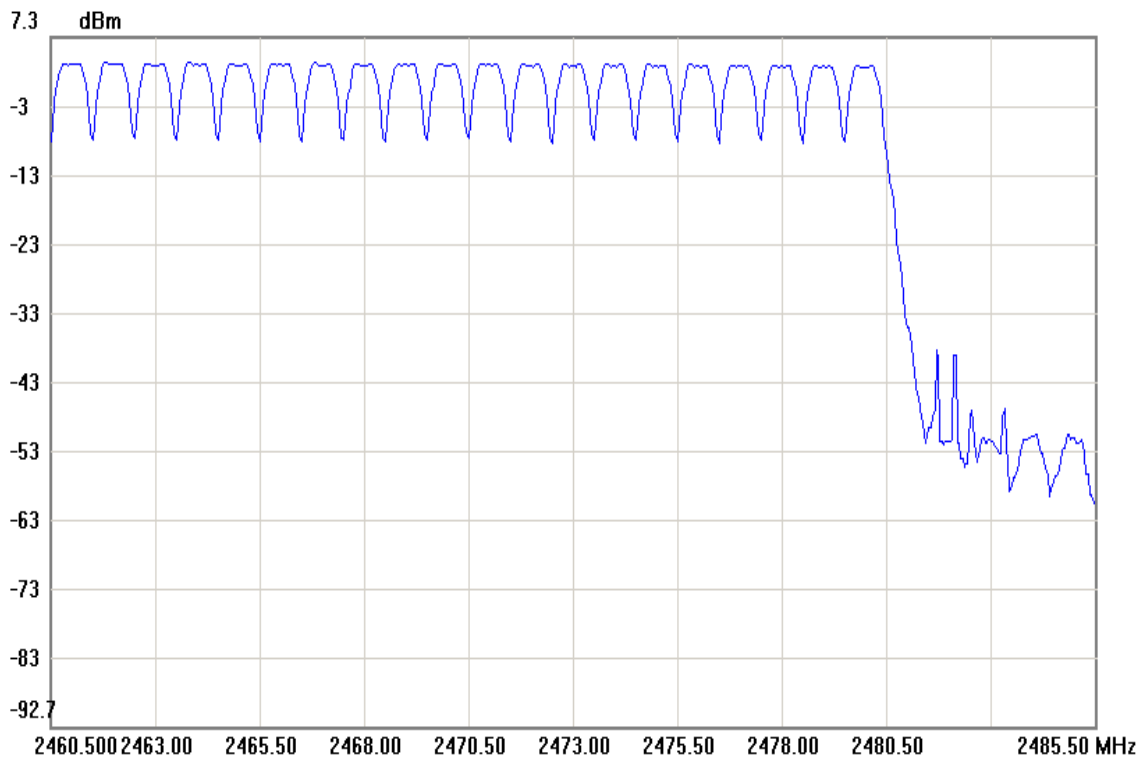



**For 8DPSK**

**Channel Number**

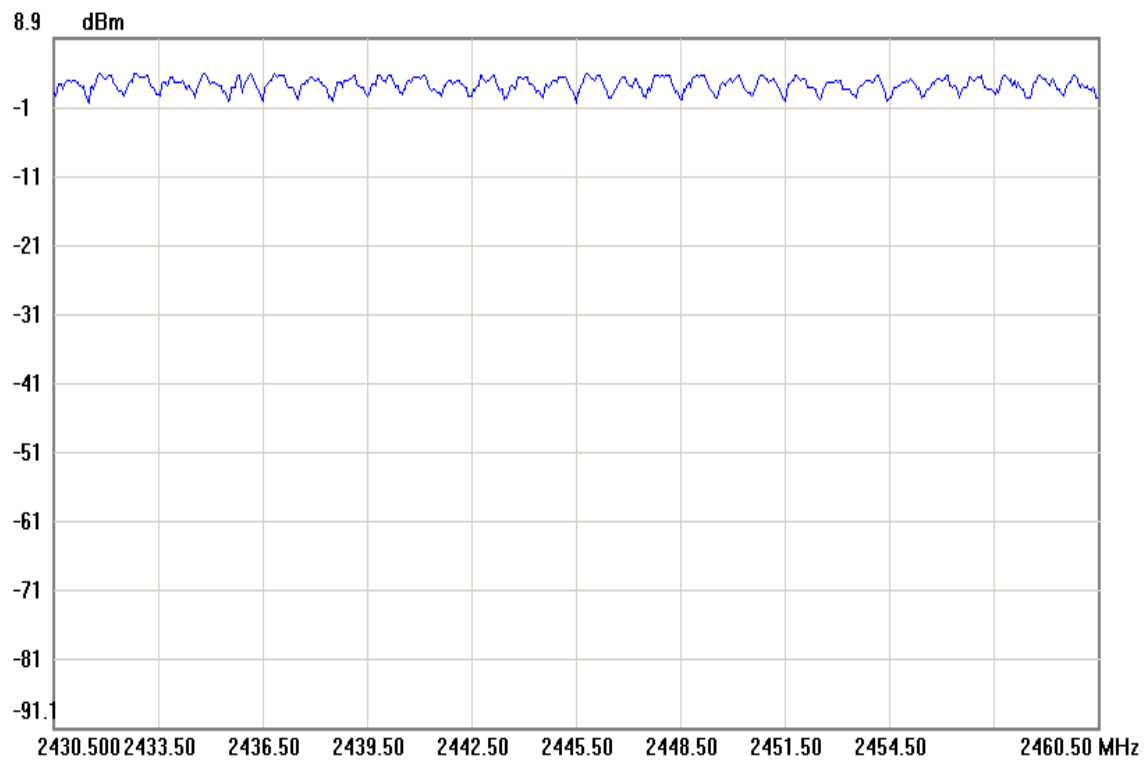
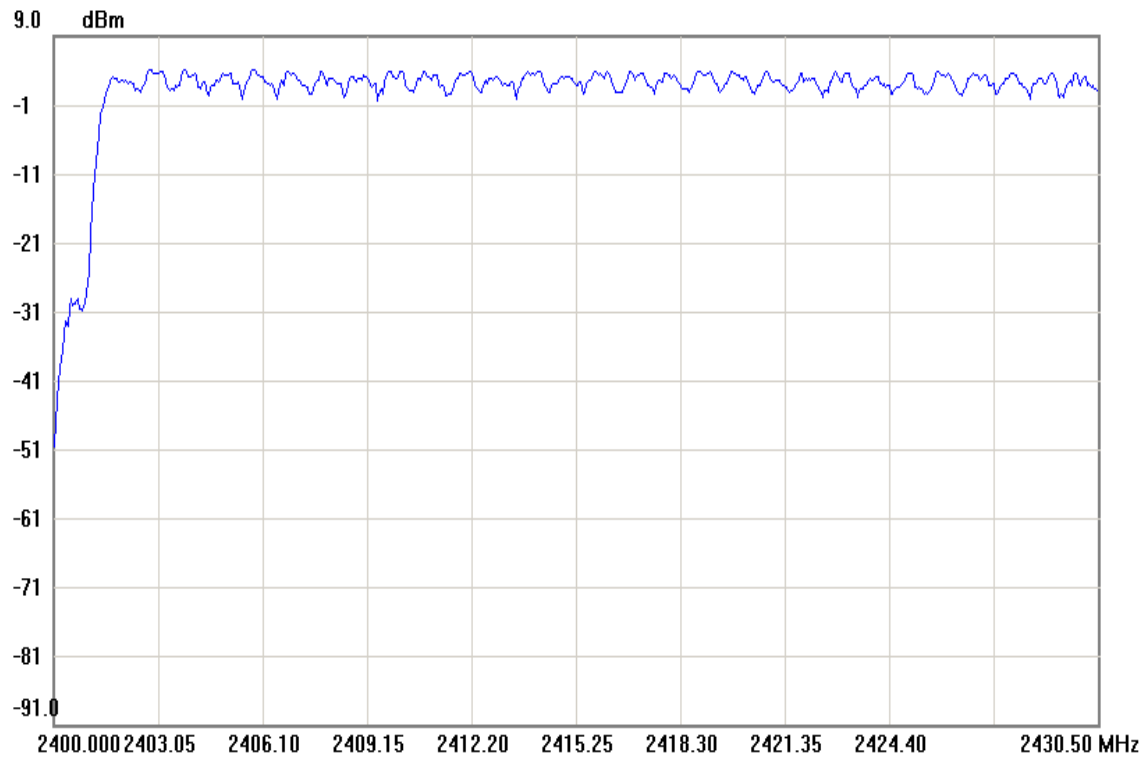

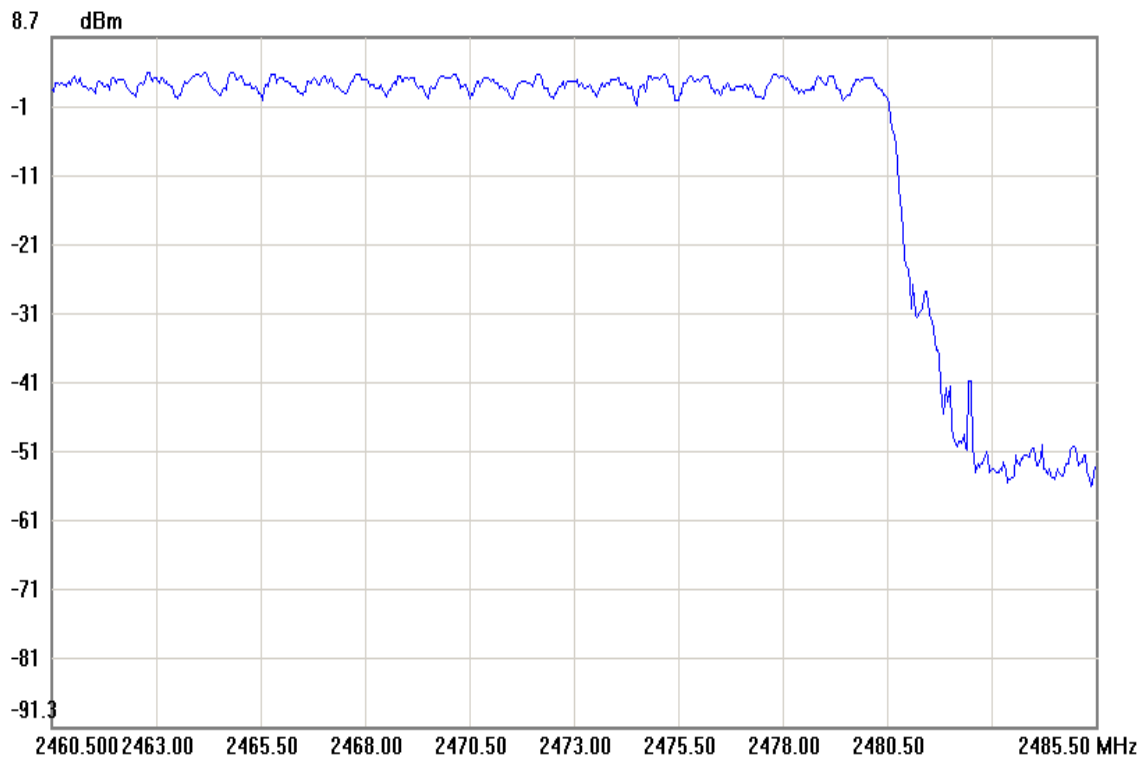



## 7.8 TIME OF OCCUPANCY (DWELL TIME)

### LIMIT

According to §15.247(a)(1)(iii), Frequency hopping systems operating in the 2400MHz-2483.5 MHz bands. The average time of occupancy on any channels shall not greater than 0.4 s within a period 0.4 s multiplied by the number of hopping channels employed.

According to RSS-210 §A8.1(4), the average time of occupancy on any channel shall not be greater than 0.4 seconds within a period of 0.4 seconds multiplied by the number of hopping channels employed. Transmissions on particular hopping frequencies may be avoided or suppressed provided that a minimum of 15 hopping channels are used.

### Test Configuration

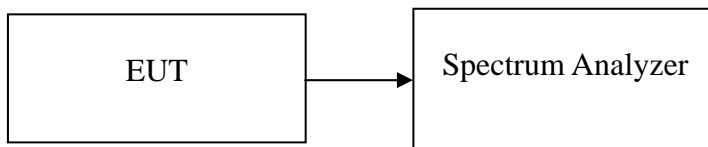

### TEST PROCEDURE

1. Place the EUT on the table and set it in transmitting mode.
2. Remove the antenna from the EUT and then connect a low loss RF cable from the antenna port to the spectrum analyzer.
3. Set center frequency of spectrum analyzer = operating frequency.
4. Set the spectrum analyzer as RBW, VBW=1MHz, Sweep = 1 ms.
5. Repeat above procedures until all frequency measured were complete.

### TEST RESULTS

*No non-compliance noted*



**Test Data**

**For GFSK**

DH 1:  $0.3983 * (1600/2)/79 * 31.6 = 127.456$  (ms)

DH 3:  $1.66 * (1600/4)/79 * 31.6 = 265.600$  (ms)

DH 5:  $2.9084 * (1600/6)/79 * 31.6 = 310.229$  (ms)

	<b>Pulse Time (ms)</b>	<b>Total of Dwell (ms)</b>	<b>Period Time (s)</b>	<b>Limit (ms)</b>	<b>Result</b>
DH 1	0.3983	127.456	31.60	400.00	PASS
DH 3	1.66	265.600	31.60		PASS
DH 5	2.9084	310.229	31.60		PASS





**Test Plot**  
**For GFSK**  
**DH 1**

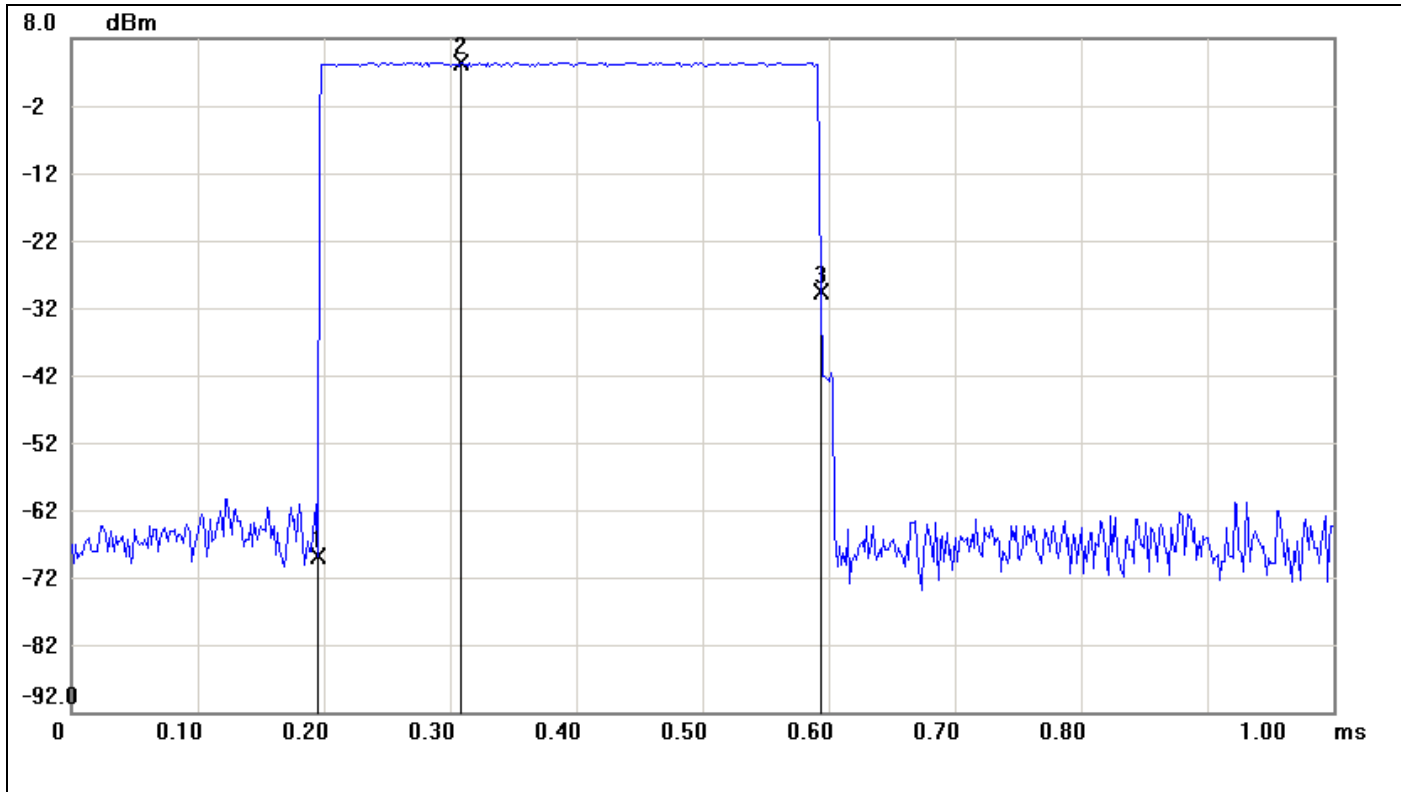

No.	Sweep time(ms)	Result(dBm)	Limit(dBm)	Margin(dBm)
1	0.1950	-68.73		
2	0.3083	4.52		
3	0.5933	-29.53		

No.		$\Delta$ Time(ms)	$\Delta$ Level(dB)
1	mk3-mk1	0.3983	39.2



**DH 3**

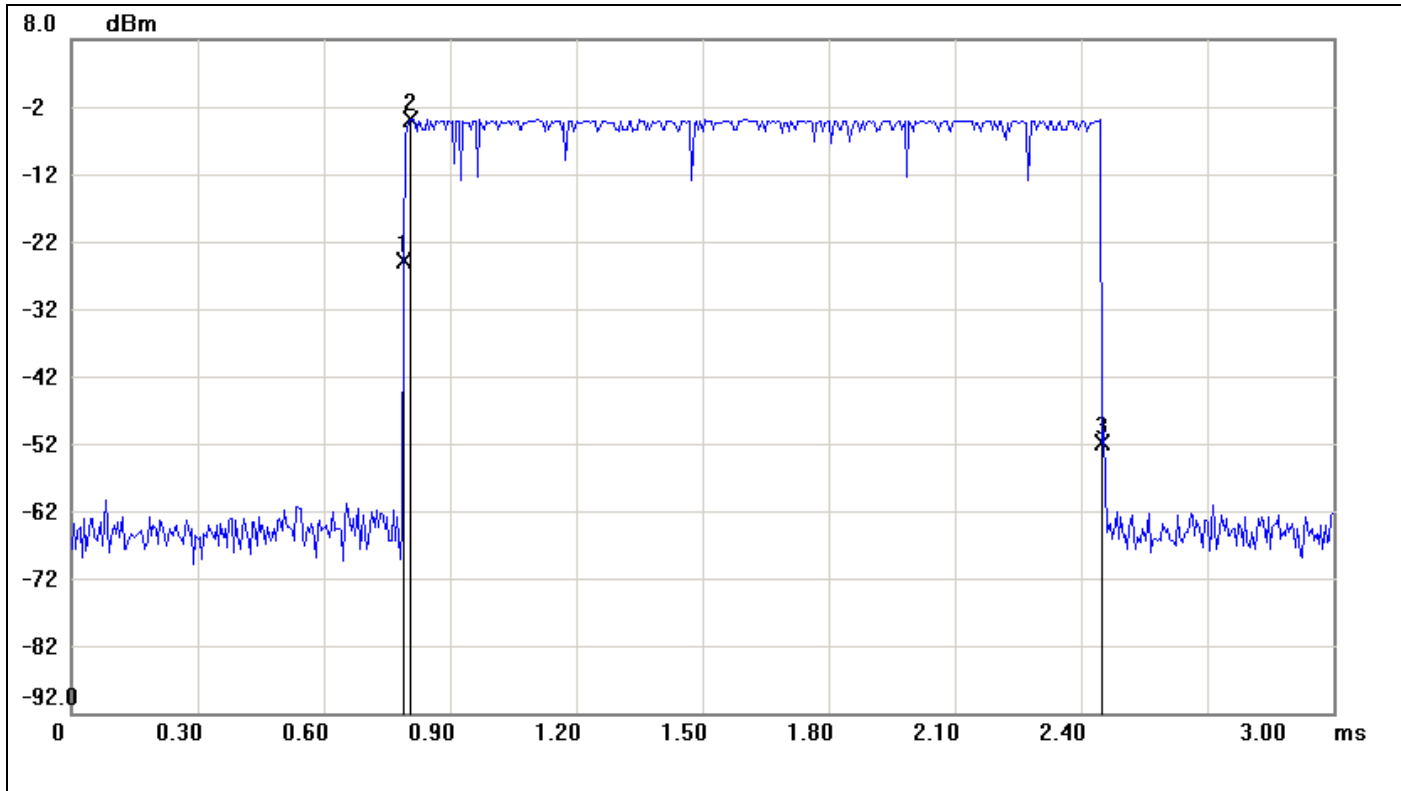

No.	Sweep time(ms)	Result(dBm)	Limit(dBm)	Margin(dBm)
1	0.7900	-24.75		
2	0.8050	-3.82		
3	2.4500	-51.94		

No.		$\Delta$ Time(ms)	$\Delta$ Level(dB)
1	mk3-mk1	1.66	-27.19



**DH 5**

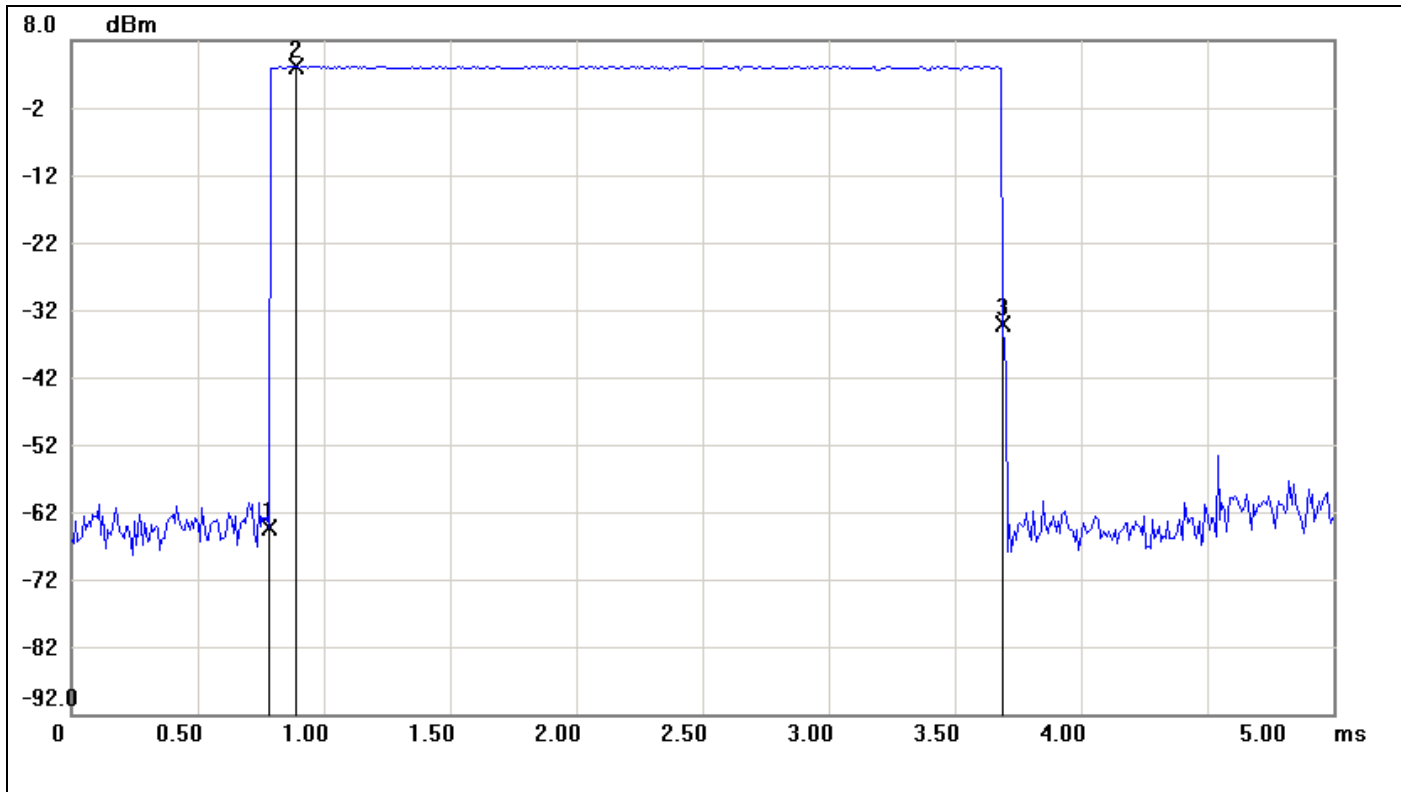

No.	Sweep time(ms)	Result(dBm)	Limit(dBm)	Margin(dBm)
1	0.7833	-64.36		
2	0.8917	4.17		
3	3.6917	-34.09		

No.		$\Delta$ Time(ms)	$\Delta$ Level(dB)
1	mk3-mk1	2.9084	30.27



**Test Data**

**For 8DPSK**

DH 1:  $0.4066 * (1600/2)/79 * 31.6 = 130.112$  (ms)

DH 3:  $1.665 * (1600/4)/79 * 31.6 = 266.400$  (ms)

DH 5:  $2.9167 * (1600/6)/79 * 31.6 = 311.115$  (ms)

	<b>Pulse Time (ms)</b>	<b>Total of Dwell (ms)</b>	<b>Period Time (s)</b>	<b>Limit (ms)</b>	<b>Result</b>
DH 1	0.4066	130.112	31.60	400.00	PASS
DH 3	1.665	266.400	31.60		PASS
DH 5	2.9167	311.115	31.60		PASS



For 8DPSK

DH 1

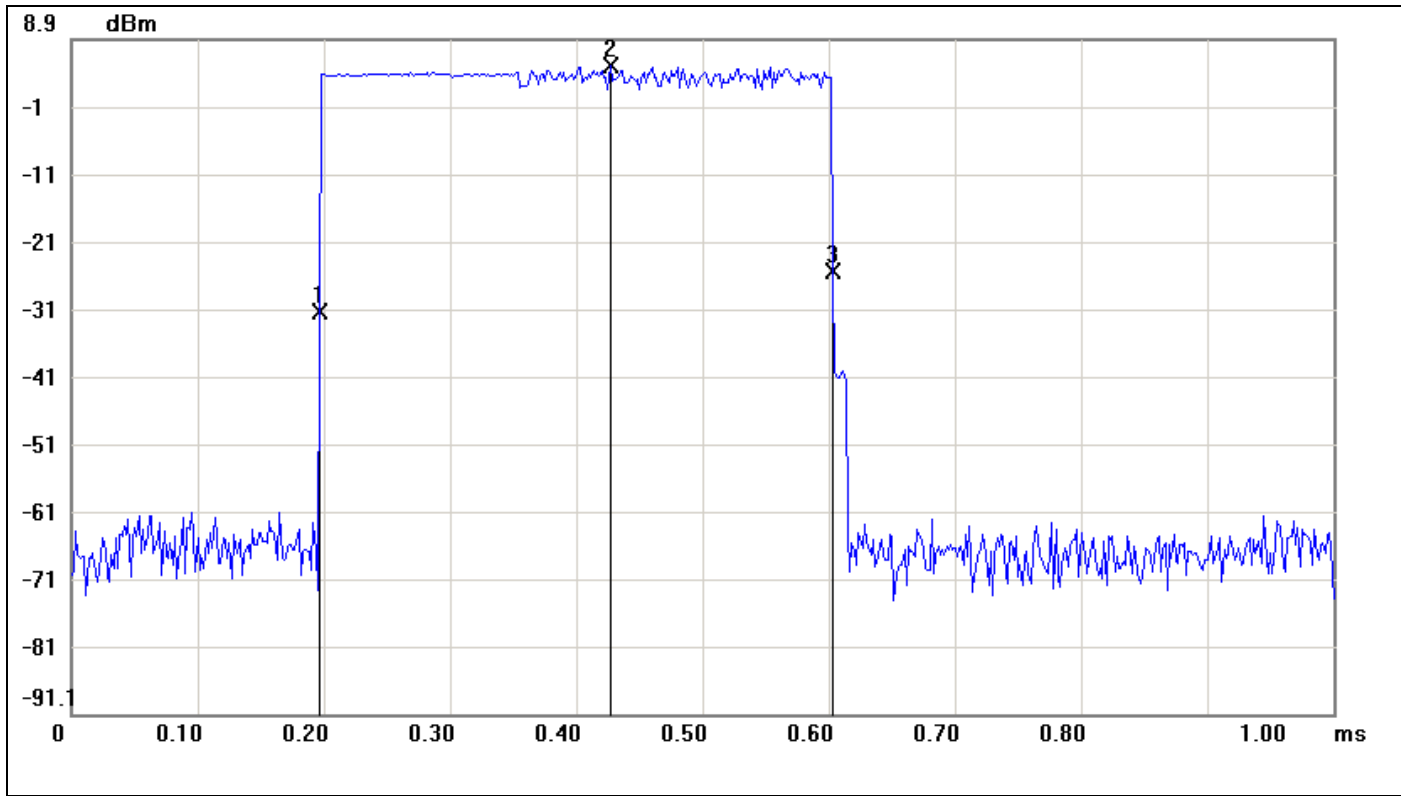

No.	Sweep time(ms)	Result(dBm)	Limit(dBm)	Margin(dBm)
1	0.1967	-31.53		
2	0.4267	4.94		
3	0.6033	-25.49		

No.		$\Delta$ Time(ms)	$\Delta$ Level(dB)
1	mk3-mk1	0.4066	6.04



**DH 3**

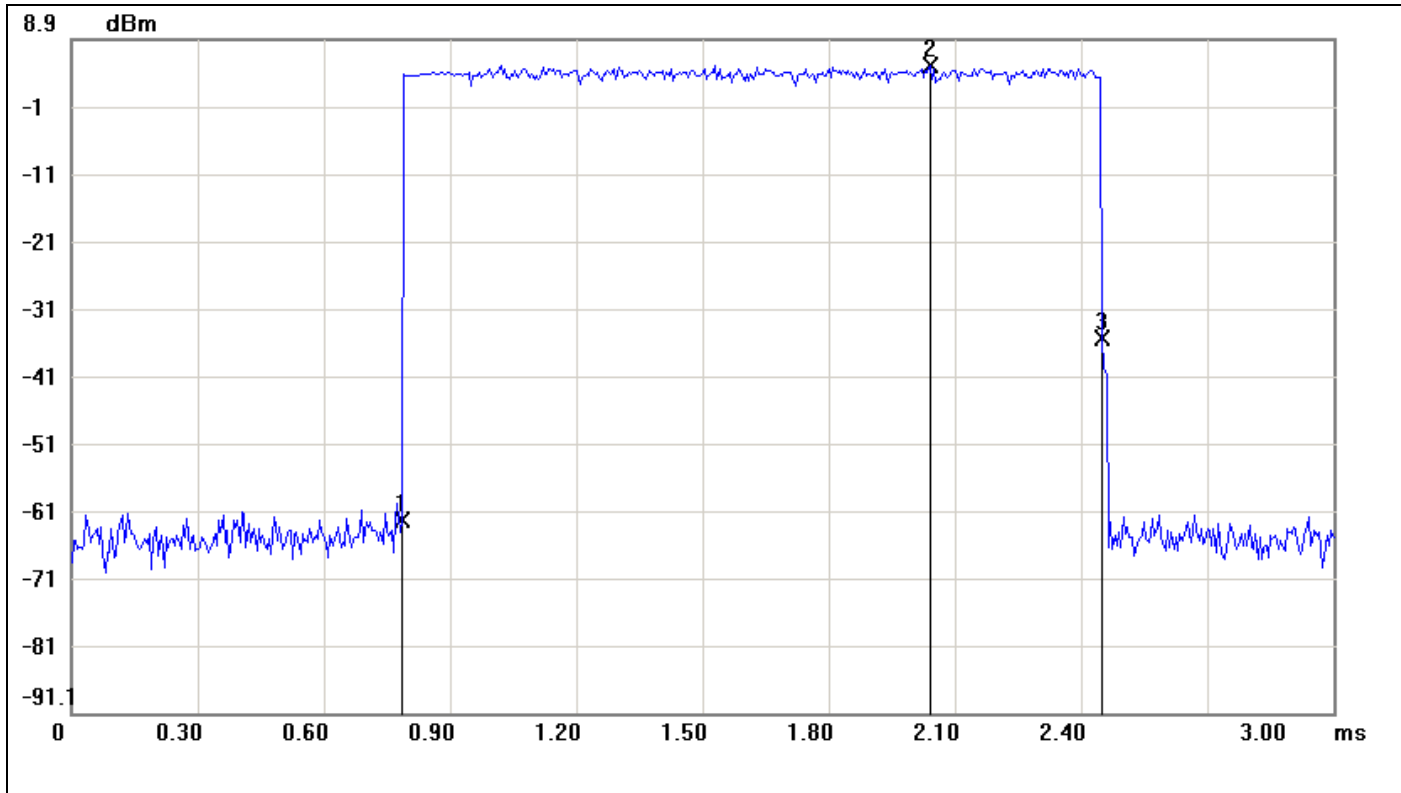

No.	Sweep time(ms)	Result(dBm)	Limit(dBm)	Margin(dBm)
1	0.7850	-62.37		
2	2.0400	5.03		
3	2.4500	-35.44		

No.		$\Delta$ Time(ms)	$\Delta$ Level(dB)
1	mk3-mk1	1.665	26.93



**DH 5**

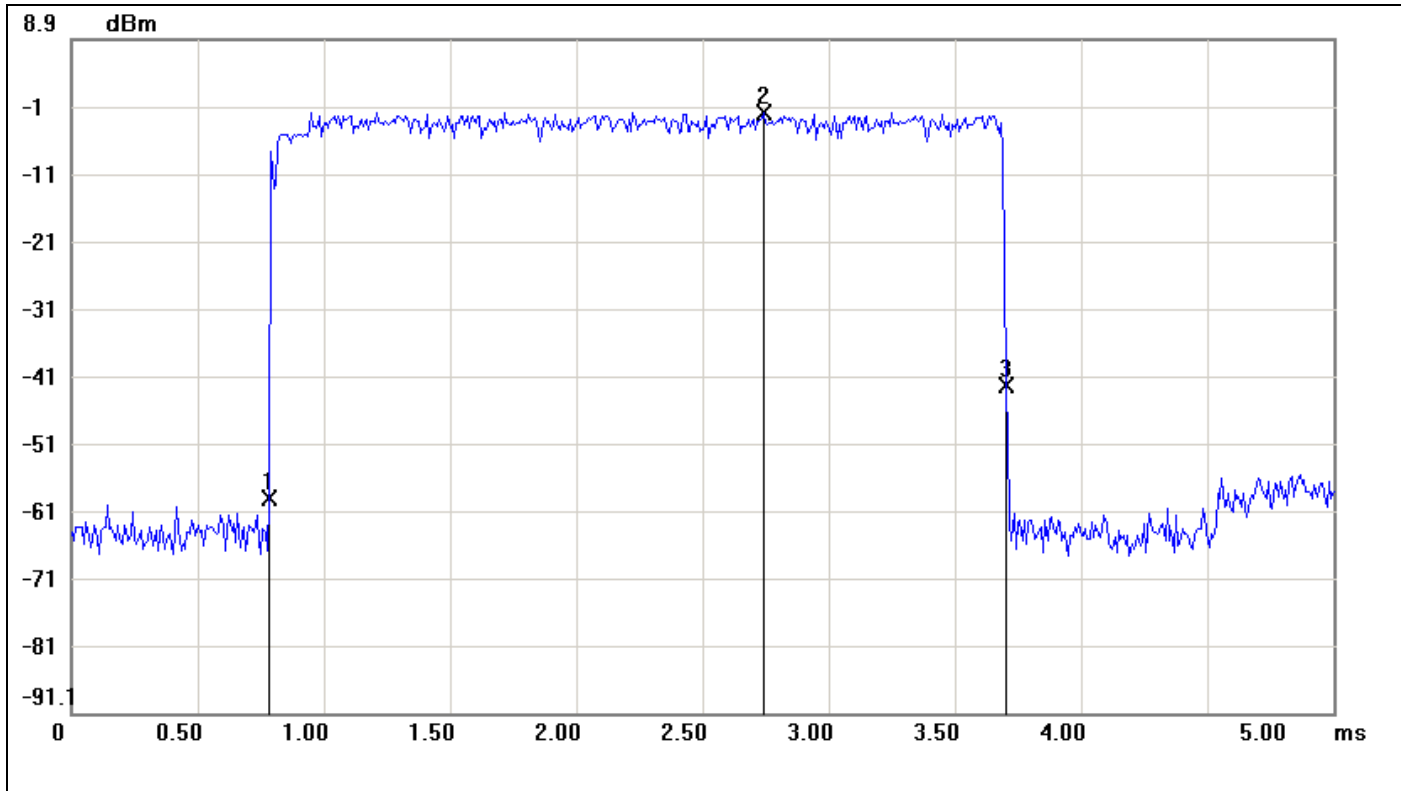

No.	Sweep time(ms)	Result(dBm)	Limit(dBm)	Margin(dBm)
1	0.7833	-59.31		
2	2.7417	-1.93		
3	3.7000	-42.39		

No.		$\Delta$ Time(ms)	$\Delta$ Level(dB)
1	mk3-mk1	2.9167	16.92



## 7.9 SPURIOUS EMISSIONS

### 7.9.1 Conducted Measurement

#### **LIMIT**

According to §15.247(d) & RSS-210 §A8.5, in any 100 kHz bandwidth outside the frequency bands in which the spread spectrum intentional radiator is operating, the radio frequency power that is produced by the intentional radiator shall be at least 20 dB below that in the 100 kHz bandwidth within the band that contains the highest level of the desired power, based on either an RF conducted or a radiated measurement, provided the transmitter demonstrates compliance with the peak conducted power limits. In addition, radiated emissions which fall in the restricted bands, as defined in §15.205(a), must also comply with the radiated emission limits specified in 15.209(a) (see Section 15.205(c)).

#### **Test Configuration**

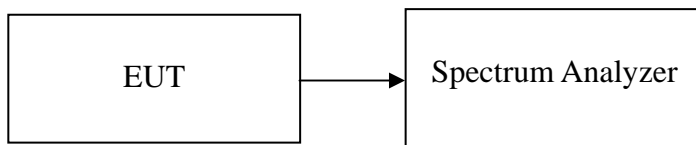

#### **TEST PROCEDURE**

Conducted RF measurements of the transmitter output were made to confirm that the EUT antenna port conducted emissions meet the specified limit and to identify any spurious signals that require further investigation or measurements on the radiated emissions site.

The transmitter output is connected to the spectrum analyzer. The resolution bandwidth is set to 100 kHz. The video bandwidth is set to 100 kHz.

Measurements are made over the 30MHz to 26GHz range with the transmitter set to the lowest, middle, and highest channels.

#### **TEST RESULTS**

*No non-compliance noted*





**Test Plot**

**For GFSK / DH5**

**CH Low**

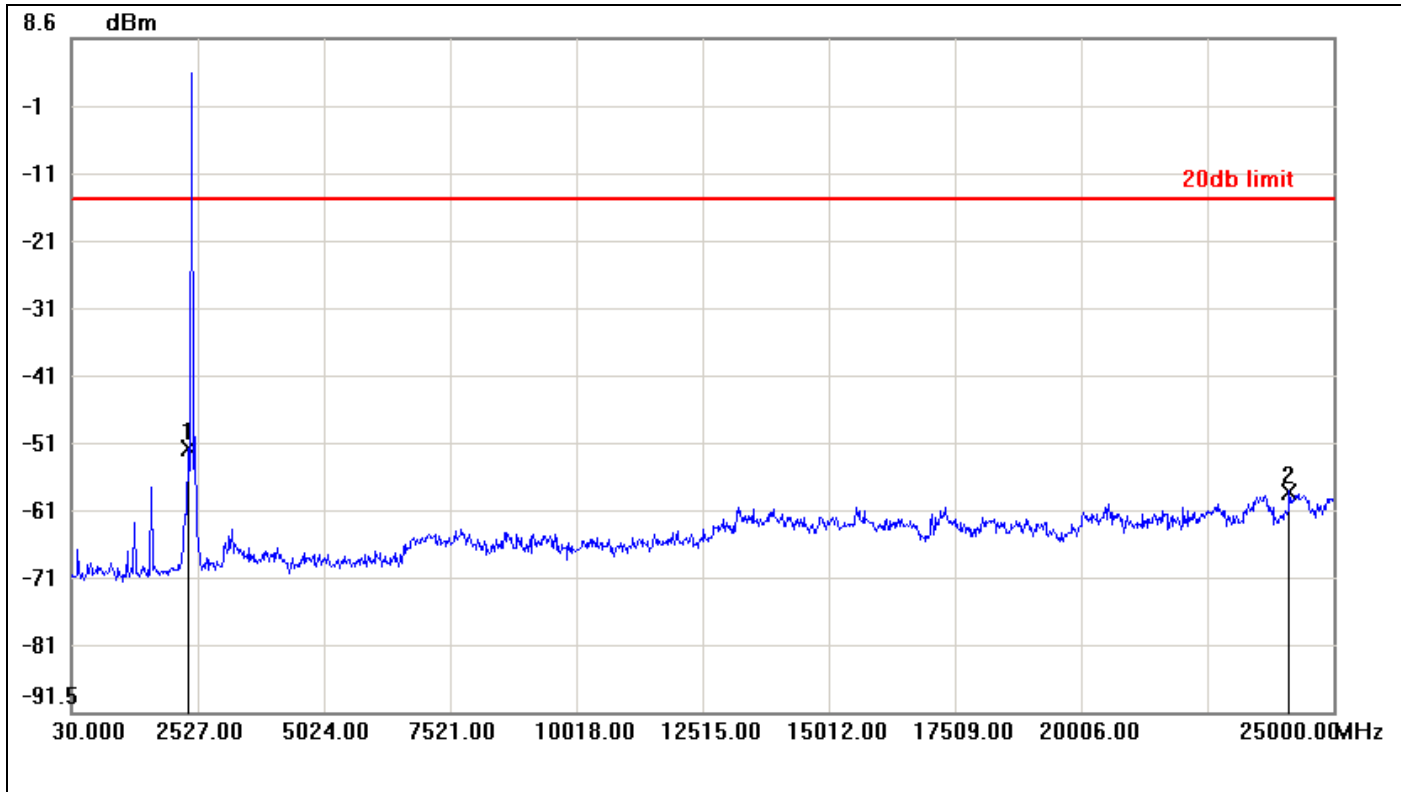

No.	Frequency(MHz)	Result(dBm)	Limit(dBm)	Margin(dBm)
1	2327.2400	-52.42	-15.22	-37.20
2	24126.0500	-58.70	-15.22	-43.48



### CH Mid

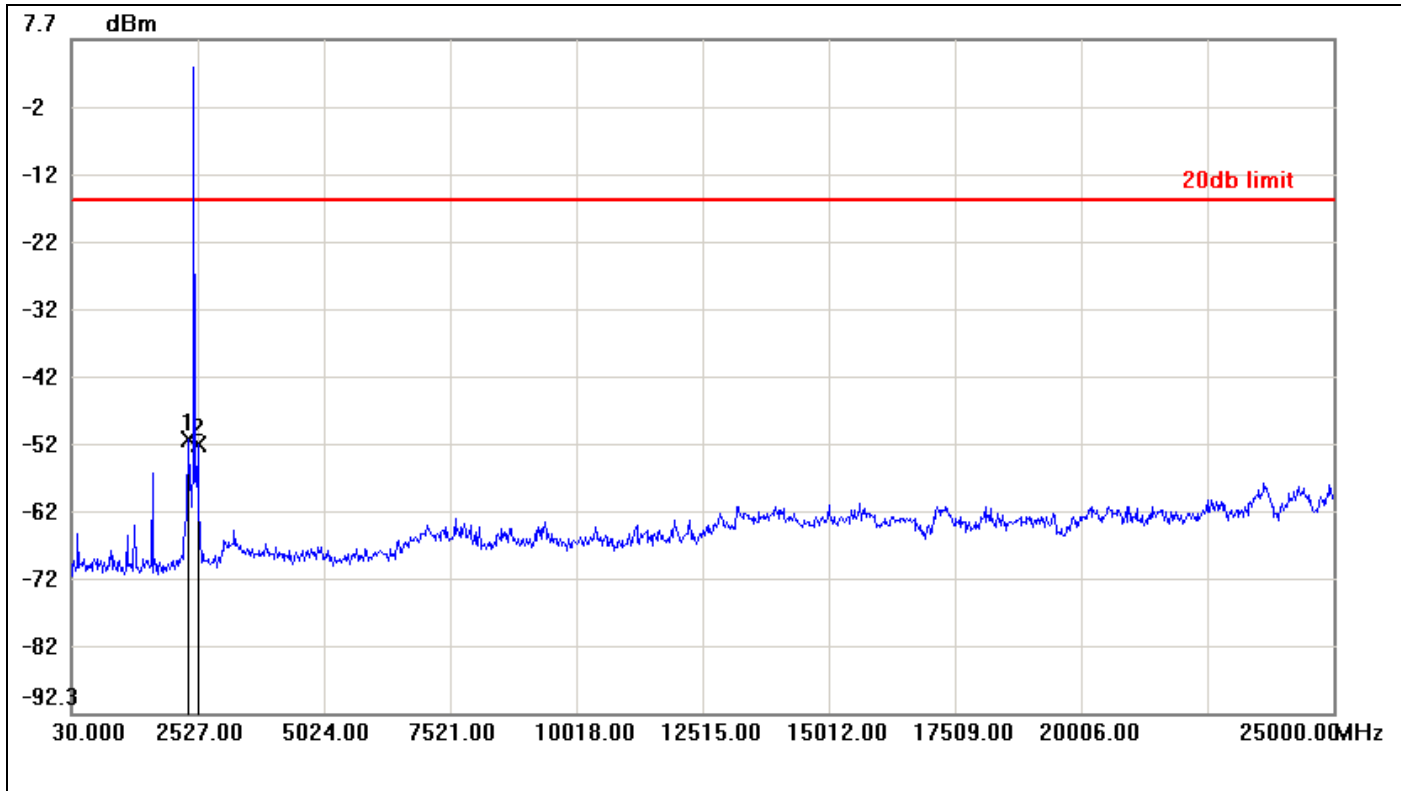

No.	Frequency(MHz)	Result(dBm)	Limit(dBm)	Margin(dBm)
1	2327.2400	-51.63	-16.08	-35.55
2	2527.0000	-52.47	-16.08	-36.39



CH High

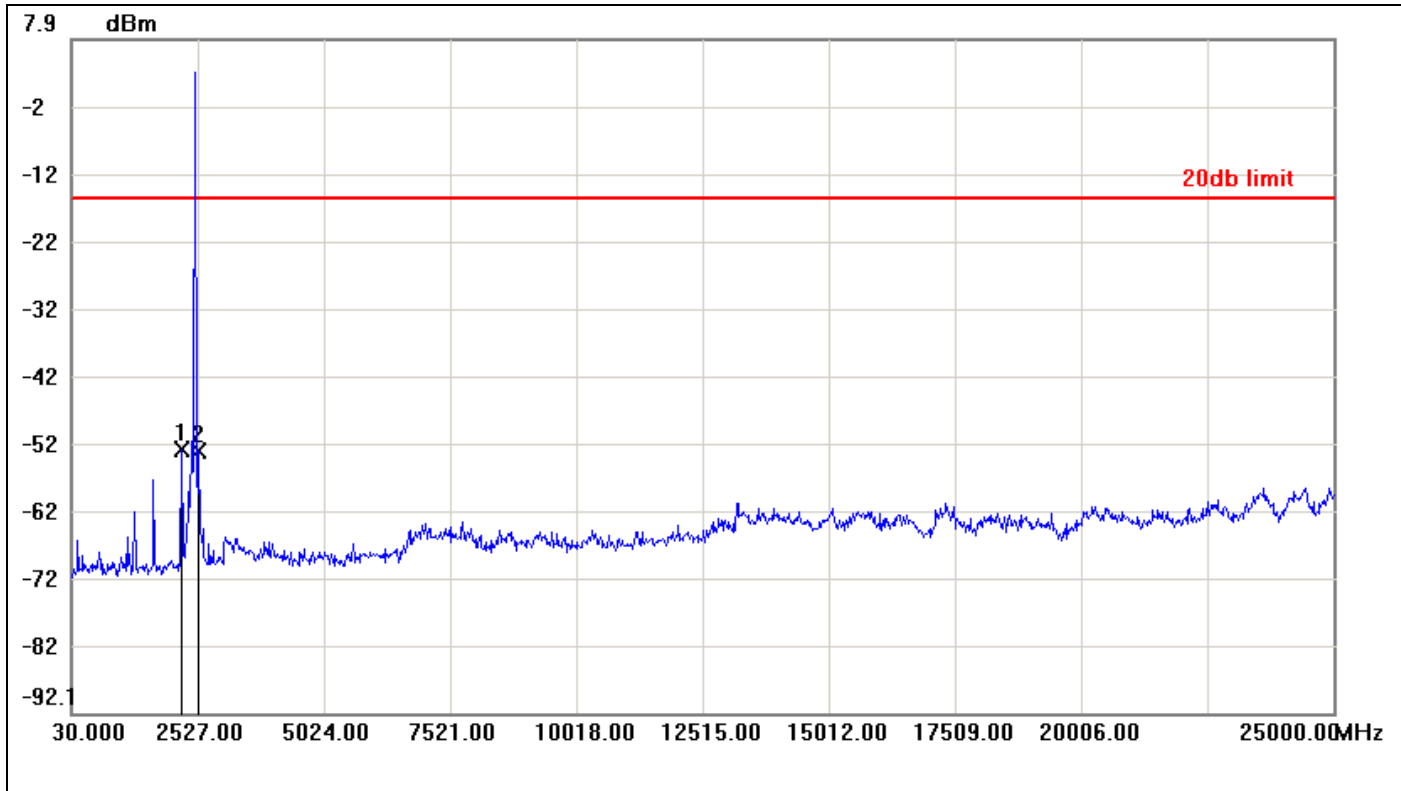

No.	Frequency(MHz)	Result(dBm)	Limit(dBm)	Margin(dBm)
1	2202.3900	-52.94	-15.75	-37.19
2	2551.9700	-53.25	-15.75	-37.50



For 8DPSK / DH5

CH Low

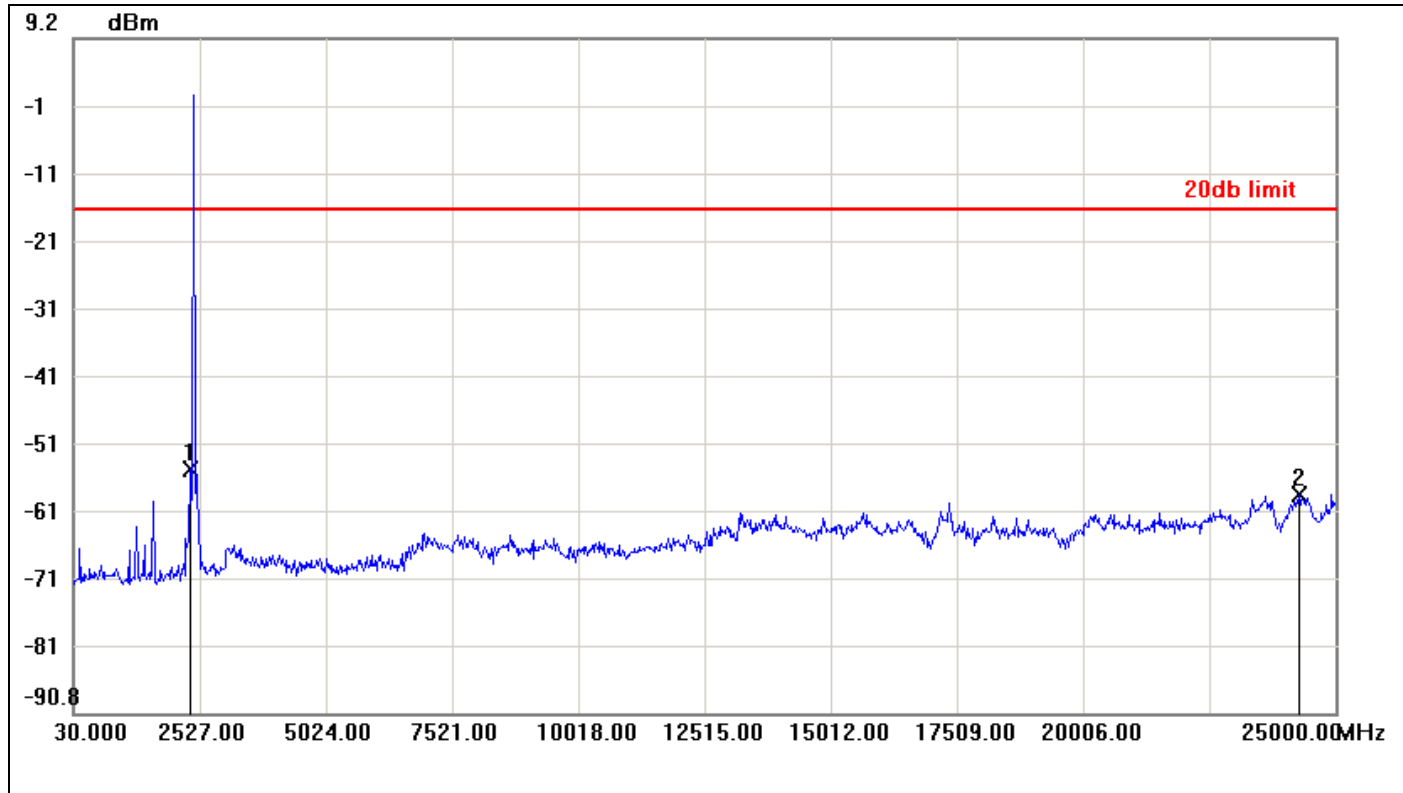

No.	Frequency(MHz)	Result(dBm)	Limit(dBm)	Margin(dBm)
1	2327.2400	-54.55	-16.05	-38.50
2	24275.8700	-58.31	-16.05	-42.26



### CH Mid

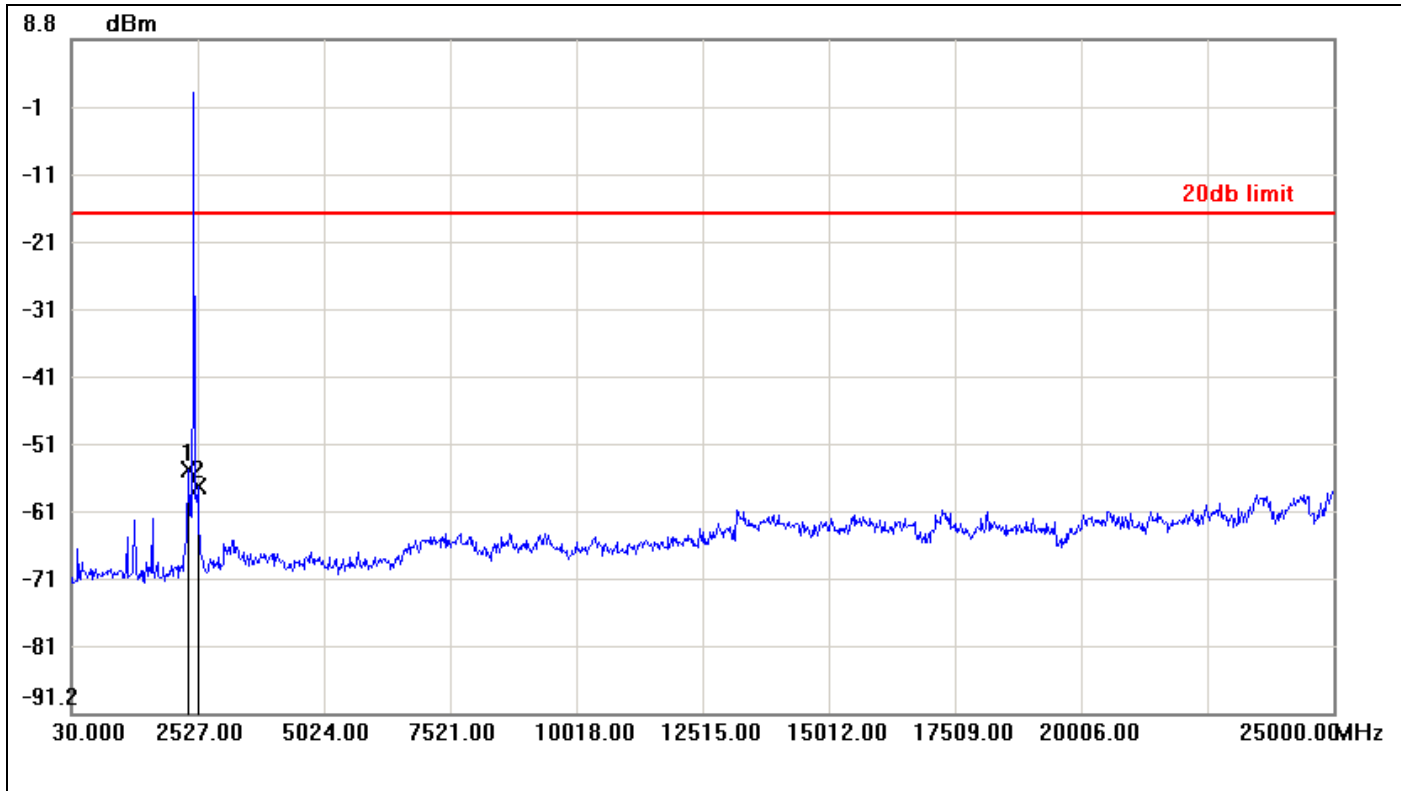

No.	Frequency(MHz)	Result(dBm)	Limit(dBm)	Margin(dBm)
1	2327.2400	-55.01	-17.00	-38.01
2	2527.0000	-57.48	-17.00	-40.48



### CH High

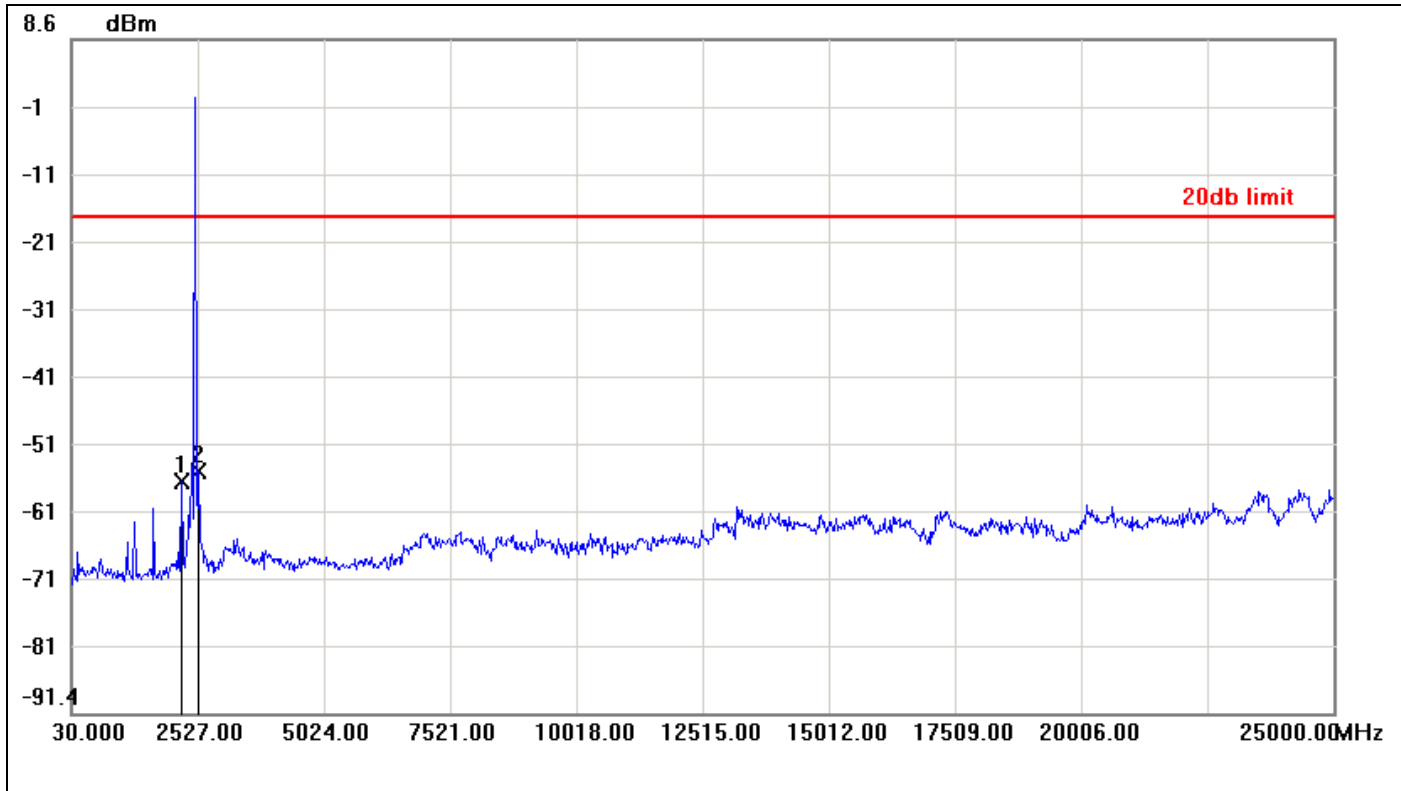

No.	Frequency(MHz)	Result(dBm)	Limit(dBm)	Margin(dBm)
1	2202.3900	-56.90	-17.73	-39.17
2	2551.9700	-55.43	-17.73	-37.70



### 7.9.2 Radiated Emissions

#### LIMIT

All spurious emissions shall comply with the limits of §15.209(a) and RSS-Gen Table 2 & Table 5.

#### RSS-Gen Table 2 & Table 5: General Field Strength Limits for Transmitters and Receivers at Frequencies Above 30 MHz <sup>(Note)</sup>

Frequency (MHz)	Field Strength microvolts/m at 3 metres (watts, e.i.r.p.)	
	Transmitters	Receivers
30-88	100 (3 nW)	100 (3 nW)
88-216	150 (6.8 nW)	150 (6.8 nW)
216-960	200 (12 nW)	200 (12 nW)
Above 960	500 (75 nW)	500 (75 nW)

**Note:** \*Measurements for compliance with limits in the above table may be performed at distances other than 3 metres, in accordance with Section 7.2.7.

Transmitting devices are not permitted in Table 1 bands or, unless stated otherwise, in TV bands (54-72 MHz, 76-88 MHz, 174-216 MHz, 470-608 MHz and 614-806 MHz).

#### RSS-Gen Table 6: General Field Strength Limits for Transmitters at Frequencies Below 30 MHz (Transmit)

Frequency	Field Strength (microvolts/m)	Magnetic H-Field (microamperes/m)	Measurement Distance (metres)
9-490 kHz	2,400/F (F in kHz)	2,400/377F (F in kHz)	3000
490-1,705 kHz	24,000/F (F in kHz)	24,000/377F (F in kHz)	30
1.705-30 MHz	30	N/A	30

**Note:** The emission limits for the bands 9-90 kHz and 110-490 kHz are based on measurements employing an average detector.



### Test Configuration

#### 9kHz ~ 30MHz

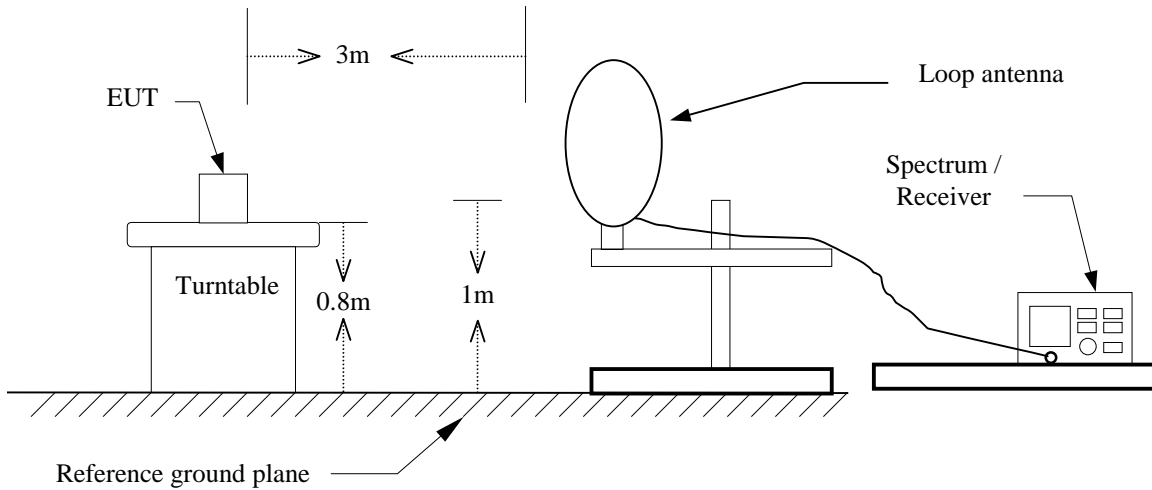

#### 30MHz ~ 1GHz

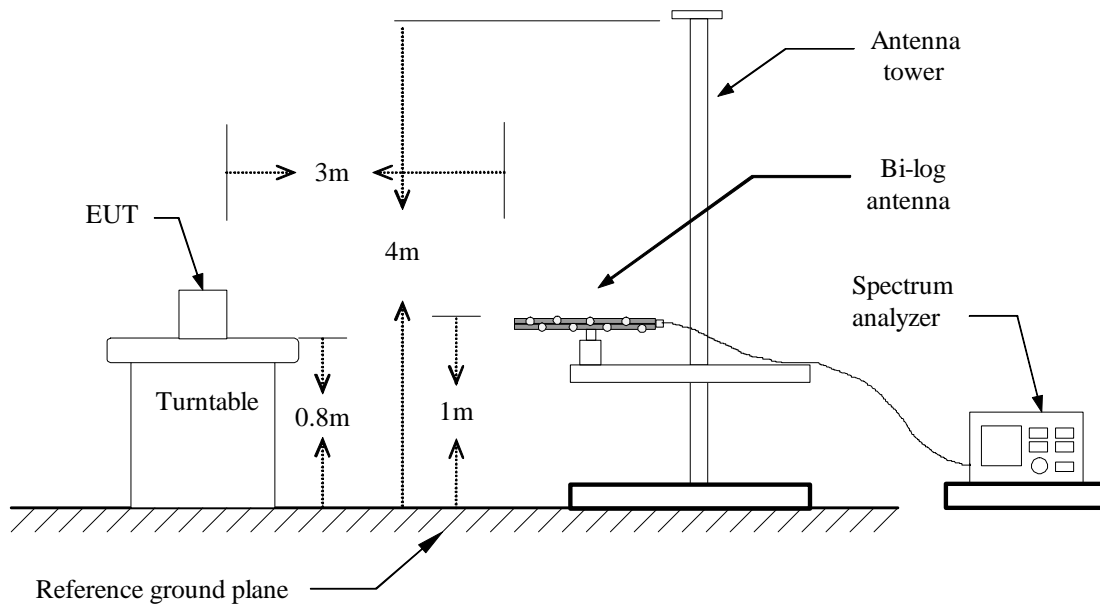





Above 1 GHz

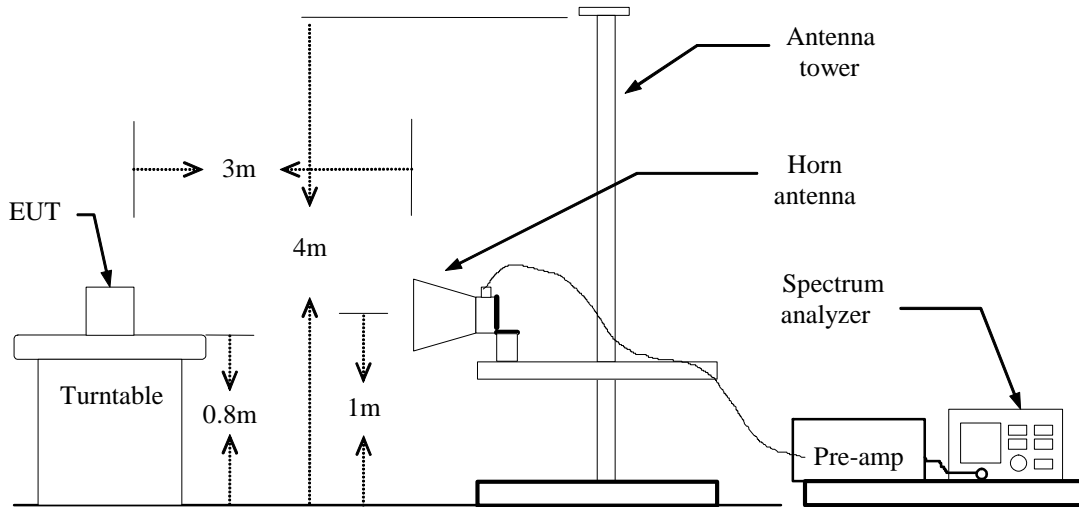



## **TEST PROCEDURE**

1. The EUT is placed on a turntable, which is 0.8m above ground plane.
2. The turntable shall be rotated for 360 degrees to determine the position of maximum emission level.
3. EUT is set 3m away from the receiving antenna, which is varied from 1m to 4m to find out the highest emissions.
4. Maximum procedure was performed on the six highest emissions to ensure EUT compliance.
5. And also, each emission was to be maximized by changing the polarization of receiving antenna both horizontal and vertical.
6. Set the spectrum analyzer in the following setting as:  
Below 1GHz:  
RBW=100kHz / VBW=300kHz / Sweep=AUTO  
Above 1GHz:  
(a) PEAK: RBW=1MHz / VBW=3MHz / Sweep=AUTO  
(b) AVERAGE: RBW=1MHz / VBW=300Hz / Sweep=AUTO
7. Repeat above procedures until the measurements for all frequencies are complete.

**Below 1 GHz****Operation Mode:** Normal Link **Test Date:** April 28, 2014**Temperature:** 27°C **Tested by:** David Shu**Humidity:** 53 % RH **Polarity:** Ver. / Hor.

Frequency (MHz)	Reading (dBuV)	Correction Factor (dB/m)	Result (dBuV/m)	Limit (dBuV/m)	Margin (dB)	Remark	Ant.Pol. (H/V)
36.7900	47.36	-14.85	32.51	40.00	-7.49	peak	V
76.5600	52.10	-22.90	29.20	40.00	-10.80	peak	V
259.8900	33.28	-17.68	15.60	46.00	-30.40	peak	V
449.0400	35.30	-12.69	22.61	46.00	-23.39	peak	V
668.2600	30.21	-9.12	21.09	46.00	-24.91	peak	V
852.5600	28.68	-6.75	21.93	46.00	-24.07	peak	V
36.7900	45.81	-14.85	30.96	40.00	-9.04	peak	H
76.5600	48.48	-22.90	25.58	40.00	-14.42	peak	H
320.0300	42.28	-15.92	26.36	46.00	-19.64	peak	H
533.4300	33.23	-11.28	21.95	46.00	-24.05	peak	H
749.7400	29.90	-7.88	22.02	46.00	-23.98	peak	H
893.3000	29.30	-6.24	23.06	46.00	-22.94	peak	H

**Remark:**

1. No emission found between lowest internal used/generated frequency to 30MHz (9kHz~30MHz)
2. Radiated emissions measured in frequency range from 30 MHz to 1000MHz were made with an instrument using peak/quasi-peak detector mode.
3. Quasi-peak test would be performed if the peak result were greater than the quasi-peak limit or as required by the applicant.
4. Measurements above show only up to 6 maximum emissions noted, or would be lesser, with " N/A " remark, if no specific emissions from the EUT are recorded (ie: margin>20dB from the applicable limit) and considered that's already beyond the background noise floor.
5.  $Margin (dB) = Remark\ result (dBuV/m) - Quasi-peak\ limit (dBuV/m)$ .



**Above 1 GHz**

**Operation Mode:** TX / GFSK / DH5 / CH Low

**Test Date:** April 28, 2014

**Temperature:** 27°C

**Tested by:** David, Shu

**Humidity:** 53 % RH

**Polarity:** Ver. / Hor.

Frequency (MHz)	Reading (dBuV)	Correction (dB/m)	Result (dBuV/m)	Limit (dBuV/m)	Margin (dB)	Remark	Ant.Pol. (H/V)
1890.000	50.61	-5.67	44.94	74.00	-29.06	peak	V
N/A							
2282.000	51.87	-4.47	47.40	74.00	-26.60	peak	H
N/A							

**Remark:**

1. Measuring frequencies from 1 GHz to the 10th harmonic of highest fundamental frequency.
2. Radiated emissions measured in frequency above 1000MHz were made with an instrument using peak/average detector mode.
3. Average test would be performed if the peak result were greater than the average limit .
4. Data of measurement within this frequency range shown “ --- ” in the table above means the reading of emissions are attenuated more than 20dB below the permissible limits or the field strength is too small to be measured.
5. Measurements above show only up to 6 maximum emissions noted, or would be lesser, with “ N/A ” remark, if no specific emissions from the EUT are recorded (ie: margin>20dB from the applicable limit) and considered that's already beyond the background noise floor.
6. Margin (dB) = Remark result (dBuV/m) – Average limit (dBuV/m).



Operation Mode: TX / GFSK / DH5 / CH Mid

Test Date: April 28, 2014

Temperature: 27°C

Tested by: David, Shu

Humidity: 53 % RH

Polarity: Ver. / Hor.

Frequency (MHz)	Reading (dBuV)	Correction (dB/m)	Result (dBuV/m)	Limit (dBuV/m)	Margin (dB)	Remark	Ant.Pol. (H/V)
1970.000	51.29	-5.17	46.12	74.00	-27.88	peak	V
N/A							
1892.000	51.29	-5.65	45.64	74.00	-28.36	peak	H
N/A							

Remark:

1. Measuring frequencies from 1 GHz to the 10th harmonic of highest fundamental frequency.
2. Radiated emissions measured in frequency above 1000MHz were made with an instrument using peak/average detector mode.
3. Average test would be performed if the peak result were greater than the average limit.
4. Data of measurement within this frequency range shown “ --- ” in the table above means the reading of emissions are attenuated more than 20dB below the permissible limits or the field strength is too small to be measured.
5. Measurements above show only up to 6 maximum emissions noted, or would be lesser; with “ N/A ” remark, if no specific emissions from the EUT are recorded (ie: margin>20dB from the applicable limit) and considered that's already beyond the background noise floor.
6. Margin (dB) = Remark result (dBuV/m) – Average limit (dBuV/m).



Operation Mode: TX / GFSK / DH5 / CH High

Test Date: April 28, 2014

Temperature: 27°C

Tested by: David, Shu

Humidity: 53 % RH

Polarity: Ver. / Hor.

Frequency (MHz)	Reading (dBuV)	Correction (dB/m)	Result (dBuV/m)	Limit (dBuV/m)	Margin (dB)	Remark	Ant.Pol. (H/V)
1334.000	58.49	-9.11	49.38	74.00	-24.62	peak	V
N/A							
1976.000	51.26	-5.14	46.12	74.00	-27.88	peak	H
N/A							

Remark:

1. Measuring frequencies from 1 GHz to the 10th harmonic of highest fundamental frequency.
2. Radiated emissions measured in frequency above 1000MHz were made with an instrument using peak/average detector mode.
3. Average test would be performed if the peak result were greater than the average limit.
4. Data of measurement within this frequency range shown “ --- ” in the table above means the reading of emissions are attenuated more than 20dB below the permissible limits or the field strength is too small to be measured.
5. Measurements above show only up to 6 maximum emissions noted, or would be lesser; with “ N/A ” remark, if no specific emissions from the EUT are recorded (ie: margin>20dB from the applicable limit) and considered that's already beyond the background noise floor.
6. Margin (dB) = Remark result (dBuV/m) – Average limit (dBuV/m).



Operation Mode: TX / 8DPSK / DH5 / CH Low

Test Date: April 28, 2014

Temperature: 27°C

Tested by: David, Shu

Humidity: 53 % RH

Polarity: Ver. / Hor.

Frequency (MHz)	Reading (dBuV)	Correction (dB/m)	Result (dBuV/m)	Limit (dBuV/m)	Margin (dB)	Remark	Ant.Pol. (H/V)
1634.000	51.73	-7.24	44.49	74.00	-29.51	peak	V
N/A							
1816.000	51.34	-6.12	45.22	74.00	-28.78	peak	H
N/A							

Remark:

1. Measuring frequencies from 1 GHz to the 10th harmonic of highest fundamental frequency.
2. Radiated emissions measured in frequency above 1000MHz were made with an instrument using peak/average detector mode.
3. Average test would be performed if the peak result were greater than the average limit.
4. Data of measurement within this frequency range shown “ --- ” in the table above means the reading of emissions are attenuated more than 20dB below the permissible limits or the field strength is too small to be measured.
5. Measurements above show only up to 6 maximum emissions noted, or would be lesser; with “ N/A ” remark, if no specific emissions from the EUT are recorded (ie: margin>20dB from the applicable limit) and considered that's already beyond the background noise floor.
6. Margin (dB) = Remark result (dBuV/m) – Average limit (dBuV/m).



Operation Mode: TX / 8DPSK / DH5 / CH Mid

Test Date: April 28, 2014

Temperature: 27°C

Tested by: David, Shu

Humidity: 53 % RH

Polarity: Ver. / Hor.

Frequency (MHz)	Reading (dBuV)	Correction (dB/m)	Result (dBuV/m)	Limit (dBuV/m)	Margin (dB)	Remark	Ant.Pol. (H/V)
1764.000	51.17	-6.44	44.73	74.00	-29.27	peak	V
N/A							
1624.000	51.78	-7.30	44.48	74.00	-29.52	peak	H
N/A							

Remark:

1. Measuring frequencies from 1 GHz to the 10th harmonic of highest fundamental frequency.
2. Radiated emissions measured in frequency above 1000MHz were made with an instrument using peak/average detector mode.
3. Average test would be performed if the peak result were greater than the average limit.
4. Data of measurement within this frequency range shown “ --- ” in the table above means the reading of emissions are attenuated more than 20dB below the permissible limits or the field strength is too small to be measured.
5. Measurements above show only up to 6 maximum emissions noted, or would be lesser; with “ N/A ” remark, if no specific emissions from the EUT are recorded (ie: margin>20dB from the applicable limit) and considered that's already beyond the background noise floor.
6. Margin (dB) = Remark result (dBuV/m) – Average limit (dBuV/m).





Operation Mode: TX / 8DPSK / DH5 / CH High

Test Date: April 28, 2014

Temperature: 27°C

Tested by: David, Shu

Humidity: 53 % RH

Polarity: Ver. / Hor.

Frequency (MHz)	Reading (dBuV)	Correction (dB/m)	Result (dBuV/m)	Limit (dBuV/m)	Margin (dB)	Remark	Ant.Pol. (H/V)
1786.000	52.50	-6.30	46.20	74.00	-27.80	peak	V
N/A							
2082.000	51.19	-4.82	46.37	74.00	-27.63	peak	H
N/A							

Remark:

1. Measuring frequencies from 1 GHz to the 10th harmonic of highest fundamental frequency.
2. Radiated emissions measured in frequency above 1000MHz were made with an instrument using peak/average detector mode.
3. Average test would be performed if the peak result were greater than the average limit.
4. Data of measurement within this frequency range shown “ --- ” in the table above means the reading of emissions are attenuated more than 20dB below the permissible limits or the field strength is too small to be measured.
5. Measurements above show only up to 6 maximum emissions noted, or would be lesser; with “ N/A ” remark, if no specific emissions from the EUT are recorded (ie: margin>20dB from the applicable limit) and considered that's already beyond the background noise floor.
6. Margin (dB) = Remark result (dBuV/m) – Average limit (dBuV/m).



## 7.10 POWERLINE CONDUCTED EMISSIONS

### LIMIT

According to §15.207(a) & RSS-Gen §7.2.4, except as shown in paragraphs (b) and (c) of this section, for an intentional radiator that is designed to be connected to the public utility (AC) power line, the radio frequency voltage that is conducted back onto the AC power line on any frequency or frequencies within the band 150 kHz to 30 MHz shall not exceed the limits in the following table, as measured using a 50 μH/50 ohms line impedance stabilization network (LISN). Compliance with the provisions of this paragraph shall be based on the measurement of the radio frequency voltage between each power line and ground at the power terminal. The lower limit applies at the boundary between the frequency ranges.

Frequency Range (MHz)	Limits (dBμV)	
	Quasi-peak	Average
0.15 to 0.50	66 to 56*	56 to 46*
0.50 to 5	56	46
5 to 30	60	50

\* Decreases with the logarithm of the frequency.

### Test Configuration

See test photographs attached in Appendix II for the actual connections between EUT and support equipment.

### TEST PROCEDURE

1. The EUT was placed on a table, which is 0.8m above ground plane.
2. Maximum procedure was performed on the six highest emissions to ensure EUT compliance.
3. Repeat above procedures until all frequency measured were complete.



## TEST RESULTS

The initial step in collecting conducted data is a spectrum analyzer peak scan of the measurement range. Significant peaks are then marked as shown on the following data page, and these signals are then quasi-peaked.

### Test Data

**Operation Mode:** Normal Link                      **Test Date:** May 2, 2014  
**Temperature:** 26°C                                      **Tested by:** Sehni Hu  
**Humidity:** 60% RH

Freq. (MHz)	QP Reading (dBuV)	AV Reading (dBuV)	Corr. factor (dB/m)	QP Result (dBuV/m)	AV Result (dBuV/m)	QP Limit (dBuV)	AV Limit (dBuV)	QP Margin (dB)	AV Margin (dB)	Note
0.1780	39.54	32.83	0.19	39.73	33.02	64.58	54.58	-24.85	-21.56	L1
0.2180	27.83	18.08	0.19	28.02	18.27	62.89	52.89	-34.87	-34.62	L1
0.5140	31.44	23.63	0.20	31.64	23.83	56.00	46.00	-24.36	-22.17	L1
0.5860	31.38	23.37	0.20	31.58	23.57	56.00	46.00	-24.42	-22.43	L1
2.5780	27.06	20.29	0.16	27.22	20.45	56.00	46.00	-28.78	-25.55	L1
5.0740	19.49	10.27	0.24	19.73	10.51	60.00	50.00	-40.27	-39.49	L1
0.1722	31.68	21.19	0.19	31.87	21.38	64.85	54.85	-32.98	-33.47	L2
0.2620	31.84	25.36	0.19	32.03	25.55	61.37	51.37	-29.34	-25.82	L2
0.4860	36.73	31.63	0.19	36.92	31.82	56.24	46.24	-19.32	-14.42	L2
1.1020	32.35	25.45	0.19	32.54	25.64	56.00	46.00	-23.46	-20.36	L2
2.4700	29.72	23.43	0.13	29.85	23.56	56.00	46.00	-26.15	-22.44	L2
7.0500	23.06	15.89	0.29	23.35	16.18	60.00	50.00	-36.65	-33.82	L2

### **Remark:**

1. Measuring frequencies from 0.15 MHz to 30MHz.
2. The emissions measured in frequency range from 0.15 MHz to 30MHz were made with an instrument using Quasi-peak detector and average detector.
3. The IF bandwidth of SPA between 0.15MHz and 30MHz was 10 kHz; the IF bandwidth of Test Receiver between 0.15MHz and 30MHz was 9 kHz;
4. L1 = Line One (Live Line) / L2 = Line Two (Neutral Line)



**Test Plots**

**Conducted emissions (Line 1)**

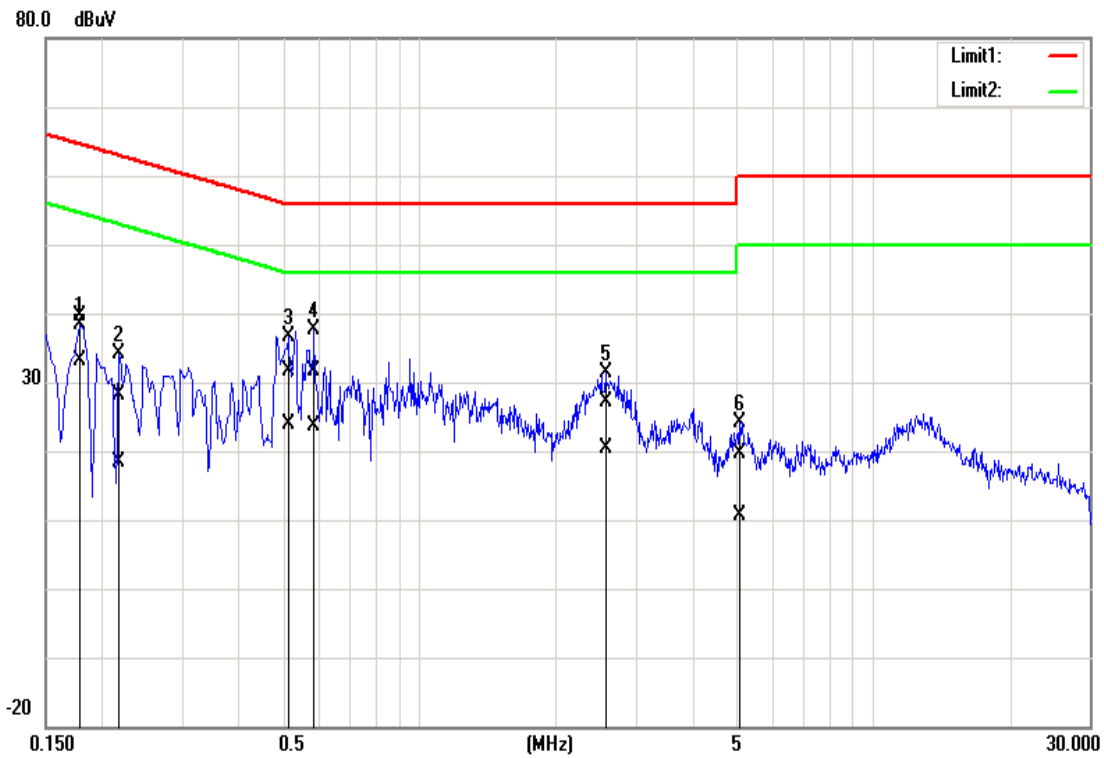

**Conducted emissions (Line 2)**

