



**FCC 47 CFR PART 15 SUBPART C &
INDUSTRY CANADA RSS-210**

TEST REPORT

For

Tablet Computer

FCC Model: WT10-A, WT10-B

IC Mode: WT10-A

Trade Name: TOSHIBA

Issued to

Pegatron Corporation

5F, NO. 76, LIGONG ST., BEITOU DISTRICT, TAIPEI CITY 112, TAIWAN (R.O.C.)

Issued by

Compliance Certification Services Inc.

**No.11, Wugong 6th Rd., Wugu Dist.,
New Taipei City 24891, Taiwan. (R.O.C.)**

<http://www.ccsrf.com>

service@ccsrf.com

Issued Date: May 8, 2014



Testing Laboratory
1309

Note: This report shall not be reproduced except in full, without the written approval of Compliance Certification Services Inc. This document may be altered or revised by Compliance Certification Services Inc. personnel only, and shall be noted in the revision section of the document.



Revision History

Rev.	Issue Date	Revisions	Effect Page	Revised By
00	May 8, 2014	Initial Issue	ALL	Becca Chen



TABLE OF CONTENTS

1. TEST RESULT CERTIFICATION	4
2. EUT DESCRIPTION	5
3. TEST METHODOLOGY	6
3.1 EUT CONFIGURATION	6
3.2 EUT EXERCISE.....	6
3.3 GENERAL TEST PROCEDURES	6
3.4 FCC PART 15.205 RESTRICTED BANDS OF OPERATIONS	7
3.5 DESCRIPTION OF TEST MODES.....	8
4 INSTRUMENT CALIBRATION	9
4.1 MEASURING INSTRUMENT CALIBRATION.....	9
4.2 MEASUREMENT EQUIPMENT USED	9
4.3 MEASUREMENT UNCERTAINTY.....	10
5 FACILITIES AND ACCREDITATIONS	11
5.1 FACILITIES	11
5.2 EQUIPMENT	11
5.3 TABLE OF ACCREDITATIONS AND LISTINGS	12
6 SETUP OF EQUIPMENT UNDER TEST	13
6.1 SETUP CONFIGURATION OF EUT	13
6.2 SUPPORT EQUIPMENT	13
7 FCC PART 15.247 REQUIREMENTS & RSS 210 REQUIREMENTS	14
7.1 99% BANDWIDTH	14
7.2 6DB BANDWIDTH	17
7.3 PEAK POWER.....	21
7.4 AVERAGE POWER	22
7.5 BAND EDGES MEASUREMENT.....	23
7.6 PEAK POWER SPECTRAL DENSITY	31
7.7 SPURIOUS EMISSIONS.....	35
7.8 POWERLINE CONDUCTED EMISSIONS.....	47
APPENDIX I PHOTOGRAPHS OF TEST SETUP	50
APPENDIX 1 - PHOTOGRAPHS OF EUT	



1. TEST RESULT CERTIFICATION

Applicant: Pegatron Corporation
5F, NO. 76, LIGONG ST., BEITOU DISTRICT, TAIPEI CITY
112, TAIWAN (R.O.C.)

Manufacturer: Toshiba Corporation
1-1, Shibaura 1-Chome, Minato-Ku, Tokyo, 105-8001, Japan

Equipment Under Test: Tablet Computer

Trade Name: TOSHIBA

FCC Model: WT10-A, WT10-B

IC Model: WT10-A

Date of Test: April 28 ~ May 2, 2014

APPLICABLE STANDARDS	
STANDARD	TEST RESULT
FCC 47 CFR Part 15 Subpart C Industry Canada RSS-210 Issue 8 Annex 8 Industry Canada RSS-GEN Issue 3	No non-compliance noted
Deviation from Applicable Standard	
N/A	

We hereby certify that:

The above equipment was tested by Compliance Certification Services Inc. The test data, data evaluation, test procedures, and equipment configurations shown in this report were made in accordance with the procedures given in **ANSI C63.4: 2009** and the energy emitted by the sample EUT tested as described in this report is in compliance with the requirements set forth in the above standards.

The test results of this report relate only to the tested sample EUT identified in this report.

Approved by:

Reviewed by:

Miller Lee
Section Manager
Compliance Certification Services Inc.

Angel Cheng
Section Manager
Compliance Certification Services Inc.



2. EUT DESCRIPTION

Product	Tablet Computer
Trade Name	TOSHIBA
FCC Model Number	WT10-A, WT10-B
IC Model Number	WT10-A
Model Discrepancy	N/A
Received Date	April 21, 2014
EUT Power Rating	1. Power from Adaptor Chicony / W12-010N3A I/P: 100-240Vac, 50/60Hz, 0.3A O/P: 5Vdc, 2.0A 2. Powered from host device via USB Cable 3. Power from Battery LG (Trademark: Toshiba) / PA5204U-1BRS Rating: 3.75V 5820mAh
Frequency Range	2402MHz ~ 2480MHz
Transmit Power	7.62 dBm
Modulation Technique	BT 4.0 LE mode, GFSK (1Mbps)
Number of Channels	40 Channels
Antenna Specification	ACXC / Chip Antenna P/N: AT5020-B2R8HAAT/LF Gain: 2.629 dBi

Remark:

1. The sample selected for test was engineering sample that approximated to production product and was provided by manufacturer.
2. This submittal(s) (test report) is intended for FCC&IC ID: VUIPDAWT10-A & 7582A-PDAWT10-A filing to comply with FCC Part 15C, Section 15.207, 15.209 and IC RSS-210 & RSS-GEN.



3. TEST METHODOLOGY

The tests documented in this report were performed in accordance with ANSI C63.4: 2009 and FCC CFR 47 Part 15.207, 15.209, 15.247 and DA00-705.

The tests documented in this report were performed in accordance with IC RSS-210, IC RSS-Gen, IC RSS-102, IC RSS-212, and ANSI C63.4.

3.1 EUT CONFIGURATION

The EUT configuration for testing is installed on RF field strength measurement to meet the Commissions requirement and operating in a manner that intends to maximize its emission characteristics in a continuous normal application.

3.2 EUT EXERCISE

The EUT was operated in the engineering mode to fix the TX frequency that was for the purpose of the measurements.

According to its specifications, the EUT must comply with the requirements of the Section 15.207, 15.209 and 15.247 under the FCC Rules Part 15 Subpart C and RSS-210 Annex 8.

3.3 GENERAL TEST PROCEDURES

Conducted Emissions

The EUT is placed on the turntable, which is 0.8 m above ground plane. According to the requirements in Section 13.1.4.1 of ANSI C63.4 Conducted emissions from the EUT measured in the frequency range between 0.15 MHz and 30MHz using CISPR Quasi-peak and average detector modes.

Radiated Emissions

The EUT is placed on a turn table, which is 0.8 m above ground plane. The turntable shall rotate 360 degrees to determine the position of maximum emission level. EUT is set 3m away from the receiving antenna, which varied from 1m to 4m to find out the highest emission. And also, each emission was to be maximized by changing the polarization of receiving antenna both horizontal and vertical. In order to find out the maximum emissions, exploratory radiated emission measurements were made according to the requirements in Section 13.1.4.1 of ANSI C63.4.



3.4 FCC PART 15.205 RESTRICTED BANDS OF OPERATIONS

(a) Except as shown in paragraph (d) of this section, only spurious emissions are permitted in any of the frequency bands listed below:

MHz	MHz	MHz	GHz
0.090 - 0.110	16.42 - 16.423	399.9 - 410	4.5 - 5.15
¹ 0.495 - 0.505	16.69475 - 16.69525	608 - 614	5.35 - 5.46
2.1735 - 2.1905	16.80425 - 16.80475	960 - 1240	7.25 - 7.75
4.125 - 4.128	25.5 - 25.67	1300 - 1427	8.025 - 8.5
4.17725 - 4.17775	37.5 - 38.25	1435 - 1626.5	9.0 - 9.2
4.20725 - 4.20775	73 - 74.6	1645.5 - 1646.5	9.3 - 9.5
6.215 - 6.218	74.8 - 75.2	1660 - 1710	10.6 - 12.7
6.26775 - 6.26825	108 - 121.94	1718.8 - 1722.2	13.25 - 13.4
6.31175 - 6.31225	123 - 138	2200 - 2300	14.47 - 14.5
8.291 - 8.294	149.9 - 150.05	2310 - 2390	15.35 - 16.2
8.362 - 8.366	156.52475 -	2483.5 - 2500	17.7 - 21.4
8.37625 - 8.38675	156.52525	2655 - 2900	22.01 - 23.12
8.41425 - 8.41475	156.7 - 156.9	3260 - 3267	23.6 - 24.0
12.29 - 12.293	162.0125 - 167.17	3332 - 3339	31.2 - 31.8
12.51975 - 12.52025	167.72 - 173.2	3345.8 - 3358	36.43 - 36.5
12.57675 - 12.57725	240 - 285	3600 - 4400	(²)
13.36 - 13.41	322 - 335.4		

¹ Until February 1, 1999, this restricted band shall be 0.490-0.510 MHz.

² Above 38.6

(b) Except as provided in paragraphs (d) and (e), the field strength of emissions appearing within these frequency bands shall not exceed the limits shown in Section 15.209. At frequencies equal to or less than 1000 MHz, compliance with the limits in Section 15.209 shall be demonstrated using measurement instrumentation employing a CISPR quasi-peak detector. Above 1000 MHz, compliance with the emission limits in Section 15.209 shall be demonstrated based on the average value of the measured emissions. The provisions in Section 15.35 apply to these measurements.



3.5 DESCRIPTION OF TEST MODES

The EUT (model: WT10-A, WT10-B) is a 1x1 802.11abgn+ BT combo card module. WLAN and Bluetooth cannot transmit simultaneously.

Software used to control the EUT for staying in continuous transmitting mode was programmed.

After verification, all tests were carried out with the worst case test modes as shown below except radiated spurious emission below 1GHz and power line conducted emissions below 30MHz, which worst case was in normal link mode only.

BT 4.0

Tested Channel	Frequency (MHz)
Low	2402
Mid	2440
High	2480



4 INSTRUMENT CALIBRATION

4.1 MEASURING INSTRUMENT CALIBRATION

The measuring equipment, which was utilized in performing the tests documented herein, has been calibrated in accordance with the manufacturer's recommendations for utilizing calibration equipment, which is traceable to recognized national standards.

4.2 MEASUREMENT EQUIPMENT USED

Equipment Used for Emissions Measurement

Remark: Each piece of equipment is scheduled for calibration once a year and Loop Antenna is scheduled for calibration once three years.

Conducted Emissions Test Site				
Name of Equipment	Manufacturer	Model	Serial Number	Calibration Due
Spectrum Analyzer	Agilent	E4446A	MY43360131	03/19/2015
Power Meter	Anritsu	ML2495A	1012009	06/04/2014
Power Sensor	Anritsu	MA2411A	0917072	06/04/2014

Wugu 966 Chamber A				
Name of Equipment	Manufacturer	Model	Serial Number	Calibration Due
Spectrum Analyzer	Agilent	E4446A	US42510268	11/05/2014
EMI Test Receiver	R&S	ESCI	100064	02/27/2015
Pre-Amplifier	Mini-Circults	ZFL-1000LN	SF350700823	01/11/2015
Pre-Amplifier	MITEQ	AFS44-00102650-42-10P-44	1415367	11/18/2014
Bilog Antenna	Sunol Sciences	JB3	A030105	10/01/2014
Horn Antenna	EMCO	3117	00055165	02/12/2015
Horn Antenna	EMCO	3116	2487	10/09/2014
Loop Antenna	EMCO	6502	8905/2356	06/09/2014
Turn Table	CCS	CC-T-1F	N/A	N.C.R
Antenna Tower	CCS	CC-A-1F	N/A	N.C.R
Controller	CCS	CC-C-1F	N/A	N.C.R
Site NSA	CCS	N/A	N/A	12/21/2014
Test S/W	EZ-EMC (CCS-3A1RE)			

Conducted Emission room #A				
Name of Equipment	Manufacturer	Model	Serial Number	Calibration Due
EMI Test Receiver	R&S	ESI	101203	09/12/2014
LISN	R&S	ESH3-Z5	848773/014	12/05/2014
Coaxial Cable	Commate	CFD300-NL	NA	12/05/2014
Test S/W	CCS-3A1-CE			



4.3 MEASUREMENT UNCERTAINTY

PARAMETER	UNCERTAINTY
Powerline Conducted Emission	+/- 1.2159
3M Semi Anechoic Chamber / 30M~200M	+/- 4.0138
3M Semi Anechoic Chamber / 200M~1000M	+/- 3.9483
3M Semi Anechoic Chamber / 1G~8G	+/- 2.5975
3M Semi Anechoic Chamber / 8G~18G	+/- 2.6112
3M Semi Anechoic Chamber / 18G~26G	+/- 2.7389
3M Semi Anechoic Chamber / 26G~40G	+/- 2.9683

Remark: This uncertainty represents an expanded uncertainty expressed at approximately the 95% confidence level using a coverage factor of $k=2$.



5 FACILITIES AND ACCREDITATIONS

5.1 FACILITIES

All measurement facilities used to collect the measurement data are located at

No.199, Chungshen Road, Hsintien City, Taipei Hsien, Taiwan, R.O.C.

Tel: 886-2-2217-0894 / Fax: 886-2-2217-1029

No.11, Wugong 6th Rd., Wugu Dist., New Taipei City 24891, Taiwan. (R.O.C.)

Tel: 886-2-2299-9720 / Fax: 886-2-2298-4045

No.81-1, Lane 210, Bade 2nd Rd., Lujhu Township, Taoyuan County 33841, TAIWAN, R.O.C.

Tel: 886-3-324-0332 / Fax: 886-3-324-5235

The sites are constructed in conformance with the requirements of ANSI C63.7, ANSI C63.4 and CISPR Publication 22.

5.2 EQUIPMENT

Radiated emissions are measured with one or more of the following types of linearly polarized antennas: tuned dipole, biconical, log periodic, bi-log, and/or ridged waveguide, horn. Spectrum analyzers with pre-selectors and quasi-peak detectors are used to perform radiated measurements.



Conducted emissions are measured with Line Impedance Stabilization Networks and EMI Test Receivers.

Calibrated wideband preamplifiers, coaxial cables, and coaxial attenuators are also used for making measurements.

All receiving equipment conforms to CISPR Publication 16-1, "Radio Interference Measuring Apparatus and Measurement Methods."



5.3 TABLE OF ACCREDITATIONS AND LISTINGS

Country	Agency	Scope of Accreditation	Logo
USA	FCC	3M Semi Anechoic Chamber (FCC MRA: TW1039) to perform FCC Part 15 measurements	 FCC MRA: TW1039
Taiwan	TAF	LP0002, RTTE01, FCC Method-47 CFR Part 15 Subpart C, D, E, RSS-210, RSS-310 IDA TS SRD, AS/NZS 4268, AS/NZS 4771, TS 12.1 & 12.2, ETSI EN 300 440-1, ETSI EN 300 440-2, ETSI EN 300 328, ETSI EN 300 220-1, ETSI EN 300 220-2, ETSI EN 301 893, ETSI EN 301 489-1/3/7/17 FCC OET Bulletin 65 + Supplement C, EN 50360, EN 50361, EN 50371, RSS 102, EN 50383, EN 50385, EN 50392, IEC 62209, CNS 14958-1, CNS 14959 FCC Method -47 CFR Part 15 Subpart B IEC / EN 61000-3-2, IEC / EN 61000-3-3, IEC / EN 61000-4-2/3/4/5/6/8/11	 Testing Laboratory 1309
Canada	Industry Canada	3M Semi Anechoic Chamber (IC 2324G-1 / IC 2324G-2) to perform	 IC 2324G-1 IC 2324G-2

* No part of this report may be used to claim or imply product endorsement by A2LA or any agency of the US Government.



6 SETUP OF EQUIPMENT UNDER TEST

6.1 SETUP CONFIGURATION OF EUT

See test photographs attached in Appendix II for the actual connections between EUT and support equipment.

6.2 SUPPORT EQUIPMENT

No.	Device Type	Brand	Model	Series No.	FCC ID	Data Cable	Power Cord
	N/A						

Remark:

1. *All the equipment/cables were placed in the worst-case configuration to maximize the emission during the test.*
2. *Grounding was established in accordance with the manufacturer's requirements and conditions for the intended use.*



7 FCC PART 15.247 REQUIREMENTS & RSS 210 REQUIREMENTS

7.1 99% BANDWIDTH

Test Configuration

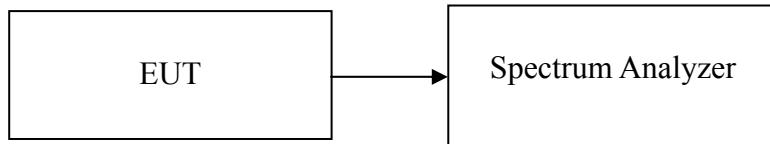

TEST PROCEDURE

The resolution bandwidth shall be set to as close to 1% of the selected span as is possible without being below 1%. The video bandwidth shall be set to 3 times the resolution bandwidth. Video averaging is not permitted. Where practical, a sampling detector shall be used since a peak or, peak hold.

TEST RESULTS

No non-compliance noted.

Test Data

For GFSK

Channel	Frequency (MHz)	99% Bandwidth (MHz)
Low	2402	1.0464
Mid	2441	1.0486
High	2480	1.0518



Test Plot

99% Bandwidth (CH Low)

Agilent

R L

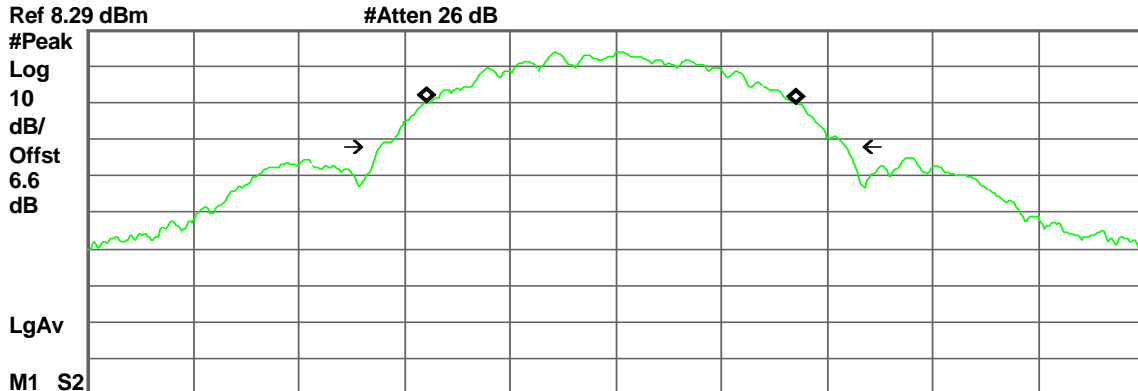

Occupied Bandwidth
1.0464 MHz

Occ BW % Pwr 99.00 %
x dB -26.00 dB

Transmit Freq Error -11.862 kHz
x dB Bandwidth 1.326 MHz

99% Bandwidth (CH Mid)

Agilent

R L

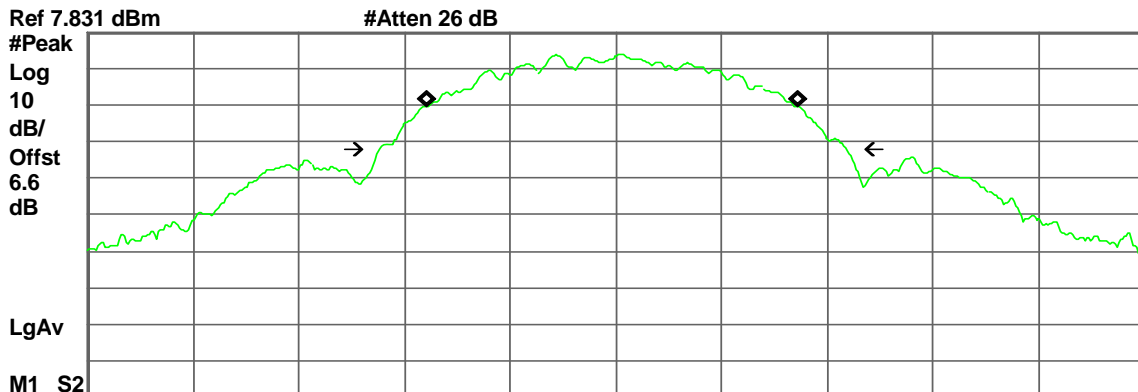

Occupied Bandwidth
1.0486 MHz

Occ BW % Pwr 99.00 %
x dB -26.00 dB

Transmit Freq Error -11.611 kHz
x dB Bandwidth 1.331 MHz



99% Bandwidth (CH High)

Agilent

R L

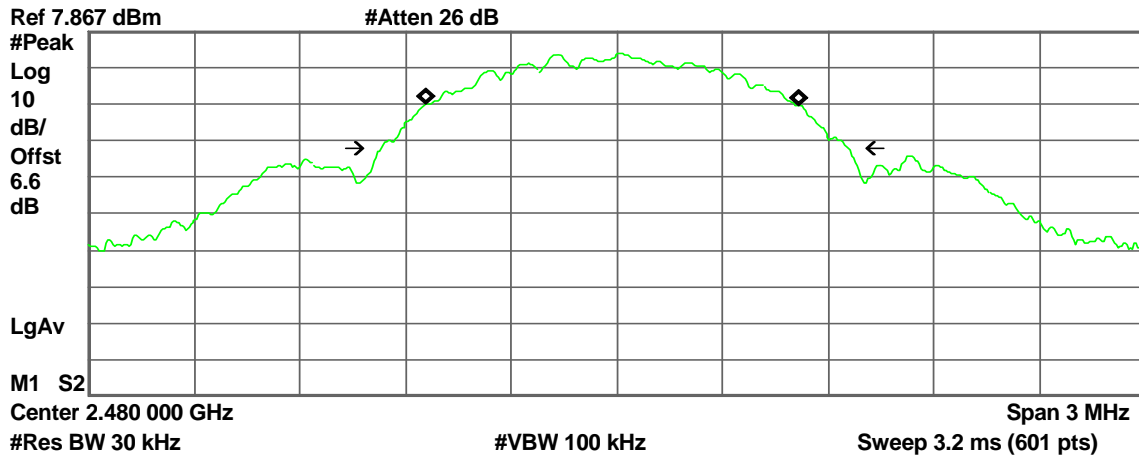

Occupied Bandwidth
1.0518 MHz

Occ BW % Pwr	99.00 %
x dB	-26.00 dB

Transmit Freq Error	-12.135 kHz
x dB Bandwidth	1.329 MHz



7.2 6DB BANDWIDTH

LIMIT

According to §15.247(a)(2) & RSS-210 §A8.2(a), systems using digital modulation techniques may operate in the 902 - 928 MHz, 2400 - 2483.5 MHz, and 5725 - 5850 MHz bands. The minimum 6dB bandwidth shall be at least 500 kHz.

Test Configuration

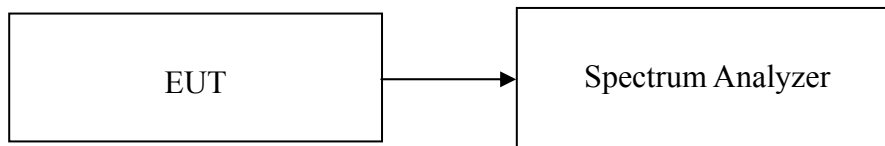

TEST PROCEDURE

The transmitter output is connected to the spectrum analyzer. Set the RBW = 1%-5% of the emission bandwidth, VBW $\geq 3 \times$ RBW, Detector = Peak, Trace mode = max hold, Sweep = auto couple. Measure the maximum width of the emission that is constrained by the frequencies associated with the two amplitude points (upper and lower) that are attenuated by 6dB relative to the maximum level measured in the fundamental emission.

TEST RESULTS

No non-compliance noted

Test Data

Channel	Frequency (MHz)	6dB Bandwidth (MHz)	Limit (kHz)	Test Result
Low	2402	0.75	>500	PASS
Mid	2440	0.75		PASS
High	2480	0.75		PASS



Test Plot

6dB Bandwidth (CH Low)

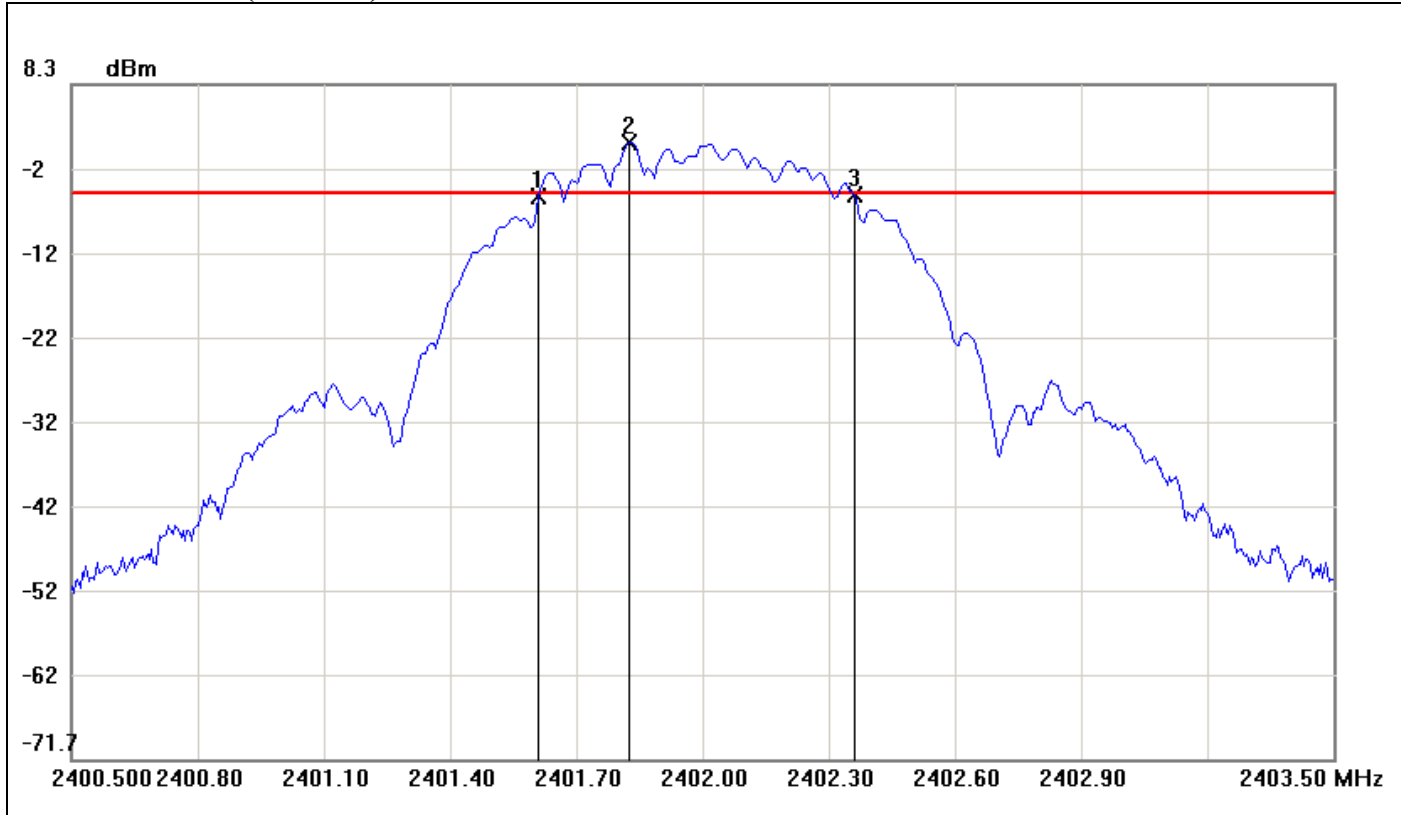

No.	Frequency(MHz)	Result(dBm)	Limit(dBm)	Margin(dBm)
1	2401.6100	-5.07	-4.57	-0.50
2	2401.8250	1.43	-4.57	6.00
3	2402.3600	-4.79	-4.57	-0.22

No.		Δ Frequency(MHz)	Δ Level(dB)
1	mk3-mk1	0.75	0.28



6dB Bandwidth (CH Mid)

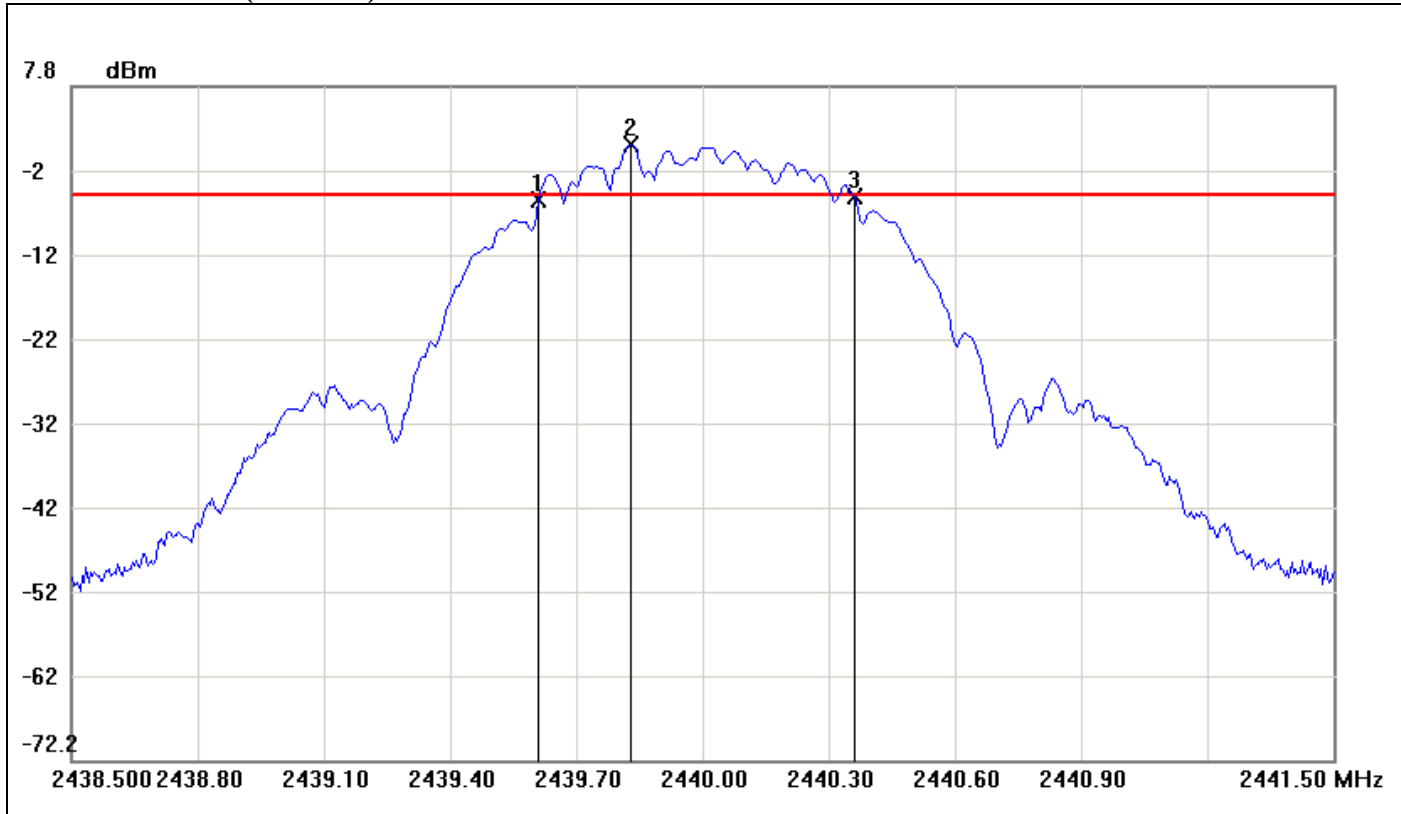

No.	Frequency(MHz)	Result(dBm)	Limit(dBm)	Margin(dBm)
1	2439.6100	-5.69	-5.08	-0.61
2	2439.8300	0.92	-5.08	6.00
3	2440.3600	-5.25	-5.08	-0.17

No.		Δ Frequency(MHz)	Δ Level(dB)
1	mk3-mk1	0.75	0.44



6dB Bandwidth (CH High)

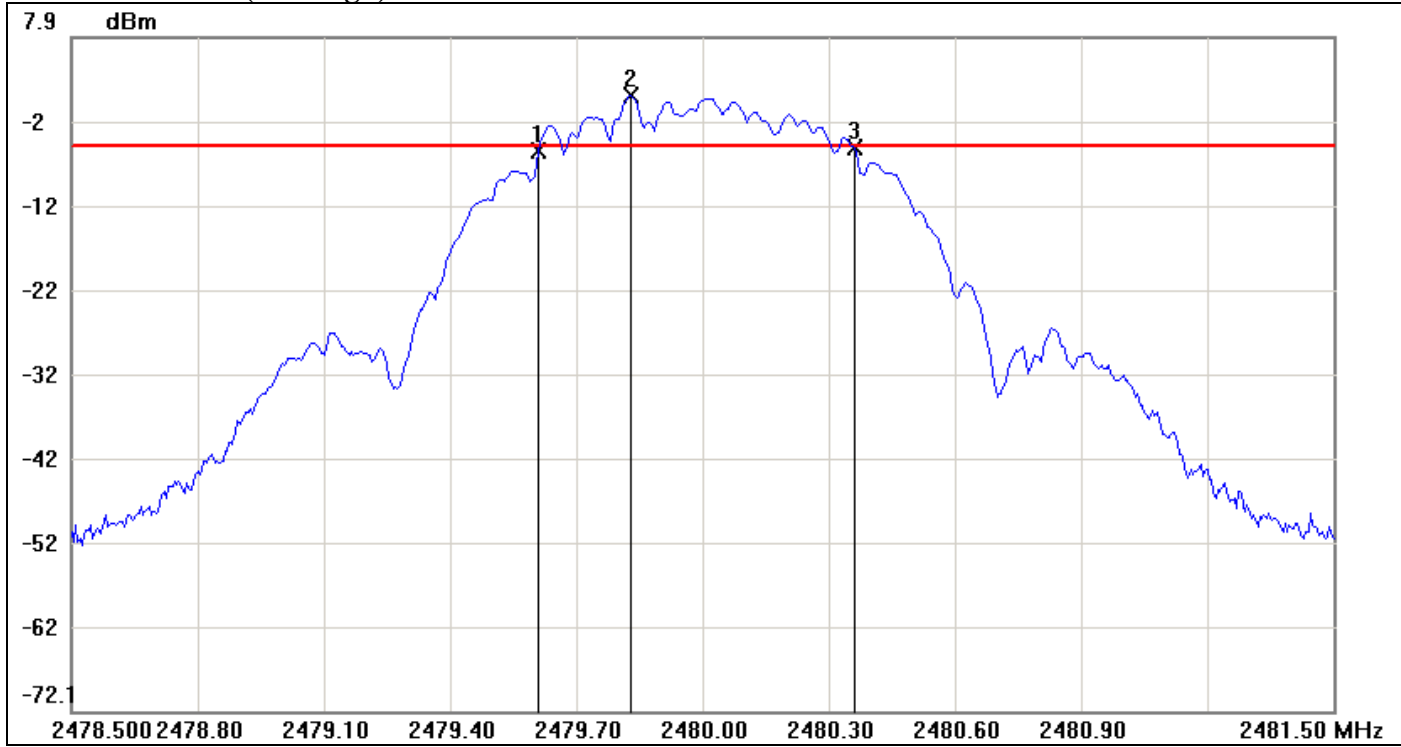

No.	Frequency(MHz)	Result(dBm)	Limit(dBm)	Margin(dBm)
1	2479.6100	-5.56	-5.05	-0.51
2	2479.8300	0.95	-5.05	6.00
3	2480.3600	-5.24	-5.05	-0.19

No.		Δ Frequency(MHz)	Δ Level(dB)
1	mk3-mk1	0.75	0.32



7.3 PEAK POWER

LIMIT

The maximum peak output power of the intentional radiator shall not exceed the following:

1. According to §15.247(b)(3), for systems using digital modulation in the bands of 902-928 MHz, 2400-2483.5 MHz, and 5725-5850 MHz: 1 Watt.
2. According to §15.247(b)(4), the conducted output power limit specified in paragraph (b) of this section is based on the use of antennas with directional gains that do not exceed 6 dBi. Except as shown in paragraph (c) of this section, if transmitting antennas of directional gain greater than 6 dBi are used, the conducted output power from the intentional radiator shall be reduced below the stated values in paragraphs (b)(1), (b)(2), and (b)(3) of this section, as appropriate, by the amount in dB that the directional gain of the antenna exceeds 6 dBi.
3. According to RSS-210 §A8.4(4), for systems employing digital modulation techniques operating in the bands 902-928 MHz, 2400-2483.5 MHz and 5725-5850 MHz, the maximum peak conducted output power shall not exceed 1 W.

Test Configuration

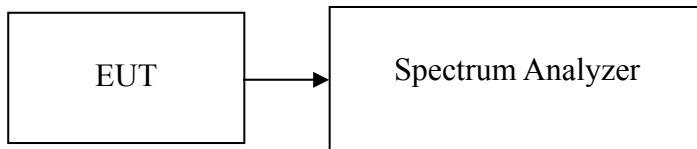

TEST PROCEDURE

The transmitter output is connected to the spectrum analyzer. Set the RBW = 1MHz , VBW = 3MHz, Detector = Peak, Trace mode = max hold, Sweep = auto couple. Record the max reading. Repeat the above procedure until the measurements for all frequencies are completed.

TEST RESULTS

No non-compliance noted

Test Data

Channel	Frequency (MHz)	Output Power (dBm)	Output Power (W)	Limit (W)	Test Result
Low	2402	7.62	0.0058	1	PASS
Mid	2440	7.13	0.0052		PASS
High	2480	7.12	0.0052		PASS



7.4 AVERAGE POWER

LIMIT

None; for reporting purposes only.

Test Configuration

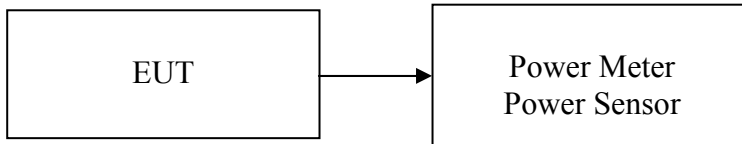

TEST PROCEDURE

The transmitter output is connected to the Power Meter. The Power Meter is set to the Average power detection.

TEST RESULTS

No non-compliance noted

Test Data

Channel	Frequency (MHz)	Output Power (dBm)	Output Power (W)	Limit (W)	Test Result
Low	2402	5.69	0.0037	1	PASS
Mid	2440	5.64	0.0037		PASS
High	2480	5.59	0.0036		PASS



7.5 BAND EDGES MEASUREMENT

LIMIT

According to §15.247(d) & RSS-210 §A8.5, in any 100 kHz bandwidth outside the frequency bands in which the spread spectrum intentional radiator is operating, the radio frequency power that is produced by the intentional radiator shall be at least 20 dB below that in the 100 kHz bandwidth within the band that contains the highest level of the desired power, based on either an RF conducted or a radiated measurement, provided the transmitter demonstrates compliance with the peak conducted power limits. In addition, radiated emissions which fall in the restricted bands, as defined in §15.205(a), must also comply with the radiated emission limits specified in 15.209(a) (see Section 15.205(c)).

Test Configuration

For Radiated

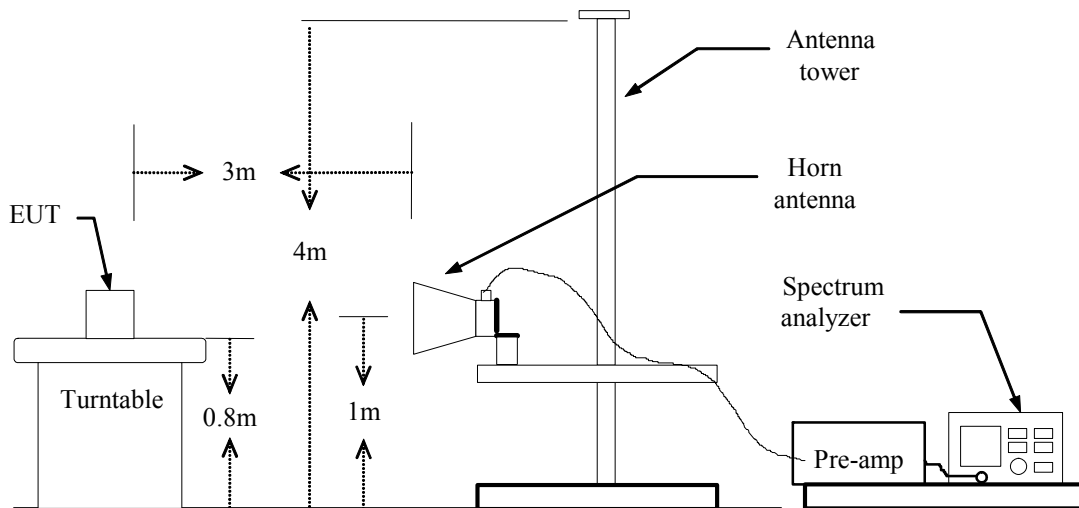

For Conducted

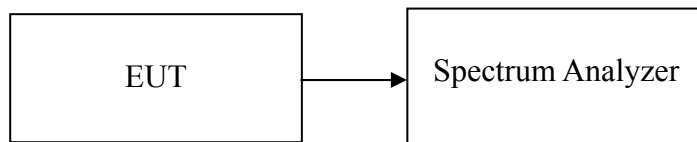



TEST PROCEDURE

For Radiated

1. The EUT is placed on a turntable, which is 0.8m above the ground plane.
2. The turntable shall be rotated for 360 degrees to determine the position of maximum emission level.
3. EUT is set 3m away from the receiving antenna, which is varied from 1m to 4m to find out the highest emission.
4. Set the spectrum analyzer in the following setting in order to capture the lower and upper band-edges of the emission:
 - (a) PEAK: RBW=1MHz / VBW=3MHz / Sweep=AUTO
 - (b) AVERAGE: RBW=1MHz / VBW=300Hz / Sweep=AUTO
5. Repeat the procedures until all the PEAK and AVERAGE versus POLARIZATION are measured.

For Conducted

Conducted RF measurements of the transmitter output were made to confirm that the EUT antenna port conducted emissions meet the specified limit and to identify any spurious signals that require further investigation or measurements on the radiated emissions site.

The transmitter output is connected to the spectrum analyzer. The resolution bandwidth is set to 100 kHz. The video bandwidth is set to 100 kHz.

TEST RESULTS

Refer to attach spectrum analyzer data chart.



Band Edges (CH Low)

Detector mode: Peak

Polarity: Vertical

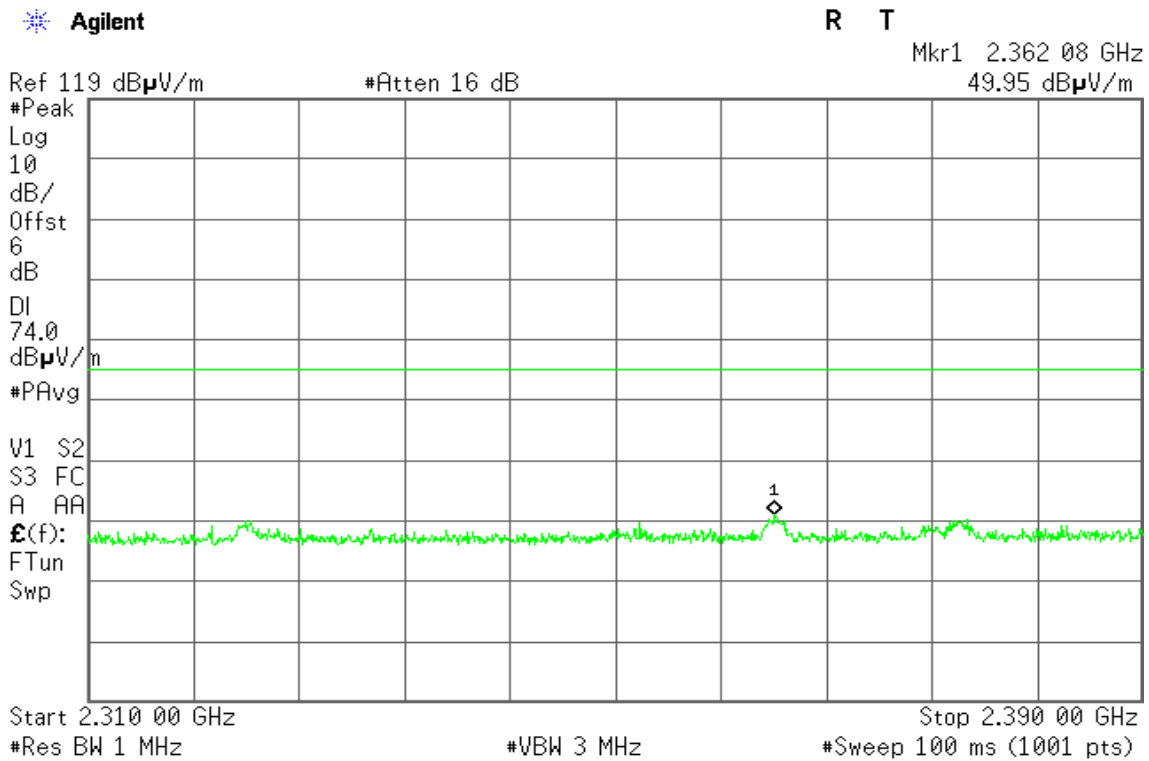

Detector mode: Average

Polarity: Vertical

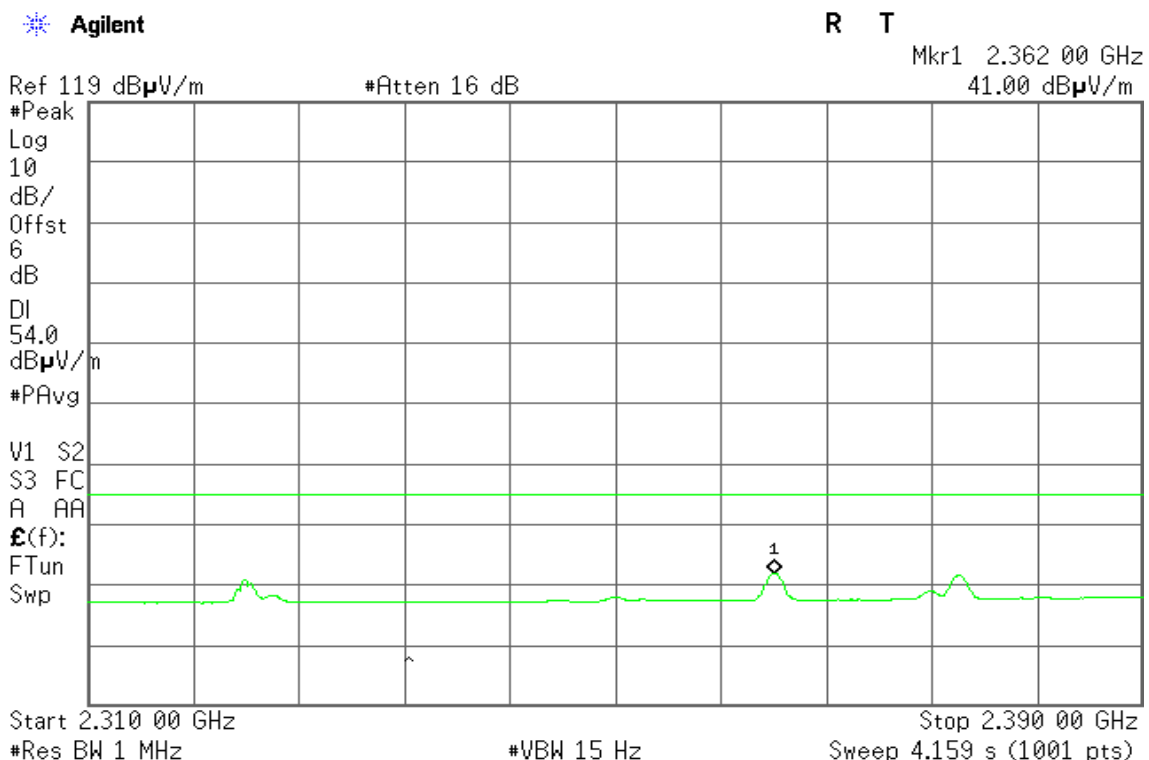



Detector mode: Peak

Polarity: Horizontal

Agilent

R T

Mkr1 2.362 00 GHz
53.67 dB μ V/m

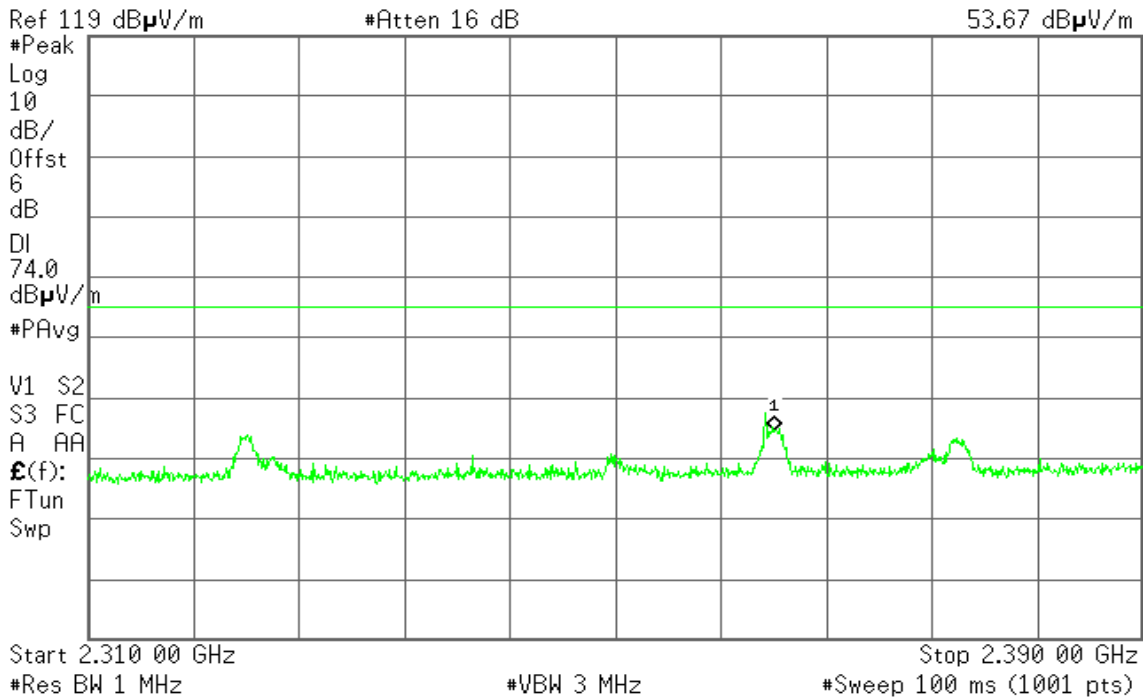

Detector mode: Average

Polarity: Horizontal

Agilent

R T

Mkr1 2.362 00 GHz
47.89 dB μ V/m

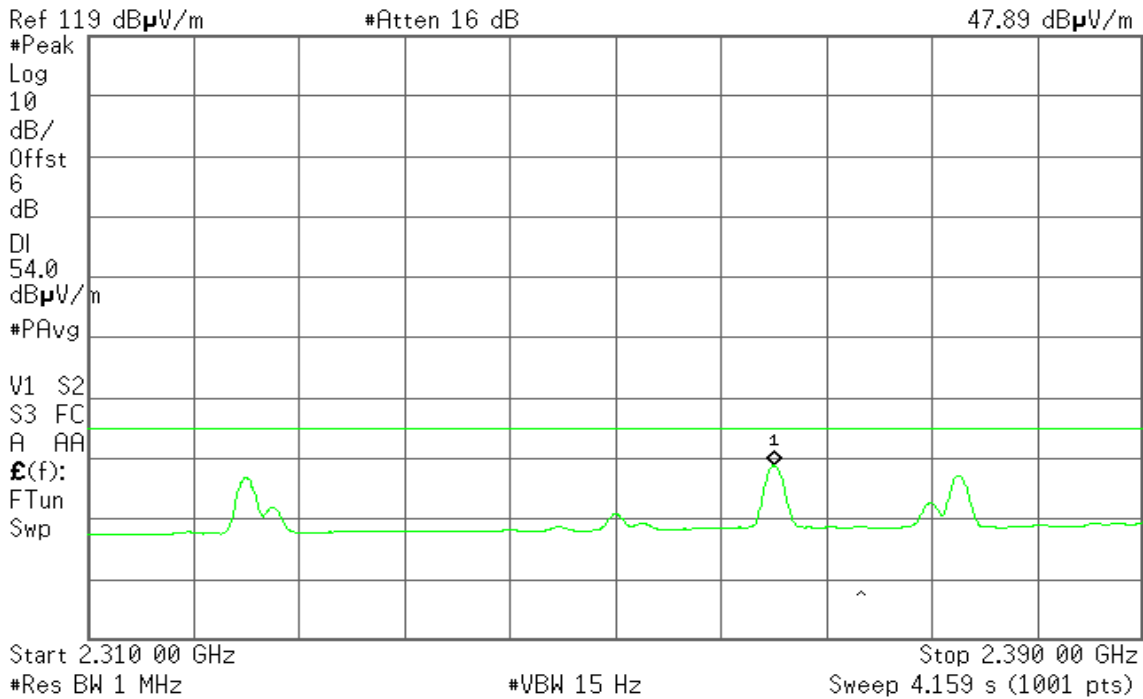



Band Edges (CH High)

Detector mode: Peak

Polarity: Vertical

Agilent

R T

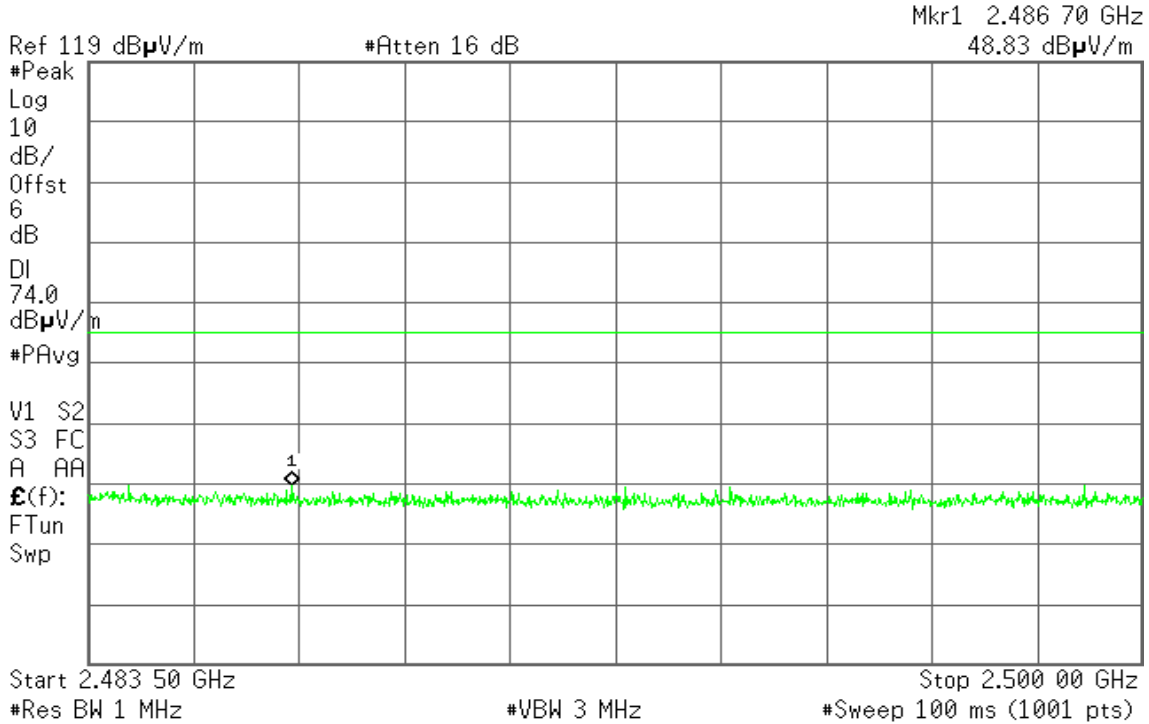

Detector mode: Average

Polarity: Vertical

Agilent

R T

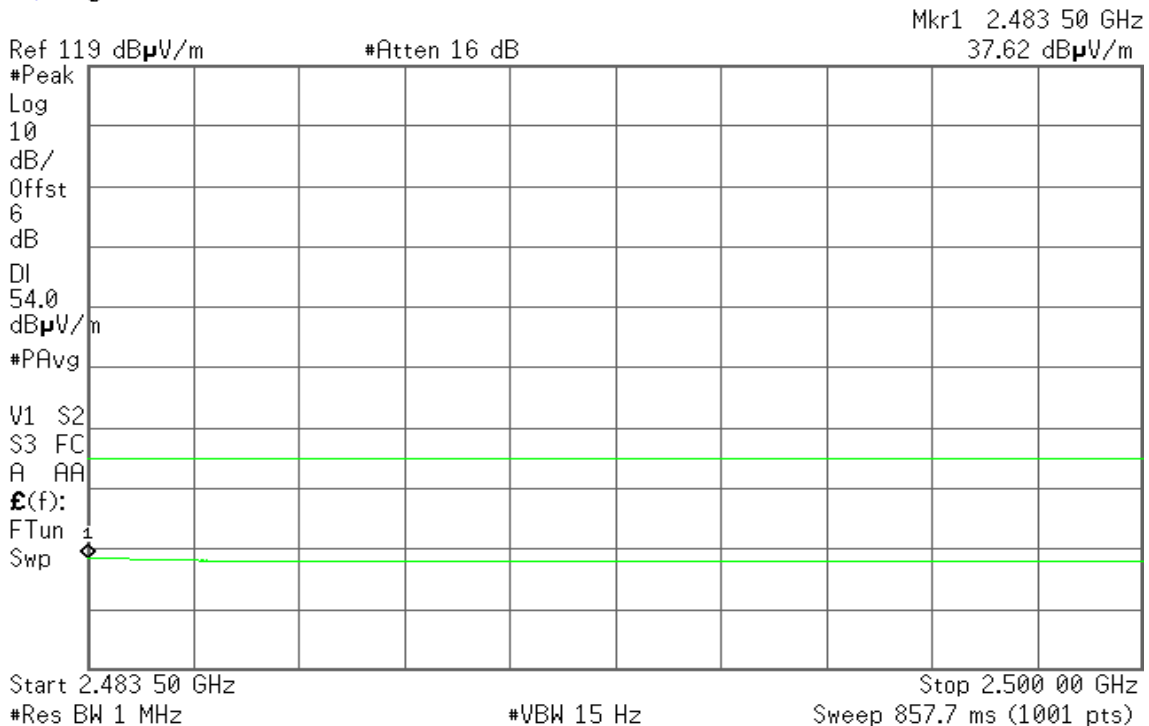



Detector mode: Peak

Polarity: Horizontal

Agilent

R T

Mkr1 2.499 999 995 GHz
49.29 dBµV/m

Ref 119 dBµV/m

#Atten 16 dB

#Peak
Log
10
dB/
Offst
6
dB
DI
74.0
dBµV/m
#PAvg
V1 S2
S3 FC
A AA
£(f):
FTun
Swp

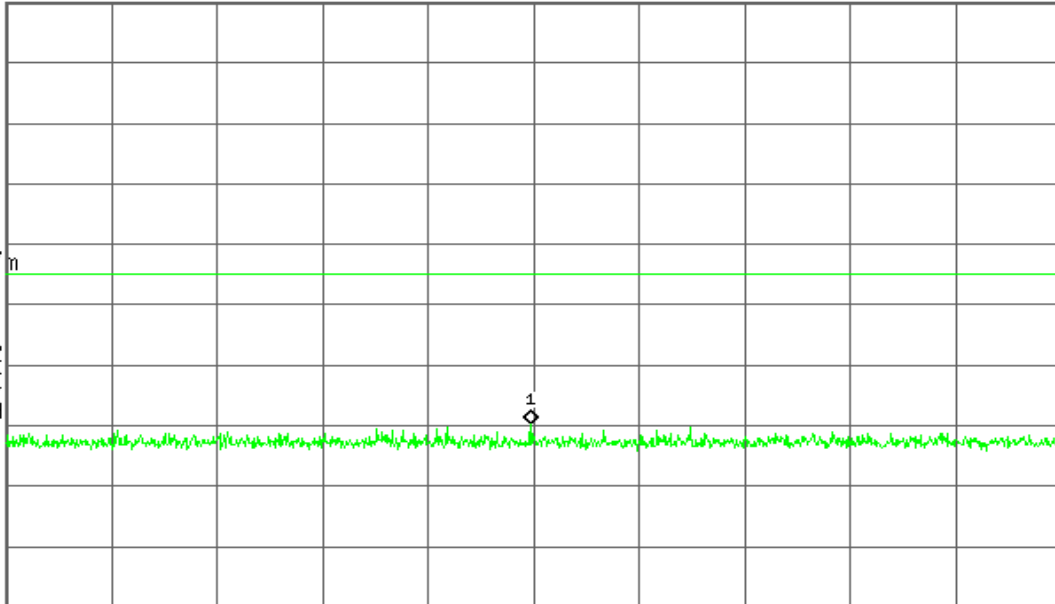

Center 2.499 999 995 GHz

Span 10 Hz

#Res BW 1 MHz

#VBW 3 MHz

#Sweep 100 ms (1001 pts)

Detector mode: Average

Polarity: Horizontal

Agilent

R T

Mkr1 2.499 999 990 GHz
36.86 dBµV/m

Ref 119 dBµV/m

#Atten 16 dB

#Peak
Log
10
dB/
Offst
6
dB
DI
54.0
dBµV/m
#PAvg
V1 S2
S3 FC
A AA
£(f):
FTun
Swp

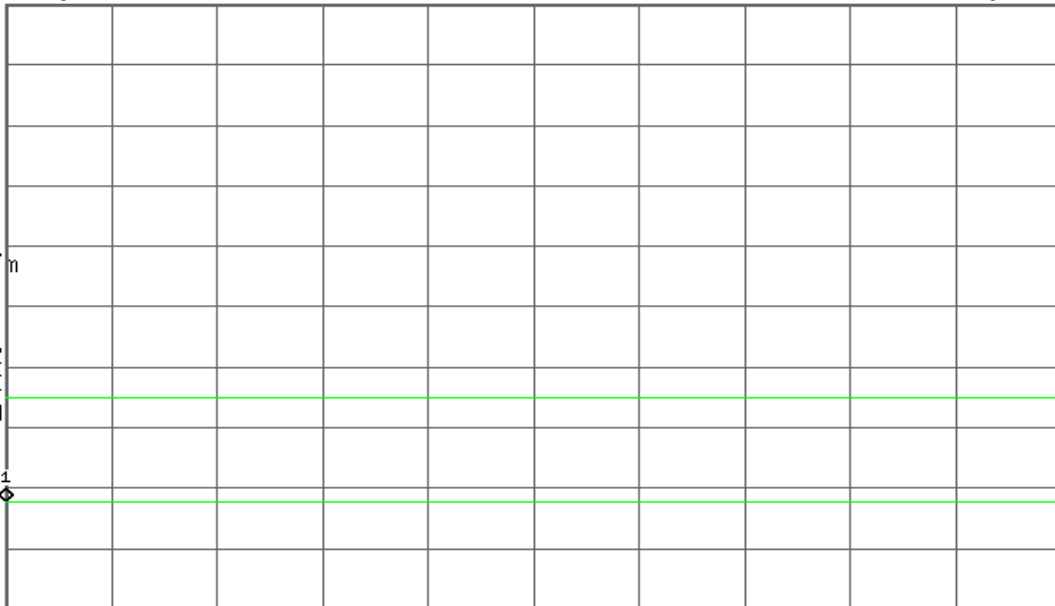

Center 2.499 999 995 GHz

Span 10 Hz

#Res BW 1 MHz

#VBW 15 Hz

Sweep 1 ms (1001 pts)



Conducted Band Edges (CH Low)

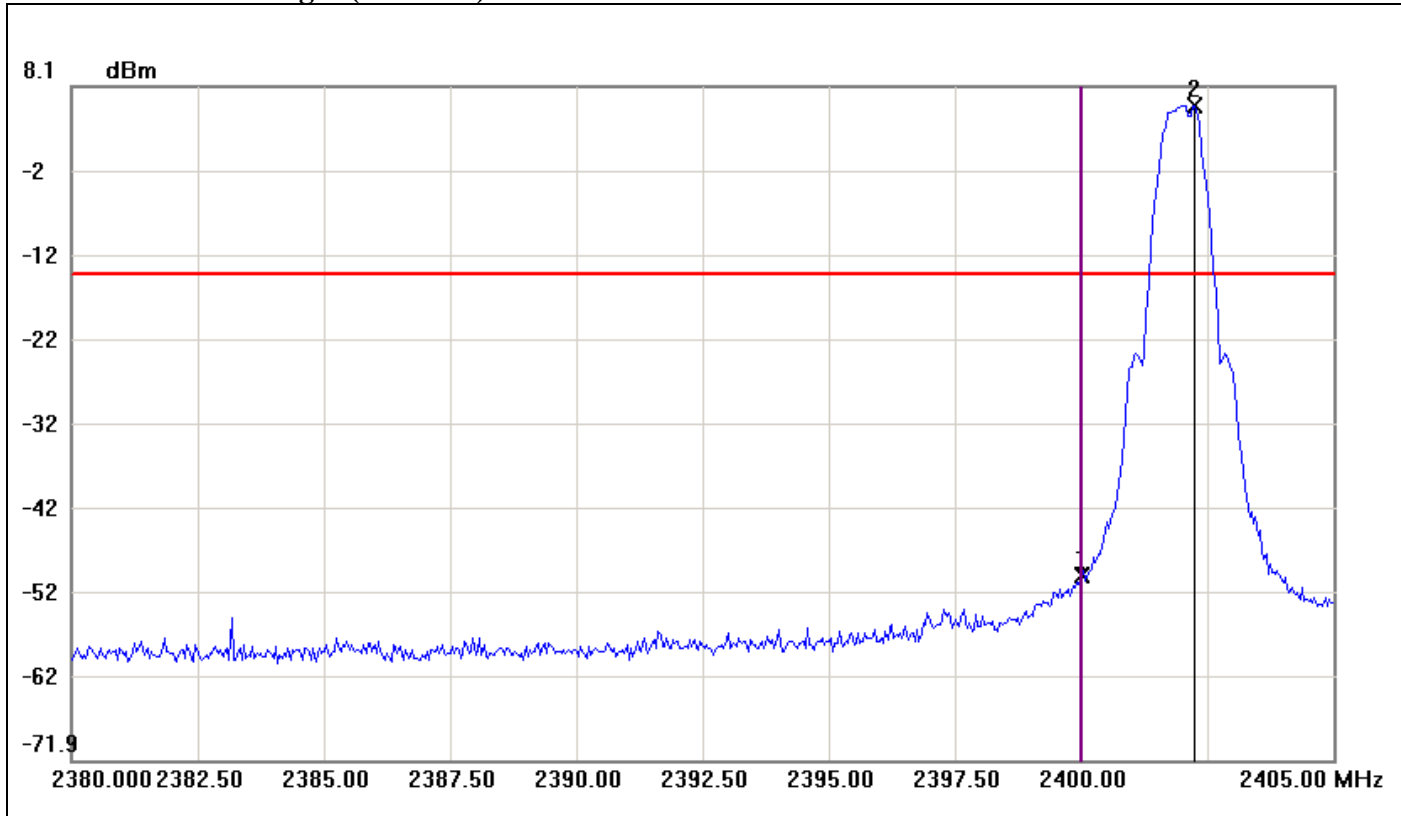

No.	Frequency(MHz)	Result(dBm)	Limit(dBm)	Margin(dBm)
1	2400.0000	-49.97	-14.17	-35.80
2	2402.2500	5.83	-14.17	20.00



Conducted Band Edges (CH High)

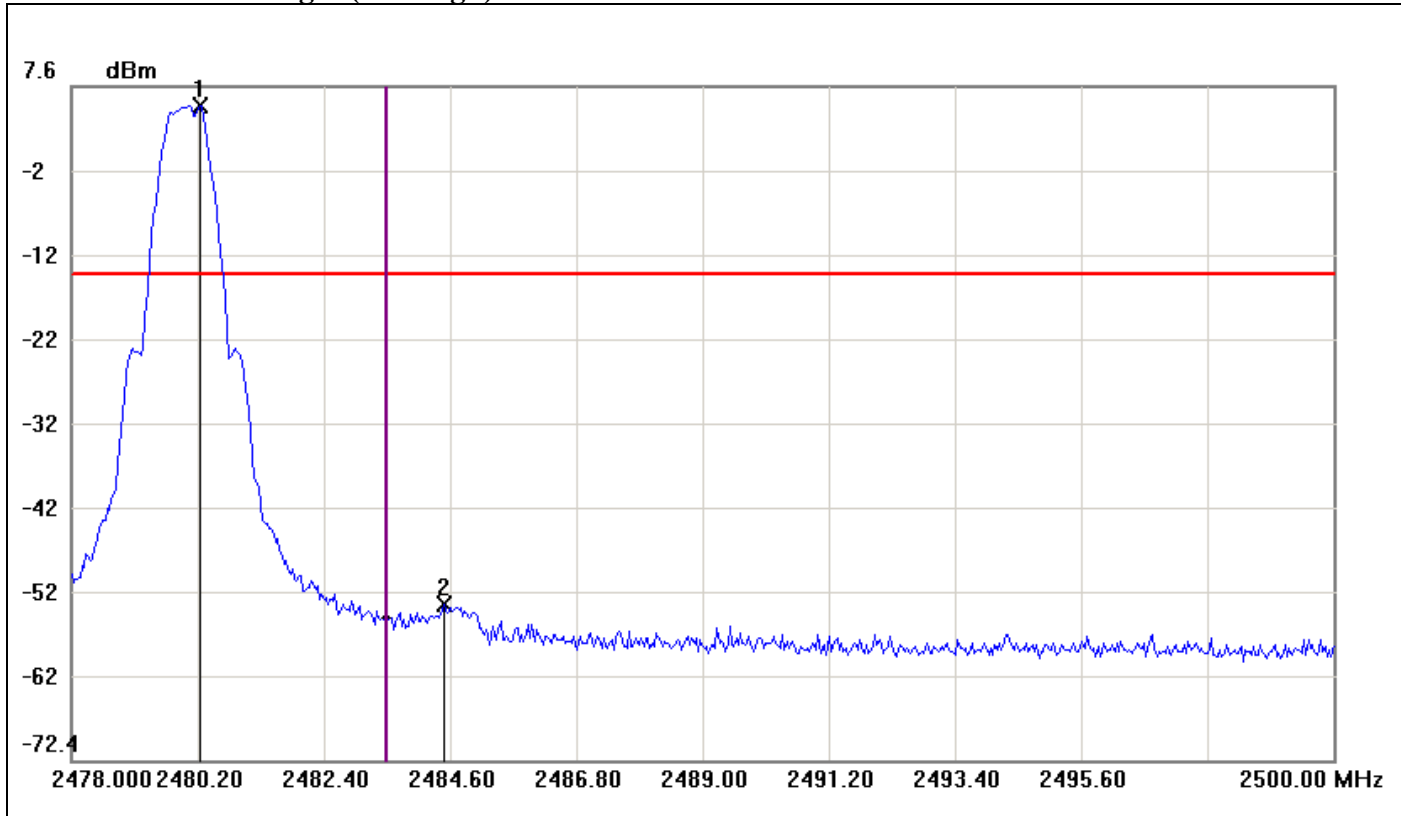

No.	Frequency(MHz)	Result(dBm)	Limit(dBm)	Margin(dBm)
1	2480.2367	5.29	-14.71	20.00
2	2484.4900	-53.84	-14.71	-39.13



7.6 PEAK POWER SPECTRAL DENSITY

LIMIT

1. According to §15.247(e) & RSS-210 §A8.2, for digitally modulated systems, the power spectral density conducted from the intentional radiator to the antenna shall not be greater than 8 dBm in any 3 kHz band during any time interval of continuous transmission.
2. According to §15.247(f) & RSS-210 §A8.3, the digital modulation operation of the hybrid system, with the frequency hopping turned off, shall comply with the power density requirements of paragraph (d) of this section.

Test Configuration

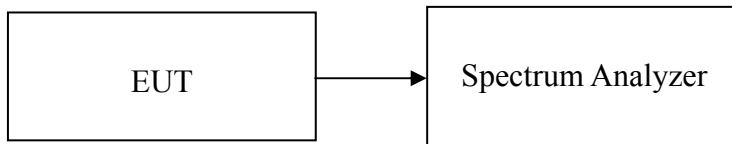

TEST PROCEDURE

The transmitter output is connected to a spectrum analyzer. Set the RBW = 100 kHz, VBW 300 kHz, span 5-30% greater than EBW, Detector = peak, Trace mode = max hold, Sweep = auto couple. Scale the observed power level to an equivalent value in 3 kHz by adjusting (reducing) the measured power by a bandwidth correction factor (BWCF) where $BWCF = 10\log(3\text{ kHz}/100\text{ kHz} = -15.2\text{ dB})$. Record the maximum reading. Repeat the above procedure until the measurements for all frequencies are completed.

TEST RESULTS

No non-compliance noted

Test Data

Channel	Frequency (MHz)	PPSD (dBm)	Limit (dBm)	Test Result
Low	2402	2.06	8	PASS
Mid	2440	1.47		PASS
High	2480	1.46		PASS



Test Plot

PPSD (CH Low)

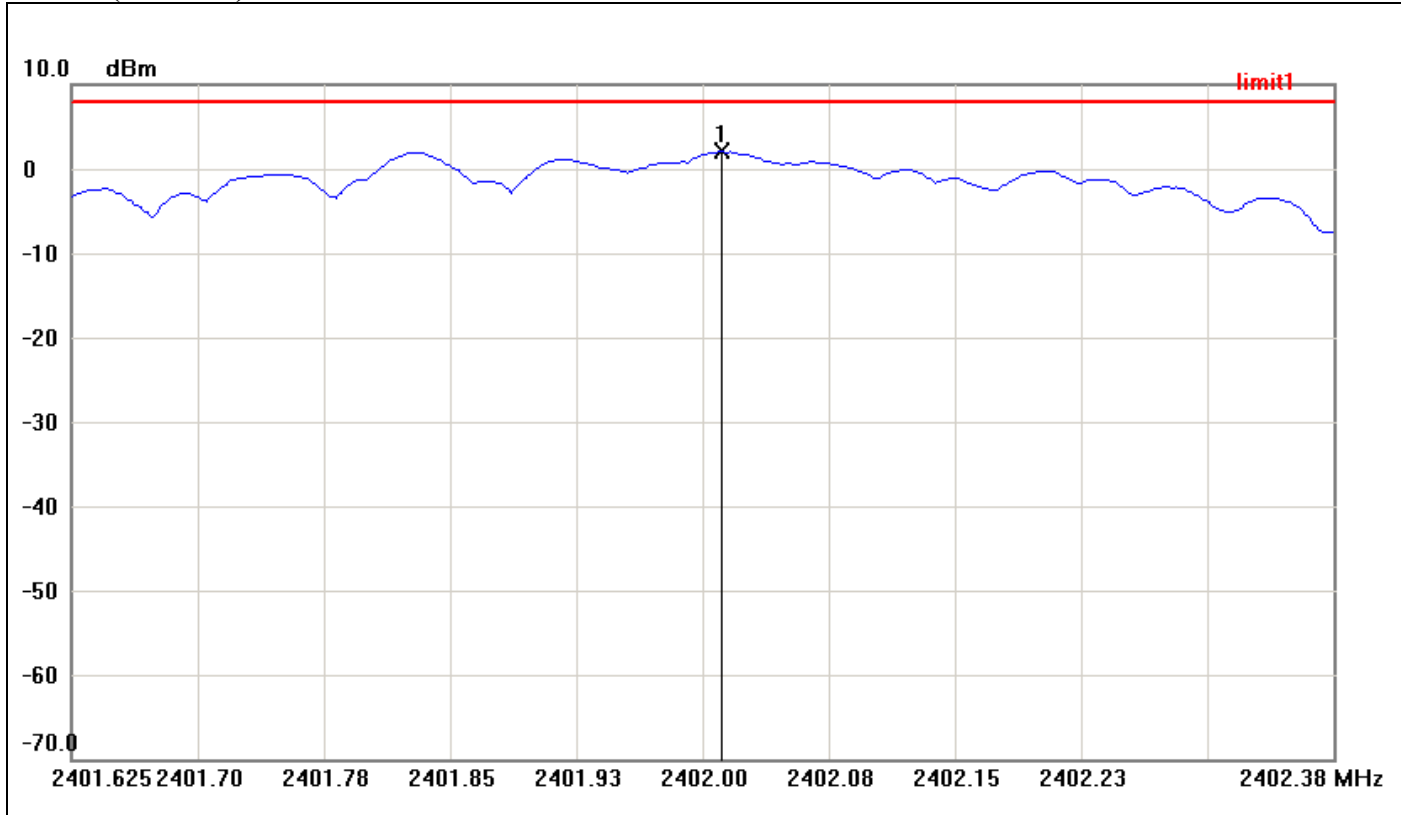

No.	Frequency(MHz)	Result(dBm)	Limit(dBm)	Margin(dBm)
1	2402.0113	2.06	8.00	-5.94



PPSD (CH Mid)

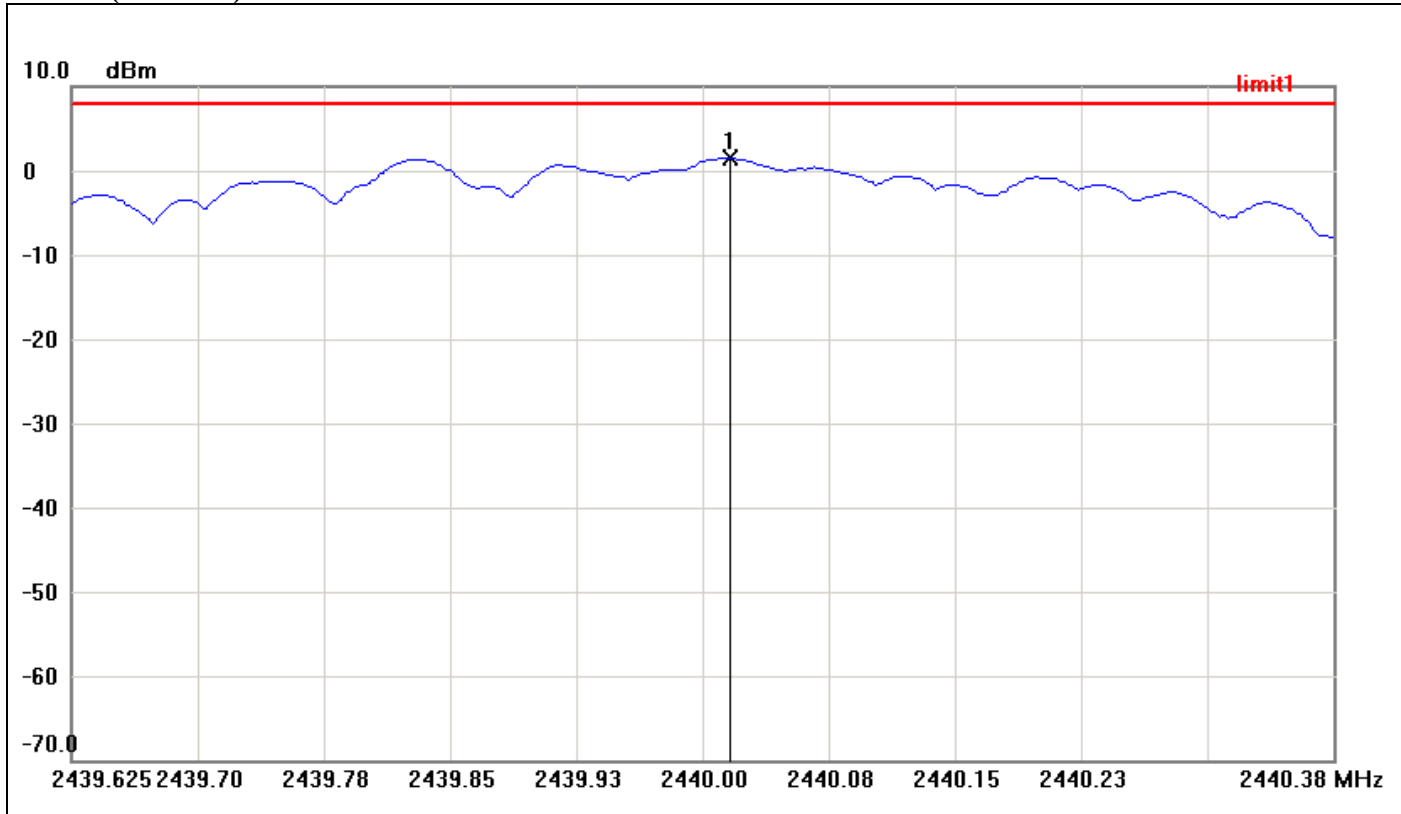

No.	Frequency(MHz)	Result(dBm)	Limit(dBm)	Margin(dBm)
1	2440.0163	1.47	8.00	-6.53



PPSD (CH High)

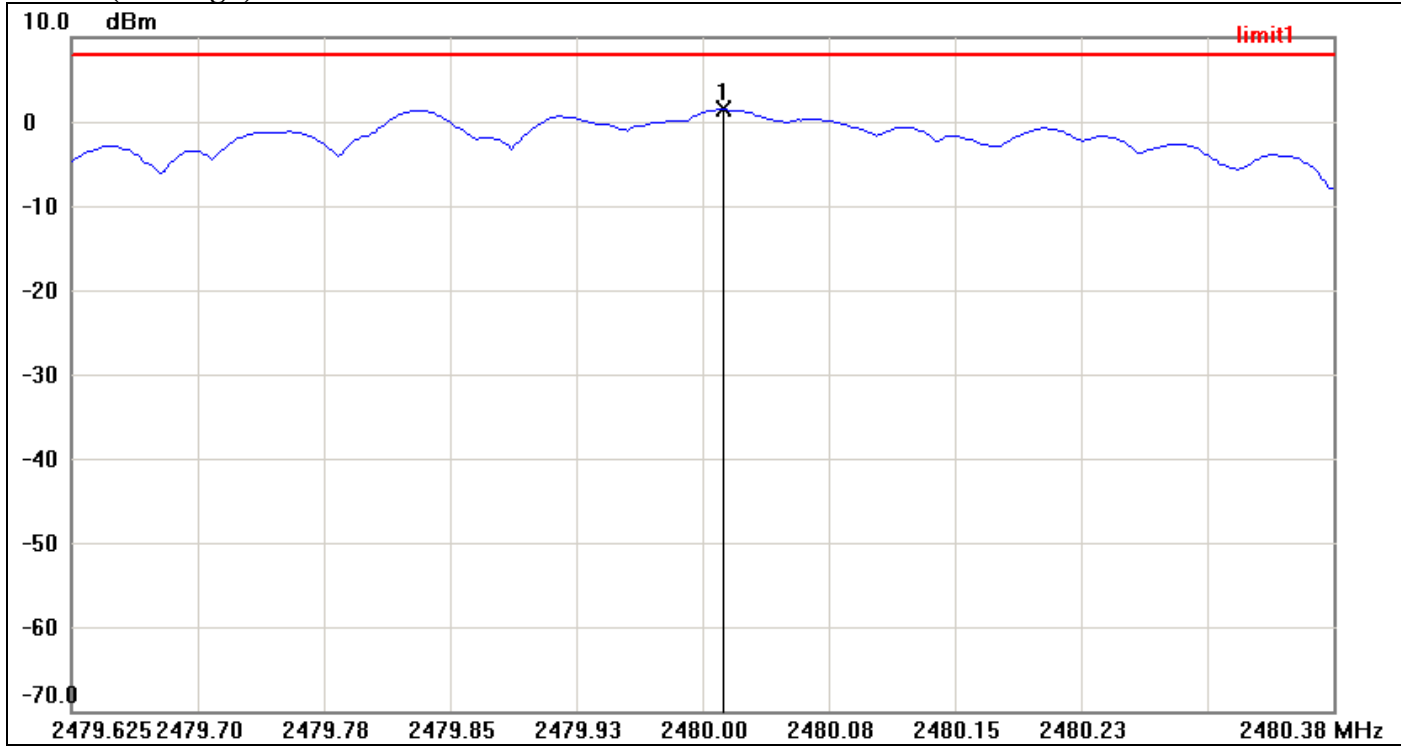

No.	Frequency(MHz)	Result(dBm)	Limit(dBm)	Margin(dBm)
1	2480.0125	1.46	8.00	-6.54



7.7 SPURIOUS EMISSIONS

7.7.1 Conducted Measurement

LIMIT

According to §15.247(d) & RSS-210 §A8.5, in any 100 kHz bandwidth outside the frequency bands in which the spread spectrum intentional radiator is operating, the radio frequency power that is produced by the intentional radiator shall be at least 20 dB below that in the 100 kHz bandwidth within the band that contains the highest level of the desired power, based on either an RF conducted or a radiated measurement, provided the transmitter demonstrates compliance with the peak conducted power limits. In addition, radiated emissions which fall in the restricted bands, as defined in §15.205(a), must also comply with the radiated emission limits specified in 15.209(a) (see Section 15.205(c)).

Test Configuration

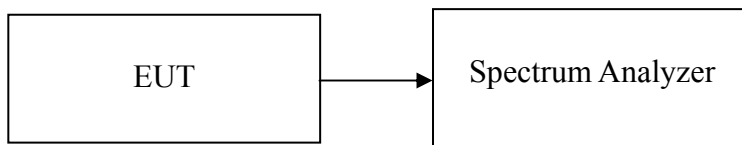

TEST PROCEDURE

Conducted RF measurements of the transmitter output were made to confirm that the EUT antenna port conducted emissions meet the specified limit and to identify any spurious signals that require further investigation or measurements on the radiated emissions site.

The transmitter output is connected to the spectrum analyzer. The resolution bandwidth is set to 100 kHz. The video bandwidth is set to 100 kHz.

Measurements are made over the 30MHz to 26GHz range with the transmitter set to the lowest, middle, and highest channels.

TEST RESULTS

No non-compliance noted



Test Plot

CH Low

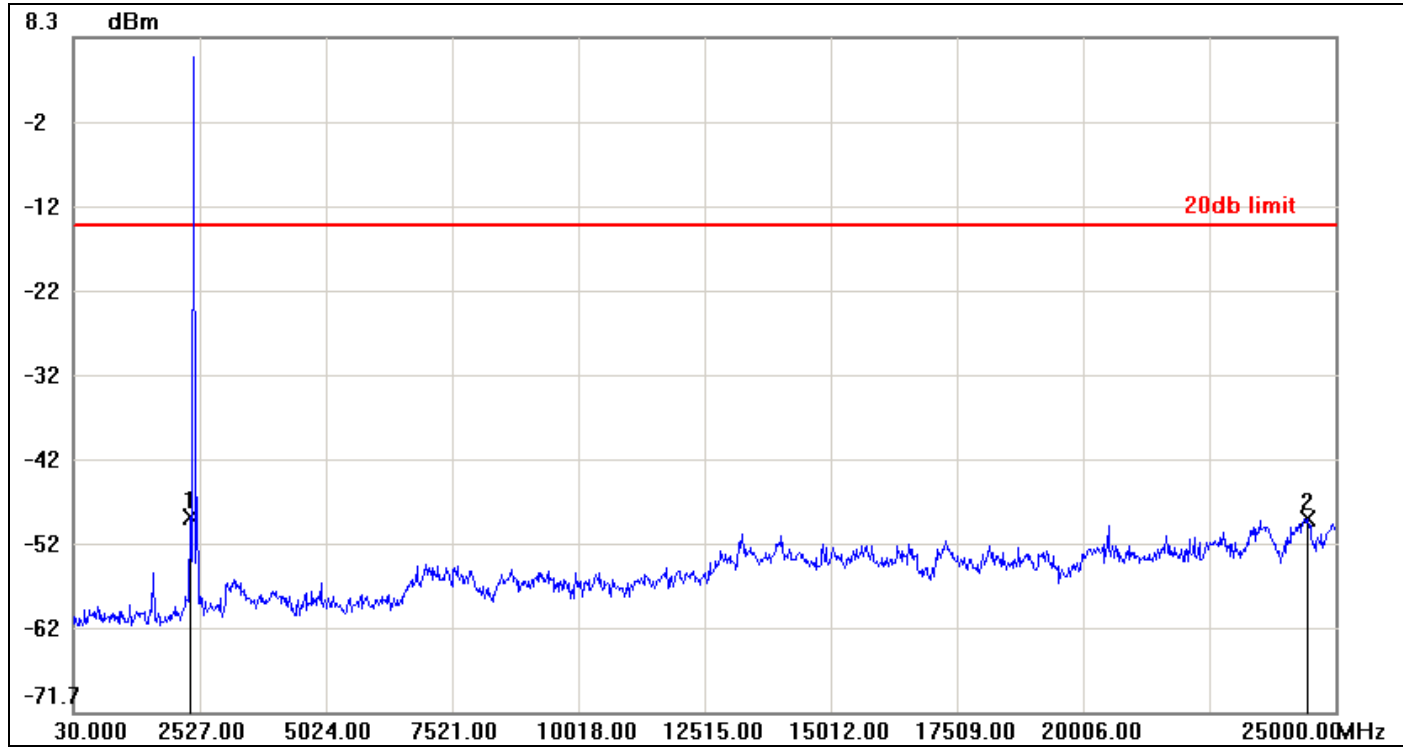

No.	Frequency(MHz)	Result(dBm)	Limit(dBm)	Margin(dBm)
1	2327.2400	-48.66	-14.07	-34.59
2	24450.6600	-48.71	-14.07	-34.64



CH Mid

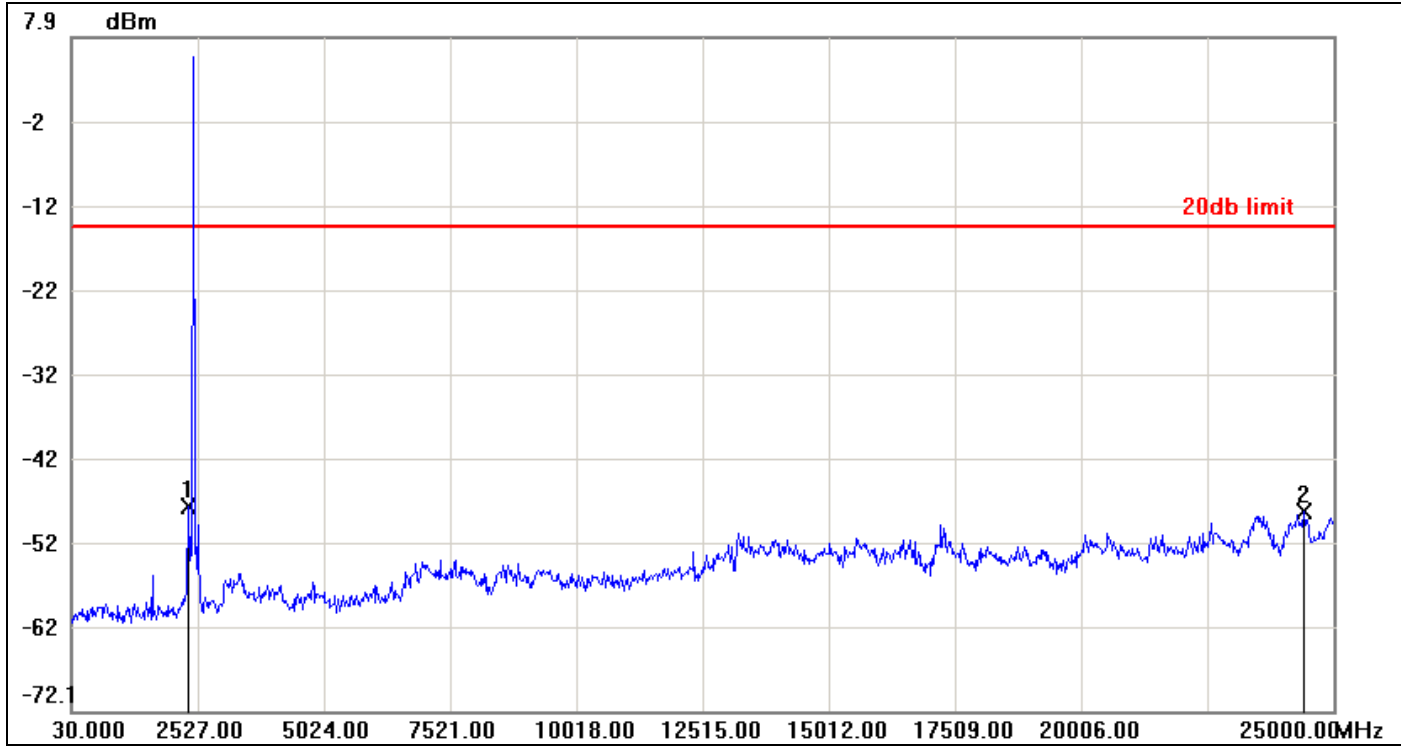

No.	Frequency(MHz)	Result(dBm)	Limit(dBm)	Margin(dBm)
1	2327.2400	-47.76	-14.59	-33.17
2	24425.6900	-48.50	-14.59	-33.91



CH High

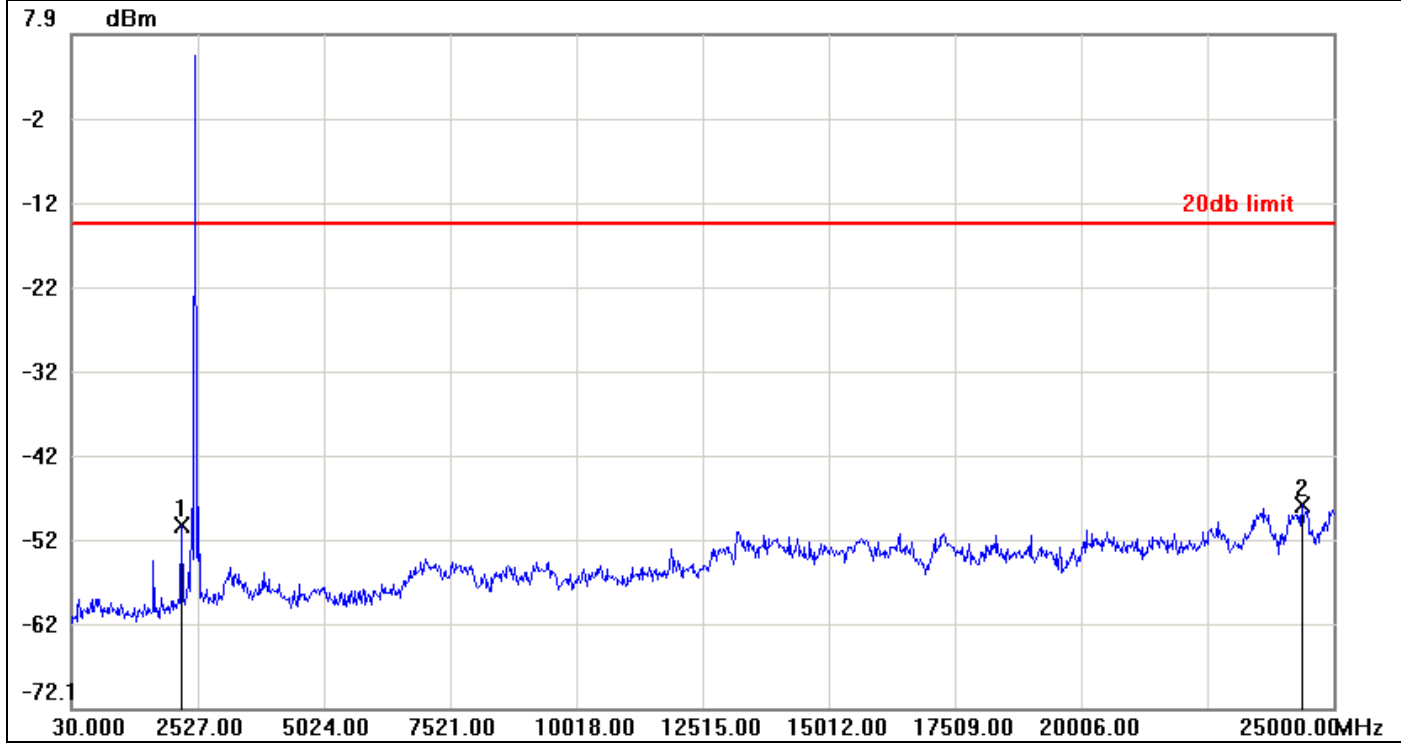

No.	Frequency(MHz)	Result(dBm)	Limit(dBm)	Margin(dBm)
1	2202.3900	-50.50	-14.63	-35.87
2	24375.7500	-48.09	-14.63	-33.46



7.7.2 Radiated Emissions

LIMIT

All spurious emissions shall comply with the limits of §15.209(a) and RSS-Gen Table 2 & Table 5.

RSS-Gen Table 2 & Table 5: General Field Strength Limits for Transmitters and Receivers at Frequencies Above 30 MHz ^(Note)

Frequency (MHz)	Field Strength microvolts/m at 3 metres (watts, e.i.r.p.)	
	Transmitters	Receivers
30-88	100 (3 nW)	100 (3 nW)
88-216	150 (6.8 nW)	150 (6.8 nW)
216-960	200 (12 nW)	200 (12 nW)
Above 960	500 (75 nW)	500 (75 nW)

Note: *Measurements for compliance with limits in the above table may be performed at distances other than 3 metres, in accordance with Section 7.2.7.

Transmitting devices are not permitted in Table 1 bands or, unless stated otherwise, in TV bands (54-72 MHz, 76-88 MHz, 174-216 MHz, 470-608 MHz and 614-806 MHz).

RSS-Gen Table 6: General Field Strength Limits for Transmitters at Frequencies Below 30 MHz (Transmit)

Frequency	Field Strength (microvolts/m)	Magnetic H-Field (microamperes/m)	Measurement Distance (metres)
9-490 kHz	2,400/F (F in kHz)	2,400/377F (F in kHz)	3000
490-1,705 kHz	24,000/F (F in kHz)	24,000/377F (F in kHz)	30
1.705-30 MHz	30	N/A	30

Note: The emission limits for the bands 9-90 kHz and 110-490 kHz are based on measurements employing an average detector.



Test Configuration

9kHz ~ 30MHz

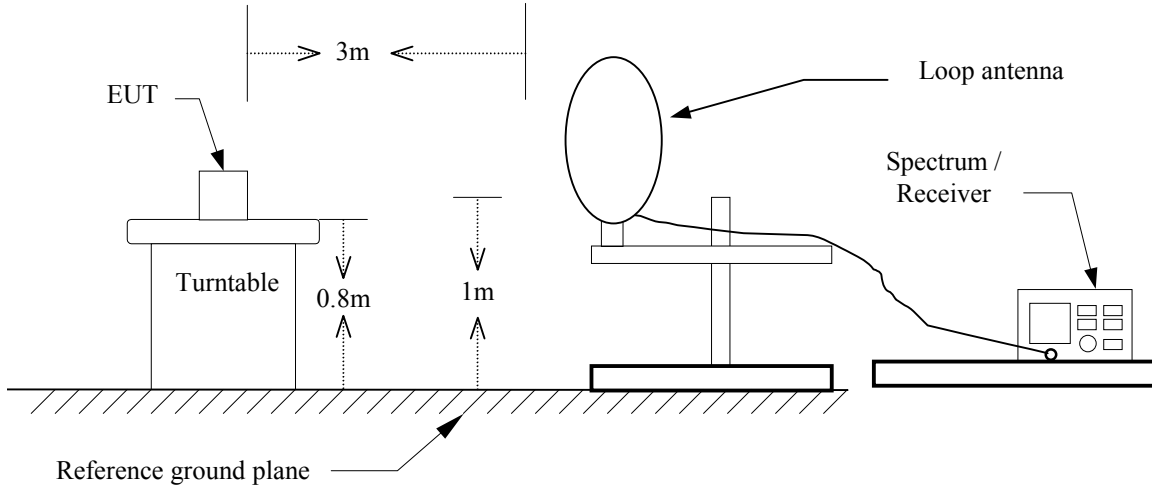

30MHz ~ 1GHz

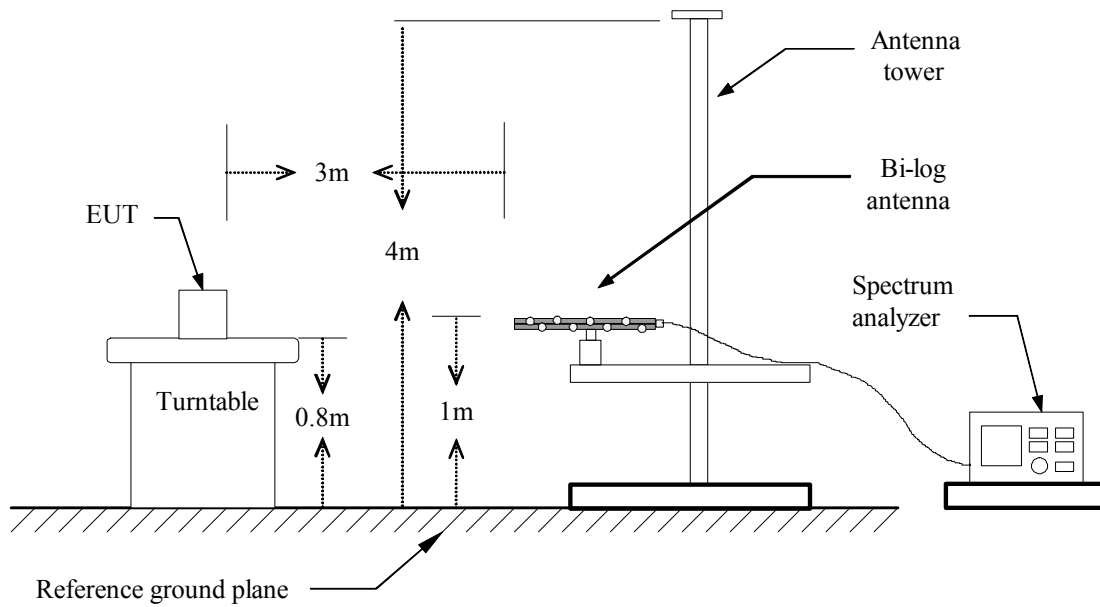



Above 1 GHz

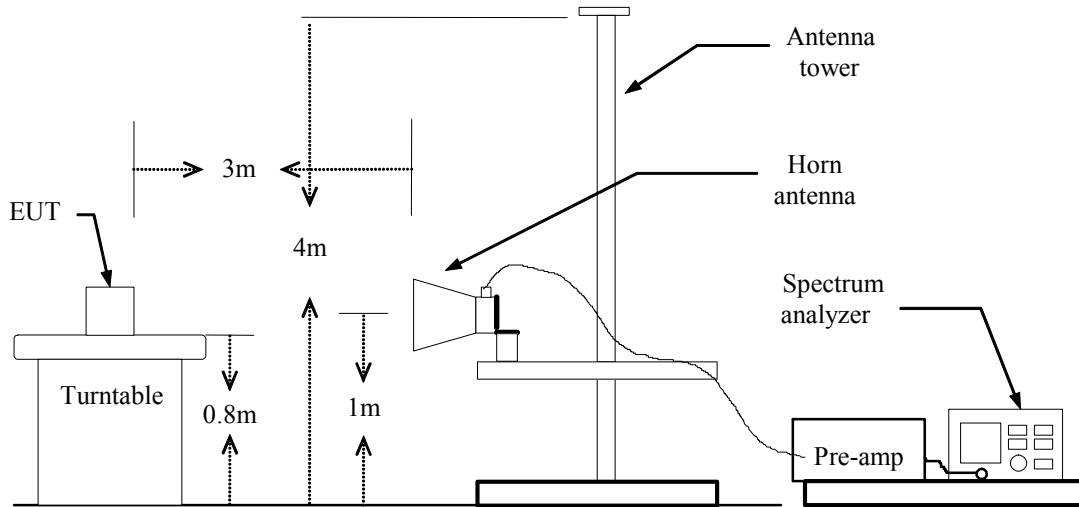



TEST PROCEDURE

1. The EUT is placed on a turntable, which is 0.8m above ground plane.
2. The turntable shall be rotated for 360 degrees to determine the position of maximum emission level.
3. EUT is set 3m away from the receiving antenna, which is varied from 1m to 4m to find out the highest emissions.
4. Maximum procedure was performed on the six highest emissions to ensure EUT compliance.
5. And also, each emission was to be maximized by changing the polarization of receiving antenna both horizontal and vertical.
6. Set the spectrum analyzer in the following setting as:
Below 1GHz:
RBW=100kHz / VBW=300kHz / Sweep=AUTO
Above 1GHz:
(a) PEAK: RBW=1MHz / VBW=3MHz / Sweep=AUTO
(b) AVERAGE: RBW=1MHz / VBW=300Hz / Sweep=AUTO
7. Repeat above procedures until the measurements for all frequencies are complete.



Below 1 GHz

Operation Mode: Normal Link **Test Date:** April 28, 2014
Temperature: 27°C **Tested by:** David Shu
Humidity: 53 % RH **Polarity:** Ver. / Hor.

Frequency (MHz)	Reading (dBuV)	Correction Factor (dB/m)	Result (dBuV/m)	Limit (dBuV/m)	Margin (dB)	Remark	Ant. Pol. (H/V)
36.7900	47.36	-14.85	32.51	40.00	-7.49	peak	V
76.5600	52.10	-22.90	29.20	40.00	-10.80	peak	V
259.8900	33.28	-17.68	15.60	46.00	-30.40	peak	V
449.0400	35.30	-12.69	22.61	46.00	-23.39	peak	V
668.2600	30.21	-9.12	21.09	46.00	-24.91	peak	V
852.5600	28.68	-6.75	21.93	46.00	-24.07	peak	V
36.7900	45.81	-14.85	30.96	40.00	-9.04	peak	H
76.5600	48.48	-22.90	25.58	40.00	-14.42	peak	H
320.0300	42.28	-15.92	26.36	46.00	-19.64	peak	H
533.4300	33.23	-11.28	21.95	46.00	-24.05	peak	H
749.7400	29.90	-7.88	22.02	46.00	-23.98	peak	H
893.3000	29.30	-6.24	23.06	46.00	-22.94	peak	H

Remark:

1. No emission found between lowest internal used/generated frequency to 30MHz (9kHz~30MHz)
2. Radiated emissions measured in frequency range from 30 MHz to 1000MHz were made with an instrument using peak/quasi-peak detector mode.
3. Quasi-peak test would be performed if the peak result were greater than the quasi-peak limit or as required by the applicant.
4. Measurements above show only up to 6 maximum emissions noted, or would be lesser, with " N/A " remark, if no specific emissions from the EUT are recorded (ie: margin>20dB from the applicable limit) and considered that's already beyond the background noise floor.
5. Margin (dB) = Remark result (dBuV/m) – Quasi-peak limit (dBuV/m).



Above 1 GHz

Operation Mode: GFSK / TX / CH Low **Test Date:** April 28, 2014

Temperature: 27°C **Tested by:** David Shu

Humidity: 53 % RH **Polarity:** Ver. / Hor.

Frequency (MHz)	Reading (dBuV)	Correction (dB/m)	Result (dBuV/m)	Limit (dBuV/m)	Margin (dB)	Remark	Ant.Pol. (H/V)
1572.000	53.55	-7.62	45.93	74.00	-28.07	peak	V
N/A							
1334.000	56.61	-9.11	47.50	74.00	-26.50	peak	H
N/A							

Remark:

1. *Measuring frequencies from 1 GHz to the 10th harmonic of highest fundamental frequency.*
2. *Radiated emissions measured in frequency above 1000MHz were made with an instrument using peak/average detector mode.*
3. *Average test would be performed if the peak result were greater than the average limit or as required by the applicant.*
4. *Data of measurement within this frequency range shown “ --- ” in the table above means the reading of emissions are attenuated more than 20dB below the permissible limits or the field strength is too small to be measured.*
5. *Measurements above show only up to 6 maximum emissions noted, or would be lesser, with “ N/A ” remark, if no specific emissions from the EUT are recorded (ie: margin>20dB from the applicable limit) and considered that's already beyond the background noise floor.*
6. *Margin (dB) = Remark result (dBuV/m) – Average limit (dBuV/m).*



Operation Mode: GFSK / TX / CH Mid **Test Date:** April 28, 2014
Temperature: 27°C **Tested by:** David Shu
Humidity: 53 % RH **Polarity:** Ver. / Hor.

Frequency (MHz)	Reading (dBuV)	Correction (dB/m)	Result (dBuV/m)	Limit (dBuV/m)	Margin (dB)	Remark	Ant.Pol. (H/V)
1958.000	50.75	-5.25	45.50	74.00	-28.50	peak	V
N/A							
1936.000	50.39	-5.38	45.01	74.00	-28.99	peak	H
N/A							

Remark:

1. Measuring frequencies from 1 GHz to the 10th harmonic of highest fundamental frequency.
2. Radiated emissions measured in frequency above 1000MHz were made with an instrument using peak/average detector mode.
3. Average test would be performed if the peak result were greater than the average limit or as required by the applicant.
4. Data of measurement within this frequency range shown “ --- ” in the table above means the reading of emissions are attenuated more than 20dB below the permissible limits or the field strength is too small to be measured.
5. Measurements above show only up to 6 maximum emissions noted, or would be lesser, with “ N/A ” remark, if no specific emissions from the EUT are recorded (ie: margin > 20dB from the applicable limit) and considered that's already beyond the background noise floor.
6. Margin (dB) = Remark result (dBuV/m) – Average limit (dBuV/m).



Operation Mode: GFSK / TX / CH High **Test Date:** April 28, 2014
Temperature: 27°C **Tested by:** David Shu
Humidity: 53 % RH **Polarity:** Ver. / Hor.

Frequency (MHz)	Reading (dBuV)	Correction (dB/m)	Result (dBuV/m)	Limit (dBuV/m)	Margin (dB)	Remark	Ant.Pol. (H/V)
1578.000	51.65	-7.58	44.07	74.00	-29.93	peak	V
N/A							
1694.000	51.20	-6.87	44.33	74.00	-29.67	peak	H
N/A							

Remark:

1. Measuring frequencies from 1 GHz to the 10th harmonic of highest fundamental frequency.
2. Radiated emissions measured in frequency above 1000MHz were made with an instrument using peak/average detector mode.
3. Average test would be performed if the peak result were greater than the average limit or as required by the applicant.
4. Data of measurement within this frequency range shown “ --- ” in the table above means the reading of emissions are attenuated more than 20dB below the permissible limits or the field strength is too small to be measured.
5. Measurements above show only up to 6 maximum emissions noted, or would be lesser, with “ N/A ” remark, if no specific emissions from the EUT are recorded (ie: margin > 20dB from the applicable limit) and considered that's already beyond the background noise floor.
6. Margin (dB) = Remark result (dBuV/m) – Average limit (dBuV/m).



7.8 POWERLINE CONDUCTED EMISSIONS

LIMIT

According to §15.207(a) & RSS-Gen §7.2.4, except as shown in paragraphs (b) and (c) of this section, for an intentional radiator that is designed to be connected to the public utility (AC) power line, the radio frequency voltage that is conducted back onto the AC power line on any frequency or frequencies within the band 150 kHz to 30 MHz shall not exceed the limits in the following table, as measured using a 50 μ H/50 ohms line impedance stabilization network (LISN). Compliance with the provisions of this paragraph shall be based on the measurement of the radio frequency voltage between each power line and ground at the power terminal. The lower limit applies at the boundary between the frequency ranges.

Frequency Range (MHz)	Limits (dB μ V)	
	Quasi-peak	Average
0.15 to 0.50	66 to 56*	56 to 46*
0.50 to 5	56	46
5 to 30	60	50

Test Configuration

See test photographs attached in Appendix II for the actual connections between EUT and support equipment.

TEST PROCEDURE

1. The EUT was placed on a table, which is 0.8m above ground plane.
2. Maximum procedure was performed on the six highest emissions to ensure EUT compliance.
3. Repeat above procedures until all frequency measured were complete.



TEST RESULTS

The initial step in collecting conducted data is a spectrum analyzer peak scan of the measurement range. Significant peaks are then marked as shown on the following data page, and these signals are then quasi-peaked.

Test Data

Operation Mode: Normal Link **Test Date:** May 2, 2014
Temperature: 26°C **Tested by:** Sehni Hu
Humidity: 60% RH

Freq. (MHz)	QP Reading (dBuV)	AV Reading (dBuV)	Corr. factor (dB/m)	QP Result (dBuV/m)	AV Result (dBuV/m)	QP Limit (dBuV)	AV Limit (dBuV)	QP Margin (dB)	AV Margin (dB)	Note
0.1780	39.54	32.83	0.19	39.73	33.02	64.58	54.58	-24.85	-21.56	L1
0.2180	27.83	18.08	0.19	28.02	18.27	62.89	52.89	-34.87	-34.62	L1
0.5140	31.44	23.63	0.20	31.64	23.83	56.00	46.00	-24.36	-22.17	L1
0.5860	31.38	23.37	0.20	31.58	23.57	56.00	46.00	-24.42	-22.43	L1
2.5780	27.06	20.29	0.16	27.22	20.45	56.00	46.00	-28.78	-25.55	L1
5.0740	19.49	10.27	0.24	19.73	10.51	60.00	50.00	-40.27	-39.49	L1
0.1722	31.68	21.19	0.19	31.87	21.38	64.85	54.85	-32.98	-33.47	L2
0.2620	31.84	25.36	0.19	32.03	25.55	61.37	51.37	-29.34	-25.82	L2
0.4860	36.73	31.63	0.19	36.92	31.82	56.24	46.24	-19.32	-14.42	L2
1.1020	32.35	25.45	0.19	32.54	25.64	56.00	46.00	-23.46	-20.36	L2
2.4700	29.72	23.43	0.13	29.85	23.56	56.00	46.00	-26.15	-22.44	L2
7.0500	23.06	15.89	0.29	23.35	16.18	60.00	50.00	-36.65	-33.82	L2

Remark:

1. Measuring frequencies from 0.15 MHz to 30MHz.
2. The emissions measured in frequency range from 0.15 MHz to 30MHz were made with an instrument using Quasi-peak detector and average detector.
3. The IF bandwidth of SPA between 0.15MHz and 30MHz was 10 kHz; the IF bandwidth of Test Receiver between 0.15MHz and 30MHz was 9 kHz;
4. L1 = Line One (Live Line) / L2 = Line Two (Neutral Line)



Test Plots

Conducted emissions (Line 1)

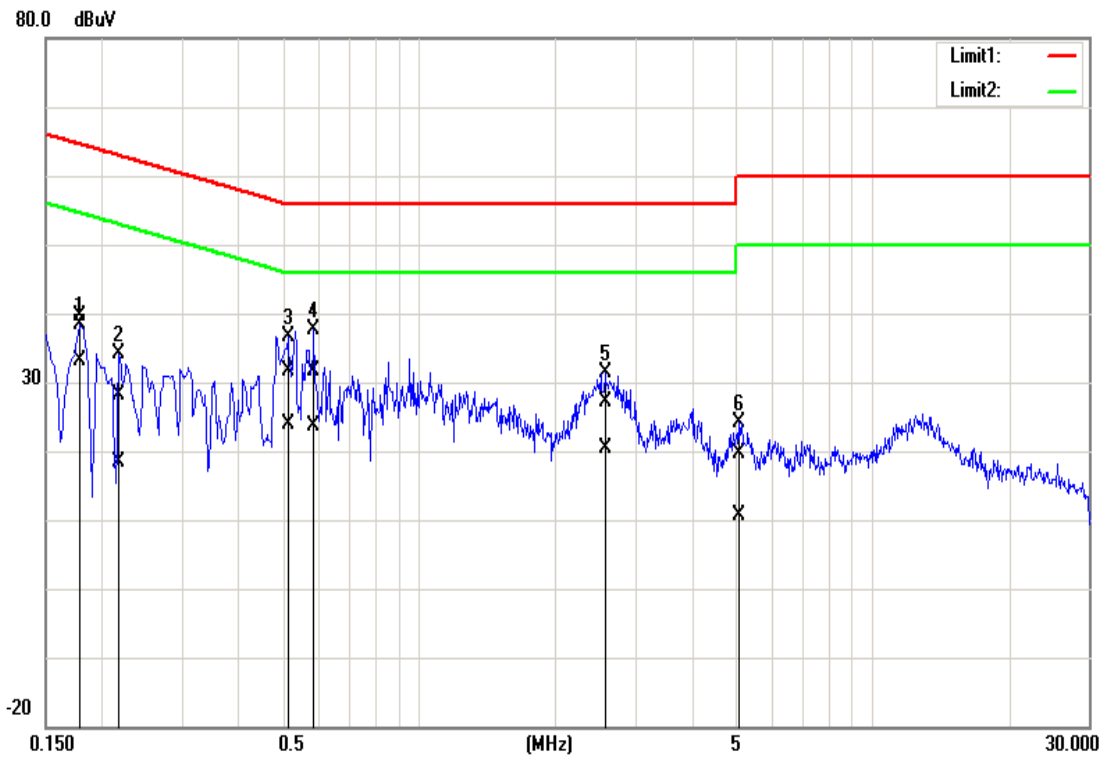

Conducted emissions (Line 2)

