



FCC RF Test Report

APPLICANT : PEGATRON CORPORATION
EQUIPMENT : Tablet
BRAND NAME : TOSHIBA, Excite
MODEL NAME : TOSHIBA AT300,Excite 10 AT300,Excite 10 AT305
FCC ID : VUIPDA4330LB
STANDARD : FCC Part 15 Subpart C §15.247
CLASSIFICATION : (DTS) Digital Transmission System

The product was received on Mar. 09, 2012 and completely tested on Apr. 03, 2012. We, SPORTON INTERNATIONAL INC., would like to declare that the tested sample has been evaluated in accordance with the procedures given in ANSI C63.4-2003 and shown the compliance with the applicable technical standards.

The test results in this report apply exclusively to the tested model / sample. Without written approval of SPORTON INTERNATIONAL INC., the test report shall not be reproduced except in full.

Reviewed by:

Jones Tsai / Manager



SPORTON INTERNATIONAL INC.

No. 52, Hwa Ya 1st Rd., Hwa Ya Technology Park, Kwei-Shan Hsiang, Tao Yuan Hsien, Taiwan, R.O.C.



TABLE OF CONTENTS

REVISION HISTORY 3

SUMMARY OF TEST RESULT 4

1 GENERAL DESCRIPTION 5

 1.1 Applicant 5

 1.2 Manufacturer 5

 1.3 Feature of Equipment Under Test 5

 1.4 Testing Site 6

 1.5 Applied Standards 6

 1.6 Ancillary Equipment List 7

2 TEST CONFIGURATION OF EQUIPMENT UNDER TEST 8

 2.1 Pre-Scanned RF Power 8

 2.2 Maximum Peak Conducted Output Power: 9

 2.3 Maximum Average Conducted Output Power: 9

 2.4 Test Mode 10

 2.5 Connection Diagram of Test System 11

 2.6 RF Utility 11

3 TEST RESULT 12

 3.1 6dB and 99% Bandwidth Measurement 12

 3.2 Output Power Measurement 25

 3.3 Band Edges Measurement 32

 3.4 Spurious Emission Measurement 40

 3.5 Power Spectral Density Measurement 50

 3.6 AC Conducted Emission Measurement 57

 3.7 Radiated Emission Measurement 62

 3.8 Antenna Requirements 75

4 LIST OF MEASURING EQUIPMENT 76

5 UNCERTAINTY OF EVALUATION 77

APPENDIX A. PHOTOGRAPHS OF EUT

APPENDIX B. SETUP PHOTOGRAPHS



REVISION HISTORY

REPORT NO.	VERSION	DESCRIPTION	ISSUED DATE
FR232172B	Rev. 01	Initial issue of report	Apr. 09, 2012
FR232172B	Rev. 02	Update report for adding description of model name.	Apr. 10, 2012

SUMMARY OF TEST RESULT

Report Section	FCC Rule	IC Rule	Description	Limit	Result	Remark
3.1	15.247(a)(2)	A8.2(a)	6dB Bandwidth	$\geq 0.5\text{MHz}$	Pass	-
3.1	-	Gen 4.6.1	99% Bandwidth	-	Pass	-
3.2	15.247(b)	A8.4	Power Output	$\leq 30\text{dBm}$	Pass	-
3.3	15.247(d)	A8.5	Frequency Band Edges	$\leq 20\text{dBc}$	Pass	-
3.4	15.247(d)	A8.5	Spurious Emission	$< 20\text{ dBc}$	Pass	-
3.5	15.247(e)	A8.2(b)	Power Spectral Density	$\leq 8\text{dBm}$	Pass	-
3.6	15.207	Gen 7.2.4	AC Conducted Emission	15.207(a)	Pass	Under limit 13.10 dB at 0.726 MHz
3.7	15.247(d)	A8.5	Transmitter Radiated Emission	15.209(a) & 15.247(d)	Pass	Under limit 0.78 dB at 2389.040 MHz
3.8	15.203 & 15.247(b)	A8.4	Antenna Requirement	N/A	Pass	-

1 General Description

1.1 Applicant

PEGATRON CORPORATION

No. 76, Ligong St., Beitou District, Taipei City 11261

1.2 Manufacturer

PEGATRON CORPORATION

No. 76, Ligong St., Beitou District, Taipei City 11261

1.3 Feature of Equipment Under Test

Product Feature & Specification	
Equipment	Tablet
Brand Name	TOSHIBA, EXCITE
Model Name	TOSHIBA AT300,Excite 10 AT300,Excite 10 AT305
FCC ID	VUIPDA4330LB
Sample 1	EUT with 16G eMMC
Sample 2	EUT with 32G eMMC
Sample 3	EUT with 64G eMMC
Tx/Rx Frequency Range	2400 MHz ~ 2483.5 MHz
Number of Channels	11
Carrier Frequency of Each Channel	2412+(n-1)*5 MHz; n=1~11
Channel Spacing	5 MHz
Maximum Output Power to Antenna	802.11b : 16.16 dBm (0.041 W) 802.11g : 17.08 dBm (0.051 W) 802.11g/n (BW 20MHz) : 15.92 dBm (0.039 W)
Duty Cycle	802.11b : 100.00% 802.11g : 86.44% 802.11g/n (BW 20MHz) : 85.65%
Antenna Type	Chip Antenna with gain 2.10 dBi
Type of Antenna Connector	I-PEX connector
HW Version	1.03
SW Version	Android 4.0 (tostab11BA-eng 4.0.3 IML74K eng.daily-build-a.20120309)
Type of Modulation	802.11b : DSSS (BPSK / QPSK / CCK) 802.11g/n : OFDM (BPSK / QPSK / 16QAM / 64QAM)
EUT Stage	Identical Prototype

Remark:

1. The above EUT's information was declared by manufacturer. Please refer to the specifications or user's manual for more detailed description.
2. The model names (TOSHIBA AT300, Excite 10 AT300, Excite 10 AT305) are identical on hardware. The only difference is the label of different branding for different customer.

1.4 Testing Site

Test Site	SPORTON INTERNATIONAL INC.		
Test Site Location	No. 52, Hwa Ya 1 st Rd., Hwa Ya Technology Park, Kwei-Shan Hsiang, Tao Yuan Hsien, Taiwan, R.O.C. TEL: +886-3-3273456 / FAX: +886-3-3284978		
Test Site No.	Sporton Site No.		FCC/IC Registration No.
	CO05-HY	03CH05-HY	722060/4086B-1

1.5 Applied Standards

According to the specifications of the manufacturer, the EUT must comply with the requirements of the following standards:

- ♦ FCC Part 15 Subpart C §15.247
- ♦ FCC KDB Publication No. 558074 D01 DTS Meas. Guidance v01
- ♦ ANSI C63.4-2003
- ♦ IC RSS-210 Issue 8
- ♦ IC RSS-Gen Issue 3

Remark:

1. All test items were verified and recorded according to the standards and without any deviation during the test.
2. This EUT has also been tested and complied with the requirements of FCC Part 15, Subpart B, recorded in a separate test report.



1.6 Ancillary Equipment List

Item	Equipment	Trade Name	Model Name	FCC ID	Data Cable	Power Cord
1.	GPS Station	Pendulum	GSG-54	N/A	N/A	Unshielded, 1.8 m
2.	WLAN AP	D-Link	DIR-628	KA2DIR628A2	N/A	Unshielded, 1.8 m
3.	Notebook	DELL	P20G	FCC DoC	N/A	AC I/P: Unshielded, 1.2 m DC O/P: Shielded, 1.8 m
4.	LCD TV	HANNspree	ST19ZOO_CN	N/A	Shielded, 1.8 m	Unshielded, 1.8 m
5.	Bluetooth Earphone	Sony Ericsson	MW600	PY70DA2029	N/A	N/A
6.	iPod	Apple	A1199	FCC DoC	Shielded, 1.0 m	N/A
7.	iPod	Apple	A1285	FCC DoC	Shielded, 1.0 m	N/A
8.	iPod Earphone	Apple	N/A	FCC DoC	Unshielded, 1.0 m	N/A
9.	Earphone	Ergotech	ET-E200	FCC DoC	Unshielded, 1.8 m	N/A

2 Test Configuration of Equipment Under Test

2.1 Pre-Scanned RF Power

Preliminary tests were performed in different data rate as below table and the highest power data rates (11b, 11g, 11g/n (BW 20MHz) modes) were chosen for full test in the following sections to demonstrate compliance to the FCC limit line.

2.4GHz 802.11b mode				
Data Rate (MHz)	1M bps	2M bps	5.5M bps	11M bps
Peak Power (dBm)	16.16	15.83	15.66	15.42

2.4GHz 802.11g mode								
Data Rate (MHz)	6M bps	9M bps	12M bps	18M bps	24M bps	36M bps	48M bps	54M bps
Peak Power (dBm)	17.08	16.83	16.72	16.26	15.97	15.52	14.95	14.75

2.4GHz 802.11g/n (BW 20MHz) mode								
Data Rate (MHz)	MCS0	MCS1	MCS2	MCS3	MCS4	MCS5	MCS6	MCS7
Peak Power (dBm)	15.92	15.46	15.12	14.9	14.32	13.7	13.65	13.24

2.2 Maximum Peak Conducted Output Power:

Band	2.4GHz 802.11b RF Power (dBm)			2.4GHz 802.11g RF Power (dBm)		
	Channel	1	6	11	1	6
Frequency (MHz)	2412	2437	2462	2412	2437	2462
Peak Power	16.16	16.12	15.88	17.08	16.86	16.66

Band	2.4GHz 802.11g/n (BW 20MHz) RF Peak Power (dBm)		
	Channel	1	6
Frequency (MHz)	2412	2437	2462
Peak Power	15.92	15.84	15.34

Remark:

The data rates of WLAN 802.11b/g/n were set in 1Mbps for 802.11b, 6Mbps for 802.11g, and MCS0 for 802.11g/n (BW 20MHz) for all the test cases due to the highest RF output power.

2.3 Maximum Average Conducted Output Power:

Band	2.4GHz 802.11b RF Power (dBm)			2.4GHz 802.11g RF Power (dBm)		
	Channel	1	6	11	1	6
Frequency (MHz)	2412	2437	2462	2412	2437	2462
Average Power	13.73	13.71	13.35	11.09	10.87	10.57

Band	2.4GHz 802.11g/n (BW 20MHz) RF Peak Power (dBm)		
	Channel	1	6
Frequency (MHz)	2412	2437	2462
Average Power	9.94	9.71	9.30

Remark:

1. The average power, which is used by the test method, AVG2, in DTS Meas. Guidance v01, is reporting only.
2. The EUT is programmed to transmit signals continuously.

2.4 Test Mode

The EUT has been associated with peripherals pursuant to ANSI C63.4-2003 and configuration operated in a manner tended to maximize its emission characteristics in a typical application. Frequency range investigated: conducted emission (150 KHz to 30 MHz), radiated emission (30 MHz to the 10th harmonic of the highest fundamental frequency or to 40 GHz, whichever is lower).

Pre-scanned tests, X, Y, Z in three orthogonal panels, were conducted to determine the final configuration from all possible combinations.

The following tables are showing the test modes as the worst cases (X plane) and recorded in this report.

Test Cases		
Test Item	802.11b (Modulation : DSSS)	802.11g/n (Modulation : OFDM)
Conducted TCs	Mode 1 : 802.11b CH01_2412 MHz Mode 2 : 802.11b CH06_2437 MHz Mode 3 : 802.11b CH11_2462 MHz	Mode 4: 802.11g_CH01_2412 MHz Mode 5: 802.11g_CH06_2437 MHz Mode 6: 802.11g_CH11_2462 MHz Mode 7: 802.11g/n (BW 20M)_CH01_2412 MHz Mode 8: 802.11g/n (BW 20M)_CH06_2437 MHz Mode 9: 802.11g/n (BW 20M)_CH11_2462 MHz
Radiated TCs	Mode 1 : 802.11b CH01_2412 MHz Mode 2 : 802.11b CH06_2437 MHz Mode 3 : 802.11b CH11_2462 MHz	Mode 4: 802.11g_CH01_2412 MHz Mode 5: 802.11g_CH06_2437 MHz Mode 6: 802.11g_CH11_2462 MHz Mode 7: 802.11g/n (BW 20M)_CH01_2412 MHz Mode 8: 802.11g/n (BW 20M)_CH06_2437 MHz Mode 9: 802.11g/n (BW 20M)_CH11_2462 MHz
AC Conducted Emission	Mode 1 : WLAN Link + Bluetooth Link + GPS Rx + TC for Sample 1	
Remark: 1. TC stands for Test Configuration, and consists of HDMI Cable, iPod earphone, SD card, USB Cable (Data Link with Notebook) and adapter. 2. The tests were performance with Sample 1. 3. Link with Notebook means data application transferred mode between EUT and Notebook.		

2.5 Connection Diagram of Test System

<WLAN Tx Mode>

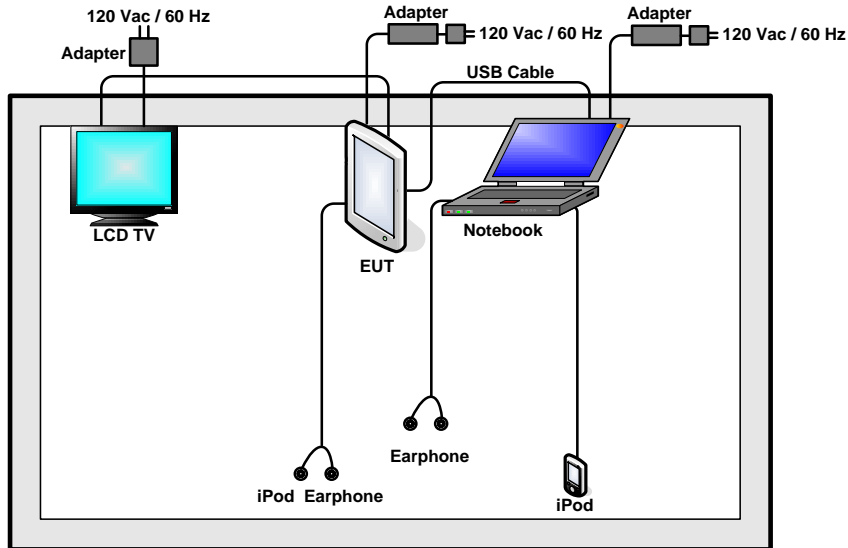

<AC Conducted Emission Mode>

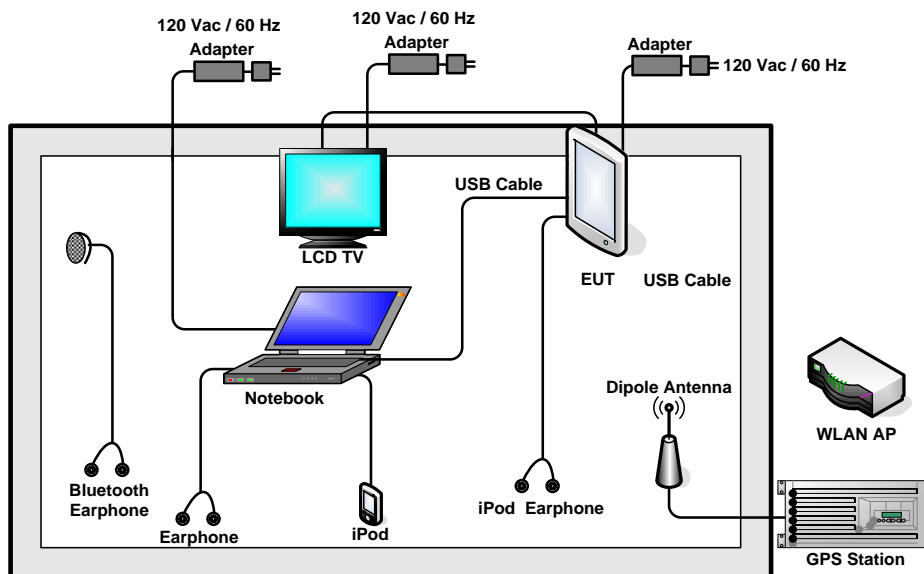

2.6 RF Utility

For WLAN function, programmed RF utility, “command” installed in the EUT provides functions like channel selection and power level for continuous transmitting and receiving signals.

3 Test Result

3.1 6dB and 99% Bandwidth Measurement

3.1.1 Limit of 6dB Bandwidth

The minimum 6 dB bandwidth shall be at least 500 KHz.

3.1.2 Measuring Instruments

See list of measuring instruments of this test report.

3.1.3 Test Procedures

1. The testing follows FCC KDB Publication No. 558074 D01 DTS Meas. Guidance v01.
2. The RF output of EUT was connected to the spectrum analyzer by a low loss cable. The path loss was compensated to the results for each measurement.
3. Make the measurement with the spectrum analyzer's resolution bandwidth (RBW) = 1-5% of the emission bandwidth (EBW). Set the Video bandwidth (VBW) $\geq 3 * RBW$. In order to make an accurate measurement. The 6 dB bandwidth must be greater than 500 KHz.
4. The marker-delta reading at this point is the 6 dB bandwidth of the emission.

3.1.4 Test Setup

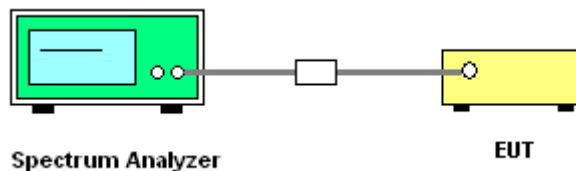



3.1.5 Test Result of 6dB Bandwidth

Test Mode :	Mode 1, 2, 3	Temperature :	24~26°C
Test Engineer :	Reece Li	Relative Humidity :	50~53%

Channel	Frequency (MHz)	802.11b 6dB Bandwidth (MHz)	6dB Bandwidth Min. Limit (MHz)	Pass/Fail
01	2412	7.159	0.5	Pass
06	2437	7.195	0.5	Pass
11	2462	7.605	0.5	Pass

Mode 1 : 6 dB Bandwidth Plot on 802.11b Channel 01

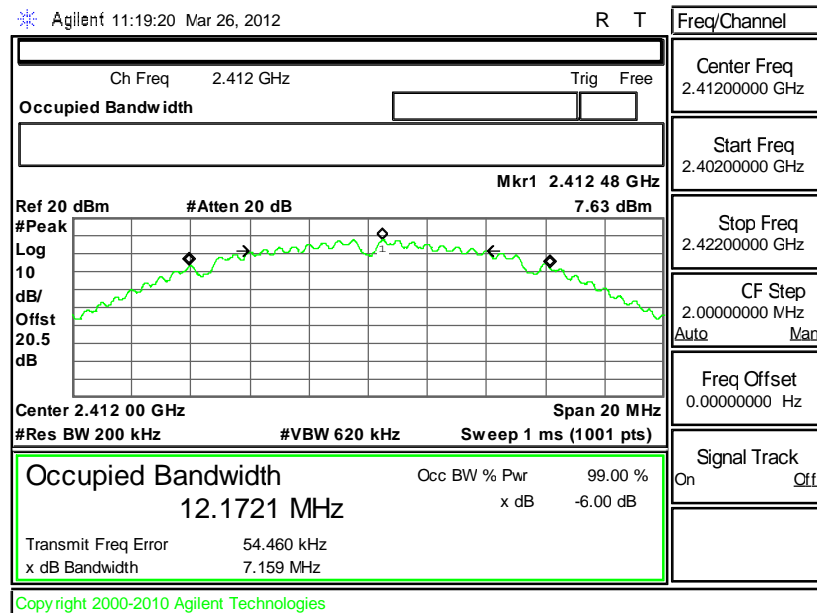



Mode 2 : 6 dB Bandwidth Plot on 802.11b Channel 06

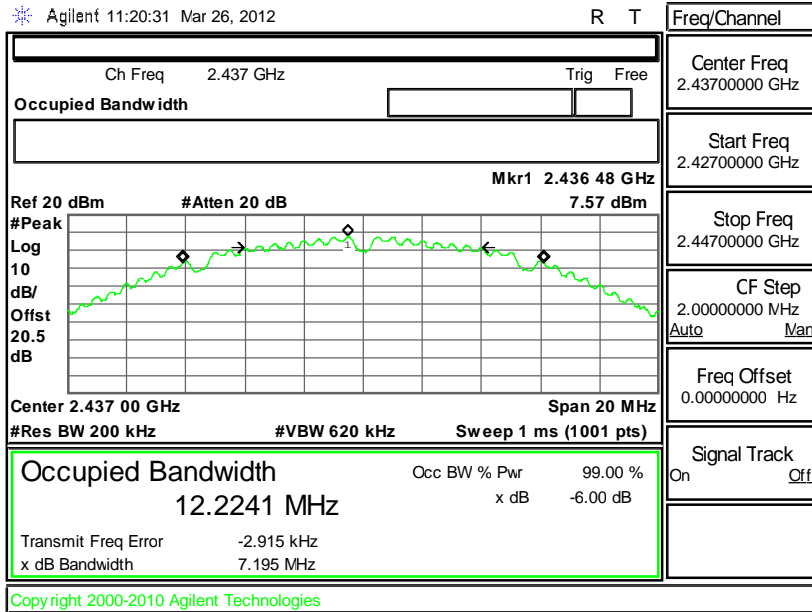

Mode 3 : 6 dB Bandwidth Plot on 802.11b Channel 11

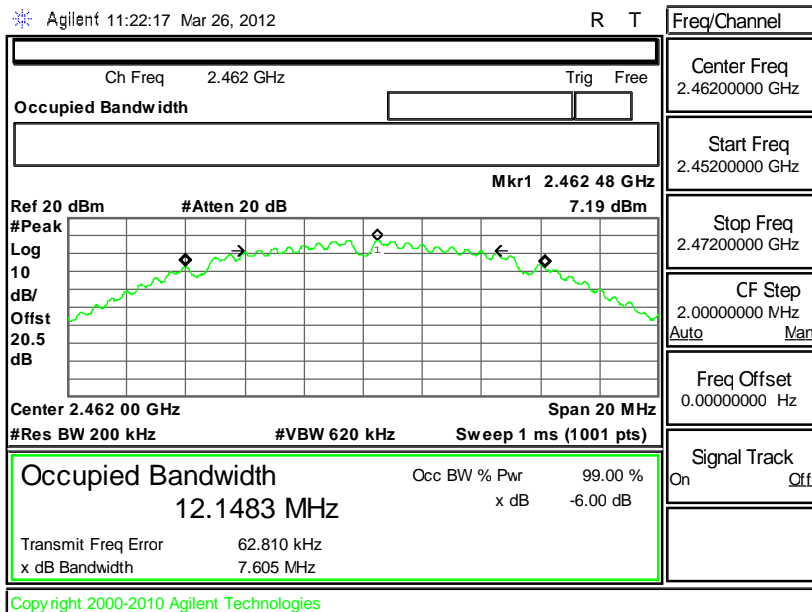



Test Mode :	Mode 4, 5, 6	Temperature :	24~26°C
Test Engineer :	Reece Li	Relative Humidity :	50~53%

Channel	Frequency (MHz)	802.11g 6dB Bandwidth (MHz)	6dB Bandwidth Min. Limit (MHz)	Pass/Fail
01	2412	15.718	0.5	Pass
06	2437	15.885	0.5	Pass
11	2462	15.747	0.5	Pass

Mode 4 : 6 dB Bandwidth Plot on 802.11g Channel 01

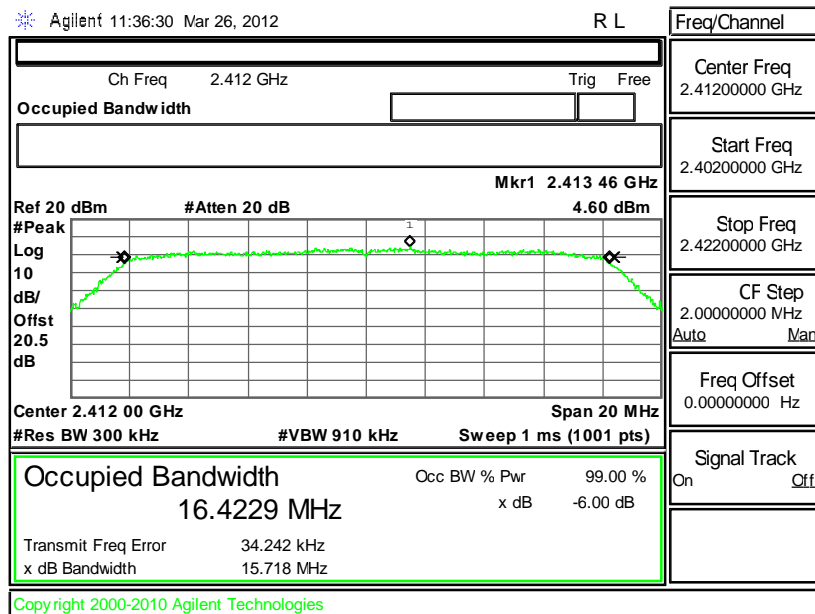



Mode 5 : 6 dB Bandwidth Plot on 802.11g Channel 06

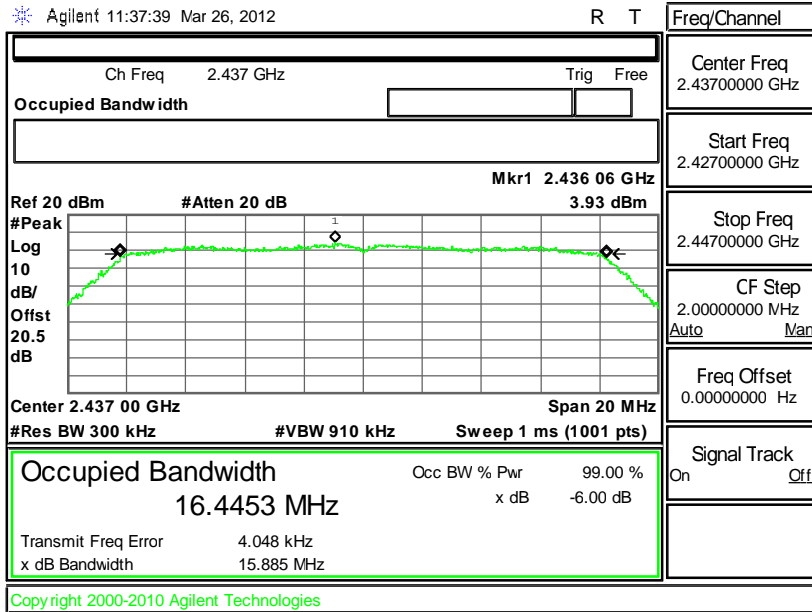

Mode 6 : 6 dB Bandwidth Plot on 802.11g Channel 11

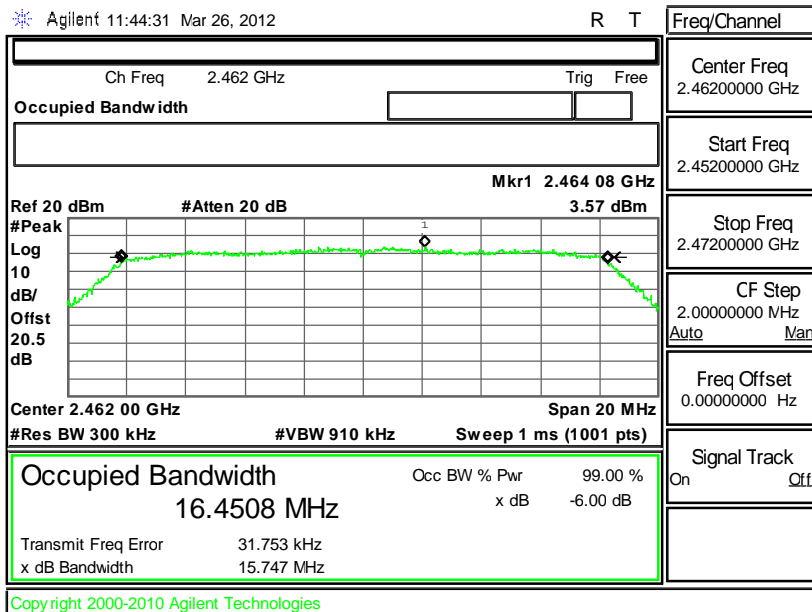



Test Mode :	Mode 7, 8, 9	Temperature :	24~26°C
Test Engineer :	Reece Li	Relative Humidity :	50~53%

Channel	Frequency (MHz)	802.11g/n (BW 20MHz) 6dB Bandwidth (MHz)	6dB Bandwidth Min. Limit (MHz)	Pass/Fail
01	2412	17.176	0.5	Pass
06	2437	17.335	0.5	Pass
11	2462	17.138	0.5	Pass

Mode 7 : 6 dB Bandwidth Plot on 802.11g/n(BW 20MHz) Channel

01

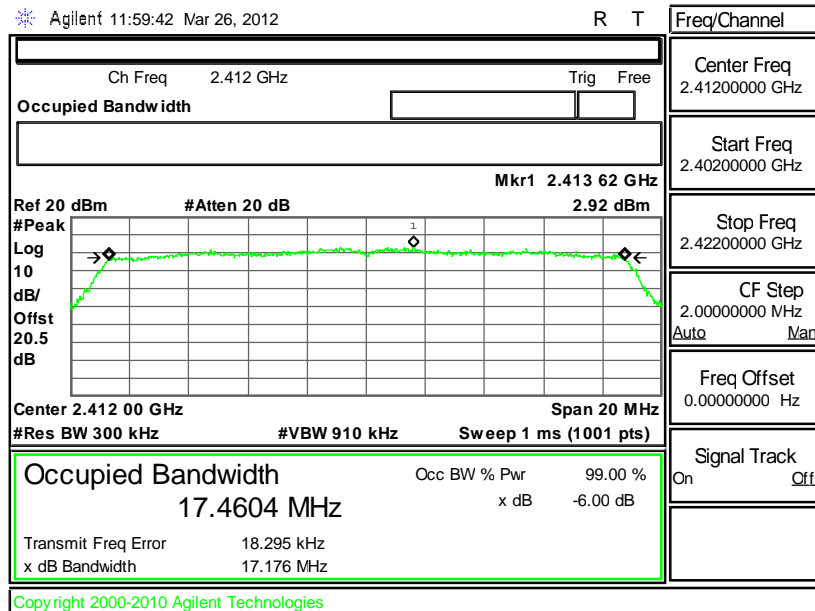



Mode 8 : 6 dB Bandwidth Plot on 802.11g/n(BW 20MHz) Channel

06

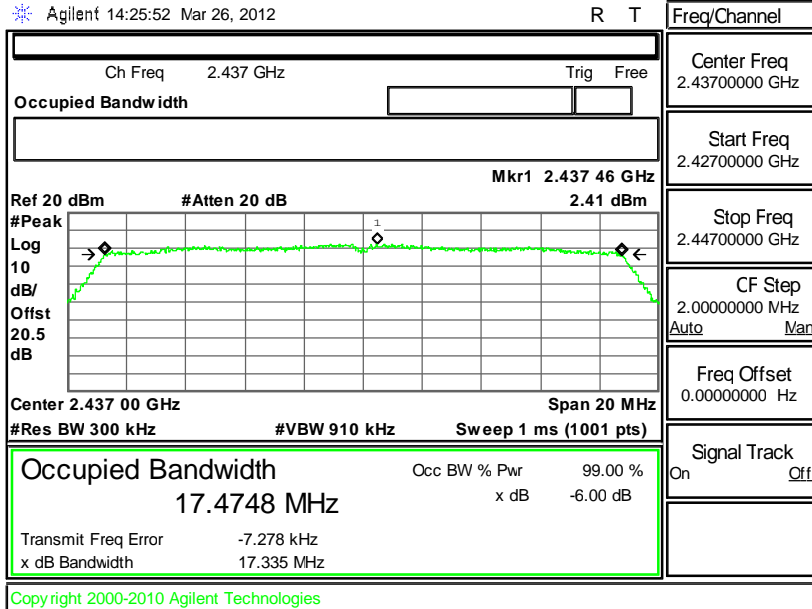

Mode 9 : 6 dB Bandwidth Plot on 802.11g/n(BW 20MHz) Channel

11

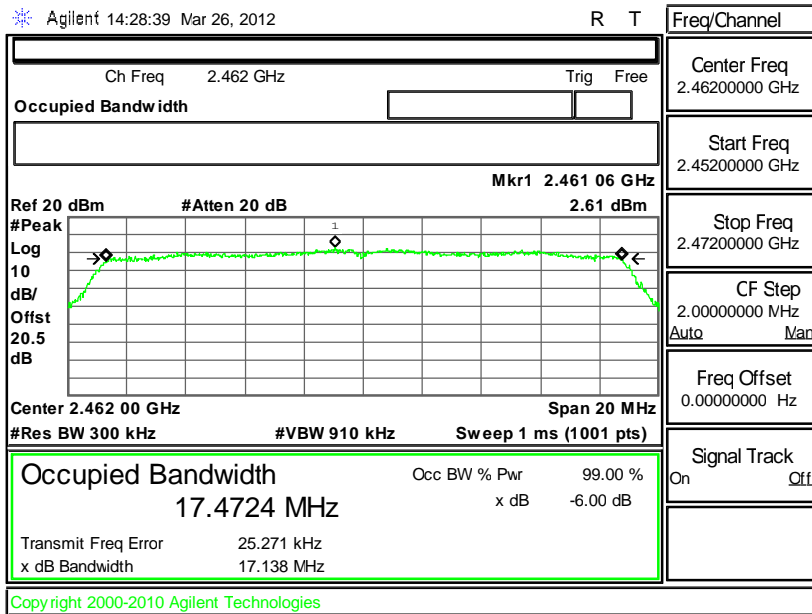



3.1.6 Test Result of 99% Occupied Bandwidth

Test Mode :	Mode 1, 2, 3	Temperature :	24~26°C
Test Engineer :	Reece Li	Relative Humidity :	50~53%

Channel	Frequency (MHz)	802.11b 99% Occupied Bandwidth (MHz)	Pass/Fail
01	2412	12.6533	Pass
06	2437	12.5778	Pass
11	2462	12.4319	Pass

Mode 1 : 99% Occupied Bandwidth Plot on 802.11b Channel 01

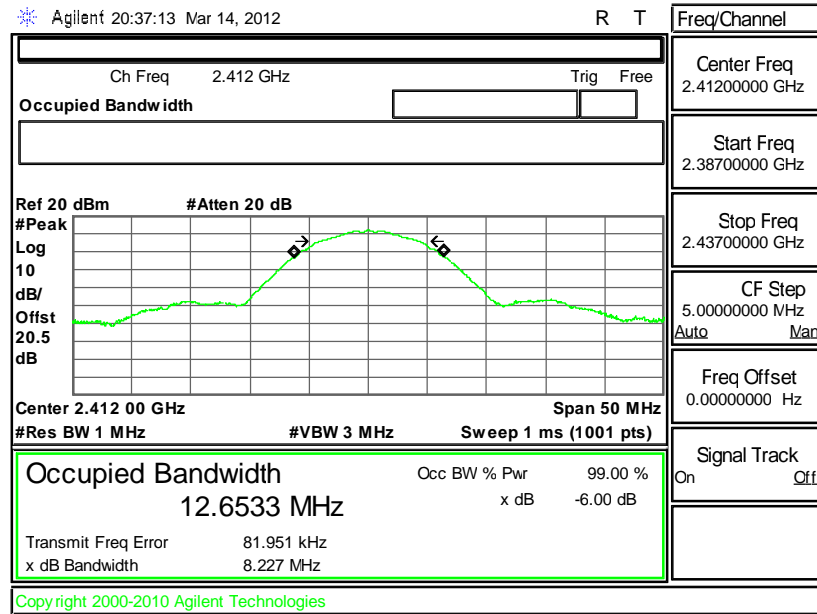



Mode 2 : 99% Occupied Bandwidth Plot on 802.11b Channel 06

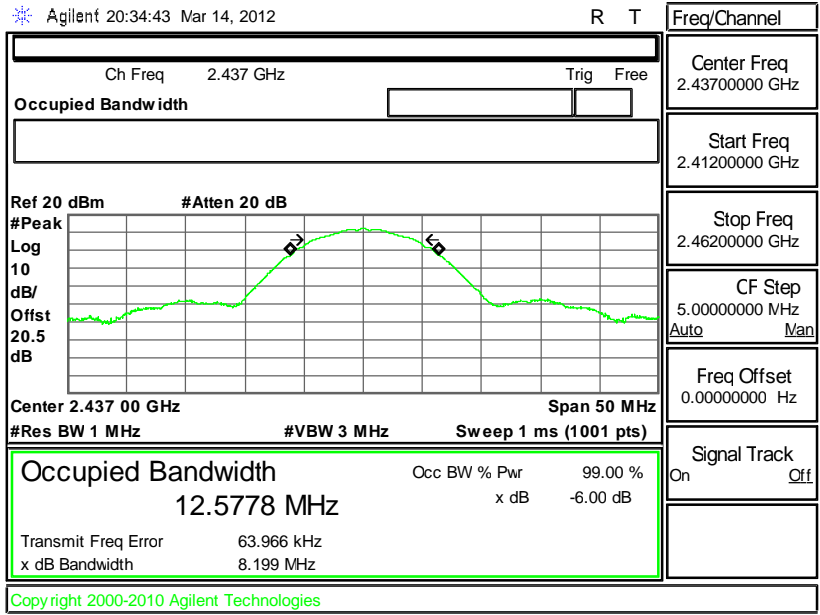

Mode 3 : 99% Occupied Bandwidth Plot on 802.11b Channel 11

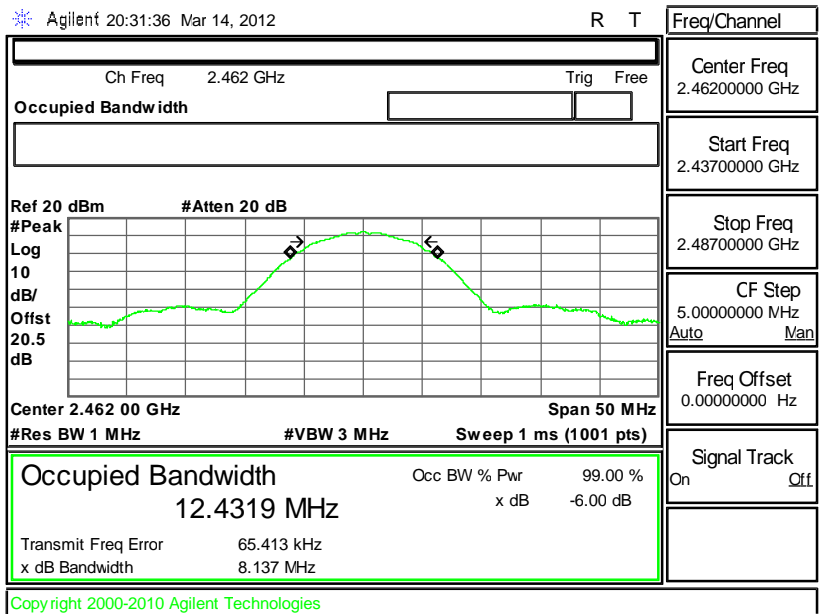



Test Mode :	Mode 4, 5, 6	Temperature :	24~26°C
Test Engineer :	Reece Li	Relative Humidity :	50~53%

Channel	Frequency (MHz)	802.11g 99% Occupied Bandwidth (MHz)	Pass/Fail
01	2412	17.5093	Pass
06	2437	17.4561	Pass
11	2462	17.5863	Pass

Mode 4 : 99% Occupied Bandwidth Plot on 802.11g Channel 01

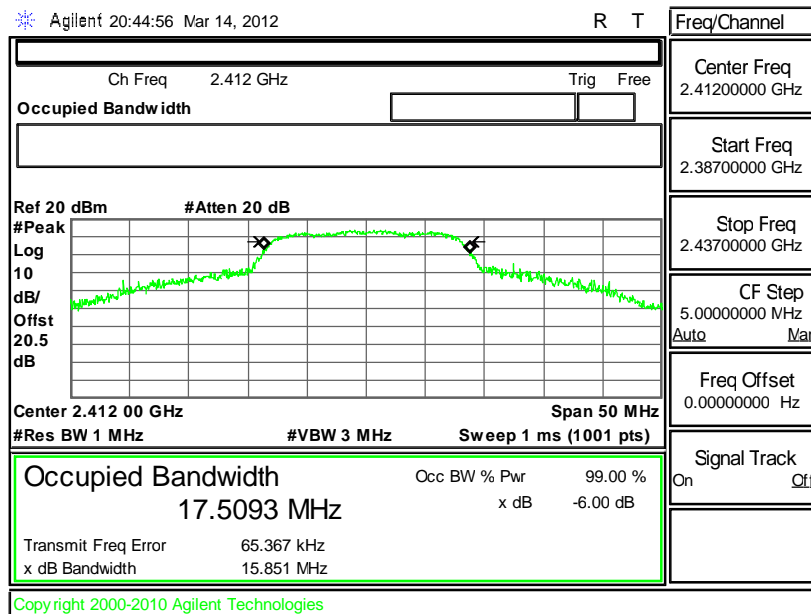



Mode 5 : 99% Occupied Bandwidth Plot on 802.11g Channel 06

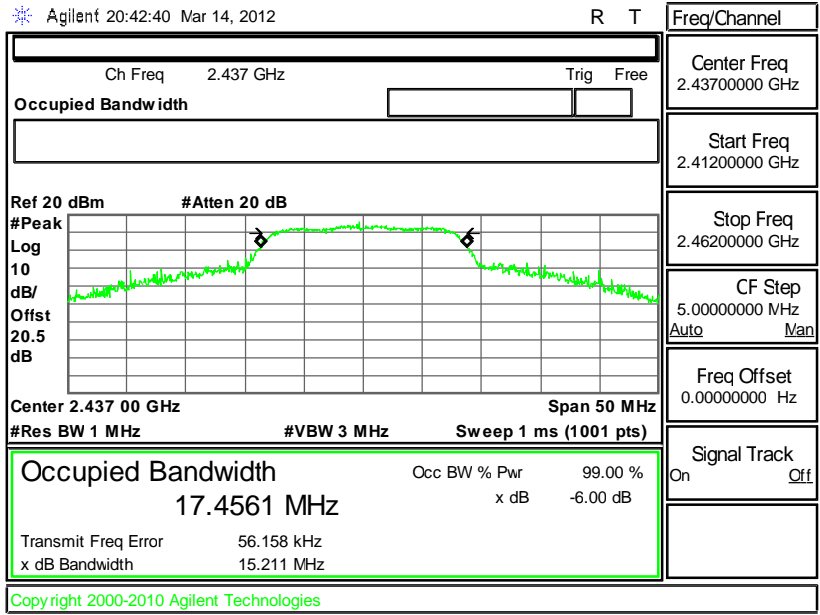

Mode 6 : 99% Occupied Bandwidth Plot on 802.11g Channel 11

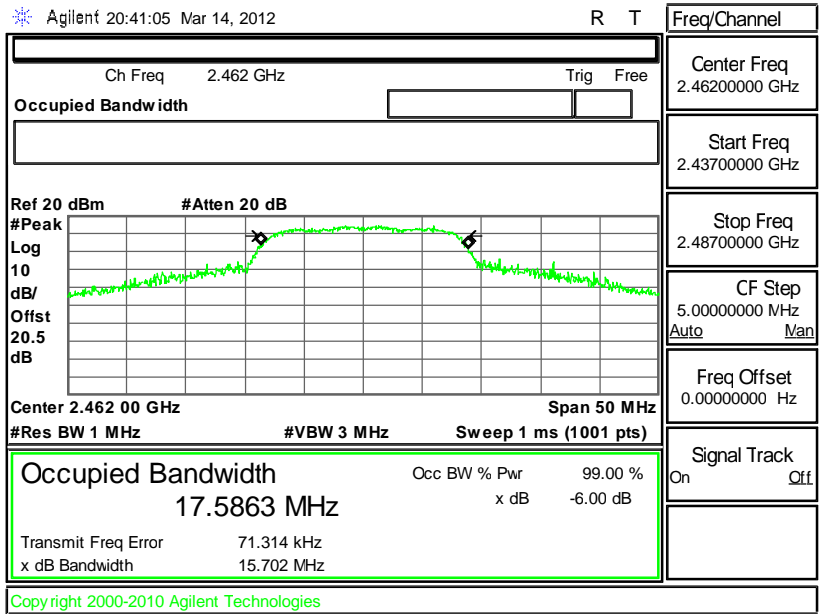



Test Mode :	Mode 7, 8, 9	Temperature :	24~26°C
Test Engineer :	Reece Li	Relative Humidity :	50~53%

Channel	Frequency (MHz)	802.11g/n (BW 20MHz) 99% Occupied Bandwidth (MHz)	Pass/Fail
01	2412	17.8363	Pass
06	2437	17.8135	Pass
11	2462	17.8303	Pass

Mode 7 : 99% Occupied Bandwidth Plot on 802.11g/n(BW 20MHz) Channel 01

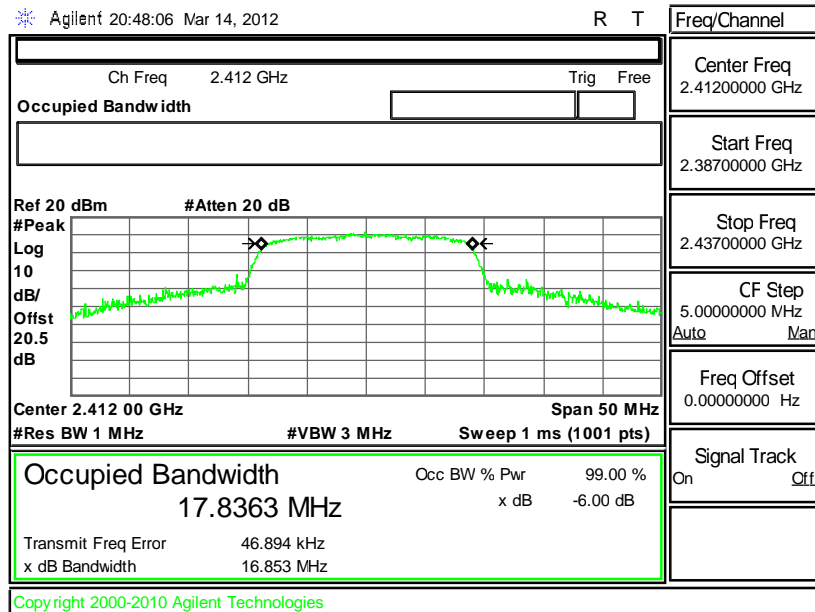



Mode 8 : 99% Occupied Bandwidth Plot on 802.11g/n(BW 20MHz) Channel 06

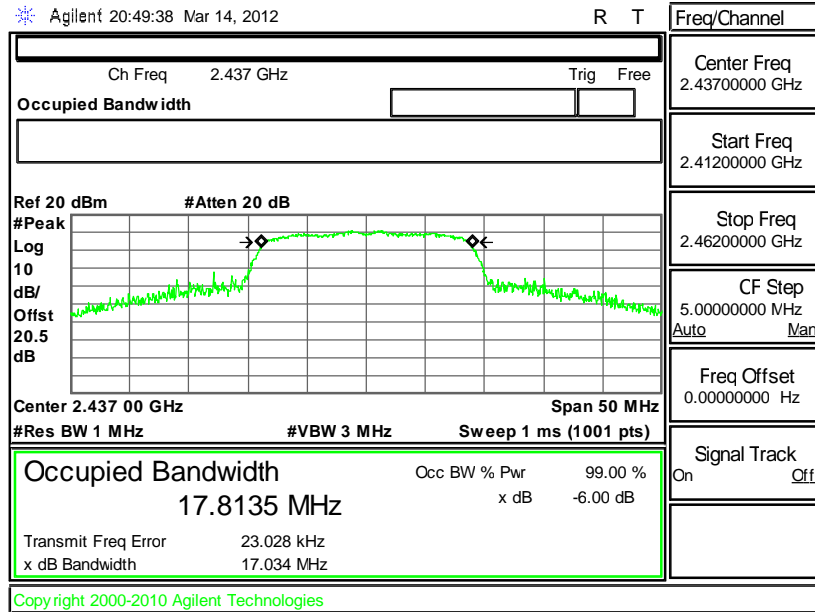

Mode 9 : 99% Occupied Bandwidth Plot on 802.11g/n(BW 20MHz) Channel 11

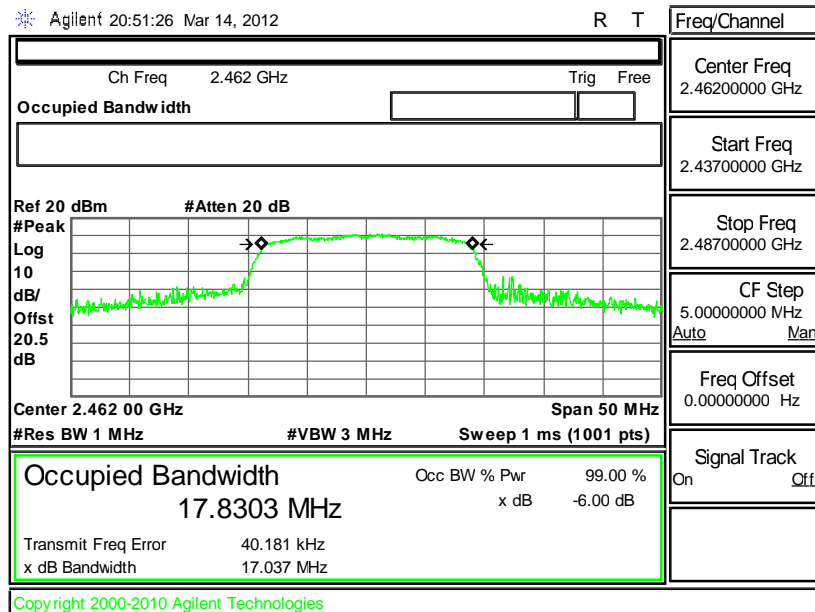

3.2 Output Power Measurement

3.2.1 Limit of Output Power

For systems using digital modulation in the 2400-2483.5MHz, the limit for peak output power is 30dBm. If transmitting antenna of directional gain greater than 6dBi are used the peak output power from the intentional radiator shall be reduced below the above stated value by the amount in dB that the directional gain of the antenna exceeds 6 dBi. In case of point-to-point operation, the limit has to be reduced by 1dB for every 3dB that the directional gain of the antenna exceeds 6dBi.

3.2.2 Measuring Instruments

See list of measuring instruments of this test report.

3.2.3 Test Procedures

1. The testing follows the Measurement Procedure PK2 of FCC KDB No. 558074 DTS Meas. Guidance v01.
2. The RF output of EUT was connected to the spectrum analyzer by a low loss cable. The path loss was compensated to the results for each measurement.
3. The spectrum analyzer's settings are Resolution bandwidth (RBW) = 1MHz, Video bandwidth (VBW) = 3MHz, Peak Detector, auto sweep time, and the frequency span to a value that is 5-30 % greater than the EBW.
4. The spectrum analyzer's integrated band power measurement function is used to measure the peak power and the test results are demonstrated to compliance to the limit line as following plots.

3.2.4 Test Setup

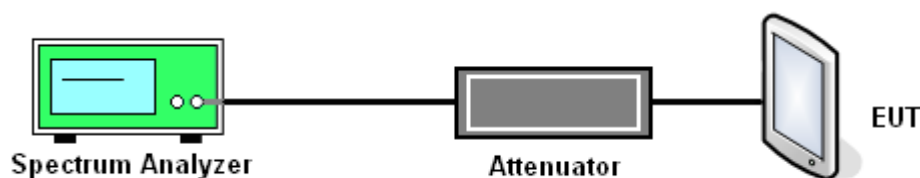



3.2.5 Test Result of Output Power

Test Mode :	Mode 1, 2, 3	Temperature :	24~26°C
Test Engineer :	Reece Li	Relative Humidity :	50~53%

Channel	Frequency (MHz)	802.11b Peak Output Power (dBm)	Max. Limits (dBm)	Pass/Fail
01	2412	16.16	30	Pass
06	2437	16.12	30	Pass
11	2462	15.88	30	Pass

Mode 1 : Output Power Plot on 802.11b Channel 01

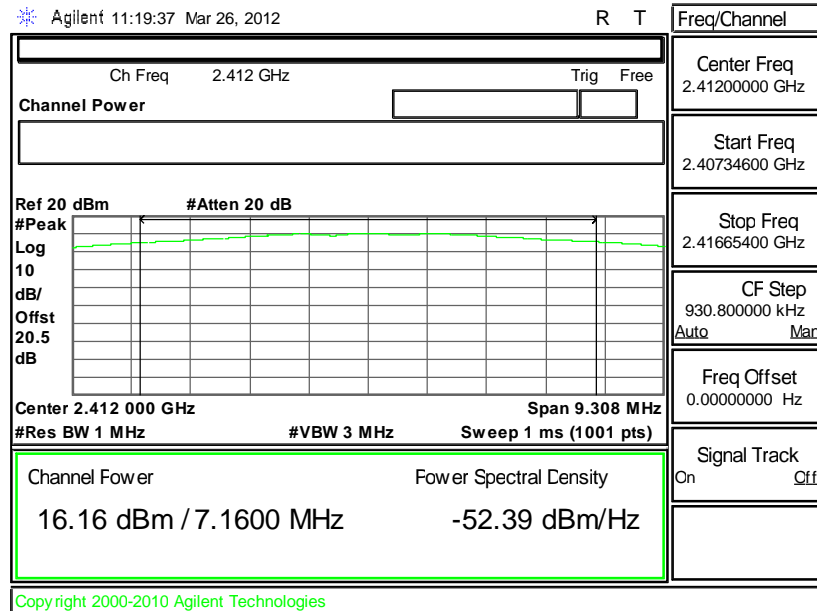



Mode 2 : Output Power Plot on 802.11b Channel 06

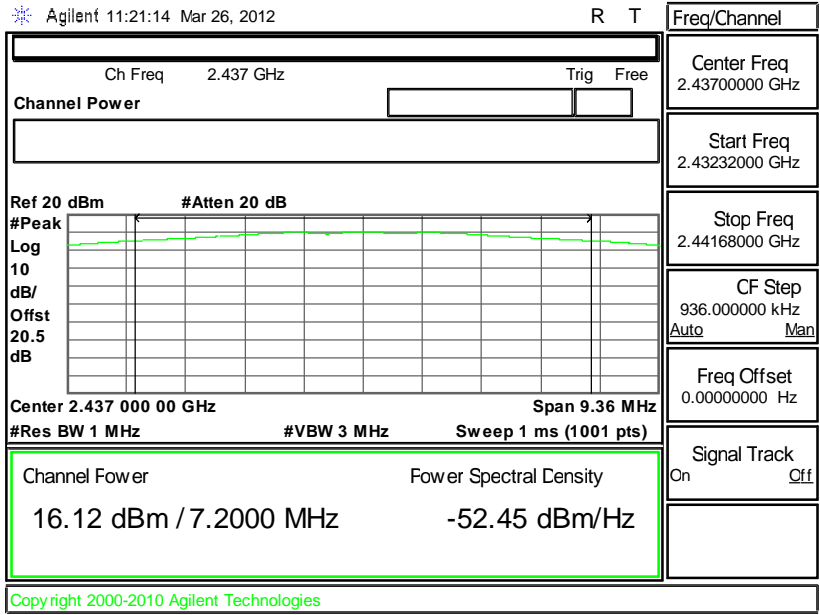

Mode 3 : Output Power Plot on 802.11b Channel 11

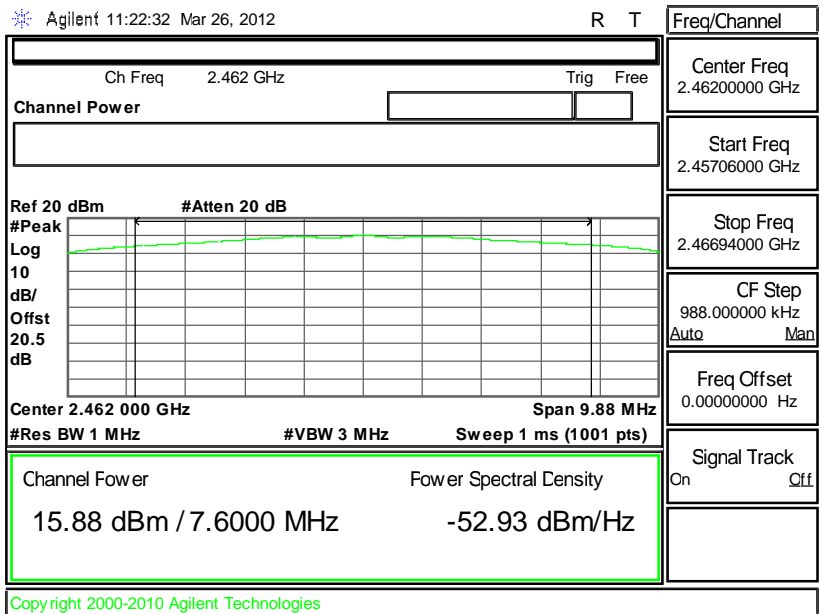



Test Mode :	Mode 4, 5, 6	Temperature :	24~26°C
Test Engineer :	Reece Li	Relative Humidity :	50~53%

Channel	Frequency (MHz)	802.11g Peak Output Power (dBm)	Max. Limits (dBm)	Pass/Fail
01	2412	17.08	30	Pass
06	2437	16.86	30	Pass
11	2462	16.66	30	Pass

Mode 4 : Output Power Plot on 802.11g Channel 01

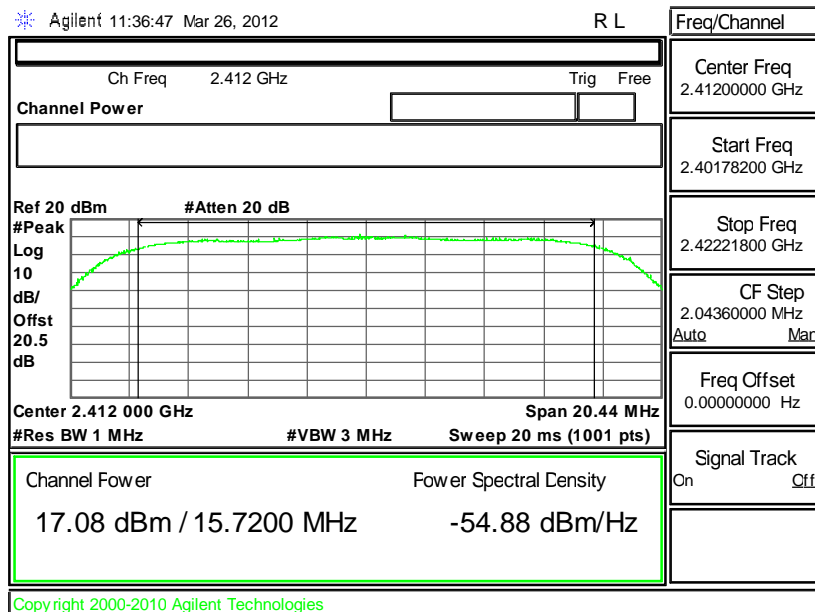



Mode 5 : Output Power Plot on 802.11g Channel 06

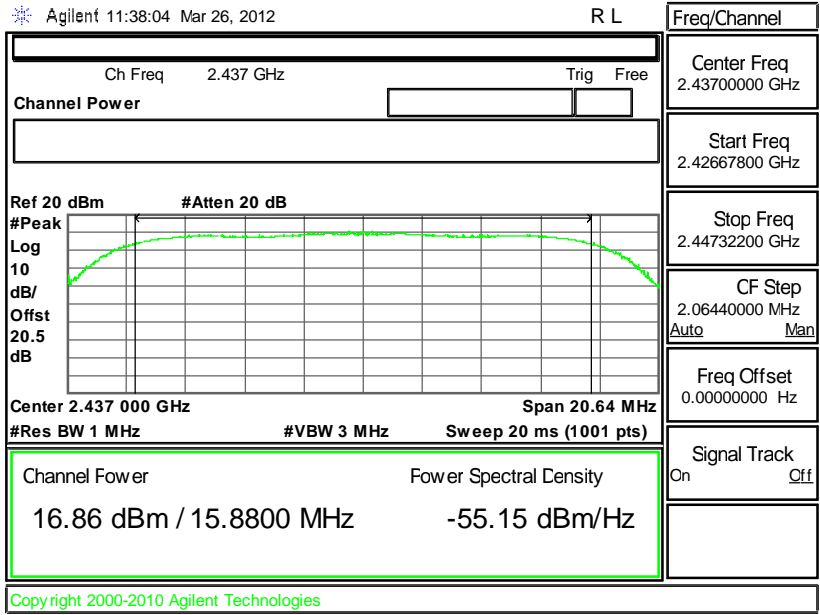

Mode 6 : Output Power Plot on 802.11g Channel 11

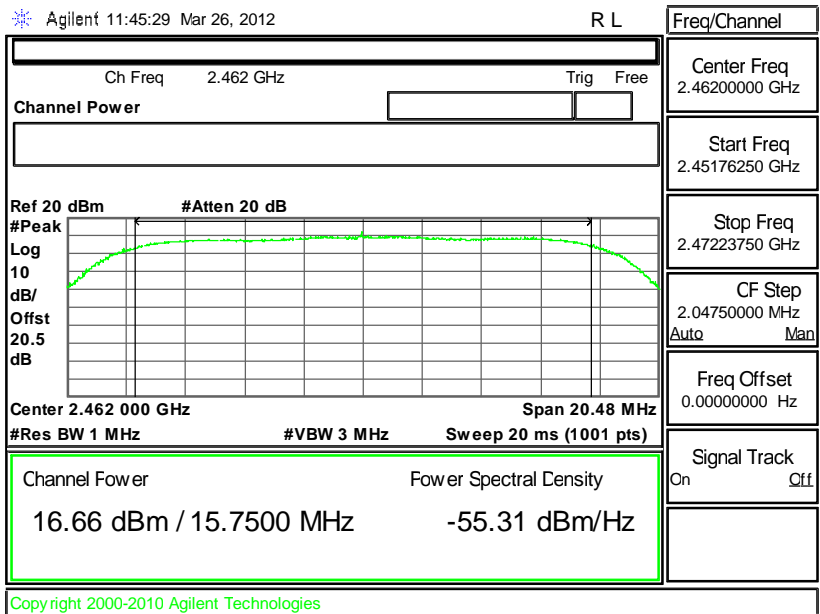



Test Mode :	Mode 7, 8, 9	Temperature :	24~26°C
Test Engineer :	Reece Li	Relative Humidity :	50~53%

Channel	Frequency (MHz)	802.11g/n (BW 20MHz) Peak Output Power (dBm)	Max. Limits (dBm)	Pass/Fail
01	2412	15.92	30	Pass
06	2437	15.84	30	Pass
11	2462	15.34	30	Pass

Mode 7: Output Power Plot on 802.11g/n (BW 20MHz) channel 01

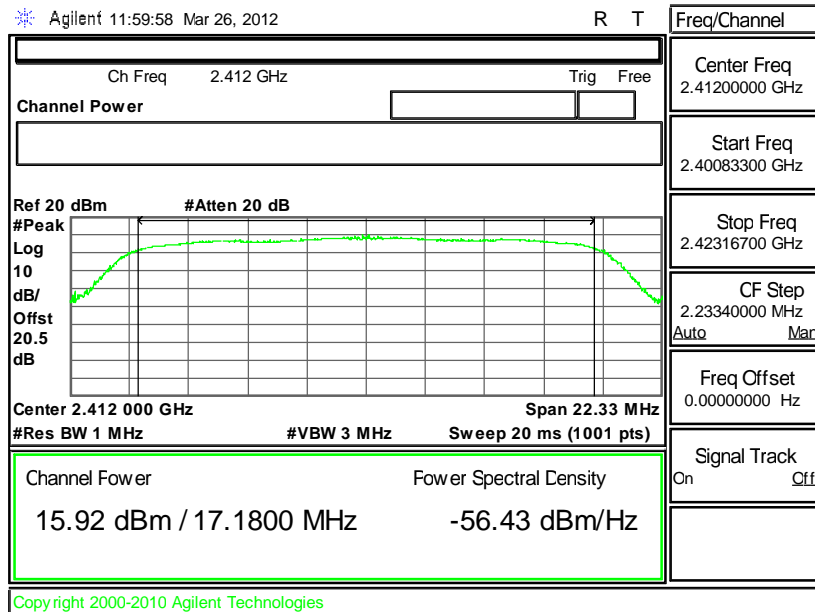



Mode 8 : Output Power Plot on 802.11g/n (BW 20MHz) Channel 06

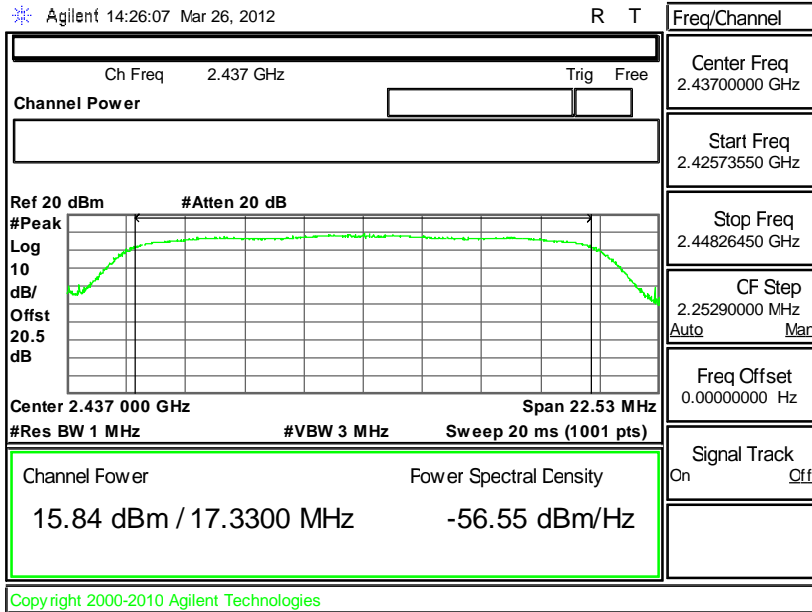

Mode 9 : Output Power Plot on 802.11g/n (BW 20MHz) Channel 11

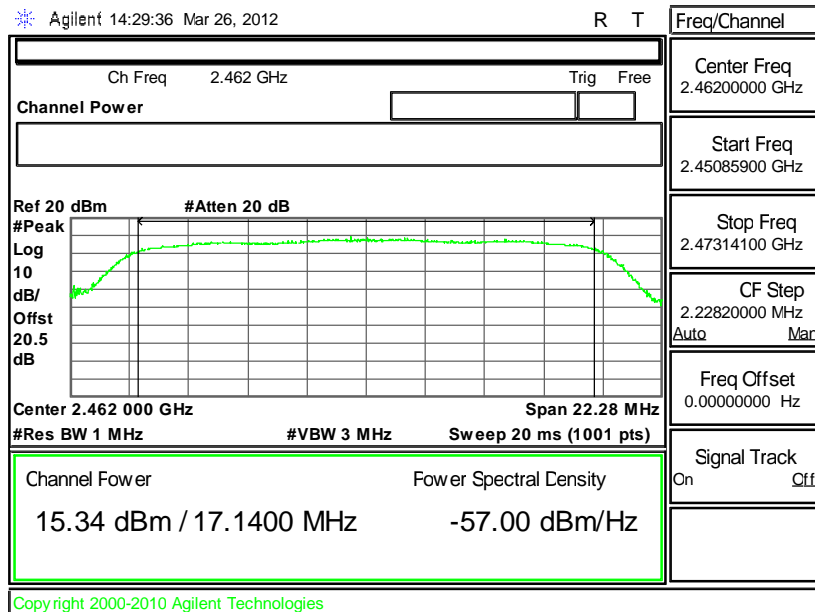



3.3 Band Edges Measurement

3.3.1 Limit of Band Edges

In any 100 KHz bandwidth outside the intentional radiation frequency band, the radio frequency power shall be at least 20 dB below the highest level of the radiated power. If the output power of this device was measured by spectrum analyzer, the attenuation under this paragraph shall be 30 dB instead of 20 dB.

3.3.2 Measuring Instruments

See list of measuring instruments of this test report.

3.3.3 Test Procedures

1. The testing follows the guidelines in ANSI C63.4-2003 and the Measurement Procedure of FCC KDB Publication No. 558074 D01 DTS Meas. Guidance v01.
2. Conducted emission test: Set RBW = 100 KHz, Video bandwidth (VBW) \geq RBW. Out of the authorized frequency band emissions must be at least 20 dB lower than the highest emission level within the authorized band as measured with a 100 KHz RBW. If the transmitter complies with the conducted power limits based on the use of RMS averaging over a time interval, the attenuation required under this paragraph shall be 30 dB instead of 20 dB per 15.247(d).
3. Radiated emission test: Apply to band edge emissions that falling on the restricted bands listed in FCC Section 15.205. The maximum permitted average field strength is listed in FCC Section 15.209. A pre-amp is necessary for this measurement. For measurement above 1 GHz, set RBW = 1MHz, VBW = 10 Hz, Sweep=Auto. If the emission is pulsed, then modify the unit for continuous operation. Use the settings in this paragraph to correct the reading level by subtracting the peak-average correction factor, derived from the appropriate duty cycle calculation per 15.35(b) and (c).

3.3.4 Test Setup

<Radiated Band Edges>

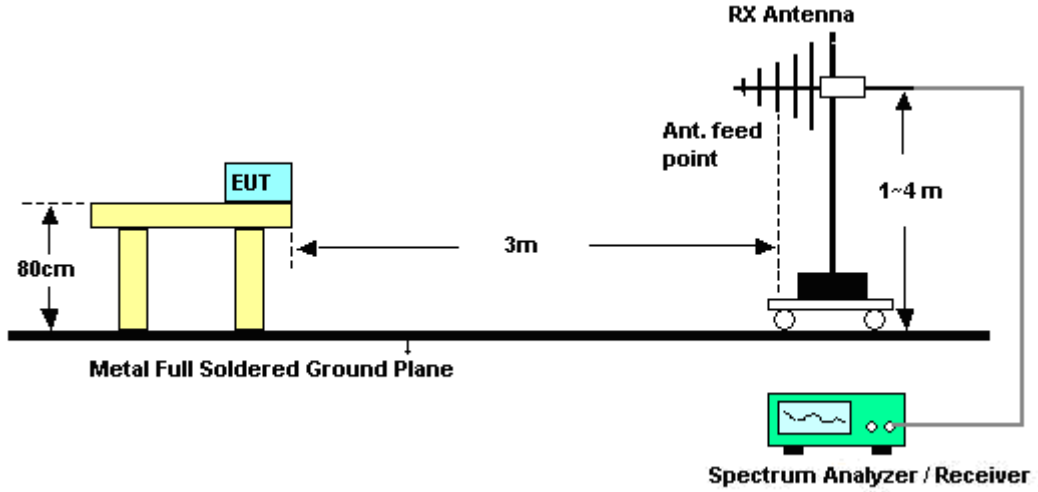

<Conducted Band Edges>

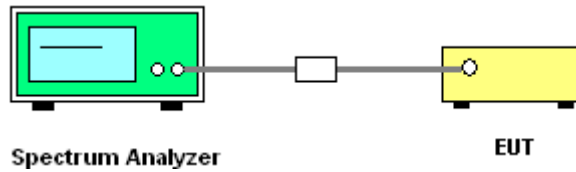



3.3.5 Test Result of Radiated Band Edges

Test Mode :	Mode 1	Temperature :	23~24°C
Test Band :	802.11b	Relative Humidity :	44~45%
Test Channel :	01	Test Engineer :	David Ke

ANTENNA POLARITY : HORIZONTAL										
Frequency (MHz)	Level (dBμV/m)	Over Limit (dB)	Limit Line (dBμV/m)	Read Level (dBμV)	Antenna Factor (dB)	Cable Loss (dB)	Preamp Factor (dB)	Ant Pos (cm)	Table Pos (deg)	Remark
2389.04	61.02	-12.98	74	60.3	32.02	4.58	35.88	100	46	Peak
2389.04	53.22	-0.78	54	52.5	32.02	4.58	35.88	100	46	Average

ANTENNA POLARITY : VERTICAL										
Frequency (MHz)	Level (dBμV/m)	Over Limit (dB)	Limit Line (dBμV/m)	Read Level (dBμV)	Antenna Factor (dB)	Cable Loss (dB)	Preamp Factor (dB)	Ant Pos (cm)	Table Pos (deg)	Remark
2389.42	57.64	-16.36	74	56.92	32.02	4.58	35.88	125	246	Peak
2389.42	49.48	-4.52	54	48.76	32.02	4.58	35.88	125	246	Average

Test Mode :	Mode 3	Temperature :	23~24°C
Test Band :	802.11b	Relative Humidity :	44~45%
Test Channel :	11	Test Engineer :	David Ke

ANTENNA POLARITY : HORIZONTAL										
Frequency (MHz)	Level (dBμV/m)	Over Limit (dB)	Limit Line (dBμV/m)	Read Level (dBμV)	Antenna Factor (dB)	Cable Loss (dB)	Preamp Factor (dB)	Ant Pos (cm)	Table Pos (deg)	Remark
2493.16	57.56	-16.44	74	56.62	32.1	4.64	35.8	100	52	Peak
2493.16	47.27	-6.73	54	46.33	32.1	4.64	35.8	100	52	Average

ANTENNA POLARITY : VERTICAL										
Frequency (MHz)	Level (dBμV/m)	Over Limit (dB)	Limit Line (dBμV/m)	Read Level (dBμV)	Antenna Factor (dB)	Cable Loss (dB)	Preamp Factor (dB)	Ant Pos (cm)	Table Pos (deg)	Remark
2488.6	55.1	-18.9	74	54.17	32.1	4.64	35.81	132	73	Peak
2488.6	44.65	-9.35	54	43.72	32.1	4.64	35.81	132	73	Average



Test Mode :	Mode 4	Temperature :	23~24°C
Test Band :	802.11g	Relative Humidity :	44~45%
Test Channel :	01	Test Engineer :	David Ke

ANTENNA POLARITY : HORIZONTAL										
Frequency (MHz)	Level (dBμV/m)	Over Limit (dB)	Limit Line (dBμV/m)	Read Level (dBμV)	Antenna Factor (dB)	Cable Loss (dB)	Preamp Factor (dB)	Ant Pos (cm)	Table Pos (deg)	Remark
2389.99	71.17	-2.83	74	70.43	32.02	4.58	35.86	100	43	Peak
2389.99	48.85	-5.15	54	48.11	32.02	4.58	35.86	100	43	Average

ANTENNA POLARITY : VERTICAL										
Frequency (MHz)	Level (dBμV/m)	Over Limit (dB)	Limit Line (dBμV/m)	Read Level (dBμV)	Antenna Factor (dB)	Cable Loss (dB)	Preamp Factor (dB)	Ant Pos (cm)	Table Pos (deg)	Remark
2389.04	66.23	-7.77	74	65.51	32.02	4.58	35.88	150	252	Peak
2389.04	44.9	-9.1	54	44.18	32.02	4.58	35.88	150	252	Average

Test Mode :	Mode 6	Temperature :	23~24°C
Test Band :	802.11g	Relative Humidity :	44~45%
Test Channel :	11	Test Engineer :	David Ke

ANTENNA POLARITY : HORIZONTAL										
Frequency (MHz)	Level (dBμV/m)	Over Limit (dB)	Limit Line (dBμV/m)	Read Level (dBμV)	Antenna Factor (dB)	Cable Loss (dB)	Preamp Factor (dB)	Ant Pos (cm)	Table Pos (deg)	Remark
2483.5	68.82	-5.18	74	67.9	32.09	4.64	35.81	100	52	Peak
2483.5	46.3	-7.7	54	45.38	32.09	4.64	35.81	100	52	Average

ANTENNA POLARITY : VERTICAL										
Frequency (MHz)	Level (dBμV/m)	Over Limit (dB)	Limit Line (dBμV/m)	Read Level (dBμV)	Antenna Factor (dB)	Cable Loss (dB)	Preamp Factor (dB)	Ant Pos (cm)	Table Pos (deg)	Remark
2484.04	65.11	-8.89	74	64.19	32.09	4.64	35.81	185	80	Peak
2484.04	42.94	-11.06	54	42.02	32.09	4.64	35.81	185	80	Average



Test Mode :	Mode 7	Temperature :	23~24°C
Test Band :	802.11g/n (BW 20MHz)	Relative Humidity :	44~45%
Test Channel :	01	Test Engineer :	David Ke

ANTENNA POLARITY : HORIZONTAL										
Frequency (MHz)	Level (dBμV/m)	Over Limit (dB)	Limit Line (dBμV/m)	Read Level (dBμV)	Antenna Factor (dB)	Cable Loss (dB)	Preamp Factor (dB)	Ant Pos (cm)	Table Pos (deg)	Remark
2389.61	70.53	-3.47	74	69.81	32.02	4.58	35.88	100	45	Peak
2389.61	47.98	-6.02	54	47.26	32.02	4.58	35.88	100	45	Average

ANTENNA POLARITY : VERTICAL										
Frequency (MHz)	Level (dBμV/m)	Over Limit (dB)	Limit Line (dBμV/m)	Read Level (dBμV)	Antenna Factor (dB)	Cable Loss (dB)	Preamp Factor (dB)	Ant Pos (cm)	Table Pos (deg)	Remark
2389.8	66.77	-7.23	74	66.03	32.02	4.58	35.86	125	247	Peak
2389.8	45.93	-8.07	54	45.19	32.02	4.58	35.86	125	247	Average

Test Mode :	Mode 9	Temperature :	23~24°C
Test Band :	802.11g/n (BW 20MHz)	Relative Humidity :	44~45%
Test Channel :	11	Test Engineer :	David Ke

ANTENNA POLARITY : HORIZONTAL										
Frequency (MHz)	Level (dBμV/m)	Over Limit (dB)	Limit Line (dBμV/m)	Read Level (dBμV)	Antenna Factor (dB)	Cable Loss (dB)	Preamp Factor (dB)	Ant Pos (cm)	Table Pos (deg)	Remark
2483.66	67.54	-6.46	74	66.62	32.09	4.64	35.81	100	53	Peak
2483.66	45.12	-8.88	54	44.2	32.09	4.64	35.81	100	53	Average

ANTENNA POLARITY : VERTICAL										
Frequency (MHz)	Level (dBμV/m)	Over Limit (dB)	Limit Line (dBμV/m)	Read Level (dBμV)	Antenna Factor (dB)	Cable Loss (dB)	Preamp Factor (dB)	Ant Pos (cm)	Table Pos (deg)	Remark
2483.85	66.24	-7.76	74	65.32	32.09	4.64	35.81	131	72	Peak
2483.85	43.57	-10.43	54	42.65	32.09	4.64	35.81	131	72	Average



3.3.6 Test Plots of Conducted Band Edges

Test Mode :	Mode 1 and 3	Temperature :	24~26°C
Test Band :	802.11b	Relative Humidity :	50~53%
Test Channel :	01 and 11	Test Engineer :	Reece Li

Low Band Edge Plot on 802.11b Channel 01

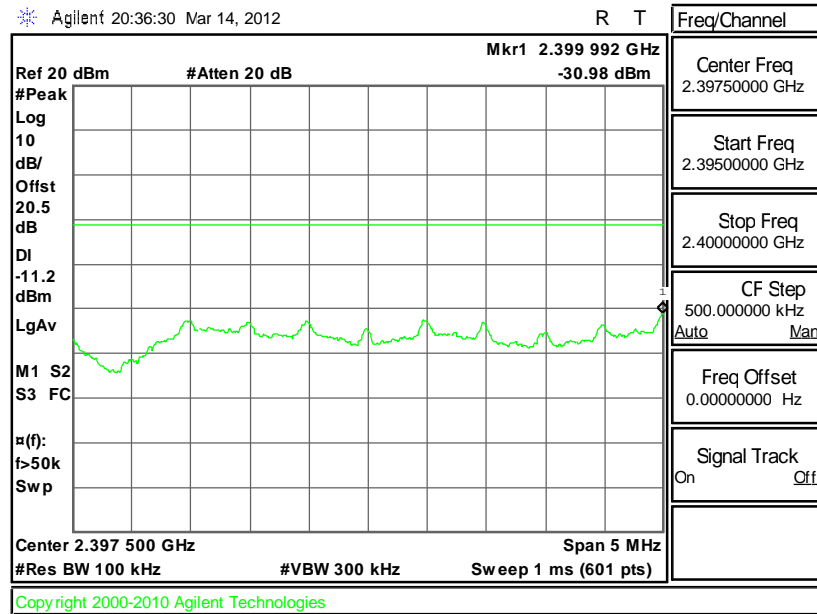

High Band Edge Plot on 802.11b Channel 11

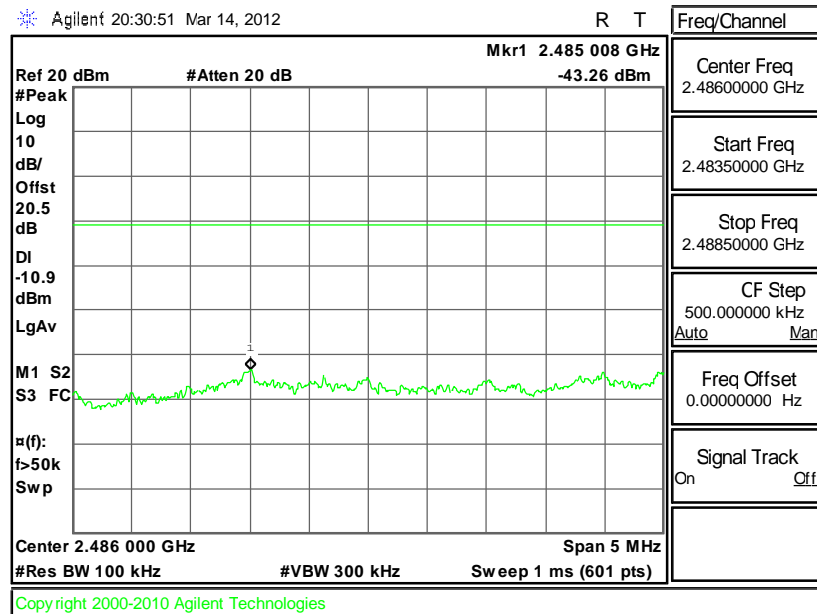



Test Mode :	Mode 4 and 6	Temperature :	24~26°C
Test Band :	802.11g	Relative Humidity :	50~53%
Test Channel :	01 and 11	Test Engineer :	Reece Li

Low Band Edge Plot on 802.11g Channel 01

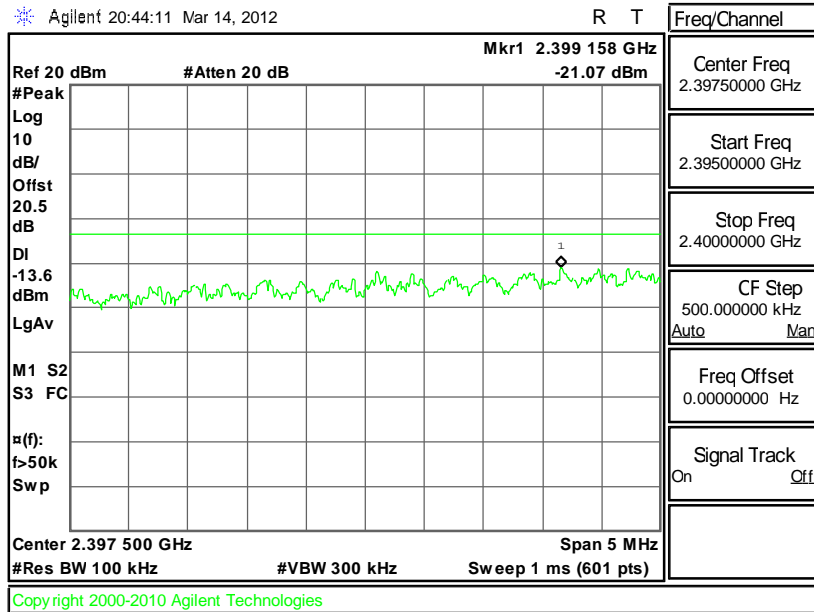

High Band Edge Plot on 802.11g Channel 11

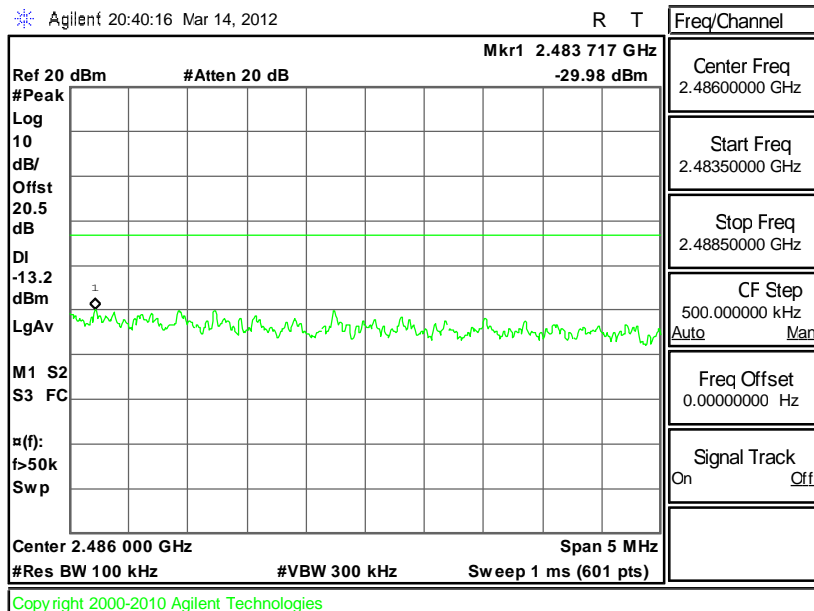



Test Mode :	Mode 7 and 9	Temperature :	24~26°C
Test Band :	802.11g/n (BW 20MHz)	Relative Humidity :	50~53%
Test Channel :	01 and 11	Test Engineer :	Reece Li

Low Band Edge Plot on 802.11g/n (BW 20MHz) Channel 01

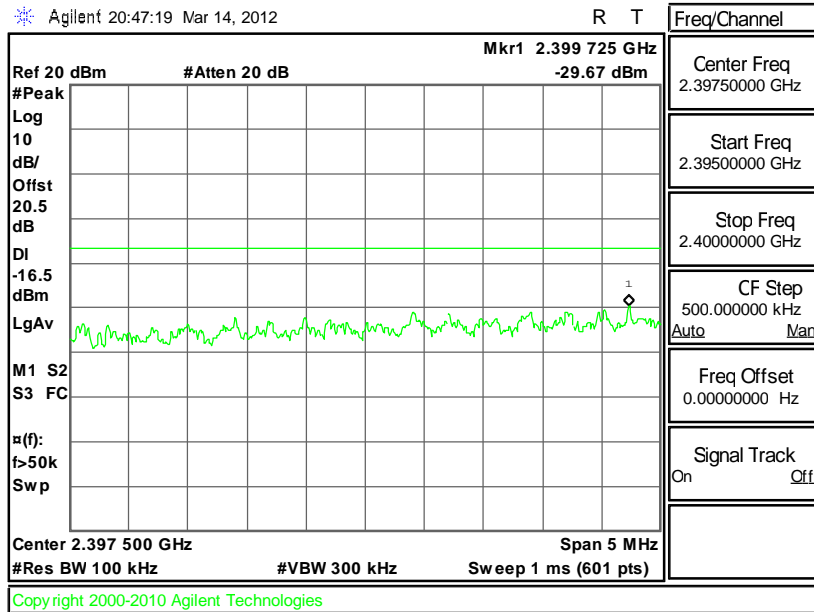

High Band Edge Plot on 802.11g/n (BW 20MHz) Channel 11

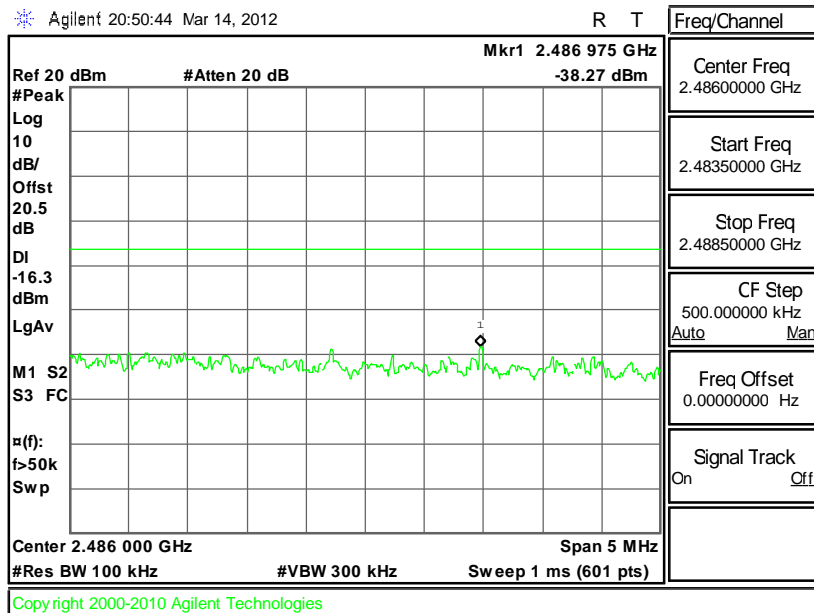

3.4 Spurious Emission Measurement

3.4.1 Limit of Spurious Emission Measurement

All harmonics/spurious must be at least 20 dB down from the highest emission level within the authorized band.

3.4.2 Measuring Instruments

See list of measuring instruments of this test report.

3.4.3 Test Procedure

1. The transmitter output was connected to the spectrum analyzer via a low lose cable. The path loss was compensated to the results for each measurement.
2. Set RBW = 100 KHz, Video bandwidth (VBW) \geq RBW, scan up through 10th harmonic. All harmonics/spurs must be at least 20 dB down from the highest emission level within the authorized band as measured with a 100 KHz RBW.

3.4.4 Test Setup

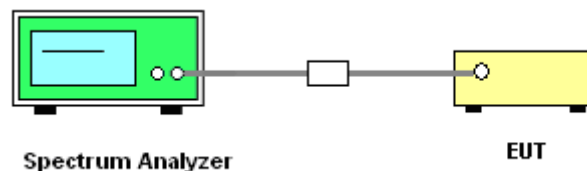



3.4.5 Test Plots of Spurious Emission

Test Mode :	Mode 1	Temperature :	24~26°C
Test Band :	802.11b	Relative Humidity :	50~53%
Test Channel :	01	Test Engineer :	Reece Li

Conducted Spurious Emission Plot between 30MHz ~ 3 GHz

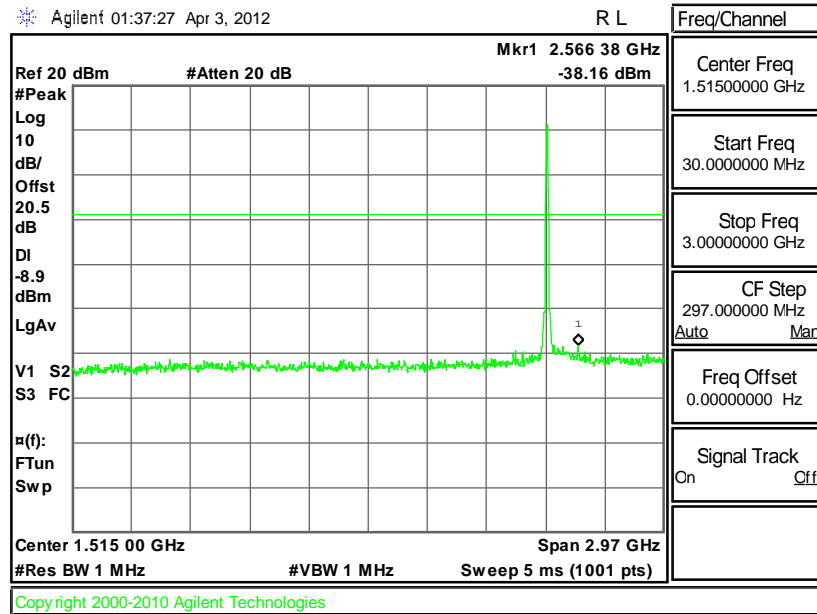

Conducted Spurious Emission Plot between 3 GHz ~ 25 GHz

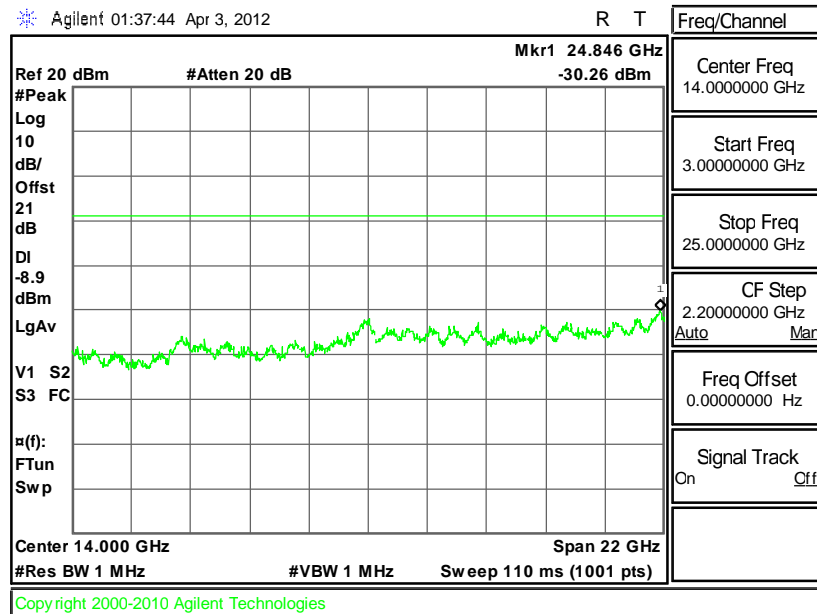



Test Mode :	Mode 2	Temperature :	24~26°C
Test Band :	802.11b	Relative Humidity :	50~53%
Test Channel :	06	Test Engineer :	Reece Li

Conducted Spurious Emission Plot between 30MHz ~ 3 GHz

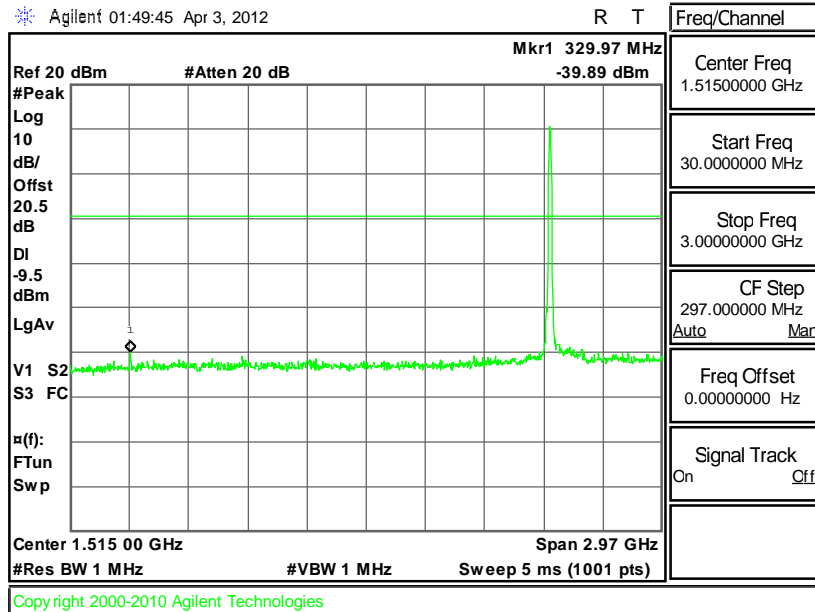

Conducted Spurious Emission Plot between 3 GHz ~ 25 GHz

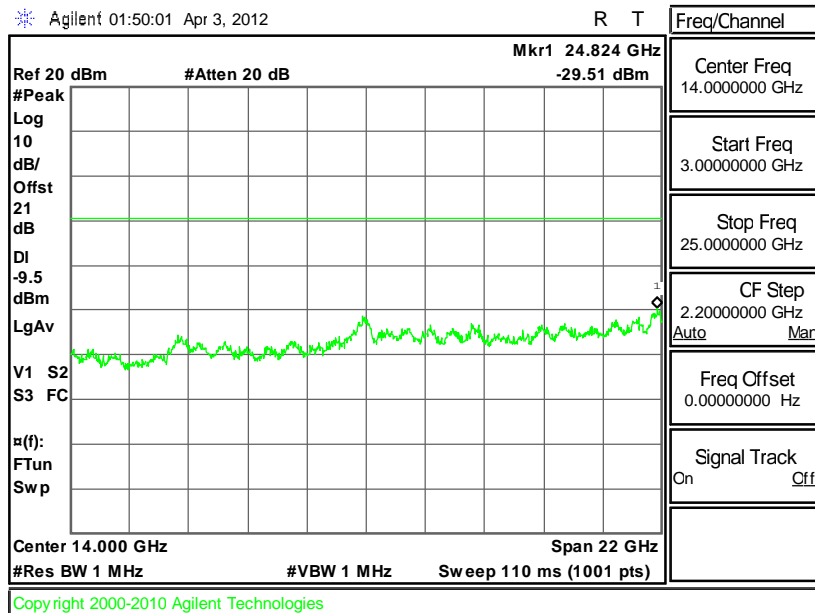



Test Mode :	Mode 3	Temperature :	24~26°C
Test Band :	802.11b	Relative Humidity :	50~53%
Test Channel :	11	Test Engineer :	Reece Li

Conducted Spurious Emission Plot between 30MHz ~ 3 GHz

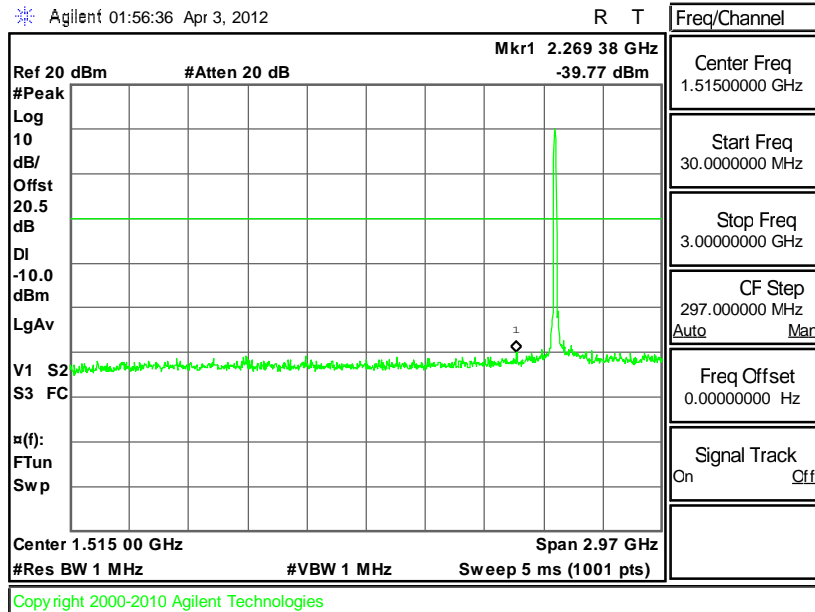

Conducted Spurious Emission Plot between 3 GHz ~ 25 GHz

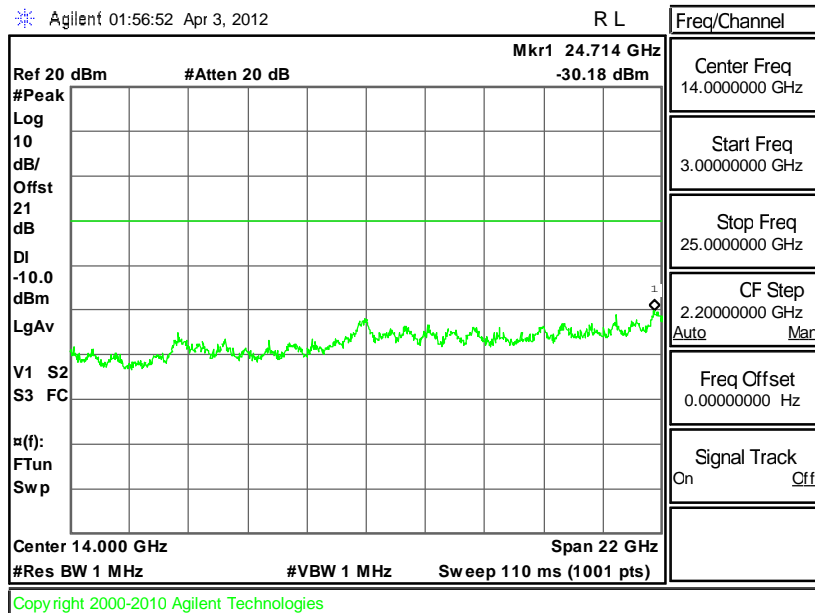



Test Mode :	Mode 4	Temperature :	24~26°C
Test Band :	802.11g	Relative Humidity :	50~53%
Test Channel :	01	Test Engineer :	Reece Li

Conducted Spurious Emission Plot between 30MHz ~ 3 GHz

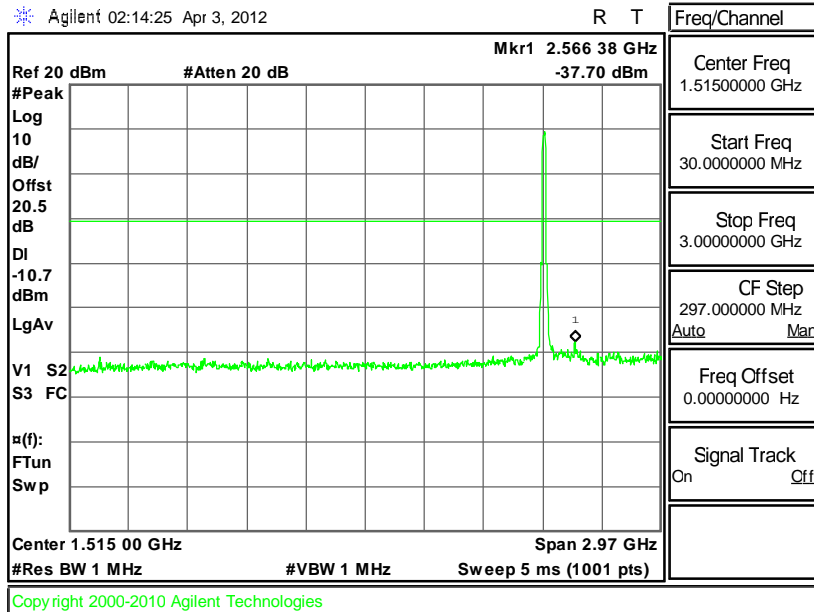

Conducted Spurious Emission Plot between 3 GHz ~ 25 GHz

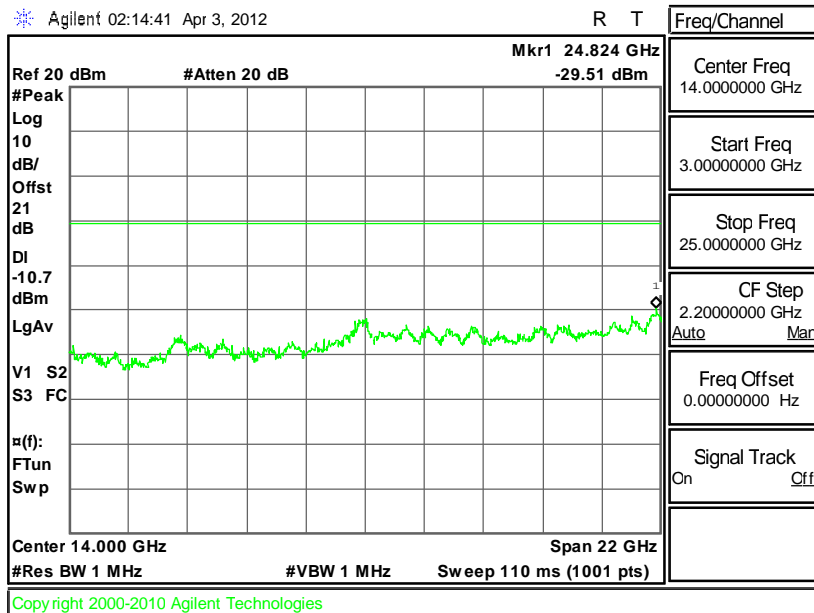



Test Mode :	Mode 5	Temperature :	24~26
Test Band :	802.11g	Relative Humidity :	50~53
Test Channel :	06	Test Engineer :	Reece Li

Conducted Spurious Emission Plot between 30MHz ~ 3 GHz

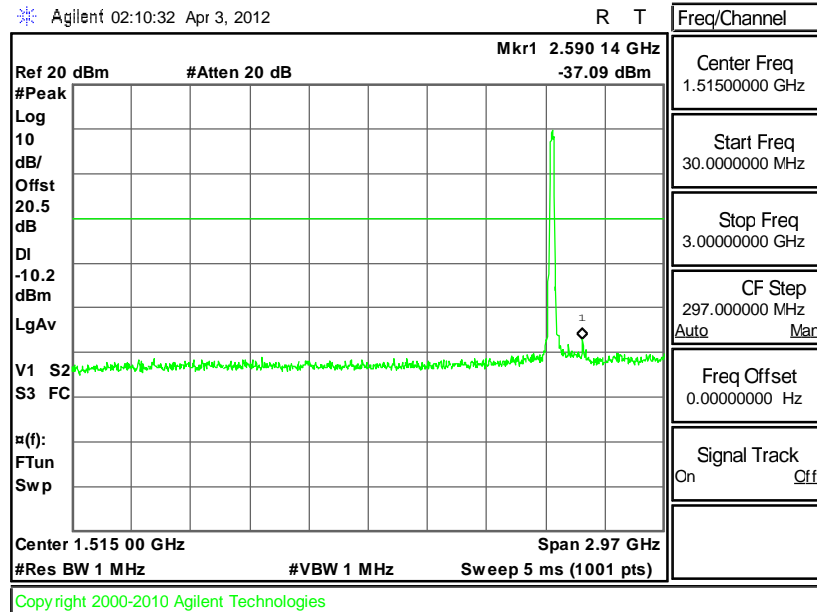

Conducted Spurious Emission Plot between 3 GHz ~ 25 GHz

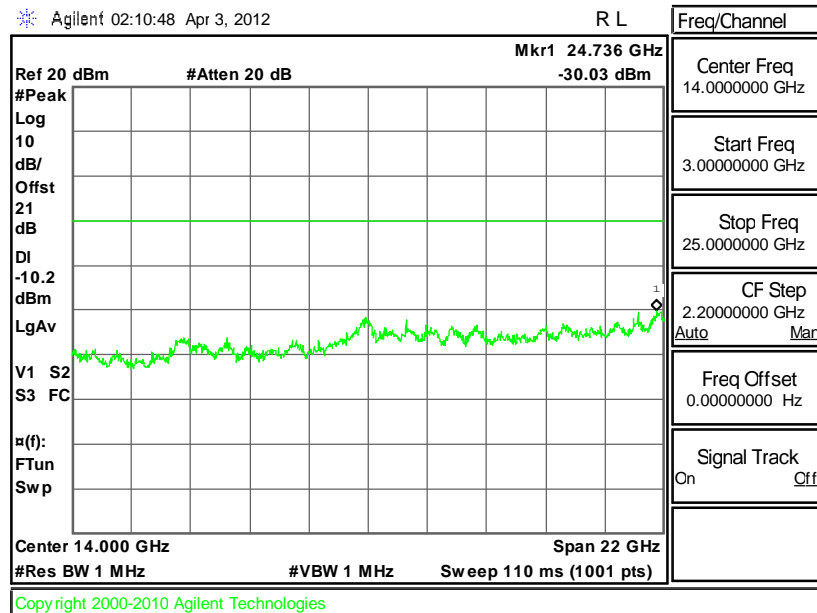



Test Mode :	Mode 6	Temperature :	24~26°C
Test Band :	802.11g	Relative Humidity :	50~53%
Test Channel :	11	Test Engineer :	Reece Li

Conducted Spurious Emission Plot between 30MHz ~ 3 GHz

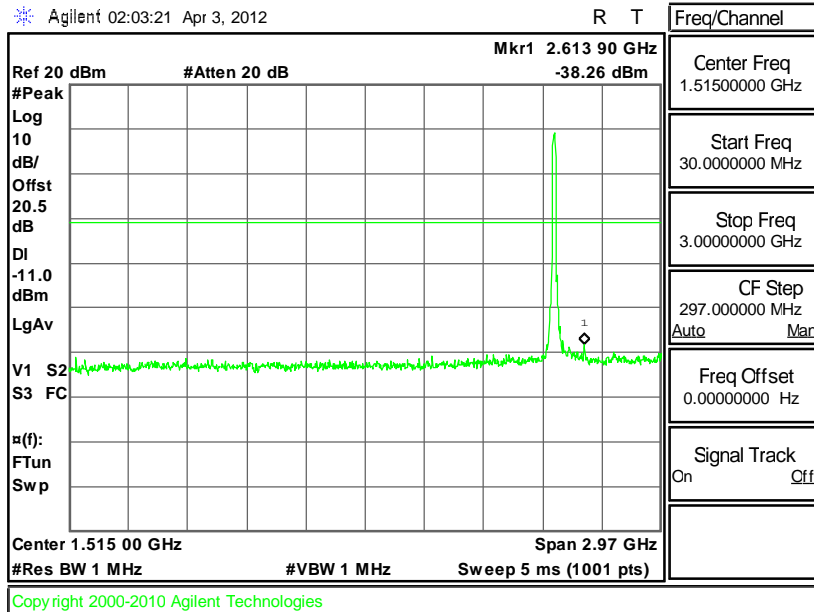

Conducted Spurious Emission Plot between 3 GHz ~ 25 GHz

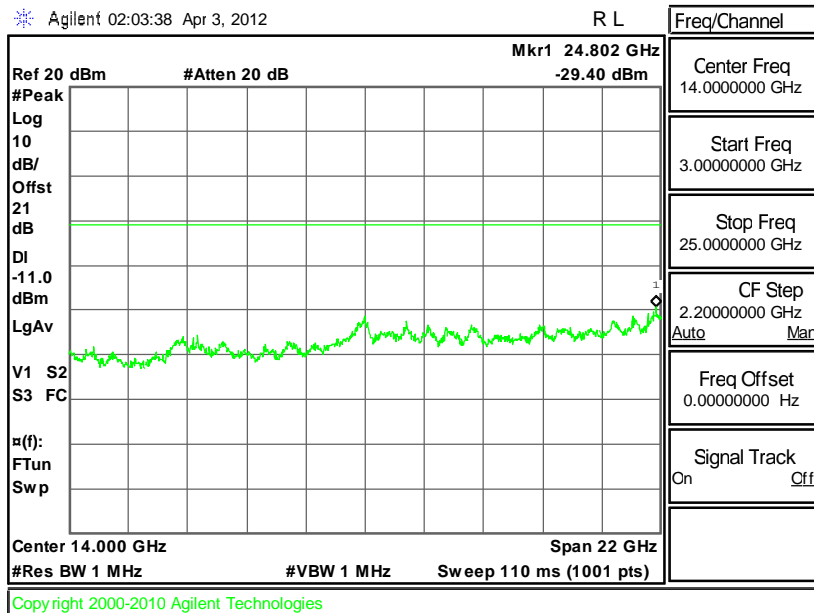



Test Mode :	Mode 7	Temperature :	24~26°C
Test Band :	802.11g/n (BW 20MHz)	Relative Humidity :	50~53%
Test Channel :	01	Test Engineer :	Reece Li

Conducted Spurious Emission Plot between 30MHz ~ 3 GHz

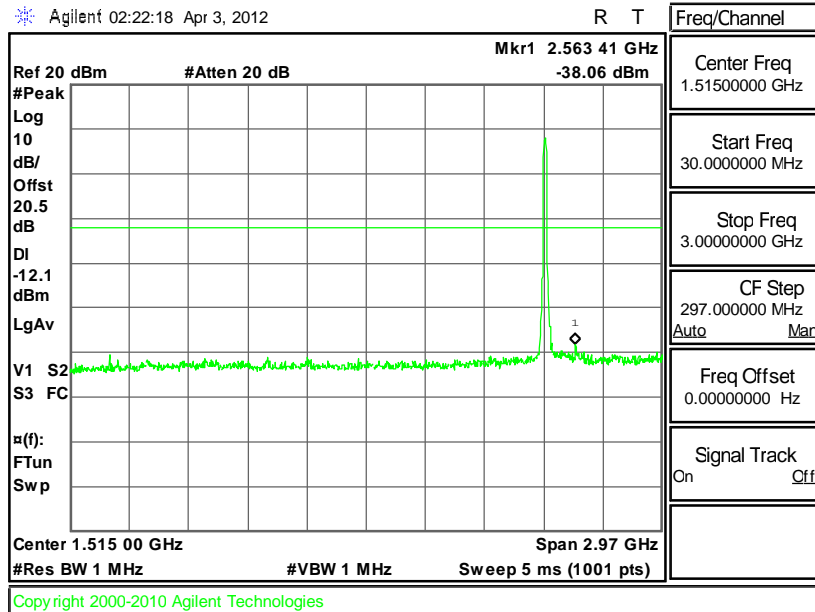

Conducted Spurious Emission Plot between 3 GHz ~ 25 GHz

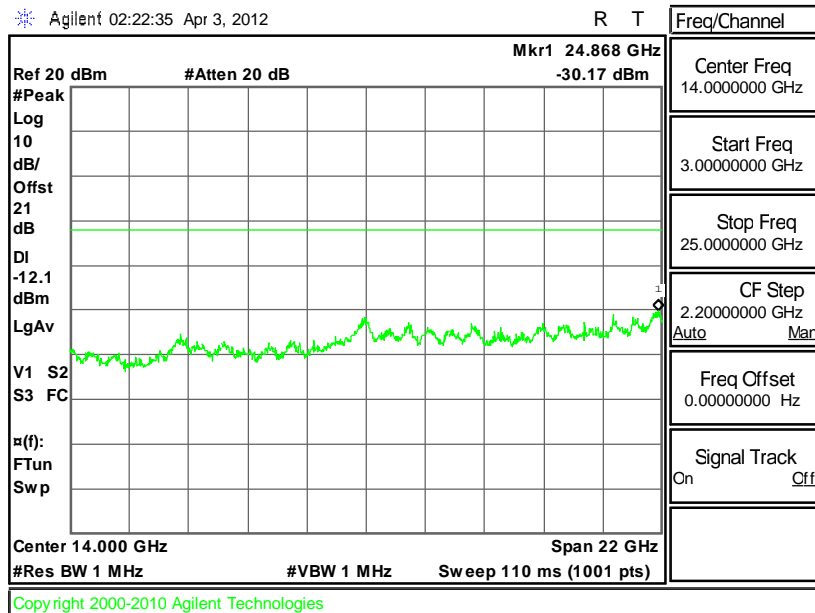



Test Mode :	Mode 8	Temperature :	24~26°C
Test Band :	802.11g/n (BW 20MHz)	Relative Humidity :	50~53%
Test Channel :	06	Test Engineer :	Reece Li

Conducted Spurious Emission Plot between 30MHz ~ 3 GHz

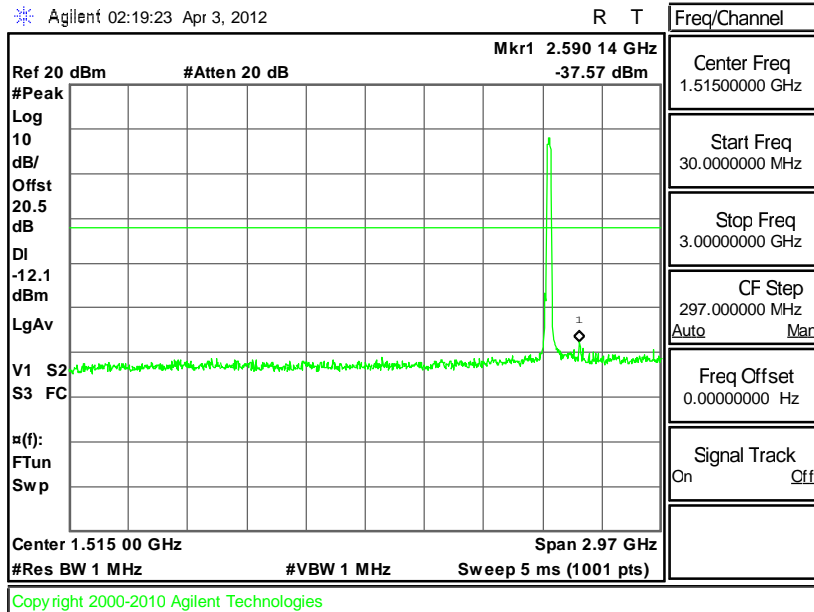

Conducted Spurious Emission Plot between 3 GHz ~ 25 GHz

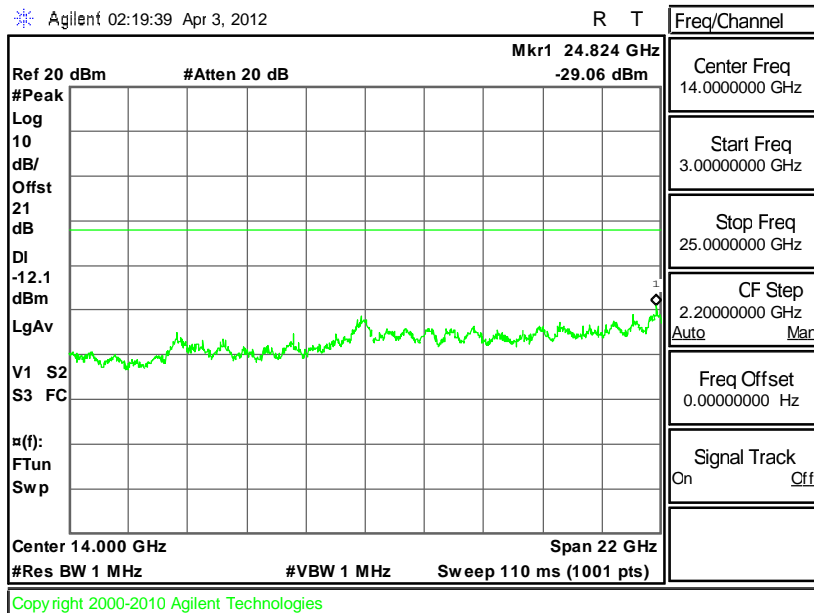



Test Mode :	Mode 9	Temperature :	24~26°C
Test Band :	802.11g/n (BW 20MHz)	Relative Humidity :	50~53%
Test Channel :	11	Test Engineer :	Reece Li

Conducted Spurious Emission Plot between 30MHz ~ 3 GHz

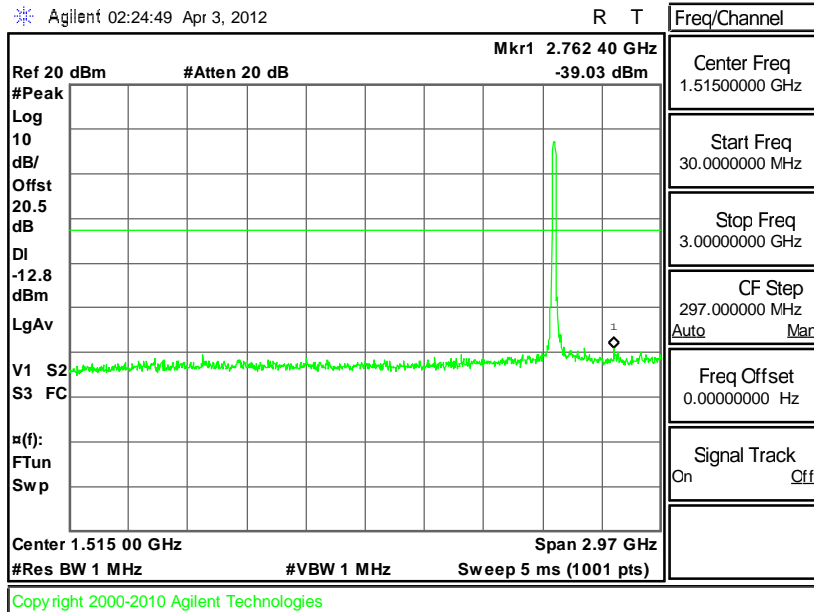

Conducted Spurious Emission Plot between 3 GHz ~ 25 GHz

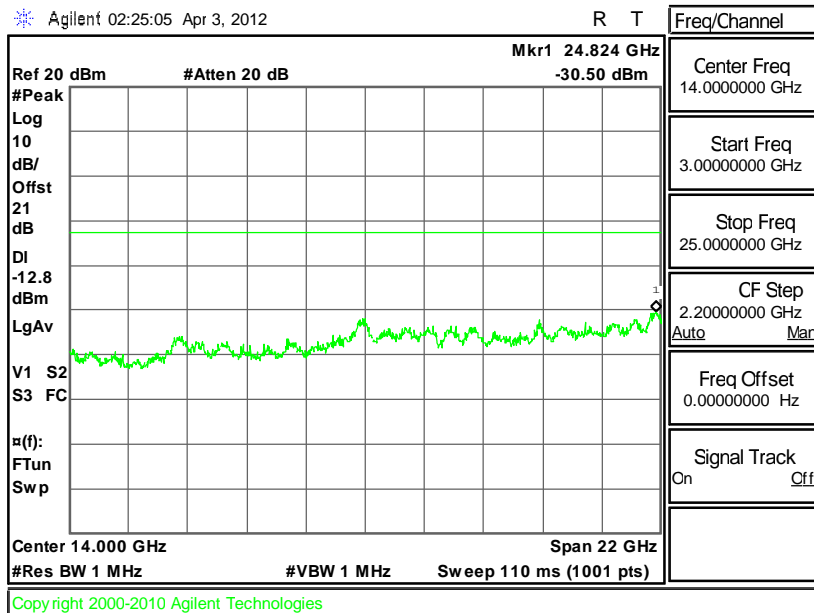

3.5 Power Spectral Density Measurement

3.5.1 Limit of Power Spectral Density

The peak power spectral density shall not be greater than 8dBm in any 3KHz band at any time interval of continuous transmission.

3.5.2 Measuring Instruments

See list of measuring instruments of this test report.

3.5.3 Test Procedures

1. The testing follows Measurement Procedure PKPSD of FCC KDB Publication No. 558074 D01 DTS Meas. Guidance v01.
2. The RF output of EUT was connected to the spectrum analyzer by a low loss cable. The path loss was compensated to the results for each measurement.
3. Record the measurement data derived from spectrum analyzer.
4. Make the measurement with the spectrum analyzer's resolution bandwidth (RBW) = 100 KHz. Video bandwidth (VBW) \geq 300 KHz In order to make an accurate measurement, set the span to 5-30% greater than Emission Bandwidth (EBW)
5. Detector = peak, Sweep time = auto couple, Trace mode = max hold, Allow trace to fully stabilize. Use the peak marker function to determine the maximum power level in any 100 kHz band segment within the fundamental EBW.
6. Scale the observed power level to an equivalent value in 3 kHz by adjusting (reducing) the measured power by a bandwidth correction factor (BWCF) where $BWCF = 10\log(3\text{ kHz}/100\text{ kHz} = -15.2\text{ dB})$.

3.5.4 Test Setup

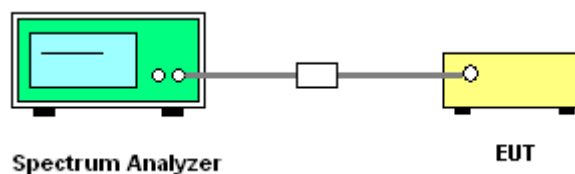



3.5.5 Test Result of Power Spectral Density

Test Mode :	Mode 1, 2, 3	Temperature :	24~26°C
Test Engineer :	Reece Li	Relative Humidity :	50~53%

Channel	Frequency (MHz)	802.11b Power Density		Max. Limits (dBm)	Pass/Fail
		Measured PSD/100KHz (dBm)	PSD/3KHz (dBm)		
01	2412	8.84	-6.36	8	Pass
06	2437	8.67	-6.53	8	Pass
11	2462	9.06	-6.14	8	Pass

Note:

1. Measured power density (dBm) has offset with cable loss.
2. BWCF (dB) = $10 \log (3k/100k) = -15.2 \text{ dB}$
3. Power Density/ 3kHz (dBm) = Measured power density/ 100KHz (dBm) + BWCF (dB)

Mode 1 : PSD Plot on 802.11b Channel 01

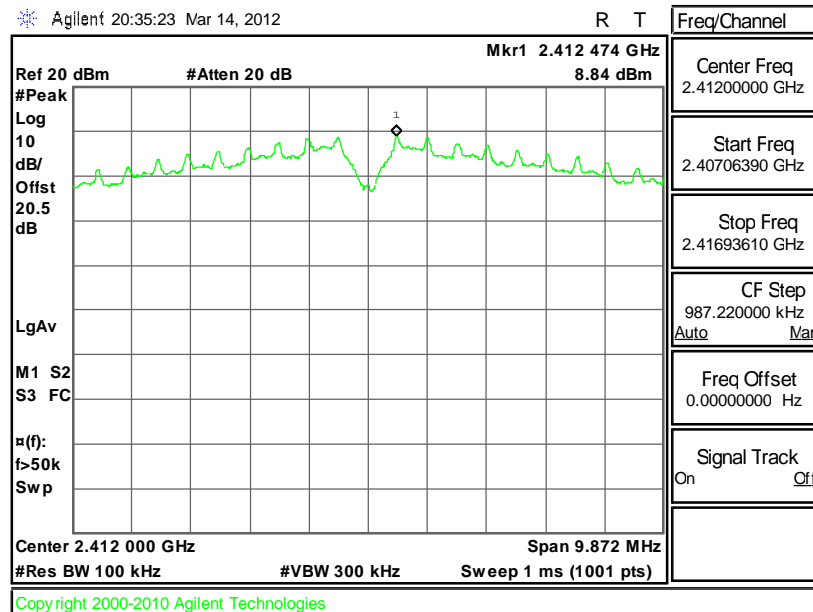



Mode 2 : PSD Plot on 802.11b Channel 06

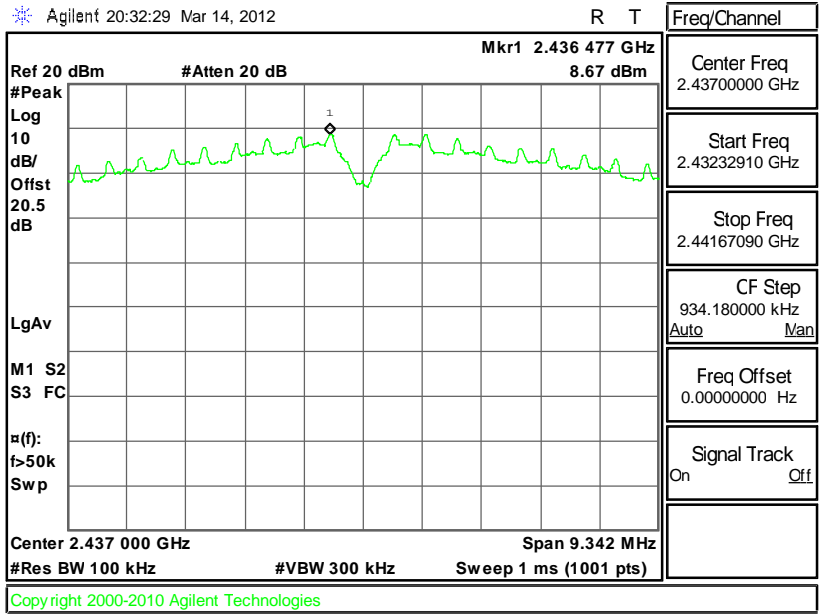

Mode 3 : PSD Plot on 802.11b Channel 11

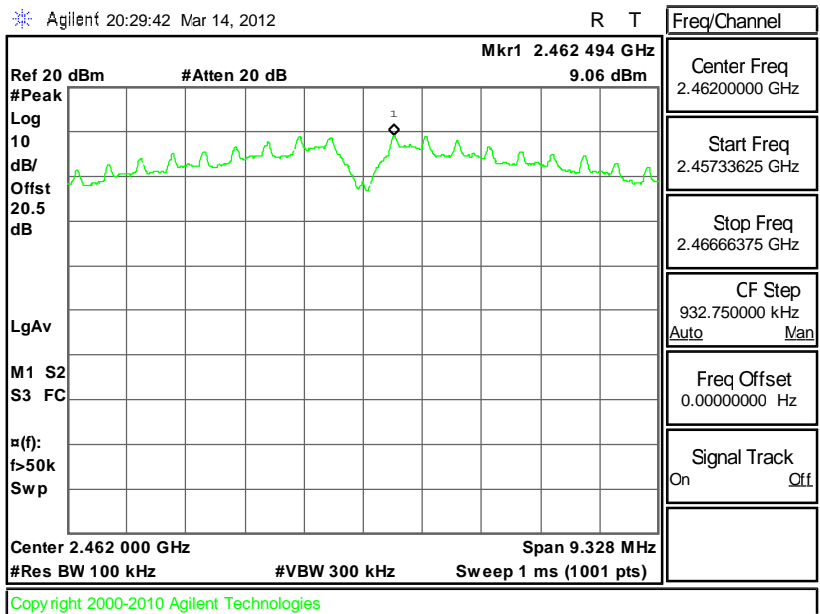



Test Mode :	Mode 4, 5, 6	Temperature :	24~26°C
Test Engineer :	Reece Li	Relative Humidity :	50~53%

Channel	Frequency (MHz)	802.11g Power Density		Max. Limits (dBm)	Pass/Fail
		Measured PSD/100KHz (dBm)	PSD/3KHz (dBm)		
01	2412	6.36	-8.84	8	Pass
06	2437	6.58	-8.62	8	Pass
11	2462	6.80	-8.40	8	Pass

Note:

1. Measured power density (dBm) has offset with cable loss.
2. BWCF (dB) = $10 \log (3k/100k) = -15.2 \text{ dB}$
3. Power Density/ 3KHz (dBm) = Measured power density/ 100KHz (dBm) + BWCF (dB)

Mode 4 : PSD Plot on 802.11g Channel 01

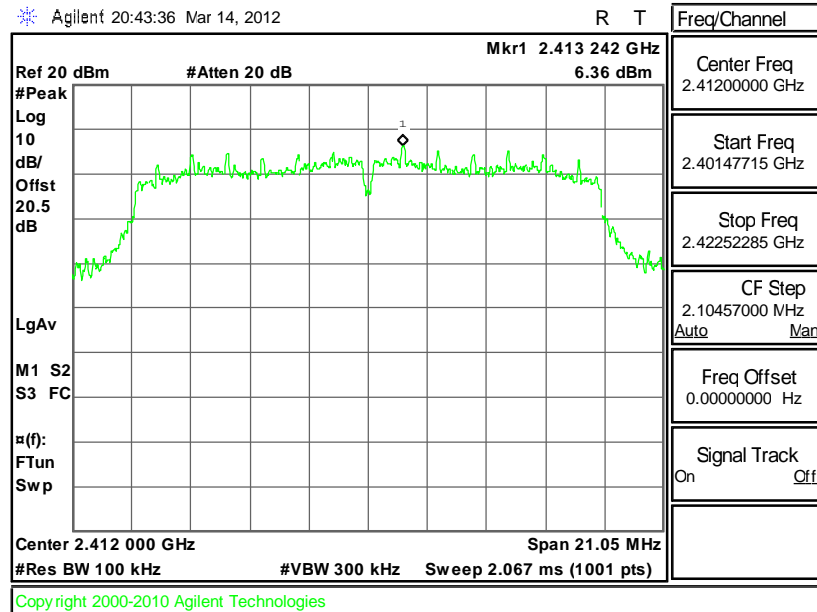



Mode 5 : PSD Plot on 802.11g Channel 06

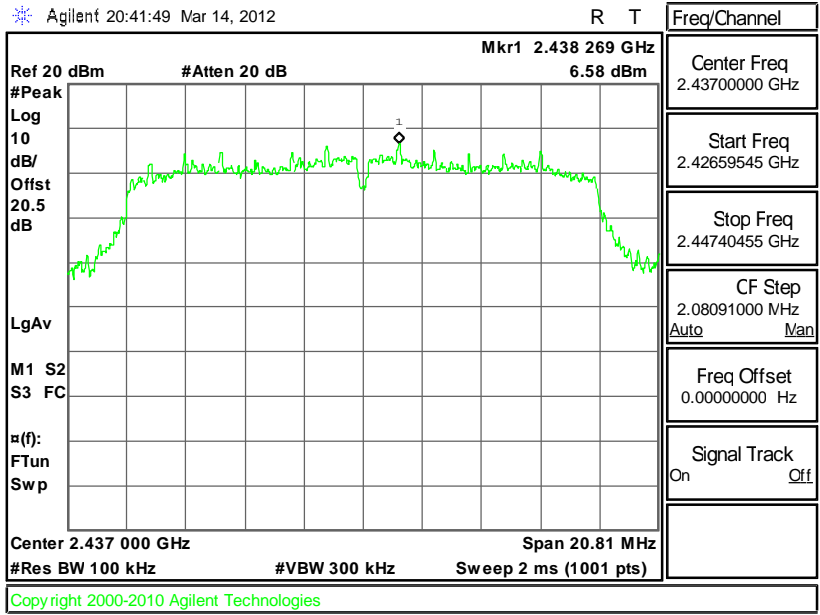

Mode 6 : PSD Plot on 802.11g Channel 11

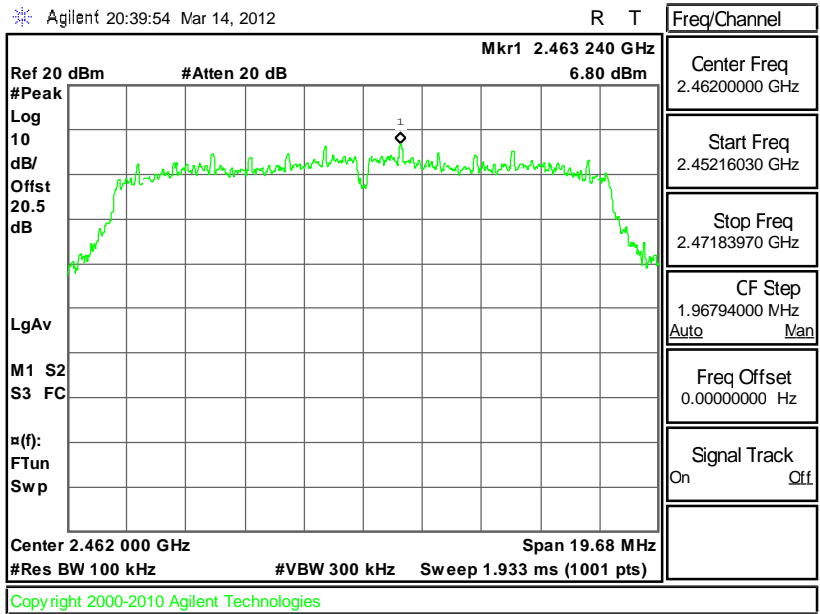



Test Mode :	Mode 7, 8, 9	Temperature :	24~26°C
Test Engineer :	Reece Li	Relative Humidity :	50~53%

Channel	Frequency (MHz)	802.11g/n (BW 20MHz) Power Density		Max. Limits (dBm)	Pass/Fail
		Measured PSD/100KHz (dBm)	PSD/3KHz (dBm)		
01	2412	3.45	-11.75	8	Pass
06	2437	2.60	-12.60	8	Pass
11	2462	3.72	-11.48	8	Pass

Note:

1. Measured power density (dBm) has offset with cable loss.
2. BWCF (dB) = $10 \log (3k/100k) = -15.2 \text{ dB}$
3. Power Density/ 3KHz (dBm) = Measured power density/ 100KHz (dBm) + BWCF (dB)

Mode 7 : PSD Plot on 802.11g/n (BW 20MHz) Channel 01

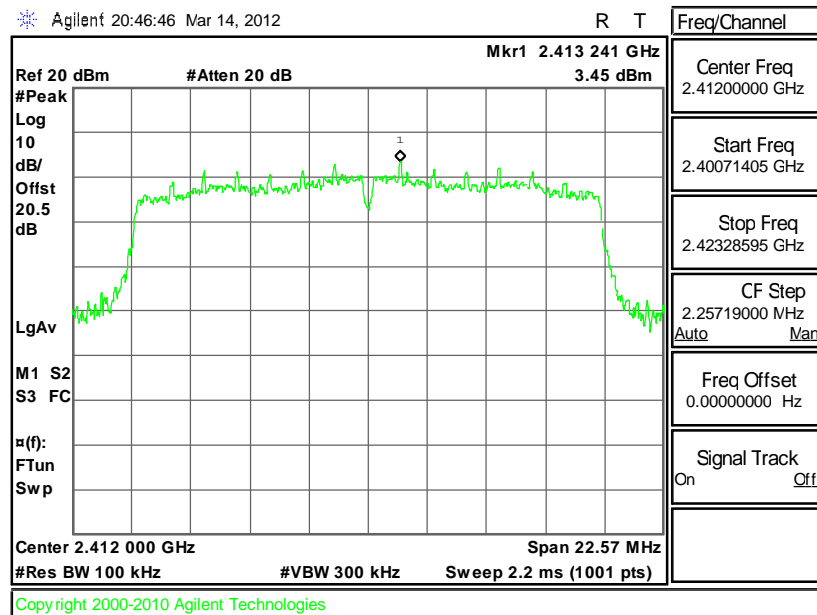



Mode 8 : PSD Plot on 802.11g/n (BW 20MHz) Channel 06

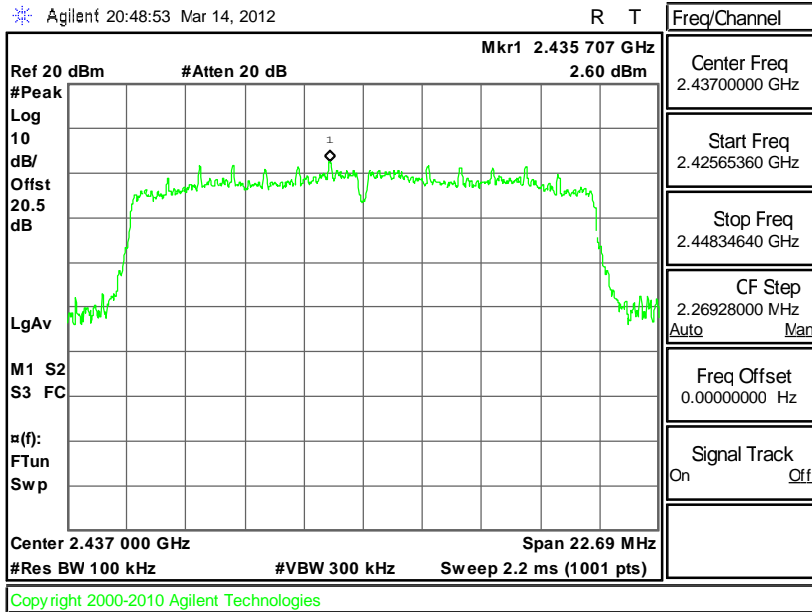

Mode 9 : PSD Plot on 802.11g/n (BW 20MHz) Channel 11

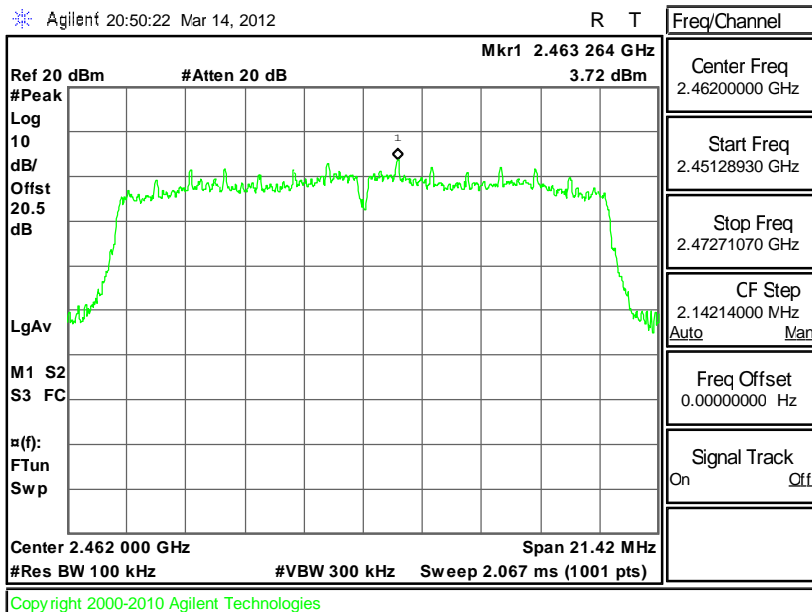

3.6 AC Conducted Emission Measurement

3.6.1 Limit of AC Conducted Emission

For equipment that is designed to be connected to the public utility (AC) power line, the radio frequency voltage that is conducted back onto the AC power line on any frequency or frequencies within the band 150 KHz to 30 MHz shall not exceed the limits in the following table.

Frequency of Emission (MHz)	Conducted Limit (dBuV)	
	Quasi-Peak	Average
0.15-0.5	66 to 56*	56 to 46*
0.5-5	56	46
5-30	60	50

*Decreases with the logarithm of the frequency.

3.6.2 Measuring Instruments

See list of measuring instruments of this test report.

3.6.3 Test Procedures

1. The testing follows the guidelines in ANSI C63.4-2003.
2. The EUT was placed 0.4 meter from the conducting wall of the shielding room, and it was kept at least 80 centimeters from any other grounded conducting surface.
3. Connect EUT to the power mains through a line impedance stabilization network (LISN).
4. All the support units are connecting to the other LISN.
5. The LISN provides 50 ohm coupling impedance for the measuring instrument.
6. The FCC states that a 50 ohm, 50 microhenry LISN should be used.
7. Both sides of AC line were checked for maximum conducted interference.
8. The frequency range from 150 KHz to 30 MHz was searched.
9. Set the test-receiver system to Peak Detect Function and specified bandwidth with Maximum Hold Mode.

3.6.4 Test Setup

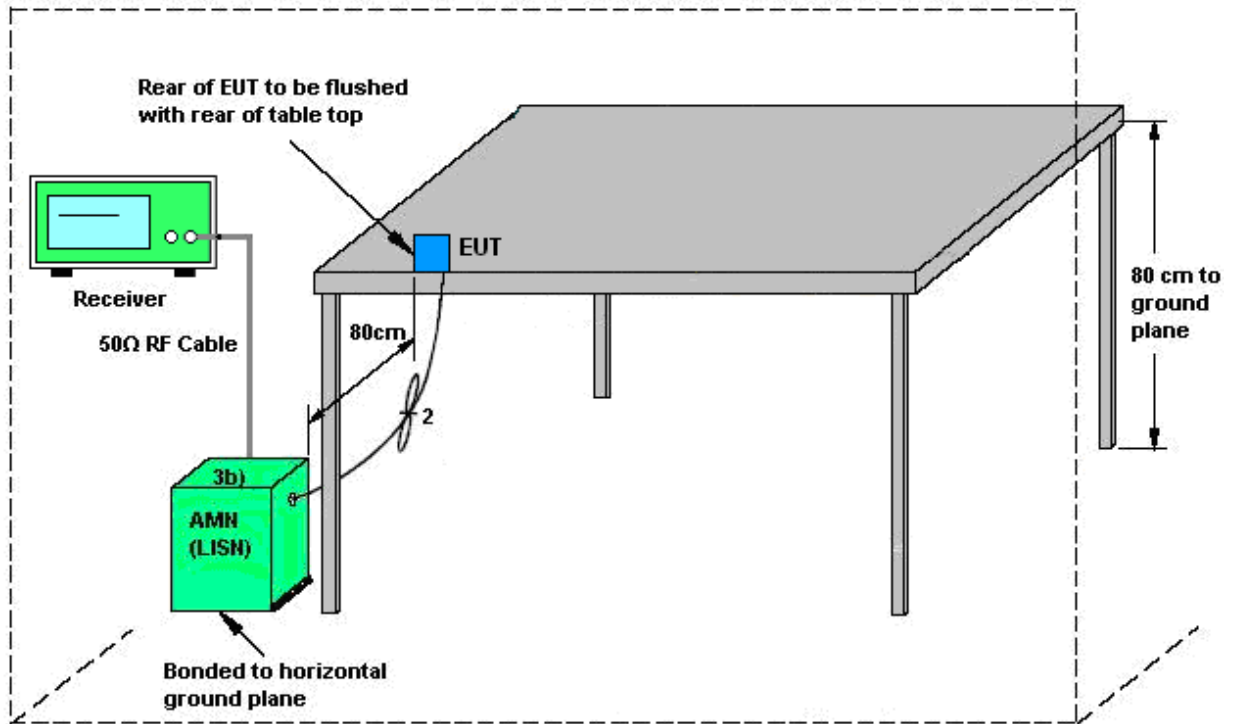

AMN = Artificial mains network (LISH)
 AE = Associated equipment
 EUT = Equipment under test
 ISN = Impedance stabilization network

3.6.5 Test Result of AC Conducted Emission

Test Mode :	Mode 1	Temperature :	20~22°C
Test Engineer :	Kai-Chun Chu	Relative Humidity :	50~52%
Test Voltage :	120Vac / 60Hz	Phase :	Line
Function Type :	WLAN Link + Bluetooth Link + GPS Rx + TC for Sample 1		
Remark :	All emissions not reported here are more than 10 dB below the prescribed limit.		

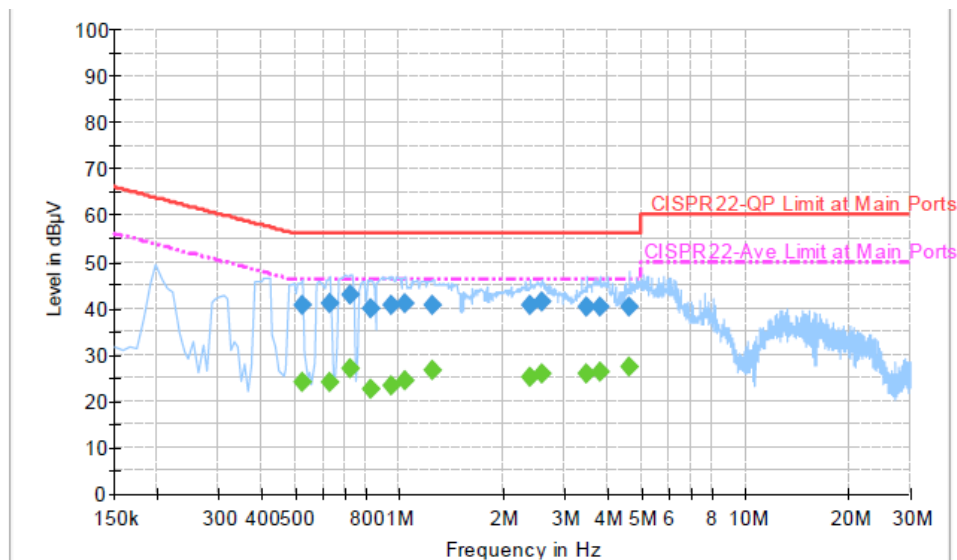

Final Result : QuasiPeak

Frequency (MHz)	QuasiPeak (dBµV)	Filter	Line	Corr. (dB)	Margin (dB)	Limit (dBµV)
0.526000	40.8	Off	L1	19.3	15.2	56.0
0.630000	40.9	Off	L1	19.4	15.1	56.0
0.726000	42.9	Off	L1	19.4	13.1	56.0
0.830000	40.0	Off	L1	19.4	16.0	56.0
0.950000	40.6	Off	L1	19.4	15.4	56.0
1.046000	40.9	Off	L1	19.4	15.1	56.0
1.254000	40.7	Off	L1	19.4	15.3	56.0
2.390000	40.8	Off	L1	19.5	15.2	56.0
2.582000	41.3	Off	L1	19.5	14.7	56.0
3.478000	40.4	Off	L1	19.5	15.6	56.0
3.798000	40.3	Off	L1	19.5	15.7	56.0
4.638000	40.3	Off	L1	19.5	15.7	56.0



Test Mode :	Mode 1	Temperature :	20~22°C
Test Engineer :	Kai-Chun Chu	Relative Humidity :	50~52%
Test Voltage :	120Vac / 60Hz	Phase :	Line
Function Type :	WLAN Link + Bluetooth Link + GPS Rx + TC for Sample 1		
Remark :	All emissions not reported here are more than 10 dB below the prescribed limit.		

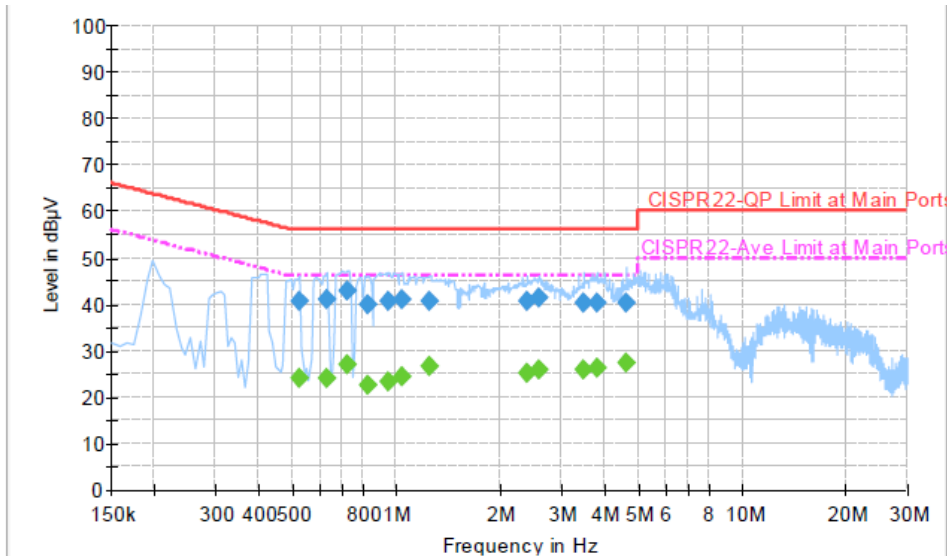

Final Result : Average

Frequency (MHz)	Average (dBµV)	Filter	Line	Corr. (dB)	Margin (dB)	Limit (dBµV)
0.526000	23.9	Off	L1	19.3	22.1	46.0
0.630000	24.0	Off	L1	19.4	22.0	46.0
0.726000	27.1	Off	L1	19.4	18.9	46.0
0.830000	22.7	Off	L1	19.4	23.3	46.0
0.950000	23.2	Off	L1	19.4	22.8	46.0
1.046000	24.3	Off	L1	19.4	21.7	46.0
1.254000	26.7	Off	L1	19.4	19.3	46.0
2.390000	25.1	Off	L1	19.5	20.9	46.0
2.582000	25.8	Off	L1	19.5	20.2	46.0
3.478000	25.7	Off	L1	19.5	20.3	46.0
3.798000	26.1	Off	L1	19.5	19.9	46.0
4.638000	27.3	Off	L1	19.5	18.7	46.0

Test Mode :	Mode 1	Temperature :	20~22°C
Test Engineer :	Kai-Chun Chu	Relative Humidity :	50~52%
Test Voltage :	120Vac / 60Hz	Phase :	Neutral
Function Type :	WLAN Link + Bluetooth Link + GPS Rx + TC for Sample 1		
Remark :	All emissions not reported here are more than 10 dB below the prescribed limit.		

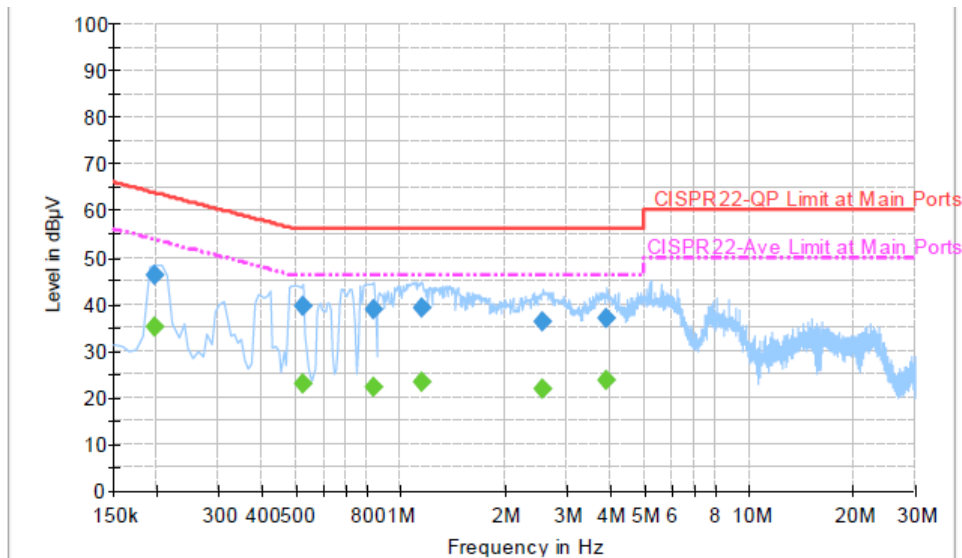

Final Result : QuasiPeak

Frequency (MHz)	QuasiPeak (dBµV)	Filter	Line	Corr. (dB)	Margin (dB)	Limit (dBµV)
0.198000	46.0	Off	N	19.3	17.7	63.7
0.526000	39.3	Off	N	19.3	16.7	56.0
0.838000	38.7	Off	N	19.5	17.3	56.0
1.158000	39.0	Off	N	19.4	17.0	56.0
2.574000	36.3	Off	N	19.5	19.7	56.0
3.918000	37.0	Off	N	19.5	19.0	56.0

Final Result : Average

Frequency (MHz)	Average (dBµV)	Filter	Line	Corr. (dB)	Margin (dB)	Limit (dBµV)
0.198000	35.0	Off	N	19.3	18.7	53.7
0.526000	22.7	Off	N	19.3	23.3	46.0
0.838000	22.1	Off	N	19.5	23.9	46.0
1.158000	23.2	Off	N	19.4	22.8	46.0
2.574000	21.6	Off	N	19.5	24.4	46.0
3.918000	23.5	Off	N	19.5	22.5	46.0

3.7 Radiated Emission Measurement

3.7.1 Limit of Radiated Emission

In any 100 KHz bandwidth outside the intentional radiator frequency band, all harmonics/spurious must be at least 20 dB below the highest emission level within the authorized band. If the output power of this device was measured by spectrum analyzer, the attenuation under this paragraph shall be 30 dB instead of 20 dB. In addition, radiated emissions which fall in the restricted bands must also comply with the FCC section 15.209 limits as below.

Frequency (MHz)	Field Strength (microvolts/meter)	Measurement Distance (meters)
0.009 – 0.490	2400/F(KHz)	300
0.490 – 1.705	24000/F(KHz)	30
1.705 – 30.0	30	30
30 – 88	100	3
88 – 216	150	3
216 - 960	200	3
Above 960	500	3

3.7.2 Measuring Instruments

See list of measuring instruments of this test report.

3.7.3 Test Procedures

1. Use the following spectrum analyzer settings:
 - (1) Span shall wide enough to fully capture the emission being measured;
 - (2) Set RBW = 1 MHz for $f \geq 1$ GHz, 100 KHz for $f < 1$ GHz; VBW \geq RBW; Sweep = auto; Detector function = peak; Trace = max hold;
 - (3) Measurement above 18 GHz shall be extrapolated to the specified distance using an extrapolation factor of 20 dB per decade from 3m to 1m.
Distance extrapolation factor = $20 \log(\text{specific distance [3m]} / \text{test distance [1m]})$ (dB)
2. Maximize the emission by rotating the EUT for three orthogonal planes, and adjusting the measurement antenna height and polarization. A pre-amp and a high pass filter are used for the test in order to get better signal level to comply with the guidelines in ANSI C63.4-2003.

3.7.4 Test Setup

For radiated emissions below 30MHz

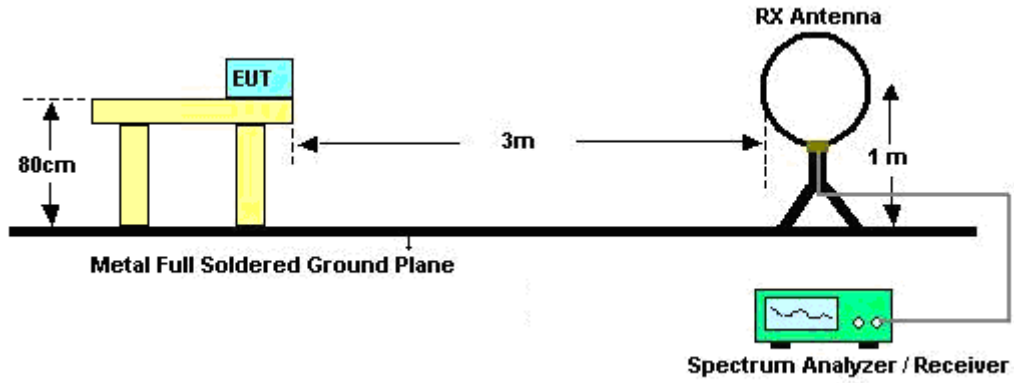

For radiated emissions from 30MHz to 1GHz

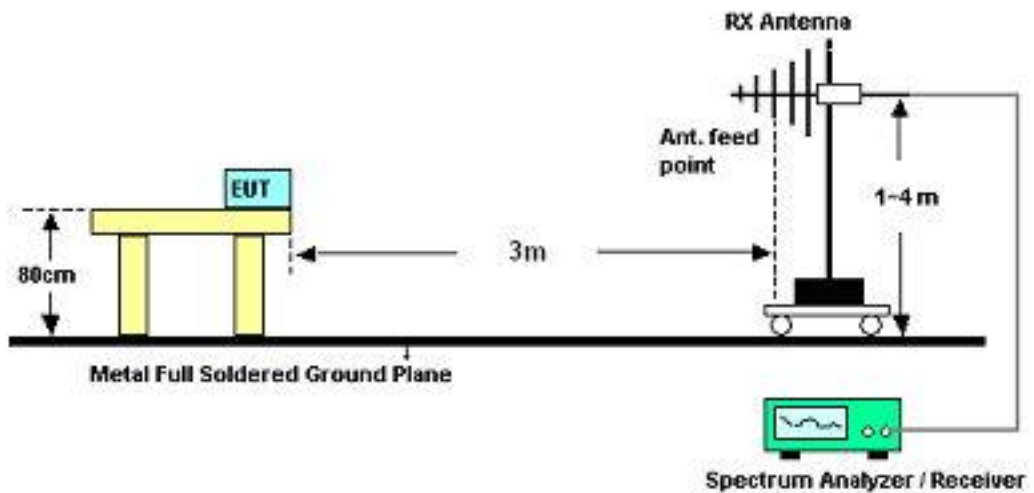

For radiated emissions above 1GHz

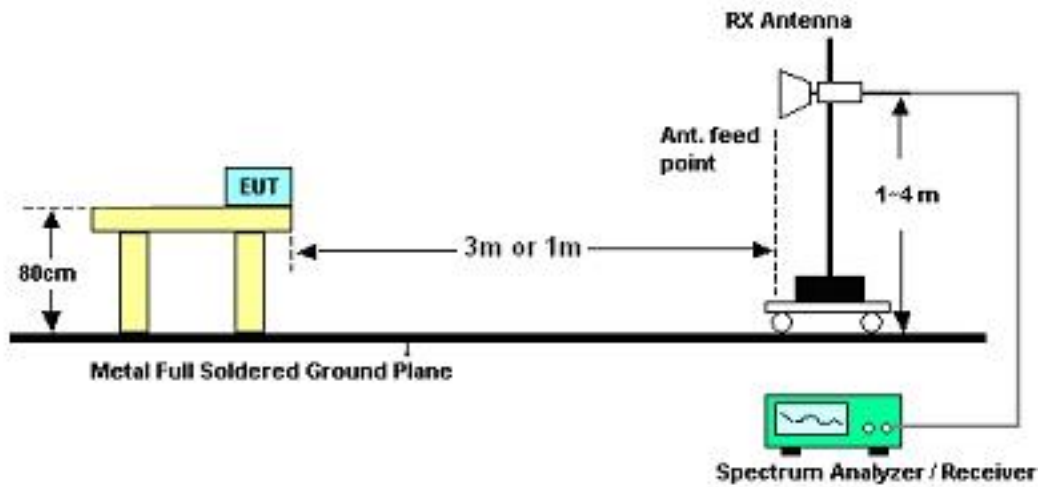

3.7.5 Test Results of Radiated Emissions (9 KHz ~ 30 MHz)

The low frequency, which started from 9 KHz to 30MHz, was pre-scanned and the result which was 20dB lower than the limit line per 15.31(o) was not reported.

3.7.6 Test Result of Radiated Emission (30 MHz ~ 10th Harmonic)

Test Mode :	Mode 1	Temperature :	23~24°C
Test Channel :	01	Relative Humidity :	44~45%
Test Engineer :	David Ke	Polarization :	Horizontal
Remark :	1. 2412 MHz is fundamental signal which can be ignored. 2. 7236 MHz and 9648 MHz are not within a restricted band, and its limit line is 20dB below the highest emission level. For example, 110.62 dBuV/m - 20dB = 90.62 dBuV/m.		

Frequency (MHz)	Level (dB μ V/m)	Over Limit (dB)	Limit Line (dB μ V/m)	Read Level (dB μ V)	Antenna Factor (dB)	Cable Loss (dB)	Preamp Factor (dB)	Ant Pos (cm)	Table Pos (deg)	Remark
30	22.27	-17.73	40	33.33	19.8	0.7	31.56	-	-	Peak
195.24	26.53	-16.97	43.5	47.75	8.8	1.45	31.47	100	88	Peak
236.28	26.22	-19.78	46	45.08	11.04	1.61	31.51	-	-	Peak
339.9	24.13	-21.87	46	39.49	14.07	1.87	31.3	-	-	Peak
502.3	22.91	-23.09	46	33.63	18.12	2.23	31.07	-	-	Peak
720.7	23.71	-22.29	46	30.03	21.64	2.69	30.65	-	-	Peak
2389.04	53.22	-0.78	54	52.5	32.02	4.58	35.88	100	46	Average
2389.04	61.02	-12.98	74	60.3	32.02	4.58	35.88	100	46	Peak
2412	105.74	-	-	104.98	32.03	4.59	35.86	100	46	Average
2412	110.62	-	-	109.86	32.03	4.59	35.86	100	46	Peak
2492	41.11	-12.89	54	40.17	32.1	4.64	35.8	100	46	Average
2492	51.63	-22.37	74	50.69	32.1	4.64	35.8	100	46	Peak
7236	44.69	-45.93	90.62	58.46	35.6	8.29	57.66	100	0	Peak
9648	46.49	-44.13	90.62	56.95	36.62	9.48	56.56	100	0	Peak



Test Mode :	Mode 1	Temperature :	23~24°C
Test Channel :	01	Relative Humidity :	44~45%
Test Engineer :	David Ke	Polarization :	Vertical
Remark :	1. 2412 MHz is fundamental signal which can be ignored. 2. 7236 MHz and 9648 MHz are not within the restricted bands.		

Frequency (MHz)	Level (dBμV/m)	Over Limit (dB)	Limit Line (dBμV/m)	Read Level (dBμV)	Antenna Factor (dB)	Cable Loss (dB)	Preamp Factor (dB)	Ant Pos (cm)	Table Pos (deg)	Remark
34.86	31.49	-8.51	40	45.87	16.4	0.74	31.52	100	149	Peak
86.16	25.02	-14.98	40	47.3	8.22	1.05	31.55	-	-	Peak
120.45	28.89	-14.61	43.5	47.4	11.8	1.21	31.52	-	-	Peak
300.7	22.86	-23.14	46	38.96	13.39	1.78	31.27	-	-	Peak
561.1	25.28	-20.72	46	33.63	20.23	2.35	30.93	-	-	Peak
715.1	24.31	-21.69	46	31	21.3	2.68	30.67	-	-	Peak
2389.42	49.48	-4.52	54	48.76	32.02	4.58	35.88	125	246	Average
2389.42	57.64	-16.36	74	56.92	32.02	4.58	35.88	125	246	Peak
2412	101.38	-	-	100.62	32.03	4.59	35.86	125	246	Average
2412	106.48	-	-	105.72	32.03	4.59	35.86	125	246	Peak
2488	37.54	-16.46	54	36.61	32.1	4.64	35.81	125	246	Average
2488	49.1	-24.9	74	48.17	32.1	4.64	35.81	125	246	Peak
7236	46.15	-40.33	86.48	59.92	35.6	8.29	57.66	100	0	Peak
9648	49.3	-37.18	86.48	59.76	36.62	9.48	56.56	100	0	Peak



Test Mode :	Mode 2	Temperature :	23~24°C
Test Channel :	06	Relative Humidity :	44~45%
Test Engineer :	David Ke	Polarization :	Horizontal
Remark :	2437 MHz is fundamental signal which can be ignored.		

Frequency (MHz)	Level (dBμV/m)	Over Limit (dB)	Limit Line (dBμV/m)	Read Level (dBμV)	Antenna Factor (dB)	Cable Loss (dB)	Preamp Factor (dB)	Ant Pos (cm)	Table Pos (deg)	Remark
2370	41.9	-12.1	54	41.21	32	4.57	35.88	100	45	Average
2370	52.17	-21.83	74	51.48	32	4.57	35.88	100	45	Peak
2437	104.44	-	-	103.61	32.06	4.61	35.84	100	45	Average
2437	109.16	-	-	108.33	32.06	4.61	35.84	100	45	Peak
2484	41.18	-12.82	54	40.26	32.09	4.64	35.81	100	45	Average
2484	53.96	-20.04	74	53.04	32.09	4.64	35.81	100	45	Peak
7311	46.01	-27.99	74	59.69	35.6	8.42	57.7	100	0	Peak

Test Mode :	Mode 2	Temperature :	23~24°C
Test Channel :	06	Relative Humidity :	44~45%
Test Engineer :	David Ke	Polarization :	Vertical
Remark :	1. 2437 MHz is fundamental signal which can be ignored. 2. 9748 MHz is not within a restricted band.		

Frequency (MHz)	Level (dBμV/m)	Over Limit (dB)	Limit Line (dBμV/m)	Read Level (dBμV)	Antenna Factor (dB)	Cable Loss (dB)	Preamp Factor (dB)	Ant Pos (cm)	Table Pos (deg)	Remark
2390	39.38	-14.62	54	38.64	32.02	4.58	35.86	113	74	Average
2390	50.48	-23.52	74	49.74	32.02	4.58	35.86	113	74	Peak
2437	101.62	-	-	100.79	32.06	4.61	35.84	113	74	Average
2437	106.3	-	-	105.47	32.06	4.61	35.84	113	74	Peak
2498	39.96	-14.04	54	39.02	32.1	4.64	35.8	113	74	Average
2498	50.88	-23.12	74	49.94	32.1	4.64	35.8	113	74	Peak
7311	46.58	-27.42	74	60.26	35.6	8.42	57.7	100	0	Peak
9748	48.4	-37.9	86.3	58.59	36.76	9.49	56.44	100	0	Peak



Test Mode :	Mode 3	Temperature :	23~24°C
Test Channel :	11	Relative Humidity :	44~45%
Test Engineer :	David Ke	Polarization :	Horizontal
Remark :	1. 2462 MHz is fundamental signal which can be ignored. 2. 9848 MHz is not within a restricted band.		

Frequency (MHz)	Level (dBμV/m)	Over Limit (dB)	Limit Line (dBμV/m)	Read Level (dBμV)	Antenna Factor (dB)	Cable Loss (dB)	Preamp Factor (dB)	Ant Pos (cm)	Table Pos (deg)	Remark
2384	40.1	-13.9	54	39.4	32	4.58	35.88	100	52	Average
2384	51.55	-22.45	74	50.85	32	4.58	35.88	100	52	Peak
2462	103.68	-	-	102.82	32.07	4.62	35.83	100	52	Average
2462	108.71	-	-	107.85	32.07	4.62	35.83	100	52	Peak
2493.16	47.27	-6.73	54	46.33	32.1	4.64	35.8	100	52	Average
2493.16	57.56	-16.44	74	56.62	32.1	4.64	35.8	100	52	Peak
7386	45.29	-28.71	74	58.9	35.6	8.55	57.76	100	0	Peak
9848	47.09	-41.62	88.71	57.04	36.88	9.51	56.34	100	0	Peak

Test Mode :	Mode 3	Temperature :	23~24°C
Test Channel :	11	Relative Humidity :	44~45%
Test Engineer :	David Ke	Polarization :	Vertical
Remark :	1. 2462 MHz is fundamental signal which can be ignored. 2. 9848 MHz is not within a restricted band.		

Frequency (MHz)	Level (dBμV/m)	Over Limit (dB)	Limit Line (dBμV/m)	Read Level (dBμV)	Antenna Factor (dB)	Cable Loss (dB)	Preamp Factor (dB)	Ant Pos (cm)	Table Pos (deg)	Remark
2386	37.5	-16.5	54	36.78	32.02	4.58	35.88	132	73	Average
2386	48.22	-25.78	74	47.5	32.02	4.58	35.88	132	73	Peak
2462	100.23	-	-	99.37	32.07	4.62	35.83	132	73	Average
2462	105.17	-	-	104.31	32.07	4.62	35.83	132	73	Peak
2488.6	44.65	-9.35	54	43.72	32.1	4.64	35.81	132	73	Average
2488.6	55.1	-18.9	74	54.17	32.1	4.64	35.81	132	73	Peak
7386	46.39	-27.61	74	60	35.6	8.55	57.76	100	0	Peak
9848	47.67	-37.5	85.17	57.62	36.88	9.51	56.34	100	0	Peak



Test Mode :	Mode 4	Temperature :	23~24°C
Test Channel :	01	Relative Humidity :	44~45%
Test Engineer :	David Ke	Polarization :	Horizontal
Remark :	2412 MHz is fundamental signal which can be ignored.		

Frequency (MHz)	Level (dBµV/m)	Over Limit (dB)	Limit Line (dBµV/m)	Read Level (dBµV)	Antenna Factor (dB)	Cable Loss (dB)	Preamp Factor (dB)	Ant Pos (cm)	Table Pos (deg)	Remark
2389.99	48.85	-5.15	54	48.11	32.02	4.58	35.86	100	43	Average
2389.99	71.17	-2.83	74	70.43	32.02	4.58	35.86	100	43	Peak
2412	92	-	-	91.24	32.03	4.59	35.86	100	43	Average
2412	109.49	-	-	108.73	32.03	4.59	35.86	100	43	Peak
2496	38.5	-15.5	54	37.56	32.1	4.64	35.8	100	43	Average
2496	51.86	-22.14	74	50.92	32.1	4.64	35.8	100	43	Peak

Test Mode :	Mode 4	Temperature :	23~24°C
Test Channel :	01	Relative Humidity :	44~45%
Test Engineer :	David Ke	Polarization :	Vertical
Remark :	2412 MHz is fundamental signal which can be ignored.		

Frequency (MHz)	Level (dBµV/m)	Over Limit (dB)	Limit Line (dBµV/m)	Read Level (dBµV)	Antenna Factor (dB)	Cable Loss (dB)	Preamp Factor (dB)	Ant Pos (cm)	Table Pos (deg)	Remark
2389.04	44.9	-9.1	54	44.18	32.02	4.58	35.88	150	252	Average
2389.04	66.23	-7.77	74	65.51	32.02	4.58	35.88	150	252	Peak
2412	88.99	-	-	88.23	32.03	4.59	35.86	150	252	Average
2412	105.96	-	-	105.2	32.03	4.59	35.86	150	252	Peak
2492	36.09	-17.91	54	35.15	32.1	4.64	35.8	150	252	Average
2492	47.82	-26.18	74	46.88	32.1	4.64	35.8	150	252	Peak



Test Mode :	Mode 5	Temperature :	23~24°C
Test Channel :	06	Relative Humidity :	44~45%
Test Engineer :	David Ke	Polarization :	Horizontal
Remark :	2437 MHz is fundamental signal which can be ignored.		

Frequency (MHz)	Level (dBµV/m)	Over Limit (dB)	Limit Line (dBµV/m)	Read Level (dBµV)	Antenna Factor (dB)	Cable Loss (dB)	Preamp Factor (dB)	Ant Pos (cm)	Table Pos (deg)	Remark
2386	40.59	-13.41	54	39.87	32.02	4.58	35.88	100	45	Average
2386	56.42	-17.58	74	55.7	32.02	4.58	35.88	100	45	Peak
2437	91.06	-	-	90.23	32.06	4.61	35.84	100	45	Average
2437	108.02	-	-	107.19	32.06	4.61	35.84	100	45	Peak
2484	41.14	-12.86	54	40.22	32.09	4.64	35.81	100	45	Average
2484	54.77	-19.23	74	53.85	32.09	4.64	35.81	100	45	Peak

Test Mode :	Mode 5	Temperature :	23~24°C
Test Channel :	06	Relative Humidity :	44~45%
Test Engineer :	David Ke	Polarization :	Vertical
Remark :	2437 MHz is fundamental signal which can be ignored.		

Frequency (MHz)	Level (dBµV/m)	Over Limit (dB)	Limit Line (dBµV/m)	Read Level (dBµV)	Antenna Factor (dB)	Cable Loss (dB)	Preamp Factor (dB)	Ant Pos (cm)	Table Pos (deg)	Remark
2390	40.61	-13.39	54	39.87	32.02	4.58	35.86	136	81	Average
2390	49.06	-24.94	74	48.32	32.02	4.58	35.86	136	81	Peak
2437	89.33	-	-	88.5	32.06	4.61	35.84	136	81	Average
2437	106.13	-	-	105.3	32.06	4.61	35.84	136	81	Peak
2498	41.17	-12.83	54	40.23	32.1	4.64	35.8	136	81	Average
2498	51.6	-22.4	74	50.66	32.1	4.64	35.8	136	81	Peak



Test Mode :	Mode 6	Temperature :	23~24°C
Test Channel :	11	Relative Humidity :	44~45%
Test Engineer :	David Ke	Polarization :	Horizontal
Remark :	2462 MHz is fundamental signal which can be ignored.		

Frequency (MHz)	Level (dBμV/m)	Over Limit (dB)	Limit Line (dBμV/m)	Read Level (dBμV)	Antenna Factor (dB)	Cable Loss (dB)	Preamp Factor (dB)	Ant Pos (cm)	Table Pos (deg)	Remark
2390	37.82	-16.18	54	37.08	32.02	4.58	35.86	100	52	Average
2390	50.93	-23.07	74	50.19	32.02	4.58	35.86	100	52	Peak
2462	90.26	-	-	89.4	32.07	4.62	35.83	100	52	Average
2462	107.04	-	-	106.18	32.07	4.62	35.83	100	52	Peak
2483.5	46.3	-7.7	54	45.38	32.09	4.64	35.81	100	52	Average
2483.5	68.82	-5.18	74	67.9	32.09	4.64	35.81	100	52	Peak

Test Mode :	Mode 6	Temperature :	23~24°C
Test Channel :	11	Relative Humidity :	44~45%
Test Engineer :	David Ke	Polarization :	Vertical
Remark :	2462 MHz is fundamental signal which can be ignored.		

Frequency (MHz)	Level (dBμV/m)	Over Limit (dB)	Limit Line (dBμV/m)	Read Level (dBμV)	Antenna Factor (dB)	Cable Loss (dB)	Preamp Factor (dB)	Ant Pos (cm)	Table Pos (deg)	Remark
2390	35.86	-18.14	54	35.12	32.02	4.58	35.86	185	80	Average
2390	48.31	-25.69	74	47.57	32.02	4.58	35.86	185	80	Peak
2462	86.98	-	-	86.12	32.07	4.62	35.83	185	80	Average
2462	104.24	-	-	103.38	32.07	4.62	35.83	185	80	Peak
2484.04	42.94	-11.06	54	42.02	32.09	4.64	35.81	185	80	Average
2484.04	65.11	-8.89	74	64.19	32.09	4.64	35.81	185	80	Peak



Test Mode :	Mode 7	Temperature :	23~24°C
Test Channel :	01	Relative Humidity :	44~45%
Test Engineer :	David Ke	Polarization :	Horizontal
Remark :	2412 MHz is fundamental signal which can be ignored.		

Frequency (MHz)	Level (dBµV/m)	Over Limit (dB)	Limit Line (dBµV/m)	Read Level (dBµV)	Antenna Factor (dB)	Cable Loss (dB)	Preamp Factor (dB)	Ant Pos (cm)	Table Pos (deg)	Remark
2389.61	47.98	-6.02	54	47.26	32.02	4.58	35.88	100	45	Average
2389.61	70.53	-3.47	74	69.81	32.02	4.58	35.88	100	45	Peak
2412	90.45	-	-	89.69	32.03	4.59	35.86	100	45	Average
2412	109.16	-	-	108.4	32.03	4.59	35.86	100	45	Peak
2492	38.51	-15.49	54	37.57	32.1	4.64	35.8	100	45	Average
2492	52.11	-21.89	74	51.17	32.1	4.64	35.8	100	45	Peak

Test Mode :	Mode 7	Temperature :	23~24°C
Test Channel :	01	Relative Humidity :	44~45%
Test Engineer :	David Ke	Polarization :	Vertical
Remark :	2412 MHz is fundamental signal which can be ignored.		

Frequency (MHz)	Level (dBµV/m)	Over Limit (dB)	Limit Line (dBµV/m)	Read Level (dBµV)	Antenna Factor (dB)	Cable Loss (dB)	Preamp Factor (dB)	Ant Pos (cm)	Table Pos (deg)	Remark
2389.8	45.93	-8.07	54	45.19	32.02	4.58	35.86	125	247	Average
2389.8	66.77	-7.23	74	66.03	32.02	4.58	35.86	125	247	Peak
2412	86.76	-	-	86	32.03	4.59	35.86	125	247	Average
2412	104.31	-	-	103.55	32.03	4.59	35.86	125	247	Peak
2484	35.86	-18.14	54	34.94	32.09	4.64	35.81	125	247	Average
2484	46.76	-27.24	74	45.84	32.09	4.64	35.81	125	247	Peak



Test Mode :	Mode 8	Temperature :	23~24°C
Test Channel :	06	Relative Humidity :	44~45%
Test Engineer :	David Ke	Polarization :	Horizontal
Remark :	2437 MHz is fundamental signal which can be ignored.		

Frequency (MHz)	Level (dBμV/m)	Over Limit (dB)	Limit Line (dBμV/m)	Read Level (dBμV)	Antenna Factor (dB)	Cable Loss (dB)	Preamp Factor (dB)	Ant Pos (cm)	Table Pos (deg)	Remark
2390	40.01	-13.99	54	39.27	32.02	4.58	35.86	100	44	Average
2390	53.45	-20.55	74	52.71	32.02	4.58	35.86	100	44	Peak
2437	89.53	-	-	88.7	32.06	4.61	35.84	100	44	Average
2437	106.54	-	-	105.71	32.06	4.61	35.84	100	44	Peak
2484	40.42	-13.58	54	39.5	32.09	4.64	35.81	100	44	Average
2484	54.98	-19.02	74	54.06	32.09	4.64	35.81	100	44	Peak

Test Mode :	Mode 8	Temperature :	23~24°C
Test Channel :	06	Relative Humidity :	44~45%
Test Engineer :	David Ke	Polarization :	Vertical
Remark :	2437 MHz is fundamental signal which can be ignored.		

Frequency (MHz)	Level (dBμV/m)	Over Limit (dB)	Limit Line (dBμV/m)	Read Level (dBμV)	Antenna Factor (dB)	Cable Loss (dB)	Preamp Factor (dB)	Ant Pos (cm)	Table Pos (deg)	Remark
2388	37.61	-16.39	54	36.89	32.02	4.58	35.88	133	72	Average
2388	52.97	-21.03	74	52.25	32.02	4.58	35.88	133	72	Peak
2437	86.51	-	-	85.68	32.06	4.61	35.84	133	72	Average
2437	103.4	-	-	102.57	32.06	4.61	35.84	133	72	Peak
2494	37.85	-16.15	54	36.91	32.1	4.64	35.8	133	72	Average
2494	49.82	-24.18	74	48.88	32.1	4.64	35.8	133	72	Peak



Test Mode :	Mode 9	Temperature :	23~24°C
Test Channel :	11	Relative Humidity :	44~45%
Test Engineer :	David Ke	Polarization :	Horizontal
Remark :	2462 MHz is fundamental signal which can be ignored.		

Frequency (MHz)	Level (dBμV/m)	Over Limit (dB)	Limit Line (dBμV/m)	Read Level (dBμV)	Antenna Factor (dB)	Cable Loss (dB)	Preamp Factor (dB)	Ant Pos (cm)	Table Pos (deg)	Remark
2390	37.72	-16.28	54	36.98	32.02	4.58	35.86	100	53	Average
2390	50.79	-23.21	74	50.05	32.02	4.58	35.86	100	53	Peak
2462	88.54	-	-	87.68	32.07	4.62	35.83	100	53	Average
2462	105.87	-	-	105.01	32.07	4.62	35.83	100	53	Peak
2483.66	45.12	-8.88	54	44.2	32.09	4.64	35.81	100	53	Average
2483.66	67.54	-6.46	74	66.62	32.09	4.64	35.81	100	53	Peak

Test Mode :	Mode 9	Temperature :	23~24°C
Test Channel :	11	Relative Humidity :	44~45%
Test Engineer :	David Ke	Polarization :	Vertical
Remark :	2462 MHz is fundamental signal which can be ignored.		

Frequency (MHz)	Level (dBμV/m)	Over Limit (dB)	Limit Line (dBμV/m)	Read Level (dBμV)	Antenna Factor (dB)	Cable Loss (dB)	Preamp Factor (dB)	Ant Pos (cm)	Table Pos (deg)	Remark
2380	35.91	-18.09	54	35.21	32	4.58	35.88	131	72	Average
2380	47.05	-26.95	74	46.35	32	4.58	35.88	131	72	Peak
2462	85.23	-	-	84.37	32.07	4.62	35.83	131	72	Average
2462	102.1	-	-	101.24	32.07	4.62	35.83	131	72	Peak
2483.85	43.57	-10.43	54	42.65	32.09	4.64	35.81	131	72	Average
2483.85	66.24	-7.76	74	65.32	32.09	4.64	35.81	131	72	Peak



3.8 Antenna Requirements

3.8.1 Standard Applicable

If directional gain of transmitting antennas is greater than 6dBi, the power shall be reduced by the same level in dB comparing to gain minus 6dBi. For the fixed point-to-point operation, the power shall be reduced by one dB for every 3 dB that the directional gain of the antenna exceeds 6 dBi. The use of a permanently attached antenna or of an antenna that uses a unique coupling to the intentional radiator shall be considered sufficient to comply with the FCC rule.

3.8.2 Antenna Connected Construction

The antennas type used in this product is Chip Antenna without connector and it is considered to meet antenna requirement.

3.8.3 Antenna Gain

The antenna peak gain of EUT is less than 6 dBi. Therefore, it is not necessary to reduce maximum peak output power limit.



4 List of Measuring Equipment

Instrument	Manufacturer	Model No.	Serial No.	Characteristics	Calibration Date	Test Date	Due Date	Remark
Spectrum Analyzer	Agilent	E4445A	MY4820287	3Hz~13.2GHz	Nov. 02, 2011	Mar. 13, 2012 ~ Apr. 03, 2012	Nov. 01, 2013	Conducted (TH02-HY)
EMI Test Receive	R&S	ESCS 30	100356	9KHz ~ 2.75GHz	Oct. 27, 2011	Mar. 09, 2012	Oct. 26, 2012	Conduction (CO05-HY)
Two-LISN	R&S	ENV216	11-100081	9KHz ~ 30MHz	Dec. 09, 2011	Mar. 09, 2012	Dec. 08, 2012	Conduction (CO05-HY)
Two-LISN	R&S	ENV216	11-100080	9KHz ~ 30MHz	Dec. 06, 2011	Mar. 09, 2012	Dec. 05, 2012	Conduction (CO05-HY)
AC Power Source	APC	APC-1000 W	N/A	N/A	N/A	Mar. 09, 2012	N/A	Conduction (CO05-HY)
GPS Station	Pendulum	GSG-54	N/A	N/A	N/A	Mar. 09, 2012	N/A	Conduction (CO05-HY)
Spectrum Analyzer	R&S	ESU26	100390	20Hz ~ 26.5GHz	Dec. 22, 2011	Mar. 19, 2012 ~ Mar. 24, 2012	Dec. 21, 2012	Radiation (03CH05-HY)
COM-POWER	COM-POWER	PA-103	161075	10Hz~1000MHz Gain:32dB	Feb. 27, 2012	Mar. 19, 2012 ~ Mar. 24, 2012	Feb. 26, 2013	Radiation (03CH05-HY)
Bilog Antenna	SCHAFFNER	CBL6111C	2725	30MHz ~ 2GHz	Oct. 22, 2011	Mar. 19, 2012 ~ Mar. 24, 2012	Oct. 21, 2012	Radiation (03CH05-HY)
Turn Table	HD	Deis HD 2000	420/611	0 ~ 360 degree	N/A	Mar. 19, 2012 ~ Mar. 24, 2012	N/A	Radiation (03CH05-HY)
Antenna Mast	HD	MA 240	240/666	1 m ~ 4 m	N/A	Mar. 19, 2012 ~ Mar. 24, 2012	N/A	Radiation (03CH05-HY)
Horn Antenna	ESCO	3117	66584	1GHz ~ 18GHz	Aug. 04, 2011	Mar. 19, 2012 ~ Mar. 24, 2012	Aug. 03, 2012	Radiation (03CH05-HY)
Pre Amplifier	COM-POWER	PA-103	161075	10Hz ~ 1000MHz Gain:32dB	Feb. 27, 2012	Mar. 19, 2012 ~ Mar. 24, 2012	Feb. 26, 2013	Radiation (03CH05-HY)
Pre Amplifier	EMCI	EMC05184 5	SN980048	1GHz~18GHz	Jul. 18, 2011	Mar. 19, 2012 ~ Mar. 24, 2012	Jul. 17, 2012	Radiation (03CH05-HY)
Pre Amplifier	Agilent	8449B	3008A01917	1GHz~26.5GHz	Aug. 30, 2011	Mar. 19, 2012 ~ Mar. 24, 2012	Aug. 29, 2012	Radiation (03CH05-HY)
Loop Antenna	R&S	HFH2-Z2	860004/001	9 kHz~30 MHz	Jul. 29, 2010	Mar. 19, 2012 ~ Mar. 24, 2012	Jul. 28, 2012	Radiation (03CH05-HY)

5 Uncertainty of Evaluation

Uncertainty of Conducted Emission Measurement (150 KHz ~ 30 MHz)

Contribution	Uncertainty of X_i		$u(X_i)$
	dB	Probability Distribution	
Receiver Reading	0.10	Normal (k=2)	0.05
Cable Loss	0.10	Normal (k=2)	0.05
AMN Insertion Loss	2.50	Rectangular	0.63
Receiver Specification	1.50	Rectangular	0.43
Site Imperfection	1.39	Rectangular	0.80
Mismatch	+0.34 / -0.35	U-Shape	0.24
Combined Standard Uncertainty $U_c(y)$	1.13		
Measuring Uncertainty for a Level of Confidence of 95% ($U = 2U_c(y)$)	2.26		

Uncertainty of Radiated Emission Measurement (30 MHz ~ 1000 MHz)

Contribution	Uncertainty of X_i		$u(X_i)$
	dB	Probability Distribution	
Receiver Reading	0.41	Normal (k=2)	0.21
Antenna Factor Calibration	0.83	Normal (k=2)	0.42
Cable Loss Calibration	0.25	Normal (k=2)	0.13
Pre-Amplifier Gain Calibration	0.27	Normal (k=2)	0.14
RCV/SPA Specification	2.50	Rectangular	0.72
Antenna Factor Interpolation for Frequency	1.00	Rectangular	0.29
Site Imperfection	1.43	Rectangular	0.83
Mismatch	+0.39 / -0.41	U-Shape	0.28
Combined Standard Uncertainty $U_c(y)$	1.27		
Measuring Uncertainty for a Level of Confidence of 95% ($U = 2U_c(y)$)	2.54		

Uncertainty of Radiated Emission Measurement (1 GHz ~ 40 GHz)

Contribution	Uncertainty of X_i		$u(X_i)$	C_i	$C_i * u(X_i)$
	dB	Probability Distribution			
Receiver Reading	±0.10	Normal (k=2)	0.10	1	0.10
Antenna Factor Calibration	±1.70	Normal (k=2)	0.85	1	0.85
Cable Loss Calibration	±0.50	Normal (k=2)	0.25	1	0.25
Receiver Correction	±2.00	Rectangular	1.15	1	1.15
Antenna Factor Directional	±1.50	Rectangular	0.87	1	0.87
Site Imperfection	±2.80	Triangular	1.14	1	1.14
Mismatch Receiver VSWR $\Gamma_1 = 0.197$ Antenna VSWR $\Gamma_2 = 0.194$ Uncertainty = $20\text{Log}(1-\Gamma_1*\Gamma_2)$	+0.34 / -0.35	U-Shape	0.244	1	0.244
Combined Standard Uncertainty $U_c(y)$	2.36				
Measuring Uncertainty for a Level of Confidence of 95% ($U = 2U_c(y)$)	4.72				



Appendix A. Photographs of EUT

Please refer to Sporton report number EP232172 as below.