

FCC SAR Test Report

APPLICANT : PEGATRON CORPORATION
EQUIPMENT : HSPA+ Module
BRAND NAME : HUAWEI
MODEL NAME : MU736
FCC ID : VUIMU736ARC1
STANDARD : FCC 47 CFR Part 2 (2.1093)
ANSI/IEEE C95.1-1992
IEEE 1528-2003
FCC OET Bulletin 65 Supplement C (Edition 01-01)

The product was installed into Tablet PC (Brand Name: TOSHIBA, Model Name: TOSHIBA AT10-A、TOSHIBA AT15-A, FCC ID: VUIPDAPDAAT10-A) during test.

The product was completely tested on Apr. 26, 2013. We, SPORTON INTERNATIONAL INC., would like to declare that the tested sample has been evaluated in accordance with the procedures and shown the compliance with the applicable technical standards.

The test results in this report apply exclusively to the tested model / sample. Without written approval of SPORTON INTERNATIONAL INC., the test report shall not be reproduced except in full.

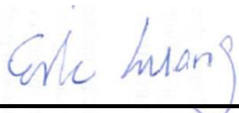

Reviewed by: Eric Huang / Deputy Manager



Approved by: Jones Tsai / Manager



SPORTON INTERNATIONAL INC.

No. 52, Hwa Ya 1st Rd., Hwa Ya Technology Park, Kwei-Shan Hsiang, Tao Yuan Hsien, Taiwan, R.O.C.



Table of Contents

1. Statement of Compliance 4
2. Administration Data 5
2.1 Testing Laboratory..... 5
2.2 Applicant 5
2.3 Manufacturer 5
2.4 Application Details..... 5
3. General Information 6
3.1 Description of Equipment Under Test (EUT) 6
3.2 Maximum RF output power among production units 7
3.3 Applied Standard..... 7
3.4 Device Category and SAR Limits 7
3.5 Test Conditions..... 7
4. Specific Absorption Rate (SAR).....11
4.1 Introduction 11
4.2 SAR Definition..... 11
5. SAR Measurement System.....12
5.1 E-Field Probe 12
5.2 Data Acquisition Electronics (DAE) 13
5.3 Robot 14
5.4 Measurement Server..... 14
5.5 Phantom..... 15
5.6 Device Holder..... 16
5.7 Data Storage and Evaluation 17
5.8 Test Equipment List 19
6. Tissue Simulating Liquids.....20
7. SAR System Verification22
7.1 Purpose of System Performance check 22
7.2 System Setup..... 22
7.3 SAR System Verification Results 23
8. EUT Testing Position24
9. Measurement Procedures24
9.1 Spatial Peak SAR Evaluation 24
9.2 Power Reference Measurement..... 25
9.3 Area & Zoom Scan Procedures..... 25
9.4 Volume Scan Procedures..... 26
9.5 SAR Averaged Methods 26
9.6 Power Drift Monitoring..... 26
10. Conducted RF Output Power (Unit: dBm).....27
11. Exposure Positions Consideration.....32
12. SAR Test Results35
12.1 Test Records for Body SAR Test 35
12.2 Repeated SAR Measurement 37
12.3 Highest SAR Plot 38
13. Simultaneous Transmission Analysis41
13.1 Body Exposure Conditions 42
13.2 SPLSR Evaluation and Analysis..... 44
14. Uncertainty Assessment49
15. References.....51
Appendix A. Plots of System Performance Check
Appendix B. Plots of SAR Measurement
Appendix C. DASYS Calibration Certificate
Appendix D. Test Setup Photos



1. Statement of Compliance

The maximum results of Specific Absorption Rate (SAR) found during testing for PEGATRON CORPORATION HSPA+ Module, MU736, are as follows.

<Highest Reported SAR Summary>

Exposure Position	Frequency Band	Reported 1g-SAR (W/kg)	Equipment Class	Highest Reported 1g-SAR (W/kg)
Body	GPRS850	1.03	PCB	1.03
	GPRS1900	0.98		
	WCDMA Band V	1.03		
	WCDMA Band IV	0.88		
	WCDMA Band II	1.00		

<Highest SAR Simultaneous transmission >

Frequency Band	Equipment Class	Exposure Position	Highest Reported Simultaneous Transmission 1g-SAR (W/kg)
GPRS1900	PCB	Bottom Face (1cm gap)	1.49
WLAN 2.4GHz Band	DTS		

Frequency Band	Equipment Class	Exposure Position	Highest Reported Simultaneous Transmission 1g-SAR (W/kg)
GPRS850	PCB	Edge 2 (0cm gap)	1.43
2.4GHz Bluetooth	DSS		

This device is in compliance with Specific Absorption Rate (SAR) for general population/uncontrolled exposure limits (1.6 W/kg) specified in FCC 47 CFR part 2 (2.1093) and ANSI/IEEE C95.1-1992, and had been tested in accordance with the measurement methods and procedures specified in IEEE 1528-2003 and FCC OET Bulletin 65 Supplement C (Edition 01-01).



2. Administration Data

2.1 Testing Laboratory

Test Site	SPORTON INTERNATIONAL INC.
Test Site Location	No. 52, Hwa Ya 1 st Rd., Hwa Ya Technology Park, Kwei-Shan Hsiang, Tao Yuan Hsien, Taiwan, R.O.C. TEL: +886-3-327-3456 FAX: +886-3-328-4978

2.2 Applicant

Company Name	PEGATRON CORPORATION
Address	No. 76, Ligong St., Beitou District, Taipei City 112

2.3 Manufacturer

Company Name	Huawei Technologies Canada Co., Ltd
Address	Administration Building, Headquarters of Huawei Technologies Co., Ltd., Bantian, Longgang District, Shenzhen, 518129, P.R.C

2.4 Application Details

Date of Start during the Test	Apr. 23, 2013
Date of End during the Test	Apr. 26, 2013



3. General Information

3.1 Description of Equipment Under Test (EUT)

Product Feature & Specification	
EUT	HSPA+ Module
Brand Name	HUAWEI
Model Name	MU736
FCC ID	VUIMU736ARC1
IMEI Code	866274010091274
TX Frequency	GSM850: 824.2 MHz ~ 848.8 MHz GSM1900: 1850.2 MHz ~ 1909.8 MHz WCDMA Band V: 826.4 MHz ~ 846.6 MHz WCDMA Band IV: 1712.4 MHz ~ 1752.6 MHz WCDMA Band II: 1852.4 MHz ~ 1907.6 MHz
Uplink Modulations	GSM: GMSK GPRS: GMSK EDGE: GMSK / 8PSK WCDMA (Rel 99): QPSK HSDPA (Rel 6): QPSK HSUPA (Rel 6): QPSK
EUT Stage	Production Unit
Remark: 1. The above EUT's information was declared by manufacturer. Please refer to the specifications or user's manual for more detailed description.	

Host Product Feature & Specification	
Host Name	Tablet
Brand Name	TOSHIBA
Model Name	TOSHIBA AT10-A, TOSHIBA AT15-A
FCC ID	VUIPDAPDAAT10-A
Antenna Type	WWAN: PCB Antenna WLAN: Chip Antenna Bluetooth: Chip Antenna NFC: Loop Antenna

Bluetooth Keyboard Cover Product Feature & Specification	
Brand Name	TOSHIBA
Model Name	U68B
FCC ID	O62U68B
TX Frequency	Bluetooth: 2402 MHz ~ 2480 MHz
Antenna Type	Bluetooth: PIFA Antenna
Modulations	Bluetooth 2.1 BDR (1Mbps) : GFSK

3.2 Maximum RF output power among production units

Band	average power (dBm)			
	GSM 850		GSM 1900	
Output Power Status	Normal	Reduced	Normal	Reduced
GPRS/EDGE (GMSK, 1 Tx slot)	33.5	29.5	30.5	25.5
GPRS/EDGE (GMSK, 2 Tx slots)	31	27	28	23
GPRS/EDGE (GMSK, 3 Tx slots)	29	25	26	21
GPRS/EDGE (GMSK, 4 Tx slots)	28	24	25	20
EDGE (8PSK, 1 Tx slot)	28	26	27	25
EDGE (8PSK, 2 Tx slots)	25.5	23.5	24.5	22.5
EDGE (8PSK, 3 Tx slots)	24	22	23	21
EDGE (8PSK, 4 Tx slots)	22.5	20.5	21.5	19.5

Band	average power(dBm)					
	WCDMA Band V		WCDMA Band II		WCDMA Band IV	
Output Power Status	Normal	Reduced	Normal	Reduced	Normal	Reduced
RMC 12.2Kbps	24.5	21.5	24.5	16.5	24.5	16.5
HSDPA Subtest-1	24.5	21.5	24.5	16.5	24.5	16.5
HSUPA Subtest-5	24.5	21.5	24.5	16.5	24.5	16.5

3.3 Applied Standard

The Specific Absorption Rate (SAR) testing specification, method, and procedure for this device is in accordance with the following standards:

- FCC 47 CFR Part 2 (2.1093)
- ANSI/IEEE C95.1-1992
- IEEE 1528-2003
- FCC OET Bulletin 65 Supplement C (Edition 01-01)
- FCC KDB 447498 D01 v05
- FCC KDB 616217 D04 v01
- FCC KDB 941225 D01 v02
- FCC KDB 941225 D03 v01

3.4 Device Category and SAR Limits

This device belongs to portable device category because its radiating structure is allowed to be used within 20 centimeters of the body of the user. Limit for General Population/Uncontrolled exposure should be applied for this device, it is 1.6 W/kg as averaged over any 1 gram of tissue.

3.5 Test Conditions

3.5.1 Ambient Condition

Ambient Temperature	20 to 24 °C
Humidity	< 60 %

3.5.2 Test Configuration

For WWAN SAR testing, the device was controlled by using a base station emulator. Communication between the device and the emulator was established by air link. The distance between the EUT and the antenna of the emulator is larger than 50 cm and the output power radiated from the emulator antenna is at least 30 dB smaller than the output power of EUT.



Target Power reduction applied for each wireless mode and orientation

Exposure Position / wireless mode	Bottom Face ⁽¹⁾	Edge 1 ⁽¹⁾	Edge 2	Edge 3	Edge 4
GSM850 GPRS/EDGE (GMSK, 1 Tx slot)	4.0 dB	4.0 dB	0 dB	0 dB	0 dB
GSM850 GPRS/EDGE (GMSK, 2 Tx slots)	4.0 dB	4.0 dB	0 dB	0 dB	0 dB
GSM850 GPRS/EDGE (GMSK, 3 Tx slots)	4.0 dB	4.0 dB	0 dB	0 dB	0 dB
GSM850 GPRS/EDGE (GMSK, 4 Tx slots)	4.0 dB	4.0 dB	0 dB	0 dB	0 dB
GSM850 EDGE (8PSK 1 Tx slot) - MCS5	2.0 dB	2.0 dB	0 dB	0 dB	0 dB
GSM850 EDGE (8PSK 2 Tx slot) - MCS5	2.0 dB	2.0 dB	0 dB	0 dB	0 dB
GSM850 EDGE (8PSK 3 Tx slot) - MCS5	2.0 dB	2.0 dB	0 dB	0 dB	0 dB
GSM850 EDGE (8PSK 4 Tx slot) - MCS5	2.0 dB	2.0 dB	0 dB	0 dB	0 dB
GSM1900 GPRS/EDGE (GMSK, 1 Tx slot)	5.0 dB	5.0 dB	0 dB	0 dB	0 dB
GSM1900 GPRS/EDGE (GMSK, 2 Tx slots)	5.0 dB	5.0 dB	0 dB	0 dB	0 dB
GSM1900 GPRS/EDGE (GMSK, 3 Tx slots)	5.0 dB	5.0 dB	0 dB	0 dB	0 dB
GSM1900 GPRS/EDGE (GMSK, 4 Tx slots)	5.0 dB	5.0 dB	0 dB	0 dB	0 dB
GSM1900 EDGE (8PSK 1 Tx slot) - MCS5	2.0 dB	2.0 dB	0 dB	0 dB	0 dB
GSM1900 EDGE (8PSK 2 Tx slot) - MCS5	2.0 dB	2.0 dB	0 dB	0 dB	0 dB
GSM1900 EDGE (8PSK 3 Tx slot) - MCS5	2.0 dB	2.0 dB	0 dB	0 dB	0 dB
GSM1900 EDGE (8PSK 4 Tx slot) - MCS5	2.0 dB	2.0 dB	0 dB	0 dB	0 dB
WCDMA Band V	3.0 dB	3.0 dB	0 dB	0 dB	0 dB
WCDMA Band IV	8.0 dB	8.0 dB	0 dB	0 dB	0 dB
WCDMA Band II	8.0 dB	8.0 dB	0 dB	0 dB	0 dB

Remark:

- 1. ⁽¹⁾: Reduced maximum limit applied by activation of proximity sensor.=>P-Sensor
- 2. Power reduction is not applicable for WLAN and Bluetooth.



Measurement on EUT:

Band/Mode	Ch #	Measured power reduction (dBm)		Reduction Levels
		w/o power back-off	w/ power back-off	(dB)
GSM850 GPRS/EDGE (GMSK, 4 Tx slots)	189	26.66	23.03	3.63
GSM1900 GPRS/EDGE (GMSK, 4 Tx slots)	661	23.39	19.58	3.81
WCDMA Band 5 (RMC 12.2Kbps)	4182	23.09	19.62	3.47
WCDMA Band 2 (RMC 12.2Kbps)	9400	23.13	15.98	7.15
WCDMA Band 4 (RMC 12.2Kbps)	1413	22.93	14.52	8.14

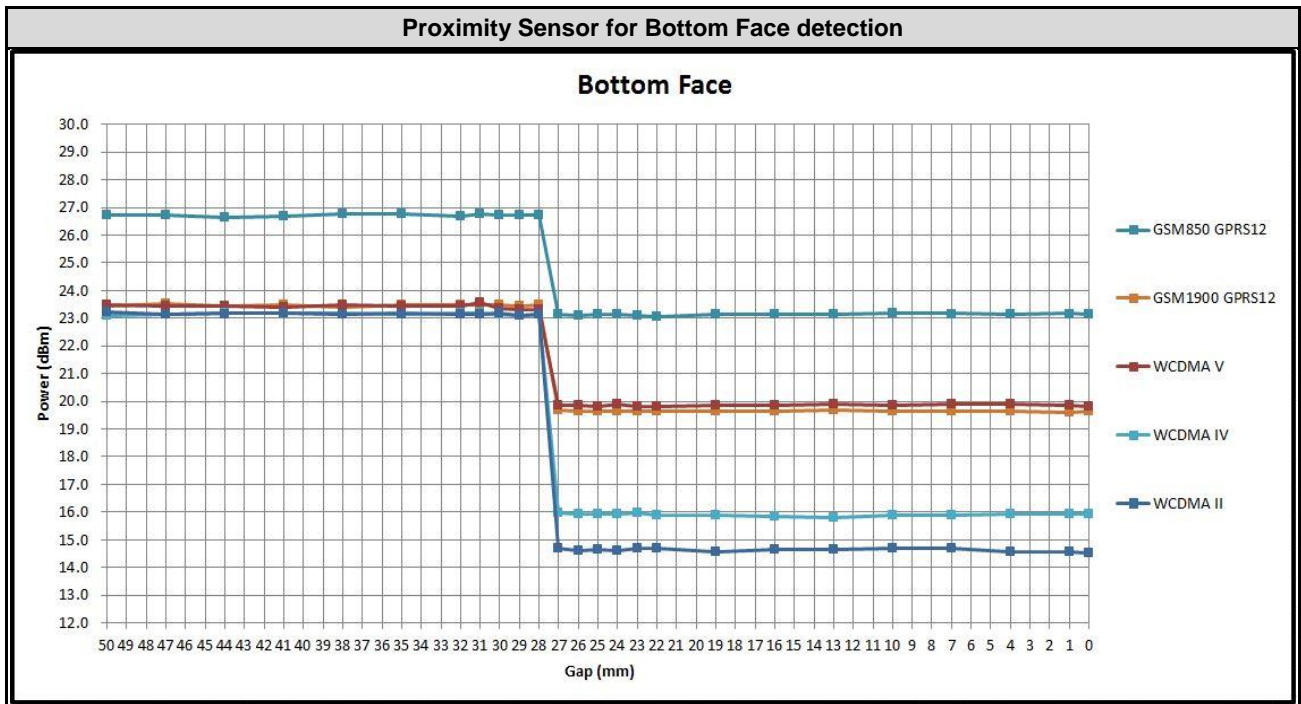



Proximity Sensor for Edge 1 detection

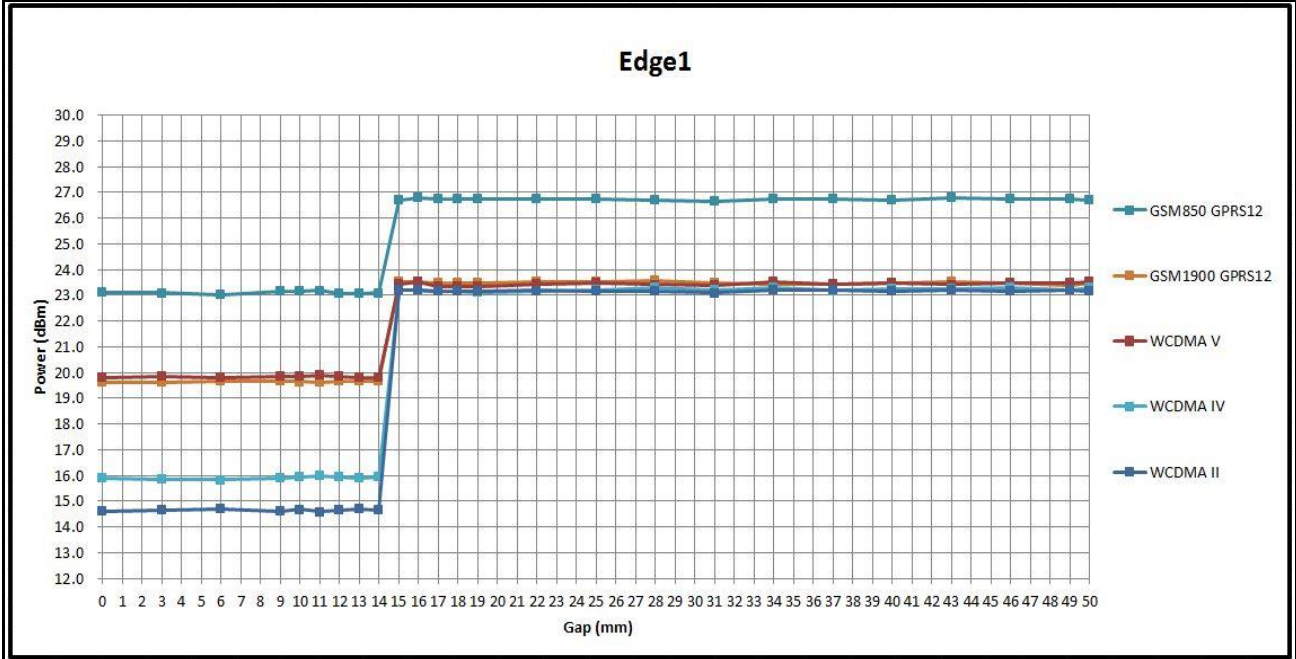

4. Specific Absorption Rate (SAR)

4.1 Introduction

SAR is related to the rate at which energy is absorbed per unit mass in an object exposed to a radio field. The SAR distribution in a biological body is complicated and is usually carried out by experimental techniques or numerical modeling. The standard recommends limits for two tiers of groups, occupational/controlled and general population/uncontrolled, based on a person's awareness and ability to exercise control over his or her exposure. In general, occupational/controlled exposure limits are higher than the limits for general population/uncontrolled.

4.2 SAR Definition

The SAR definition is the time derivative (rate) of the incremental energy (dW) absorbed by (dissipated in) an incremental mass (dm) contained in a volume element (dv) of a given density (ρ). The equation description is as below:

$$\text{SAR} = \frac{d}{dt} \left(\frac{dW}{dm} \right) = \frac{d}{dt} \left(\frac{dW}{\rho dv} \right)$$

SAR is expressed in units of Watts per kilogram (W/kg)

SAR measurement can be either related to the temperature elevation in tissue by

$$\text{SAR} = C \left(\frac{\delta T}{\delta t} \right)$$

Where: C is the specific heat capacity, δT is the temperature rise and δt is the exposure duration, or related to the electrical field in the tissue by

$$\text{SAR} = \frac{\sigma |E|^2}{\rho}$$

Where: σ is the conductivity of the tissue, ρ is the mass density of the tissue and E is the RMS electrical field strength.

However for evaluating SAR of low power transmitter, electrical field measurement is typically applied.

5. SAR Measurement System

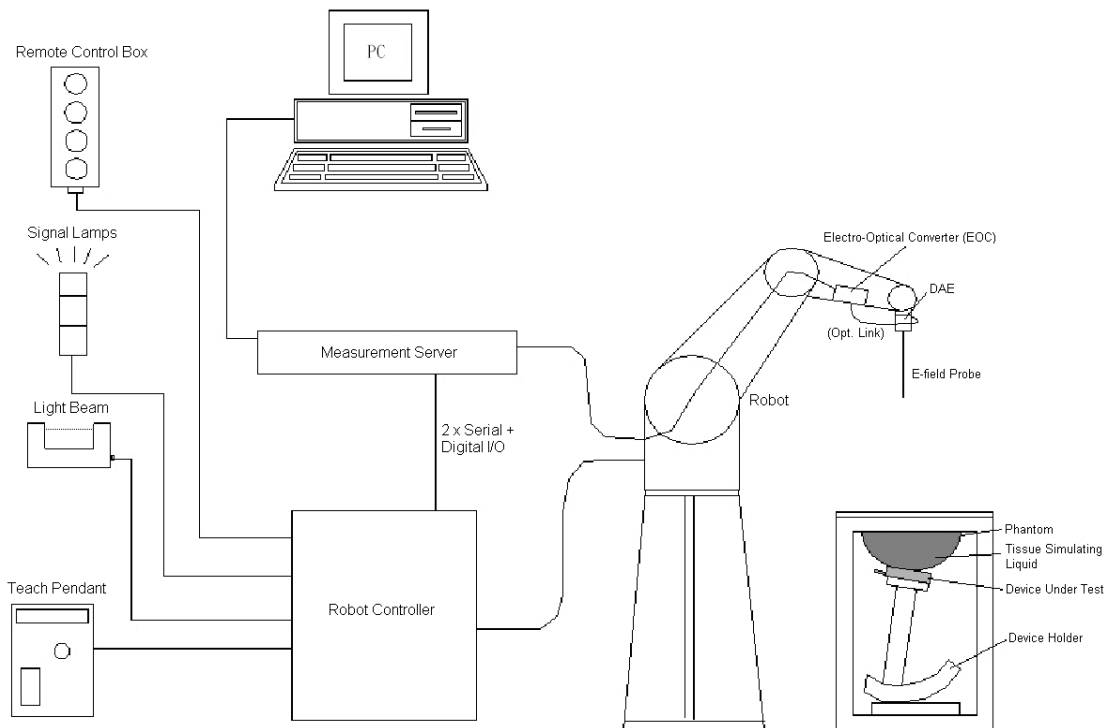

Fig 5.1 SPEAG DASY System Configurations

The DASY system for performance compliance tests is illustrated above graphically. This system consists of the following items:

- A standard high precision 6-axis robot with controller, a teach pendant and software
- A data acquisition electronic (DAE) attached to the robot arm extension
- A dosimetric probe equipped with an optical surface detector system
- The electro-optical converter (EOC) performs the conversion between optical and electrical signals
- A measurement server performs the time critical tasks such as signal filtering, control of the robot operation and fast movement interrupts.
- A probe alignment unit which improves the accuracy of the probe positioning
- A computer operating Windows XP
- DASY software
- Remote control with teach pendant and additional circuitry for robot safety such as warning lamps, etc.
- The SAM twin phantom
- A device holder
- Tissue simulating liquid
- Dipole for evaluating the proper functioning of the system

Component details are described in in the following sub-sections.

5.1 E-Field Probe

The SAR measurement is conducted with the dosimetric probe (manufactured by SPEAG).The probe is specially designed and calibrated for use in liquid with high permittivity. The dosimetric probe has special calibration in liquid at different frequency. This probe has a built in optical surface detection system to prevent from collision with phantom.

5.1.1 E-Field Probe Specification

<ET3DV6 Probe >

Construction	Symmetrical design with triangular core Built-in optical fiber for surface detection system. Built-in shielding against static charges. PEEK enclosure material (resistant to organic solvents, e.g., DGBE)
Frequency	10 MHz to 3 GHz; Linearity: ± 0.2 dB
Directivity	± 0.2 dB in HSL (rotation around probe axis) ± 0.4 dB in HSL (rotation normal to probe axis)
Dynamic Range	5 μ W/g to 100 mW/g; Linearity: ± 0.2 dB
Dimensions	Overall length: 330 mm (Tip: 16 mm) Tip diameter: 6.8 mm (Body: 12 mm) Distance from probe tip to dipole centers: 2.7 mm



Fig 5.2 Photo of ET3DV6

5.1.2 E-Field Probe Calibration

Each probe needs to be calibrated according to a dosimetric assessment procedure with accuracy better than $\pm 10\%$. The spherical isotropy shall be evaluated and within ± 0.25 dB. The sensitivity parameters (NormX, NormY, and NormZ), the diode compression parameter (DCP) and the conversion factor (ConvF) of the probe are tested. The calibration data can be referred to appendix C of this report.

5.2 Data Acquisition Electronics (DAE)

The data acquisition electronics (DAE) consists of a highly sensitive electrometer-grade preamplifier with auto-zeroing, a channel and gain-switching multiplexer, a fast 16 bit AD-converter and a command decoder and control logic unit. Transmission to the measurement server is accomplished through an optical downlink for data and status information as well as an optical uplink for commands and the clock. The input impedance of the DAE is 200 MOhm; the inputs are symmetrical and floating. Common mode rejection is above 80 dB.



Fig 5.3 Photo of DAE

5.3 Robot

The SPEAG DASY system uses the high precision robots (DASY4: RX90BL; DASY5: TX90XL) type from Stäubli SA (France). For the 6-axis controller system, the robot controller version (DASY4: CS7MB; DASY5: CS8c) from Stäubli is used. The Stäubli robot series have many features that are important for our application:

- High precision (repeatability ± 0.035 mm)
- High reliability (industrial design)
- Jerk-free straight movements
- Low ELF interference (the closed metallic construction shields against motor control fields)



Fig 5.4 Photo of DASY4



Fig 5.5 Photo of DASY5

5.4 Measurement Server

The measurement server is based on a PC/104 CPU board with CPU (DASY4: 166 MHz, Intel Pentium; DASY5: 400 MHz, Intel Celeron), chipdisk (DASY4: 32 MB; DASY5: 128 MB), RAM (DASY4: 64 MB, DASY5: 128 MB). The necessary circuits for communication with the DAE electronic box, as well as the 16 bit AD converter system for optical detection and digital I/O interface are contained on the DASY I/O board, which is directly connected to the PC/104 bus of the CPU board.

The measurement server performs all the real-time data evaluation for field measurements and surface detection, controls robot movements and handles safety operations.



Fig 5.6 Photo of Server for DASY4



Fig 5.7 Photo of Server for DASY5

5.5 Phantom

<SAM Twin Phantom>

Shell Thickness	2 ± 0.2 mm; Center ear point: 6 ± 0.2 mm
Filling Volume	Approx. 25 liters
Dimensions	Length: 1000 mm; Width: 500 mm; Height: adjustable feet
Measurement Areas	Left Hand, Right Hand, Flat Phantom



Fig 5.8 Photo of SAM Phantom

The bottom plate contains three pair of bolts for locking the device holder. The device holder positions are adjusted to the standard measurement positions in the three sections. A white cover is provided to tap the phantom during off-periods to prevent water evaporation and changes in the liquid parameters. On the phantom top, three reference markers are provided to identify the phantom position with respect to the robot.

<ELI4 Phantom>

Shell Thickness	2 ± 0.2 mm (sagging: <1%)
Filling Volume	Approx. 30 liters
Dimensions	Major ellipse axis: 600 mm Minor axis: 400 mm



Fig 5.9 Photo of ELI4 Phantom

The ELI4 phantom is intended for compliance testing of handheld and body-mounted wireless devices in the frequency range of 30 MHz to 6 GHz. ELI4 is fully compatible with standard and all known tissue simulating liquids.

5.6 Device Holder

<Device Holder for SAM Twin Phantom>

The SAR in the phantom is approximately inversely proportional to the square of the distance between the source and the liquid surface. For a source at 5 mm distance, a positioning uncertainty of ± 0.5 mm would produce a SAR uncertainty of ± 20 %. Accurate device positioning is therefore crucial for accurate and repeatable measurements. The positions in which the devices must be measured are defined by the standards.

The DASY device holder is designed to cope with different positions given in the standard. It has two scales for the device rotation (with respect to the body axis) and the device inclination (with respect to the line between the ear reference points). The rotation center for both scales is the ear reference point (ERP). Thus the device needs no repositioning when changing the angles.

The DASY device holder is constructed of low-loss POM material having the following dielectric parameters: relative permittivity $\epsilon = 3$ and loss tangent $\delta = 0.02$. The amount of dielectric material has been reduced in the closest vicinity of the device, since measurements have suggested that the influence of the clamp on the test results could thus be lowered.



Fig 5.10 Device Holder

<Laptop Extension Kit>

The extension is lightweight and made of POM, acrylic glass and foam. It fits easily on the upper part of the mounting device in place of the phone positioned. The extension is fully compatible with the SAM Twin and ELI phantoms.

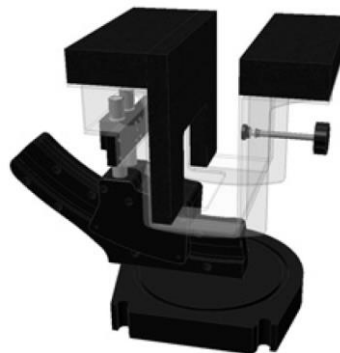

Fig 5.11 Laptop Extension Kit



5.7 Data Storage and Evaluation

5.7.1 Data Storage

The DASY software stores the assessed data from the data acquisition electronics as raw data (in microvolt readings from the probe sensors), together with all the necessary software parameters for the data evaluation (probe calibration data, liquid parameters and device frequency and modulation data) in measurement files. The post-processing software evaluates the desired unit and format for output each time the data is visualized or exported. This allows verification of the complete software setup even after the measurement and allows correction of erroneous parameter settings. For example, if a measurement has been performed with an incorrect crest factor parameter in the device setup, the parameter can be corrected afterwards and the data can be reevaluated.

The measured data can be visualized or exported in different units or formats, depending on the selected probe type (e.g., [V/m], [A/m], [mW/g]). Some of these units are not available in certain situations or give meaningless results, e.g., a SAR-output in a non-lose media, will always be zero. Raw data can also be exported to perform the evaluation with other software packages.

5.7.2 Data Evaluation

The DASY post-processing software (SEMCAD) automatically executes the following procedures to calculate the field units from the microvolt readings at the probe connector. The parameters used in the evaluation are stored in the configuration modules of the software :

Probe parameters :	- Sensitivity	Norm _i , a _{i0} , a _{i1} , a _{i2}
	- Conversion factor	ConvF _i
	- Diode compression point	dcp _i
Device parameters :	- Frequency	f
	- Crest factor	cf
Media parameters :	- Conductivity	σ
	- Density	ρ

These parameters must be set correctly in the software. They can be found in the component documents or they can be imported into the software from the configuration files issued for the DASY components. In the direct measuring mode of the multi-meter option, the parameters of the actual system setup are used. In the scan visualization and export modes, the parameters stored in the corresponding document files are used.

The first step of the evaluation is a linearization of the filtered input signal to account for the compression characteristics of the detector diode. The compensation depends on the input signal, the diode type and the DC-transmission factor from the diode to the evaluation electronics. If the exciting field is pulsed, the crest factor of the signal must be known to correctly compensate for peak power.

The formula for each channel can be given as :

$$V_i = U_i + U_i^2 \cdot \frac{cf}{dcp_i}$$

with V_i = compensated signal of channel i , ($i = x, y, z$)
 U_i = input signal of channel i , ($i = x, y, z$)
 cf = crest factor of exciting field (DASY parameter)
 dcp_i = diode compression point (DASY parameter)

From the compensated input signals, the primary field data for each channel can be evaluated :

$$\text{E-field Probes : } E_i = \sqrt{\frac{V_i}{\text{Norm}_i \cdot \text{ConvF}}}$$

$$\text{H-field Probes : } H_i = \sqrt{V_i \cdot \frac{a_{i0} + a_{i1}f + a_{i2}f^2}{f}}$$

with V_i = compensated signal of channel i , ($i = x, y, z$)
 Norm_i = sensor sensitivity of channel i , ($i = x, y, z$), $\mu\text{V}/(\text{V/m})^2$ for E-field Probes
 ConvF = sensitivity enhancement in solution
 a_{ij} = sensor sensitivity factors for H-field probes
 f = carrier frequency [GHz]
 E_i = electric field strength of channel i in V/m
 H_i = magnetic field strength of channel i in A/m

The RSS value of the field components gives the total field strength (Hermitian magnitude) :

$$E_{\text{tot}} = \sqrt{E_x^2 + E_y^2 + E_z^2}$$

The primary field data are used to calculate the derived field units.

$$\text{SAR} = E_{\text{tot}}^2 \cdot \frac{\sigma}{\rho \cdot 1000}$$

with SAR = local specific absorption rate in mW/g
 E_{tot} = total field strength in V/m
 σ = conductivity in [mho/m] or [Siemens/m]
 ρ = equivalent tissue density in g/cm^3

Note that the density is set to 1, to account for actual head tissue density rather than the density of the tissue simulating liquid.



5.8 Test Equipment List

Manufacturer	Name of Equipment	Type/Model	Serial Number	Calibration	
				Last Cal.	Due Date
SPEAG	835MHz System Validation Kit	D835V2	499	Mar. 18, 2013	Mar. 19, 2014
SPEAG	1750MHz System Validation Kit	D1750V2	1068	Jun. 20, 2012	Jun. 19, 2013
SPEAG	1900MHz System Validation Kit	D1900V2	5d041	Mar. 20, 2013	Mar. 19, 2014
SPEAG	Data Acquisition Electronics	DAE4	910	Dec. 05, 2012	Dec. 04, 2013
SPEAG	Dosimetric E-Field Probe	ET3DV6	1787	May. 29, 2012	May. 28, 2013
H.M.IRIS	Thermometer	TH-08	TM658	Nov. 13, 2012	Nov. 12, 2013
SPEAG	Device Holder	N/A	N/A	NCR	NCR
SPEAG	ELI4 Phantom	QD 0VA 002 AA	TP-1127	NCR	NCR
SPEAG	ELI4 Phantom	QD 0VA 002 AA	TP-1131	NCR	NCR
Agilent	ENA Network Analyzer	E5071C	MY46316648	Feb. 07, 2013	Feb. 06, 2014
Agilent	ESG Vector Series Signal Generator	E4438C	MY49070755	Oct. 02, 2012	Oct. 01, 2013
Anritsu	Power Meter	ML2495A	1132003	Aug. 14, 2012	Aug. 13, 2013
Agilent	Wireless Communication Test Set	E5515C	MY48360820	Jan. 05, 2012	Jan. 04, 2014
Agilent	Dual Directional Coupler	778D	50422	Note 3	
Woken	Attenuator 1	WK0602-XX	N/A	Note 3	
PE	Attenuator 2	PE7005-10	N/A	Note 3	
PE	Attenuator 3	PE7005- 3	N/A	Note 3	
Agilent	Dielectric Probe Kit	85070D	US01440205	Note 4	
AR	Power Amplifier	5S1G4M2	328767	Note 5	
R&S	Spectrum Analyzer	FSP	101131	Jul. 23, 2012	Jul. 22, 2013

Table 5.1 Test Equipment List

Note:

1. The calibration certificate of DASYS can be referred to appendix C of this report.
2. Referring to KDB 865664 D01v01, the dipole calibration interval can be extended to 3 years with justification. The dipoles are also not physically damaged, or repaired during the interval.
3. The Insertion Loss calibration of Dual Directional Coupler and Attenuator were characterized via the network analyzer and compensated during system check.
4. The dielectric probe kit was calibrated via the network analyzer, with the specified procedure (calibrated in pure water) and calibration kit (standard) short circuit, before the dielectric measurement. The specific procedure and calibration kit are provided by Agilent.
5. In system check we need to monitor the level on the power meter, and adjust the power amplifier level to have precise power level to the dipole; the measured SAR will be normalized to 1W input power according to the ratio of 1W to the input power to the dipole. For system check, the calibration of the power amplifier is deemed not critically required for correct measurement; the power meter is critical and we do have calibration for it
6. Attenuator 1 insertion loss is calibrated by the network Analyzer, which the calibration is valid, before system check.

6. Tissue Simulating Liquids

For the measurement of the field distribution inside the SAM phantom with DASY, the phantom must be filled with around 25 liters of homogeneous body tissue simulating liquid. For head SAR testing, the liquid height from the ear reference point (ERP) of the phantom to the liquid top surface is larger than 15 cm, which is shown in Fig. 6.1. For body SAR testing, the liquid height from the center of the flat phantom to the liquid top surface is larger than 15 cm, which is shown in Fig. 6.2.

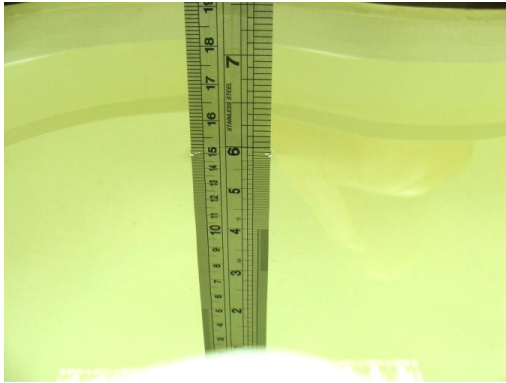

Fig 6.1 Photo of Liquid Height for Head SAR



Fig 6.2 Photo of Liquid Height for Body SAR

The following table gives the recipes for tissue simulating liquid.

Frequency (MHz)	Water (%)	Sugar (%)	Cellulose (%)	Salt (%)	Preventol (%)	DGBE (%)	Conductivity (σ)	Permittivity (ϵ_r)
For Body								
750	51.7	47.2	0	0.9	0.1	0	0.96	55.5
835	50.8	48.2	0	0.9	0.1	0	0.97	55.2
900	50.8	48.2	0	0.9	0.1	0	1.05	55.0
1800, 1900, 2000	70.2	0	0	0.4	0	29.4	1.52	53.3
2450	68.6	0	0	0	0	31.4	1.95	52.7

Table 6.1 Recipes of Tissue Simulating Liquid

Simulating Liquid for 5G, Manufactured by SPEAG

Ingredients	(% by weight)
Water	64~78%
Mineral oil	11~18%
Emulsifiers	9~15%
Additives and Salt	2~3%



The dielectric parameters of the liquids were verified prior to the SAR evaluation using an Agilent 85070D Dielectric Probe Kit and an Agilent Network Analyzer.

The following table shows the measuring results for simulating liquid.

Frequency (MHz)	Liquid Type	Liquid Temp. (°C)	Conductivity (σ)	Permittivity (ϵ_r)	Conductivity Target (σ)	Permittivity Target (ϵ_r)	Delta (σ) (%)	Delta (ϵ_r) (%)	Limit (%)	Date
835	Body	21.7	0.996	55.38	0.97	55.2	2.68	0.33	±5	Apr. 24, 2013
835	Body	21.5	0.963	54.498	0.97	55.2	-0.72	-1.27	±5	Apr. 26, 2013
1750	Body	21.5	1.5	52.306	1.52	53.3	-1.32	-1.86	±5	Apr. 24, 2013
1900	Body	21.5	1.53	52.859	1.52	53.3	0.66	-0.83	±5	Apr. 23, 2013

Table 6.2 Measuring Results for Simulating Liquid

7. SAR System Verification

Each DASY system is equipped with one or more system validation kits. These units, together with the predefined measurement procedures within the DASY software, enable the user to conduct the system performance check and system validation. System validation kit includes a dipole, tripod holder to fix it underneath the flat phantom and a corresponding distance holder.

7.1 Purpose of System Performance check

The system performance check verifies that the system operates within its specifications. System and operator errors can be detected and corrected. It is recommended that the system performance check be performed prior to any usage of the system in order to guarantee reproducible results. The system performance check uses normal SAR measurements in a simplified setup with a well characterized source. This setup was selected to give a high sensitivity to all parameters that might fail or vary over time. The system check does not intend to replace the calibration of the components, but indicates situations where the system uncertainty is exceeded due to drift or failure.

7.2 System Setup

In the simplified setup for system evaluation, the EUT is replaced by a calibrated dipole and the power source is replaced by a continuous wave that comes from a signal generator. The calibrated dipole must be placed beneath the flat phantom section of the SAM twin phantom with the correct distance holder. The distance holder should touch the phantom surface with a light pressure at the reference marking and be oriented parallel to the long side of the phantom. The equipment setup is shown below:

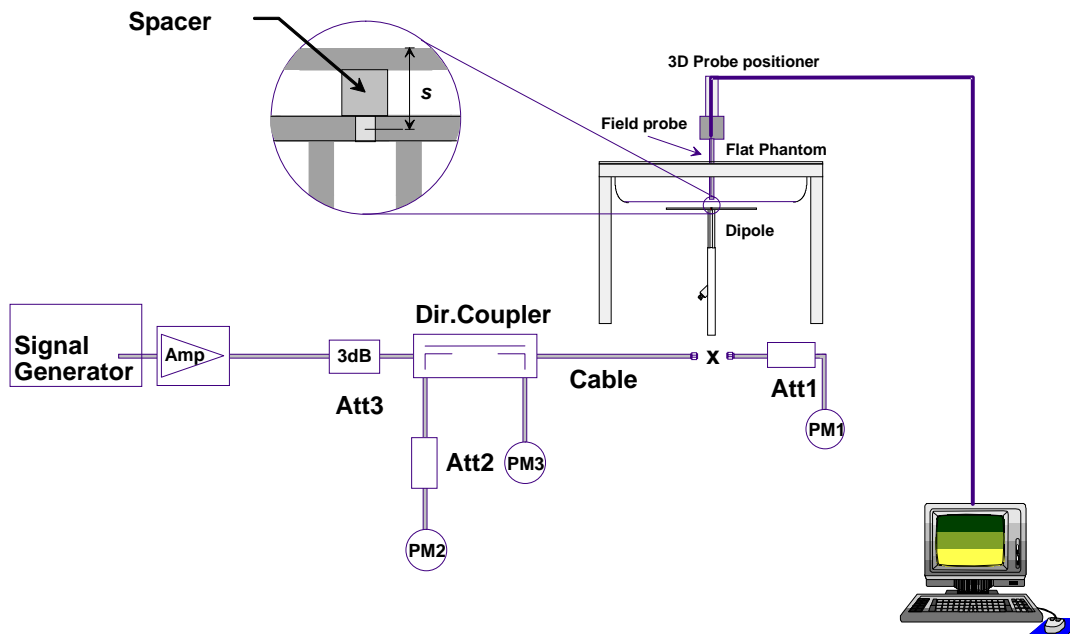

Fig 7.1 System Setup for System Evaluation

1. Signal Generator
2. Amplifier
3. Directional Coupler
4. Power Meter
5. Calibrated Dipole



Fig 7.2 Photo of Dipole Setup

7.3 SAR System Verification Results

Comparing to the original SAR value provided by SPEAG, the verification data should be within its specification of 10 %. Table 7.1 shows the target SAR and measured SAR after normalized to 1W input power. The table below indicates the system performance check can meet the variation criterion and the plots can be referred to Appendix A of this report.

Date	Frequency (MHz)	Liquid Type	Power fed onto reference dipole (mW)	Targeted SAR (W/kg)	Measured SAR (W/kg)	Normalized SAR (W/kg)	Deviation (%)
Apr. 24, 2013	835	Body	250	9.63	2.4	9.6	-0.31
Apr. 26, 2013	835	Body	250	9.63	2.44	9.76	1.35
Apr. 24, 2013	1750	Body	250	36.8	8.97	35.88	-2.50
Apr. 23, 2013	1900	Body	250	40.8	9.85	39.4	-3.43

Table 7.1 Target and Measurement SAR after Normalized



8. EUT Testing Position

This EUT was tested in four different positions. They are bottom-face/Edge 1/Edge2/ Curved surface of Edge1 of tablet PC. In these positions, the surface of EUT is touching with phantom 0cm, and additional 1 cm separation for bottom-face, additional 1.2 cm separation for Edge 1. Please refer to Appendix D for the test setup photos.

9. Measurement Procedures

The measurement procedures are as follows:

<Conducted power measurement>

- (a) For WWAN power measurement, use base station simulator to configure EUT WWAN transmission in conducted connection with RF cable, at maximum power in each supported wireless interface and frequency band.
- (b) Read the WWAN RF power level from the base station simulator.
- (c) For WLAN/BT power measurement, use engineering software to configure EUT WLAN/BT continuously transmission, at maximum RF power in each supported wireless interface and frequency band
- (d) Connect EUT RF port through RF cable to the power meter, and measure WLAN/BT output power

<SAR measurement>

- (a) Use base station simulator to configure EUT WWAN transmission in radiated connection, and engineering software to configure EUT WLAN/BT continuously transmission, at maximum RF power, in the highest power channel.
- (b) Place the EUT in the positions as Appendix D demonstrates.
- (c) Set scan area, grid size and other setting on the DASY software.
- (d) Measure SAR results for the highest power channel on each testing position.
- (e) Find out the largest SAR result on these testing positions of each band
- (f) Measure SAR results for other channels in worst SAR testing position if the reported SAR of highest power channel is larger than 0.8 W/kg

According to the test standard, the recommended procedure for assessing the peak spatial-average SAR value consists of the following steps:

- (a) Power reference measurement
- (b) Area scan
- (c) Zoom scan
- (d) Power drift measurement

9.1 Spatial Peak SAR Evaluation

The procedure for spatial peak SAR evaluation has been implemented according to the test standard. It can be conducted for 1g and 10g, as well as for user-specific masses. The DASY software includes all numerical procedures necessary to evaluate the spatial peak SAR value.

The base for the evaluation is a "cube" measurement. The measured volume must include the 1g and 10g cubes with the highest averaged SAR values. For that purpose, the center of the measured volume is aligned to the interpolated peak SAR value of a previously performed area scan.

The entire evaluation of the spatial peak values is performed within the post-processing engine (SEMCAD). The system always gives the maximum values for the 1g and 10g cubes. The algorithm to find the cube with highest averaged SAR is divided into the following stages:

- (a) Extraction of the measured data (grid and values) from the Zoom Scan
- (b) Calculation of the SAR value at every measurement point based on all stored data (A/D values and measurement parameters)
- (c) Generation of a high-resolution mesh within the measured volume
- (d) Interpolation of all measured values from the measurement grid to the high-resolution grid
- (e) Extrapolation of the entire 3-D field distribution to the phantom surface over the distance from sensor to surface
- (f) Calculation of the averaged SAR within masses of 1g and 10g

9.2 Power Reference Measurement

The Power Reference Measurement and Power Drift Measurements are for monitoring the power drift of the device under test in the batch process. The minimum distance of probe sensors to surface determines the closest measurement point to phantom surface. This distance cannot be smaller than the distance of sensor calibration points to probe tip as defined in the probe properties.

9.3 Area & Zoom Scan Procedures

First Area Scan is used to locate the approximate location(s) of the local peak SAR value(s). The measurement grid within an Area Scan is defined by the grid extent, grid step size and grid offset. Next, in order to determine the EM field distribution in a three-dimensional spatial extension, Zoom Scan is required. The Zoom Scan is performed around the highest E-field value to determine the averaged SAR-distribution over 10 g. Area scan and zoom scan resolution setting follows KDB 865664 D01v01 quoted below.

For any secondary peaks found in the area scan which are within 2 dB of the maximum peak and are not within this zoom scan, the zoom scan should be repeated

		≤ 3 GHz	> 3 GHz
Maximum distance from closest measurement point (geometric center of probe sensors) to phantom surface		5 ± 1 mm	½·δ·ln(2) ± 0.5 mm
Maximum probe angle from probe axis to phantom surface normal at the measurement location		30° ± 1°	20° ± 1°
Maximum area scan spatial resolution: Δx _{Area} , Δy _{Area}		≤ 2 GHz: ≤ 15 mm 2 – 3 GHz: ≤ 12 mm	3 – 4 GHz: ≤ 12 mm 4 – 6 GHz: ≤ 10 mm
		When the x or y dimension of the test device, in the measurement plane orientation, is smaller than the above, the measurement resolution must be ≤ the corresponding x or y dimension of the test device with at least one measurement point on the test device.	
Maximum zoom scan spatial resolution: Δx _{Zoom} , Δy _{Zoom}		≤ 2 GHz: ≤ 8 mm 2 – 3 GHz: ≤ 5 mm*	3 – 4 GHz: ≤ 5 mm* 4 – 6 GHz: ≤ 4 mm*
Maximum zoom scan spatial resolution, normal to phantom surface	uniform grid: Δz _{Zoom(n)}	≤ 5 mm	3 – 4 GHz: ≤ 4 mm 4 – 5 GHz: ≤ 3 mm 5 – 6 GHz: ≤ 2 mm
	graded grid Δz _{Zoom(1)} : between 1 st two points closest to phantom surface	≤ 4 mm	3 – 4 GHz: ≤ 3 mm 4 – 5 GHz: ≤ 2.5 mm 5 – 6 GHz: ≤ 2 mm
	Δz _{Zoom(n>1)} : between subsequent points	≤ 1.5·Δz _{Zoom(n-1)}	
Minimum zoom scan volume	x, y, z	≥ 30 mm	3 – 4 GHz: ≥ 28 mm 4 – 5 GHz: ≥ 25 mm 5 – 6 GHz: ≥ 22 mm
Note: δ is the penetration depth of a plane-wave at normal incidence to the tissue medium; see draft standard IEEE P1528-2011 for details. * When zoom scan is required and the <i>reported</i> SAR from the area scan based <i>1-g SAR estimation</i> procedures of KDB 447498 is ≤ 1.4 W/kg, ≤ 8 mm, ≤ 7 mm and ≤ 5 mm zoom scan resolution may be applied, respectively, for 2 GHz to 3 GHz, 3 GHz to 4 GHz and 4 GHz to 6 GHz.			



9.4 Volume Scan Procedures

The volume scan is used for assess overlapping SAR distributions for antennas transmitting in different frequency bands. It is equivalent to an oversized zoom scan used in standalone measurements. The measurement volume will be used to enclose all the simultaneous transmitting antennas. For antennas transmitting simultaneously in different frequency bands, the volume scan is measured separately in each frequency band. In order to sum correctly to compute the 1g aggregate SAR, the EUT remain in the same test position for all measurements and all volume scan use the same spatial resolution and grid spacing. When all volume scan were completed, the software, SEMCAD postprocessor can combine and subsequently superpose these measurement data to calculating the multiband SAR.

9.5 SAR Averaged Methods

In DASYS, the interpolation and extrapolation are both based on the modified Quadratic Shepard's method. The interpolation scheme combines a least-square fitted function method and a weighted average method which are the two basic types of computational interpolation and approximation.

Extrapolation routines are used to obtain SAR values between the lowest measurement points and the inner phantom surface. The extrapolation distance is determined by the surface detection distance and the probe sensor offset. The uncertainty increases with the extrapolation distance. To keep the uncertainty within 1% for the 1 g and 10 g cubes, the extrapolation distance should not be larger than 5 mm.

9.6 Power Drift Monitoring

All SAR testing is under the EUT install full charged battery and transmit maximum output power. In DASYS measurement software, the power reference measurement and power drift measurement procedures are used for monitoring the power drift of EUT during SAR test. Both these procedures measure the field at a specified reference position before and after the SAR testing. The software will calculate the field difference in dB. If the power drifts more than 5%, the SAR will be retested.

10. Conducted RF Output Power (Unit: dBm)

<GSM Conducted Power>

Note:

1. Per KDB 941225 D03, for Body SAR testing, the EUT operating without power back-off was set in GPRS(4 Tx slots) and the EUT operating with power back-off was set in GPRS(4 Tx slots), due to its highest frame-average power.
2. Per KDB 447498 D01v05, the maximum output power channel is used for SAR testing and for further SAR test reduction.

Maximum Average RF Power (Proximity Sensor Inactive)

Band GSM850	Burst Average Power (dBm)			Frame-Average Power (dBm)		
	TX Channel	128	189	251	128	189
Frequency (MHz)	824.2	836.4	848.8	824.2	836.4	848.8
GPRS (GMSK, 1 Tx slot) – CS1	31.52	31.58	31.68	22.52	22.58	22.68
GPRS (GMSK, 2 Tx slots) – CS1	29.24	29.29	29.37	23.24	23.29	23.37
GPRS (GMSK, 3 Tx slots) – CS1	27.69	27.79	27.89	23.43	23.53	23.63
GPRS (GMSK, 4 Tx slots) – CS1	26.60	26.66	26.73	23.60	23.66	23.73
EDGE (GMSK, 1 Tx slot) – MCS1	31.51	31.57	31.65	22.51	22.57	22.65
EDGE (GMSK, 2 Tx slots) – MCS1	29.26	29.28	29.36	23.26	23.28	23.36
EDGE (GMSK, 3 Tx slots) – MCS1	27.74	27.81	27.79	23.48	23.55	23.53
EDGE (GMSK, 4 Tx slots) – MCS1	26.59	26.65	26.72	23.59	23.65	23.72
EDGE (8PSK, 1 Tx slot) – MCS5	26.06	26.11	26.21	17.06	17.11	17.21
EDGE (8PSK, 2 Tx slots) – MCS5	23.53	23.60	23.68	17.53	17.60	17.68
EDGE (8PSK, 3 Tx slots) – MCS5	22.06	22.13	22.21	17.80	17.87	17.95
EDGE (8PSK, 4 Tx slots) – MCS5	20.58	20.63	20.73	17.58	17.63	17.73

Remark: The frame-averaged power is linearly scaled the maximum burst averaged power over 8 time slots.

The calculated method are shown as below:

Frame-averaged power = Maximum burst averaged power (1 Tx Slot) - 9 dB

Frame-averaged power = Maximum burst averaged power (2 Tx Slots) - 6 dB

Frame-averaged power = Maximum burst averaged power (3 Tx Slots) - 4.26 dB

Frame-averaged power = Maximum burst averaged power (4 Tx Slots) - 3 dB

Maximum Average RF Power (Proximity Sensor Inactive)

Band GSM1900	Burst Average Power (dBm)			Frame-Average Power (dBm)		
	TX Channel	512	661	810	512	661
Frequency (MHz)	1850.2	1880	1909.8	1850.2	1880	1909.8
GPRS (GMSK, 1 Tx slot) – CS1	28.68	28.59	28.54	19.68	19.59	19.54
GPRS (GMSK, 2 Tx slots) – CS1	26.18	26.10	26.06	20.18	20.10	20.06
GPRS (GMSK, 3 Tx slots) – CS1	24.67	24.59	24.55	20.41	20.33	20.29
GPRS (GMSK, 4 Tx slots) – CS1	23.48	23.39	23.35	20.48	20.39	20.35
EDGE (GMSK, 1 Tx slot) – MCS1	28.67	28.57	28.53	19.67	19.57	19.53
EDGE (GMSK, 2 Tx slots) – MCS1	26.17	26.05	26.06	20.17	20.05	20.06
EDGE (GMSK, 3 Tx slots) – MCS1	24.65	24.60	24.56	20.39	20.34	20.30
EDGE (GMSK, 4 Tx slots) – MCS1	23.47	23.38	23.34	20.47	20.38	20.34
EDGE (8PSK, 1 Tx slot) – MCS5	25.03	25.02	25.00	16.03	16.02	16.00
EDGE (8PSK, 2 Tx slots) – MCS5	22.61	22.51	22.50	16.61	16.51	16.50
EDGE (8PSK, 3 Tx slots) – MCS5	21.16	21.07	21.00	16.90	16.81	16.74
EDGE (8PSK, 4 Tx slots) – MCS5	19.66	19.57	19.51	16.66	16.57	16.51

Remark: The frame-averaged power is linearly scaled the maximum burst averaged power over 8 time slots.

The calculated method are shown as below:

Frame-averaged power = Maximum burst averaged power (1 Tx Slot) - 9 dB

Frame-averaged power = Maximum burst averaged power (2 Tx Slots) - 6 dB

Frame-averaged power = Maximum burst averaged power (3 Tx Slots) - 4.26 dB

Frame-averaged power = Maximum burst averaged power (4 Tx Slots) - 3 dB



Reduced Average RF Power (Proximity Sensor active)

Band GSM850 TX Channel	Burst Average Power (dBm)			Frame-Average Power (dBm)		
	128	189	251	128	189	251
Frequency (MHz)	824.2	836.4	848.8	824.2	836.4	848.8
GPRS (GMSK, 1 Tx slot) – CS1	28.77	28.84	28.91	19.77	19.84	19.91
GPRS (GMSK, 2 Tx slots) – CS1	25.87	25.93	26.02	19.87	19.93	20.02
GPRS (GMSK, 3 Tx slots) – CS1	23.91	23.97	24.05	19.65	19.71	19.79
GPRS (GMSK, 4 Tx slots) – CS1	22.98	23.03	23.12	19.98	20.03	20.12
EDGE (GMSK, 1 Tx slot) – MCS1	28.76	28.82	28.90	19.76	19.82	19.90
EDGE (GMSK, 2 Tx slots) – MCS1	25.87	25.93	26.01	19.87	19.93	20.01
EDGE (GMSK, 3 Tx slots) – MCS1	23.90	23.97	24.05	19.64	19.71	19.79
EDGE (GMSK, 4 Tx slots) – MCS1	22.97	23.02	23.11	19.97	20.02	20.11
EDGE (8PSK, 1 Tx slot) – MCS5	24.90	24.96	25.04	15.90	15.96	16.04
EDGE (8PSK, 2 Tx slots) – MCS5	22.05	22.07	22.16	16.05	16.07	16.16
EDGE (8PSK, 3 Tx slots) – MCS5	20.09	20.14	20.21	15.83	15.88	15.95
EDGE (8PSK, 4 Tx slots) – MCS5	19.11	19.16	19.27	16.11	16.16	16.27

Remark: The frame-averaged power is linearly scaled the maximum burst averaged power over 8 time slots.
 The calculated method are shown as below:
 Frame-averaged power = Maximum burst averaged power (1 Tx Slot) - 9 dB
 Frame-averaged power = Maximum burst averaged power (2 Tx Slots) - 6 dB
 Frame-averaged power = Maximum burst averaged power (3 Tx Slots) - 4.26 dB
 Frame-averaged power = Maximum burst averaged power (4 Tx Slots) - 3 dB

Reduced Average RF Power (Proximity Sensor Inactive)

Band GSM1900 TX Channel	Burst Average Power (dBm)			Frame-Average Power (dBm)		
	512	661	810	512	661	810
Frequency (MHz)	1850.2	1880	1909.8	1850.2	1880	1909.8
GPRS (GMSK, 1 Tx slot) – CS1	25.49	25.46	25.48	16.49	16.46	16.48
GPRS (GMSK, 2 Tx slots) – CS1	22.63	22.53	22.47	16.63	16.53	16.47
GPRS (GMSK, 3 Tx slots) – CS1	20.61	20.52	20.47	16.35	16.26	16.21
GPRS (GMSK, 4 Tx slots) – CS1	19.68	19.58	19.50	16.68	16.58	16.50
EDGE (GMSK, 1 Tx slot) – MCS1	25.62	25.53	25.48	16.62	16.53	16.48
EDGE (GMSK, 2 Tx slots) – MCS1	22.62	22.53	22.47	16.62	16.53	16.47
EDGE (GMSK, 3 Tx slots) – MCS1	20.61	20.52	20.47	16.35	16.26	16.21
EDGE (GMSK, 4 Tx slots) – MCS1	19.67	19.58	19.50	16.67	16.58	16.50
EDGE (8PSK, 1 Tx slot) – MCS5	25.02	24.92	24.85	16.02	15.92	15.85
EDGE (8PSK, 2 Tx slots) – MCS5	22.05	21.94	21.88	16.05	15.94	15.88
EDGE (8PSK, 3 Tx slots) – MCS5	20.02	19.92	19.84	15.76	15.66	15.58
EDGE (8PSK, 4 Tx slots) – MCS5	19.04	18.94	18.89	16.04	15.94	15.89

Remark: The frame-averaged power is linearly scaled the maximum burst averaged power over 8 time slots.
 The calculated method are shown as below:
 Frame-averaged power = Maximum burst averaged power (1 Tx Slot) - 9 dB
 Frame-averaged power = Maximum burst averaged power (2 Tx Slots) - 6 dB
 Frame-averaged power = Maximum burst averaged power (3 Tx Slots) - 4.26 dB
 Frame-averaged power = Maximum burst averaged power (4 Tx Slots) - 3 dB

<WCDMA Conducted Power>

The following tests were conducted according to the test requirements outlines in 3GPP TS 34.121 specification.

A summary of these settings are illustrated below:

HSDPA Setup Configuration:

- a. The EUT was connected to Base Station Agilent E5515C referred to the Setup Configuration.
- b. The RF path losses were compensated into the measurements.
- c. A call was established between EUT and Base Station with following setting:
 - i. Set Gain Factors (β_c and β_d) and parameters were set according to each
 - ii. Specific sub-test in the following table, C10.1.4, quoted from the TS 34.121
 - iii. Set RMC 12.2Kbps + HSDPA mode.
 - iv. Set Cell Power = -86 dBm
 - v. Set HS-DSCH Configuration Type to FRC (H-set 1, QPSK)
 - vi. Select HSDPA Uplink Parameters
 - vii. Set Delta ACK, Delta NACK and Delta CQI = 8
 - viii. Set Ack-Nack Repetition Factor to 3
 - ix. Set CQI Feedback Cycle (k) to 4 ms
 - x. Set CQI Repetition Factor to 2
 - xi. Power Ctrl Mode = All Up bits
- d. The transmitted maximum output power was recorded.

Table C.10.1.4: β values for transmitter characteristics tests with HS-DPCCH

Sub-test	β_c	β_d	β_d (SF)	β_c/β_d	β_{HS} (Note 1, Note 2)	CM (dB) (Note 3)	MPR (dB) (Note 3)
1	2/15	15/15	64	2/15	4/15	0.0	0.0
2	12/15 (Note 4)	15/15 (Note 4)	64	12/15 (Note 4)	24/15	1.0	0.0
3	15/15	8/15	64	15/8	30/15	1.5	0.5
4	15/15	4/15	64	15/4	30/15	1.5	0.5

Note 1: $\Delta_{ACK}, \Delta_{NACK}$ and $\Delta_{CQI} = 30/15$ with $\beta_{HS} = 30/15 * \beta_c$.

Note 2: For the HS-DPCCH power mask requirement test in clause 5.2C, 5.7A, and the Error Vector Magnitude (EVM) with HS-DPCCH test in clause 5.13.1A, and HSDPA EVM with phase discontinuity in clause 5.13.1AA, Δ_{ACK} and $\Delta_{NACK} = 30/15$ with $\beta_{HS} = 30/15 * \beta_c$, and $\Delta_{CQI} = 24/15$ with $\beta_{HS} = 24/15 * \beta_c$.

Note 3: CM = 1 for $\beta_c/\beta_d = 12/15, \beta_{HS}/\beta_c = 24/15$. For all other combinations of DPDCH, DPCCH and HS-DPCCH the MPR is based on the relative CM difference. This is applicable for only UEs that support HSDPA in release 6 and later releases.

Note 4: For subtest 2 the β_c/β_d ratio of 12/15 for the TFC during the measurement period (TF1, TF0) is achieved by setting the signalled gain factors for the reference TFC (TF1, TF1) to $\beta_c = 11/15$ and $\beta_d = 15/15$.

Setup Configuration

HSUPA Setup Configuration:

- a. The EUT was connected to Base Station Agilent E5515C referred to the Setup Configuration.
- b. The RF path losses were compensated into the measurements.
- c. A call was established between EUT and Base Station with following setting * :
 - i. Call Configs = 5.2B, 5.9B, 5.10B, and 5.13.2B with QPSK
 - ii. Set the Gain Factors (β_c and β_d) and parameters (AG Index) were set according to each specific sub-test in the following table, C11.1.3, quoted from the TS 34.121
 - iii. Set Cell Power = -86 dBm
 - iv. Set Channel Type = 12.2k + HSPA
 - v. Set UE Target Power
 - vi. Power Ctrl Mode= Alternating bits
 - vii. Set and observe the E-TFCl
 - viii. Confirm that E-TFCl is equal to the target E-TFCl of 75 for sub-test 1, and other subtest's E-TFCl
- d. The transmitted maximum output power was recorded.

Table C.11.1.3: β values for transmitter characteristics tests with HS-DPCCH and E-DCH

Sub-test	β_c	β_d	β_d (SF)	β_c/β_d	β_{HS} (Note 1)	β_{ec}	β_{ed} (Note 5) (Note 6)	β_{ed} (SF)	β_{ed} (Codes)	CM (dB) (Note 2)	MPR (dB) (Note 2)	AG Index (Note 6)	E-TFCl
1	11/15 (Note 3)	15/15 (Note 3)	64	11/15 (Note 3)	22/15	209/225	1309/225	4	1	1.0	0.0	20	75
2	6/15	15/15	64	6/15	12/15	12/15	94/75	4	1	3.0	2.0	12	67
3	15/15	9/15	64	15/9	30/15	30/15	$\beta_{ed1}: 47/15$ $\beta_{ed2}: 47/15$	4	2	2.0	1.0	15	92
4	2/15	15/15	64	2/15	4/15	2/15	56/75	4	1	3.0	2.0	17	71
5	15/15 (Note 4)	15/15 (Note 4)	64	15/15 (Note 4)	30/15	24/15	134/15	4	1	1.0	0.0	21	81

Note 1: $\Delta_{ACK}, \Delta_{NACK}$ and $\Delta_{CQI} = 30/15$ with $\beta_{hs} = 30/15 * \beta_c$.

Note 2: CM = 1 for $\beta_c/\beta_d = 12/15, \beta_{hs}/\beta_c = 24/15$. For all other combinations of DPDCH, DPCCH, HS- DPCCH, E-DPDCH and E-DPCCH the MPR is based on the relative CM difference.

Note 3: For subtest 1 the β_c/β_d ratio of 11/15 for the TFC during the measurement period (TF1, TF0) is achieved by setting the signalled gain factors for the reference TFC (TF1, TF1) to $\beta_c = 10/15$ and $\beta_d = 15/15$.

Note 4: For subtest 5 the β_c/β_d ratio of 15/15 for the TFC during the measurement period (TF1, TF0) is achieved by setting the signalled gain factors for the reference TFC (TF1, TF1) to $\beta_c = 14/15$ and $\beta_d = 15/15$.

Note 5: In case of testing by UE using E-DPDCH Physical Layer category 1, Sub-test 3 is omitted according to TS25.306 Table 5.1g.

Note 6: β_{ed} can not be set directly, it is set by Absolute Grant Value.

Setup Configuration



Note:

1. Applying the subtest setup in Table C.11.1.3 of 3GPP TS 34.121-1 V9.1.0 to Rel. 6 HSPA.
2. By design, HSDPA/HSUPA RF power will not be larger than RMC 12.2kbps.

Maximum Average RF Power (Proximity Sensor Inactive)

Band		WCDMA V			WCDMA II			WCDMA IV		
TX Channel		4132	4182	4233	9262	9400	9538	1312	1413	1513
Frequency (MHz)		826.4	836.4	846.6	1852.4	1880	1907.6	1712.4	1732.6	1752.6
3GPP Rel 99	RMC 12.2Kbps	23.33	23.09	22.88	23.00	23.13	22.85	23.12	22.93	22.88
3GPP Rel 6	HSDPA Subtest-1	23.10	22.92	22.72	22.63	22.88	22.60	22.89	22.66	22.57
3GPP Rel 6	HSDPA Subtest-2	22.15	21.86	21.69	21.63	21.80	21.62	21.91	21.78	21.79
3GPP Rel 6	HSDPA Subtest-3	21.88	21.60	21.40	21.46	21.55	21.42	21.64	21.44	21.41
3GPP Rel 6	HSDPA Subtest-4	21.68	21.31	21.17	21.21	21.33	21.18	21.40	21.19	21.16
3GPP Rel 6	HSUPA Subtest-1	22.15	21.87	21.65	21.83	21.89	21.71	21.93	21.81	21.70
3GPP Rel 6	HSUPA Subtest-2	20.13	19.71	19.82	19.72	20.04	19.55	20.05	19.84	19.81
3GPP Rel 6	HSUPA Subtest-3	20.92	20.68	20.51	20.55	20.74	20.58	20.72	20.61	20.59
3GPP Rel 6	HSUPA Subtest-4	20.49	20.23	20.19	19.83	19.90	19.79	20.11	19.66	19.68
3GPP Rel 6	HSUPA Subtest-5	22.11	21.74	21.54	21.60	21.78	21.65	21.81	21.84	21.85
3GPP MPR specification	MPR result	WCDMA V			WCDMA II			WCDMA IV		
0	HSDPA Subtest-1	0.00	0.00	0.00	0.00	0.00	0.00	0.00	0.00	0.00
0	HSDPA Subtest-2	0.95	1.06	1.03	1.00	1.08	0.98	0.98	0.88	0.78
≤0.5	HSDPA Subtest-3	1.22	1.32	1.32	1.17	1.33	1.18	1.25	1.22	1.16
≤0.5	HSDPA Subtest-4	1.42	1.61	1.55	1.42	1.55	1.42	1.49	1.47	1.41
≤0	HSUPA Subtest-1	-0.04	-0.13	-0.11	-0.23	-0.11	-0.06	-0.12	0.03	0.15
≤2	HSUPA Subtest-2	1.98	2.03	1.72	1.88	1.74	2.10	1.76	2.00	2.04
≤1	HSUPA Subtest-3	1.19	1.06	1.03	1.05	1.04	1.07	1.09	1.23	1.26
≤2	HSUPA Subtest-4	1.62	1.51	1.35	1.77	1.88	1.86	1.70	2.18	2.17
≤0	HSUPA Subtest-5	0.00	0.00	0.00	0.00	0.00	0.00	0.00	0.00	0.00

Reduced Average RF Power (Proximity Sensor Inactive)

Band		WCDMA V			WCDMA II			WCDMA IV		
TX Channel		4132	4182	4233	9262	9400	9538	1312	1413	1513
Frequency (MHz)		826.4	836.4	846.6	1852.4	1880	1907.6	1712.4	1732.6	1752.6
3GPP Rel 99	RMC 12.2Kbps	19.87	19.62	19.51	15.80	15.98	15.76	14.68	14.52	14.57
3GPP Rel 6	HSDPA Subtest-1	19.81	19.56	19.46	15.50	15.81	15.72	14.55	14.43	14.40
3GPP Rel 6	HSDPA Subtest-2	19.82	19.61	19.45	15.48	15.79	15.52	14.60	14.50	14.42
3GPP Rel 6	HSDPA Subtest-3	19.86	19.60	19.42	15.52	15.73	15.55	14.65	14.44	14.55
3GPP Rel 6	HSDPA Subtest-4	19.85	19.59	19.43	15.50	15.70	15.54	14.61	14.50	14.52
3GPP Rel 6	HSUPA Subtest-1	19.34	19.27	19.22	15.24	15.38	15.22	14.24	14.14	14.25
3GPP Rel 6	HSUPA Subtest-2	19.25	19.19	19.18	15.19	15.28	15.17	14.21	14.13	14.22
3GPP Rel 6	HSUPA Subtest-3	19.20	19.04	19.10	15.20	15.30	15.20	14.18	14.12	14.21
3GPP Rel 6	HSUPA Subtest-4	19.24	19.18	19.15	15.18	15.25	15.16	14.22	14.10	14.23
3GPP Rel 6	HSUPA Subtest-5	19.75	19.61	19.53	15.53	15.72	15.63	14.61	14.49	14.42
3GPP MPR specification	MPR result	WCDMA V			WCDMA II			WCDMA IV		
0	HSDPA Subtest-1	0.00	0.00	0.00	0.00	0.00	0.00	0.00	0.00	0.00
0	HSDPA Subtest-2	-0.01	-0.05	0.01	0.02	0.02	0.20	-0.05	-0.07	-0.02
≤0.5	HSDPA Subtest-3	-0.05	-0.04	0.04	-0.02	0.08	0.17	-0.10	-0.01	-0.15
≤0.5	HSDPA Subtest-4	-0.04	-0.03	0.03	0.00	0.11	0.18	-0.06	-0.07	-0.12
≤0	HSUPA Subtest-1	0.41	0.34	0.31	0.29	0.34	0.41	0.37	0.35	0.17
≤2	HSUPA Subtest-2	0.50	0.42	0.35	0.34	0.44	0.46	0.40	0.36	0.20
≤1	HSUPA Subtest-3	0.55	0.57	0.43	0.33	0.42	0.43	0.43	0.37	0.21
≤2	HSUPA Subtest-4	0.51	0.43	0.38	0.35	0.47	0.47	0.39	0.39	0.19
≤0	HSUPA Subtest-5	0.00	0.00	0.00	0.00	0.00	0.00	0.00	0.00	0.00

11. Exposure Positions Consideration

<Tablet PC>

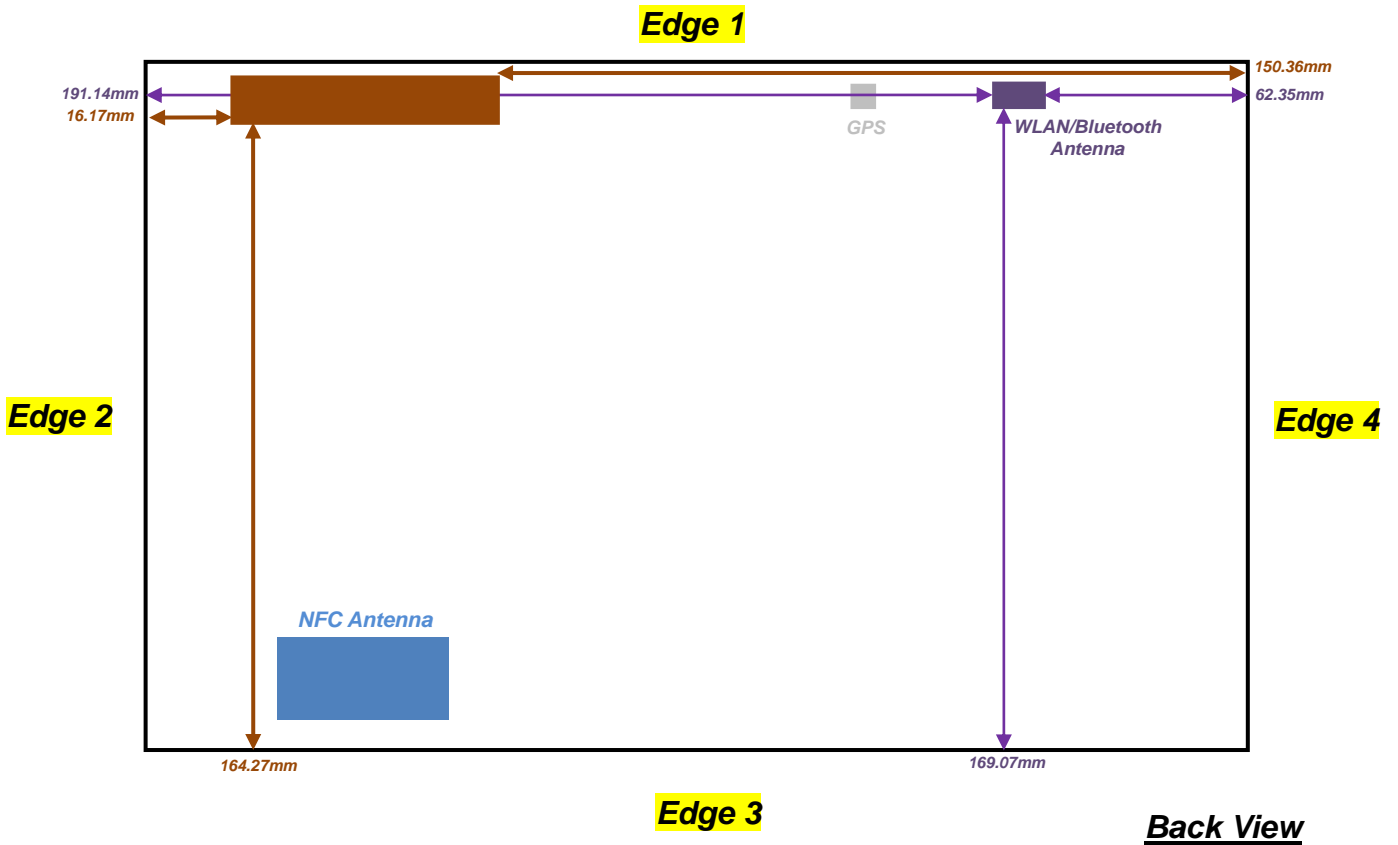

<Laptop Mode>

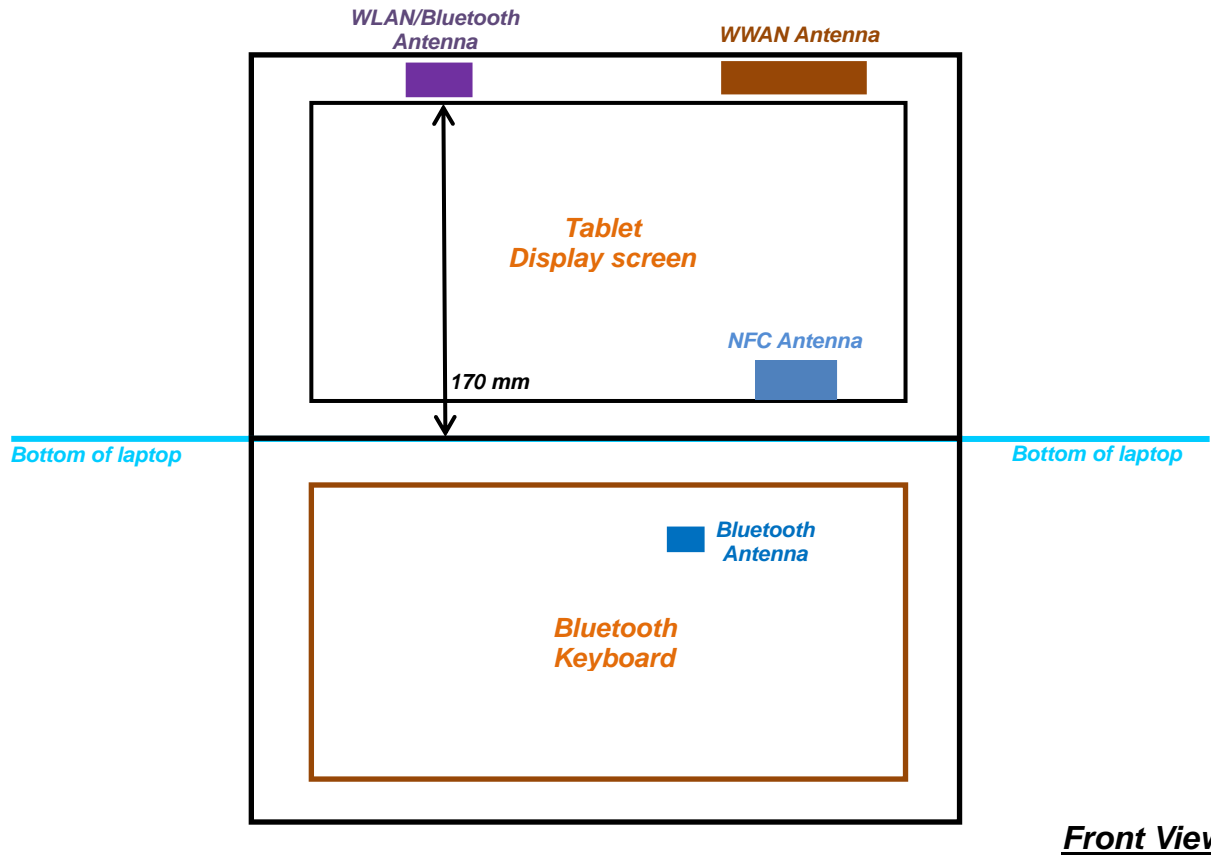

Front View



General Note:

- Bluetooth keyboard cover will combination with this host. Max Bluetooth Average Power is -2.18dBm refer to FCC ID: O62U68B, Report No. FR341228.
- Per KDB 447498 D01v05, for larger devices, the *test separation distance* is determined by the closest separation between the antenna and the user.
- Per KDB 447498 D01v05, standalone SAR test exclusion threshold is applied; If the distance of the antenna to the user is < 5mm, 5mm is used to determine SAR exclusion threshold
- Per KDB 447498 D01v05, the 1-g and 10-g SAR test exclusion thresholds for 100 MHz to 6 GHz at *test separation distances* ≤ 50 mm are determined by:

$$[(\text{max. power of channel, including tune-up tolerance, mW}) / (\text{min. test separation distance, mm})] \cdot [\sqrt{f(\text{GHz})}] \leq 3.0$$
 for 1-g SAR and ≤ 7.5 for 10-g extremity SAR
 - f(GHz) is the RF channel transmit frequency in GHz
 - Power and distance are rounded to the nearest mW and mm before calculation
 - The result is rounded to one decimal place for comparison
- Per KDB 447498 D01v05, at 100 MHz to 6 GHz and for *test separation distances* > 50 mm, the SAR test exclusion threshold is determined according to the following
 - [Threshold at 50 mm in step 1) + (test separation distance - 50 mm) · (f(MHz)/150)] mW, at 100 MHz to 1500 MHz
 - [Threshold at 50 mm in step 1) + (test separation distance - 50 mm) · 10] mW at > 1500 MHz and ≤ 6 GHz

<SAR test exclusion of Tablet PC>

Exposure Position	Wireless Interface	GPRS850 Class 10	GPRS1900 Class 10	WCDMA Band V	WCDMA Band IV	WCDMA Band II
		Tune-up Maximum power	25	22	24.5	24.5
	Tune-up Maximum rated power(mW)	316.23	158.49	281.84	281.84	281.84
Bottom Face	Antenna to user (mm)	5				
	SAR exclusion threshold	58.24	43.8	51.85	74.57	77.84
	SAR testing required?	Yes	Yes	Yes	Yes	Yes
Edge 1	Antenna to user (mm)	5				
	SAR exclusion threshold	58.24	43.8	51.85	74.57	77.84
	SAR testing required?	Yes	Yes	Yes	Yes	Yes
Edge 2	Antenna to user (mm)	16.17				
	SAR exclusion threshold	18.01	13.54	16.03	23.06	24.07
	SAR testing required?	Yes	Yes	Yes	Yes	Yes
Edge 3	Antenna to user (mm)	164.27				
	SAR exclusion threshold	808.90	1251.26	807.56	1256.09	1251.32
	SAR testing required?	No	No	No	No	No
Edge 4	Antenna to user (mm)	150.36				
	SAR exclusion threshold	730.26	1112.16	729.11	1116.99	1112.22
	SAR testing required?	No	No	No	No	No

<SAR test exclusion of Laptop>

Exposure Position	Wireless Interface	Tablet PC					Keyboard
		GPRS850 Class 10	GPRS1900 Class 10	WCDMA Band V	WCDMA Band IV	WCDMA Band II	Bluetooth
	Tune-up Maximum power	25	22	24.5	24.5	24.5	-2.18
	Tune-up Maximum rated power(mW)	316.23	158.49	281.84	281.84	281.84	0.61
Bottom	Antenna to user (mm)	170					5
	SAR exclusion threshold	841.29	1308.56	839.88	1313.39	1308.62	0.19
	SAR testing required?	No	No	No	No	No	NO



12. SAR Test Results

General Note:

- Per KDB 447498 D01v05, the reported SAR is the measured SAR value adjusted for maximum tune-up tolerance.
 $Scaling\ Factor = \frac{tune-up\ limit\ power\ (mW)}{EUT\ RF\ power\ (mW)}$, where tune-up limit is the maximum rated power among all production units.
 $Reported\ SAR(W/kg) = Measured\ SAR(W/kg) * Scaling\ Factor$
- For the exposure positions that proximity sensor power reduction is applied for SAR compliance, additional SAR testing with EUT transmitting full power in normal mode was performed; 1.0cm for bottom face, 1.2cm for edge1
- Per KDB 941225 D01, RMC 12.2kbps setting is used to evaluate SAR. If HSDPA/HSUPA output power is < 0.25dB higher than RMC, or reported SAR with RMC 12.2kbps setting is $\leq 1.2W/kg$, HSDPA/HSUPA SAR evaluation can be excluded.

12.1 Test Records for Body SAR Test

<GSM SAR>

Plot No.	Band	Mode	Test Position	Gap (cm)	Ch.	Freq. (MHz)	Power Back-off	Average Power (dBm)	Tune-Up Limit (dBm)	Tune-up Scaling Factor	Power Drift (dB)	Measured SAR 1g (W/kg)	Scaled SAR 1g (W/kg)
16	GSM850	GPRS (4 Tx slots)	Bottom Face	1cm	251	848.8	Off	26.73	28	1.340	-0.17	0.375	0.502
17	GSM850	GPRS (4 Tx slots)	Edge 1	1.2cm	251	848.8	Off	26.73	28	1.340	-0.04	0.193	0.259
40	GSM850	GPRS (4 Tx slots)	Edge 2	0cm	251	848.8	Off	26.73	28	1.340	-0.14	0.63	0.844
41	GSM850	GPRS (4 Tx slots)	Edge 2	0cm	128	824.2	Off	26.6	28	1.380	0.03	0.646	0.892
42	GSM850	GPRS (4 Tx slots)	Edge 2	0cm	189	836.4	Off	26.66	28	1.361	-0.03	0.757	1.031
18	GSM850	GPRS (4 Tx slots)	Bottom Face	0cm	251	848.8	On	23.12	24	1.225	-0.04	0.694	0.850
43	GSM850	GPRS (4 Tx slots)	Bottom Face	0cm	128	824.2	On	22.98	24	1.265	-0.07	0.642	0.812
44	GSM850	GPRS (4 Tx slots)	Bottom Face	0cm	189	836.4	On	23.03	24	1.250	-0.05	0.642	0.803
19	GSM850	GPRS (4 Tx slots)	Edge 1	0cm	251	848.8	On	23.12	24	1.225	-0.01	0.457	0.560
20	GSM850	GPRS (4 Tx slots)	Curved surface of Edge1	0cm	251	848.8	On	23.12	24	1.225	0	0.598	0.732
1	GSM1900	GPRS (4 Tx slots)	Bottom Face	1cm	512	1850.2	Off	23.48	25	1.419	-0.07	0.265	0.376
2	GSM1900	GPRS (4 Tx slots)	Edge 1	1.2cm	512	1850.2	Off	23.48	25	1.419	-0.01	0.198	0.281
26	GSM1900	GPRS (4 Tx slots)	Edge2	0cm	512	1850.2	Off	23.48	25	1.419	-0.04	0.347	0.492
3	GSM1900	GPRS (4 Tx slots)	Bottom Face	0cm	512	1850.2	On	19.68	20	1.076	-0.12	0.718	0.773
27	GSM1900	GPRS (4 Tx slots)	Bottom Face	0cm	661	1880	On	19.58	20	1.102	-0.1	0.679	0.748
28	GSM1900	GPRS (4 Tx slots)	Bottom Face	0cm	810	1909.8	On	19.5	20	1.122	-0.13	0.692	0.776
4	GSM1900	GPRS (4 Tx slots)	Edge 1	0cm	512	1850.2	On	19.68	20	1.076	0.02	0.646	0.695
29	GSM1900	GPRS (4 Tx slots)	Edge 1	0cm	661	1880	On	19.58	20	1.102	0.1	0.747	0.823
30	GSM1900	GPRS (4 Tx slots)	Edge 1	0cm	810	1909.8	On	19.5	20	1.122	0	0.78	0.875
5	GSM1900	GPRS (4 Tx slots)	Curved surface of Edge1	0cm	512	1850.2	On	19.68	20	1.076	-0.12	0.815	0.877
31	GSM1900	GPRS (4 Tx slots)	Curved surface of Edge1	0cm	661	1880	On	19.58	20	1.102	-0.15	0.843	0.929
32	GSM1900	GPRS (4 Tx slots)	Curved surface of Edge1	0cm	810	1909.8	On	19.5	20	1.122	-0.11	0.873	0.980



<WCDMA SAR>

Plot No.	Band	Mode	Test Position	Gap (cm)	Ch.	Freq. (MHz)	Power Back-off	Average Power (dBm)	Tune-Up Limit (dBm)	Tune-up Scaling Factor	Power Drift (dB)	Measured SAR 1g (W/kg)	Scaled SAR 1g (W/kg)
21	WCDMA V	RMC 12.2Kbps	Bottom Face	1cm	4132	826.4	Off	23.33	24.5	1.309	0	0.379	0.496
22	WCDMA V	RMC 12.2Kbps	Edge 1	1.2cm	4132	826.4	Off	23.33	24.5	1.309	0.01	0.182	0.238
52	WCDMA V	RMC12.2Kbps	Edge 2	0cm	4132	826.4	Off	23.33	24.5	1.309	-0.07	0.536	0.702
45	WCDMA V	RMC12.2Kbps	Bottom Face	0cm	4132	826.4	On	19.87	21.5	1.455	0	0.687	1.000
46	WCDMA V	RMC12.2Kbps	Bottom Face	0cm	4182	836.4	On	19.62	21.5	1.542	-0.05	0.656	1.011
47	WCDMA V	RMC12.2Kbps	Bottom Face	0cm	4233	846.6	On	19.51	21.5	1.581	-0.04	0.654	1.034
48	WCDMA V	RMC12.2Kbps	Edge 1	0cm	4132	826.4	On	19.87	21.5	1.455	-0.06	0.529	0.770
49	WCDMA V	RMC 12.2Kbps	Curved surface of Edge1	0cm	4132	826.4	On	19.87	21.5	1.455	-0.05	0.581	0.846
50	WCDMA V	RMC 12.2Kbps	Curved surface of Edge1	0cm	4182	836.4	On	19.62	21.5	1.542	-0.02	0.527	0.812
51	WCDMA V	RMC 12.2Kbps	Curved surface of Edge1	0cm	4233	846.6	On	19.51	21.5	1.581	-0.01	0.542	0.857
11	WCDMA IV	RMC 12.2Kbps	Bottom Face	1cm	1312	1712.4	Off	23.12	24.5	1.374	-0.02	0.637	0.875
55	WCDMA IV	RMC 12.2Kbps	Bottom Face	1cm	1413	1732.6	Off	22.93	24.5	1.435	-0.1	0.613	0.880
56	WCDMA IV	RMC 12.2Kbps	Bottom Face	1cm	1513	1752.6	Off	22.88	24.5	1.452	-0.05	0.572	0.831
12	WCDMA IV	RMC 12.2Kbps	Edge 1	1.2cm	1312	1712.4	Off	23.12	24.5	1.374	0.01	0.482	0.662
57	WCDMA IV	RMC 12.2Kbps	Edge 2	0cm	1312	1712.4	Off	23.12	24.5	1.374	-0.02	0.58	0.797
13	WCDMA IV	RMC 12.2Kbps	Bottom Face	0cm	1312	1712.4	On	14.68	16.5	1.521	-0.12	0.547	0.832
53	WCDMA IV	RMC 12.2Kbps	Bottom Face	0cm	1413	1732.6	On	14.52	16.5	1.578	-0.16	0.447	0.705
54	WCDMA IV	RMC 12.2Kbps	Bottom Face	0cm	1513	1752.6	On	14.57	16.5	1.560	-0.14	0.442	0.689
14	WCDMA IV	RMC 12.2Kbps	Edge 1	0cm	1312	1712.4	On	14.68	16.5	1.521	0.06	0.378	0.575
15	WCDMA IV	RMC 12.2Kbps	Curved surface of Edge1	0cm	1312	1712.4	On	14.68	16.5	1.521	-0.1	0.481	0.731
6	WCDMA II	RMC 12.2Kbps	Bottom Face	1cm	9400	1880	Off	23.13	24.5	1.371	0.02	0.58	0.795
7	WCDMA II	RMC 12.2Kbps	Edge 1	1.2cm	9400	1880	Off	23.13	24.5	1.371	-0.02	0.473	0.648
60	WCDMA II	RMC 12.2Kbps	Edge 2	0cm	9400	1880	Off	23.13	24.5	1.371	-0.04	0.707	0.969
61	WCDMA II	RMC 12.2Kbps	Edge 2	0cm	9262	1852.4	Off	23	24.5	1.413	0	0.706	0.997
62	WCDMA II	RMC 12.2Kbps	Edge 2	0cm	9538	1907.6	Off	22.85	24.5	1.462	0	0.62	0.907
8	WCDMA II	RMC 12.2Kbps	Bottom Face	0cm	9400	1880	On	15.98	16.5	1.127	-0.09	0.739	0.833
33	WCDMA II	RMC 12.2Kbps	Bottom Face	0cm	9262	1852.4	On	15.8	16.5	1.175	-0.11	0.68	0.799
34	WCDMA II	RMC 12.2Kbps	Bottom Face	0cm	9538	1907.6	On	15.76	16.5	1.186	-0.11	0.678	0.804
9	WCDMA II	RMC 12.2Kbps	Edge 1	0cm	9400	1880	On	15.98	16.5	1.127	0.07	0.747	0.842
35	WCDMA II	RMC 12.2Kbps	Edge 1	0cm	9262	1852.4	On	15.8	16.5	1.175	0.08	0.641	0.753
36	WCDMA II	RMC 12.2Kbps	Edge 1	0cm	9538	1907.6	On	15.76	16.5	1.186	0.03	0.737	0.874
10	WCDMA II	RMC 12.2Kbps	Curved surface of Edge1	0cm	9400	1880	On	15.98	16.5	1.127	-0.1	0.844	0.951
37	WCDMA II	RMC 12.2Kbps	Curved surface of Edge1	0cm	9262	1852.4	On	15.8	16.5	1.175	-0.13	0.775	0.911
38	WCDMA II	RMC 12.2Kbps	Curved surface of Edge1	0cm	9538	1907.6	On	15.76	16.5	1.186	-0.11	0.83	0.984



12.2 Repeated SAR Measurement

Plot No.	Band	Mode	Test Position	Gap (cm)	Ch.	Freq. (MHz)	Power Back-off	Average Power (dBm)	Tune-Up Limit (dBm)	Tune-up Scaling Factor	Power Drift (dB)	Measured SAR 1g (W/kg)	Ratio	Scaled SAR 1g (W/kg)
32	GSM1900	GPRS (4 Tx slots)	Curved surface of Edge1	0cm	810	1909.8	On	19.5	20	1.122	-0.11	0.873	1	0.980
39	GSM1900	GPRS (4 Tx slots)	Curved surface of Edge1	0cm	810	1909.8	On	19.5	20	1.122	-0.1	0.87	1.01	0.976

Note:

1. Per KDB 865664 D01v01, for each frequency band, repeated SAR measurement is required only when the measured SAR is ≥ 0.8 W/kg
2. Per KDB 865664 D01v01, if the ratio among the repeated measurement is ≤ 1.2 and the measured SAR < 1.45 W/kg, only one repeated measurement is required.
3. The ratio is the difference in percentage between original and repeated *measured* SAR.
4. All measurement SAR result is scaled-up to account for tune-up tolerance and is compliant.

12.3 Highest SAR Plot

Test Laboratory: Sporton International Inc. SAR/HAC Testing Lab

Date: 2013/4/26

#47_WCDMA V_RMC12.2Kbps_Bottom Face_0cm_Ch4233

DUT: 322823-02

Communication System: WCDMA; Frequency: 846.6 MHz; Duty Cycle: 1:1

Medium: MSL_850_130426 Medium parameters used: $f = 847$ MHz; $\sigma = 0.975$ mho/m; $\epsilon_r = 54.378$; $\rho = 1000$ kg/m³

Ambient Temperature : 22.5 °C; Liquid Temperature : 21.5 °C

DASY5 Configuration:

- Probe: ET3DV6 - SN1787; ConvF(6.08, 6.08, 6.08); Calibrated: 2012/5/29;
- Sensor-Surface: 4mm (Mechanical Surface Detection)
- Electronics: DAE4 Sn910; Calibrated: 2012/12/5
- Phantom: ELI v5.0 Left; Type: QDOVA002AA; Serial: TP:1131
- Measurement SW: DASY52, Version 52.8 (3); SEMCAD X Version 14.6.5 (6469)

Configuration/Ch4233/Area Scan (51x91x1): Measurement grid: dx=15mm, dy=15mm
Maximum value of SAR (interpolated) = 0.745 mW/g

Configuration/Ch4233/Zoom Scan (5x5x7)/Cube 0: Measurement grid: dx=8mm, dy=8mm, dz=5mm

Reference Value = 27.779 V/m; Power Drift = -0.04 dB

Peak SAR (extrapolated) = 1.190 mW/g

SAR(1 g) = 0.654 mW/g; SAR(10 g) = 0.370 mW/g

Maximum value of SAR (measured) = 0.695 mW/g

Configuration/Ch4233/Zoom Scan (5x5x7)/Cube 1: Measurement grid: dx=8mm, dy=8mm, dz=5mm

Reference Value = 27.779 V/m; Power Drift = -0.04 dB

Peak SAR (extrapolated) = 0.876 mW/g

SAR(1 g) = 0.454 mW/g; SAR(10 g) = 0.253 mW/g

Maximum value of SAR (measured) = 0.510 mW/g

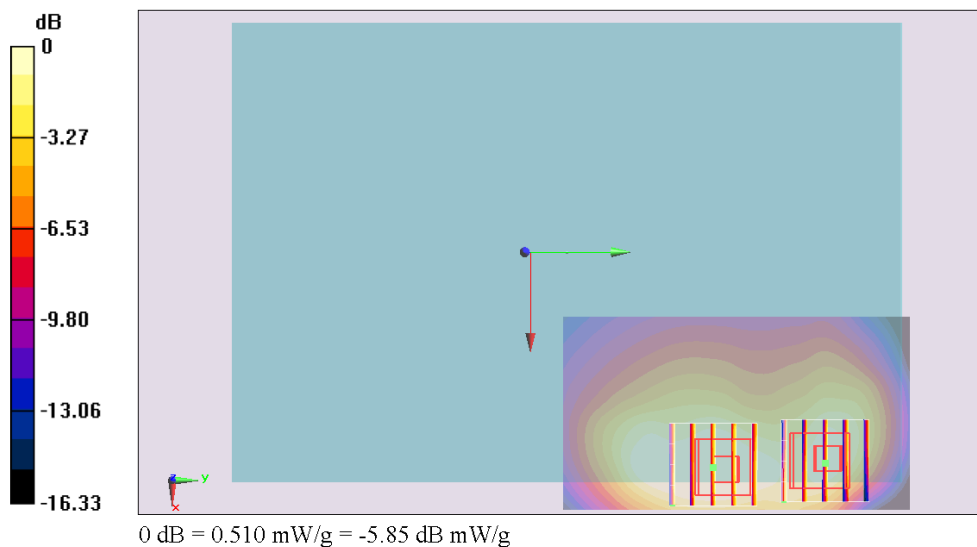

Test Laboratory: Sporton International Inc. SAR/HAC Testing Lab

Date: 2013/4/24

#55_WCDMA IV_RMC 12.2Kbps_Bottom Face_1cm_Ch1413

DUT: 322823-02

Communication System: WCDMA; Frequency: 1732.6 MHz; Duty Cycle: 1:1
 Medium: MSL_1750_130424 Medium parameters used: $f = 1733$ MHz; $\sigma = 1.482$ mho/m; $\epsilon_r = 52.325$; $\rho = 1000$ kg/m³
Ambient Temperature : 22.5 °C ; Liquid Temperature : 21.5 °C

DASY5 Configuration:

- Probe: ET3DV6 - SN1787; ConvF(4.81, 4.81, 4.81); Calibrated: 2012/5/29;
- Sensor-Surface: 4mm (Mechanical Surface Detection)
- Electronics: DAE4 Sn910; Calibrated: 2012/12/5
- Phantom: ELI v4.0; Type: QDOVA001BB; Serial: TP:1127
- Measurement SW: DASY52, Version 52.8 (3); SEMCAD X Version 14.6.5 (6469)

Configuration/Ch1413/Area Scan (51x91x1): Measurement grid: dx=15mm, dy=15mm
 Maximum value of SAR (interpolated) = 0.673 mW/g

Configuration/Ch1413/Zoom Scan (5x5x7)/Cube 0: Measurement grid: dx=8mm, dy=8mm, dz=5mm

Reference Value = 22.779 V/m; Power Drift = -0.10 dB

Peak SAR (extrapolated) = 0.888 mW/g

SAR(1 g) = 0.613 mW/g; SAR(10 g) = 0.383 mW/g

Maximum value of SAR (measured) = 0.645 mW/g

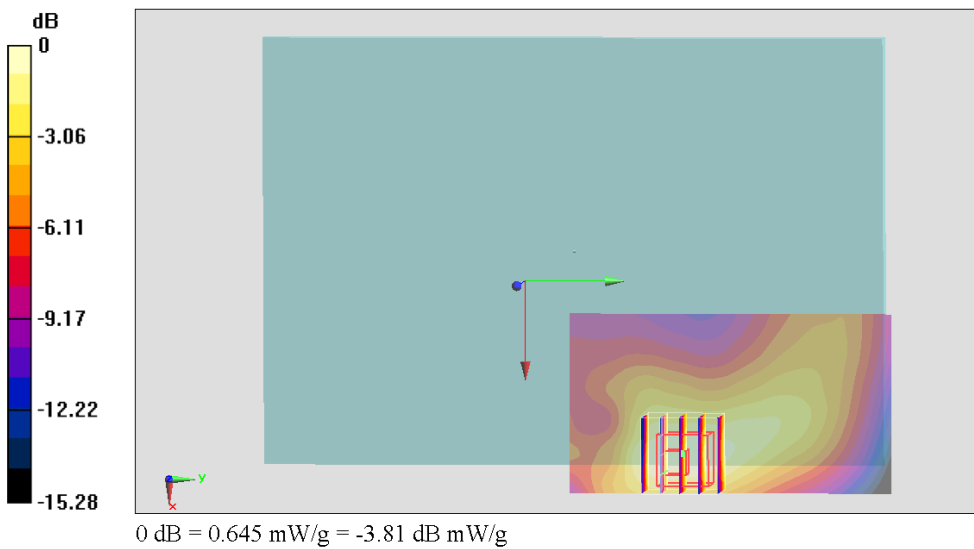

Test Laboratory: Sporton International Inc. SAR/HAC Testing Lab

Date: 2013/4/23

#61_WCDMA II_RMC 12.2Kbps_Edge 2_0cm_Ch9262

DUT: 322823-02

Communication System: WCDMA; Frequency: 1852.4 MHz; Duty Cycle: 1:1
 Medium: MSL_1900_130423 Medium parameters used: $f = 1852.4 \text{ MHz}$; $\sigma = 1.49 \text{ mho/m}$; $\epsilon_r = 53.057$; $\rho = 1000 \text{ kg/m}^3$
Ambient Temperature : 22.5 °C ; Liquid Temperature : 21.5 °C

DASY5 Configuration:

- Probe: ET3DV6 - SN1787; ConvF(4.58, 4.58, 4.58); Calibrated: 2012/5/29;
- Sensor-Surface: 4mm (Mechanical Surface Detection)
- Electronics: DAE4 Sn910; Calibrated: 2012/12/5
- Phantom: ELI v4.0; Type: QDOVA001BB; Serial: TP:1127
- Measurement SW: DASY52, Version 52.8 (3); SEMCAD X Version 14.6.5 (6469)

Configuration/Ch9262/Area Scan (41x131x1): Measurement grid: dx=15mm, dy=15mm
 Maximum value of SAR (interpolated) = 0.817 mW/g

Configuration/Ch9262/Zoom Scan (5x5x7)/Cube 0: Measurement grid: dx=8mm, dy=8mm, dz=5mm
 Reference Value = 25.316 V/m; Power Drift = 0.00 dB
 Peak SAR (extrapolated) = 1.170 mW/g
SAR(1 g) = 0.706 mW/g; SAR(10 g) = 0.348 mW/g
 Maximum value of SAR (measured) = 0.787 mW/g

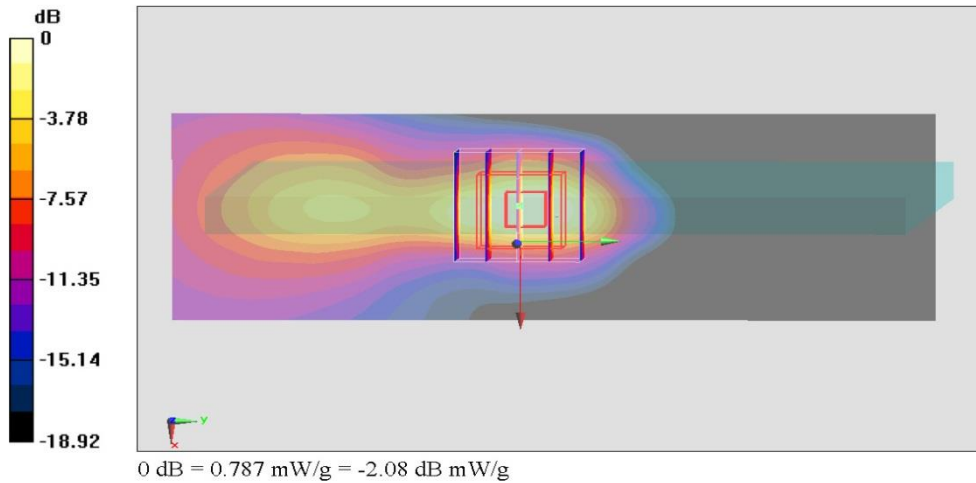

13. Simultaneous Transmission Analysis

NO.	Simultaneous Transmission Configurations	Tablet PC	Laptop	Note
		Body	Body	
1.	GPRS/EDGE(Data) + WLAN2.4GHz(data)	Yes		2.4GHz Hotspot
2.	WCDMA(Data) + WLAN2.4GHz(data)	Yes		2.4GHz Hotspot
3.	GPRS/EDGE(Data) + Bluetooth(data)	Yes		Bluetooth Tethering
4.	WCDMA(Data) + Bluetooth(data)	Yes		Bluetooth Tethering
5.	GPRS/EDGE (data) + Bluetooth(data) + Bluetooth(data)		Yes	See note1
6.	WWAN(data) + Bluetooth(data) + Bluetooth(data)		Yes	See note1

Note:

- Since WLAN function of the tablet cannot transmit simultaneously with the Keyboard, the only possible simultaneous transmission is Bluetooth of tablet and the keyboard during user typing
- Bluetooth keyboard cover will combination with this host. Max Bluetooth Average Power is -2.18dBm refer to FCC ID: O62U68B, Report No. FR341228.
- WLAN/Bluetooth power and test data is referred to Sporton FCC SAR Report FCC ID: VUIPDAPDAAT10-A, Report No: FA322823 Rev.01, and was granted on 2013/04/17 available on FCC website.
- The Scaled SAR summation is calculated based on the same configuration and test position.
- Per KDB 447498 D01v05, simultaneous transmission SAR is compliant if,
 - Scalar SAR summation < 1.6W/kg.
 - $SPLSR = (SAR_1 + SAR_2)^{1.5} / (min. \text{ separation distance, mm})$, and the peak separation distance is determined from the square root of $[(x_1-x_2)^2 + (y_1-y_2)^2 + (z_1-z_2)^2]$, where (x_1, y_1, z_1) and (x_2, y_2, z_2) are the coordinates of the extrapolated peak SAR locations in the zoom scan
If $SPLSR \leq 0.04$, simultaneously transmission SAR measurement is not necessary
 - Simultaneously transmission SAR measurement, and the reported multi-band SAR < 1.6W/kg
- For simultaneous transmission analysis, Bluetooth SAR is estimated per KDB 447498 D01v05 based on the formula below.
 - $(max. \text{ power of channel, including tune-up tolerance, mW}) / (min. \text{ test separation distance, mm}) \cdot [\sqrt{f(\text{GHz})} / x] \text{ W/kg}$ for test separation distances $\leq 50 \text{ mm}$; where $x = 7.5$ for 1-g SAR, and $x = 18.75$ for 10-g SAR.
 - 0.4 W/kg for 1-g SAR and 1.0 W/kg for 10-g SAR, when the test separation distances is > 50 mm.

<Bluetooth Estimated SAR of Tablet Mode>

Exposure Position	Bottom 0cm gap	Bottom 1cm gap	Curved surface of Edge1 0cm gap	Edge 1 0cm gap	Edge 1 1.2cm gap	Edge2 0cm gap
Test separation	0 mm	0 mm	0 mm	0 mm	0 mm	0 mm
Antenna to user distance	5 mm	10 mm	5 mm	5 mm	12 mm	191.14 mm
Estimated SAR (W/kg)	0.084 W/kg	0.042 W/kg	0.084 W/kg	0.084 W/kg	0.035 W/kg	0.4 W/kg

<Estimated SAR of Laptop Mode>

Wireless Mode	Tablet PC		Keyboard
	WWAN	Bluetooth	Bluetooth
Exposure Position	Bottom 0cm gap	Bottom 0cm gap	Bottom 0cm gap
Test separation	0 mm	0 mm	0 mm
Antenna to user distance	170 mm	170 mm	5 mm
Estimated SAR (W/kg)	0.4 W/kg	0.4 W/kg	0.025 W/kg



13.1 Body Exposure Conditions

<WWAN + WLAN 2.4GHz>

Position	WWAN			WLAN		WWAN + WLAN	SPLSR	Case No
	WWAN Band	Plot No	SAR (W/kg)	Plot No	SAR (W/kg)			
Bottom Face At 1 cm	GSM850	16	0.502	20	1.115	1.62	0.02	Case 1
	GSM1900	1	0.376	20	1.115	1.49		
	WCDMA V	21	0.496	20	1.115	1.61	0.02	Case 2
	WCDMA IV	55	0.88	20	1.115	2.00	0.03	Case 3
	WCDMA II	6	0.795	20	1.115	1.91	0.02	Case 4
Edge1 At 1.2 cm	GSM850	17	0.259	23	0.507	0.77		
	GSM1900	2	0.281	23	0.507	0.79		
	WCDMA V	22	0.238	23	0.507	0.75		
	WCDMA IV	12	0.662	23	0.507	1.17		
	WCDMA II	7	0.648	23	0.507	1.16		
Edge2 At 0cm	GSM850	42	1.031			1.03		
	GSM1900	26	0.492			0.49		
	WCDMA V	52	0.702			0.70		
	WCDMA IV	57	0.797			0.80		
	WCDMA II	61	0.997			1.00		
Bottom Face At 0 cm	GSM850	18	0.85	20	1.115	1.97	0.02	Case 5
	GSM1900	28	0.776	20	1.115	1.89	0.02	Case 6
	WCDMA V	47	1.034	20	1.115	2.15	0.02	Case 7
	WCDMA IV	13	0.832	20	1.115	1.95	0.03	Case 8
	WCDMA II	8	0.833	20	1.115	1.95	0.02	Case 9
Edge1 At 0cm	GSM850	19	0.56	23	0.507	1.07		
	GSM1900	30	0.875	23	0.507	1.38		
	WCDMA V	48	0.77	23	0.507	1.28		
	WCDMA IV	14	0.575	23	0.507	1.08		
	WCDMA II	36	0.874	23	0.507	1.38		
Curved surface of Edge1 At 0cm	GSM850	20	0.732	28	0.907	1.64	0.02	Case 11
	GSM1900	32	0.98	28	0.907	1.89	0.02	Case 12
	WCDMA V	51	0.857	28	0.907	1.76	0.02	Case 13
	WCDMA IV	15	0.731	28	0.907	1.64	0.02	Case 14
	WCDMA II	38	0.984	28	0.907	1.89	0.02	Case 15



<WWAN + Bluetooth>

Position	WWAN			Bluetooth	WWAN + Bluetooth	SPLSR	Case No
	WWAN Band	Plot No	SAR (W/kg)	Estimated SAR (W/kg)			
Bottom Face At 1 cm	GSM850	16	0.502	0.042	0.54		
	GSM1900	1	0.376	0.042	0.42		
	WCDMA V	21	0.496	0.042	0.54		
	WCDMA IV	55	0.88	0.042	0.92		
	WCDMA II	6	0.795	0.042	0.84		
Edge1 At 1.2 cm	GSM850	17	0.259	0.035	0.29		
	GSM1900	2	0.281	0.035	0.32		
	WCDMA V	22	0.238	0.035	0.27		
	WCDMA IV	12	0.662	0.035	0.70		
	WCDMA II	7	0.648	0.035	0.68		
Edge2 At 0cm	GSM850	42	1.031	0.4	1.43		
	GSM1900	26	0.492	0.4	0.89		
	WCDMA V	52	0.702	0.4	1.10		
	WCDMA IV	57	0.797	0.4	1.20		
	WCDMA II	61	0.997	0.4	1.40		
Bottom Face At 0 cm	GSM850	18	0.85	0.084	0.93		
	GSM1900	28	0.776	0.084	0.86		
	WCDMA V	47	1.034	0.084	1.12		
	WCDMA IV	13	0.832	0.084	0.92		
	WCDMA II	8	0.833	0.084	0.92		
Edge1 At 0cm	GSM850	19	0.56	0.084	0.64		
	GSM1900	30	0.875	0.084	0.96		
	WCDMA V	48	0.77	0.084	0.85		
	WCDMA IV	14	0.575	0.084	0.66		
	WCDMA II	36	0.874	0.084	0.96		
Curved surface of Edge1 At 0cm	GSM850	20	0.732	0.084	0.82		
	GSM1900	32	0.98	0.084	1.06		
	WCDMA V	51	0.857	0.084	0.94		
	WCDMA IV	15	0.731	0.084	0.82		
	WCDMA II	38	0.984	0.084	1.07		

<WWAN + Bluetooth + Bluetooth>

Position	Tablet		Keyboard	WWAN + Bluetooth + Bluetooth
	WWAN Estimated SAR (W/kg)	Bluetooth Estimated SAR (W/kg)	Bluetooth Estimated SAR (W/kg)	
Bottom of Laptop	0.4	0.4	0.025	0.83

13.2 SPLSR Evaluation and Analysis

<WLAN 2.4 GHz>

Case 1 Plot No	Band	Position	SAR (W/kg)	Gap (cm)	SAR peak location (m)			3D distance (mm)	Pair SAR sum (W/kg)	SPLSR	Simultaneous SAR
					X	Y	Z				
#16	GSM 850_cube0	Bottom Face	0.502	1	0.0705	0.105	-0.179	174.7	1.62	0.01	Not required
#20	WLAN2.4GHz		1.115	0	0.0804	-0.0694	-0.175				
#16	GSM 850_cube1	Bottom Face	0.468	1	0.081	0.061	-0.179	130.5	1.58	0.02	Not required
#20	WLAN2.4GHz		1.115	0	0.0804	-0.0694	-0.175				

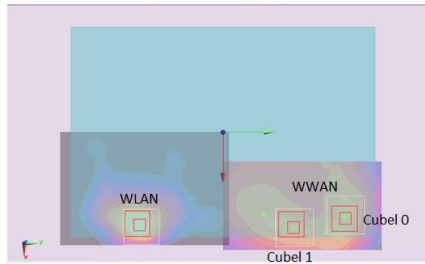

Case 2 Plot No	Band	Position	SAR (W/kg)	Gap (cm)	SAR peak location (m)			3D distance (mm)	Pair SAR sum (W/kg)	SPLSR	Simultaneous SAR
					X	Y	Z				
#21	WCDMA V_cube0	Bottom Face	0.496	1	0.069	0.105	-0.179	174.8	1.61	0.01	Not required
#20	WLAN2.4GHz		1.115	0	0.0804	-0.0694	-0.175				
#21	WCDMA V_cube1	Bottom Face	0.453	1	0.081	0.0565	-0.179	126.0	1.57	0.02	Not required
#20	WLAN2.4GHz		1.115	0	0.0804	-0.0694	-0.175				

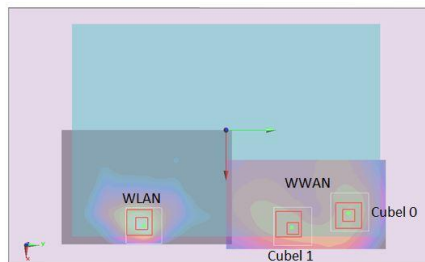

Case 3 Plot No	Band	Position	SAR (W/kg)	Gap (cm)	SAR peak location (m)			3D distance (mm)	Pair SAR sum (W/kg)	SPLSR	Simultaneous SAR
					X	Y	Z				
#55	WCDMA IV	Bottom Face	0.88	1	0.0905	0.041	-0.178	110.9	2.00	0.03	Not required
#20	WLAN2.4GHz		1.115	0	0.0804	-0.0694	-0.175				

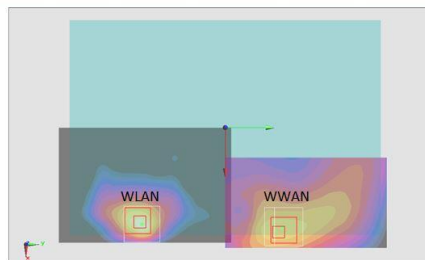

Case 4 Plot No	Band	Position	SAR (W/kg)	Gap (cm)	SAR peak location (m)			3D distance (mm)	Pair SAR sum (W/kg)	SPLSR	Simultaneous SAR
					X	Y	Z				
#6	WCDMA II	Bottom Face	0.795	1	0.0825	0.049	-0.178	118.5	1.91	0.02	Not required
#20	WLAN2.4GHz		1.115	0	0.0804	-0.0694	-0.175				

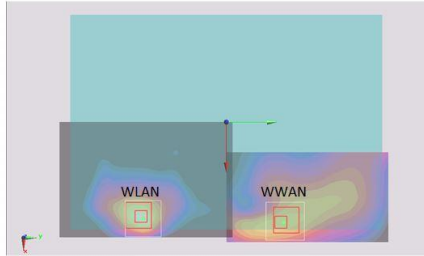

Case 5 Plot No	Band	Position	SAR (W/kg)	Gap (cm)	SAR peak location (m)			3D distance (mm)	Pair SAR sum (W/kg)	SPLSR	Simultaneous SAR
					X	Y	Z				
#18	GSM 850	Bottom Face	0.85	0	0.0825	0.067	-0.178	136.4	1.97	0.02	Not required
#20	WLAN2.4GHz		1.115	0	0.0804	-0.0694	-0.175				

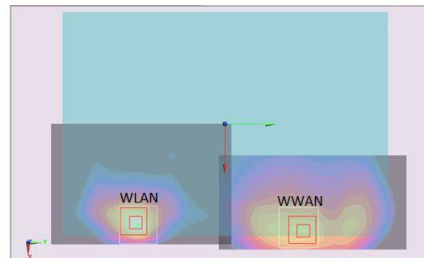

Case 6 Plot No	Band	Position	SAR (W/kg)	Gap (cm)	SAR peak location (m)			3D distance (mm)	Pair SAR sum (W/kg)	SPLSR	Simultaneous SAR
					X	Y	Z				
#28	GSM 1900	Bottom Face	0.776	0	0.0825	0.046	-0.178	115.5	1.89	0.02	Not required
#20	WLAN2.4GHz		1.115	0	0.0804	-0.0694	-0.175				

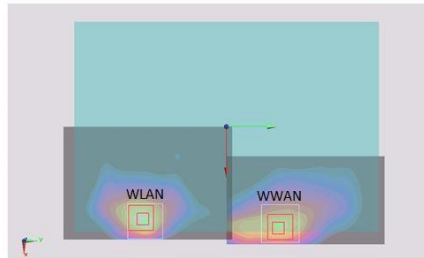

Case 7 Plot No	Band	Position	SAR (W/kg)	Gap (cm)	SAR peak location (m)			3D distance (mm)	Pair SAR sum (W/kg)	SPLSR	Simultaneous SAR
					X	Y	Z				
#47	WCDMA V_cube0	Bottom Face	1.034	0	0.0825	0.0675	-0.178	136.9	2.15	0.02	Not required
#20	WLAN2.4GHz		1.115	0	0.0804	-0.0694	-0.175				
#47	WCDMA V_cube1	Bottom Face	0.725	0	0.081	0.103	-0.178	172.4	1.84	0.01	Not required
#20	WLAN2.4GHz		1.115	0	0.0804	-0.0694	-0.175				

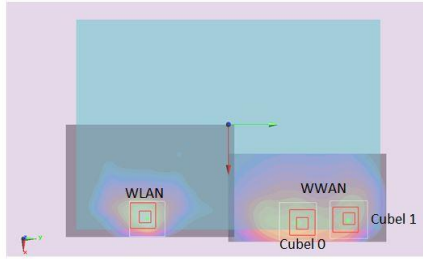

Case 8 Plot No	Band	Position	SAR (W/kg)	Gap (cm)	SAR peak location (m)			3D distance (mm)	Pair SAR sum (W/kg)	SPLSR	Simultaneous SAR
					X	Y	Z				
#13	WCDMA IV	Bottom Face	0.832	0	0.081	0.0365	-0.178	105.9	1.95	0.03	Not required
#20	WLAN2.4GHz		1.115	0	0.0804	-0.0694	-0.175				

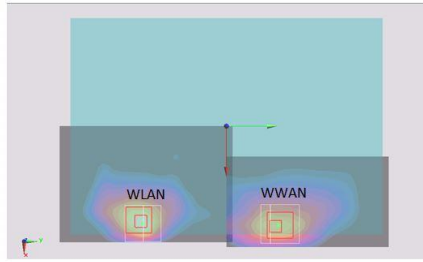

Case 9 Plot No	Band	Position	SAR (W/kg)	Gap (cm)	SAR peak location (m)			3D distance (mm)	Pair SAR sum (W/kg)	SPLSR	Simultaneous SAR
					X	Y	Z				
#8	WCDMA II	Bottom Face	0.833	0	0.0825	0.046	-0.178	115.5	1.95	0.02	Not required
#20	WLAN2.4GHz		1.115	0	0.0804	-0.0694	-0.175				

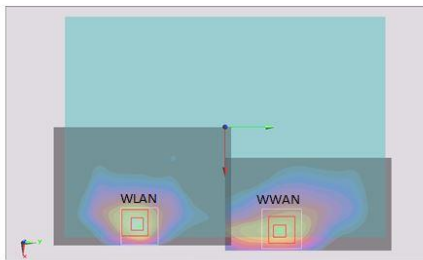

Case 11 Plot No	Band	Position	SAR (W/kg)	Gap (cm)	SAR peak location (m)			3D distance (mm)	Pair SAR sum (W/kg)	SPLSR	Simultaneous SAR
					X	Y	Z				
#20	GSM850	Curved surface of Edge1	0.732	0	0.0675	0.0625	-0.179	132.0	1.64	0.02	Not required
#28	WLAN2.4GHz		0.907	0	0.0712	-0.0694	-0.174				

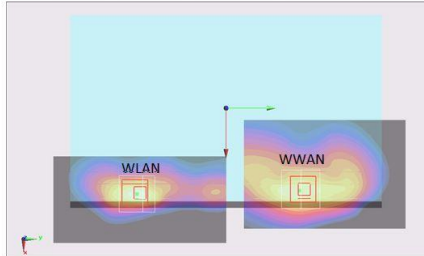

Case 12 Plot No	Band	Position	SAR (W/kg)	Gap (cm)	SAR peak location (m)			3D distance (mm)	Pair SAR sum (W/kg)	SPLSR	Simultaneous SAR
					X	Y	Z				
#32	GSM1900	Curved surface of Edge1	0.98	0	0.069	0.0475	-0.178	117.0	1.89	0.02	Not required
#28	WLAN2.4GHz		0.907	0	0.0712	-0.0694	-0.174				

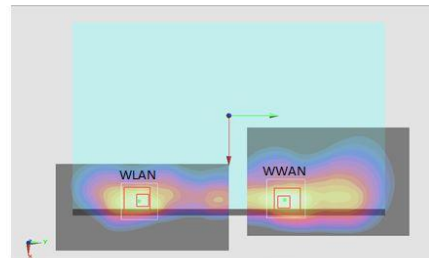

Case 13 Plot No	Band	Position	SAR (W/kg)	Gap (cm)	SAR peak location (m)			3D distance (mm)	Pair SAR sum (W/kg)	SPLSR	Simultaneous SAR
					X	Y	Z				
#51	WCDMA V_cube0	Curved surface of Edge1	0.857	0	0.0705	0.0625	-0.179	132.0	1.76	0.02	Not required
#28	WLAN2.4GHz		0.907	0	0.0712	-0.0694	-0.174				
#51	WCDMA V_cube1	Curved surface of Edge1	0.699	0	0.081	0.0895	-0.178	159.3	1.61	0.01	Not required
#28	WLAN2.4GHz		0.907	0	0.0712	-0.0694	-0.174				

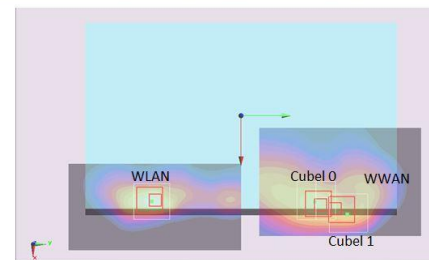

Case 14	Band	Position	SAR (W/kg)	Gap (cm)	SAR peak location (m)			3D distance (mm)	Pair SAR sum (W/kg)	SPLSR	Simultaneous SAR
Plot No					X	Y	Z				
#15	WCDMA IV	Curved surface of Edge1	0.731	0	0.0675	0.0475	-0.178	117.0	1.64	0.02	Not required
#28	WLAN2.4GHz		0.907	0	0.0712	-0.0694	-0.174				

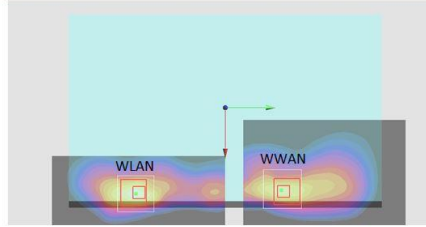

Case 15	Band	Position	SAR (W/kg)	Gap (cm)	SAR peak location (m)			3D distance (mm)	Pair SAR sum (W/kg)	SPLSR	Simultaneous SAR
Plot No					X	Y	Z				
#38	WCDMA II	Curved surface of Edge1	0.984	0	0.069	0.0475	-0.178	117.0	1.89	0.02	Not required
#28	WLAN2.4GHz		0.907	0	0.0712	-0.0694	-0.174				

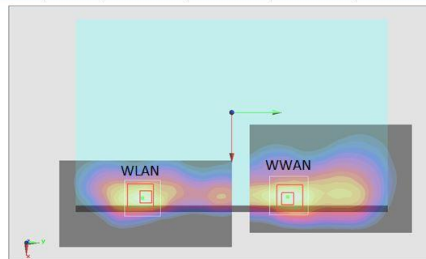

Test Engineer : San Lin, Bevis Chang, Jack Wu, and Nick Yu

14. Uncertainty Assessment

The component of uncertainty may generally be categorized according to the methods used to evaluate them. The evaluation of uncertainty by the statistical analysis of a series of observations is termed a Type A evaluation of uncertainty. The evaluation of uncertainty by means other than the statistical analysis of a series of observations is termed a Type B evaluation of uncertainty. Each component of uncertainty, however evaluated, is represented by an estimated standard deviation, termed standard uncertainty, which is determined by the positive square root of the estimated variance.

A Type A evaluation of standard uncertainty may be based on any valid statistical method for treating data. This includes calculating the standard deviation of the mean of a series of independent observations; using the method of least squares to fit a curve to the data in order to estimate the parameter of the curve and their standard deviations; or carrying out an analysis of variance in order to identify and quantify random effects in certain kinds of measurement.

A type B evaluation of standard uncertainty is typically based on scientific judgment using all of the relevant information available. These may include previous measurement data, experience, and knowledge of the behavior and properties of relevant materials and instruments, manufacture's specification, data provided in calibration reports and uncertainties assigned to reference data taken from handbooks. Broadly speaking, the uncertainty is either obtained from an outdoor source or obtained from an assumed distribution, such as the normal distribution, rectangular or triangular distributions indicated in Table 12.1

Uncertainty Distributions	Normal	Rectangular	Triangular	U-Shape
Multi-plying Factor ^(a)	1/k ^(b)	1/√3	1/√6	1/√2

(a) standard uncertainty is determined as the product of the multiplying factor and the estimated range of variations in the measured quantity

(b) κ is the coverage factor

Table 14.1 Standard Uncertainty for Assumed Distribution

The combined standard uncertainty of the measurement result represents the estimated standard deviation of the result. It is obtained by combining the individual standard uncertainties of both Type A and Type B evaluation using the usual "root-sum-squares" (RSS) methods of combining standard deviations by taking the positive square root of the estimated variances.

Expanded uncertainty is a measure of uncertainty that defines an interval about the measurement result within which the measured value is confidently believed to lie. It is obtained by multiplying the combined standard uncertainty by a coverage factor. Typically, the coverage factor ranges from 2 to 3. Using a coverage factor allows the true value of a measured quantity to be specified with a defined probability within the specified uncertainty range. For purpose of this document, a coverage factor two is used, which corresponds to confidence interval of about 95 %. The DASY uncertainty Budget is shown in the following tables.



Error Description	Uncertainty Value (±%)	Probability Distribution	Divisor	Ci (1g)	Ci (10g)	Standard Uncertainty (1g)	Standard Uncertainty (10g)
Measurement System							
Probe Calibration	6.0	Normal	1	1	1	± 6.0 %	± 6.0 %
Axial Isotropy	4.7	Rectangular	√3	0.7	0.7	± 1.9 %	± 1.9 %
Hemispherical Isotropy	9.6	Rectangular	√3	0.7	0.7	± 3.9 %	± 3.9 %
Boundary Effects	1.0	Rectangular	√3	1	1	± 0.6 %	± 0.6 %
Linearity	4.7	Rectangular	√3	1	1	± 2.7 %	± 2.7 %
System Detection Limits	1.0	Rectangular	√3	1	1	± 0.6 %	± 0.6 %
Readout Electronics	0.3	Normal	1	1	1	± 0.3 %	± 0.3 %
Response Time	0.8	Rectangular	√3	1	1	± 0.5 %	± 0.5 %
Integration Time	2.6	Rectangular	√3	1	1	± 1.5 %	± 1.5 %
RF Ambient Noise	3.0	Rectangular	√3	1	1	± 1.7 %	± 1.7 %
RF Ambient Reflections	3.0	Rectangular	√3	1	1	± 1.7 %	± 1.7 %
Probe Positioner	0.4	Rectangular	√3	1	1	± 0.2 %	± 0.2 %
Probe Positioning	2.9	Rectangular	√3	1	1	± 1.7 %	± 1.7 %
Max. SAR Eval.	1.0	Rectangular	√3	1	1	± 0.6 %	± 0.6 %
Test Sample Related							
Device Positioning	2.9	Normal	1	1	1	± 2.9 %	± 2.9 %
Device Holder	3.6	Normal	1	1	1	± 3.6 %	± 3.6 %
Power Drift	5.0	Rectangular	√3	1	1	± 2.9 %	± 2.9 %
Phantom and Setup							
Phantom Uncertainty	4.0	Rectangular	√3	1	1	± 2.3 %	± 2.3 %
Liquid Conductivity (Target)	5.0	Rectangular	√3	0.64	0.43	± 1.8 %	± 1.2 %
Liquid Conductivity (Meas.)	2.5	Normal	1	0.64	0.43	± 1.6 %	± 1.1 %
Liquid Permittivity (Target)	5.0	Rectangular	√3	0.6	0.49	± 1.7 %	± 1.4 %
Liquid Permittivity (Meas.)	2.5	Normal	1	0.6	0.49	± 1.5 %	± 1.2 %
Combined Standard Uncertainty						± 11.0 %	± 10.8 %
Coverage Factor for 95 %						K=2	
Expanded Uncertainty						± 22.0 %	± 21.5 %

Table 14.2 Uncertainty Budget for frequency range 300 MHz to 3 GHz according to IEEE1528-2003



15. References

- [1] FCC 47 CFR Part 2 “Frequency Allocations and Radio Treaty Matters; General Rules and Regulations”
- [2] ANSI/IEEE Std. C95.1-1992, “IEEE Standard for Safety Levels with Respect to Human Exposure to Radio Frequency Electromagnetic Fields, 3 kHz to 300 GHz”, September 1992
- [3] IEEE Std. 1528-2003, “Recommended Practice for Determining the Peak Spatial-Average Specific Absorption Rate (SAR) in the Human Head from Wireless Communications Devices: Measurement Techniques”, December 2003
- [4] FCC OET Bulletin 65 (Edition 97-01) Supplement C (Edition 01-01), “Evaluating Compliance with FCC Guidelines for Human Exposure to Radiofrequency Electromagnetic Fields”, June 2001
- [5] SPEAG DASY System Handbook
- [6] FCC KDB 248227 D01 v01r02, “SAR Measurement Procedures for 802.11 a/b/g Transmitters”, May 2007
- [7] FCC KDB 447498 D01 v05, “Mobile and Portable Device RF Exposure Procedures and Equipment Authorization Policies”, October 2012
- [8] FCC KDB 941225 D03 v01, “Recommended SAR Test Reduction Procedures for GSM / GPRS / EDGE”, December 2008
- [9] FCC KDB 941225 D01 v02, “SAR Measurement Procedures for 3G Devices – CDMA 2000 / Ev-Do / WCDMA / HSDPA / HSPA”, October 2007
- [10] FCC KDB 616217 D04 v01, “SAR Evaluation Considerations for Laptop, Notebook, Netbook and Tablet Computers”, October 2012