



SPORTON International Inc.

No. 52, Hwa Ya 1st Rd., Hwa Ya Technology Park, Kwei-Shan Hsiang, Tao Yuan Hsien, Taiwan, R.O.C.
Ph: 886-3-327-3456 / FAX: 886-3-327-0973 / www.sporton.com.tw

FCC RADIO TEST REPORT

Applicant's company	PEGATRON CORPORATION
Applicant Address	5F., NO. 76, LIGONG ST., BEITOU DISTRICT, TAIPEI CITY 112 Taiwan
FCC ID	VUICLG8202SEC-NA
Manufacturer's company	MAINTEK COMPUTER
Manufacturer Address	233 Jinfeng Rd., Suzhou, Jiangsu, PRC

Product Name	Wireless Home Automation and Security
Brand Name	CISCO
Model No.	CLG-8202-SEC NA
Test Rule	47 CFR FCC Part 15 Subpart C § 15.247
Test Freq. Range	2400 ~ 2483.5MHz
Received Date	May 05, 2014
Final Test Date	Jun. 03, 2014
Submission Type	Original Equipment

Statement

Test result included in this report is for the IEEE 802.11n and IEEE 802.11b/g of the product.

The test result in this report refers exclusively to the presented test model / sample.

Without written approval of SPORTON International Inc., the test report shall not be reproduced except in full.

The measurements and test results shown in this test report were made in accordance with the procedures and found in compliance with the limit given in ANSI C63.10-2009, 47 CFR FCC Part 15 Subpart C, KDB 558074 D01 v03r01 and KDB 662911 D01 v02r01.

The test equipment used to perform the test is calibrated and traceable to NML/ROC.



Table of Contents

1. CERTIFICATE OF COMPLIANCE	1
2. SUMMARY OF THE TEST RESULT	2
3. GENERAL INFORMATION	3
3.1. Product Details.....	3
3.2. Accessories.....	4
3.3. Table for Filed Antenna.....	5
3.4. Table for Carrier Frequencies	6
3.5. Table for Test Modes.....	6
3.6. Table for Testing Locations.....	7
3.7. Table for Supporting Units	8
3.8. Table for Parameters of Test Software Setting	8
3.9. EUT Operation during Test	8
3.10. Duty Cycle.....	9
3.11. Test Configurations	11
4. TEST RESULT	14
4.1. AC Power Line Conducted Emissions Measurement.....	14
4.2. Maximum Conducted Output Power Measurement.....	18
4.3. Power Spectral Density Measurement	21
4.4. 6dB Spectrum Bandwidth Measurement	29
4.5. Radiated Emissions Measurement	34
4.6. Emissions Measurement	53
4.7. Antenna Requirements	71
5. LIST OF MEASURING EQUIPMENTS	72
6. MEASUREMENT UNCERTAINTY.....	74
APPENDIX A. TEST PHOTOS	A1 ~ A5
APPENDIX B. RADIATED EMISSION CO-LOCATION REPORT	B1 ~ B3



History of This Test Report

REPORT NO.	VERSION	DESCRIPTION	ISSUED DATE
FR450502AA	Rev. 01	Initial issue of report	Jun. 30, 2014

1. CERTIFICATE OF COMPLIANCE

Product Name : Wireless Home Automation and Security
Brand Name : CISCO
Model No. : CLG-8202-SEC NA
Applicant : PEGATRON CORPORATION
Test Rule Part(s) : 47 CFR FCC Part 15 Subpart C § 15.247

Sporton International as requested by the applicant to evaluate the EMC performance of the product sample received on May 05, 2014 would like to declare that the tested sample has been evaluated and found to be in compliance with the tested rule parts. The data recorded as well as the test configuration specified is true and accurate for showing the sample's EMC nature.

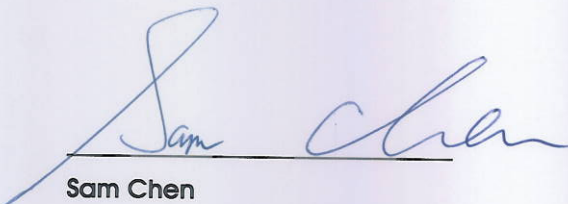

Sam Chen

SPORTON INTERNATIONAL INC.

2. SUMMARY OF THE TEST RESULT

Applied Standard: 47 CFR FCC Part 15 Subpart C				
Part	Rule Section	Description of Test	Result	Under Limit
4.1	15.207	AC Power Line Conducted Emissions	Complies	12.89 dB
4.2	15.247(b)(3)	Maximum Conducted Output Power	Complies	9.73 dB
4.3	15.247(e)	Power Spectral Density	Complies	12.00 dB
4.4	15.247(a)(2)	6dB Spectrum Bandwidth	Complies	-
4.5	15.247(d)	Radiated Emissions	Complies	0.14 dB
4.6	15.247(d)	Band Edge Emissions	Complies	0.13 dB
4.7	15.203	Antenna Requirements	Complies	-

3. GENERAL INFORMATION

3.1. Product Details

IEEE 802.11n

Items	Description
Product Type	WLAN (2TX, 2RX)
Radio Type	Intentional Transceiver
Power Type	From power adapter
Modulation	see the below table for IEEE 802.11n
Data Modulation	OFDM (BPSK / QPSK / 16QAM / 64QAM)
Data Rate (Mbps)	see the below table for IEEE 802.11n
Frequency Range	2400 ~ 2483.5MHz
Channel Number	11 for 20MHz bandwidth ; 7 for 40MHz bandwidth
Channel Band Width (99%)	MCS0 (HT20): 17.68 MHz ; MCS0 (HT40): 36.48 MHz
Maximum Conducted Output Power	MCS0 (HT20): 20.27 dBm ; MCS0 (HT40): 16.87 dBm
Carrier Frequencies	Please refer to section 3.4
Antenna	Please refer to section 3.3

IEEE 802.11b/g

Items	Description
Product Type	802.11b: WLAN (1TX, 2RX) 802.11g: WLAN (2TX, 2RX)
Radio Type	Intentional Transceiver
Power Type	From power adapter
Modulation	DSSS for IEEE 802.11b ; OFDM for IEEE 802.11g
Data Modulation	DSSS (BPSK / QPSK / CCK) ; OFDM (BPSK / QPSK / 16QAM / 64QAM)
Data Rate (Mbps)	DSSS (1/ 2/ 5.5/11) ; OFDM (6/9/12/18/24/36/48/54)
Frequency Range	2400 ~ 2483.5MHz
Channel Number	11
Channel Band Width (99%)	11b: 10.24 MHz ; 11g: 16.24 MHz
Maximum Conducted Output Power	11b: 19.03 dBm ; 11g: 20.22 dBm
Carrier Frequencies	Please refer to section 3.4
Antenna	Please refer to section 3.3

Items	Description	
Beamforming Function	<input type="checkbox"/> With beamforming	<input checked="" type="checkbox"/> Without beamforming

Antenna and Band width

Antenna	Single (TX)		Two (TX)	
	20 MHz	40 MHz	20 MHz	40 MHz
IEEE 802.11b	V	X	X	X
IEEE 802.11g	X	X	V	X
IEEE 802.11n	X	X	V	V

IEEE 11n Spec.

Protocol	Number of Transmit Chains (NTX)	Data Rate / MCS
802.11n (HT20)	2	MCS 0-15
802.11n (HT40)	2	MCS 0-15

Note 1: IEEE Std. 802.11n modulation consists of HT20 and HT40 (HT: High Throughput).
Then EUT support HT20 and HT40.

Note 2: Modulation modes consist of below configuration: HT20/HT40: IEEE 802.11n

3.2. Accessories

Power	Brand	Model	Rating
Adapter	APD	WA-23A15FU	INPUT: 100-240V ~ 50-60Hz OUTPUT: 15V, 1.5A
Other			
Pedestal*1			

3.3. Table for Filed Antenna

Ant.	Brand Holder	Model Name	Antenna Type	Connector	Gain (dBi)
1	HL TECHNOLOGY	-	PCB Antenna	Murata	2.57
2	HL TECHNOLOGY	-	PCB Antenna	Murata	3.53
3	HL TECHNOLOGY	-	PCB Antenna	Murata	0.40
4	HL TECHNOLOGY	-	PCB Antenna	Murata	3.81

Note:

For 2.4GHz function:

For IEEE 802.11b mode (1TX/2RX)

The EUT supports the Ant. 1 and Ant. 2 with TX diversity function.

Ant. 2 generated the worst case than Ant. 1, so it is tested and recorded in the report.

Ant. 1 and Ant. 2 could receive simultaneously.

For IEEE 802.11g/n mode (2TX/2RX)

Ant. 1 and Ant. 2 can be used as transmitting/receiving antenna.

Ant. 1 and Ant. 2 could transmit/receive simultaneously.

For Z-wave function (1TX/1RX)

Only Ant. 3 can be used as transmitting/receiving antenna.

For AFM function (1TX/1RX)

Only Ant. 4 can be used as transmitting/receiving antenna.

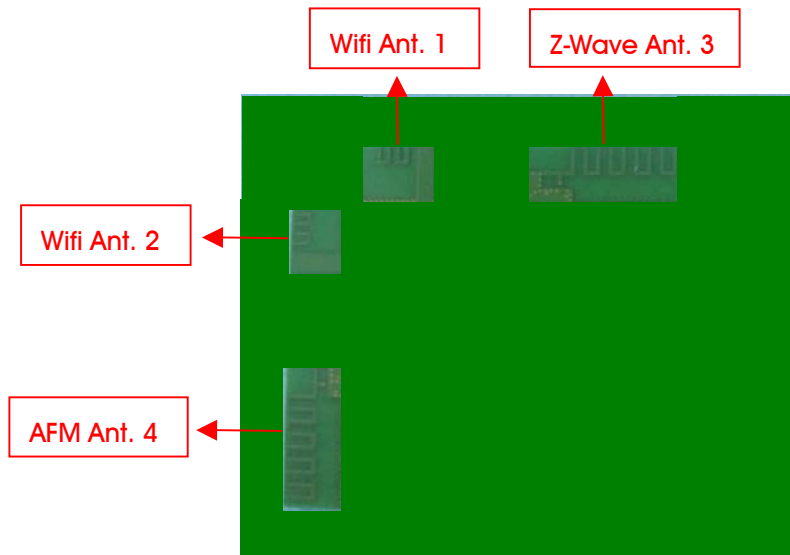

3.4. Table for Carrier Frequencies

There are two bandwidth systems.

For 20MHz bandwidth systems, use Channel 1~Channel 11.

For 40MHz bandwidth systems, use Channel 3~Channel 9.

Frequency Band	Channel No.	Frequency	Channel No.	Frequency
2400~2483.5MHz	1	2412 MHz	7	2442 MHz
	2	2417 MHz	8	2447 MHz
	3	2422 MHz	9	2452 MHz
	4	2427 MHz	10	2457 MHz
	5	2432 MHz	11	2462 MHz
	6	2437 MHz	-	-

3.5. Table for Test Modes

Preliminary tests were performed in different data rate to find the worst radiated emission. The data rate shown in the table below is the worst-case rate with respect to the specific test item. Investigation has been done on all the possible configurations for searching the worst cases. The following table is a list of the test modes shown in this test report.

Test Items	Mode	Data Rate	Channel	Antenna
AC Power Line Conducted Emissions	CTX	-	-	-
Maximum Conducted Output Power	802.11n HT20	MCS0	1/6/11	1+2
	802.11n HT40	MCS0	3/6/9	1+2
	11b/BPSK	1 Mbps	1/6/11	2
	11g/BPSK	6 Mbps	1/6/11	1+2
Power Spectral Density	802.11n HT20	MCS0	1/6/11	1+2
	802.11n HT40	MCS0	3/6/9	1+2
	11b/BPSK	1 Mbps	1/6/11	2
	11g/BPSK	6 Mbps	1/6/11	1+2
6dB Spectrum Bandwidth	802.11n HT20	MCS0	1/6/11	1+2
	802.11n HT40	MCS0	3/6/9	1+2
	11b/BPSK	1 Mbps	1/6/11	2
	11g/BPSK	6 Mbps	1/6/11	1+2
Radiated Emissions 9kHz~1GHz	CTX	-	-	-
Radiated Emissions 1GHz~10 th Harmonic	802.11n HT20	MCS0	1/6/11	1+2
	802.11n HT40	MCS0	3/6/9	1+2
	11b/BPSK	1 Mbps	1/6/11	2
	11g/BPSK	6 Mbps	1/6/11	1+2

Band Edge Emissions	802.11n HT20	MCS0	1/6/11	1+2
	802.11n HT40	MCS0	3/6/9	1+2
	11b/BPSK	1 Mbps	1/6/11	2
	11g/BPSK	6 Mbps	1/6/11	1+2

The following test modes were performed for all tests:

For Conducted Emission test:

Mode 1. EUT standing (Wifi function + Z-wave function + AFM function)

For Radiated Emission below 1GHz test:

Mode 1. EUT standing (Wifi function + Z-wave function + AFM function)

For Radiated Emission above 1GHz test:

Mode 1. EUT standing

For Radiated Emission Co-location Test:

The EUT could be applied with 2.4GHz WLAN function, Z-wave function and AFM function; therefore Radiated Emission Co-location (please refer to Appendix B) tests are added for simultaneously transmit among 2.4GHz WLAN function, Z-wave function and AFM function.

3.6. Table for Testing Locations

Test Site Location				
Address:	No.8, Lane 724, Bo-ai St., Jhubei City, Hsinchu County 302, Taiwan, R.O.C.			
TEL:	886-3-656-9065			
FAX:	886-3-656-9085			
Test Site No.	Site Category	Location	FCC Reg. No.	IC File No.
03CH01-CB	SAC	Hsin Chu	262045	IC 4086D
CO01-CB	Conduction	Hsin Chu	262045	IC 4086D
TH01-CB	OVEN Room	Hsin Chu	-	-

Open Area Test Site (OATS); Semi Anechoic Chamber (SAC).

3.7. Table for Supporting Units

For Test Site No: 03CH01-CB

For Radiated Emission below 1GHz test:

Support Unit	Brand	Model	FCC ID
Flash Disk	Silicon	D33B03	DoC
Notebook	DELL	D420	DoC

For Radiated Emission above 1GHz test:

Support Unit	Brand	Model	FCC ID
Notebook	DELL	D420	DoC

For Test Site No: CO01-CB

Support Unit	Brand	Model	FCC ID
Notebook	DELL	E6430	DoC
Flash Disk	Silicon	I-Series	DoC

For Test Site No: TH01-CB

Support Unit	Brand	Model	FCC ID
Notebook	DELL	E6220	D2A62L1989V5

3.8. Table for Parameters of Test Software Setting

During testing, Channel and Power Controlling Software provided by the customer was used to control the operating channel as well as the output power level. The RF output power selection is for the setting of RF output power expected by the customer and is going to be fixed on the firmware of the final end product.

Power Parameters of IEEE 802.11n

Test Software Version	MTOOL_2.0.1.0		
Frequency	2412 MHz	2437 MHz	2462 MHz
MCS0 HT20	46	62	48
Frequency	2422 MHz	2437 MHz	2452 MHz
MCS0 HT40	32	44	47

Power Parameters of IEEE 802.11b/g

Test Software Version	MTOOL_2.0.1.0		
Frequency	2412 MHz	2437 MHz	2462 MHz
IEEE 802.11b	63	61	52
IEEE 802.11g	50	62	49

3.9. EUT Operation during Test

The EUT was programmed to be in continuously transmitting mode.

3.10. Duty Cycle

IEEE 802.11n MCS0 HT20

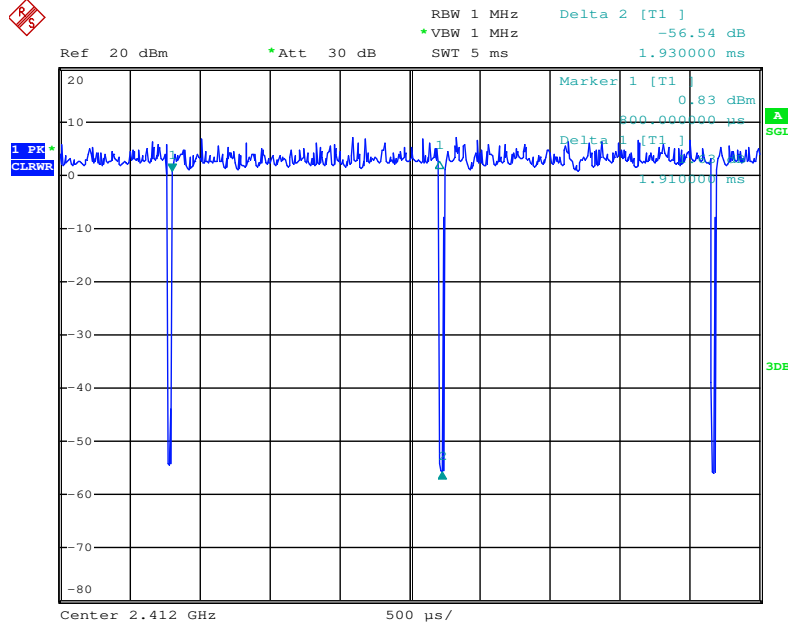

Date: 3.JUN.2014 13:19:28

IEEE 802.11n MCS0 HT40

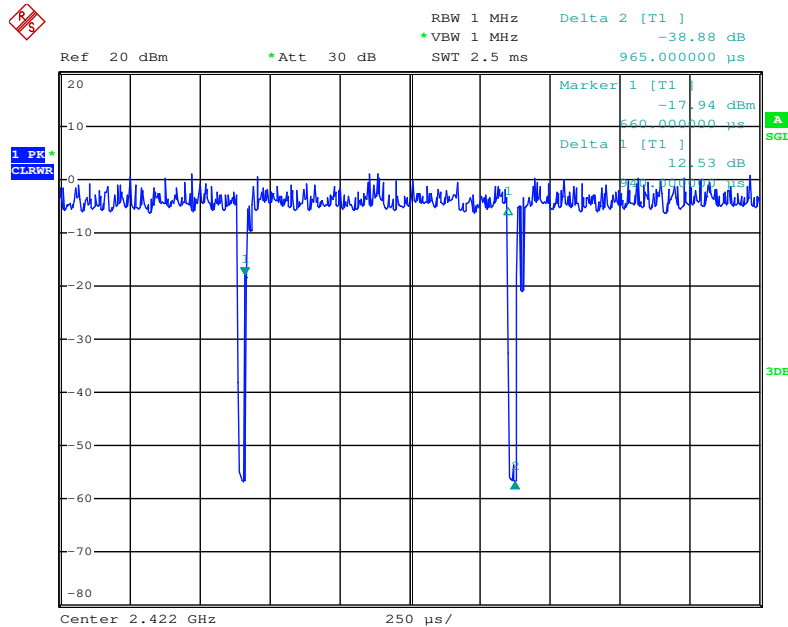

Date: 3.JUN.2014 13:20:27

IEEE 802.11b

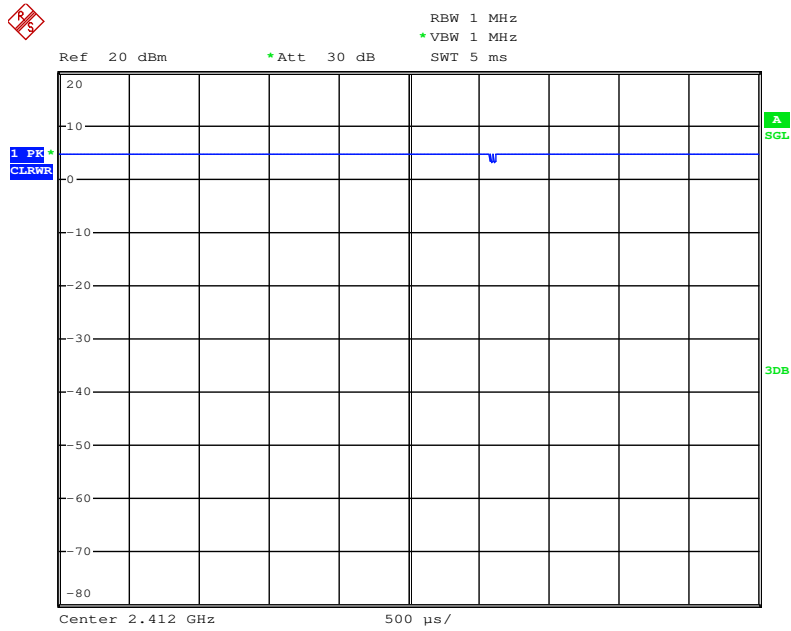

Date: 3.JUN.2014 13:17:37

IEEE 802.11g

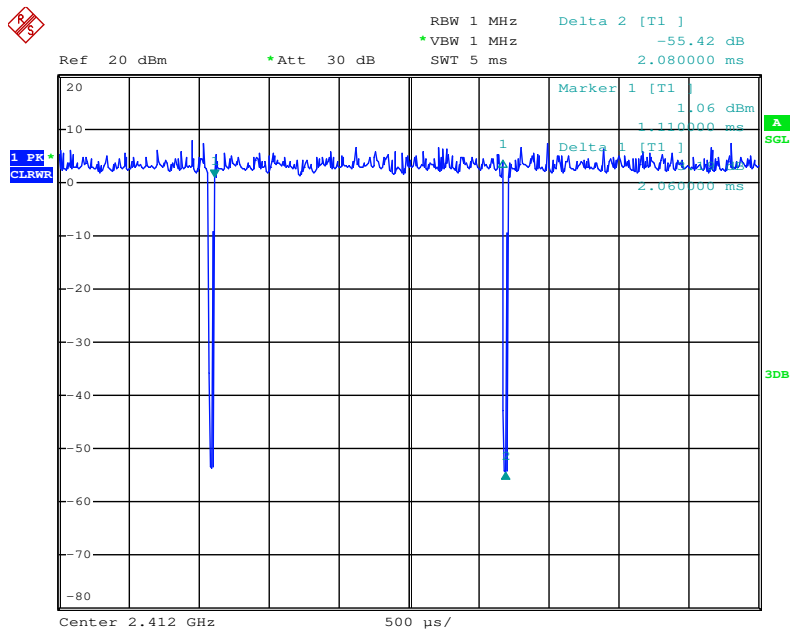

Date: 3.JUN.2014 13:18:27

3.11. Test Configurations

3.11.1.AC Power Line Conduction Emissions Test Configuration

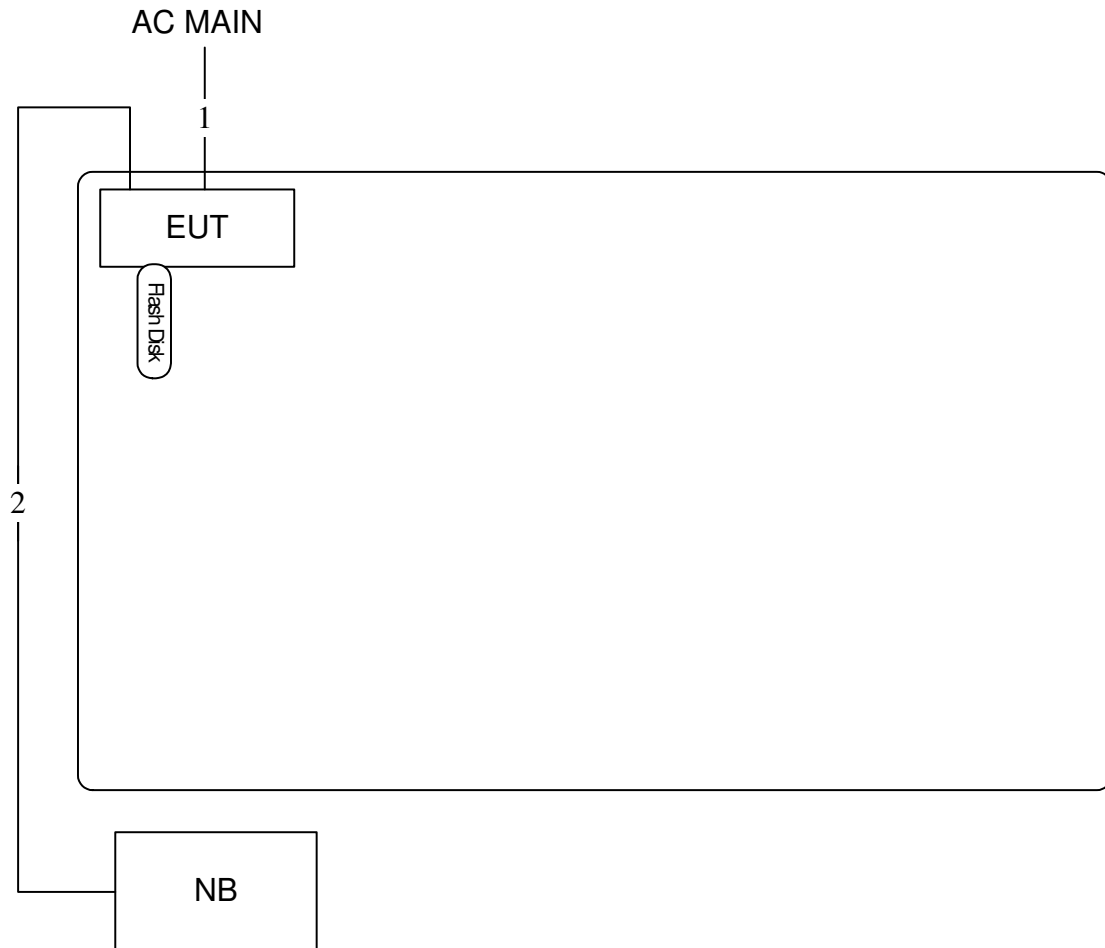

Item	Connection	Shielded	Length(m)
1	Power Cable	No	1.5m
2	RJ-45 Cable	No	10m

3.11.2. Radiation Emissions Test Configuration

Test Configuration: 30MHz~1GHz

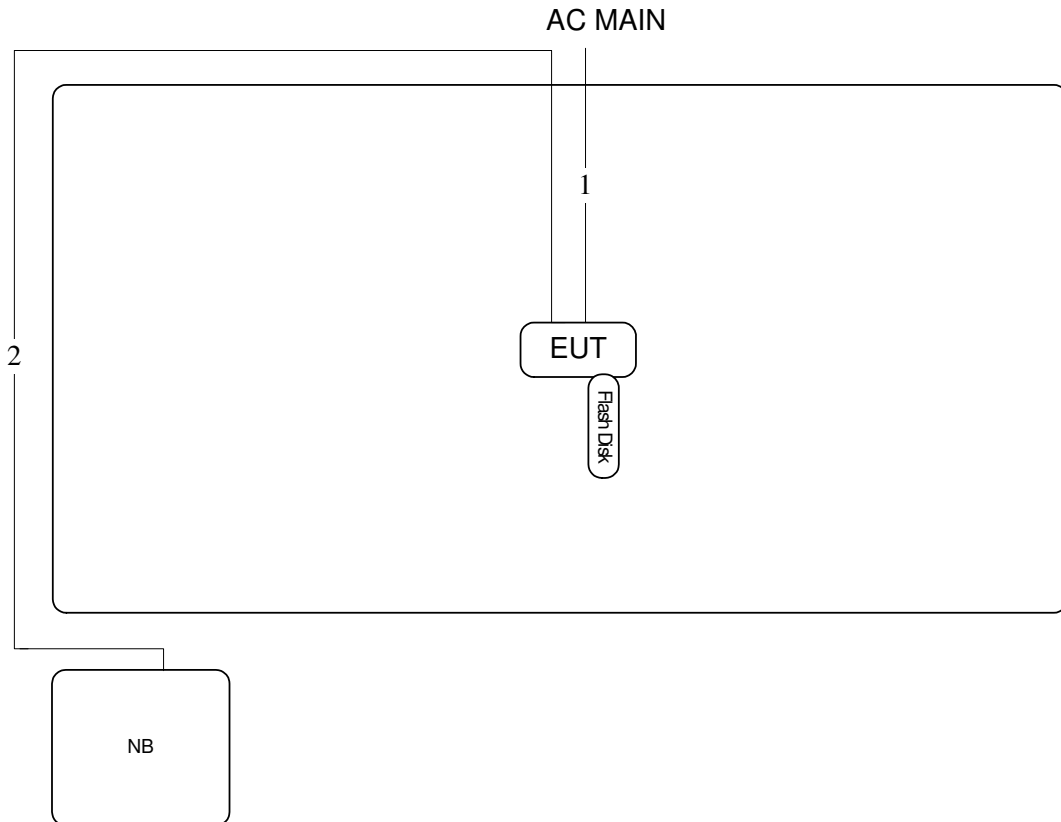

Item	Connection	Shielded	Length(m)
1	Power Cable	No	1.5m
2	RJ-45 Cable	No	10m

Test Configuration: above 1GHz

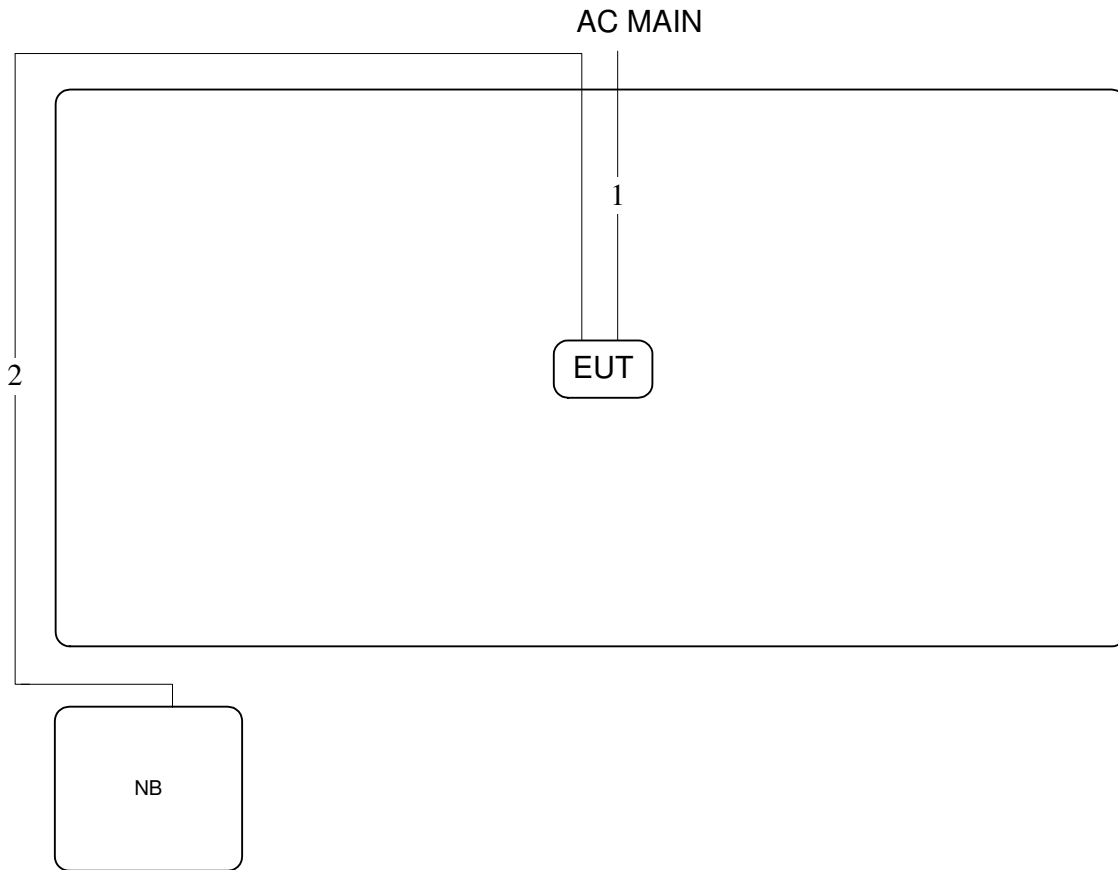

Item	Connection	Shielded	Length(m)
1	Power Cable	No	1.5m
2	RJ-45 Cable	No	10m

4. TEST RESULT

4.1. AC Power Line Conducted Emissions Measurement

4.1.1. Limit

For this product which is designed to be connected to the AC power line, the radio frequency voltage that is conducted back onto the AC power line on any frequency or frequencies within the band 150 kHz to 30 MHz shall not exceed below limits table.

Frequency (MHz)	QP Limit (dBuV)	AV Limit (dBuV)
0.15~0.5	66~56	56~46
0.5~5	56	46
5~30	60	50

4.1.2. Measuring Instruments and Setting

Please refer to section 5 of equipments list in this report. The following table is the setting of the receiver.

Receiver Parameters	Setting
Attenuation	10 dB
Start Frequency	0.15 MHz
Stop Frequency	30 MHz
IF Bandwidth	9 kHz

4.1.3. Test Procedures

1. Configure the EUT according to ANSI C63.10. The EUT or host of EUT has to be placed 0.4 meter far from the conducting wall of the shielding room and at least 80 centimeters from any other grounded conducting surface.
2. Connect EUT or host of EUT to the power mains through a line impedance stabilization network (LISN).
3. All the support units are connected to the other LISNs. The LISN should provide 50uH/50ohms coupling impedance.
4. The frequency range from 150 kHz to 30 MHz was searched.
5. Set the test-receiver system to Peak Detect Function and Specified Bandwidth with Maximum Hold Mode.
6. The measurement has to be done between each power line and ground at the power terminal.

4.1.4. Test Setup Layout

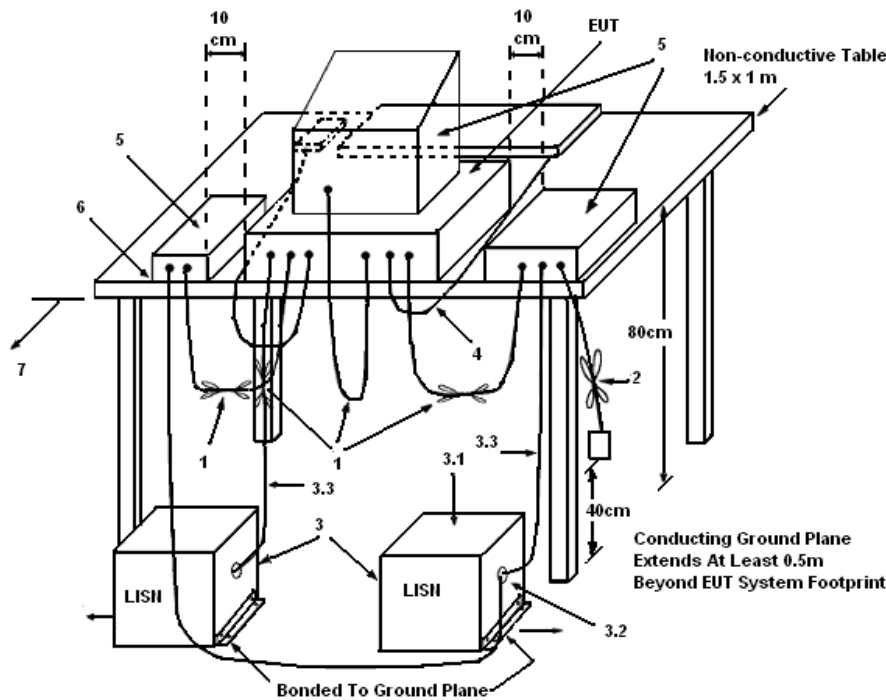

LEGEND:

- (1) Interconnecting cables that hang closer than 40 cm to the ground plane shall be folded back and forth in the center forming a bundle 30 to 40 cm long.
- (2) I/O cables that are not connected to a peripheral shall be bundled in the center. The end of the cable may be terminated, if required, using the correct terminating impedance. The overall length shall not exceed 1 m.
- (3) EUT connected to one LISN. Unused LISN measuring port connectors shall be terminated in 50 Ω . LISN can be placed on top of, or immediately beneath, reference ground plane.
 - (3.1) All other equipment powered from additional LISN(s).
 - (3.2) Multiple outlet strip can be used for multiple power cords of non-EUT equipment.
 - (3.3) LISN at least 80 cm from nearest part of EUT chassis.
- (4) Cables of hand-operated devices, such as keyboards, mice, etc., shall be placed as for normal use.
- (5) Non-EUT components of EUT system being tested.
- (6) Rear of EUT, including peripherals, shall all be aligned and flush with rear of tabletop.
- (7) Rear of tabletop shall be 40 cm removed from a vertical conducting plane that is bonded to the ground plane.

4.1.5. Test Deviation

There is no deviation with the original standard.

4.1.6. EUT Operation during Test

The EUT was placed on the test table and programmed in normal function.

4.1.7. Results of AC Power Line Conducted Emissions Measurement

Temperature	24°C	Humidity	54%
Test Engineer	Parody Lin	Phase	Line
Configuration	CTX		

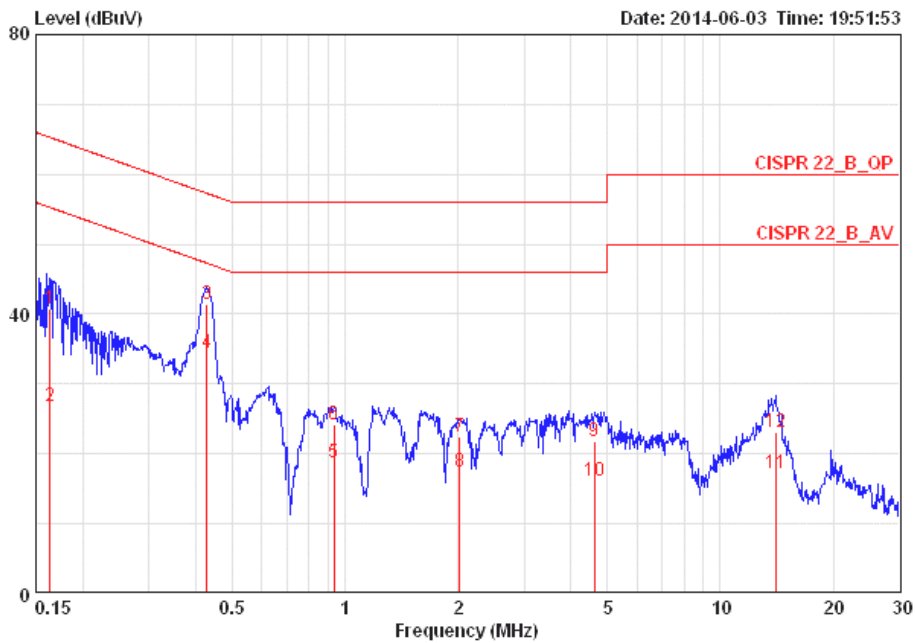

	Freq	Level	Over Limit	Limit Line	LISN Factor	Read Level	Cable Loss	Pol/Phase	Remark	Factor
	MHz	dB μ V	dB	dB μ V	dB	dB μ V	dB			dB
1	0.16327	40.87	-24.43	65.30	0.08	40.60	0.19	LINE	QP	0.27
2	0.16327	26.77	-28.53	55.30	0.08	26.50	0.19	LINE	AVERAGE	0.27
3	0.42825	41.36	-15.93	57.29	0.08	41.08	0.20	LINE	QP	0.28
4	0.42825	34.40	-12.89	47.29	0.08	34.12	0.20	LINE	AVERAGE	0.28
5	0.93314	18.75	-27.25	46.00	0.09	18.48	0.18	LINE	AVERAGE	0.27
6	0.93314	24.30	-31.70	56.00	0.09	24.03	0.18	LINE	QP	0.27
7	2.023	22.43	-33.57	56.00	0.12	22.08	0.23	LINE	QP	0.35
8	2.023	17.38	-28.62	46.00	0.12	17.03	0.23	LINE	AVERAGE	0.35
9	4.622	21.71	-34.29	56.00	0.16	21.24	0.31	LINE	QP	0.47
10	4.622	16.10	-29.90	46.00	0.16	15.63	0.31	LINE	AVERAGE	0.47
11	14.063	17.29	-32.71	50.00	0.30	16.59	0.40	LINE	AVERAGE	0.70
12	14.063	23.15	-36.85	60.00	0.30	22.45	0.40	LINE	QP	0.70

Temperature	24°C	Humidity	54%
Test Engineer	Parody Lin	Phase	Neutral
Configuration	CTX		

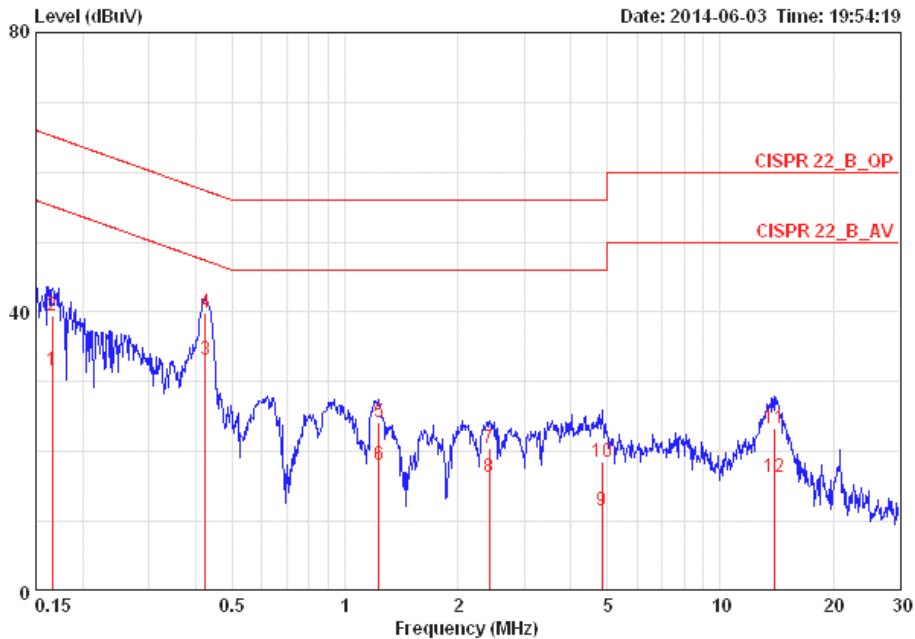

	Freq	Level	Over	Limit	LISN	Read	Cable	Pol/Phase	Remark	Factor
	MHz	dBuV	dB	dBuV	dB	dBuV	dB			dB
1	0.16589	31.58	-23.59	55.16	0.08	31.31	0.19	NEUTRAL	AVERAGE	0.27
2	0.16589	39.50	-25.67	65.16	0.08	39.23	0.19	NEUTRAL	QP	0.27
3	0.42373	33.04	-14.33	47.37	0.09	32.75	0.20	NEUTRAL	AVERAGE	0.29
4	0.42373	39.86	-17.51	57.37	0.09	39.57	0.20	NEUTRAL	QP	0.29
5	1.229	24.28	-31.72	56.00	0.10	23.97	0.21	NEUTRAL	QP	0.31
6	1.229	18.11	-27.89	46.00	0.10	17.80	0.21	NEUTRAL	AVERAGE	0.31
7	2.422	20.55	-35.45	56.00	0.13	20.18	0.24	NEUTRAL	QP	0.37
8	2.422	16.25	-29.75	46.00	0.13	15.88	0.24	NEUTRAL	AVERAGE	0.37
9	4.848	11.45	-34.55	46.00	0.17	10.96	0.32	NEUTRAL	AVERAGE	0.49
10	4.848	18.60	-37.40	56.00	0.17	18.11	0.32	NEUTRAL	QP	0.49
11	13.915	23.22	-36.78	60.00	0.30	22.52	0.40	NEUTRAL	QP	0.70
12	13.915	16.26	-33.74	50.00	0.30	15.56	0.40	NEUTRAL	AVERAGE	0.70

Note:

Level = Read Level + LISN Factor + Cable Loss.

4.2. Maximum Conducted Output Power Measurement

4.2.1. Limit

For systems using digital modulation in the 2400-2483.5MHz, the limit for output power is 30dBm. The limited has to be reduced by the amount in dB that the gain of the antenna exceed 6dBi. In case of point-to-point operation, the limit has to be reduced by 1dB for every 3dB that the directional gain of the antenna exceeds 6dBi.

4.2.2. Measuring Instruments and Setting

Please refer to section 5 of equipments list in this report. The following table is the setting of the power meter.

Power Meter Parameter	Setting
Bandwidth	50MHz bandwidth is greater than the EUT emission bandwidth
Detector	Average

4.2.3. Test Procedures

1. Test procedures refer KDB 558074 D01 v03r01 section 9.2.2 Measurement using a power meter (PM).
2. This procedure provides an alternative for determining the RMS output power using a broadband RF average power meter with a thermocouple detector.

4.2.4. Test Setup Layout

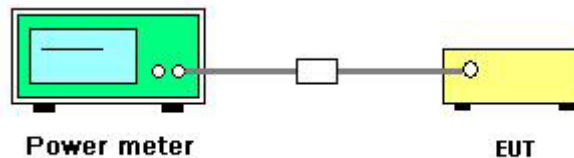

4.2.5. Test Deviation

There is no deviation with the original standard.

4.2.6. EUT Operation during Test

The EUT was programmed to be in continuously transmitting mode.

4.2.7. Test Result of Maximum Conducted Output Power

Temperature	20°C	Humidity	53%
Test Engineer	Jim Huang	Configurations	IEEE 802.11n
Test Date	Jun. 03, 2014		

Configuration IEEE 802.11n MCS0 HT20

Channel	Frequency	Conducted Power (dBm)			Max. Limit (dBm)	Result
		Ant. 1	Ant. 2	Total		
1	2412 MHz	13.83	13.23	16.55	30.00	Complies
6	2437 MHz	17.26	17.25	20.27	30.00	Complies
11	2462 MHz	13.50	12.95	16.24	30.00	Complies

Configuration IEEE 802.11n MCS0 HT40

Channel	Frequency	Conducted Power (dBm)			Max. Limit (dBm)	Result
		Ant. 1	Ant. 2	Total		
3	2422 MHz	10.26	10.22	13.25	30.00	Complies
6	2437 MHz	13.48	13.38	16.44	30.00	Complies
9	2452 MHz	13.77	13.94	16.87	30.00	Complies

Temperature	20°C	Humidity	53%
Test Engineer	Jim Huang	Configurations	IEEE 802.11b/g
Test Date	Jun. 03, 2014		

Configuration IEEE 802.11b / Ant. 2

Channel	Frequency	Conducted Power (dBm)	Max. Limit (dBm)	Result
1	2412 MHz	19.03	30.00	Complies
6	2437 MHz	18.05	30.00	Complies
11	2462 MHz	14.66	30.00	Complies

Configuration IEEE 802.11g

Channel	Frequency	Conducted Power (dBm)			Max. Limit (dBm)	Result
		Ant. 1	Ant. 2	Total		
1	2412 MHz	14.45	14.32	17.40	30.00	Complies
6	2437 MHz	16.99	17.41	20.22	30.00	Complies
11	2462 MHz	13.56	13.40	16.49	30.00	Complies

4.3. Power Spectral Density Measurement

4.3.1. Limit

For digitally modulated systems, the power spectral density conducted from the intentional radiator to the antenna shall not be greater than 8 dBm in any 3 kHz band during any time interval of continuous transmission.

4.3.2. Measuring Instruments and Setting

Please refer to section 5 of equipments list in this report. The following table is the setting of the spectrum analyzer.

Spectrum Parameter	Setting
Attenuation	Auto
Span Frequency	Set the span to 1.5 times the DTS channel bandwidth.
RBW	$3 \text{ kHz} \leq \text{RBW} \leq 100\text{kHz}$
VBW	$\geq 3 \times \text{RBW}$
Detector	Peak
Trace	Max Hold
Sweep Time	Auto couple

4.3.3. Test Procedures

1. Test procedures refer KDB 558074 D01 v03r01 section 10.2 Method PKPSD (peak PSD) and KDB 662911 D01 v02r01 section In-Band Power Spectral Density (PSD) Measurements option (b) Measure and sum spectral maximal across the outputs.
2. Use this procedure when the maximum conducted output power in the fundamental emission is used to demonstrate compliance. The EUT must be configured to transmit continuously at full power over the measurement duration.
3. Ensure that the number of measurement points in the sweep $\geq 2 \times \text{span}/\text{RBW}$ (use of a greater number of measurement points than this minimum requirement is recommended).
4. Use the peak marker function to determine the maximum level in any 3 kHz band segment within the fundamental EBW.
5. The resulting PSD level must be $\leq 8 \text{ dBm}$.

4.3.4. Test Setup Layout

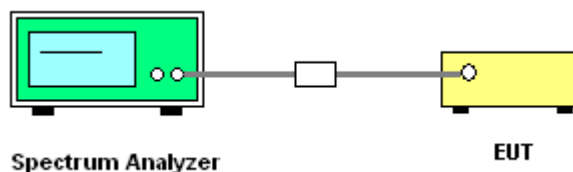

4.3.5. Test Deviation

There is no deviation with the original standard.

4.3.6. EUT Operation during Test

The EUT was programmed to be in continuously transmitting mode.

4.3.7. Test Result of Power Spectral Density

Temperature	20°C	Humidity	53%
Test Engineer	Jim Huang	Configurations	IEEE 802.11n

Configuration IEEE 802.11n MCS0 HT20

Channel	Frequency	Power Density (dBm/3kHz)			Power Density Limit (dBm/3kHz)	Result
		Ant. 1	Ant. 2	Total		
1	2412 MHz	-10.09	-10.35	-7.21	8.00	Complies
6	2437 MHz	-6.89	-7.36	-4.11	8.00	Complies
11	2462 MHz	-10.92	-12.11	-8.46	8.00	Complies

Configuration IEEE 802.11n MCS0 HT40

Channel	Frequency	Power Density (dBm/3kHz)			Power Density Limit (dBm/3kHz)	Result
		Ant. 1	Ant. 2	Total		
3	2422 MHz	-18.66	-16.49	-14.43	8.00	Complies
6	2437 MHz	-15.35	-14.00	-11.61	8.00	Complies
9	2452 MHz	-15.09	-14.38	-11.71	8.00	Complies

Temperature	20°C	Humidity	53%
Test Engineer	Jim Huang	Configurations	IEEE 802.11b/g

Configuration IEEE 802.11b / Ant. 2

Channel	Frequency	Power Density (dBm/3kHz)	Power Density Limit (dBm/3kHz)	Result
1	2412 MHz	-4.00	8.00	Complies
6	2437 MHz	-4.56	8.00	Complies
11	2462 MHz	-7.47	8.00	Complies

Configuration IEEE 802.11g

Channel	Frequency	Power Density (dBm/3kHz)			Power Density Limit (dBm/3kHz)	Result
		Ant. 1	Ant. 2	Total		
1	2412 MHz	-9.96	-9.99	-6.96	8.00	Complies
6	2437 MHz	-7.44	-7.81	-4.61	8.00	Complies
11	2462 MHz	-10.89	-11.33	-8.09	8.00	Complies

Note: All the test values were listed in the report.

For plots, only the channel with worse result was shown.

Power Density Plot on Configuration IEEE 802.11n MCS0 HT20 / 2437 MHz / Ant. 1

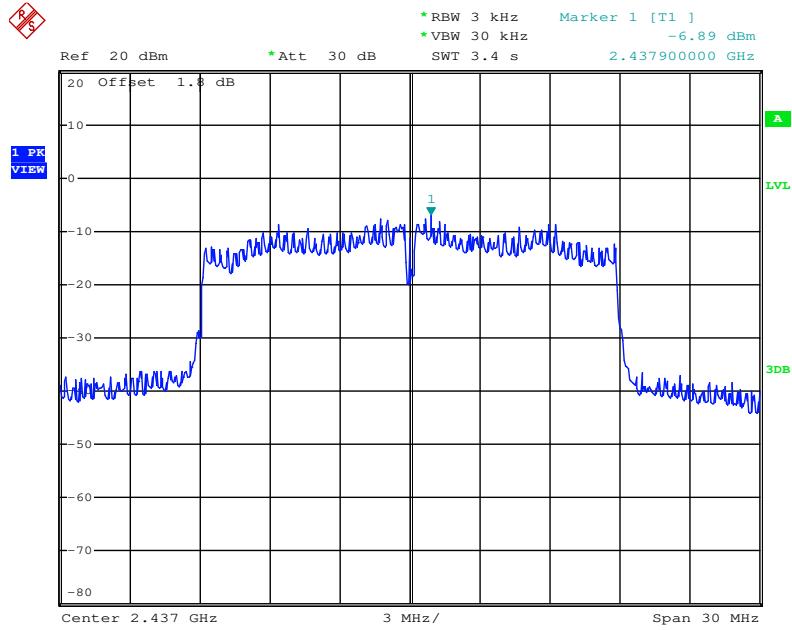

Date: 3.JUN.2014 12:36:36

Power Density Plot on Configuration IEEE 802.11n MCS0 HT20 / 2437 MHz / Ant. 2

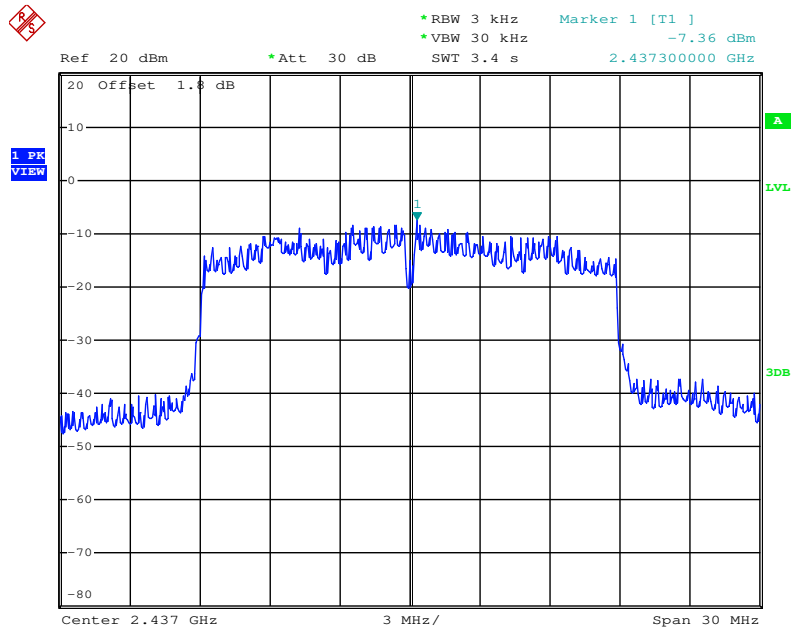

Date: 3.JUN.2014 12:26:33

Power Density Plot on Configuration IEEE 802.11n MCS0 HT40 / 2437 MHz / Ant. 1

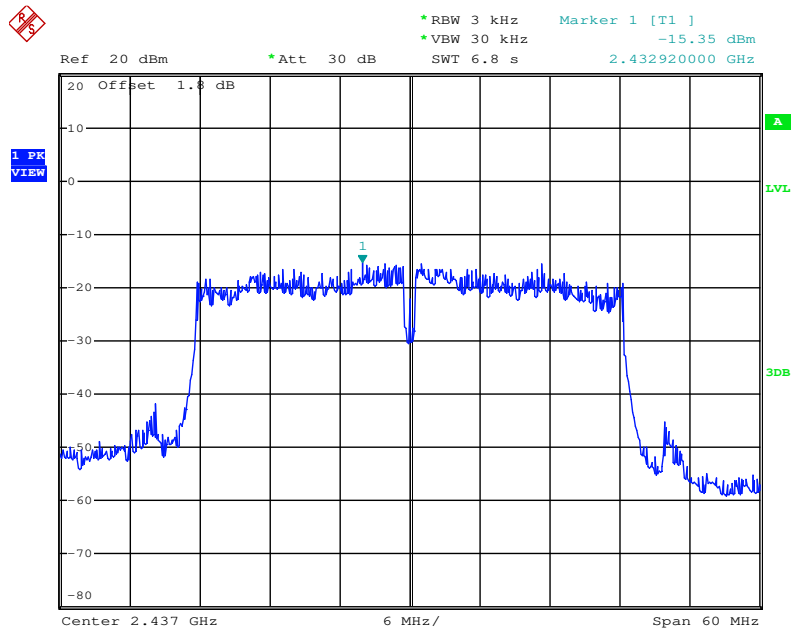

Date: 3.JUN.2014 12:32:55

Power Density Plot on Configuration IEEE 802.11n MCS0 HT40 / 2437 MHz / Ant. 2

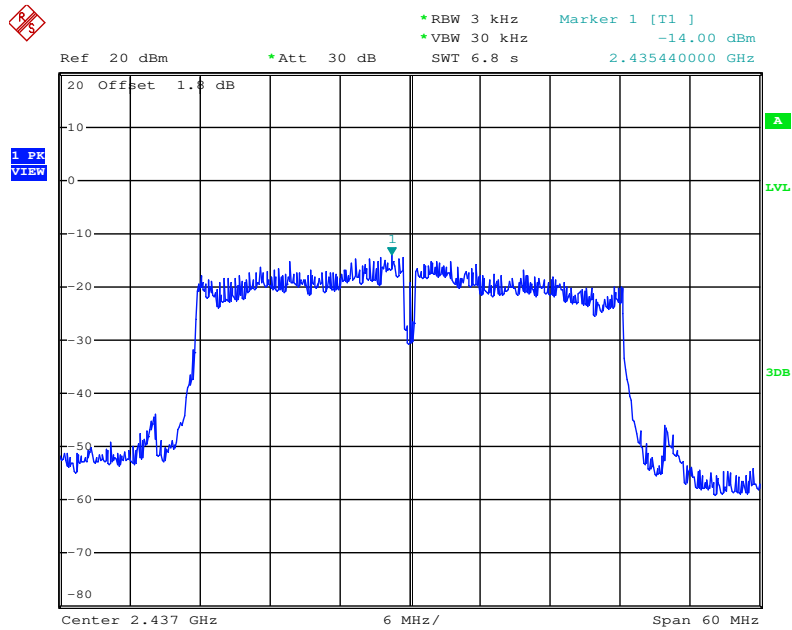

Date: 3.JUN.2014 12:29:39

Power Density Plot on Configuration IEEE 802.11b / 2412 MHz / Ant. 2

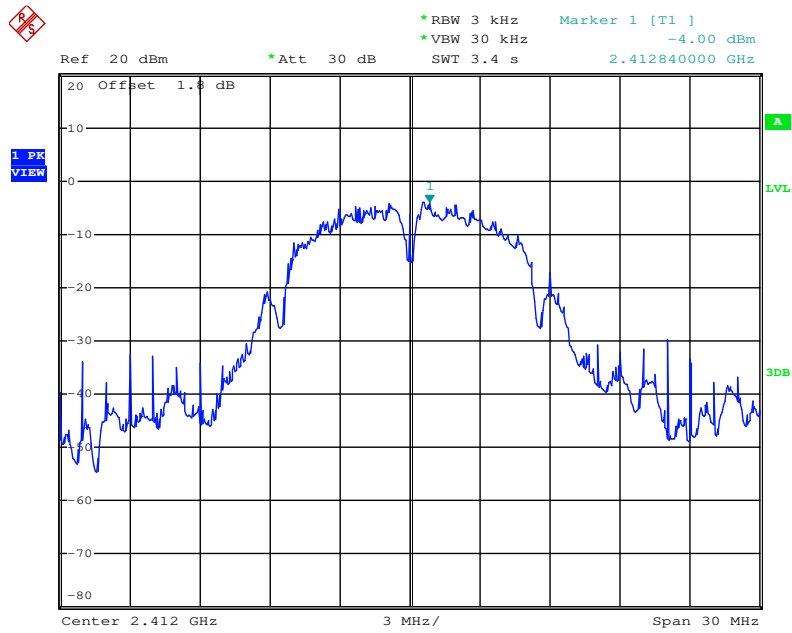

Date: 3.JUN.2014 12:17:49

Power Density Plot on Configuration IEEE 802.11g / 2437 MHz / Ant. 1

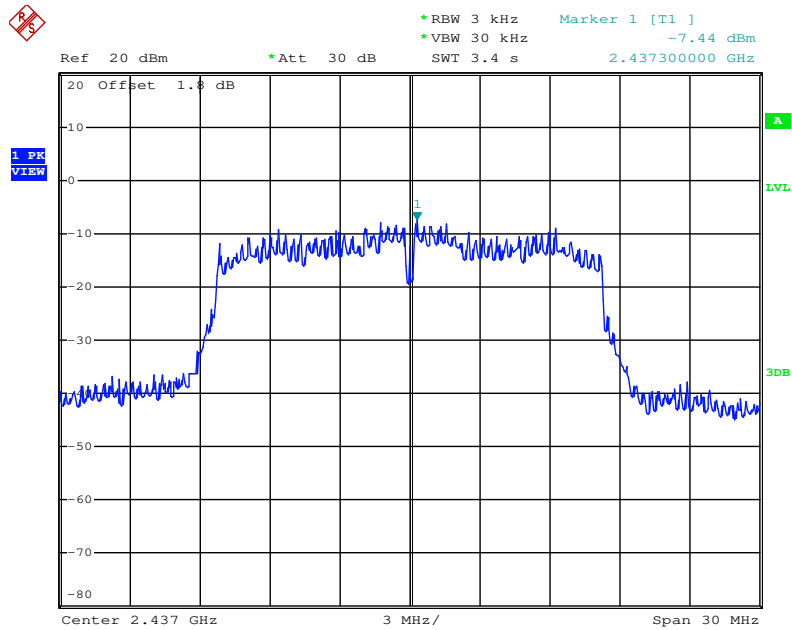

Date: 3.JUN.2014 12:39:30

Power Density Plot on Configuration IEEE 802.11g / 2437 MHz / Ant. 2

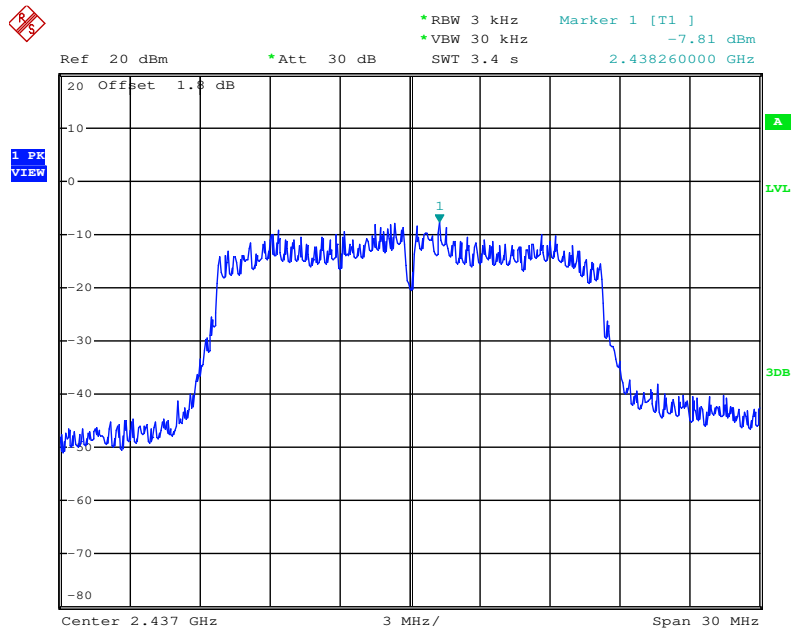

Date: 3.JUN.2014 12:22:22

4.4. 6dB Spectrum Bandwidth Measurement

4.4.1. Limit

For digital modulation systems, the minimum 6 dB bandwidth shall be at least 500 kHz.

4.4.2. Measuring Instruments and Setting

Please refer to section 5 of equipments list in this report. The following table is the setting of the Spectrum Analyzer.

Spectrum Parameters	Setting
Attenuation	Auto
Span Frequency	> 6dB Bandwidth
RBW	100kHz
VBW	$\geq 3 \times \text{RBW}$
Detector	Peak
Trace	Max Hold
Sweep Time	Auto

4.4.3. Test Procedures

For Radiated 6dB Bandwidth Measurement:

1. The transmitter was radiated to the spectrum analyzer in peak hold mode.
2. Test was performed in accordance with KDB 558074 D01 v03r01 for Performing Compliance Measurements on Digital Transmission Systems (DTS) Operating Under §15.247 section 8.0 DTS 6-dB signal bandwidth option 1.
3. Multiple antenna system was performed in accordance with KDB 662911 D01 v02r01 Emissions Testing of Transmitters with Multiple Outputs in the Same Band.
4. Measured the spectrum width with power higher than 6dB below carrier.

4.4.4. Test Setup Layout

For Radiated 6dB Bandwidth Measurement:

This test setup layout is the same as that shown in section 4.5.4.

4.4.5. Test Deviation

There is no deviation with the original standard.

4.4.6. EUT Operation during Test

The EUT was programmed to be in continuously transmitting mode.

4.4.7. Test Result of 6dB Spectrum Bandwidth

Temperature	20°C	Humidity	53%
Test Engineer	Jim Huang	Configurations	IEEE 802.11n

Configuration IEEE 802.11n MCS0 HT20 / Ant. 1 + Ant. 2

Channel	Frequency	6dB Bandwidth (MHz)	99% Occupied Bandwidth (MHz)	Min. Limit (kHz)	Test Result
1	2412 MHz	17.36	17.68	500	Complies
6	2437 MHz	10.08	16.64	500	Complies
11	2462 MHz	15.04	17.52	500	Complies

Configuration IEEE 802.11n MCS0 HT40 / Ant. 1 + Ant. 2

Channel	Frequency	6dB Bandwidth (MHz)	99% Occupied Bandwidth (MHz)	Min. Limit (kHz)	Test Result
3	2422 MHz	34.24	36.48	500	Complies
6	2437 MHz	31.36	35.84	500	Complies
9	2452 MHz	27.84	35.52	500	Complies

Temperature	20°C	Humidity	53%
Test Engineer	Jim Huang	Configurations	IEEE 802.11 b/g

Configuration IEEE 802.11b / Ant. 2

Channel	Frequency	6dB Bandwidth (MHz)	99% Occupied Bandwidth (MHz)	Min. Limit (kHz)	Test Result
1	2412 MHz	7.52	10.24	500	Complies
6	2437 MHz	8.00	10.24	500	Complies
11	2462 MHz	7.92	10.08	500	Complies

Configuration IEEE 802.11g / Ant. 1 + Ant. 2

Channel	Frequency	6dB Bandwidth (MHz)	99% Occupied Bandwidth (MHz)	Min. Limit (kHz)	Test Result
1	2412 MHz	14.40	15.60	500	Complies
6	2437 MHz	11.44	15.76	500	Complies
11	2462 MHz	11.60	16.24	500	Complies

Note: All the test values were listed in the report.

For plots, only the channel with worse result was shown.

6 dB Bandwidth Plot on Configuration IEEE 802.11n MCS0 HT20 / 2437 MHz / Ant. 1 + Ant. 2

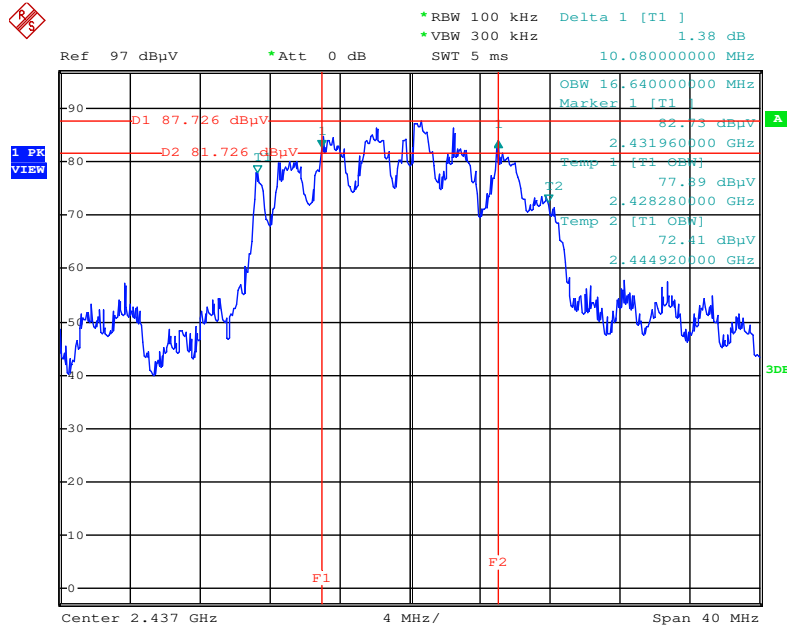

Date: 3.JUN.2014 13:03:09

6 dB Bandwidth Plot on Configuration IEEE 802.11n MCS0 HT40 / 2452 MHz / Ant. 1 + Ant. 2

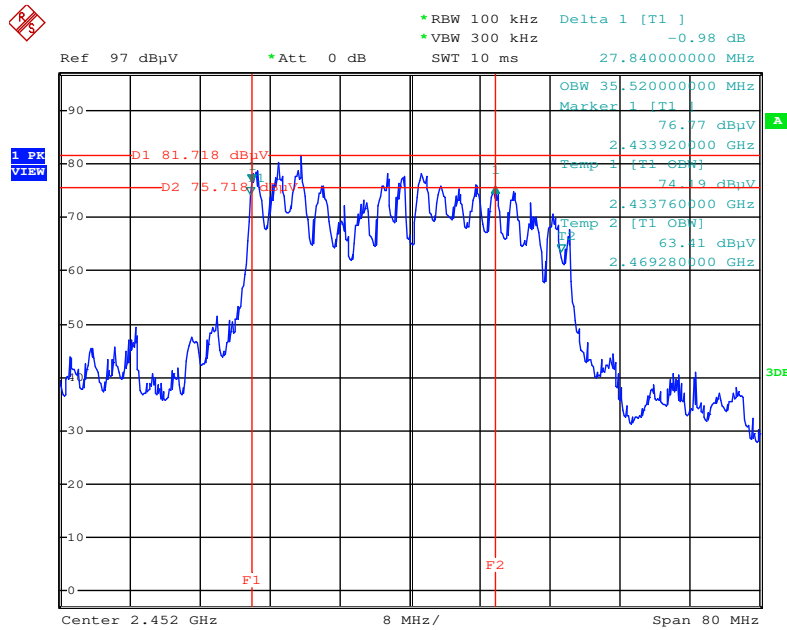

Date: 3.JUN.2014 13:06:05

6 dB Bandwidth Plot on Configuration IEEE 802.11b / 2412 MHz / Ant. 2

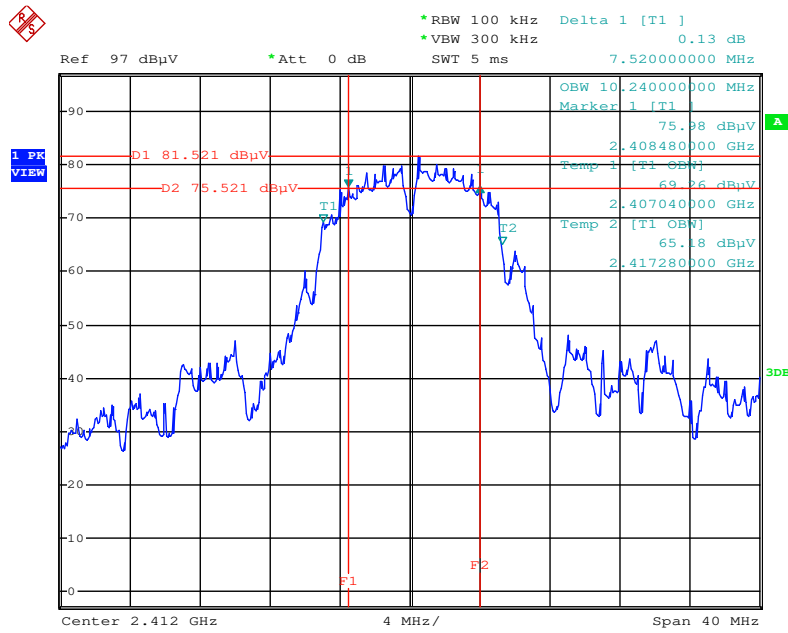

Date: 3.JUN.2014 12:44:25

6 dB Bandwidth Plot on Configuration IEEE 802.11g / 2437 MHz / Ant. 1 + Ant. 2

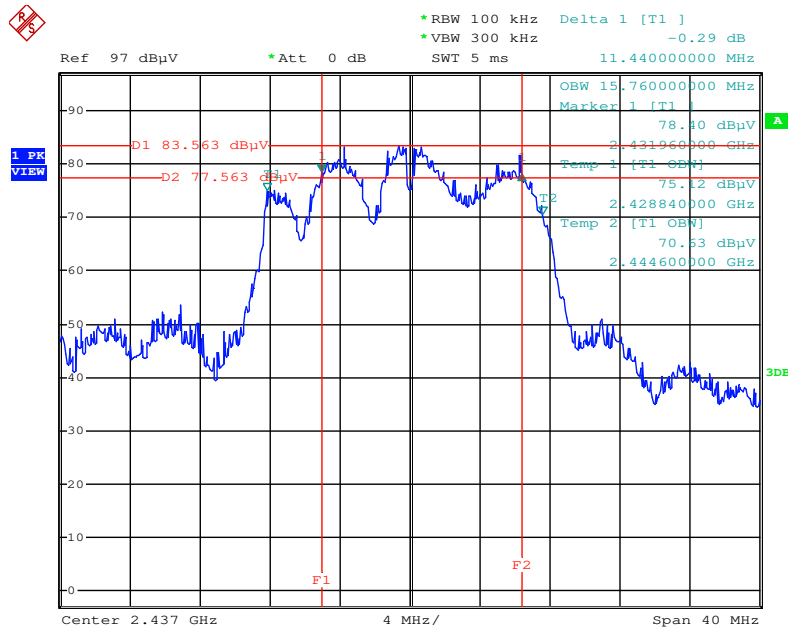

Date: 3.JUN.2014 13:00:13

4.5. Radiated Emissions Measurement

4.5.1. Limit

30dBc in any 100 kHz bandwidth outside the operating frequency band. In case the emission fall within the restricted band specified on 15.205(a), then the 15.209(a) limit in the table below has to be followed.

Frequencies (MHz)	Field Strength (micorvolts/meter)	Measurement Distance (meters)
0.009~0.490	2400/F(kHz)	300
0.490~1.705	24000/F(kHz)	30
1.705~30.0	30	30
30~88	100	3
88~216	150	3
216~960	200	3
Above 960	500	3

4.5.2. Measuring Instruments and Setting

Please refer to section 5 of equipments list in this report. The following table is the setting of spectrum analyzer and receiver.

Spectrum Parameter	Setting
Attenuation	Auto
Start Frequency	1000 MHz
Stop Frequency	10th carrier harmonic
RBW / VBW (Emission in restricted band)	1MHz / 3MHz for Peak, 1MHz / 10Hz for Average
RBW / VBW (Emission in non-restricted band)	100kHz / 300kHz for peak

Receiver Parameter	Setting
Attenuation	Auto
Start ~ Stop Frequency	9kHz~150kHz / RBW 200Hz for QP
Start ~ Stop Frequency	150kHz~30MHz / RBW 9kHz for QP
Start ~ Stop Frequency	30MHz~1000MHz / RBW 120kHz for QP

4.5.3. Test Procedures

1. Configure the EUT according to ANSI C63.10. The EUT was placed on the top of the turntable 0.8 meter above ground. The phase center of the receiving antenna mounted on the top of a height-variable antenna tower was placed 3 meters far away from the turntable.
2. Power on the EUT and all the supporting units. The turntable was rotated by 360 degrees to determine the position of the highest radiation.
3. The height of the broadband receiving antenna was varied between one meter and four meters above ground to find the maximum emissions field strength of both horizontal and vertical polarization.
4. For each suspected emissions, the antenna tower was scan (from 1 m to 4 m) and then the turntable was rotated (from 0 degree to 360 degrees) to find the maximum reading.
5. Set the test-receiver system to Peak or CISPR quasi-peak Detect Function with specified bandwidth under Maximum Hold Mode.
6. For emissions above 1GHz, use 1MHz VBW and 3MHz RBW for peak reading. Then 1MHz RBW and 10Hz VBW for average reading in spectrum analyzer.
7. If the emissions level of the EUT in peak mode was 3 dB lower than the average limit specified, then testing will be stopped and peak values of EUT will be reported, otherwise, the emissions which do not have 3 dB margin will be repeated one by one using the quasi-peak method for below 1GHz.
8. For testing above 1GHz, the emissions level of the EUT in peak mode was lower than average limit (that means the emissions level in peak mode also complies with the limit in average mode), then testing will be stopped and peak values of EUT will be reported, otherwise, the emissions will be measured in average mode again and reported.
9. In case the emission is lower than 30MHz, loop antenna has to be used for measurement and the recorded data should be QP measured by receiver. High – Low scan is not required in this case.

4.5.4. Test Setup Layout

For Radiated Emissions: 9kHz ~30MHz

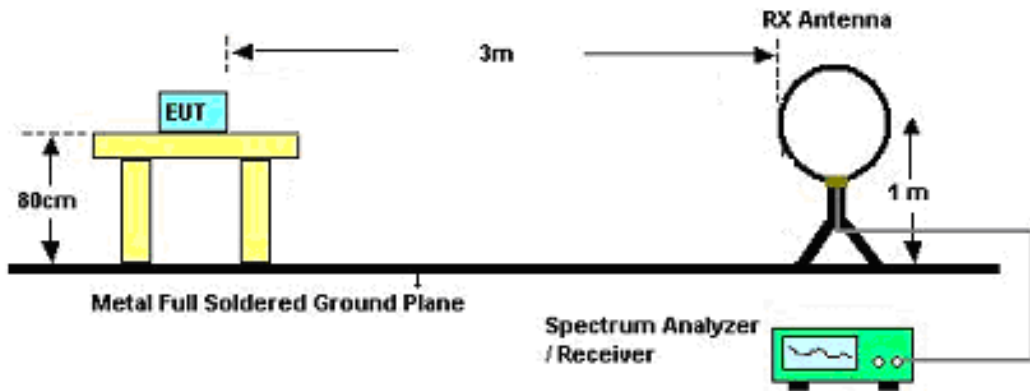

For Radiated Emissions: 30MHz~1GHz

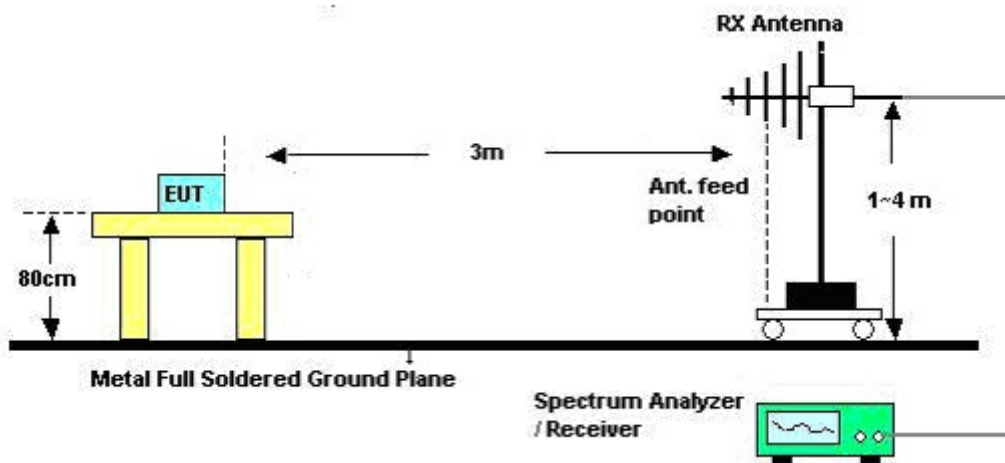

For Radiated Emissions: Above 1GHz

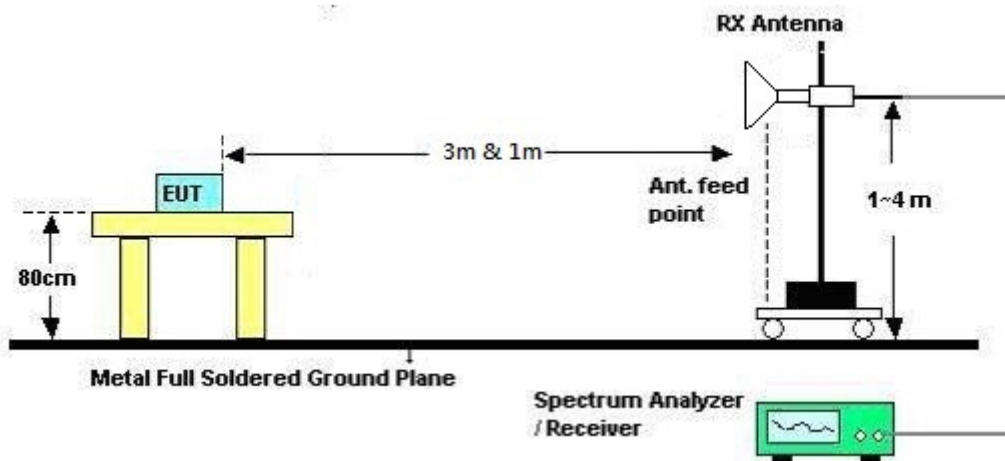

4.5.5. Test Deviation

There is no deviation with the original standard.

4.5.6. EUT Operation during Test

The EUT was programmed to be in continuously transmitting mode.

4.5.7. Results of Radiated Emissions (9kHz~30MHz)

Temperature	26°C	Humidity	62%
Test Engineer	YC Chen	Configurations	CTX
Test Date	May 30, 2014		

Freq. (MHz)	Level (dBuV)	Over Limit (dB)	Limit Line (dBuV)	Remark
-	-	-	-	See Note

Note:

The amplitude of spurious emissions which are attenuated by more than 20 dB below the permissible value has no need to be reported.

Distance extrapolation factor = $40 \log(\text{specific distance} / \text{test distance})$ (dB);

Limit line = specific limits (dBuV) + distance extrapolation factor.

4.5.8. Results of Radiated Emissions (30MHz~1GHz)

Temperature	26°C	Humidity	62%
Test Engineer	YC Chen	Configurations	CTX

Horizontal

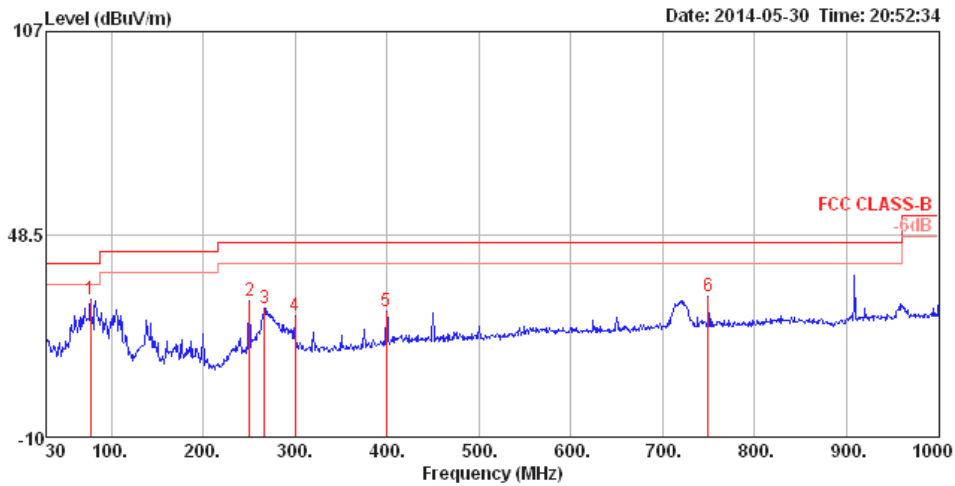

	Freq	Level	Limit	Over	Read	Cable	Antenna	Preamp	A/Pos	T/Pos	Pol/Phase	Remark
	MHz	dBuV/m	dBuV/m	dB	dBuV	dB	dB/m	dB	cm	deg		
1	77.53	29.63	40.00	-10.37	53.77	1.03	6.53	31.70	200	266	HORIZONTAL	Peak
2	250.19	29.38	46.00	-16.62	47.06	1.90	11.91	31.49	125	126	HORIZONTAL	Peak
3	266.68	27.06	46.00	-18.94	44.11	1.97	12.53	31.55	100	149	HORIZONTAL	Peak
4	299.66	24.93	46.00	-21.07	41.20	2.13	13.02	31.42	100	124	HORIZONTAL	Peak
5	399.57	26.15	46.00	-19.85	39.26	2.49	15.86	31.46	100	46	HORIZONTAL	Peak
6	749.74	30.68	46.00	-15.32	38.83	3.53	19.69	31.37	125	156	HORIZONTAL	Peak

Vertical

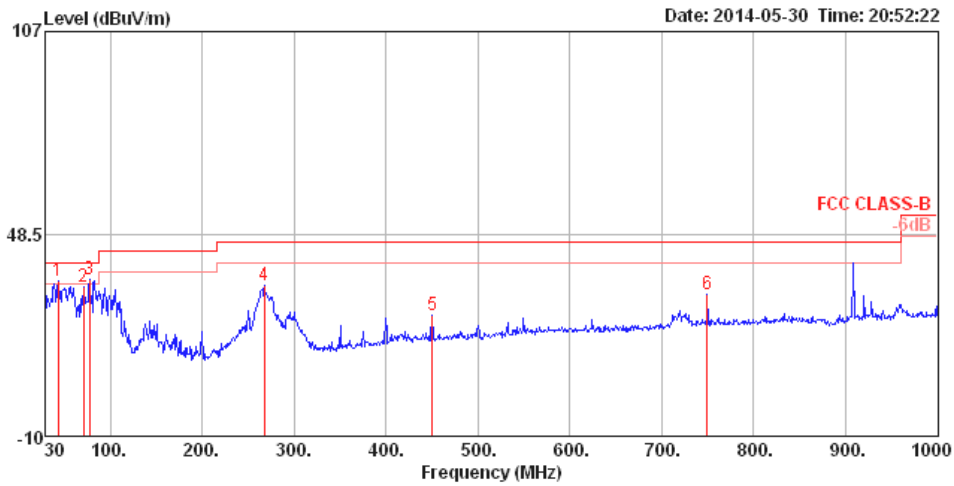

	Freq	Level	Limit	Over	Read	CableAntenna	Preamp	A/Pos	T/Pos	Pol/Phase	Remark
	MHz	dBuV/m	dBuV/m	dB	dBuV	dB	dB/m	dB	cm	deg	
1	43.58	34.70	40.00	-5.30	55.51	0.78	10.25	31.84	125	125 VERTICAL	Peak
2	70.74	33.35	40.00	-6.65	58.73	1.00	5.39	31.77	125	324 VERTICAL	Peak
3	77.53	35.16	40.00	-4.84	59.30	1.03	6.53	31.70	125	2 VERTICAL	Peak
4	267.65	33.53	46.00	-12.47	50.63	1.98	12.47	31.55	200	150 VERTICAL	Peak
5	450.01	25.08	46.00	-20.92	37.42	2.65	16.20	31.19	125	110 VERTICAL	Peak
6	749.74	30.82	46.00	-15.18	38.97	3.53	19.69	31.37	100	2 VERTICAL	Peak

Note:

The amplitude of spurious emissions which are attenuated by more than 20 dB below the permissible value has no need to be reported.

Emission level (dBuV/m) = 20 log Emission level (uV/m).

Corrected Reading: Antenna Factor + Cable Loss + Read Level - Preamp Factor = Level.

4.5.9. Results for Radiated Emissions (1GHz~10th Harmonic)

Temperature	26°C	Humidity	62%
Test Engineer	YC Chen	Configurations	IEEE 802.11n MCS0 HT20 CH 1 / Ant. 1 + Ant. 2
Test Date	May 26, 2014		

Horizontal

	Freq	Level	Limit Line	Over Limit	Read Level	Cable Loss	Antenna Factor	Preamp Factor	Remark	A/Pos	T/Pos	Pol/Phase
	MHz	dBuV/m	dBuV/m	dB	dBuV	dB	dB/m	dB		cm	deg	
1	4819.51	51.00	74.00	-23.00	49.05	3.31	33.56	34.92	Peak	135	21	HORIZONTAL
2	4824.16	37.26	54.00	-16.74	35.31	3.31	33.56	34.92	Average	135	21	HORIZONTAL

Vertical

	Freq	Level	Limit Line	Over Limit	Read Level	Cable Loss	Antenna Factor	Preamp Factor	Remark	A/Pos	T/Pos	Pol/Phase
	MHz	dBuV/m	dBuV/m	dB	dBuV	dB	dB/m	dB		cm	deg	
1	4821.68	53.84	74.00	-20.16	51.89	3.31	33.56	34.92	Peak	100	311	VERTICAL
2	4823.84	39.48	54.00	-14.52	37.53	3.31	33.56	34.92	Average	100	311	VERTICAL

Temperature	26°C	Humidity	62%
Test Engineer	YC Chen	Configurations	IEEE 802.11n MCS0 HT20 CH 6 / Ant. 1 + Ant. 2
Test Date	May 26, 2014		

Horizontal

	Freq	Level	Limit Line	Over Limit	Read Level	CableAntenna Loss Factor	Preamp Factor	Remark	A/Pos	T/Pos	Pol/Phase
	MHz	dBuV/m	dBuV/m	dB	dBuV	dB	dB/m	dB	cm	deg	
1	4873.84	59.48	74.00	-14.52	57.41	3.33	33.66	34.92	Peak	121	320 HORIZONTAL
2	4874.10	46.06	54.00	-7.94	43.99	3.33	33.66	34.92	Average	121	320 HORIZONTAL
3	7311.90	50.64	54.00	-3.36	45.13	4.06	36.64	35.19	Average	100	316 HORIZONTAL
4	7314.49	64.11	74.00	-9.89	58.60	4.06	36.64	35.19	Peak	100	316 HORIZONTAL

Vertical

	Freq	Level	Limit Line	Over Limit	Read Level	CableAntenna Loss Factor	Preamp Factor	Remark	A/Pos	T/Pos	Pol/Phase
	MHz	dBuV/m	dBuV/m	dB	dBuV	dB	dB/m	dB	cm	deg	
1	4872.53	41.26	54.00	-12.74	39.19	3.33	33.66	34.92	Average	100	325 VERTICAL
2	4874.55	55.16	74.00	-18.84	53.09	3.33	33.66	34.92	Peak	100	325 VERTICAL
3	7309.05	68.33	74.00	-5.67	62.82	4.06	36.64	35.19	Peak	103	29 VERTICAL
4	7309.24	53.55	54.00	-0.45	48.04	4.06	36.64	35.19	Average	103	29 VERTICAL

Temperature	26°C	Humidity	62%
Test Engineer	YC Chen	Configurations	IEEE 802.11n MCS0 HT20 CH 11 / Ant. 1 + Ant. 2
Test Date	May 26, 2014		

Horizontal

	Freq	Level	Limit	Over	Read	CableAntenna	Preamp	Remark	A/Pos	T/Pos	Pol/Phase
	MHz	dBuV/m	dBuV/m	dB	dBuV	dB	dB/m	dB	cm	deg	
1	4920.25	52.06	74.00	-21.94	49.86	3.35	33.76	34.91	100	319	HORIZONTAL
2	4923.20	39.29	54.00	-14.71	37.09	3.35	33.76	34.91	100	319	HORIZONTAL
3	7386.51	43.95	54.00	-10.05	38.25	4.06	36.85	35.21	100	314	HORIZONTAL
4	7388.92	57.73	74.00	-16.27	52.03	4.06	36.85	35.21	100	314	HORIZONTAL

Vertical

	Freq	Level	Limit	Over	Read	CableAntenna	Preamp	Remark	A/Pos	T/Pos	Pol/Phase
	MHz	dBuV/m	dBuV/m	dB	dBuV	dB	dB/m	dB	cm	deg	
1	4928.42	38.15	54.00	-15.85	35.95	3.35	33.76	34.91	100	336	VERTICAL
2	4930.80	52.86	74.00	-21.14	50.66	3.35	33.76	34.91	100	336	VERTICAL
3	7386.22	48.06	54.00	-5.94	42.36	4.06	36.85	35.21	102	29	VERTICAL
4	7386.29	62.62	74.00	-11.38	56.92	4.06	36.85	35.21	102	29	VERTICAL

Temperature	26°C	Humidity	62%
Test Engineer	YC Chen	Configurations	IEEE 802.11n MCS0 HT40 CH 3 / Ant. 1 + Ant. 2
Test Date	May 26, 2014		

Horizontal

	Freq	Level	Limit Line	Over Limit	Read Level	CableAntenna Loss	Antenna Factor	Preamp Factor	Remark	A/Pos	T/Pos	Pol/Phase
	MHz	dBuV/m	dBuV/m	dB	dBuV	dB	dB/m	dB		cm	deg	
1	4843.92	43.93	74.00	-30.07	41.94	3.32	33.59	34.92	Peak	120	332	HORIZONTAL
2	4844.00	34.47	54.00	-19.53	32.48	3.32	33.59	34.92	Average	120	332	HORIZONTAL
3	7271.37	35.66	54.00	-18.34	30.23	4.06	36.56	35.19	Average	100	264	HORIZONTAL
4	7282.19	47.79	74.00	-26.21	42.32	4.06	36.60	35.19	Peak	100	264	HORIZONTAL

Vertical

	Freq	Level	Limit Line	Over Limit	Read Level	CableAntenna Loss	Antenna Factor	Preamp Factor	Remark	A/Pos	T/Pos	Pol/Phase
	MHz	dBuV/m	dBuV/m	dB	dBuV	dB	dB/m	dB		cm	deg	
1	4843.92	30.96	54.00	-23.04	28.97	3.32	33.59	34.92	Average	100	21	VERTICAL
2	4850.01	42.94	74.00	-31.06	40.95	3.32	33.59	34.92	Peak	100	21	VERTICAL
3	7251.34	47.78	74.00	-26.22	42.38	4.06	36.52	35.18	Peak	100	102	VERTICAL
4	7268.56	35.32	54.00	-18.68	29.89	4.06	36.56	35.19	Average	100	102	VERTICAL

Temperature	26°C	Humidity	62%
Test Engineer	YC Chen	Configurations	IEEE 802.11n MCS0 HT40 CH 6 / Ant. 1 + Ant. 2
Test Date	May 26, 2014		

Horizontal

	Freq	Level	Limit Line	Over Limit	Read Level	CableAntenna Loss	Antenna Factor	Preamp Factor	Remark	A/Pos	T/Pos	Pol/Phase
	MHz	dBuV/m	dBuV/m	dB	dBuV	dB	dB/m	dB		cm	deg	
1	4866.55	48.12	74.00	-25.88	46.09	3.33	33.62	34.92	Peak	100	308	HORIZONTAL
2	4874.16	34.37	54.00	-19.63	32.30	3.33	33.66	34.92	Average	100	308	HORIZONTAL
3	7313.97	51.81	74.00	-22.19	46.30	4.06	36.64	35.19	Peak	116	318	HORIZONTAL
4	7319.49	41.16	54.00	-12.84	35.60	4.06	36.69	35.19	Average	116	318	HORIZONTAL

Vertical

	Freq	Level	Limit Line	Over Limit	Read Level	CableAntenna Loss	Antenna Factor	Preamp Factor	Remark	A/Pos	T/Pos	Pol/Phase
	MHz	dBuV/m	dBuV/m	dB	dBuV	dB	dB/m	dB		cm	deg	
1	4868.31	45.46	74.00	-28.54	43.39	3.33	33.66	34.92	Peak	101	217	VERTICAL
2	4877.77	34.04	54.00	-19.96	31.97	3.33	33.66	34.92	Average	101	217	VERTICAL
3	7316.93	43.30	54.00	-10.70	37.74	4.06	36.69	35.19	Average	102	25	VERTICAL
4	7319.01	56.63	74.00	-17.37	51.07	4.06	36.69	35.19	Peak	102	25	VERTICAL

Temperature	26°C	Humidity	62%
Test Engineer	YC Chen	Configurations	IEEE 802.11n MCS0 HT40 CH 9 / Ant. 1 + Ant. 2
Test Date	May 26, 2014		

Horizontal

	Freq	Level	Limit Line	Over Limit	Read Level	CableAntenna Loss Factor	Preamp Factor	Remark	A/Pos	T/Pos	Pol/Phase	
	MHz	dBuV/m	dBuV/m	dB	dBuV	dB	dB/m	dB	cm	deg		
1	4903.36	35.65	54.00	-18.35	33.49	3.34	33.73	34.91	Average	134	316	HORIZONTAL
2	4903.36	48.54	74.00	-25.46	46.38	3.34	33.73	34.91	Peak	134	316	HORIZONTAL
3	7345.98	54.54	74.00	-19.46	48.95	4.06	36.73	35.20	Peak	100	315	HORIZONTAL
4	7351.11	42.43	54.00	-11.57	36.80	4.06	36.77	35.20	Average	100	315	HORIZONTAL

Vertical

	Freq	Level	Limit Line	Over Limit	Read Level	CableAntenna Loss Factor	Preamp Factor	Remark	A/Pos	T/Pos	Pol/Phase	
	MHz	dBuV/m	dBuV/m	dB	dBuV	dB	dB/m	dB	cm	deg		
1	4917.38	35.28	54.00	-18.72	33.11	3.35	33.73	34.91	Average	101	243	VERTICAL
2	4917.54	48.48	74.00	-25.52	46.31	3.35	33.73	34.91	Peak	101	243	VERTICAL
3	7353.04	52.18	74.00	-21.82	46.55	4.06	36.77	35.20	Peak	100	53	VERTICAL
4	7355.76	40.42	54.00	-13.58	34.79	4.06	36.77	35.20	Average	100	53	VERTICAL

Note:

The amplitude of spurious emissions which are attenuated by more than 20 dB below the permissible value has no need to be reported.

Emission level (dBuV/m) = 20 log Emission level (uV/m).

Corrected Reading: Antenna Factor + Cable Loss + Read Level - Preamp Factor = Level.

Temperature	26°C	Humidity	62%
Test Engineer	YC Chen	Configurations	IEEE 802.11b CH 1 / Ant. 2
Test Date	May 26, 2014		

Horizontal

	Freq	Level	Limit Line	Over Limit	Read Level	Cable Loss	Antenna Factor	Preamp Factor	Remark	A/Pos	T/Pos	Pol/Phase
	MHz	dBuV/m	dBuV/m	dB	dBuV	dB	dB/m	dB		cm	deg	
1	4823.97	54.39	74.00	-19.61	52.44	3.31	33.56	34.92	Peak	100	331	HORIZONTAL
2	4823.99	52.59	54.00	-1.41	50.64	3.31	33.56	34.92	Average	100	331	HORIZONTAL

Vertical

	Freq	Level	Limit Line	Over Limit	Read Level	Cable Loss	Antenna Factor	Preamp Factor	Remark	A/Pos	T/Pos	Pol/Phase
	MHz	dBuV/m	dBuV/m	dB	dBuV	dB	dB/m	dB		cm	deg	
1	4823.94	56.04	74.00	-17.96	54.09	3.31	33.56	34.92	Peak	100	239	VERTICAL
2	4824.00	53.86	54.00	-0.14	51.91	3.31	33.56	34.92	Average	100	239	VERTICAL

Temperature	26°C	Humidity	62%
Test Engineer	YC Chen	Configurations	IEEE 802.11b CH 6 / Ant. 2
Test Date	May 26, 2014		

Horizontal

	Freq	Level	Limit	Over	Read	Cable	Antenna	Preamp	Remark	A/Pos	T/Pos	Pol/Phase
	MHz	dBuV/m	dBuV/m	dB	dBuV	Loss	Factor	Factor		cm	deg	
1	4873.99	56.08	74.00	-17.92	54.01	3.33	33.66	34.92	Peak	119	303	HORIZONTAL
2	4874.01	53.56	54.00	-0.44	51.49	3.33	33.66	34.92	Average	119	303	HORIZONTAL
3	7310.62	57.36	74.00	-16.64	51.85	4.06	36.64	35.19	Peak	100	78	HORIZONTAL
4	7311.74	51.80	54.00	-2.20	46.29	4.06	36.64	35.19	Average	100	78	HORIZONTAL

Vertical

	Freq	Level	Limit	Over	Read	Cable	Antenna	Preamp	Remark	A/Pos	T/Pos	Pol/Phase
	MHz	dBuV/m	dBuV/m	dB	dBuV	Loss	Factor	Factor		cm	deg	
1	4874.00	52.51	54.00	-1.49	50.44	3.33	33.66	34.92	Average	103	22	VERTICAL
2	4874.01	54.94	74.00	-19.06	52.87	3.33	33.66	34.92	Peak	103	22	VERTICAL
3	7311.75	52.77	54.00	-1.23	47.26	4.06	36.64	35.19	Average	102	26	VERTICAL
4	7311.98	57.92	74.00	-16.08	52.41	4.06	36.64	35.19	Peak	102	26	VERTICAL

Temperature	26°C	Humidity	62%
Test Engineer	YC Chen	Configurations	IEEE 802.11b CH 11 / Ant. 2
Test Date	May 26, 2014		

Horizontal

	Freq	Level	Limit	Over	Read	Cable	Antenna	Preamp	Remark	A/Pos	T/Pos	Pol/Phase
	MHz	dBuV/m	dBuV/m	dB	dBuV	Loss	Factor	Factor		cm	deg	
1	4924.00	56.59	74.00	-17.41	54.39	3.35	33.76	34.91	Peak	130	298	HORIZONTAL
2	4924.01	53.77	54.00	-0.23	51.57	3.35	33.76	34.91	Average	130	298	HORIZONTAL
3	7385.08	55.46	74.00	-18.54	49.76	4.06	36.85	35.21	Peak	166	26	HORIZONTAL
4	7385.27	49.30	54.00	-4.70	43.60	4.06	36.85	35.21	Average	166	26	HORIZONTAL

Vertical

	Freq	Level	Limit	Over	Read	Cable	Antenna	Preamp	Remark	A/Pos	T/Pos	Pol/Phase
	MHz	dBuV/m	dBuV/m	dB	dBuV	Loss	Factor	Factor		cm	deg	
1	4923.98	51.86	54.00	-2.14	49.66	3.35	33.76	34.91	Average	110	67	VERTICAL
2	4923.99	54.78	74.00	-19.22	52.58	3.35	33.76	34.91	Peak	110	67	VERTICAL
3	7385.05	55.48	74.00	-18.52	49.78	4.06	36.85	35.21	Peak	102	32	VERTICAL
4	7385.29	49.46	54.00	-4.54	43.76	4.06	36.85	35.21	Average	102	32	VERTICAL

Temperature	26°C	Humidity	62%
Test Engineer	YC Chen	Configurations	IEEE 802.11g CH 1 / Ant. 1 + Ant. 2
Test Date	May 26, 2014		

Horizontal

	Freq	Level	Limit Line	Over Limit	Read Level	Cable Loss	Antenna Factor	Preamp Factor	Remark	A/Pos	T/Pos	Pol/Phase
	MHz	dBuV/m	dBuV/m	dB	dBuV	dB	dB/m	dB		cm	deg	
1	4819.64	53.62	74.00	-20.38	51.67	3.31	33.56	34.92	Peak	122	23	HORIZONTAL
2	4824.16	39.67	54.00	-14.33	37.72	3.31	33.56	34.92	Average	122	23	HORIZONTAL

Vertical

	Freq	Level	Limit Line	Over Limit	Read Level	Cable Loss	Antenna Factor	Preamp Factor	Remark	A/Pos	T/Pos	Pol/Phase
	MHz	dBuV/m	dBuV/m	dB	dBuV	dB	dB/m	dB		cm	deg	
1	4823.71	40.94	54.00	-13.06	38.99	3.31	33.56	34.92	Average	100	308	VERTICAL
2	4823.81	56.44	74.00	-17.56	54.49	3.31	33.56	34.92	Peak	100	308	VERTICAL

Temperature	26°C	Humidity	62%
Test Engineer	YC Chen	Configurations	IEEE 802.11g CH 6 / Ant. 1 + Ant. 2
Test Date	May 26, 2014		

Horizontal

	Freq	Level	Limit	Over	Read	CableAntenna	Preamp	Remark	A/Pos	T/Pos	Pol/Phase	
	MHz	dBuV/m	dBuV/m	dB	dBuV	dB	dB/m	dB	cm	deg		
1	4869.48	58.80	74.00	-15.20	56.73	3.33	33.66	34.92	Peak	119	298	HORIZONTAL
2	4874.29	45.26	54.00	-8.74	43.19	3.33	33.66	34.92	Average	119	298	HORIZONTAL
3	7312.99	49.53	54.00	-4.47	44.02	4.06	36.64	35.19	Average	100	313	HORIZONTAL
4	7312.99	64.75	74.00	-9.25	59.24	4.06	36.64	35.19	Peak	100	313	HORIZONTAL

Vertical

	Freq	Level	Limit	Over	Read	CableAntenna	Preamp	Remark	A/Pos	T/Pos	Pol/Phase	
	MHz	dBuV/m	dBuV/m	dB	dBuV	dB	dB/m	dB	cm	deg		
1	4870.25	54.86	74.00	-19.14	52.79	3.33	33.66	34.92	Peak	101	314	VERTICAL
2	4870.64	41.41	54.00	-12.59	39.34	3.33	33.66	34.92	Average	101	314	VERTICAL
3	7312.54	53.84	54.00	-0.16	48.33	4.06	36.64	35.19	Average	102	26	VERTICAL
4	7312.64	69.01	74.00	-4.99	63.50	4.06	36.64	35.19	Peak	102	26	VERTICAL

Temperature	26°C	Humidity	62%
Test Engineer	YC Chen	Configurations	IEEE 802.11g CH 11 / Ant. 1 + Ant. 2
Test Date	May 26, 2014		

Horizontal

	Freq	Level	Limit Line	Over Limit	Read Level	Cable Loss	Antenna Factor	Preamp Factor	Remark	A/Pos	T/Pos	Pol/Phase
	MHz	dBuV/m	dBuV/m	dB	dBuV	dB	dB/m	dB		cm	deg	
1	4924.16	39.06	54.00	-14.94	36.86	3.35	33.76	34.91	Average	118	302	HORIZONTAL
2	4924.58	54.88	74.00	-19.12	52.68	3.35	33.76	34.91	Peak	118	302	HORIZONTAL
3	7386.87	58.91	74.00	-15.09	53.21	4.06	36.85	35.21	Peak	100	312	HORIZONTAL
4	7387.15	44.98	54.00	-9.02	39.28	4.06	36.85	35.21	Average	100	312	HORIZONTAL

Vertical

	Freq	Level	Limit Line	Over Limit	Read Level	Cable Loss	Antenna Factor	Preamp Factor	Remark	A/Pos	T/Pos	Pol/Phase
	MHz	dBuV/m	dBuV/m	dB	dBuV	dB	dB/m	dB		cm	deg	
1	4922.65	42.04	54.00	-11.96	39.84	3.35	33.76	34.91	Average	120	311	VERTICAL
2	4928.10	56.53	74.00	-17.47	54.33	3.35	33.76	34.91	Peak	120	311	VERTICAL
3	7386.64	47.70	54.00	-6.30	42.00	4.06	36.85	35.21	Average	104	30	VERTICAL
4	7386.77	62.71	74.00	-11.29	57.01	4.06	36.85	35.21	Peak	104	30	VERTICAL

Note:

The amplitude of spurious emissions that are attenuated by more than 20dB below the permissible value has no need to be reported.

Emission level (dBuV/m) = 20 log Emission level (uV/m).

Corrected Reading: Antenna Factor + Cable Loss + Read Level - Preamp Factor = Level.

4.6. Emissions Measurement

4.6.1. Limit

30dBc in any 100 kHz bandwidth outside the operating frequency band. In case the emission fall within the restricted band specified on 15.205(a), then the 15.209(a) limit in the table below has to be followed.

Frequencies (MHz)	Field Strength (micorvolts/meter)	Measurement Distance (meters)
0.009~0.490	2400/F(kHz)	300
0.490~1.705	24000/F(kHz)	30
1.705~30.0	30	30
30~88	100	3
88~216	150	3
216~960	200	3
Above 960	500	3

4.6.2. Measuring Instruments and Setting

Please refer to section 5 of equipments list in this report. The following table is the setting of the spectrum analyzer.

Spectrum Parameter	Setting
Attenuation	Auto
Span Frequency	100 MHz
RBW / VBW (Emission in restricted band)	1MHz / 3MHz for Peak, 1MHz / 10Hz for Average
RBW / VBW (Emission in non-restricted band)	100 kHz / 300 kHz for Peak

4.6.3. Test Procedures

For Radiated band edges Measurement:

1. The test procedure is the same as section 4.5.3, only the frequency range investigated is limited to 100MHz around band edges.

For Radiated Out of Band Emission Measurement:

1. Test was performed in accordance with KDB 558074 D01 v03r01 for Performing Compliance Measurements on Digital Transmission Systems (DTS) Operating Under §15.247 section 10.1 Unwanted Emissions into Non-Restricted Frequency Bands Measurement Procedure.
2. The radiated emission test is performed on each TX port of operating mode without summing or adding 10log (N) since the limit is relative emission limit.
Only worst data of each operating mode is presented.

4.6.4. Test Setup Layout

For Radiated band edges Measurement:

This test setup layout is the same as that shown in section 4.5.4.

For Radiated Out of Band Emission Measurement:

This test setup layout is the same as that shown in section 4.5.4.

4.6.5. Test Deviation

There is no deviation with the original standard.

4.6.6. EUT Operation during Test

The EUT was programmed to be in continuously transmitting mode.

4.6.7. Test Result of Band Edge and Fundamental Emissions

Temperature	26°C	Humidity	62%
Test Engineer	YC Chen	Configurations	IEEE 802.11n MCS0 HT20 CH 1, 6, 11 / Ant. 1 + Ant. 2
Test Date	May 26, 2014		

Channel 1

	Freq	Level	Limit Line	Over Limit	Read Level	CableAntenna Loss	Antenna Factor	Preamp Factor	Remark	A/Pos	T/Pos	Pol/Phase
	MHz	dBuV/m	dBuV/m	dB	dBuV	dB	dB/m	dB		cm	deg	
1	2388.40	70.70	74.00	-3.30	40.00	2.21	28.49	0.00	Peak	130	84	VERTICAL
2	2389.84	53.87	54.00	-0.13	23.16	2.22	28.49	0.00	Average	130	84	VERTICAL
3	2412.64	112.05			81.30	2.22	28.53	0.00	Peak	130	84	VERTICAL
4	2412.80	101.49			70.74	2.22	28.53	0.00	Average	130	84	VERTICAL

Item 3, 4 are the fundamental frequency at 2412 MHz.

Channel 6

	Freq	Level	Limit Line	Over Limit	Read Level	CableAntenna Loss	Antenna Factor	Preamp Factor	Remark	A/Pos	T/Pos	Pol/Phase
	MHz	dBuV/m	dBuV/m	dB	dBuV	dB	dB/m	dB		cm	deg	
1	2388.72	66.59	74.00	-7.41	35.89	2.21	28.49	0.00	Peak	132	84	VERTICAL
2	2390.00	52.88	54.00	-1.12	22.17	2.22	28.49	0.00	Average	132	84	VERTICAL
3	2437.64	117.83			87.00	2.23	28.60	0.00	Peak	132	84	VERTICAL
4	2437.96	106.12			75.29	2.23	28.60	0.00	Average	132	84	VERTICAL
5	2483.50	50.28	54.00	-3.72	19.35	2.26	28.67	0.00	Average	132	84	VERTICAL
6	2485.74	67.76	74.00	-6.24	36.83	2.26	28.67	0.00	Peak	132	84	VERTICAL

Item 3, 4 are the fundamental frequency at 2437 MHz.

Channel 11

	Freq	Level	Limit Line	Over Limit	Read Level	CableAntenna Loss	Antenna Factor	Preamp Factor	Remark	A/Pos	T/Pos	Pol/Phase
	MHz	dBuV/m	dBuV/m	dB	dBuV	dB	dB/m	dB		cm	deg	
1	2462.96	101.23			70.36	2.24	28.63	0.00	Average	127	83	VERTICAL
2	2463.28	112.33			81.46	2.24	28.63	0.00	Peak	127	83	VERTICAL
3	2483.50	53.69	54.00	-0.31	22.76	2.26	28.67	0.00	Average	127	83	VERTICAL
4	2484.30	69.06	74.00	-4.94	38.13	2.26	28.67	0.00	Peak	127	83	VERTICAL

Item 1, 2 are the fundamental frequency at 2462 MHz.

Temperature	26°C	Humidity	62%
Test Engineer	YC Chen	Configurations	IEEE 802.11n MCS0 HT40 CH 3, 6, 9 / Ant. 1 + Ant. 2
Test Date	May 26, 2014		

Channel 3

	Freq	Level	Limit Line	Over Limit	Read Level	Cable Loss	Antenna Factor	Preamp Factor	Remark	A/Pos	T/Pos	Pol/Phase
	MHz	dBuV/m	dBuV/m	dB	dBuV	dB	dB/m	dB		cm	deg	
1	2390.00	53.74	54.00	-0.26	23.03	2.22	28.49	0.00	Average	128	83	VERTICAL
2	2390.00	70.00	74.00	-4.00	39.29	2.22	28.49	0.00	Peak	128	83	VERTICAL
3	2410.46	93.22			62.47	2.22	28.53	0.00	Average	128	83	VERTICAL
4	2425.85	104.38			73.59	2.23	28.56	0.00	Peak	128	83	VERTICAL

Item 3, 4 are the fundamental frequency at 2422 MHz.

Channel 6

	Freq	Level	Limit Line	Over Limit	Read Level	Cable Loss	Antenna Factor	Preamp Factor	Remark	A/Pos	T/Pos	Pol/Phase
	MHz	dBuV/m	dBuV/m	dB	dBuV	dB	dB/m	dB		cm	deg	
1	2388.72	69.65	74.00	-4.35	38.95	2.21	28.49	0.00	Peak	129	82	VERTICAL
2	2390.00	53.73	54.00	-0.27	23.02	2.22	28.49	0.00	Average	129	82	VERTICAL
3	2435.72	97.28			66.49	2.23	28.56	0.00	Average	129	82	VERTICAL
4	2435.72	109.20			78.41	2.23	28.56	0.00	Peak	129	82	VERTICAL
5	2483.50	49.64	54.00	-4.36	18.71	2.26	28.67	0.00	Average	129	82	VERTICAL
6	2483.82	61.89	74.00	-12.11	30.96	2.26	28.67	0.00	Peak	129	82	VERTICAL

Item 3, 4 are the fundamental frequency at 2437 MHz.

Channel 9

	Freq	Level	Limit Line	Over Limit	Read Level	Cable Loss	Antenna Factor	Preamp Factor	Remark	A/Pos	T/Pos	Pol/Phase
	MHz	dBuV/m	dBuV/m	dB	dBuV	dB	dB/m	dB		cm	deg	
1	2450.40	98.17			67.33	2.24	28.60	0.00	Average	130	81	VERTICAL
2	2450.40	110.08			79.24	2.24	28.60	0.00	Peak	130	81	VERTICAL
3	2485.10	53.83	54.00	-0.17	22.90	2.26	28.67	0.00	Average	130	81	VERTICAL
4	2485.42	71.86	74.00	-2.14	40.93	2.26	28.67	0.00	Peak	130	81	VERTICAL

Item 1, 2 are the fundamental frequency at 2452 MHz.

Note:

Emission level (dBuV/m) = 20 log Emission level (uV/m).

Corrected Reading: Antenna Factor + Cable Loss + Read Level - Preamp Factor = Level.

Temperature	26°C	Humidity	62%
Test Engineer	YC Chen	Configurations	IEEE 802.11b CH 1, 6, 11 / Ant. 2
Test Date	May 26, 2014		

Channel 1

	Freq	Level	Limit Line	Over Limit	Read Level	Cable Loss	Antenna Factor	Preamp Factor	Remark	A/Pos	T/Pos	Pol/Phase
	MHz	dBuV/m	dBuV/m	dB	dBuV	dB	dB/m	dB		cm	deg	
1	2387.12	52.64	54.00	-1.36	21.94	2.21	28.49	0.00	Average	168	87	VERTICAL
2	2387.12	61.80	74.00	-12.20	31.10	2.21	28.49	0.00	Peak	168	87	VERTICAL
3	2411.04	111.33			80.58	2.22	28.53	0.00	Peak	168	87	VERTICAL
4	2411.20	107.51			76.76	2.22	28.53	0.00	Average	168	87	VERTICAL

Item 3, 4 are the fundamental frequency at 2412 MHz.

Channel 6

	Freq	Level	Limit Line	Over Limit	Read Level	Cable Loss	Antenna Factor	Preamp Factor	Remark	A/Pos	T/Pos	Pol/Phase
	MHz	dBuV/m	dBuV/m	dB	dBuV	dB	dB/m	dB		cm	deg	
1	2389.04	57.46	74.00	-16.54	26.76	2.21	28.49	0.00	Peak	100	64	VERTICAL
2	2390.00	46.33	54.00	-7.67	15.62	2.22	28.49	0.00	Average	100	64	VERTICAL
3	2436.36	105.20			74.41	2.23	28.56	0.00	Average	100	64	VERTICAL
4	2437.96	109.09			78.26	2.23	28.60	0.00	Peak	100	64	VERTICAL
5	2483.50	46.07	54.00	-7.93	15.14	2.26	28.67	0.00	Average	100	64	VERTICAL
6	2485.42	56.97	74.00	-17.03	26.04	2.26	28.67	0.00	Peak	100	64	VERTICAL

Item 3, 4 are the fundamental frequency at 2437 MHz.

Channel 11

	Freq	Level	Limit Line	Over Limit	Read Level	Cable Loss	Antenna Factor	Preamp Factor	Remark	A/Pos	T/Pos	Pol/Phase
	MHz	dBuV/m	dBuV/m	dB	dBuV	dB	dB/m	dB		cm	deg	
1	2462.80	105.93			75.06	2.24	28.63	0.00	Average	131	75	VERTICAL
2	2462.96	109.92			79.05	2.24	28.63	0.00	Peak	131	75	VERTICAL
3	2483.50	48.67	54.00	-5.33	17.74	2.26	28.67	0.00	Average	131	75	VERTICAL
4	2483.82	60.50	74.00	-13.50	29.57	2.26	28.67	0.00	Peak	131	75	VERTICAL

Item 1, 2 are the fundamental frequency at 2462 MHz.

Temperature	26°C	Humidity	62%
Test Engineer	YC Chen	Configurations	IEEE 802.11g CH 1, 6, 11 / Ant. 1 + Ant. 2
Test Date	May 26, 2014		

Channel 1

	Freq	Level	Limit Line	Over Limit	Read Level	CableAntenna Loss	Antenna Factor	Preamp Factor	Remark	A/Pos	T/Pos	Pol/Phase
	MHz	dBuV/m	dBuV/m	dB	dBuV	dB	dB/m	dB		cm	deg	
1	2389.68	53.63	54.00	-0.37	22.93	2.21	28.49	0.00	Average	131	85	VERTICAL
2	2390.00	72.98	74.00	-1.02	42.27	2.22	28.49	0.00	Peak	131	85	VERTICAL
3	2413.12	102.41			71.66	2.22	28.53	0.00	Average	131	85	VERTICAL
4	2413.44	112.83			82.08	2.22	28.53	0.00	Peak	131	85	VERTICAL

Item 3, 4 are the fundamental frequency at 2412 MHz.

Channel 6

	Freq	Level	Limit Line	Over Limit	Read Level	CableAntenna Loss	Antenna Factor	Preamp Factor	Remark	A/Pos	T/Pos	Pol/Phase
	MHz	dBuV/m	dBuV/m	dB	dBuV	dB	dB/m	dB		cm	deg	
1	2389.36	70.03	74.00	-3.97	39.33	2.21	28.49	0.00	Peak	130	83	VERTICAL
2	2389.68	52.62	54.00	-1.38	21.92	2.21	28.49	0.00	Average	130	83	VERTICAL
3	2438.60	105.81			74.98	2.23	28.60	0.00	Average	130	83	VERTICAL
4	2438.92	117.08			86.25	2.23	28.60	0.00	Peak	130	83	VERTICAL
5	2484.46	50.25	54.00	-3.75	19.32	2.26	28.67	0.00	Average	130	83	VERTICAL
6	2484.46	65.80	74.00	-8.20	34.87	2.26	28.67	0.00	Peak	130	83	VERTICAL

Item 3, 4 are the fundamental frequency at 2437 MHz.

Channel 11

	Freq	Level	Limit Line	Over Limit	Read Level	CableAntenna Loss	Antenna Factor	Preamp Factor	Remark	A/Pos	T/Pos	Pol/Phase
	MHz	dBuV/m	dBuV/m	dB	dBuV	dB	dB/m	dB		cm	deg	
1	2463.12	112.85			81.98	2.24	28.63	0.00	Peak	128	83	VERTICAL
2	2463.60	101.78			70.91	2.24	28.63	0.00	Average	128	83	VERTICAL
3	2483.50	53.53	54.00	-0.47	22.60	2.26	28.67	0.00	Average	128	83	VERTICAL
4	2484.30	70.05	74.00	-3.95	39.12	2.26	28.67	0.00	Peak	128	83	VERTICAL

Item 1, 2 are the fundamental frequency at 2462 MHz.

Note:

Emission level (dBuV/m) = 20 log Emission level (uV/m).

Corrected Reading: Antenna Factor + Cable Loss + Read Level - Preamp Factor = Level.

For Emission not in Restricted Band

Plot on Configuration IEEE 802.11n MCS0 HT20 / Reference Level

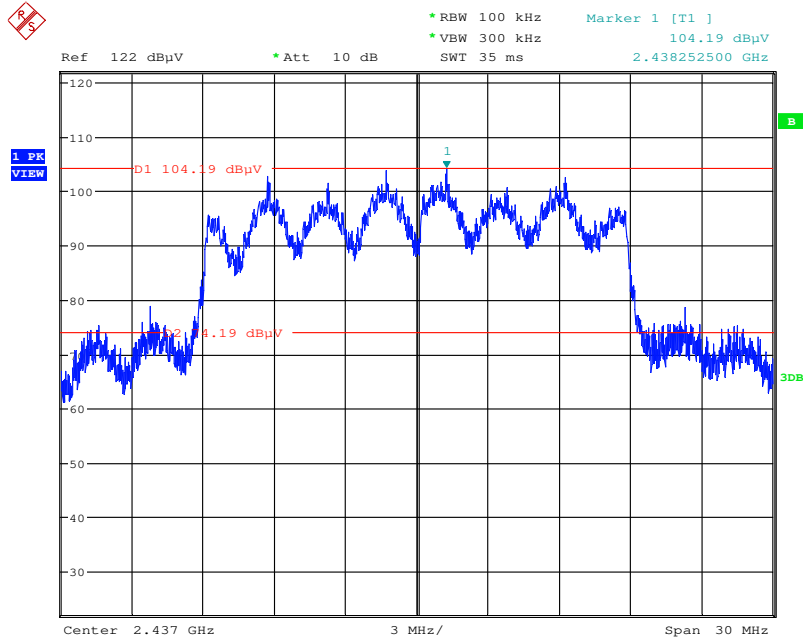

Date: 26.MAY.2014 23:35:52

Plot on Configuration IEEE 802.11n MCS0 HT20 / CH 1 / 30MHz~2400MHz (down 30dBc)

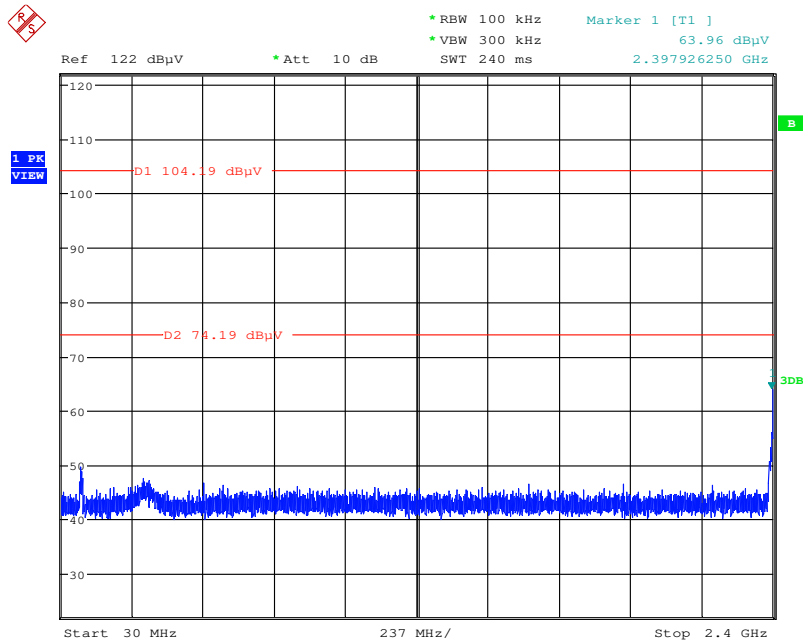

Date: 26.MAY.2014 23:36:34

Plot on Configuration IEEE 802.11n MCS0 HT20 / CH 1 / 2500MHz~26500MHz (down 30dBc)

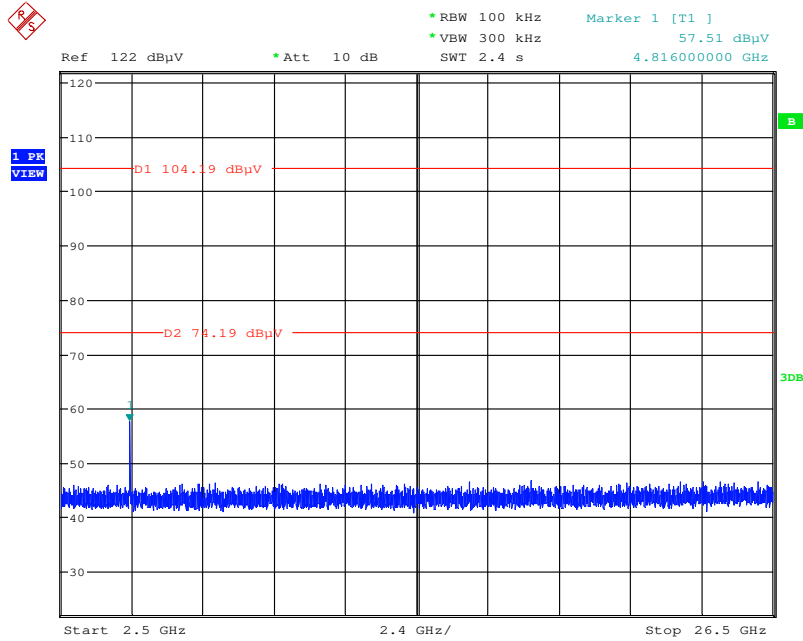

Date: 26.MAY.2014 23:37:08

Plot on Configuration IEEE 802.11n MCS0 HT20 / CH 11 / 30MHz~2400MHz (down 30dBc)

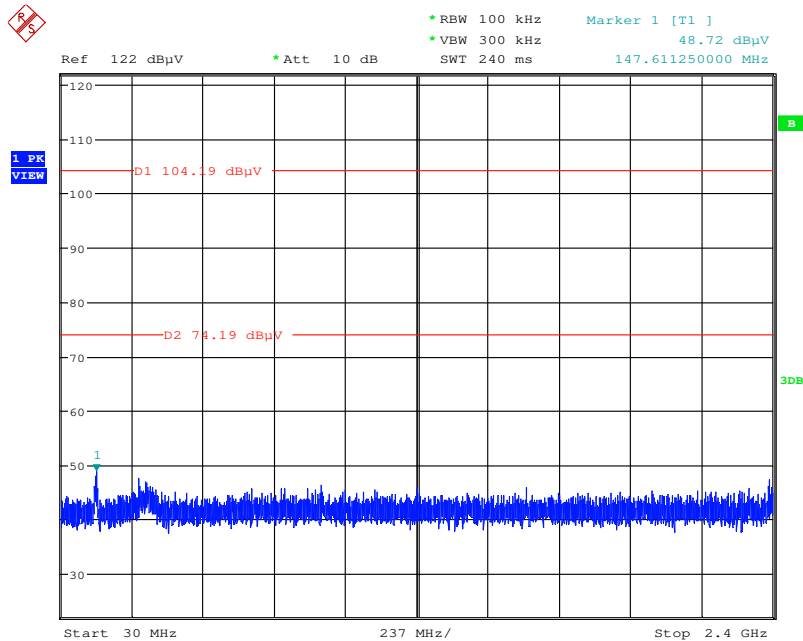

Date: 26.MAY.2014 23:38:03

Plot on Configuration IEEE 802.11n MCS0 HT40 / CH 3 / 2500MHz~26500MHz (down 30dBc)

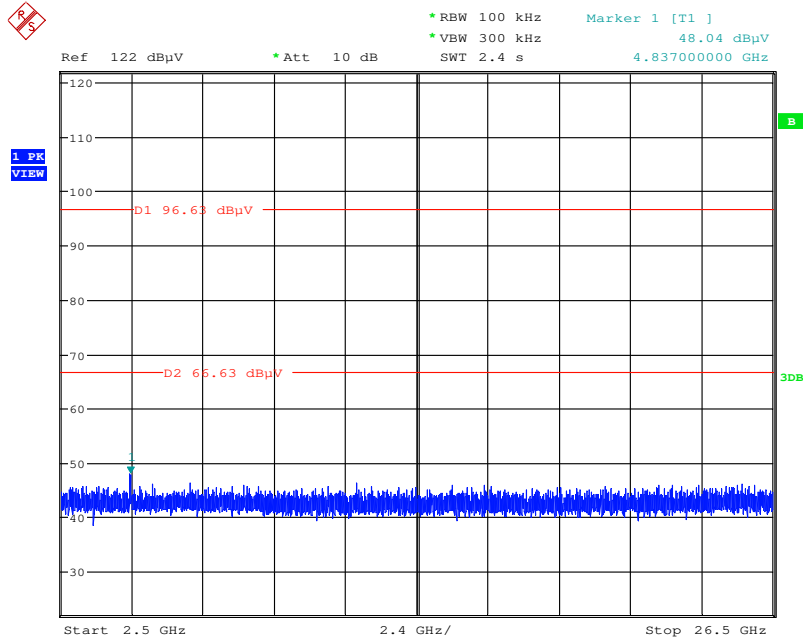

Date: 26.MAY.2014 23:46:55

Plot on Configuration IEEE 802.11n MCS0 HT40 / CH 9 / 30MHz~2400MHz (down 30dBc)

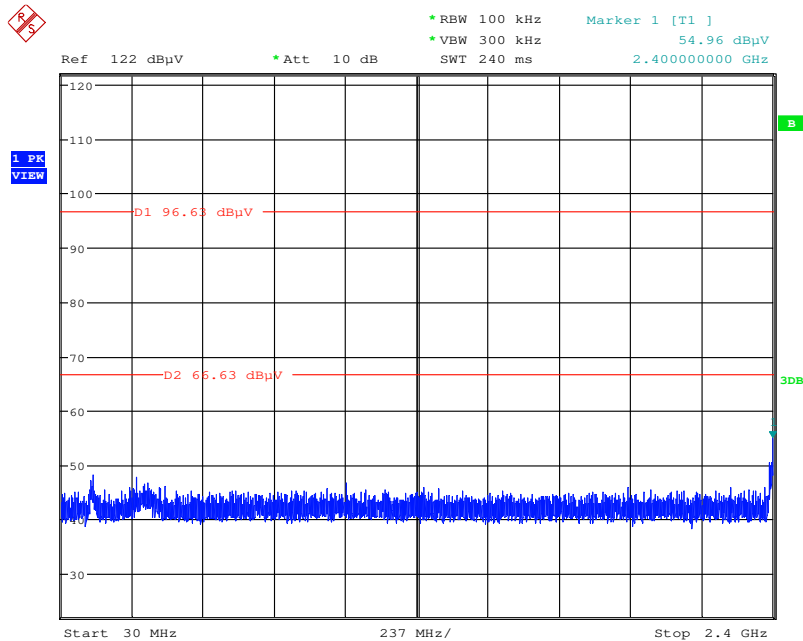

Date: 27.MAY.2014 00:42:00

Plot on Configuration IEEE 802.11n MCS0 HT40 / CH 9 / 2500MHz~26500MHz (down 30dBc)

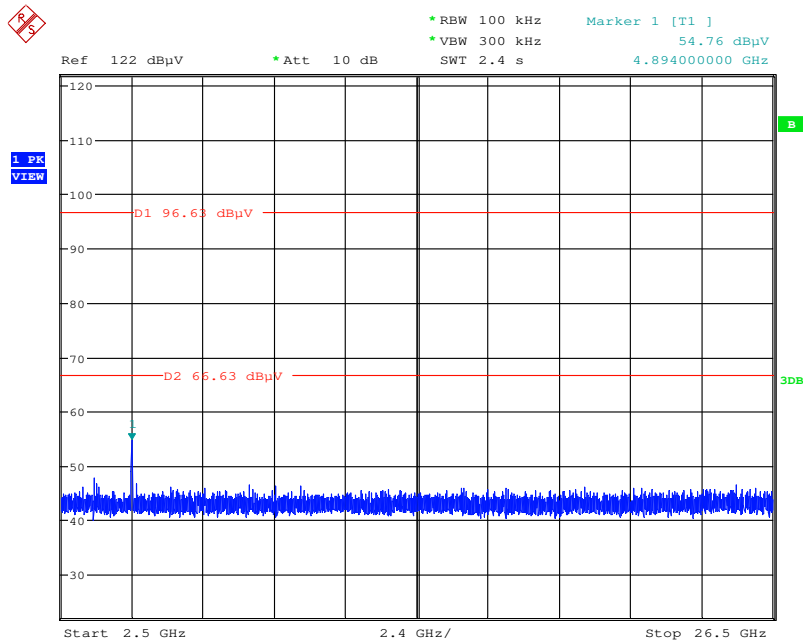

Date: 27.MAY.2014 00:41:40

Plot on Configuration IEEE 802.11b / Reference Level

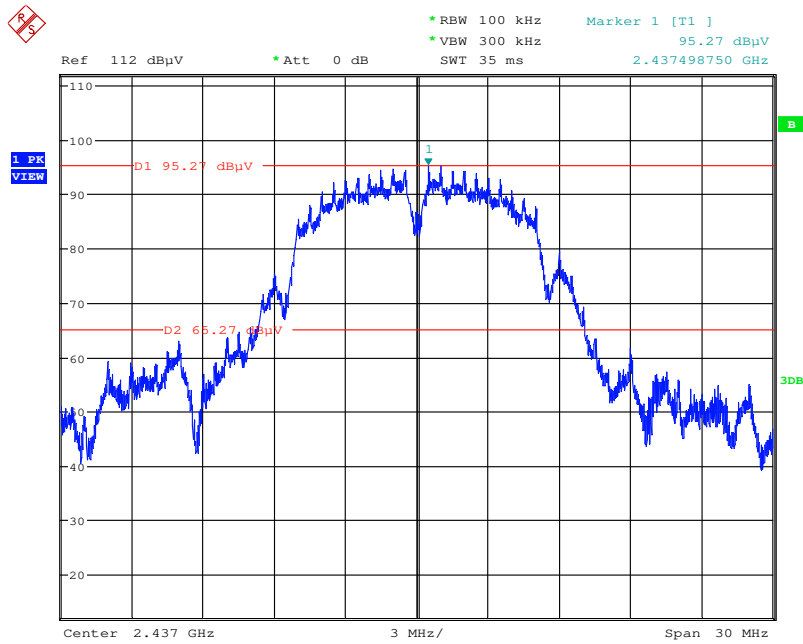

Date: 27.MAY.2014 00:49:04

Plot on Configuration IEEE 802.11b / CH 1 / 30MHz~2400MHz (down 30dBc)

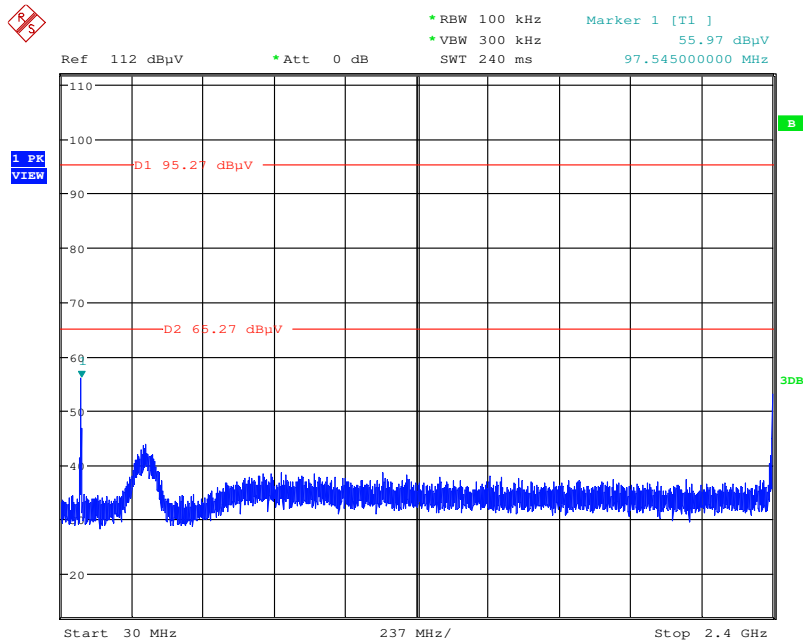

Date: 27.MAY.2014 00:50:30

Plot on Configuration IEEE 802.11b / CH 11 / 2500MHz~26500MHz (down 30dBc)

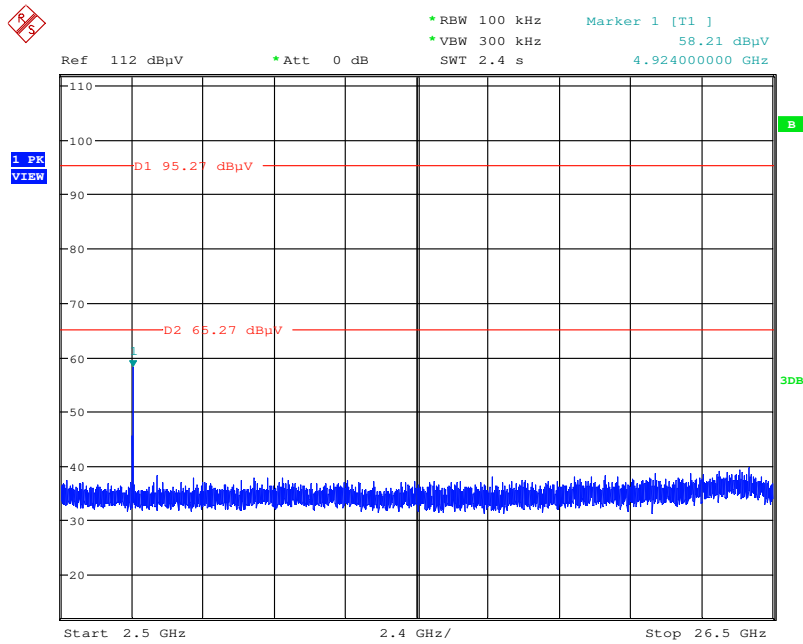

Date: 27.MAY.2014 00:51:20

Plot on Configuration IEEE 802.11g / Reference Level

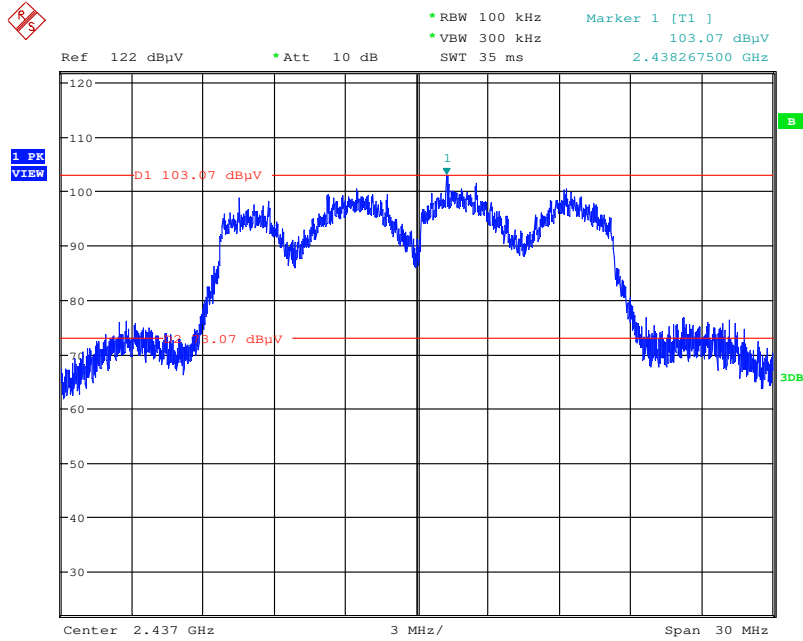

Date: 26.MAY.2014 23:32:01

Plot on Configuration IEEE 802.11g / CH 1 / 30MHz~2400MHz (down 30dBc)

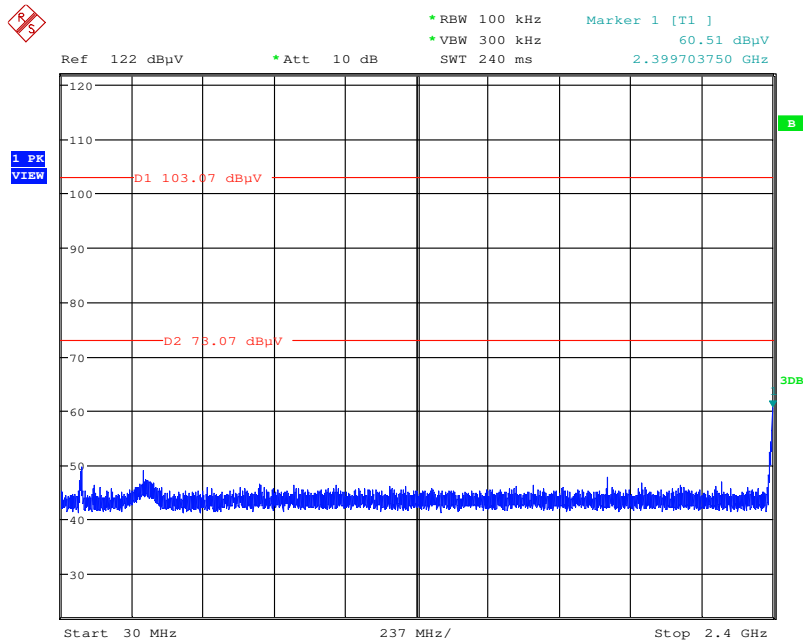

Date: 26.MAY.2014 23:33:23

4.7. Antenna Requirements

4.7.1. Limit

Except for special regulations, the Low-power Radio-frequency Devices must not be equipped with any jacket for installing an antenna with extension cable. An intentional radiator shall be designed to ensure that no antenna other than that furnished by the responsible party shall be used with the device. The use of a permanently attached antenna or of an antenna that uses a unique coupling to the intentional radiator shall be considered sufficient to comply with the provisions of this Section. The manufacturer may design the unit so that the user can replace a broken antenna, but the use of a standard antenna jack or electrical connector is prohibited. Further, this requirement does not apply to intentional radiators that must be professionally installed.

4.7.2. Antenna Connector Construction

Please refer to section 3.3 in this test report; antenna connector complied with the requirements.

5. LIST OF MEASURING EQUIPMENTS

Instrument	Manufacturer	Model No.	Serial No.	Characteristics	Calibration Date	Remark
EMI Test Receiver	R&S	ESCS 30	100355	9 kHz ~ 2.75 GHz	Apr. 23, 2014	Conduction (CO01-CB)
LISN	F.C.C.	FCC-LISN-50-16-2	04083	150 kHz ~ 100 MHz	Nov. 23, 2013	Conduction (CO01-CB)
LISN	Schwarzbeck	NSLK 8127	8127478	9kHz ~ 30MHz	Nov. 11, 2013	Conduction (CO01-CB)
COND Cable	Woken	Cable	01	150 kHz ~ 30 MHz	Dec. 04, 2013	Conduction (CO01-CB)
Software	Audix	E3	5.410e	-	N.C.R.	Conduction (CO01-CB)
BILOG ANTENNA	Schaffner	CBL6112B	2928	30MHz ~ 2GHz	Dec. 27, 2013	Radiation (03CH01-CB)
Loop Antenna	Teseq	HLA 6120	24155	9 kHz - 30 MHz	Nov. 05, 2012*	Radiation (03CH01-CB)
Horn Antenna	EMCO	3115	00075790	750MHz~18GHz	Nov. 01, 2013	Radiation (03CH01-CB)
Horn Antenna	SCHWARZBEAK	BBHA 9170	BBHA9170252	15GHz ~ 40GHz	Dec. 17, 2013	Radiation (03CH01-CB)
Pre-Amplifier	Agilent	8447D	2944A10991	0.1MHz ~ 1.3GHz	Nov. 12, 2013	Radiation (03CH01-CB)
Pre-Amplifier	Agilent	8449B	3008A02310	1GHz ~ 26.5GHz	Dec. 16, 2013	Radiation (03CH01-CB)
Pre-Amplifier	WM	TF-130N-R1	923365	26GHz ~ 40GHz	Oct. 23, 2013	Radiation (03CH01-CB)
Spectrum analyzer	R&S	FSP40	100019	9kHz~40GHz	Dec. 02, 2013	Radiation (03CH01-CB)
EMI Test Receiver	Agilent	N9038A	MY52260123	9kHz ~ 8GHz	Dec. 12, 2013	Radiation (03CH01-CB)
Turn Table	INN CO	CO 2000	N/A	0 ~ 360 degree	N.C.R.	Radiation (03CH01-CB)
Antenna Mast	INN CO	CO 2000	N/A	1 m - 4 m	N.C.R.	Radiation (03CH01-CB)
RF Cable-low	Woken	Low Cable-1	N/A	30 MHz - 1 GHz	Nov. 17, 2013	Radiation (03CH01-CB)
RF Cable-high	Woken	High Cable-1	N/A	1 GHz - 26.5 GHz	Nov. 17, 2013	Radiation (03CH01-CB)
RF Cable-high	Woken	High Cable-2	N/A	1 GHz - 26.5 GHz	Nov. 17, 2013	Radiation (03CH01-CB)
Signal analyzer	R&S	FSV40	100979	9kHz~40GHz	Nov. 29, 2013	Conducted (TH01-CB)
RF Power Divider	Woken	2 Way	0120A02056002D	2GHz ~ 18GHz	Nov. 17, 2013	Conducted (TH01-CB)
RF Power Divider	Woken	3 Way	MDC2366	2GHz ~ 18GHz	Nov. 17, 2013	Conducted (TH01-CB)
RF Power Divider	Woken	4 Way	0120A04056002D	2GHz ~ 18GHz	Nov. 17, 2013	Conducted (TH01-CB)
RF Cable-high	Woken	High Cable-7	-	1 GHz - 26.5 GHz	Nov. 17, 2013	Conducted (TH01-CB)
RF Cable-high	Woken	High Cable-8	-	1 GHz - 26.5 GHz	Nov. 17, 2013	Conducted (TH01-CB)
RF Cable-high	Woken	High Cable-9	-	1 GHz - 26.5 GHz	Nov. 17, 2013	Conducted (TH01-CB)

Instrument	Manufacturer	Model No.	Serial No.	Characteristics	Calibration Date	Remark
RF Cable-high	Woken	High Cable-10	-	1 GHz – 26.5 GHz	Nov. 17, 2013	Conducted (TH01-CB)
RF Cable-high	Woken	High Cable-11	-	1 GHz – 26.5 GHz	Nov. 17, 2013	Conducted (TH01-CB)
Power Sensor	Anritsu	MA2411B	0917223	300MHz~40GHz	Sep. 18, 2013	Conducted (TH01-CB)
Power Meter	Anritsu	ML2495A	1035008	300MHz~40GHz	Sep. 18, 2013	Conducted (TH01-CB)

Note: Calibration Interval of instruments listed above is one year.

“*” Calibration Interval of instruments listed above is two years.

N.C.R. means Non-Calibration required.

6. MEASUREMENT UNCERTAINTY

Uncertainty of Conducted Emission Measurement (150kHz ~ 30MHz)

Contribution	Uncertainty of x_i			$u(x_i)$
	Value	Unit	Probability Distribution k	
Receiver reading	0.026	dB	normal(k=2)	0.013
Cable loss	0.002	dB	normal(k=2)	0.001
AMN/LISN specification	1.200	dB	normal(k=2)	0.600
Mismatch Receiver VSWR 1= AMN/LISN VSWR 2=	-0.080	dB	U-shaped	0.060
Combined standard uncertainty $U_c(y)$				1.2
Measuring uncertainty for a level of confidence of 95% $U=2U_c(y)$				2.4

Uncertainty of Radiated Emission Measurement (30MHz ~ 1,000MHz)

Contribution	Uncertainty of x_i			$u(x_i)$
	Value	Unit	Probability Distribution k	
Receiver reading	± 0.173	dB	k=1	0.086
Cable loss	± 0.174	dB	k=2	0.087
Antenna gain	± 0.169	dB	k=2	0.084
Site imperfection	± 0.433	dB	Triangular	0.214
Pre-amplifier gain	± 0.366	dB	k=2	0.183
Transmitter antenna	± 1.200	dB	Rectangular	0.600
Signal generator	± 0.461	dB	Rectangular	0.231
Mismatch	± 0.080	dB	U-shape	0.040
Spectrum analyzer	± 0.500	dB	Rectangular	0.250
Combined standard uncertainty $U_c(y)$				1.778
Measuring uncertainty for a level of confidence of 95% $U=2U_c(y)$				3.555

Uncertainty of Radiated Emission Measurement (1GHz ~ 18GHz)

Contribution	Uncertainty of x_i			$u(x_i)$
	Value	Unit	Probability Distribution k	
Receiver reading	±0.191	dB	k=1	0.095
Cable loss	±0.169	dB	k=2	0.084
Antenna gain	±0.191	dB	k=2	0.096
Site imperfection	±0.582	dB	Triangular	0.291
Pre-amplifier gain	±0.304	dB	k=2	0.152
Transmitter antenna	±1.200	dB	Rectangular	0.600
Signal generator	±0.461	dB	Rectangular	0.231
Mismatch	±0.080	dB	U-shape	0.040
Spectrum analyzer	±0.500	dB	Rectangular	0.250
Combined standard uncertainty $U_c(y)$				1.839
Measuring uncertainty for a level of confidence of 95% $U=2U_c(y)$				3.678

Uncertainty of Radiated Emission Measurement (18GHz ~ 40GHz)

Contribution	Uncertainty of x_i			$u(x_i)$
	Value	Unit	Probability Distribution k	
Receiver reading	±0.186	dB	k=1	0.093
Cable loss	±0.167	dB	k=2	0.083
Antenna gain	±0.190	dB	k=2	0.095
Site imperfection	±0.488	dB	Triangular	0.244
Pre-amplifier gain	±0.269	dB	k=2	0.134
Transmitter antenna	±1.200	dB	Rectangular	0.600
Signal generator	±0.461	dB	Rectangular	0.231
Mismatch	±0.080	dB	U-shape	0.040
Spectrum analyzer	±0.500	dB	Rectangular	0.250
Combined standard uncertainty $U_c(y)$				1.771
Measuring uncertainty for a level of confidence of 95% $U=2U_c(y)$				3.541

Uncertainty of Conducted Emission Measurement

Contribution	Uncertainty of x_i			$u(x_i)$
	Value	Unit	Probability Distribution k	
Cable loss	±0.038	dB	k=2	0.019
Attenuator	±0.047	dB	k=2	0.024
Power Meter specification	±0.300	dB	Triangular	0.150
Power Sensor specification	±0.300	dB	Rectangular	0.150
Signal generator	±0.461	dB	Rectangular	0.231
Mismatch	±0.080	dB	U-shape	0.040
Spectrum analyzer	±0.500	dB	Rectangular	0.250
Combined standard uncertainty $U_c(y)$				0.863
Measuring uncertainty for a level of confidence of 95% $U=2U_c(y)$				1.726