

FCC Test Report (WLAN)

Report No.: RF170510C11B-1 R1

FCC ID: VUICGA4131

Test Model: CGA4131

Series Model: CGA4131XXXXX
(X = 0-1, A-Z, a-z, "-" or blank, for marketing purpose)

Received Date: May 10, 2017

Test Date: May 15 to 25, 2017 ; June 16 to July 07, 2017

Issued Date: Sep. 18, 2017

Applicant: PEGATRON CORPORATION

Address: 5F, No. 76 Ligong St., Beitou, Taipei 112, Taiwan

Issued By: Bureau Veritas Consumer Products Services (H.K.) Ltd., Taoyuan Branch
Hsin Chu Laboratory

Lab Address: E-2, No.1, Li Hsin 1st Road, Hsinchu Science Park, Hsinchu City 300,
Taiwan R.O.C.

Test Location (1): E-2, No.1, Li Hsin 1st Road, Hsinchu Science Park, Hsinchu City 300,
Taiwan R.O.C.

Test Location (2): No. 49, Ln. 206, Wende Rd., Shangshan Tsuen, Chiung Lin Hsiang, Hsin
Chu Hsien 307, Taiwan R.O.C.



This report is for your exclusive use. Any copying or replication of this report to or for any other person or entity, or use of our name or trademark, is permitted only with our prior written permission. This report sets forth our findings solely with respect to the test samples identified herein. The results set forth in this report are not indicative or representative of the quality or characteristics of the lot from which a test sample was taken or any similar or identical product unless specifically and expressly noted. Our report includes all of the tests requested by you and the results thereof based upon the information that you provided to us. You have 60 days from date of issuance of this report to notify us of any material error or omission caused by our negligence, provided, however, that such notice shall be in writing and shall specifically address the issue you wish to raise. A failure to raise such issue within the prescribed time shall constitute your unqualified acceptance of the completeness of this report, the tests conducted and the correctness of the report contents. Unless specific mention, the uncertainty of measurement has been explicitly taken into account to declare the compliance or non-compliance to the specification. The report must not be used by the client to claim product certification, approval, or endorsement by TAF or any government agencies.

Table of Contents

Release Control Record	4
1 Certificate of Conformity	5
2 Summary of Test Results	6
2.1 Measurement Uncertainty	6
2.2 Modification Record	6
3 General Information	7
3.1 General Description of EUT	7
3.2 Description of Test Modes	10
3.2.1 Test Mode Applicability and Tested Channel Detail	11
3.3 Duty Cycle of Test Signal	13
3.4 Description of Support Units	14
3.4.1 Configuration of System under Test	15
3.5 General Description of Applied Standard	16
4 Test Types and Results	17
4.1 Radiated Emission and Bandedge Measurement	17
4.1.1 Limits of Radiated Emission and Bandedge Measurement	17
4.1.2 Test Instruments	18
4.1.3 Test Procedure	21
4.1.4 Deviation from Test Standard	21
4.1.5 Test Setup	22
4.1.6 EUT Operating Condition	23
4.1.7 Test Results (Mode 1)	24
4.1.8 Test Results (Mode 2)	43
4.2 Conducted Emission Measurement	44
4.2.1 Limits of Conducted Emission Measurement	44
4.2.2 Test Instruments	44
4.2.3 Test Procedure	45
4.2.4 Deviation from Test Standard	45
4.2.5 Test Setup	45
4.2.6 EUT Operating Condition	45
4.2.7 Test Results	46
4.3 Transmit Power Measurement	48
4.3.1 Limits of Transmit Power Measurement	48
4.3.2 Test Setup	48
4.3.3 Test Instruments	48
4.3.4 Test Procedure	48
4.3.5 Deviation from Test Standard	48
4.3.6 EUT Operating Condition	48
4.3.7 Test Result	49
4.4 Occupied Bandwidth Measurement	51
4.4.1 Test Setup	51
4.4.2 Test Instruments	51
4.4.3 Test Procedure	51
4.4.4 Test Results	52
4.5 Peak Power Spectral Density Measurement	58
4.5.1 Limits of Peak Power Spectral Density Measurement	58
4.5.2 Test Setup	58
4.5.3 Test Instruments	58
4.5.4 Test Procedure	59
4.5.5 Deviation from Test Standard	59
4.5.6 EUT Operating Condition	59
4.5.7 Test Results	60
4.6 Frequency Stability Measurement	67

4.6.1	Limits of Frequency Stability Measurement	67
4.6.2	Test Setup.....	67
4.6.3	Test Instruments	67
4.6.4	Test Procedure	67
4.6.5	Deviation from Test Standard	67
4.6.6	EUT Operating Condition	67
4.6.7	Test Results	68
4.7	6dB Bandwidth Measurement	69
4.7.1	Limits of 6dB Bandwidth Measurement.....	69
4.7.2	Test Setup.....	69
4.7.3	Test Instruments	69
4.7.4	Test Procedure	69
4.7.5	Deviation from Test Standard	69
4.7.6	EUT Operating Condition	69
4.7.7	Test Results	70
5	Pictures of Test Arrangements.....	72
	Annex A- Radiated Out of Band Emission (OOBE) Measurement (For U-NII-3 band)	73
	Appendix – Information on the Testing Laboratories	76

Release Control Record

Issue No.	Description	Date Issued
RF170510C11B-1	Original release.	Sep. 14, 2017
RF170510C11B-1 R1	Modified the 5GHz antenna length.	Sep. 18, 2017

1 Certificate of Conformity

Product: D3.1 Cable Gateway

Brand: Technicolor

Test Model: CGA4131

Series Model: CGA4131XXXXX
(X = 0-1, A-Z, a-z, "-" or blank, for marketing purpose)

Sample Status: ENGINEERING SAMPLE

Applicant: PEGATRON CORPORATION

Test Date: May 15 to 25, 2017 ; June 16 to July 07, 2017

Standard: 47 CFR FCC Part 15, Subpart E (Section 15.407)
ANSI C63.10: 2013

The above equipment has been tested by **Bureau Veritas Consumer Products Services (H.K.) Ltd., Taoyuan Branch**, and found compliance with the requirement of the above standards. The test record, data evaluation & Equipment Under Test (EUT) configurations represented herein are true and accurate accounts of the measurements of the sample's EMC characteristics under the conditions specified in this report.

Prepared by : Cindy Hsin , **Date:** Sep. 18, 2017
Cindy Hsin / Specialist

Approved by : May Chen , **Date:** Sep. 18, 2017
May Chen / Manager

2 Summary of Test Results

47 CFR FCC Part 15, Subpart E (Section 15.407)			
FCC Clause	Test Item	Result	Remarks
15.407(b)(6)	AC Power Conducted Emissions	Pass	Meet the requirement of limit. Minimum passing margin is -1.42dB at 0.75750MHz.
15.407(b)(1/2/3/4(i/ii)/6)	Radiated Emissions & Band Edge Measurement*	Pass	Meet the requirement of limit. Minimum passing margin is -0.1dB at 5150.00MHz, 5350.00MHz and 5470.00MHz.
15.407(a)(1/2/3)	Max Average Transmit Power	Pass	Meet the requirement of limit.
---	Occupied Bandwidth Measurement	-	Reference only.
15.407(a)(1/2/3)	Peak Power Spectral Density	Pass	Meet the requirement of limit.
15.407(e)	6dB bandwidth	Pass	Meet the requirement of limit. (U-NII-3 Band only)
15.407(g)	Frequency Stability	Pass	Meet the requirement of limit.
15.203	Antenna Requirement	Pass	Antenna connector is i-pex(MHF) not a standard connector.

*For U-NII-3 band compliance with rule part 15.407(b)(4)(i), the OOB test plots were recorded in Annex A.

2.1 Measurement Uncertainty

Where relevant, the following measurement uncertainty levels have been estimated for tests performed on the EUT as specified in CISPR 16-4-2:

Measurement	Frequency	Expanded Uncertainty (k=2) (±)
Conducted Emissions at mains ports	150kHz ~ 30MHz	1.84 dB
Radiated Emissions up to 1 GHz	30MHz ~ 1GHz	5.30 dB
Radiated Emissions above 1 GHz	1GHz ~ 6GHz	5.16 dB
	6GHz ~ 18GHz	4.91 dB
	18GHz ~ 40GHz	5.30 dB

2.2 Modification Record

There were no modifications required for compliance.

3 General Information

3.1 General Description of EUT

Product	D3.1 Cable Gateway
Brand	Technicolor
Test Model	CGA4131
Series Model:	CGA4131XXXXX (X = 0-1, A-Z, a-z, "-" or blank, for marketing purpose)
Status of EUT	ENGINEERING SAMPLE
Power Supply Rating	100-240Vac, 50-60Hz
Modulation Type	CCK, DQPSK, DBPSK for DSSS 64QAM, 16QAM, QPSK, BPSK for OFDM 256QAM for OFDM in 11ac mode only
Modulation Technology	DSSS, OFDM
Transfer Rate	802.11b: up to 11Mbps 802.11a/g: up to 54Mbps 802.11n: up to 600Mbps 802.11ac: up to 1733.3Mbps
Operating Frequency	2.4GHz: 2.412 ~ 2.462GHz 5GHz: 5.18 ~ 5.24GHz, 5.745 ~ 5.825GHz
Number of Channel	2.4GHz: 802.11b, 802.11g, 802.11n (HT20): 11 802.11n (HT40): 7 5GHz: 802.11a, 802.11n (HT20), 802.11ac (VHT20): 9 802.11n (HT40), 802.11ac (VHT40): 4 802.11ac (VHT80): 2
Output Power	2.4GHz: 537.032mW CDD Mode: 5.18 ~ 5.24GHz: 844.646mW 5.745 ~ 5.825GHz: 995.2mW Beamforming Mode: 5.18 ~ 5.24GHz: 525.827mW 5.745 ~ 5.825GHz: 504.677mW
Antenna Type	Refer to Note
Antenna Connector	Refer to Note
Accessory Device	AC cable (Unshielded, 1.8m)
Data Cable Supplied	NA

Note:

1. This is a supplementary report of Report No.: RF170510C11-1. The differences between them are as below information:

- ◆ Changed the power board of Test Model: CGA4131
- ◆ The EUT added the different appearance of the arc and without PoE function as the following table:

Brand	Model	Difference
Technicolor	CGA4131XXXXX (X = 0-1, A-Z, a-z, "-" or blank, for marketing purpose)	Test Model: CGA4131 Appearance of the Hypotenuse, With PoE out Function
		Test Model: CGA4131TCH Appearance of the arc, Without PoE out function

From the above models, model: **CGA4131**, **CGA4131TCH** were selected as representative model for the test and its data was recorded in this report.

2. According to above conditions, only conducted Emissions and radiated emissions (below 1GHz) test need to be performed. Therefore all test data were copied from the original test report (Report No.: RF170510C11-1), except for conducted Emissions and radiated emissions (below 1GHz) test data. And all data were verified to meet the requirements.

3. 2.4GHz and 5GHz technology cannot transmit at same time.

4. The EUT uses following internal power supply as the following table:

Spec.
AC input: 100-240Vac, 1.65A, 50-60Hz
DC input: 12Vdc, 10A

5. The antennas provided to the EUT, please refer to the following table:

2.4GHz					
Transmitter Circuit	Antenna Net Gain(dBi)	Frequency range (MHz)	Antenna Type	Connector Type	Cable Length
Chain 0	2.0	2400 ~ 2483.5	PCB	i-pex(MHF)	95mm
Chain 1	2.0	2400 ~ 2483.5	PCB	i-pex(MHF)	210mm
5GHz					
Transmitter Circuit	Antenna Net Gain(dBi)	Frequency range (MHz)	Antenna Type	Connector Type	Cable Length
Chain 0	2.1	5150 ~ 5250	PCB	i-pex(MHF)	55mm
	2.6	5250 ~ 5350			
	2.4	5470 ~ 5725			
	2.4	5725 ~ 5850			
Chain 1	2.7	5150 ~ 5250	PCB	i-pex(MHF)	135mm
	2.3	5250 ~ 5350			
	2.3	5470 ~ 5725			
	2.7	5725 ~ 5850			
Chain 2	2.7	5150 ~ 5250	PCB	i-pex(MHF)	170mm
	2.6	5250 ~ 5350			
	2.4	5470 ~ 5725			
	2.4	5725 ~ 5850			
Chain 3	3.5	5150 ~ 5250	PCB	i-pex(MHF)	240mm
	3.0	5250 ~ 5350			
	3.4	5470 ~ 5725			
	3.9	5725 ~ 5850			

6. The EUT incorporates a MIMO function.

2.4GHz Band			
MODULATION MODE	DATA RATE (MCS)	TX & RX CONFIGURATION	
802.11b	1 ~ 11Mbps	1TX Fixed Chain 0	1RX Diversity
802.11g	6 ~ 54Mbps	2TX	2RX
802.11n (HT20)	MCS 0~7	2TX	2RX
	MCS 8~15	2TX	2RX
802.11n (HT40)	MCS 0~7	2TX	2RX
	MCS 8~15	2TX	2RX
5GHz Band			
MODULATION MODE	DATA RATE (MCS)	TX & RX CONFIGURATION	
802.11a	6 ~ 54Mbps	4TX	4RX
802.11n (HT20)	MCS 0~7	4TX	4RX
	MCS 8~15	4TX	4RX
	MCS 16~23	4TX	4RX
	MCS 24~31	4TX	4RX
802.11n (HT40)	MCS 0~7	4TX	4RX
	MCS 8~15	4TX	4RX
	MCS 16~23	4TX	4RX
	MCS 24~31	4TX	4RX
802.11ac (VHT20)	MCS0~8 Nss=1	4TX	4RX
	MCS0~8 Nss=2	4TX	4RX
	MCS0~9 Nss=3	4TX	4RX
	MCS0~8 Nss=4	4TX	4RX
802.11ac (VHT40)	MCS0~9 Nss=1	4TX	4RX
	MCS0~9 Nss=2	4TX	4RX
	MCS0~9 Nss=3	4TX	4RX
	MCS0~9 Nss=4	4TX	4RX
802.11ac (VHT80)	MCS0~9 Nss=1	4TX	4RX
	MCS0~9 Nss=2	4TX	4RX
	MCS0~9 Nss=3	4TX	4RX
	MCS0~9 Nss=4	4TX	4RX

Note: 1. All of modulation mode support beamforming function except 2.4GHz and 5GHz (802.11a) modulation mode.
 2. The modulation and bandwidth are similar for 802.11n mode for 20MHz (40MHz) and 802.11ac mode for 20MHz (40MHz), therefore investigated worst case to representative mode in test report. (Final test mode refer section 3.2.1).
 3. The EUT support Beamforming and CDD mode, therefore both mode were investigated and the worst case scenario was identified. The worst case data were presented in test report (except Output power test item).

7. The above EUT information is declared by manufacturer and for more detailed features description, please refer to the manufacturer's specifications or user's manual.

3.2 Description of Test Modes

FOR 5180 ~ 5240MHz

4 channels are provided for 802.11a, 802.11n (HT20), 802.11ac (VHT20):

Channel	Frequency	Channel	Frequency
36	5180MHz	44	5220MHz
40	5200MHz	48	5240MHz

2 channels are provided for 802.11n (HT40), 802.11ac (VHT40):

Channel	Frequency	Channel	Frequency
38	5190MHz	46	5230MHz

1 channel is provided for 802.11ac (VHT80):

Channel	Frequency
42	5210MHz

FOR 5745 ~ 5825MHz:

5 channels are provided for 802.11a, 802.11n (HT20), 802.11ac (VHT20):

Channel	Frequency	Channel	Frequency
149	5745MHz	161	5805MHz
153	5765MHz	165	5825MHz
157	5785MHz		

2 channels are provided for 802.11n (HT40), 802.11ac (VHT40):

Channel	Frequency	Channel	Frequency
151	5755MHz	159	5795MHz

1 channel is provided for 802.11ac (VHT80):

Channel	Frequency
155	5775MHz

3.2.1 Test Mode Applicability and Tested Channel Detail

EUT Configure Mode	Applicable To				Description
	RE \geq 1G	RE $<$ 1G	PLC	APCM	
1	√	√	√	√	With Model: CGA4131
2	-	√	-	-	With Model: CGA4131TCH

Where **RE \geq 1G**: Radiated Emission above 1GHz **RE $<$ 1G**: Radiated Emission below 1GHz
PLC: Power Line Conducted Emission **APCM**: Antenna Port Conducted Measurement

Radiated Emission Test (Above 1GHz):

- Pre-Scan has been conducted to determine the worst-case mode from all possible combinations between available modulations, data rates and antenna ports (if EUT with antenna diversity architecture).
- Following channel(s) was (were) selected for the final test as listed below.

CDD Mode						
Mode	FREQ. Band (MHz)	Available Channel	Tested Channel	Modulation Technology	Modulation Type	Data Rate (Mbps)
802.11a	5180-5240	36 to 48	36, 40, 48	OFDM	BPSK	6
802.11ac (VHT20)		36 to 48	36, 40, 48	OFDM	BPSK	6.5
802.11ac (VHT40)		38 to 46	38, 46	OFDM	BPSK	13.5
802.11ac (VHT80)		42	42	OFDM	BPSK	29.3
802.11a	5745-5825	149 to 165	149, 157, 165	OFDM	BPSK	6
802.11ac (VHT20)		149 to 165	149, 157, 165	OFDM	BPSK	6.5
802.11ac (VHT40)		151 to 159	151, 159	OFDM	BPSK	13.5
802.11ac (VHT80)		155	155	OFDM	BPSK	29.3

Radiated Emission Test (Below 1GHz):

- Pre-Scan has been conducted to determine the worst-case mode from all possible combinations between available modulations, data rates and antenna ports (if EUT with antenna diversity architecture).
- Following channel(s) was (were) selected for the final test as listed below.

CDD Mode						
Mode	FREQ. Band (MHz)	Available Channel	Tested Channel	Modulation Technology	Modulation Type	Data Rate (Mbps)
802.11ac (VHT40)	5180-5240 5745-5825	36 to 48 151 to 159	151	OFDM	BPSK	13.5

Power Line Conducted Emission Test:

- Pre-Scan has been conducted to determine the worst-case mode from all possible combinations between available modulations, data rates and antenna ports (if EUT with antenna diversity architecture).
- Following channel(s) was (were) selected for the final test as listed below.

CDD Mode						
Mode	FREQ. Band (MHz)	Available Channel	Tested Channel	Modulation Technology	Modulation Type	Data Rate (Mbps)
802.11ac (VHT40)	5180-5240 5745-5825	36 to 48 151 to 159	151	OFDM	BPSK	13.5

Antenna Port Conducted Measurement:

- This item includes all test value of each mode, but only includes spectrum plot of worst value of each mode.
- Pre-Scan has been conducted to determine the worst-case mode from all possible combinations between available modulations, data rates and antenna ports (if EUT with antenna diversity architecture).
- Following channel(s) was (were) selected for the final test as listed below.

CDD Mode						
Mode	FREQ. Band (MHz)	Available Channel	Tested Channel	Modulation Technology	Modulation Type	Data Rate (Mbps)
802.11a	5180-5240	36 to 48	36, 40, 48	OFDM	BPSK	6
802.11ac (VHT20)		36 to 48	36, 40, 48	OFDM	BPSK	6.5
802.11ac (VHT40)		38 to 46	38, 46	OFDM	BPSK	13.5
802.11ac (VHT80)		42	42	OFDM	BPSK	29.3
802.11a	5745-5825	149 to 165	149, 157, 165	OFDM	BPSK	6
802.11ac (VHT20)		149 to 165	149, 157, 165	OFDM	BPSK	6.5
802.11ac (VHT40)		151 to 159	151, 159	OFDM	BPSK	13.5
802.11ac (VHT80)		155	155	OFDM	BPSK	29.3
Beamforming Mode (Output power only)						
Mode	FREQ. Band (MHz)	Available Channel	Tested Channel	Modulation Technology	Modulation Type	Data Rate (Mbps)
802.11ac (VHT20)	5180-5240	36 to 48	36, 40, 48	OFDM	BPSK	6.5
802.11ac (VHT40)		38 to 46	38, 46	OFDM	BPSK	13.5
802.11ac (VHT80)		42	42	OFDM	BPSK	29.3
802.11ac (VHT20)	5745-5825	149 to 165	149, 157, 165	OFDM	BPSK	6.5
802.11ac (VHT40)		151 to 159	151, 159	OFDM	BPSK	13.5
802.11ac (VHT80)		155	155	OFDM	BPSK	29.3

Test Condition:

Applicable To	Environmental Conditions	Input Power	Tested By
RE \geq 1G	25deg. C, 66%RH	120Vac, 60Hz	Jyunchen Lin
RE $<$ 1G	24deg. C, 72%RH	120Vac, 60Hz	Andy Ho
PLC	25deg. C, 75%RH	120Vac, 60Hz	Andy Ho
APCM	25deg. C, 60%RH	120Vac, 60Hz	Anderson Chen

3.3 Duty Cycle of Test Signal

If duty cycle of test signal is $\geq 98\%$, duty factor is not required.
 If duty cycle of test signal is $< 98\%$, duty factor shall be considered.

802.11a: Duty cycle = $2.062 / 2.084 = 0.989$

802.11ac (VHT20): Duty cycle = $1.925 / 1.949 = 0.988$

802.11ac (VHT40): Duty cycle = $0.953 / 0.972 = 0.980$

802.11ac (VHT80): Duty cycle = $0.458 / 0.482 = 0.950$, Duty factor = $10 * \log(1 / 0.950) = 0.22$

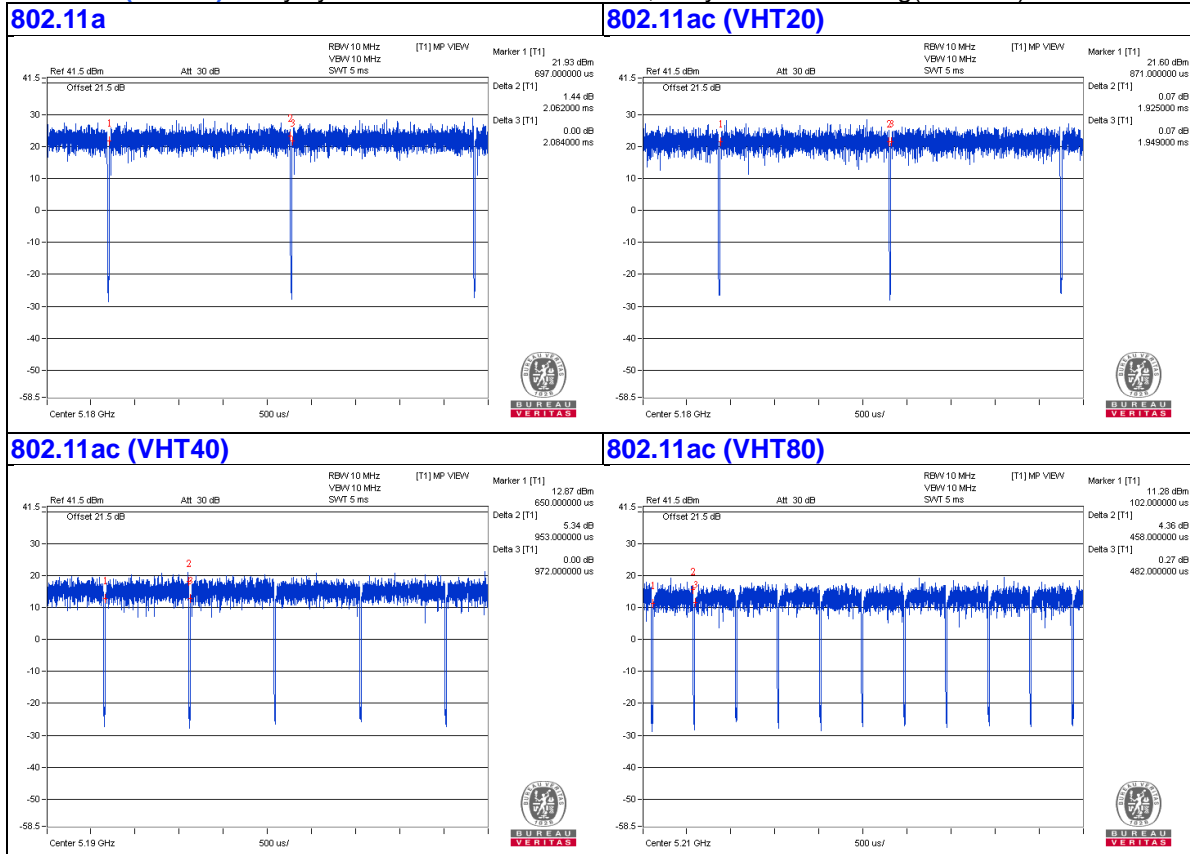

3.4 Description of Support Units

The EUT has been tested as an independent unit together with other necessary accessories or support units. The following support units or accessories were used to form a representative test configuration during the tests.

ID	Product	Brand	Model No.	Serial No.	FCC ID	Remarks
A.	Laptop	HP	Pavilion 14-ab023TU	5CD5340WXZ	NA	Provided by Lab
B.	Load	NA	NA	NA	NA	Provided by Lab

Note:

1. All power cords of the above support units are non-shielded (1.8m).

ID	Descriptions	Qty.	Length (m)	Shielding (Yes/No)	Cores (Qty.)	Remarks
1.	AC Cable	1	1.7	No	0	Supplied by client
2.	RJ-45 Cable	1	10	No	0	Provided by Lab
3.	Coaxial Cable	1	10	Yes	0	Provided by Lab

3.4.1 Configuration of System under Test

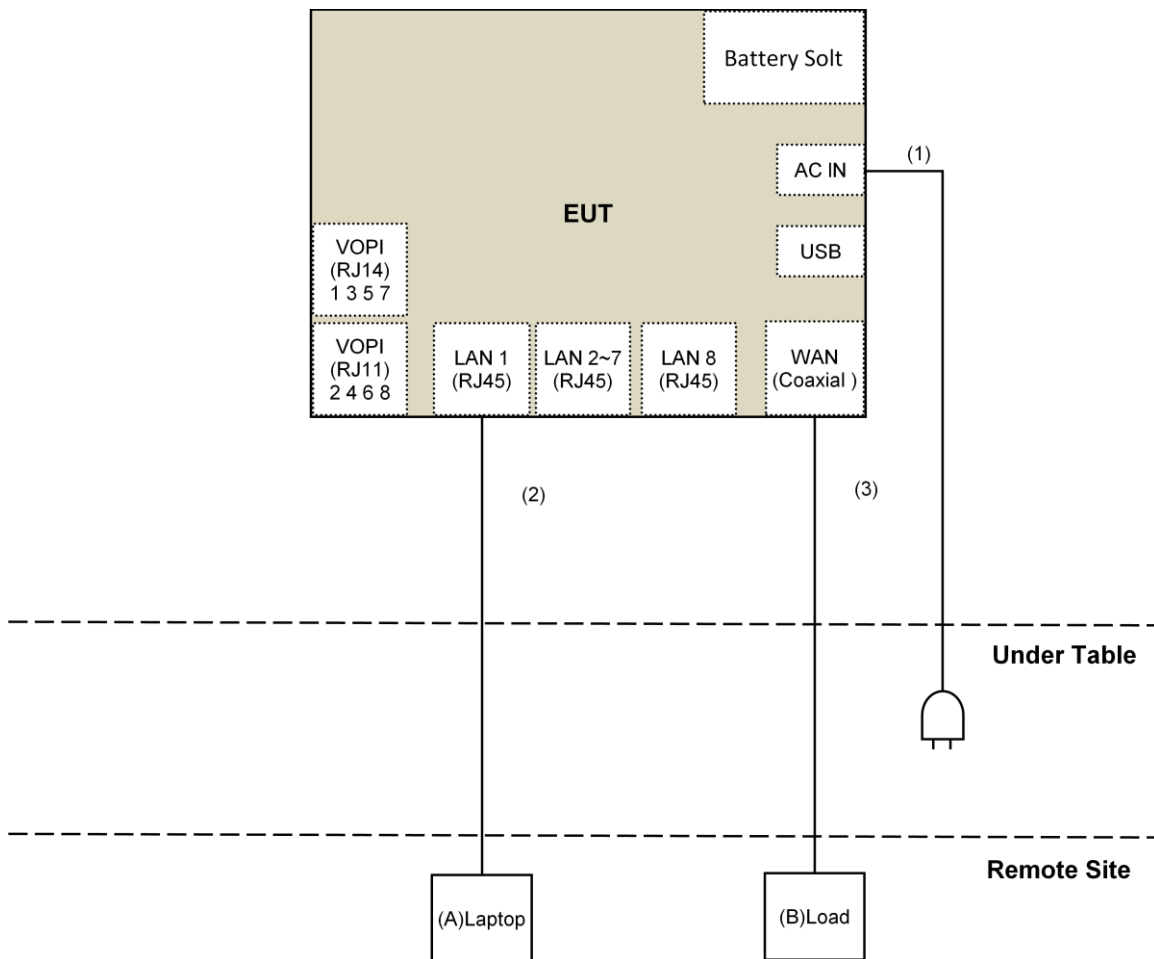

NOTE: The test configuration was defined by the applicant requirement.

3.5 General Description of Applied Standard

The EUT is a RF Product. According to the specifications of the manufacturer, it must comply with the requirements of the following standards:

FCC Part 15, Subpart E (15.407)
KDB 789033 D02 General UNII Test Procedure New Rules v01r04
KDB 662911 D01 Multiple Transmitter Output v02r01
ANSI C63.10-2013

All test items have been performed and recorded as per the above standards.

NOTE: The EUT has been verified to comply with the requirements of FCC Part 15, Subpart B, Class B (DoC). The test report has been issued separately.

4 Test Types and Results

4.1 Radiated Emission and Bandedge Measurement

4.1.1 Limits of Radiated Emission and Bandedge Measurement

Radiated emissions which fall in the restricted bands must comply with the radiated emission limits specified as below table.

Frequencies (MHz)	Field Strength (microvolts/meter)	Measurement Distance (meters)
0.009 ~ 0.490	2400/F(kHz)	300
0.490 ~ 1.705	24000/F(kHz)	30
1.705 ~ 30.0	30	30
30 ~ 88	100	3
88 ~ 216	150	3
216 ~ 960	200	3
Above 960	500	3

NOTE:

- The lower limit shall apply at the transition frequencies.
- Emission level (dBuV/m) = 20 log Emission level (uV/m).
- For frequencies above 1000MHz, the field strength limits are based on average detector, however, the peak field strength of any emission shall not exceed the maximum permitted average limits, specified above by more than 20dB under any condition of modulation.

Limits of unwanted emission out of the restricted bands

Applicable To		Limit	
789033 D02 General UNII Test Procedure New Rules v01r04		Field Strength at 3m	
		PK:74 (dBuV/m)	AV:54 (dBuV/m)
Frequency Band	Applicable To	EIRP Limit	Equivalent Field Strength at 3m
5150~5250 MHz	15.407(b)(1)	PK:-27 (dBm/MHz)	PK:68.2(dBuV/m)
5250~5350 MHz	15.407(b)(2)		
5470~5725 MHz	15.407(b)(3)		
5725~5850 MHz	<input checked="" type="checkbox"/> 15.407(b)(4)(i)	PK:-27 (dBm/MHz) ^{*1} PK:10 (dBm/MHz) ^{*2} PK:15.6 (dBm/MHz) ^{*3} PK:27 (dBm/MHz) ^{*4}	PK: 68.2(dBuV/m) ^{*1} PK:105.2 (dBuV/m) ^{*2} PK: 110.8(dBuV/m) ^{*3} PK:122.2 (dBuV/m) ^{*4}
	<input type="checkbox"/> 15.407(b)(4)(ii)	Emission limits in section 15.247(d)	
^{*1} beyond 75 MHz or more above of the band edge.		^{*2} below the band edge increasing linearly to 10 dBm/MHz at 25 MHz above.	
^{*3} below the band edge increasing linearly to a level of 15.6 dBm/MHz at 5 MHz above.		^{*4} from 5 MHz above or below the band edge increasing linearly to a level of 27 dBm/MHz at the band edge.	

Note:

The following formula is used to convert the equipment isotropic radiated power (eirp) to field strength:

$$E = \frac{1000000\sqrt{30P}}{3} \mu\text{V/m, where } P \text{ is the eirp (Watts).}$$

4.1.2 Test Instruments

For Above 1GHz, Below 1GHz (Mode 2) and other :

DESCRIPTION & MANUFACTURER	MODEL NO.	SERIAL NO.	CALIBRATED DATE	CALIBRATED UNTIL
Test Receiver Keysight	N9038A	MY54450088	July 20, 2016	July 19, 2017
Pre-Amplifier ^(*) EMCI	EMC001340	980142	Jan. 20, 2016	Jan. 19, 2018
Loop Antenna ^(*) Electro-Metrics	EM-6879	264	Dec. 16, 2016	Dec. 15, 2018
RF Cable	NA	LOOPCAB-001 LOOPCAB-002	Jan. 17, 2017	Jan. 16, 2018
Pre-Amplifier Mini-Circuits	ZFL-1000VH2B	AMP-ZFL-01	Nov. 10, 2016	Nov. 09, 2017
Trilog Broadband Antenna SCHWARZBECK	VULB 9168	9168-406	Dec. 13, 2016	Dec. 12, 2017
RF Cable	8D	966-4-1 966-4-2 966-4-3	Apr. 01, 2017	Mar. 31, 2018
Fixed attenuator Mini-Circuits	UNAT-5+	PAD-3m-4-01	Oct. 05, 2016	Oct. 04, 2017
Horn_Antenna SCHWARZBECK	BBHA 9120D	9120D-783	Dec. 27, 2016	Dec. 26, 2017
Pre-Amplifier EMCI	EMC12630SE	980385	Feb. 02, 2017	Feb. 01, 2018
RF Cable	EMC104-SM-SM-1200	160923	Feb. 02, 2017	Feb. 01, 2018
	EMC104-SM-SM-2000	150318	Mar. 29, 2017	Mar. 28, 2018
	EMC104-SM-SM-5000	150323	Mar. 29, 2017	Mar. 28, 2018
Pre-Amplifier EMCI	EMC184045SE	980387	Feb. 02, 2017	Feb. 01, 2018
Horn_Antenna SCHWARZBECK	BBHA 9170	BBHA9170608	Dec. 15, 2016	Dec. 14, 2017
RF Cable	SUCOFLEX 102	36432/2 36433/2	Jan. 15, 2017	Jan. 14, 2018
Software	ADT_Radiated_V8.7.08	NA	NA	NA
Antenna Tower & Turn Table Max-Full	MF-7802	MF780208410	NA	NA
Boresight Antenna Fixture	FBA-01	FBA-SIP02	NA	NA
Spectrum Analyzer R&S	FSv40	100964	June 28, 2016	June 27, 2017
Spectrum Analyzer Agilent	E4446A	MY48250253	Dec. 21, 2016	Dec. 20, 2017
Power meter Anritsu	ML2495A	1014008	May 11, 2017	May 10, 2018
AC Power Source Extech Electronics	6205	1440452	NA	NA
Temperature & Humidity Chamber Giant Force	GTH-150-40-SP-AR	MAA0812-008	Jan. 11, 2017	Jan. 10, 2018
DC Power Supply Topward	6603D	795558	NA	NA
Digital Multimeter FLUKE	87III	73680266	Nov. 10, 2016	Nov. 09, 2017

Note:

1. The calibration interval of the above test instruments is 12 months and the calibrations are traceable to NML/ROC and NIST/USA.
2. *The calibration interval of the above test instruments is 24 months and the calibrations are traceable to NML/ROC and NIST/USA.
3. The test was performed in 966 Chamber No. 4.
4. The FCC Designation Number is TW2022. The number will be varied with the Lab location and scope as attached.
5. The CANADA Site Registration No. is 20331-2
6. Tested Date: May 15 to 25, 2017 ; June 16, 2017

For Below 1GHz (Mode 1):

DESCRIPTION & MANUFACTURER	MODEL NO.	SERIAL NO.	CALIBRATED DATE	CALIBRATED UNTIL
Test Receiver Keysight	N9038A	MY54450088	July 20, 2016	July 19, 2017
Pre-Amplifier ^(*) EMCI	EMC001340	980142	Jan. 20, 2016	Jan. 19, 2018
Loop Antenna ^(*) Electro-Metrics	EM-6879	264	Dec. 16, 2016	Dec. 15, 2018
RF Cable	NA	LOOPCAB-001 LOOPCAB-002	Jan. 17, 2017	Jan. 16, 2018
Pre-Amplifier Mini-Circuits	ZFL-1000VH2B	AMP-ZFL-01	Nov. 10, 2016	Nov. 09, 2017
Trilog Broadband Antenna SCHWARZBECK	VULB 9168	9168-406	Dec. 13, 2016	Dec. 12, 2017
RF Cable	8D	966-4-1 966-4-2 966-4-3	Apr. 01, 2017	Mar. 31, 2018
Fixed attenuator Mini-Circuits	UNAT-5+	PAD-3m-4-01	Oct. 05, 2016	Oct. 04, 2017
Software	ADT_Radiated_V8.7.08	NA	NA	NA
Antenna Tower & Turn Table Max-Full	MF-7802	MF780208410	NA	NA

Note:

1. The calibration interval of the above test instruments is 12 months and the calibrations are traceable to NML/ROC and NIST/USA.
2. *The calibration interval of the above test instruments is 24 months and the calibrations are traceable to NML/ROC and NIST/USA.
3. The test was performed in 966 Chamber No. 4.
4. The FCC Designation Number is TW2022. The number will be varied with the Lab location and scope as attached.
5. The CANADA Site Registration No. is 20331-2
6. Tested Date: July 07, 2017

4.1.3 Test Procedure

For Radiated emission below 30MHz

- a. The EUT was placed on the top of a rotating table 0.8 meters above the ground at a 3 meter chamber room. The table was rotated 360 degrees to determine the position of the highest radiation.
- b. The EUT was set 3 meters away from the interference-receiving antenna, which was mounted on the top of a variable-height antenna tower.
- c. Both X and Y axes of the antenna are set to make the measurement.
- d. For each suspected emission, the EUT was arranged to its worst case and the rotatable table was turned from 0 degrees to 360 degrees to find the maximum reading.
- e. The test-receiver system was set to Quasi-Peak Detect Function and Specified Bandwidth with Maximum Hold Mode.

NOTE:

1. The resolution bandwidth and video bandwidth of test receiver/spectrum analyzer is 9kHz at frequency below 30MHz.

For Radiated emission above 30MHz

- a. The EUT was placed on the top of a rotating table 0.8 meters (for 30MHz ~ 1GHz) / 1.5 meters (for above 1GHz) above the ground at 3 meter chamber room for test. The table was rotated 360 degrees to determine the position of the highest radiation.
- b. The EUT was set 3 meters away from the interference-receiving antenna, which was mounted on the top of a variable-height antenna tower.
- c. The height of antenna is varied from one meter to four meters above the ground to determine the maximum value of the field strength. Both horizontal and vertical polarizations of the antenna are set to make the measurement.
- d. For each suspected emission, the EUT was arranged to its worst case and then the antenna was tuned to heights from 1 meter to 4 meters and the rotatable table was turned from 0 degrees to 360 degrees to find the maximum reading.
- e. The test-receiver system was set to quasi-peak detect function and specified bandwidth with maximum hold mode when the test frequency is below 1 GHz.
- f. The test-receiver system was set to peak and average detect function and specified bandwidth with maximum hold mode when the test frequency is above 1 GHz. If the peak reading value also meets average limit, measurement with the average detector is unnecessary.

Note:

1. The resolution bandwidth and video bandwidth of test receiver/spectrum analyzer is 120kHz for Quasi-peak detection (QP) at frequency below 1GHz.
2. The resolution bandwidth of test receiver/spectrum analyzer is 1 MHz and the video bandwidth is 3 MHz for Peak detection (PK) at frequency above 1GHz.
3. The resolution bandwidth of test receiver/spectrum analyzer is 1MHz and the video bandwidth is $\geq 1/T$ (Duty cycle < 98%) or 10Hz (Duty cycle $\geq 98\%$) for Average detection (AV) at frequency above 1GHz.
4. All modes of operation were investigated and the worst-case emissions are reported.

4.1.4 Deviation from Test Standard

No deviation.

4.1.5 Test Setup

For Radiated emission below 30MHz

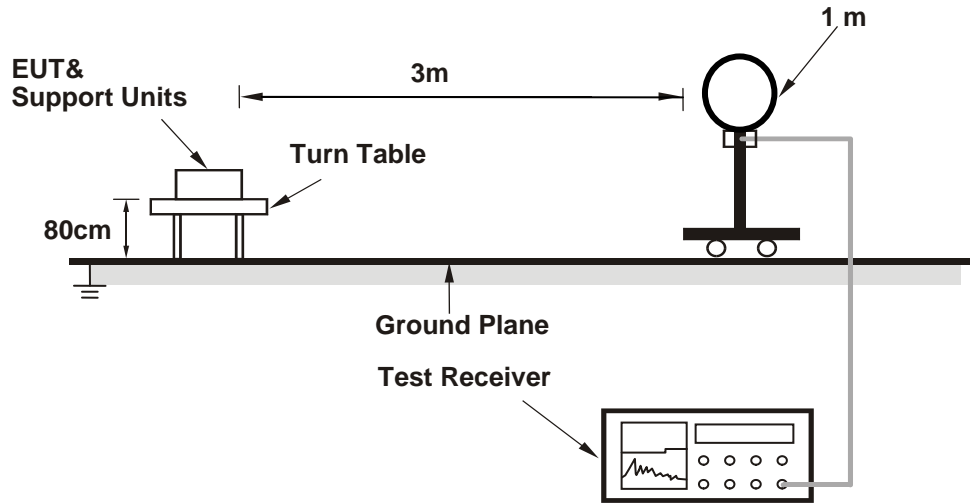

For Radiated emission 30MHz to 1GHz

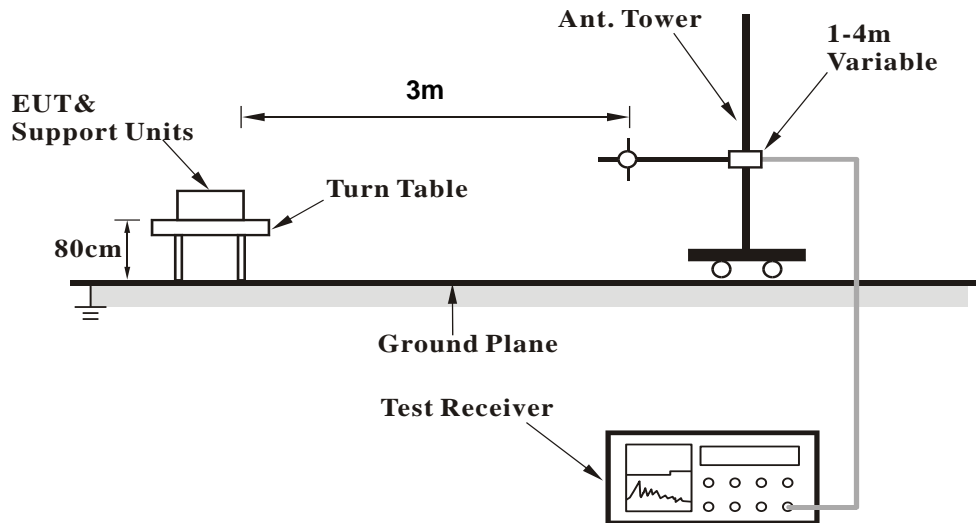

For Radiated emission above 1GHz

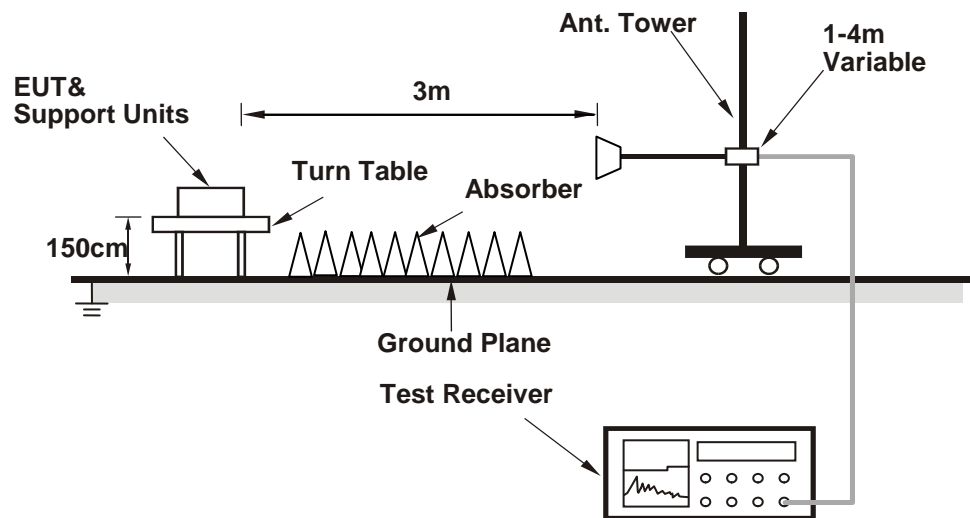

For the actual test configuration, please refer to the attached file (Test Setup Photo).

4.1.6 EUT Operating Condition

- a. Connected the EUT with the Laptop which is placed on remote site.
- b. Controlling software (Mtool V3.0.0.1) has been activated to set the EUT on specific status.

4.1.7 Test Results (Mode 1)

ABOVE 1GHz DATA

802.11a

CHANNEL	TX Channel 36	DETECTOR FUNCTION	Peak (PK)
FREQUENCY RANGE	1GHz ~ 40GHz		Average (AV)

ANTENNA POLARITY & TEST DISTANCE: HORIZONTAL AT 3 M

NO.	FREQ. (MHz)	EMISSION LEVEL (dBuV/m)	LIMIT (dBuV/m)	MARGIN (dB)	ANTENNA HEIGHT (m)	TABLE ANGLE (Degree)	RAW VALUE (dBuV)	CORRECTION FACTOR (dB/m)
1	5150.00	62.3 PK	74.0	-11.7	1.06 H	211	58.3	4.0
2	5150.00	48.3 AV	54.0	-5.7	1.06 H	211	44.3	4.0
3	*5180.00	117.0 PK			1.06 H	211	113.0	4.0
4	*5180.00	106.6 AV			1.06 H	211	102.6	4.0
5	#10360.00	50.3 PK	74.0	-23.7	1.06 H	213	36.7	13.6
6	#10360.00	37.5 AV	54.0	-16.5	1.06 H	213	23.9	13.6
7	15540.00	51.8 PK	74.0	-22.2	1.00 H	198	38.6	13.2
8	15540.00	40.0 AV	54.0	-14.0	1.00 H	198	26.8	13.2

ANTENNA POLARITY & TEST DISTANCE: VERTICAL AT 3 M

NO.	FREQ. (MHz)	EMISSION LEVEL (dBuV/m)	LIMIT (dBuV/m)	MARGIN (dB)	ANTENNA HEIGHT (m)	TABLE ANGLE (Degree)	RAW VALUE (dBuV)	CORRECTION FACTOR (dB/m)
1	5150.00	70.7 PK	74.0	-3.3	2.61 V	163	66.7	4.0
2	5150.00	53.7 AV	54.0	-0.3	2.61 V	163	49.7	4.0
3	*5180.00	119.8 PK			2.61 V	163	115.8	4.0
4	*5180.00	109.9 AV			2.61 V	163	105.9	4.0
5	#10360.00	51.5 PK	74.0	-22.5	1.06 V	159	37.9	13.6
6	#10360.00	39.2 AV	54.0	-14.8	1.06 V	159	25.6	13.6
7	15540.00	55.7 PK	74.0	-18.3	1.08 V	182	42.5	13.2
8	15540.00	42.4 AV	54.0	-11.6	1.08 V	182	29.2	13.2

REMARKS:

1. Emission Level(dBuV/m) = Raw Value(dBuV) + Correction Factor(dB/m)
2. Correction Factor(dB/m) = Antenna Factor(dB/m) + Cable Factor(dB) – Pre-Amplifier Factor(dB)
3. The other emission levels were very low against the limit.
4. Margin value = Emission Level – Limit value
5. " * ": Fundamental frequency.
6. " # ": The radiated frequency is out of the restricted band.

CHANNEL	TX Channel 40	DETECTOR FUNCTION	Peak (PK)
FREQUENCY RANGE	1GHz ~ 40GHz		Average (AV)

ANTENNA POLARITY & TEST DISTANCE: HORIZONTAL AT 3 M

NO.	FREQ. (MHz)	EMISSION LEVEL (dBuV/m)	LIMIT (dBuV/m)	MARGIN (dB)	ANTENNA HEIGHT (m)	TABLE ANGLE (Degree)	RAW VALUE (dBuV)	CORRECTION FACTOR (dB/m)
1	5126.00	56.5 PK	74.0	-17.5	1.10 H	210	52.6	3.9
2	5126.00	45.6 AV	54.0	-8.4	1.10 H	210	41.7	3.9
3	*5200.00	117.8 PK			1.10 H	210	113.8	4.0
4	*5200.00	107.4 AV			1.10 H	210	103.4	4.0
5	5367.00	52.3 PK	74.0	-21.7	1.10 H	210	47.9	4.4
6	5367.00	42.4 AV	54.0	-11.6	1.10 H	210	38.0	4.4
7	#10400.00	49.5 PK	74.0	-24.5	1.05 H	230	35.9	13.6
8	#10400.00	37.2 AV	54.0	-16.8	1.05 H	230	23.6	13.6
9	15600.00	51.8 PK	74.0	-22.2	1.00 H	203	38.4	13.4
10	15600.00	39.6 AV	54.0	-14.4	1.00 H	203	26.2	13.4

ANTENNA POLARITY & TEST DISTANCE: VERTICAL AT 3 M

NO.	FREQ. (MHz)	EMISSION LEVEL (dBuV/m)	LIMIT (dBuV/m)	MARGIN (dB)	ANTENNA HEIGHT (m)	TABLE ANGLE (Degree)	RAW VALUE (dBuV)	CORRECTION FACTOR (dB/m)
1	5126.00	61.7 PK	74.0	-12.3	2.60 V	159	57.8	3.9
2	5126.00	50.2 AV	54.0	-3.8	2.60 V	159	46.3	3.9
3	*5200.00	120.8 PK			2.60 V	159	116.8	4.0
4	*5200.00	110.7 AV			2.60 V	159	106.7	4.0
5	5367.00	57.6 PK	74.0	-16.4	2.60 V	159	53.2	4.4
6	5367.00	47.6 AV	54.0	-6.4	2.60 V	159	43.2	4.4
7	#10400.00	51.7 PK	74.0	-22.3	1.08 V	167	38.1	13.6
8	#10400.00	39.6 AV	54.0	-14.4	1.08 V	167	26.0	13.6
9	15600.00	55.6 PK	74.0	-18.4	1.10 V	202	42.2	13.4
10	15600.00	42.4 AV	54.0	-11.6	1.10 V	202	29.0	13.4

REMARKS:

1. Emission Level(dBuV/m) = Raw Value(dBuV) + Correction Factor(dB/m)
2. Correction Factor(dB/m) = Antenna Factor(dB/m) + Cable Factor(dB) – Pre-Amplifier Factor(dB)
3. The other emission levels were very low against the limit.
4. Margin value = Emission Level – Limit value
5. " * ": Fundamental frequency.
6. " # ": The radiated frequency is out of the restricted band.

CHANNEL	TX Channel 48	DETECTOR FUNCTION	Peak (PK)
FREQUENCY RANGE	1GHz ~ 40GHz		Average (AV)

ANTENNA POLARITY & TEST DISTANCE: HORIZONTAL AT 3 M

NO.	FREQ. (MHz)	EMISSION LEVEL (dBuV/m)	LIMIT (dBuV/m)	MARGIN (dB)	ANTENNA HEIGHT (m)	TABLE ANGLE (Degree)	RAW VALUE (dBuV)	CORRECTION FACTOR (dB/m)
1	5085.00	52.5 PK	74.0	-21.5	1.04 H	207	48.6	3.9
2	5085.00	41.2 AV	54.0	-12.8	1.04 H	207	37.3	3.9
3	*5240.00	117.5 PK			1.04 H	207	113.3	4.2
4	*5240.00	107.2 AV			1.04 H	207	103.0	4.2
5	5407.00	52.1 PK	74.0	-21.9	1.04 H	207	47.7	4.4
6	5407.00	41.7 AV	54.0	-12.3	1.04 H	207	37.3	4.4
7	#10480.00	50.1 PK	74.0	-23.9	1.05 H	220	36.4	13.7
8	#10480.00	37.6 AV	54.0	-16.4	1.05 H	220	23.9	13.7
9	15720.00	51.9 PK	74.0	-22.1	1.00 H	191	37.9	14.0
10	15720.00	39.9 AV	54.0	-14.1	1.00 H	191	25.9	14.0

ANTENNA POLARITY & TEST DISTANCE: VERTICAL AT 3 M

NO.	FREQ. (MHz)	EMISSION LEVEL (dBuV/m)	LIMIT (dBuV/m)	MARGIN (dB)	ANTENNA HEIGHT (m)	TABLE ANGLE (Degree)	RAW VALUE (dBuV)	CORRECTION FACTOR (dB/m)
1	5085.00	55.9 PK	74.0	-18.1	2.64 V	157	52.0	3.9
2	5085.00	45.3 AV	54.0	-8.7	2.64 V	157	41.4	3.9
3	*5240.00	120.5 PK			2.64 V	157	116.3	4.2
4	*5240.00	110.5 AV			2.64 V	157	106.3	4.2
5	5407.00	55.6 PK	74.0	-18.4	2.64 V	157	51.2	4.4
6	5407.00	45.7 AV	54.0	-8.3	2.64 V	157	41.3	4.4
7	#10480.00	51.7 PK	74.0	-22.3	1.00 V	156	38.0	13.7
8	#10480.00	39.4 AV	54.0	-14.6	1.00 V	156	25.7	13.7
9	15720.00	56.2 PK	74.0	-17.8	1.04 V	189	42.2	14.0
10	15720.00	42.8 AV	54.0	-11.2	1.04 V	189	28.8	14.0

REMARKS:

- Emission Level(dBuV/m) = Raw Value(dBuV) + Correction Factor(dB/m)
- Correction Factor(dB/m) = Antenna Factor(dB/m) + Cable Factor(dB) – Pre-Amplifier Factor(dB)
- The other emission levels were very low against the limit.
- Margin value = Emission Level – Limit value
- " * ": Fundamental frequency.
- " # ": The radiated frequency is out of the restricted band.

CHANNEL	TX Channel 149	DETECTOR FUNCTION	Peak (PK)
FREQUENCY RANGE	1GHz ~ 40GHz		Average (AV)

ANTENNA POLARITY & TEST DISTANCE: HORIZONTAL AT 3 M

NO.	FREQ. (MHz)	EMISSION LEVEL (dBuV/m)	LIMIT (dBuV/m)	MARGIN (dB)	ANTENNA HEIGHT (m)	TABLE ANGLE (Degree)	RAW VALUE (dBuV)	CORRECTION FACTOR (dB/m)
1	#5588.48	62.7 PK	68.2	-5.5	1.04 H	261	58.1	4.6
2	*5745.00	120.2 PK			1.04 H	261	115.2	5.0
3	*5745.00	110.2 AV			1.04 H	261	105.2	5.0
4	#5990.32	64.2 PK	68.2	-4.0	1.04 H	261	58.6	5.6
5	11490.00	47.7 PK	74.0	-26.3	1.08 H	220	33.6	14.1
6	11490.00	35.6 AV	54.0	-18.4	1.08 H	220	21.5	14.1
7	#17235.00	52.5 PK	74.0	-21.5	1.02 H	200	34.2	18.3
8	#17235.00	40.2 AV	54.0	-13.8	1.02 H	200	21.9	18.3

ANTENNA POLARITY & TEST DISTANCE: VERTICAL AT 3 M

NO.	FREQ. (MHz)	EMISSION LEVEL (dBuV/m)	LIMIT (dBuV/m)	MARGIN (dB)	ANTENNA HEIGHT (m)	TABLE ANGLE (Degree)	RAW VALUE (dBuV)	CORRECTION FACTOR (dB/m)
1	#5581.33	63.5 PK	68.2	-4.7	2.84 V	179	58.9	4.6
2	*5745.00	123.3 PK			2.84 V	179	118.3	5.0
3	*5745.00	112.7 AV			2.84 V	179	107.7	5.0
4	#5988.06	63.1 PK	68.2	-5.1	2.84 V	179	57.5	5.6
5	11490.00	47.6 PK	74.0	-26.4	1.55 V	38	33.5	14.1
6	11490.00	34.9 AV	54.0	-19.1	1.55 V	38	20.8	14.1
7	#17235.00	52.5 PK	74.0	-21.5	1.58 V	99	34.2	18.3
8	#17235.00	40.5 AV	54.0	-13.5	1.58 V	99	22.2	18.3

REMARKS:

1. Emission Level(dBuV/m) = Raw Value(dBuV) + Correction Factor(dB/m)
2. Correction Factor(dB/m) = Antenna Factor(dB/m) + Cable Factor(dB) – Pre-Amplifier Factor(dB)
3. The other emission levels were very low against the limit.
4. Margin value = Emission Level – Limit value
5. " * ": Fundamental frequency.
6. " # ": The radiated frequency is out of the restricted band.

CHANNEL	TX Channel 157	DETECTOR FUNCTION	Peak (PK)
FREQUENCY RANGE	1GHz ~ 40GHz		Average (AV)

ANTENNA POLARITY & TEST DISTANCE: HORIZONTAL AT 3 M

NO.	FREQ. (MHz)	EMISSION LEVEL (dBuV/m)	LIMIT (dBuV/m)	MARGIN (dB)	ANTENNA HEIGHT (m)	TABLE ANGLE (Degree)	RAW VALUE (dBuV)	CORRECTION FACTOR (dB/m)
1	#5627.43	61.8 PK	68.2	-6.4	1.04 H	260	57.1	4.7
2	*5785.00	119.9 PK			1.04 H	260	114.9	5.0
3	*5785.00	110.1 AV			1.04 H	260	105.1	5.0
4	#5941.40	62.2 PK	68.2	-6.0	1.04 H	260	56.8	5.4
5	11570.00	47.7 PK	74.0	-26.3	1.07 H	237	33.7	14.0
6	11570.00	35.5 AV	54.0	-18.5	1.07 H	237	21.5	14.0
7	#17355.00	52.7 PK	74.0	-21.3	1.04 H	181	33.8	18.9
8	#17355.00	40.5 AV	54.0	-13.5	1.04 H	181	21.6	18.9

ANTENNA POLARITY & TEST DISTANCE: VERTICAL AT 3 M

NO.	FREQ. (MHz)	EMISSION LEVEL (dBuV/m)	LIMIT (dBuV/m)	MARGIN (dB)	ANTENNA HEIGHT (m)	TABLE ANGLE (Degree)	RAW VALUE (dBuV)	CORRECTION FACTOR (dB/m)
1	#5617.94	62.5 PK	68.2	-5.7	2.95 V	166	57.8	4.7
2	*5785.00	122.6 PK			2.95 V	166	117.6	5.0
3	*5785.00	112.4 AV			2.95 V	166	107.4	5.0
4	#6020.26	62.5 PK	68.2	-5.7	2.95 V	166	56.8	5.7
5	11570.00	47.3 PK	74.0	-26.7	1.59 V	35	33.3	14.0
6	11570.00	34.9 AV	54.0	-19.1	1.59 V	35	20.9	14.0
7	#17355.00	53.0 PK	74.0	-21.0	1.59 V	97	34.1	18.9
8	#17355.00	40.5 AV	54.0	-13.5	1.59 V	97	21.6	18.9

REMARKS:

1. Emission Level(dBuV/m) = Raw Value(dBuV) + Correction Factor(dB/m)
2. Correction Factor(dB/m) = Antenna Factor(dB/m) + Cable Factor(dB) – Pre-Amplifier Factor(dB)
3. The other emission levels were very low against the limit.
4. Margin value = Emission Level – Limit value
5. " * ": Fundamental frequency.
6. " # ": The radiated frequency is out of the restricted band.

CHANNEL	TX Channel 165	DETECTOR FUNCTION	Peak (PK)
FREQUENCY RANGE	1GHz ~ 40GHz		Average (AV)

ANTENNA POLARITY & TEST DISTANCE: HORIZONTAL AT 3 M

NO.	FREQ. (MHz)	EMISSION LEVEL (dBuV/m)	LIMIT (dBuV/m)	MARGIN (dB)	ANTENNA HEIGHT (m)	TABLE ANGLE (Degree)	RAW VALUE (dBuV)	CORRECTION FACTOR (dB/m)
1	#5589.90	63.3 PK	68.2	-4.9	1.25 H	260	58.7	4.6
2	*5825.00	119.8 PK			1.25 H	260	114.6	5.2
3	*5825.00	109.9 AV			1.25 H	260	104.7	5.2
4	#5981.77	62.6 PK	68.2	-5.6	1.25 H	260	57.0	5.6
5	11650.00	47.8 PK	74.0	-26.2	1.13 H	238	33.7	14.1
6	11650.00	35.4 AV	54.0	-18.6	1.13 H	238	21.3	14.1
7	#17475.00	53.0 PK	74.0	-21.0	1.09 H	179	33.3	19.7
8	#17475.00	40.8 AV	54.0	-13.2	1.09 H	179	21.1	19.7

ANTENNA POLARITY & TEST DISTANCE: VERTICAL AT 3 M

NO.	FREQ. (MHz)	EMISSION LEVEL (dBuV/m)	LIMIT (dBuV/m)	MARGIN (dB)	ANTENNA HEIGHT (m)	TABLE ANGLE (Degree)	RAW VALUE (dBuV)	CORRECTION FACTOR (dB/m)
1	#5577.43	65.3 PK	68.2	-2.9	2.95 V	159	60.7	4.6
2	*5825.00	122.8 PK			2.95 V	159	117.6	5.2
3	*5825.00	112.5 AV			2.95 V	159	107.3	5.2
4	#5978.51	62.5 PK	68.2	-5.7	2.95 V	159	57.0	5.5
5	11650.00	47.4 PK	74.0	-26.6	1.53 V	48	33.3	14.1
6	11650.00	34.8 AV	54.0	-19.2	1.53 V	48	20.7	14.1
7	#17475.00	52.4 PK	74.0	-21.6	1.55 V	84	32.7	19.7
8	#17475.00	40.1 AV	54.0	-13.9	1.55 V	84	20.4	19.7

REMARKS:

1. Emission Level(dBuV/m) = Raw Value(dBuV) + Correction Factor(dB/m)
2. Correction Factor(dB/m) = Antenna Factor(dB/m) + Cable Factor(dB) – Pre-Amplifier Factor(dB)
3. The other emission levels were very low against the limit.
4. Margin value = Emission Level – Limit value
5. " * ": Fundamental frequency.
6. " # ": The radiated frequency is out of the restricted band.

802.11ac (VHT20)

CHANNEL	TX Channel 36	DETECTOR FUNCTION	Peak (PK)
FREQUENCY RANGE	1GHz ~ 40GHz		Average (AV)

ANTENNA POLARITY & TEST DISTANCE: HORIZONTAL AT 3 M

NO.	FREQ. (MHz)	EMISSION LEVEL (dBuV/m)	LIMIT (dBuV/m)	MARGIN (dB)	ANTENNA HEIGHT (m)	TABLE ANGLE (Degree)	RAW VALUE (dBuV)	CORRECTION FACTOR (dB/m)
1	5150.00	61.2 PK	74.0	-12.8	1.12 H	200	57.2	4.0
2	5150.00	48.3 AV	54.0	-5.7	1.12 H	200	44.3	4.0
3	*5180.00	116.9 PK			1.12 H	200	112.9	4.0
4	*5180.00	106.4 AV			1.12 H	200	102.4	4.0
5	#10360.00	54.1 PK	74.0	-19.9	1.00 H	216	40.5	13.6
6	#10360.00	42.2 AV	54.0	-11.8	1.00 H	216	28.6	13.6
7	15540.00	57.9 PK	74.0	-16.1	1.00 H	181	44.7	13.2
8	15540.00	44.9 AV	54.0	-9.1	1.00 H	181	31.7	13.2

ANTENNA POLARITY & TEST DISTANCE: VERTICAL AT 3 M

NO.	FREQ. (MHz)	EMISSION LEVEL (dBuV/m)	LIMIT (dBuV/m)	MARGIN (dB)	ANTENNA HEIGHT (m)	TABLE ANGLE (Degree)	RAW VALUE (dBuV)	CORRECTION FACTOR (dB/m)
1	5150.00	67.5 PK	74.0	-6.5	1.02 V	97	63.5	4.0
2	5150.00	53.8 AV	54.0	-0.2	1.02 V	97	49.8	4.0
3	*5180.00	120.3 PK			1.02 V	97	116.3	4.0
4	*5180.00	109.9 AV			1.02 V	97	105.9	4.0
5	#10360.00	50.5 PK	74.0	-23.5	1.00 V	169	36.9	13.6
6	#10360.00	39.3 AV	54.0	-14.7	1.00 V	169	25.7	13.6
7	15540.00	56.0 PK	74.0	-18.0	1.19 V	198	42.8	13.2
8	15540.00	42.8 AV	54.0	-11.2	1.19 V	198	29.6	13.2

REMARKS:

- Emission Level(dBuV/m) = Raw Value(dBuV) + Correction Factor(dB/m)
- Correction Factor(dB/m) = Antenna Factor(dB/m) + Cable Factor(dB) – Pre-Amplifier Factor(dB)
- The other emission levels were very low against the limit.
- Margin value = Emission Level – Limit value
- " * ": Fundamental frequency.
- " # ": The radiated frequency is out of the restricted band.

CHANNEL	TX Channel 40	DETECTOR FUNCTION	Peak (PK)
FREQUENCY RANGE	1GHz ~ 40GHz		Average (AV)

ANTENNA POLARITY & TEST DISTANCE: HORIZONTAL AT 3 M

NO.	FREQ. (MHz)	EMISSION LEVEL (dBuV/m)	LIMIT (dBuV/m)	MARGIN (dB)	ANTENNA HEIGHT (m)	TABLE ANGLE (Degree)	RAW VALUE (dBuV)	CORRECTION FACTOR (dB/m)
1	5150.00	63.2 PK	74.0	-10.8	1.08 H	208	59.2	4.0
2	5150.00	50.1 AV	54.0	-3.9	1.08 H	208	46.1	4.0
3	*5200.00	117.7 PK			1.08 H	208	113.7	4.0
4	*5200.00	107.2 AV			1.08 H	208	103.2	4.0
5	5350.00	57.3 PK	74.0	-16.7	1.08 H	208	52.9	4.4
6	5350.00	46.2 AV	54.0	-7.8	1.08 H	208	41.8	4.4
7	#10400.00	53.6 PK	74.0	-20.4	1.00 H	232	40.0	13.6
8	#10400.00	42.0 AV	54.0	-12.0	1.00 H	232	28.4	13.6
9	15600.00	58.3 PK	74.0	-15.7	1.03 H	181	44.9	13.4
10	15600.00	45.1 AV	54.0	-8.9	1.03 H	181	31.7	13.4

ANTENNA POLARITY & TEST DISTANCE: VERTICAL AT 3 M

NO.	FREQ. (MHz)	EMISSION LEVEL (dBuV/m)	LIMIT (dBuV/m)	MARGIN (dB)	ANTENNA HEIGHT (m)	TABLE ANGLE (Degree)	RAW VALUE (dBuV)	CORRECTION FACTOR (dB/m)
1	5150.00	67.1 PK	74.0	-6.9	1.05 V	97	63.1	4.0
2	5150.00	53.9 AV	54.0	-0.1	1.05 V	97	49.9	4.0
3	*5200.00	121.1 PK			1.05 V	97	117.1	4.0
4	*5200.00	110.7 AV			1.05 V	97	106.7	4.0
5	5350.00	60.5 PK	74.0	-13.5	1.05 V	97	56.1	4.4
6	5350.00	49.8 AV	54.0	-4.2	1.05 V	97	45.4	4.4
7	#10400.00	51.1 PK	74.0	-22.9	1.00 V	150	37.5	13.6
8	#10400.00	39.7 AV	54.0	-14.3	1.00 V	150	26.1	13.6
9	15600.00	56.7 PK	74.0	-17.3	1.20 V	192	43.3	13.4
10	15600.00	43.2 AV	54.0	-10.8	1.20 V	192	29.8	13.4

REMARKS:

- Emission Level(dBuV/m) = Raw Value(dBuV) + Correction Factor(dB/m)
- Correction Factor(dB/m) = Antenna Factor(dB/m) + Cable Factor(dB) – Pre-Amplifier Factor(dB)
- The other emission levels were very low against the limit.
- Margin value = Emission Level – Limit value
- " * ": Fundamental frequency.
- " # ": The radiated frequency is out of the restricted band.

CHANNEL	TX Channel 48	DETECTOR FUNCTION	Peak (PK)
FREQUENCY RANGE	1GHz ~ 40GHz		Average (AV)

ANTENNA POLARITY & TEST DISTANCE: HORIZONTAL AT 3 M

NO.	FREQ. (MHz)	EMISSION LEVEL (dBuV/m)	LIMIT (dBuV/m)	MARGIN (dB)	ANTENNA HEIGHT (m)	TABLE ANGLE (Degree)	RAW VALUE (dBuV)	CORRECTION FACTOR (dB/m)
1	*5240.00	117.4 PK			1.07 H	213	113.2	4.2
2	*5240.00	107.0 AV			1.07 H	213	102.8	4.2
3	5350.00	51.5 PK	74.0	-22.5	1.07 H	213	47.1	4.4
4	5350.00	40.1 AV	54.0	-13.9	1.07 H	213	35.7	4.4
5	#10480.00	53.9 PK	74.0	-20.1	1.00 H	221	40.2	13.7
6	#10480.00	42.3 AV	54.0	-11.7	1.00 H	221	28.6	13.7
7	15720.00	58.4 PK	74.0	-15.6	1.05 H	189	44.4	14.0
8	15720.00	45.3 AV	54.0	-8.7	1.05 H	189	31.3	14.0

ANTENNA POLARITY & TEST DISTANCE: VERTICAL AT 3 M

NO.	FREQ. (MHz)	EMISSION LEVEL (dBuV/m)	LIMIT (dBuV/m)	MARGIN (dB)	ANTENNA HEIGHT (m)	TABLE ANGLE (Degree)	RAW VALUE (dBuV)	CORRECTION FACTOR (dB/m)
1	*5240.00	120.9 PK			1.00 V	98	116.7	4.2
2	*5240.00	110.2 AV			1.00 V	98	106.0	4.2
3	5350.00	54.5 PK	74.0	-19.5	1.00 V	98	50.1	4.4
4	5350.00	43.9 AV	54.0	-10.1	1.00 V	98	39.5	4.4
5	#10480.00	51.1 PK	74.0	-22.9	1.00 V	166	37.4	13.7
6	#10480.00	39.8 AV	54.0	-14.2	1.00 V	166	26.1	13.7
7	15720.00	56.5 PK	74.0	-17.5	1.15 V	191	42.5	14.0
8	15720.00	43.0 AV	54.0	-11.0	1.15 V	191	29.0	14.0

REMARKS:

1. Emission Level(dBuV/m) = Raw Value(dBuV) + Correction Factor(dB/m)
2. Correction Factor(dB/m) = Antenna Factor(dB/m) + Cable Factor(dB) – Pre-Amplifier Factor(dB)
3. The other emission levels were very low against the limit.
4. Margin value = Emission Level – Limit value
5. " * ": Fundamental frequency.
6. " # ": The radiated frequency is out of the restricted band.

CHANNEL	TX Channel 149	DETECTOR FUNCTION	Peak (PK)
FREQUENCY RANGE	1GHz ~ 40GHz		Average (AV)

ANTENNA POLARITY & TEST DISTANCE: HORIZONTAL AT 3 M

NO.	FREQ. (MHz)	EMISSION LEVEL (dBuV/m)	LIMIT (dBuV/m)	MARGIN (dB)	ANTENNA HEIGHT (m)	TABLE ANGLE (Degree)	RAW VALUE (dBuV)	CORRECTION FACTOR (dB/m)
1	#5649.27	63.2 PK	68.2	-5.0	1.25 H	262	58.4	4.8
2	*5745.00	120.0 PK			1.25 H	262	115.0	5.0
3	*5745.00	109.5 AV			1.25 H	262	104.5	5.0
4	#5992.70	63.8 PK	68.2	-4.4	1.25 H	262	58.2	5.6
5	11490.00	47.7 PK	74.0	-26.3	1.15 H	227	33.6	14.1
6	11490.00	35.1 AV	54.0	-18.9	1.15 H	227	21.0	14.1
7	#17235.00	52.9 PK	74.0	-21.1	1.11 H	171	34.6	18.3
8	#17235.00	40.9 AV	54.0	-13.1	1.11 H	171	22.6	18.3

ANTENNA POLARITY & TEST DISTANCE: VERTICAL AT 3 M

NO.	FREQ. (MHz)	EMISSION LEVEL (dBuV/m)	LIMIT (dBuV/m)	MARGIN (dB)	ANTENNA HEIGHT (m)	TABLE ANGLE (Degree)	RAW VALUE (dBuV)	CORRECTION FACTOR (dB/m)
1	#5637.42	62.6 PK	68.2	-5.6	2.99 V	170	57.8	4.8
2	*5745.00	122.8 PK			2.99 V	170	117.8	5.0
3	*5745.00	112.5 AV			2.99 V	170	107.5	5.0
4	#5977.88	63.0 PK	68.2	-5.2	2.99 V	170	57.5	5.5
5	11490.00	47.3 PK	74.0	-26.7	1.52 V	60	33.2	14.1
6	11490.00	34.8 AV	54.0	-19.2	1.52 V	60	20.7	14.1
7	#17235.00	52.4 PK	74.0	-21.6	1.51 V	98	34.1	18.3
8	#17235.00	40.2 AV	54.0	-13.8	1.51 V	98	21.9	18.3

REMARKS:

1. Emission Level(dBuV/m) = Raw Value(dBuV) + Correction Factor(dB/m)
2. Correction Factor(dB/m) = Antenna Factor(dB/m) + Cable Factor(dB) – Pre-Amplifier Factor(dB)
3. The other emission levels were very low against the limit.
4. Margin value = Emission Level – Limit value
5. " * ": Fundamental frequency.
6. " # ": The radiated frequency is out of the restricted band.

CHANNEL	TX Channel 157	DETECTOR FUNCTION	Peak (PK)
FREQUENCY RANGE	1GHz ~ 40GHz		Average (AV)

ANTENNA POLARITY & TEST DISTANCE: HORIZONTAL AT 3 M

NO.	FREQ. (MHz)	EMISSION LEVEL (dBuV/m)	LIMIT (dBuV/m)	MARGIN (dB)	ANTENNA HEIGHT (m)	TABLE ANGLE (Degree)	RAW VALUE (dBuV)	CORRECTION FACTOR (dB/m)
1	#5627.90	62.7 PK	68.2	-5.5	1.26 H	258	58.0	4.7
2	*5785.00	119.5 PK			1.26 H	258	114.5	5.0
3	*5785.00	109.2 AV			1.26 H	258	104.2	5.0
4	#5948.52	62.3 PK	68.2	-5.9	1.26 H	258	56.9	5.4
5	11570.00	47.8 PK	74.0	-26.2	1.18 H	241	33.8	14.0
6	11570.00	35.4 AV	54.0	-18.6	1.18 H	241	21.4	14.0
7	#17355.00	52.7 PK	74.0	-21.3	1.06 H	168	33.8	18.9
8	#17355.00	40.6 AV	54.0	-13.4	1.06 H	168	21.7	18.9

ANTENNA POLARITY & TEST DISTANCE: VERTICAL AT 3 M

NO.	FREQ. (MHz)	EMISSION LEVEL (dBuV/m)	LIMIT (dBuV/m)	MARGIN (dB)	ANTENNA HEIGHT (m)	TABLE ANGLE (Degree)	RAW VALUE (dBuV)	CORRECTION FACTOR (dB/m)
1	#5550.69	63.0 PK	68.2	-5.2	2.98 V	152	58.5	4.5
2	*5785.00	122.5 PK			2.98 V	152	117.5	5.0
3	*5785.00	112.2 AV			2.98 V	152	107.2	5.0
4	#6018.34	62.0 PK	68.2	-6.2	2.98 V	152	56.3	5.7
5	11570.00	47.8 PK	74.0	-26.2	1.57 V	36	33.8	14.0
6	11570.00	35.0 AV	54.0	-19.0	1.57 V	36	21.0	14.0
7	#17355.00	52.7 PK	74.0	-21.3	1.59 V	87	33.8	18.9
8	#17355.00	40.3 AV	54.0	-13.7	1.59 V	87	21.4	18.9

REMARKS:

1. Emission Level(dBuV/m) = Raw Value(dBuV) + Correction Factor(dB/m)
2. Correction Factor(dB/m) = Antenna Factor(dB/m) + Cable Factor(dB) – Pre-Amplifier Factor(dB)
3. The other emission levels were very low against the limit.
4. Margin value = Emission Level – Limit value
5. " * ": Fundamental frequency.
6. " # ": The radiated frequency is out of the restricted band.

CHANNEL	TX Channel 165	DETECTOR FUNCTION	Peak (PK)
FREQUENCY RANGE	1GHz ~ 40GHz		Average (AV)

ANTENNA POLARITY & TEST DISTANCE: HORIZONTAL AT 3 M

NO.	FREQ. (MHz)	EMISSION LEVEL (dBuV/m)	LIMIT (dBuV/m)	MARGIN (dB)	ANTENNA HEIGHT (m)	TABLE ANGLE (Degree)	RAW VALUE (dBuV)	CORRECTION FACTOR (dB/m)
1	#5590.85	63.0 PK	68.2	-5.2	1.25 H	259	58.4	4.6
2	*5825.00	119.8 PK			1.25 H	259	114.6	5.2
3	*5825.00	109.5 AV			1.25 H	259	104.3	5.2
4	#5995.07	62.5 PK	68.2	-5.7	1.25 H	259	56.9	5.6
5	11650.00	47.8 PK	74.0	-26.2	1.16 H	227	33.7	14.1
6	11650.00	35.5 AV	54.0	-18.5	1.16 H	227	21.4	14.1
7	#17475.00	53.4 PK	74.0	-20.6	1.07 H	174	33.7	19.7
8	#17475.00	41.0 AV	54.0	-13.0	1.07 H	174	21.3	19.7

ANTENNA POLARITY & TEST DISTANCE: VERTICAL AT 3 M

NO.	FREQ. (MHz)	EMISSION LEVEL (dBuV/m)	LIMIT (dBuV/m)	MARGIN (dB)	ANTENNA HEIGHT (m)	TABLE ANGLE (Degree)	RAW VALUE (dBuV)	CORRECTION FACTOR (dB/m)
1	#5590.90	65.2 PK	68.2	-3.0	3.01 V	190	60.6	4.6
2	*5825.00	122.4 PK			3.01 V	190	117.2	5.2
3	*5825.00	112.2 AV			3.01 V	190	107.0	5.2
4	#5987.31	61.9 PK	68.2	-6.3	3.01 V	190	56.3	5.6
5	11650.00	47.0 PK	74.0	-27.0	1.49 V	33	32.9	14.1
6	11650.00	34.6 AV	54.0	-19.4	1.49 V	33	20.5	14.1
7	#17475.00	52.5 PK	74.0	-21.5	1.59 V	98	32.8	19.7
8	#17475.00	40.1 AV	54.0	-13.9	1.59 V	98	20.4	19.7

REMARKS:

1. Emission Level(dBuV/m) = Raw Value(dBuV) + Correction Factor(dB/m)
2. Correction Factor(dB/m) = Antenna Factor(dB/m) + Cable Factor(dB) – Pre-Amplifier Factor(dB)
3. The other emission levels were very low against the limit.
4. Margin value = Emission Level – Limit value
5. " * ": Fundamental frequency.
6. " # ": The radiated frequency is out of the restricted band.

802.11ac (VHT40)

CHANNEL	TX Channel 38	DETECTOR FUNCTION	Peak (PK)
FREQUENCY RANGE	1GHz ~ 40GHz		Average (AV)

ANTENNA POLARITY & TEST DISTANCE: HORIZONTAL AT 3 M

NO.	FREQ. (MHz)	EMISSION LEVEL (dBuV/m)	LIMIT (dBuV/m)	MARGIN (dB)	ANTENNA HEIGHT (m)	TABLE ANGLE (Degree)	RAW VALUE (dBuV)	CORRECTION FACTOR (dB/m)
1	5150.00	65.2 PK	74.0	-8.8	1.18 H	213	61.2	4.0
2	5150.00	50.1 AV	54.0	-3.9	1.18 H	213	46.1	4.0
3	*5190.00	113.0 PK			1.18 H	213	109.0	4.0
4	*5190.00	101.0 AV			1.18 H	213	97.0	4.0
5	5350.00	57.4 PK	74.0	-16.6	1.18 H	213	53.0	4.4
6	5350.00	46.8 AV	54.0	-7.2	1.18 H	213	42.4	4.4
7	#10380.00	47.1 PK	74.0	-26.9	1.14 H	224	33.5	13.6
8	#10380.00	35.5 AV	54.0	-18.5	1.14 H	224	21.9	13.6
9	15570.00	52.3 PK	74.0	-21.7	1.04 H	175	39.0	13.3
10	15570.00	40.0 AV	54.0	-14.0	1.04 H	175	26.7	13.3

ANTENNA POLARITY & TEST DISTANCE: VERTICAL AT 3 M

NO.	FREQ. (MHz)	EMISSION LEVEL (dBuV/m)	LIMIT (dBuV/m)	MARGIN (dB)	ANTENNA HEIGHT (m)	TABLE ANGLE (Degree)	RAW VALUE (dBuV)	CORRECTION FACTOR (dB/m)
1	5150.00	68.8 PK	74.0	-5.2	1.00 V	193	64.8	4.0
2	5150.00	53.9 AV	54.0	-0.1	1.00 V	193	49.9	4.0
3	*5190.00	116.8 PK			1.00 V	193	112.8	4.0
4	*5190.00	104.4 AV			1.00 V	193	100.4	4.0
5	5350.00	61.2 PK	74.0	-12.8	1.00 V	193	56.8	4.4
6	5350.00	50.1 AV	54.0	-3.9	1.00 V	193	45.7	4.4
7	#10380.00	49.2 PK	74.0	-24.8	1.08 V	178	35.6	13.6
8	#10380.00	37.0 AV	54.0	-17.0	1.08 V	178	23.4	13.6
9	15570.00	51.3 PK	74.0	-22.7	1.12 V	226	38.0	13.3
10	15570.00	39.6 AV	54.0	-14.4	1.12 V	226	26.3	13.3

REMARKS:

- Emission Level(dBuV/m) = Raw Value(dBuV) + Correction Factor(dB/m)
- Correction Factor(dB/m) = Antenna Factor(dB/m) + Cable Factor(dB) – Pre-Amplifier Factor(dB)
- The other emission levels were very low against the limit.
- Margin value = Emission Level – Limit value
- " * ": Fundamental frequency.
- " # ": The radiated frequency is out of the restricted band.

CHANNEL	TX Channel 46	DETECTOR FUNCTION	Peak (PK)
FREQUENCY RANGE	1GHz ~ 40GHz		Average (AV)

ANTENNA POLARITY & TEST DISTANCE: HORIZONTAL AT 3 M

NO.	FREQ. (MHz)	EMISSION LEVEL (dBuV/m)	LIMIT (dBuV/m)	MARGIN (dB)	ANTENNA HEIGHT (m)	TABLE ANGLE (Degree)	RAW VALUE (dBuV)	CORRECTION FACTOR (dB/m)
1	5150.00	60.7 PK	74.0	-13.3	1.19 H	219	56.7	4.0
2	5150.00	49.9 AV	54.0	-4.1	1.19 H	219	45.9	4.0
3	*5230.00	118.4 PK			1.19 H	219	114.2	4.2
4	*5230.00	107.2 AV			1.19 H	219	103.0	4.2
5	5396.00	59.7 PK	74.0	-14.3	1.19 H	219	55.3	4.4
6	5396.00	48.8 AV	54.0	-5.2	1.19 H	219	44.4	4.4
7	#10460.00	54.0 PK	74.0	-20.0	1.04 H	219	40.3	13.7
8	#10460.00	42.6 AV	54.0	-11.4	1.04 H	219	28.9	13.7
9	15690.00	58.2 PK	74.0	-15.8	1.03 H	192	44.2	14.0
10	15690.00	45.2 AV	54.0	-8.8	1.03 H	192	31.2	14.0

ANTENNA POLARITY & TEST DISTANCE: VERTICAL AT 3 M

NO.	FREQ. (MHz)	EMISSION LEVEL (dBuV/m)	LIMIT (dBuV/m)	MARGIN (dB)	ANTENNA HEIGHT (m)	TABLE ANGLE (Degree)	RAW VALUE (dBuV)	CORRECTION FACTOR (dB/m)
1	5150.00	64.5 PK	74.0	-9.5	1.15 V	98	60.5	4.0
2	5150.00	53.7 AV	54.0	-0.3	1.15 V	98	49.7	4.0
3	*5230.00	122.3 PK			1.15 V	98	118.1	4.2
4	*5230.00	110.6 AV			1.15 V	98	106.4	4.2
5	5396.00	63.4 PK	74.0	-10.6	1.15 V	98	59.0	4.4
6	5396.00	52.5 AV	54.0	-1.5	1.15 V	98	48.1	4.4
7	#10460.00	51.6 PK	74.0	-22.4	1.03 V	154	37.9	13.7
8	#10460.00	40.2 AV	54.0	-13.8	1.03 V	154	26.5	13.7
9	15690.00	56.6 PK	74.0	-17.4	1.15 V	178	42.6	14.0
10	15690.00	43.1 AV	54.0	-10.9	1.15 V	178	29.1	14.0

REMARKS:

1. Emission Level(dBuV/m) = Raw Value(dBuV) + Correction Factor(dB/m)
2. Correction Factor(dB/m) = Antenna Factor(dB/m) + Cable Factor(dB) – Pre-Amplifier Factor(dB)
3. The other emission levels were very low against the limit.
4. Margin value = Emission Level – Limit value
5. " * ": Fundamental frequency.
6. " # ": The radiated frequency is out of the restricted band.

CHANNEL	TX Channel 151	DETECTOR FUNCTION	Peak (PK)
FREQUENCY RANGE	1GHz ~ 40GHz		Average (AV)

ANTENNA POLARITY & TEST DISTANCE: HORIZONTAL AT 3 M

NO.	FREQ. (MHz)	EMISSION LEVEL (dBuV/m)	LIMIT (dBuV/m)	MARGIN (dB)	ANTENNA HEIGHT (m)	TABLE ANGLE (Degree)	RAW VALUE (dBuV)	CORRECTION FACTOR (dB/m)
1	#5611.27	62.8 PK	68.2	-5.4	1.31 H	260	58.1	4.7
2	*5755.00	119.3 PK			1.31 H	260	114.3	5.0
3	*5755.00	109.2 AV			1.31 H	260	104.2	5.0
4	#5934.27	61.9 PK	68.2	-6.3	1.31 H	260	56.5	5.4
5	11510.00	47.7 PK	74.0	-26.3	1.18 H	238	33.7	14.0
6	11510.00	35.1 AV	54.0	-18.9	1.18 H	238	21.1	14.0
7	#17265.00	52.6 PK	74.0	-21.4	1.06 H	168	34.1	18.5
8	#17265.00	40.7 AV	54.0	-13.3	1.06 H	168	22.2	18.5

ANTENNA POLARITY & TEST DISTANCE: VERTICAL AT 3 M

NO.	FREQ. (MHz)	EMISSION LEVEL (dBuV/m)	LIMIT (dBuV/m)	MARGIN (dB)	ANTENNA HEIGHT (m)	TABLE ANGLE (Degree)	RAW VALUE (dBuV)	CORRECTION FACTOR (dB/m)
1	#5647.13	64.7 PK	68.2	-3.5	1.11 V	89	59.9	4.8
2	*5755.00	121.8 PK			1.11 V	89	116.8	5.0
3	*5755.00	111.9 AV			1.11 V	89	106.9	5.0
4	#5935.11	60.3 PK	68.2	-7.9	1.11 V	89	54.9	5.4
5	11510.00	47.4 PK	74.0	-26.6	1.49 V	40	33.4	14.0
6	11510.00	34.8 AV	54.0	-19.2	1.49 V	40	20.8	14.0
7	#17265.00	52.4 PK	74.0	-21.6	1.51 V	73	33.9	18.5
8	#17265.00	40.4 AV	54.0	-13.6	1.51 V	73	21.9	18.5

REMARKS:

1. Emission Level(dBuV/m) = Raw Value(dBuV) + Correction Factor(dB/m)
2. Correction Factor(dB/m) = Antenna Factor(dB/m) + Cable Factor(dB) – Pre-Amplifier Factor(dB)
3. The other emission levels were very low against the limit.
4. Margin value = Emission Level – Limit value
5. " * ": Fundamental frequency.
6. " # ": The radiated frequency is out of the restricted band.

CHANNEL	TX Channel 159	DETECTOR FUNCTION	Peak (PK)
FREQUENCY RANGE	1GHz ~ 40GHz		Average (AV)

ANTENNA POLARITY & TEST DISTANCE: HORIZONTAL AT 3 M

NO.	FREQ. (MHz)	EMISSION LEVEL (dBuV/m)	LIMIT (dBuV/m)	MARGIN (dB)	ANTENNA HEIGHT (m)	TABLE ANGLE (Degree)	RAW VALUE (dBuV)	CORRECTION FACTOR (dB/m)
1	#5628.37	63.7 PK	68.2	-4.5	1.04 H	260	59.0	4.7
2	*5795.00	119.0 PK			1.04 H	260	113.9	5.1
3	*5795.00	109.1 AV			1.04 H	260	104.0	5.1
4	#5962.30	64.0 PK	68.2	-4.2	1.04 H	260	58.5	5.5
5	11590.00	47.8 PK	74.0	-26.2	1.16 H	255	33.8	14.0
6	11590.00	35.2 AV	54.0	-18.8	1.16 H	255	21.2	14.0
7	#17385.00	52.5 PK	74.0	-21.5	1.11 H	183	33.4	19.1
8	#17385.00	40.1 AV	54.0	-13.9	1.11 H	183	21.0	19.1

ANTENNA POLARITY & TEST DISTANCE: VERTICAL AT 3 M

NO.	FREQ. (MHz)	EMISSION LEVEL (dBuV/m)	LIMIT (dBuV/m)	MARGIN (dB)	ANTENNA HEIGHT (m)	TABLE ANGLE (Degree)	RAW VALUE (dBuV)	CORRECTION FACTOR (dB/m)
1	#5625.99	63.1 PK	68.2	-5.1	1.00 V	89	58.4	4.7
2	*5795.00	122.1 PK			1.00 V	89	117.0	5.1
3	*5795.00	112.0 AV			1.00 V	89	106.9	5.1
4	#5941.59	62.6 PK	68.2	-5.6	1.00 V	89	57.2	5.4
5	11590.00	47.5 PK	74.0	-26.5	1.51 V	59	33.5	14.0
6	11590.00	35.1 AV	54.0	-18.9	1.51 V	59	21.1	14.0
7	#17385.00	52.2 PK	74.0	-21.8	1.58 V	99	33.1	19.1
8	#17385.00	40.1 AV	54.0	-13.9	1.58 V	99	21.0	19.1

REMARKS:

1. Emission Level(dBuV/m) = Raw Value(dBuV) + Correction Factor(dB/m)
2. Correction Factor(dB/m) = Antenna Factor(dB/m) + Cable Factor(dB) – Pre-Amplifier Factor(dB)
3. The other emission levels were very low against the limit.
4. Margin value = Emission Level – Limit value
5. " * ": Fundamental frequency.
6. " # ": The radiated frequency is out of the restricted band.

802.11ac (VHT80)

CHANNEL	TX Channel 42	DETECTOR FUNCTION	Peak (PK)
FREQUENCY RANGE	1GHz ~ 40GHz		Average (AV)

ANTENNA POLARITY & TEST DISTANCE: HORIZONTAL AT 3 M

NO.	FREQ. (MHz)	EMISSION LEVEL (dBuV/m)	LIMIT (dBuV/m)	MARGIN (dB)	ANTENNA HEIGHT (m)	TABLE ANGLE (Degree)	RAW VALUE (dBuV)	CORRECTION FACTOR (dB/m)
1	5150.00	60.9 PK	74.0	-13.1	1.07 H	215	56.9	4.0
2	5150.00	50.1 AV	54.0	-3.9	1.07 H	215	46.1	4.0
3	*5210.00	109.7 PK			1.07 H	215	105.6	4.1
4	*5210.00	100.6 AV			1.07 H	215	96.5	4.1
5	5350.00	56.5 PK	74.0	-17.5	1.07 H	215	52.1	4.4
6	5350.00	46.1 AV	54.0	-7.9	1.07 H	215	41.7	4.4
7	#10420.00	48.1 PK	74.0	-25.9	1.13 H	207	34.5	13.6
8	#10420.00	36.3 AV	54.0	-17.7	1.13 H	207	22.7	13.6
9	15630.00	53.3 PK	74.0	-20.7	1.08 H	177	39.7	13.6
10	15630.00	40.5 AV	54.0	-13.5	1.08 H	177	26.9	13.6

ANTENNA POLARITY & TEST DISTANCE: VERTICAL AT 3 M

NO.	FREQ. (MHz)	EMISSION LEVEL (dBuV/m)	LIMIT (dBuV/m)	MARGIN (dB)	ANTENNA HEIGHT (m)	TABLE ANGLE (Degree)	RAW VALUE (dBuV)	CORRECTION FACTOR (dB/m)
1	5150.00	64.7 PK	74.0	-9.3	1.19 V	93	60.7	4.0
2	5150.00	53.9 AV	54.0	-0.1	1.19 V	93	49.9	4.0
3	*5210.00	113.5 PK			1.19 V	93	109.4	4.1
4	*5210.00	104.1 AV			1.19 V	93	100.0	4.1
5	5350.00	60.2 PK	74.0	-13.8	1.19 V	93	55.8	4.4
6	5350.00	49.8 AV	54.0	-4.2	1.19 V	93	45.4	4.4
7	#10420.00	47.3 PK	74.0	-26.7	1.10 V	204	33.7	13.6
8	#10420.00	35.5 AV	54.0	-18.5	1.10 V	204	21.9	13.6
9	15630.00	52.1 PK	74.0	-21.9	1.07 V	229	38.5	13.6
10	15630.00	40.2 AV	54.0	-13.8	1.07 V	229	26.6	13.6

REMARKS:

1. Emission Level(dBuV/m) = Raw Value(dBuV) + Correction Factor(dB/m)
2. Correction Factor(dB/m) = Antenna Factor(dB/m) + Cable Factor(dB) – Pre-Amplifier Factor(dB)
3. The other emission levels were very low against the limit.
4. Margin value = Emission Level – Limit value
5. " * ": Fundamental frequency.
6. " # ": The radiated frequency is out of the restricted band.

CHANNEL	TX Channel 155	DETECTOR FUNCTION	Peak (PK)
FREQUENCY RANGE	1GHz ~ 40GHz		Average (AV)

ANTENNA POLARITY & TEST DISTANCE: HORIZONTAL AT 3 M

NO.	FREQ. (MHz)	EMISSION LEVEL (dBuV/m)	LIMIT (dBuV/m)	MARGIN (dB)	ANTENNA HEIGHT (m)	TABLE ANGLE (Degree)	RAW VALUE (dBuV)	CORRECTION FACTOR (dB/m)
1	#5641.20	66.8 PK	68.2	-1.4	1.11 H	260	62.0	4.8
2	*5775.00	116.4 PK			1.11 H	260	111.4	5.0
3	*5775.00	106.1 AV			1.11 H	260	101.1	5.0
4	#5935.70	66.9 PK	68.2	-1.3	1.11 H	260	61.5	5.4
5	11550.00	47.3 PK	74.0	-26.7	1.21 H	241	33.3	14.0
6	11550.00	34.9 AV	54.0	-19.1	1.21 H	241	20.9	14.0
7	#17325.00	52.7 PK	74.0	-21.3	1.06 H	182	34.1	18.6
8	#17325.00	40.8 AV	54.0	-13.2	1.06 H	182	22.2	18.6

ANTENNA POLARITY & TEST DISTANCE: VERTICAL AT 3 M

NO.	FREQ. (MHz)	EMISSION LEVEL (dBuV/m)	LIMIT (dBuV/m)	MARGIN (dB)	ANTENNA HEIGHT (m)	TABLE ANGLE (Degree)	RAW VALUE (dBuV)	CORRECTION FACTOR (dB/m)
1	#5645.95	68.0 PK	68.2	-0.2	1.00 V	94	63.2	4.8
2	*5775.00	119.0 PK			1.00 V	94	114.0	5.0
3	*5775.00	109.3 AV			1.00 V	94	104.3	5.0
4	#5953.27	67.7 PK	68.2	-0.5	1.00 V	94	62.3	5.4
5	11550.00	47.4 PK	74.0	-26.6	1.49 V	50	33.4	14.0
6	11550.00	34.6 AV	54.0	-19.4	1.49 V	50	20.6	14.0
7	#17325.00	52.3 PK	74.0	-21.7	1.52 V	73	33.7	18.6
8	#17325.00	39.9 AV	54.0	-14.1	1.52 V	73	21.3	18.6

REMARKS:

1. Emission Level(dBuV/m) = Raw Value(dBuV) + Correction Factor(dB/m)
2. Correction Factor(dB/m) = Antenna Factor(dB/m) + Cable Factor(dB) – Pre-Amplifier Factor(dB)
3. The other emission levels were very low against the limit.
4. Margin value = Emission Level – Limit value
5. " * ": Fundamental frequency.
6. " # ": The radiated frequency is out of the restricted band.

Below 1GHz Data:

802.11n (HT40)

CHANNEL	TX Channel 151	DETECTOR FUNCTION	Quasi-Peak (QP)
FREQUENCY RANGE	9kHz ~ 1GHz		

ANTENNA POLARITY & TEST DISTANCE: HORIZONTAL AT 3 M

NO.	FREQ. (MHz)	EMISSION LEVEL (dBuV/m)	LIMIT (dBuV/m)	MARGIN (dB)	ANTENNA HEIGHT (m)	TABLE ANGLE (Degree)	RAW VALUE (dBuV)	CORRECTION FACTOR (dB/m)
1	77.24	36.2 QP	40.0	-3.8	2.49 H	105	53.2	-17.0
2	155.48	36.8 QP	43.5	-6.7	1.98 H	87	49.8	-13.0
3	235.46	37.9 QP	46.0	-8.1	1.55 H	32	53.1	-15.2
4	357.55	40.4 QP	46.0	-5.6	1.00 H	115	51.8	-11.4
5	551.80	39.8 QP	46.0	-6.2	1.48 H	36	46.9	-7.1
6	737.12	40.7 QP	46.0	-5.3	1.00 H	89	43.8	-3.1

ANTENNA POLARITY & TEST DISTANCE: VERTICAL AT 3 M

NO.	FREQ. (MHz)	EMISSION LEVEL (dBuV/m)	LIMIT (dBuV/m)	MARGIN (dB)	ANTENNA HEIGHT (m)	TABLE ANGLE (Degree)	RAW VALUE (dBuV)	CORRECTION FACTOR (dB/m)
1	77.40	35.2 QP	40.0	-4.8	1.98 V	355	52.3	-17.1
2	155.56	38.9 QP	43.5	-4.6	1.00 V	105	51.9	-13.0
3	360.10	37.4 QP	46.0	-8.6	1.00 V	265	48.6	-11.2
4	553.20	36.4 QP	46.0	-9.6	1.50 V	305	43.4	-7.0
5	625.00	35.3 QP	46.0	-10.7	1.55 V	341	40.5	-5.2
6	860.12	38.5 QP	46.0	-7.5	1.00 V	205	40.2	-1.7

REMARKS:

1. Emission Level(dBuV/m) = Raw Value(dBuV) + Correction Factor(dB/m)
2. Correction Factor(dB/m) = Antenna Factor(dB/m) + Cable Factor(dB) – Pre-Amplifier Factor(dB)
3. The other emission levels were very low against the limit.
4. Margin value = Emission Level – Limit value

4.1.8 Test Results (Mode 2)

Below 1GHz Data:

802.11n (HT40)

CHANNEL	TX Channel 151	DETECTOR FUNCTION	Quasi-Peak (QP)
FREQUENCY RANGE	9kHz ~ 1GHz		

ANTENNA POLARITY & TEST DISTANCE: HORIZONTAL AT 3 M

NO.	FREQ. (MHz)	EMISSION LEVEL (dBuV/m)	LIMIT (dBuV/m)	MARGIN (dB)	ANTENNA HEIGHT (m)	TABLE ANGLE (Degree)	RAW VALUE (dBuV)	CORRECTION FACTOR (dB/m)
1	48.48	29.9 QP	40.0	-10.1	3.00 H	290	37.7	-7.8
2	99.77	34.1 QP	43.5	-9.4	3.00 H	275	46.9	-12.8
3	292.17	34.2 QP	46.0	-11.8	1.00 H	36	42.1	-7.9
4	371.03	30.1 QP	46.0	-15.9	1.00 H	252	35.9	-5.8
5	548.73	33.7 QP	46.0	-12.3	2.00 H	360	35.7	-2.0
6	773.34	32.1 QP	46.0	-13.9	1.00 H	80	29.8	2.3

ANTENNA POLARITY & TEST DISTANCE: VERTICAL AT 3 M

NO.	FREQ. (MHz)	EMISSION LEVEL (dBuV/m)	LIMIT (dBuV/m)	MARGIN (dB)	ANTENNA HEIGHT (m)	TABLE ANGLE (Degree)	RAW VALUE (dBuV)	CORRECTION FACTOR (dB/m)
1	37.99	37.0 QP	40.0	-3.0	1.00 V	360	45.3	-8.3
2	84.85	33.0 QP	40.0	-7.0	2.00 V	1	46.8	-13.8
3	375.03	34.8 QP	46.0	-11.2	1.00 V	350	40.6	-5.8
4	515.29	30.9 QP	46.0	-15.1	2.00 V	0	33.2	-2.3
5	537.75	33.0 QP	46.0	-13.0	1.00 V	24	35.2	-2.2
6	788.44	28.2 QP	46.0	-17.8	3.00 V	11	25.8	2.4

REMARKS:

1. Emission Level(dBuV/m) = Raw Value(dBuV) + Correction Factor(dB/m)
2. Correction Factor(dB/m) = Antenna Factor(dB/m) + Cable Factor(dB) – Pre-Amplifier Factor(dB)
3. The other emission levels were very low against the limit.
4. Margin value = Emission Level – Limit value

4.2 Conducted Emission Measurement

4.2.1 Limits of Conducted Emission Measurement

Frequency (MHz)	Conducted Limit (dBuV)	
	Quasi-peak	Average
0.15 - 0.5	66 - 56	56 - 46
0.50 - 5.0	56	46
5.0 - 30.0	60	50

Note: 1. The lower limit shall apply at the transition frequencies.

2. The limit decreases in line with the logarithm of the frequency in the range of 0.15 to 0.50MHz.

4.2.2 Test Instruments

DESCRIPTION & MANUFACTURER	MODEL NO.	SERIAL NO.	CALIBRATED DATE	CALIBRATED UNTIL
Test Receiver R&S	ESCS 30	847124/029	Oct. 24, 2016	Oct. 23, 2017
Line-Impedance Stabilization Network (for EUT) R&S	ESH3-Z5	848773/004	Oct. 26, 2016	Oct. 25, 2017
Line-Impedance Stabilization Network (for Peripheral) R&S	ENV216	100072	June 03, 2017	June 02, 2018
50 ohms Terminator	N/A	EMC-02	Sep. 29, 2016	Sep. 28, 2017
RF Cable	5D-FB	COCCAB-001	Sep. 30, 2016	Sep. 29, 2017
10 dB PAD Mini-Circuits	HAT-10+	CONATT-004	June 18, 2017	June 17, 2018
Software BVADT	BVADT_Cond_ V7.3.7.4	NA	NA	NA

Note:

1. The calibration interval of the above test instruments are 12 months and the calibrations are traceable to NML/ROC and NIST/USA.
2. The test was performed in Shielded Room No. 1.
3. Tested Date: July 07, 2017

4.2.3 Test Procedure

- The EUT was placed 0.4 meters from the conducting wall of the shielded room with EUT being connected to the power mains through a line impedance stabilization network (LISN). Other support units were connected to the power mains through another LISN. The two LISNs provide 50 ohm/ 50uH of coupling impedance for the measuring instrument.
- Both lines of the power mains connected to the EUT were checked for maximum conducted interference.
- The frequency range from 150kHz to 30MHz was searched. Emission levels under (Limit - 20dB) was not recorded.

NOTE: All modes of operation were investigated and the worst-case emissions are reported.

4.2.4 Deviation from Test Standard

No deviation.

4.2.5 Test Setup

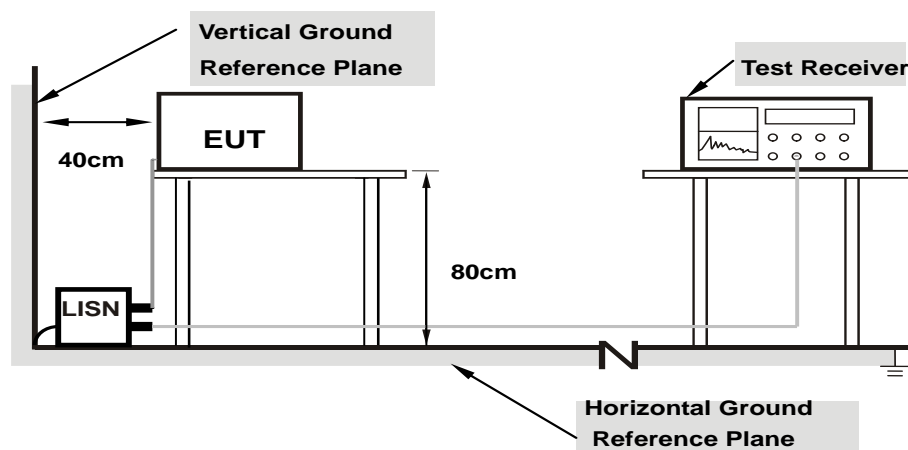

Note: 1.Support units were connected to second LISN.

For the actual test configuration, please refer to the attached file (Test Setup Photo).

4.2.6 EUT Operating Condition

Same as 4.1.6.

4.2.7 Test Results

Phase	Line (L)	Detector Function	Quasi-Peak (QP) / Average (AV)
-------	----------	-------------------	--------------------------------

No	Freq. [MHz]	Corr.	Reading Value		Emission Level		Limit		Margin	
		Factor	[dB (uV)]		[dB (uV)]		[dB (uV)]		(dB)	
	(dB)	Q.P.	AV.	Q.P.	AV.	Q.P.	AV.	Q.P.	AV.	
1	0.46250	10.11	42.21	33.66	52.32	43.77	56.65	46.65	-4.33	-2.88
2	0.75750	10.13	40.00	34.45	50.13	44.58	56.00	46.00	-5.87	-1.42
3	0.94688	10.14	39.27	31.58	49.41	41.72	56.00	46.00	-6.59	-4.28
4	1.07422	10.14	40.09	28.54	50.23	38.68	56.00	46.00	-5.77	-7.32
5	1.39063	10.14	38.72	29.82	48.86	39.96	56.00	46.00	-7.14	-6.04
6	1.69531	10.14	35.98	23.42	46.12	33.56	56.00	46.00	-9.88	-12.44
7	2.01953	10.14	34.94	27.91	45.08	38.05	56.00	46.00	-10.92	-7.95
8	2.30859	10.16	31.63	22.51	41.79	32.67	56.00	46.00	-14.21	-13.33

REMARKS:

1. Q.P. and AV. are abbreviations of quasi-peak and average individually.
2. The emission levels of other frequencies were very low against the limit.
3. Margin value = Emission level - Limit value
4. Correction factor = Insertion loss + Cable loss
5. Emission Level = Correction Factor + Reading Value.

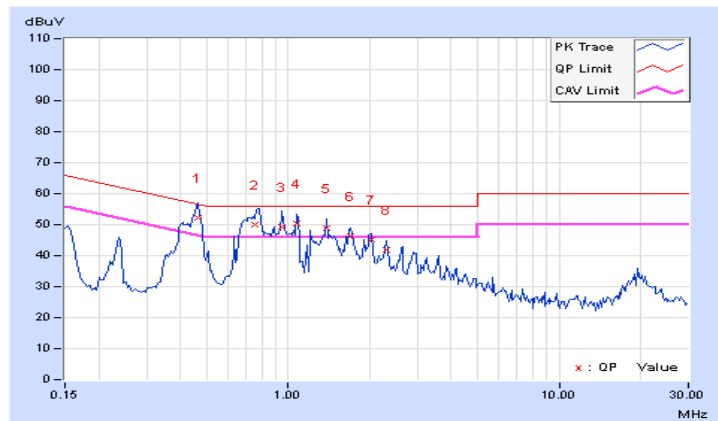

Phase	Neutral (N)	Detector Function	Quasi-Peak (QP) / Average (AV)
-------	-------------	-------------------	-----------------------------------

No	Freq. [MHz]	Corr.	Reading Value		Emission Level		Limit		Margin	
		Factor	[dB (uV)]		[dB (uV)]		[dB (uV)]		(dB)	
		(dB)	Q.P.	AV.	Q.P.	AV.	Q.P.	AV.	Q.P.	AV.
1	0.47275	10.10	41.81	34.87	51.91	44.97	56.47	46.47	-4.56	-1.50
2	0.76050	10.11	40.34	32.69	50.45	42.80	56.00	46.00	-5.55	-3.20
3	0.94822	10.11	39.73	31.67	49.84	41.78	56.00	46.00	-6.16	-4.22
4	1.07031	10.11	39.40	28.13	49.51	38.24	56.00	46.00	-6.49	-7.76
5	1.22266	10.13	34.45	23.95	44.58	34.08	56.00	46.00	-11.42	-11.92
6	1.38672	10.14	41.21	32.77	51.35	42.91	56.00	46.00	-4.65	-3.09
7	1.67969	10.16	39.28	19.34	49.44	29.50	56.00	46.00	-6.56	-16.50
8	2.02162	10.18	32.54	27.26	42.72	37.44	56.00	46.00	-13.28	-8.56

REMARKS:

1. Q.P. and AV. are abbreviations of quasi-peak and average individually.
2. The emission levels of other frequencies were very low against the limit.
3. Margin value = Emission level - Limit value
4. Correction factor = Insertion loss + Cable loss
5. Emission Level = Correction Factor + Reading Value.

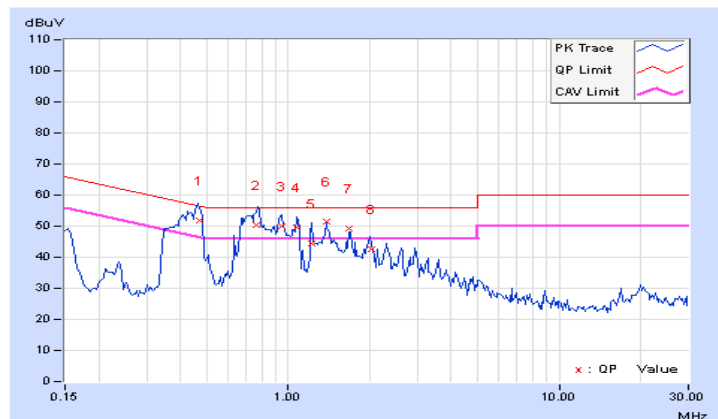

4.3 Transmit Power Measurement

4.3.1 Limits of Transmit Power Measurement

Operation Band	EUT Category		Limit
U-NII-1		Outdoor Access Point	1 Watt (30 dBm) (Max. e.i.r.p \leq 125mW(21 dBm) at any elevation angle above 30 degrees as measured from the horizon)
		Fixed point-to-point Access Point	1 Watt (30 dBm)
	√	Indoor Access Point	1 Watt (30 dBm)
		Mobile and Portable client device	250mW (24 dBm)
U-NII-2A			250mW (24 dBm) or 11 dBm+10 log B*
U-NII-2C			250mW (24 dBm) or 11 dBm+10 log B*
U-NII-3		√	1 Watt (30 dBm)

*B is the 26 dB emission bandwidth in megahertz

Per KDB 662911 Method of conducted output power measurement on IEEE 802.11 devices,

Array Gain = 0 dB (i.e., no array gain) for $N_{ANT} \leq 4$;

Array Gain = 0 dB (i.e., no array gain) for channel widths ≥ 40 MHz for any N_{ANT} ;

Array Gain = $5 \log(N_{ANT}/N_{SS})$ dB or 3 dB, whichever is less for 20-MHz channel widths with $N_{ANT} \geq 5$.

For power measurements on all other devices: Array Gain = $10 \log(N_{ANT}/N_{SS})$ dB.

4.3.2 Test Setup

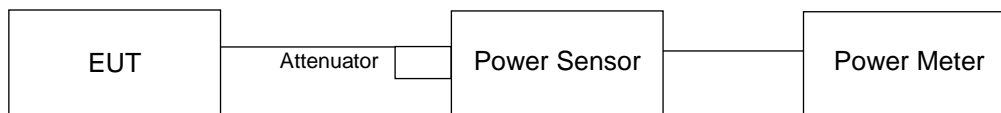

4.3.3 Test Instruments

Refer to section 4.1.2 to get information of above instrument.

4.3.4 Test Procedure

Method PM is used to perform output power measurement, trigger and gating function of wide band power meter is enabled to measure max output power of TX on burst. Duty factor is not added to measured value.

4.3.5 Deviation from Test Standard

No deviation.

4.3.6 EUT Operating Condition

The software provided by client to enable the EUT under transmission condition continuously at lowest, middle and highest channel frequencies individually.

4.3.7 Test Result

CDD Mode
802.11a

Chan.	Chan. Freq. (MHz)	Maximum Conducted Power (dBm)				Total Power (mW)	Total Power (dBm)	Limit (dBm)	Pass / Fail
		Chain 0	Chain 1	Chain 2	Chain 3				
36	5180	21.16	20.97	20.89	20.02	478.849	26.80	30.00	Pass
40	5200	21.98	21.91	21.68	20.83	581.291	27.64	30.00	Pass
48	5240	22.04	21.89	21.61	20.52	572.078	27.57	30.00	Pass
149	5745	24.73	24.20	23.57	23.15	994.242	29.97	30.00	Pass
157	5785	24.58	23.86	23.49	23.03	954.564	29.80	30.00	Pass
165	5825	24.42	23.75	23.37	23.42	950.887	29.78	30.00	Pass

802.11ac (VHT20)

Chan.	Chan. Freq. (MHz)	Maximum Conducted Power (dBm)				Total Power (mW)	Total Power (dBm)	Limit (dBm)	Pass / Fail
		Chain 0	Chain 1	Chain 2	Chain 3				
36	5180	21.06	20.75	20.42	19.82	452.588	26.56	30.00	Pass
40	5200	22.02	21.79	21.44	20.64	565.423	27.52	30.00	Pass
48	5240	22.11	21.71	21.48	20.55	564.913	27.52	30.00	Pass
149	5745	24.60	24.15	23.56	23.16	982.419	29.92	30.00	Pass
157	5785	24.53	23.98	23.54	23.15	966.309	29.85	30.00	Pass
165	5825	24.41	23.64	23.42	23.36	943.82	29.75	30.00	Pass

802.11ac (VHT40)

Chan.	Chan. Freq. (MHz)	Maximum Conducted Power (dBm)				Total Power (mW)	Total Power (dBm)	Limit (dBm)	Pass / Fail
		Chain 0	Chain 1	Chain 2	Chain 3				
38	5190	18.01	18.55	17.72	18.08	258.28	24.12	30.00	Pass
46	5230	23.48	23.80	23.47	22.03	844.646	29.27	30.00	Pass
151	5755	24.20	24.69	23.71	23.07	995.2	29.98	30.00	Pass
159	5795	24.14	24.40	23.46	23.60	985.748	29.94	30.00	Pass

802.11ac (VHT80)

Chan.	Chan. Freq. (MHz)	Maximum Conducted Power (dBm)				Total Power (mW)	Total Power (dBm)	Limit (dBm)	Pass / Fail
		Chain 0	Chain 1	Chain 2	Chain 3				
42	5210	18.53	18.41	17.65	18.22	265.212	24.24	30.00	Pass
155	5775	23.92	23.74	23.51	23.68	940.93	29.74	30.00	Pass

Beamforming Mode
802.11ac (VHT20)

Chan.	Chan. Freq. (MHz)	Maximum Conducted Power (dBm)				Total Power (mW)	Total Power (dBm)	Limit (dBm)	Pass / Fail
		Chain 0	Chain 1	Chain 2	Chain 3				
36	5180	20.89	20.59	20.49	19.75	443.645	26.47	27.22	Pass
40	5200	21.68	21.62	20.70	20.60	524.747	27.20	27.22	Pass
48	5240	21.77	21.60	20.67	20.58	525.827	27.21	27.22	Pass
149	5745	21.67	21.55	20.96	19.55	504.677	27.03	27.11	Pass
157	5785	21.62	21.44	20.79	19.40	491.573	26.92	27.11	Pass
165	5825	21.56	21.52	20.59	19.48	488.392	26.89	27.11	Pass

- Note:** 1. For UNII-1: Directional gain = $10 \log[(10^{G1/20} + 10^{G2/20} + 10^{G3/20} + 10^{G4/20})^2 / 4] = 8.78\text{dBi} > 6\text{dBi}$, so the power limit shall be reduced to $30 - (8.78 - 6) = 27.22\text{dBm}$.
2. For UNII-3: Directional gain = $10 \log[(10^{G1/20} + 10^{G2/20} + 10^{G3/20} + 10^{G4/20})^2 / 4] = 8.89\text{dBi} > 6\text{dBi}$, so the power limit shall be reduced to $30 - (8.89 - 6) = 27.11\text{dBm}$.

802.11ac (VHT40)

Chan.	Chan. Freq. (MHz)	Maximum Conducted Power (dBm)				Total Power (mW)	Total Power (dBm)	Limit (dBm)	Pass / Fail
		Chain 0	Chain 1	Chain 2	Chain 3				
38	5190	17.98	18.52	17.67	18.01	255.647	24.08	27.22	Pass
46	5230	21.58	21.62	21.03	20.31	523.255	27.19	27.22	Pass
151	5755	21.40	21.66	20.82	19.91	503.323	27.02	27.11	Pass
159	5795	21.30	21.54	20.80	19.82	493.623	26.93	27.11	Pass

- Note:** 1. For UNII-1: Directional gain = $10 \log[(10^{G1/20} + 10^{G2/20} + 10^{G3/20} + 10^{G4/20})^2 / 4] = 8.78\text{dBi} > 6\text{dBi}$, so the power limit shall be reduced to $30 - (8.78 - 6) = 27.22\text{dBm}$.
2. For UNII-3: Directional gain = $10 \log[(10^{G1/20} + 10^{G2/20} + 10^{G3/20} + 10^{G4/20})^2 / 4] = 8.89\text{dBi} > 6\text{dBi}$, so the power limit shall be reduced to $30 - (8.89 - 6) = 27.11\text{dBm}$.

802.11ac (VHT80)

Chan.	Chan. Freq. (MHz)	Maximum Conducted Power (dBm)				Total Power (mW)	Total Power (dBm)	Limit (dBm)	Pass / Fail
		Chain 0	Chain 1	Chain 2	Chain 3				
42	5210	18.21	18.33	17.43	18.03	253.167	24.03	27.22	Pass
155	5775	21.40	21.25	20.78	20.00	491.064	26.91	27.11	Pass

- Note:** 1. For UNII-1: Directional gain = $10 \log[(10^{G1/20} + 10^{G2/20} + 10^{G3/20} + 10^{G4/20})^2 / 4] = 8.78\text{dBi} > 6\text{dBi}$, so the power limit shall be reduced to $30 - (8.78 - 6) = 27.22\text{dBm}$.
2. For UNII-3: Directional gain = $10 \log[(10^{G1/20} + 10^{G2/20} + 10^{G3/20} + 10^{G4/20})^2 / 4] = 8.89\text{dBi} > 6\text{dBi}$, so the power limit shall be reduced to $30 - (8.89 - 6) = 27.11\text{dBm}$.

4.4 Occupied Bandwidth Measurement

4.4.1 Test Setup



4.4.2 Test Instruments

Refer to section 4.1.2 to get information of above instrument.

4.4.3 Test Procedure

The transmitter output was connected to the spectrum analyzer through an attenuator. The bandwidth of the fundamental frequency was measured by spectrum analyzer with resolution bandwidth in the range of 1% to 5% of the anticipated emission bandwidth, and a video bandwidth at least 3x the resolution bandwidth and set the detector to SAMPLE. The width of a frequency band such that, below the lower and above the upper frequency limits, the mean powers emitted are each equal to a specified percentage 0.5 %of the total mean power of a given emission.

4.4.4 Test Results

802.11a

Channel	Channel Frequency (MHz)	Occupied Bandwidth (MHz)			
		CHAIN 0	CHAIN 1	CHAIN 2	CHAIN 3
36	5180	16.92	17.04	17.04	16.92
40	5200	16.92	16.92	16.92	16.92
48	5240	16.92	17.04	16.80	16.92
149	5745	17.04	16.92	16.92	16.92
157	5785	16.92	16.68	16.80	16.92
165	5825	17.04	17.04	16.80	16.80

802.11ac (VHT20)

Channel	Channel Frequency (MHz)	Occupied Bandwidth (MHz)			
		CHAIN 0	CHAIN 1	CHAIN 2	CHAIN 3
36	5180	18.12	18.12	18.00	18.12
40	5200	18.12	18.00	17.88	18.00
48	5240	17.88	18.00	18.00	17.88
149	5745	18.12	18.00	18.12	17.88
157	5785	18.00	17.88	17.88	18.00
165	5825	17.88	18.00	18.00	18.12

802.11ac (VHT40)

Channel	Channel Frequency (MHz)	Occupied Bandwidth (MHz)			
		CHAIN 0	CHAIN 1	CHAIN 2	CHAIN 3
38	5190	36.72	36.72	36.72	36.72
46	5230	36.72	36.72	36.72	36.96
151	5755	36.72	36.72	36.72	36.72
159	5795	36.96	36.72	36.72	36.72

802.11ac (VHT80)

Channel	Channel Frequency (MHz)	Occupied Bandwidth (MHz)			
		CHAIN 0	CHAIN 1	CHAIN 2	CHAIN 3
42	5210	74.88	74.88	75.36	75.36
155	5775	75.84	76.32	76.32	76.32

Spectrum Plot of Worst Value

802.11a_Chain 0 / CH165

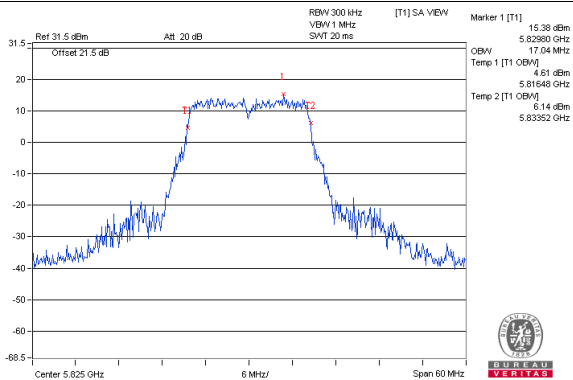

802.11ac (VHT20)_Chain 0 / CH36

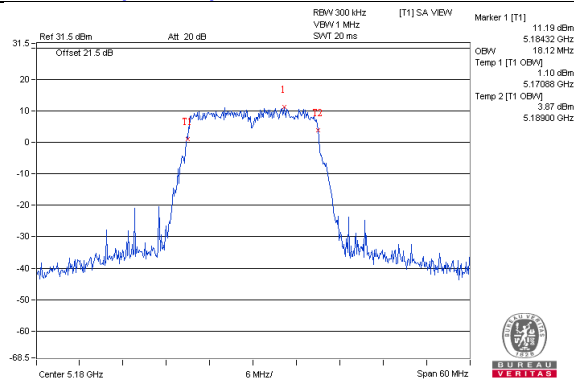

802.11ac (VHT40)_Chain 0 / CH159

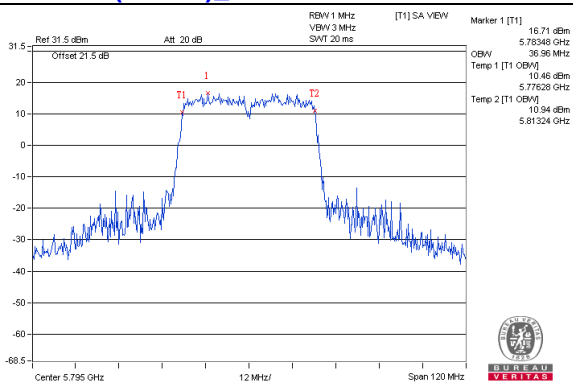

802.11ac (VHT80)_Chain 1 / CH155

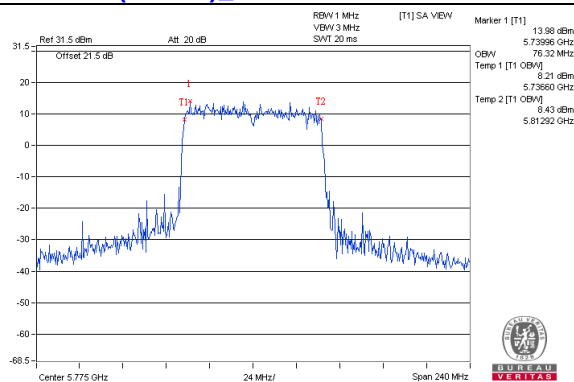

Spectrum Plot for near by DFS band (DFS is required, if 99% OCP straddle into U-NII-2A band)

802.11a_Chain0 / CH48

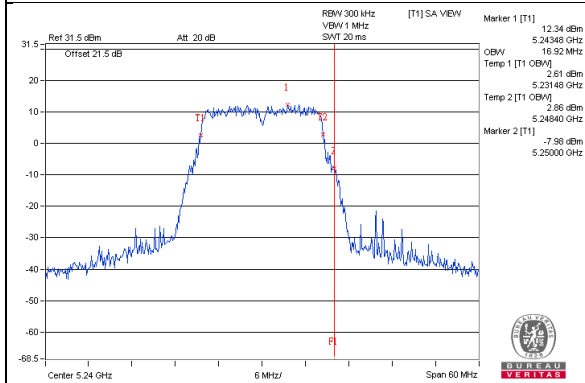

802.11a_Chain1 / CH48

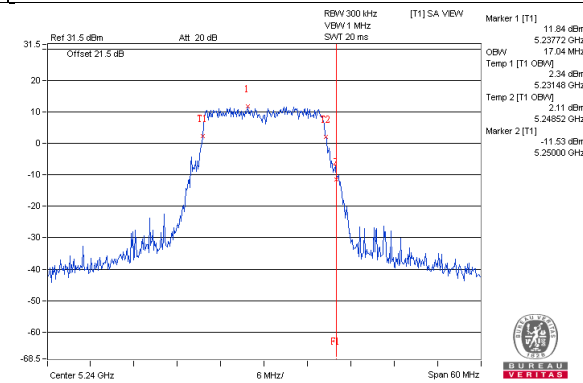

802.11a_Chain2 / CH48

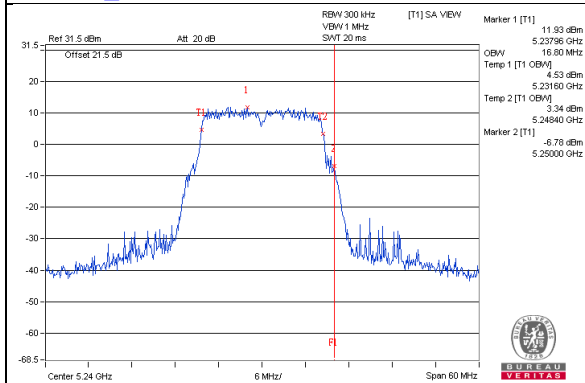

802.11a_Chain3 / CH48

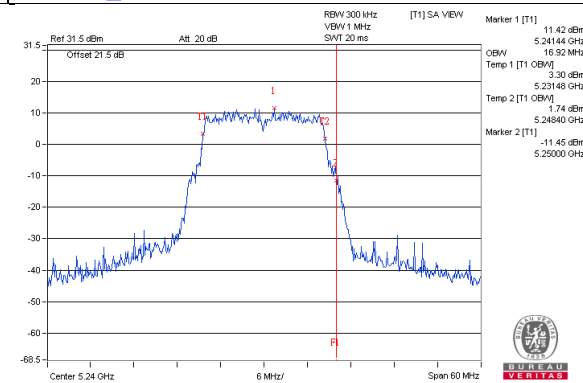

802.11ac(VHT20)_Chain0 / CH48

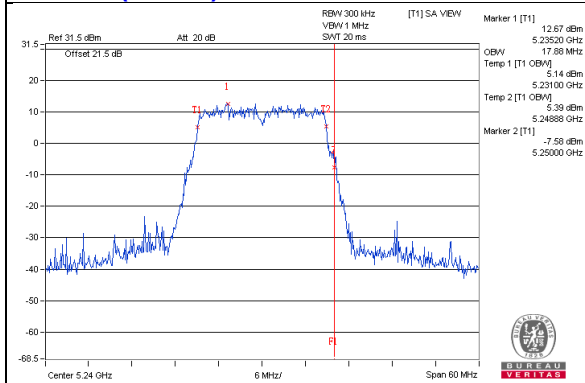

802.11ac(VHT20)_Chain1 / CH48

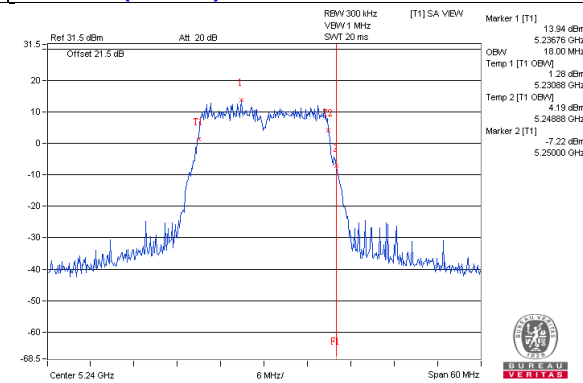

802.11ac(VHT20)_Chain2 / CH48

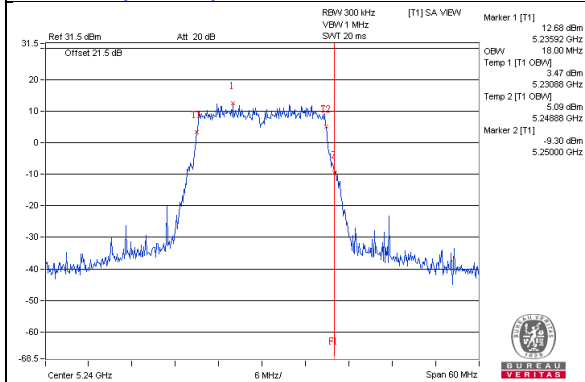

802.11ac(VHT20)_Chain3 / CH48

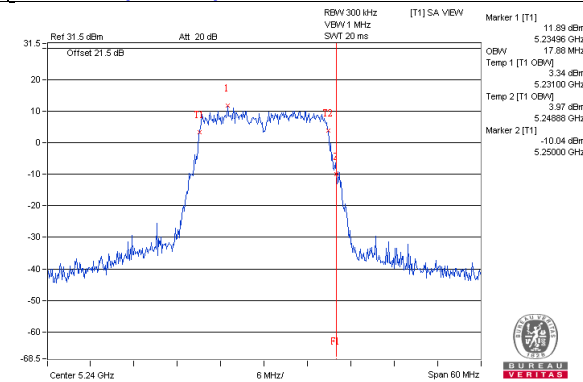

802.11ac(VHT40)_Chain0 / CH46

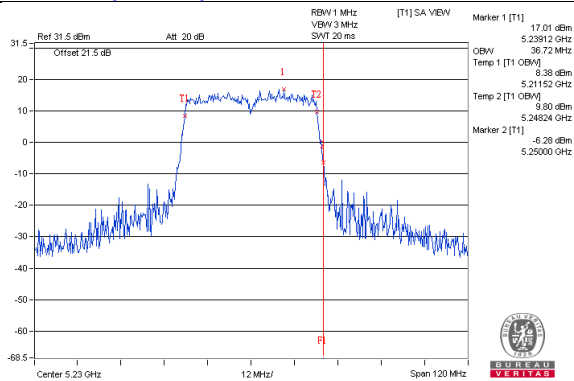

802.11ac(VHT40)_Chain1 / CH46

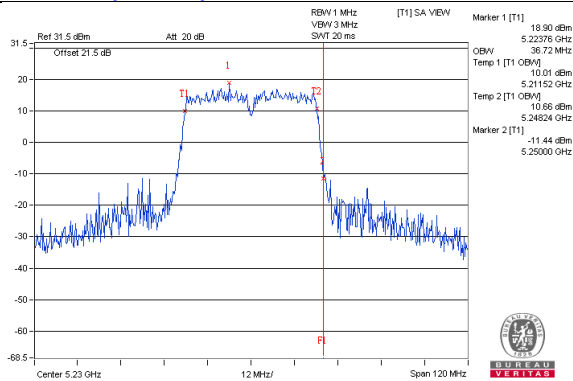

802.11ac(VHT40)_Chain2 / CH46

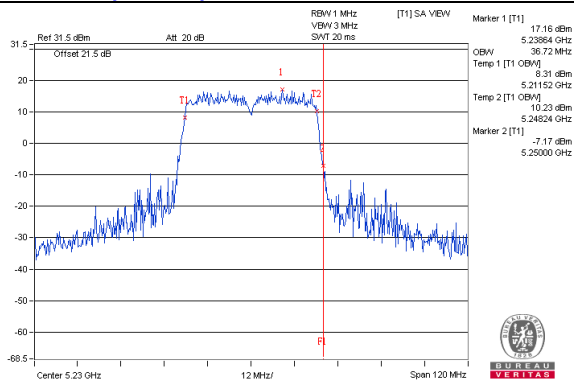

802.11ac(VHT40)_Chain3 / CH46

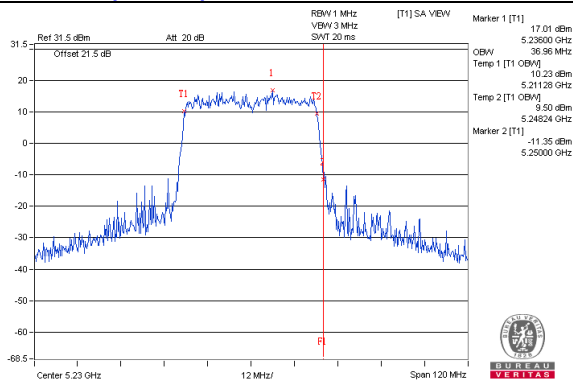

802.11ac(VHT80)_Chain0 / CH42

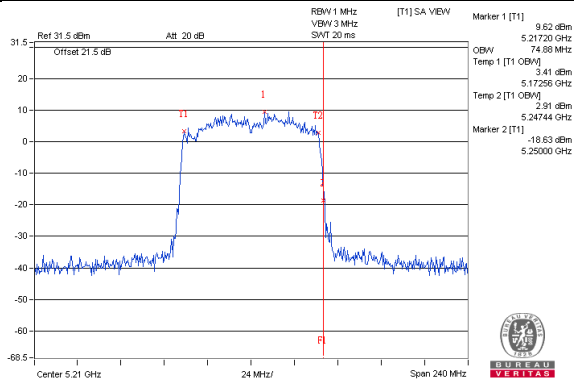

802.11ac(VHT80)_Chain1 / CH42

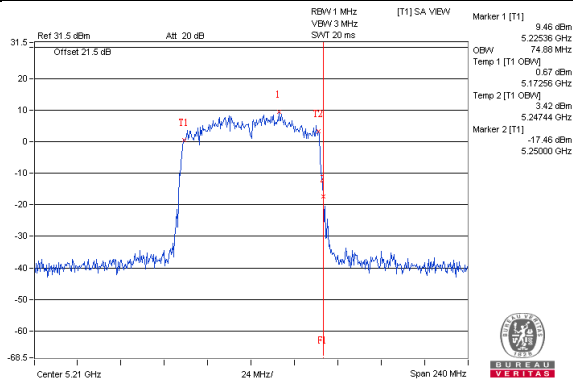

802.11ac(VHT80)_Chain2 / CH42

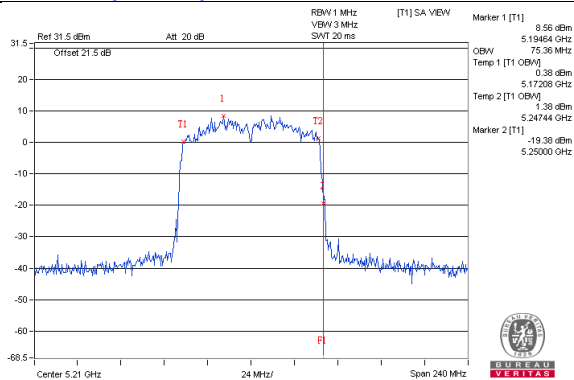

802.11ac(VHT80)_Chain3 / CH42

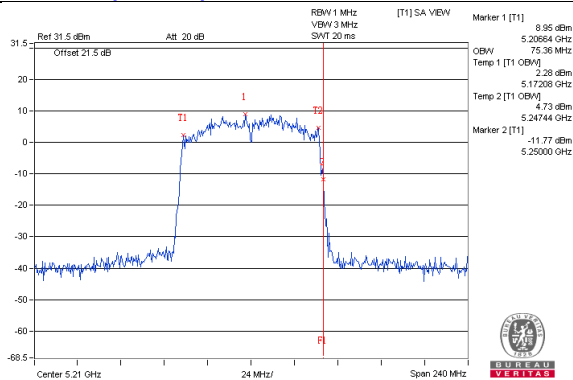

**Spectrum Plot for near by DFS band
(DFS is required, if 99% OCP straddle into U-NII-2C band)**

802.11a_Chain0 / CH149

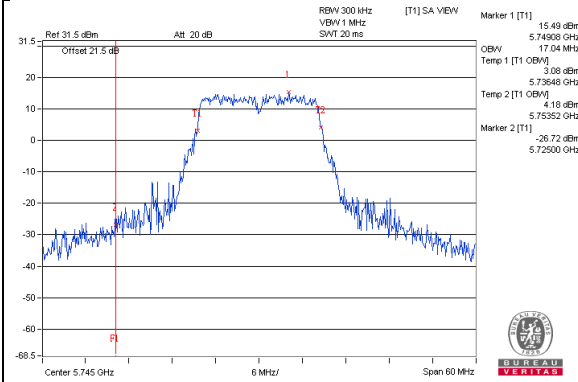

802.11a_Chain1 / CH149

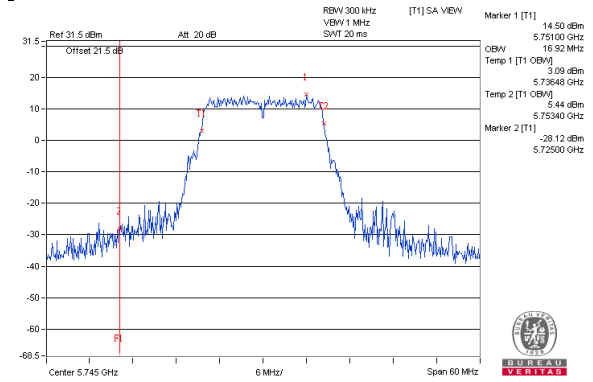

802.11a_Chain2 / CH149

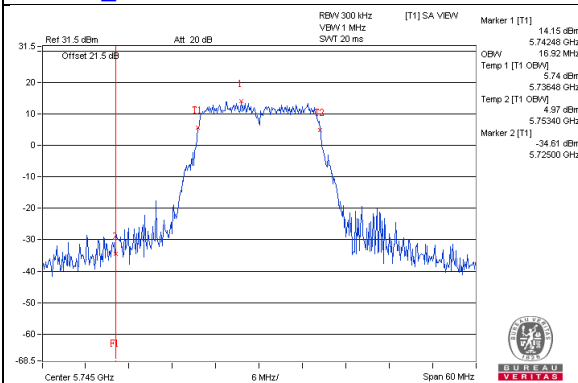

802.11a_Chain3 / CH149

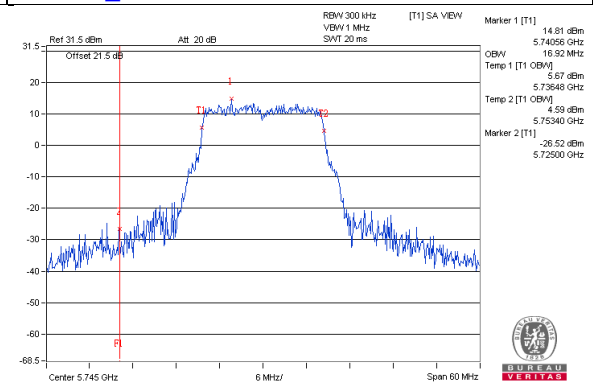

802.11ac(VHT20)_Chain0 / CH149

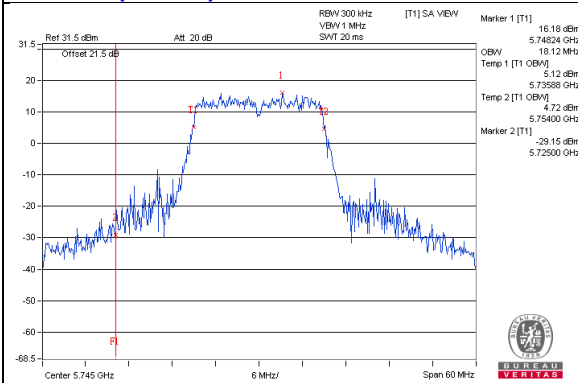

802.11ac(VHT20)_Chain1 / CH149

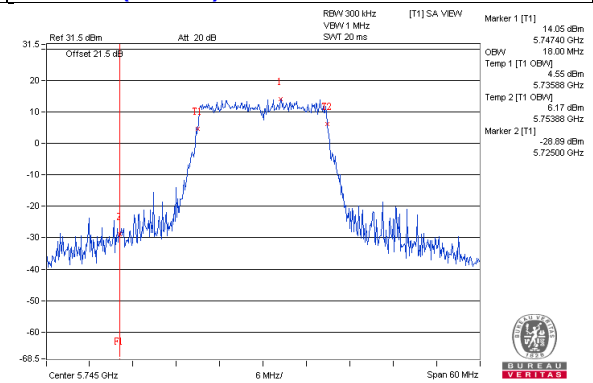

802.11ac(VHT20)_Chain2 / CH149

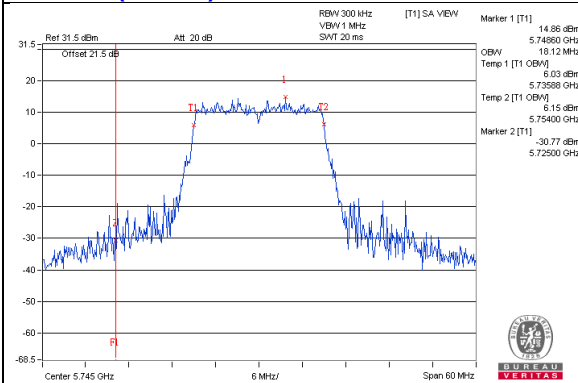

802.11ac(VHT20)_Chain3 / CH149

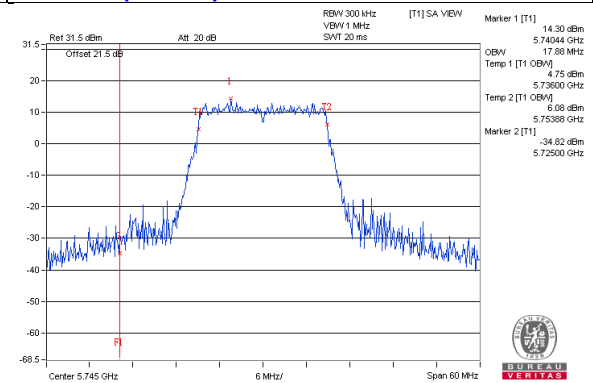

802.11ac(VHT40)_Chain0 / CH151

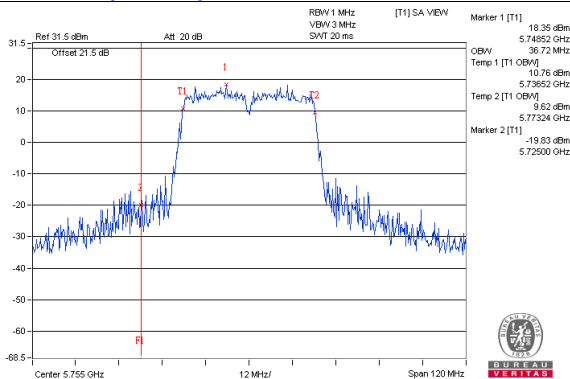

802.11ac(VHT40)_Chain1 / CH151

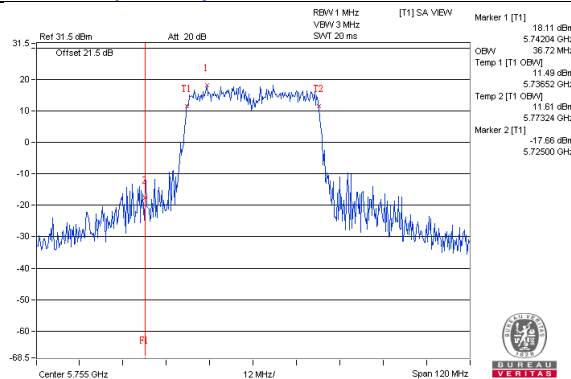

802.11ac(VHT40)_Chain2 / CH151

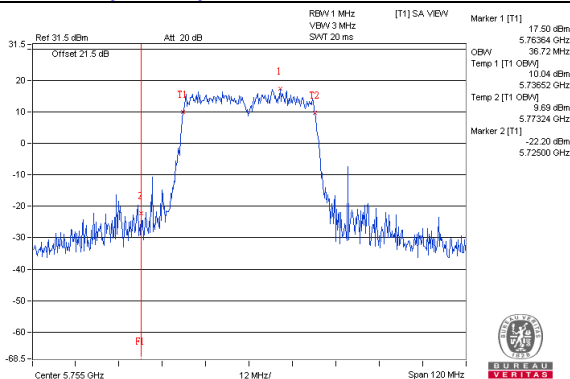

802.11ac(VHT40)_Chain3 / CH151

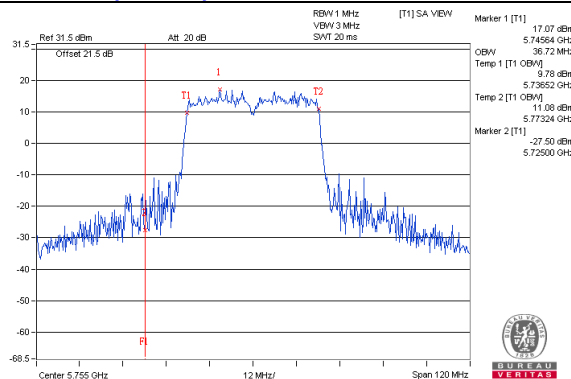

802.11ac(VHT80)_Chain0 / CH155

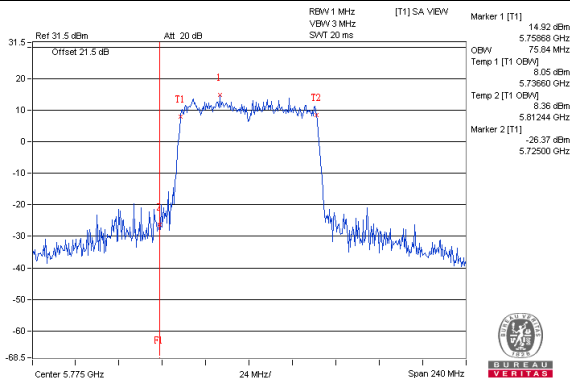

802.11ac(VHT80)_Chain1 / CH155

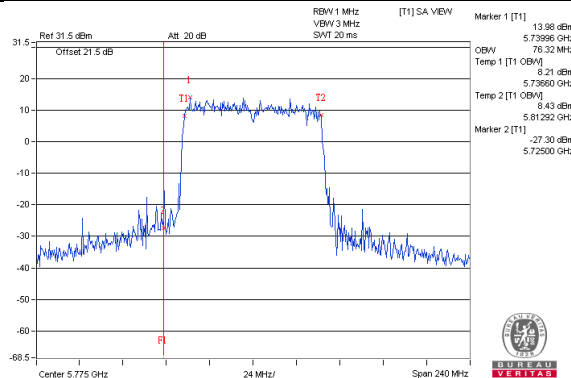

802.11ac(VHT80)_Chain2 / CH155

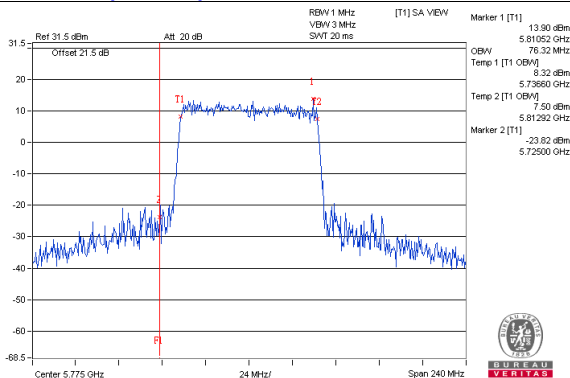

802.11ac(VHT80)_Chain3 / CH155

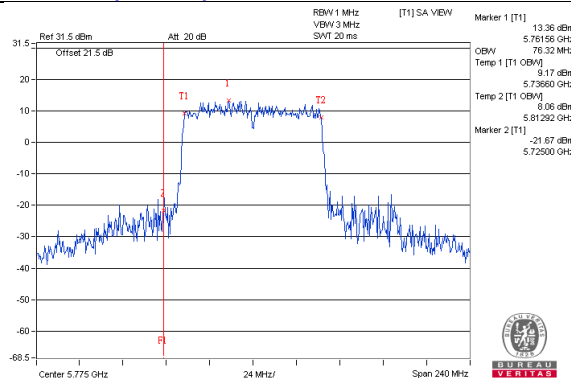

4.5 Peak Power Spectral Density Measurement

4.5.1 Limits of Peak Power Spectral Density Measurement

Operation Band	EUT Category		Limit
U-NII-1		Outdoor Access Point	17dBm/ MHz
		Fixed point-to-point Access Point	
	√	Indoor Access Point	
		Mobile and Portable client device	11dBm/ MHz
U-NII-2A			11dBm/ MHz
U-NII-2C			11dBm/ MHz
U-NII-3	√		30dBm/ 500kHz

4.5.2 Test Setup

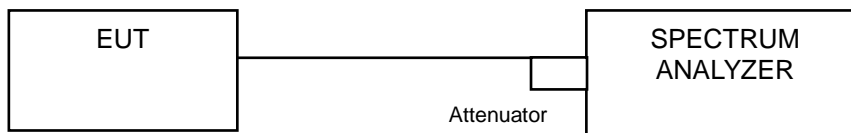

4.5.3 Test Instruments

Refer to section 4.1.2 to get information of above instrument.

4.5.4 Test Procedure

802.11a, 802.11ac (VHT20), 802.11ac (VHT40)

For U-NII-1 band:

Using method SA-1

1. Set span to encompass the entire emission bandwidth (EBW) of the signal.
2. Set RBW = 1 MHz, Set VBW \geq 3 MHz, Detector = RMS
3. Sweep time = auto, trigger set to "free run".
4. Trace average at least 100 traces in power averaging mode.
5. Record the max value

For U-NII-3:

1. Set span to encompass the entire emission bandwidth (EBW) of the signal.
2. Set RBW = 300 kHz, Set VBW \geq 1 MHz, Detector = RMS
3. Use the peak marker function to determine the maximum power level in any 300 kHz band segment within the fundamental EBW.
4. Scale the observed power level to an equivalent value in 500 kHz by adjusting (reducing) the measured power by a bandwidth correction factor (BWCF) where $BWCF = 10\log(500 \text{ kHz}/300\text{kHz})$
5. Sweep time = auto, trigger set to "free run".
6. Trace average at least 100 traces in power averaging mode.
7. Record the max value

802.11ac (VHT80)

For U-NII-1 band:

Using method SA-2

1. Set span to encompass the entire emission bandwidth (EBW) of the signal.
2. Set RBW = 1 MHz, Set VBW \geq 3 MHz, Detector = RMS
3. Sweep time = auto, trigger set to "free run".
4. Trace average at least 100 traces in power averaging mode.
5. Record the max value and add $10 \log (1/\text{duty cycle})$

For U-NII-3:

1. Set span to encompass the entire emission bandwidth (EBW) of the signal.
2. Set RBW = 300 kHz, Set VBW \geq 1 MHz, Detector = RMS
3. Use the peak marker function to determine the maximum power level in any 300 kHz band segment within the fundamental EBW.
4. Scale the observed power level to an equivalent value in 500 kHz by adjusting (reducing) the measured power by a bandwidth correction factor (BWCF) where $BWCF = 10\log(500 \text{ kHz}/300\text{kHz})$
5. Sweep time = auto, trigger set to "free run".
6. Trace average at least 100 traces in power averaging mode.
7. Record the max value and add $10 \log (1/\text{duty cycle})$

4.5.5 Deviation from Test Standard

No deviation.

4.5.6 EUT Operating Condition

Same as Item 4.3.6.

4.5.7 Test Results

For U-NII-1:

802.11a

Chan.	Chan. Freq. (MHz)	PSD (dBm/MHz)				Total Power Density (dBm/MHz)	MAX. Limit (dBm/MHz)	Pass / Fail
		Chain 0	Chain 1	Chain 2	Chain 3			
36	5180	7.53	7.51	7.05	6.94	13.29	14.22	Pass
40	5200	8.84	8.53	7.93	7.12	14.17	14.22	Pass
48	5240	8.58	8.46	8.00	6.67	14.01	14.22	Pass

- Note:** 1. Method a) of power density measurement of KDB 662911 is using for calculating total power density. Total power density is summing entire spectra across corresponding frequency bins on the various outputs by computer.
2. Directional gain = $10 \log[(10^{G1/20} + 10^{G2/20} + 10^{G3/20} + 10^{G4/20})^2 / 4] = 8.78\text{dBi} > 6\text{dBi}$, so the power density limit shall be reduced to $17 - (8.78 - 6) = 14.22\text{dBm}$

802.11ac (VHT20)

Chan.	Chan. Freq. (MHz)	PSD (dBm/MHz)				Total Power Density (dBm/MHz)	MAX. Limit (dBm/MHz)	Pass / Fail
		Chain 0	Chain 1	Chain 2	Chain 3			
36	5180	7.27	7.07	6.50	5.74	12.71	14.22	Pass
40	5200	8.80	8.04	7.50	6.62	13.83	14.22	Pass
48	5240	8.50	7.68	7.73	6.50	13.68	14.22	Pass

- Note:** 1. Method a) of power density measurement of KDB 662911 is using for calculating total power density. Total power density is summing entire spectra across corresponding frequency bins on the various outputs by computer.
2. Directional gain = $10 \log[(10^{G1/20} + 10^{G2/20} + 10^{G3/20} + 10^{G4/20})^2 / 4] = 8.78\text{dBi} > 6\text{dBi}$, so the power density limit shall be reduced to $17 - (8.78 - 6) = 14.22\text{dBm}$

802.11ac (VHT40)

Chan.	Chan. Freq. (MHz)	PSD (dBm/MHz)				Total Power Density (dBm/MHz)	MAX. Limit (dBm/MHz)	Pass / Fail
		Chain 0	Chain 1	Chain 2	Chain 3			
38	5190	1.24	1.69	1.02	1.32	7.34	14.22	Pass
46	5230	6.88	6.93	6.28	5.82	12.52	14.22	Pass

- Note:** 1. Method a) of power density measurement of KDB 662911 is using for calculating total power density. Total power density is summing entire spectra across corresponding frequency bins on the various outputs by computer.
2. Directional gain = $10 \log[(10^{G1/20} + 10^{G2/20} + 10^{G3/20} + 10^{G4/20})^2 / 4] = 8.78\text{dBi} > 6\text{dBi}$, so the power density limit shall be reduced to $17 - (8.78 - 6) = 14.22\text{dBm}$

802.11ac (VHT80)

Chan.	Chan. Freq. (MHz)	PSD W/O Duty Factor (dBm/MHz)				Duty Factor (dB)	Total PSD With Duty Factor (dBm/MHz)	MAX. EIRP Limit (dBm/MHz)	Pass / Fail
		Chain 0	Chain 1	Chain	Chain 3				
42	5210	0.00	-0.54	-1.09	-0.85	0.22	5.64	14.22	Pass

- Note:**
- Method a) of power density measurement of KDB 662911 is using for calculating total power density. Total power density is summing entire spectra across corresponding frequency bins on the various outputs by computer.
 - Directional gain = $10 \log[(10^{G1/20} + 10^{G2/20} + 10^{G3/20} + 10^{G4/20})^2 / 4] = 8.78\text{dBi} > 6\text{dBi}$, so the power density limit shall be reduced to $17 - (8.78 - 6) = 14.22\text{dBm}$
 - Refer to section 3.3 for duty cycle spectrum plot.

Spectrum Plot of Worst Value

802.11a_Chain 0 / CH40

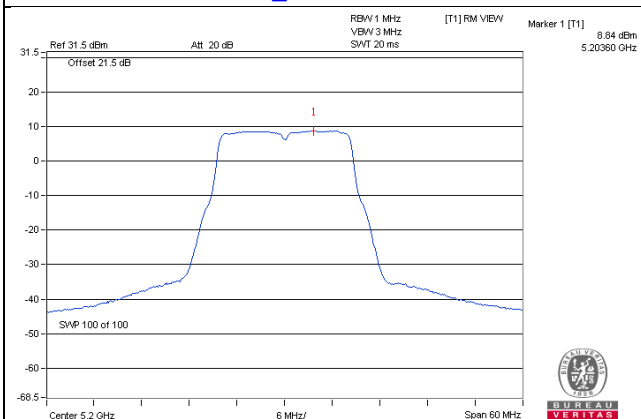

802.11ac (VHT20)_Chain 0 / CH40

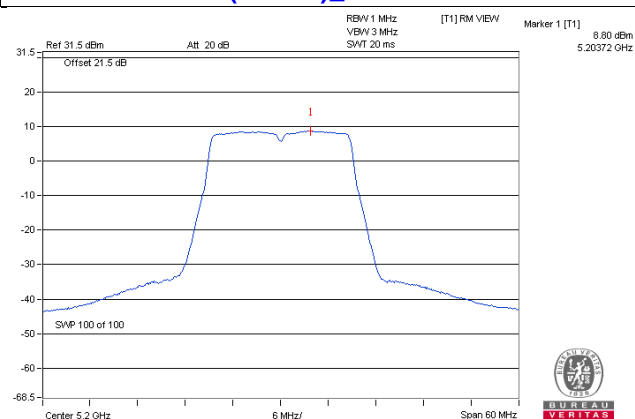

802.11ac (VHT40)_Chain 1 / CH46

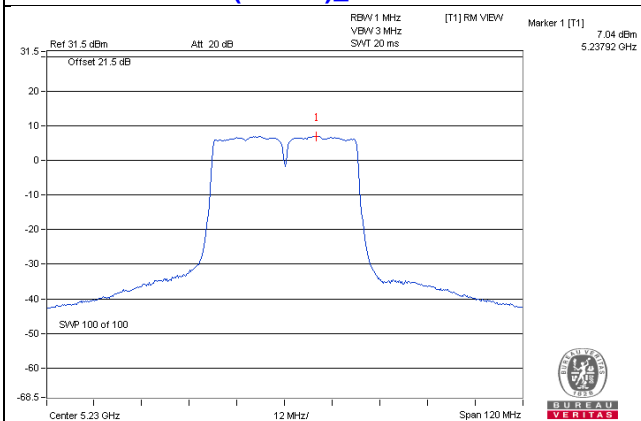

802.11ac (VHT80)_Chain 0 / CH42

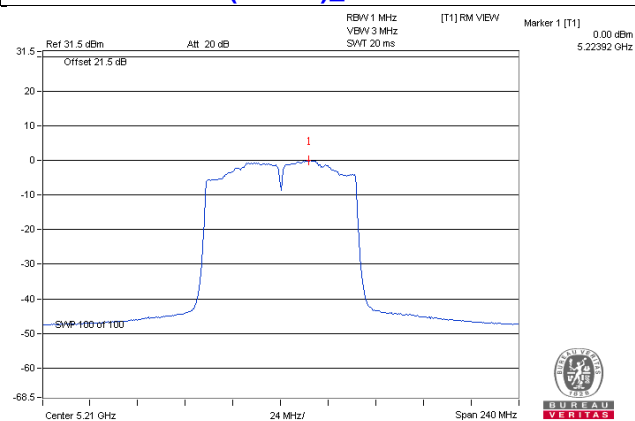

For U-NII-3:

802.11a

TX chain	Channel	Freq. (MHz)	PSD (dBm/300kHz)	PSD (dBm/500kHz)	10 log (N=4) dB	Total PSD (dBm/500kHz)	Limit (dBm/500kHz)	Pass /Fail
0	149	5745	3.06	5.28	6.02	11.30	27.11	Pass
	157	5785	3.09	5.31	6.02	11.33	27.11	Pass
	165	5825	2.38	4.60	6.02	10.62	27.11	Pass
1	149	5745	2.70	4.92	6.02	10.94	27.11	Pass
	157	5785	2.19	4.41	6.02	10.43	27.11	Pass
	165	5825	2.07	4.29	6.02	10.31	27.11	Pass
2	149	5745	2.10	4.32	6.02	10.34	27.11	Pass
	157	5785	1.66	3.88	6.02	9.90	27.11	Pass
	165	5825	1.59	3.81	6.02	9.83	27.11	Pass
3	149	5745	1.62	3.84	6.02	9.86	27.11	Pass
	157	5785	1.42	3.64	6.02	9.66	27.11	Pass
	165	5825	1.29	3.51	6.02	9.53	27.11	Pass

Note: 1. Directional gain = $10 \log[(10^{G1/20} + 10^{G2/20} + 10^{G3/20} + 10^{G4/20})^2 / 4] = 8.89\text{dBi} > 6\text{dBi}$, so the power density limit shall be reduced to $30-(8.89-6) = 27.11\text{dBm}$

802.11ac (VHT20)

TX chain	Channel	Freq. (MHz)	PSD (dBm/300kHz)	PSD (dBm/500kHz)	10 log (N=4) dB	Total PSD (dBm/500kHz)	Limit (dBm/500kHz)	Pass /Fail
0	149	5745	2.99	5.21	6.02	11.23	27.11	Pass
	157	5785	2.46	4.68	6.02	10.70	27.11	Pass
	165	5825	2.05	4.27	6.02	10.29	27.11	Pass
1	149	5745	2.13	4.35	6.02	10.37	27.11	Pass
	157	5785	1.92	4.14	6.02	10.16	27.11	Pass
	165	5825	1.54	3.76	6.02	9.78	27.11	Pass
2	149	5745	1.64	3.86	6.02	9.88	27.11	Pass
	157	5785	1.49	3.71	6.02	9.73	27.11	Pass
	165	5825	1.36	3.58	6.02	9.60	27.11	Pass
3	149	5745	1.11	3.33	6.02	9.35	27.11	Pass
	157	5785	1.43	3.65	6.02	9.67	27.11	Pass
	165	5825	1.28	3.50	6.02	9.52	27.11	Pass

Note: 1. Directional gain = $10 \log[(10^{G1/20} + 10^{G2/20} + 10^{G3/20} + 10^{G4/20})^2 / 4] = 8.89\text{dBi} > 6\text{dBi}$, so the power density limit shall be reduced to $30 - (8.89 - 6) = 27.11\text{dBm}$

802.11ac (VHT40)

TX chain	Channel	Freq. (MHz)	PSD (dBm/300kHz)	PSD (dBm/500kHz)	10 log (N=4) dB	Total PSD (dBm/500kHz)	Limit (dBm/500kHz)	Pass /Fail
0	151	5755	-1.00	1.22	6.02	7.24	27.11	Pass
	159	5795	-1.26	0.96	6.02	6.98	27.11	Pass
1	151	5755	-0.81	1.41	6.02	7.43	27.11	Pass
	159	5795	-1.14	1.08	6.02	7.10	27.11	Pass
2	151	5755	-1.52	0.70	6.02	6.72	27.11	Pass
	159	5795	-2.20	0.02	6.02	6.04	27.11	Pass
3	151	5755	-1.81	0.41	6.02	6.43	27.11	Pass
	159	5795	-2.59	-0.37	6.02	5.65	27.11	Pass

Note: 1. Directional gain = $10 \log[(10^{G1/20} + 10^{G2/20} + 10^{G3/20} + 10^{G4/20})^2 / 4] = 8.89\text{dBi} > 6\text{dBi}$, so the power density limit shall be reduced to $30 - (8.89 - 6) = 27.11\text{dBm}$

802.11ac (VHT80)

TX chain	Chan.	Chan. Freq. (MHz)	PSD W/O Duty Factor		10 log (N=4) dB	Duty Factor (dB)	Total PSD With Duty Factor (dBm/500kHz)	Limit (dBm/500kHz)	Pass /Fail
			(dBm/300kHz)	(dBm/500kHz)					
0	155	5775	-4.44	-2.22	6.02	0.22	4.02	27.11	Pass
1	155	5775	-4.80	-2.58	6.02	0.22	3.66	27.11	Pass
2	155	5775	-4.86	-2.64	6.02	0.22	3.60	27.11	Pass
3	155	5775	-5.25	-3.03	6.02	0.22	3.21	27.11	Pass

Note: 1. Directional gain = $10 \log[(10^{G1/20} + 10^{G2/20} + 10^{G3/20} + 10^{G4/20})^2 / 4] = 8.89\text{dBi} > 6\text{dBi}$, so the power density limit shall be reduced to $30-(8.89-6) = 27.11\text{dBm}$

2. Refer to section 3.3 for duty cycle spectrum plot.

Spectrum Plot of Worst Value

802.11a – Chain 0: CH 157

802.11ac (VHT20) – Chain 0: CH 149

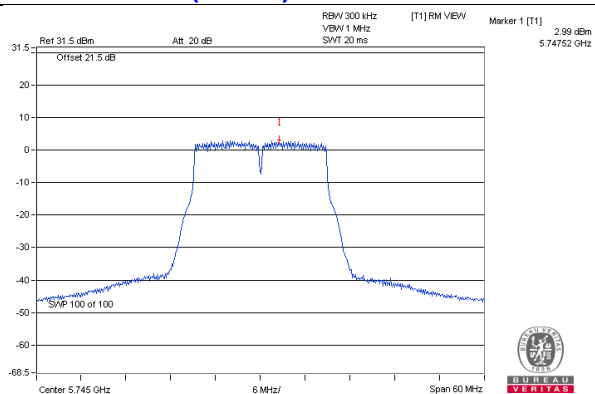
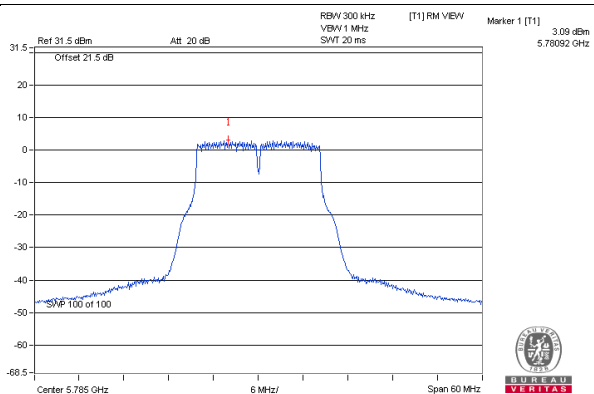

802.11ac (VHT40) – Chain 1: CH 151

802.11ac (VHT80) – Chain 0: CH 155

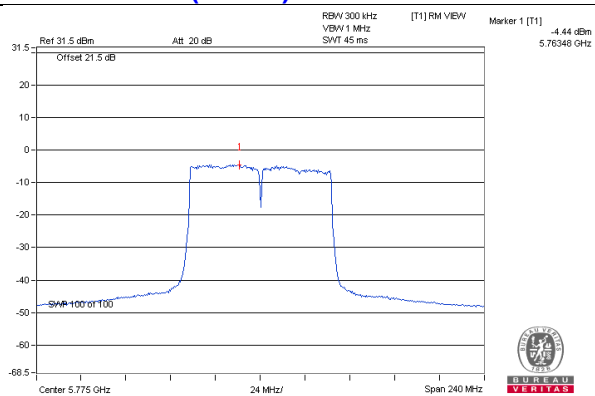
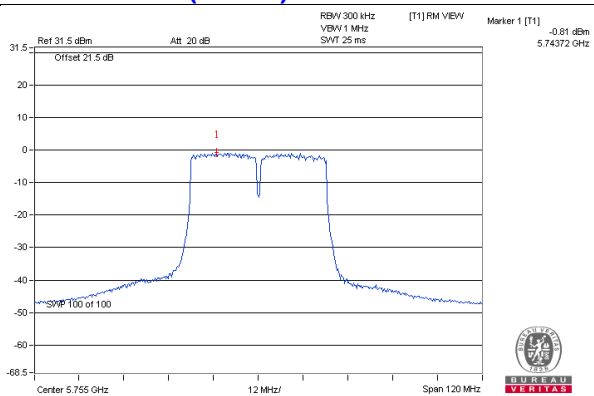

4.6 Frequency Stability Measurement

4.6.1 Limits of Frequency Stability Measurement

The frequency of the carrier signal shall be maintained within band of operation

4.6.2 Test Setup

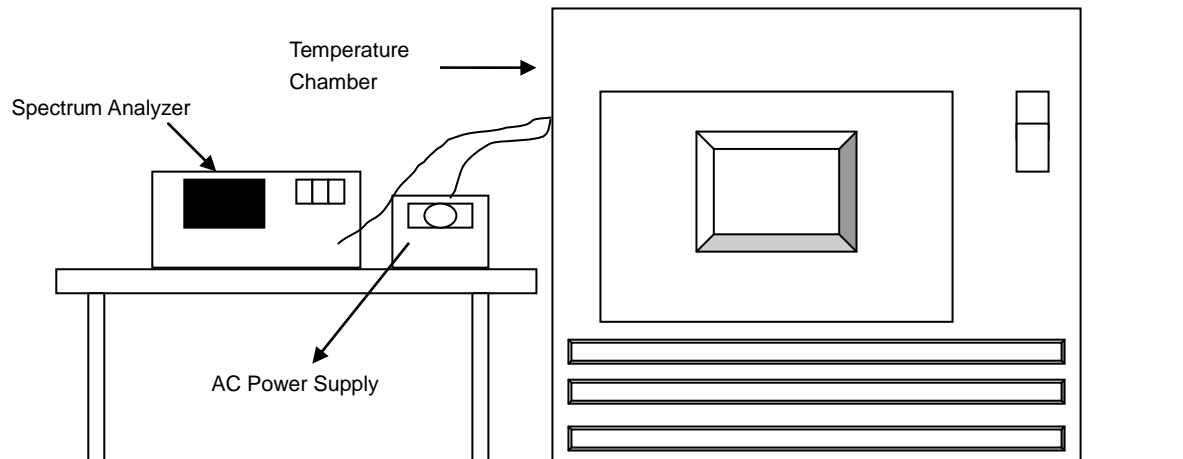

4.6.3 Test Instruments

Refer to section 4.1.2 to get information of above instrument.

4.6.4 Test Procedure

- The EUT was placed inside the environmental test chamber and powered by nominal AC voltage.
- Turn the EUT on and couple its output to a spectrum analyzer.
- Turn the EUT off and set the chamber to the highest temperature specified.
- Allow sufficient time (approximately 30 min) for the temperature of the chamber to stabilize, turn the EUT on and measure the operating frequency after 2, 5, and 10 Minutes.
- Repeat step 2 and 3 with the temperature chamber set to the lowest temperature.
- The test chamber was allowed to stabilize at +20 degree C for a minimum of 30 Minutes. The supply voltage was then adjusted on the EUT from 85% to 115% and the frequency record.

4.6.5 Deviation from Test Standard

No deviation.

4.6.6 EUT Operating Condition

Set the EUT transmit at un-modulation mode to test frequency stability.

4.6.7 Test Results

Frequency Stability Versus Temp.									
Operating Frequency: 5180 MHz									
TEMP. (°C)	Power Supply (Vac)	0 Minute		2 Minute		5 Minute		10 Minute	
		Measured Frequency (MHz)	Pass/Fail	Measured Frequency (MHz)	Pass/Fail	Measured Frequency (MHz)	Pass/Fail	Measured Frequency (MHz)	Pass/Fail
50	120	5180.0247	PASS	5180.0248	PASS	5180.0229	PASS	5180.0226	PASS
40	120	5180.0215	PASS	5180.0216	PASS	5180.0192	PASS	5180.0232	PASS
30	120	5180.0167	PASS	5180.0139	PASS	5180.0158	PASS	5180.016	PASS
20	120	5180.0047	PASS	5180.0063	PASS	5180.004	PASS	5180.0067	PASS
10	120	5180.0094	PASS	5180.0088	PASS	5180.0064	PASS	5180.0107	PASS
0	120	5179.9916	PASS	5179.9958	PASS	5179.9927	PASS	5179.9954	PASS
-10	120	5180.0098	PASS	5180.0064	PASS	5180.0062	PASS	5180.009	PASS
-20	120	5179.9912	PASS	5179.9899	PASS	5179.9877	PASS	5179.9905	PASS
-30	120	5179.9862	PASS	5179.9852	PASS	5179.9835	PASS	5179.9814	PASS

Frequency Stability Versus Voltage									
Operating Frequency: 5180 MHz									
TEMP. (°C)	Power Supply (Vac)	0 Minute		2 Minute		5 Minute		10 Minute	
		Measured Frequency (MHz)	Pass/Fail	Measured Frequency (MHz)	Pass/Fail	Measured Frequency (MHz)	Pass/Fail	Measured Frequency (MHz)	Pass/Fail
20	138	5180.0049	PASS	5180.0065	PASS	5180.0039	PASS	5180.0076	PASS
	120	5180.0047	PASS	5180.0063	PASS	5180.004	PASS	5180.0067	PASS
	102	5180.0044	PASS	5180.0057	PASS	5180.0048	PASS	5180.0074	PASS

4.7 6dB Bandwidth Measurement

4.7.1 Limits of 6dB Bandwidth Measurement

The minimum of 6dB Bandwidth Measurement is 0.5MHz.

4.7.2 Test Setup

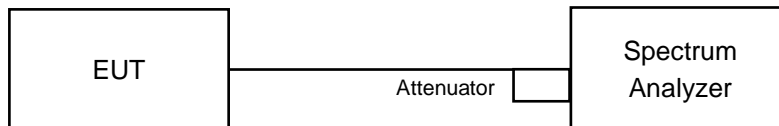

4.7.3 Test Instruments

Refer to section 4.1.2 to get information of above instrument.

4.7.4 Test Procedure

MEASUREMENT PROCEDURE REF

- a. Set resolution bandwidth (RBW) = 100kHz
- b. Set the video bandwidth (VBW) $\geq 3 \times$ RBW, Detector = Peak.
- c. Trace mode = max hold.
- d. Sweep = auto couple.
- e. Measure the maximum width of the emission that is constrained by the frequencies associated with the two amplitude points (upper and lower) that are attenuated by 6 dB relative to the maximum level measured in the fundamental emission

4.7.5 Deviation from Test Standard

No deviation.

4.7.6 EUT Operating Condition

The software provided by client to enable the EUT under transmission condition continuously at lowest, middle and highest channel frequencies individually.

4.7.7 Test Results

802.11a

Channel	Frequency (MHz)	6dB Bandwidth (MHz)				Minimum Limit (MHz)	Pass / Fail
		Chain 0	Chain 1	Chain 2	Chain 3		
149	5745	16.45	16.47	16.47	16.45	0.5	PASS
157	5785	16.46	16.45	16.44	16.44	0.5	PASS
165	5825	16.46	16.42	16.44	16.44	0.5	PASS

802.11ac (VHT20)

Channel	Frequency (MHz)	6dB Bandwidth (MHz)				Minimum Limit (MHz)	Pass / Fail
		Chain 0	Chain 1	Chain 2	Chain 3		
149	5745	17.72	17.72	17.70	17.67	0.5	PASS
157	5785	17.69	17.71	17.71	17.71	0.5	PASS
165	5825	17.67	17.71	17.64	17.68	0.5	PASS

802.11ac (VHT40)

Channel	Frequency (MHz)	6dB Bandwidth (MHz)				Minimum Limit (MHz)	Pass / Fail
		Chain 0	Chain 1	Chain 2	Chain 3		
151	5755	36.51	36.53	36.49	36.50	0.5	PASS
159	5795	36.52	36.54	36.49	36.50	0.5	PASS

802.11ac (VHT80)

Channel	Frequency (MHz)	6dB Bandwidth (MHz)				Minimum Limit (MHz)	Pass / Fail
		Chain 0	Chain 1	Chain 2	Chain 3		
155	5775	76.26	76.47	76.08	76.51	0.5	PASS

Spectrum Plot of Worst Value

802.11a_Chain 1 / CH165

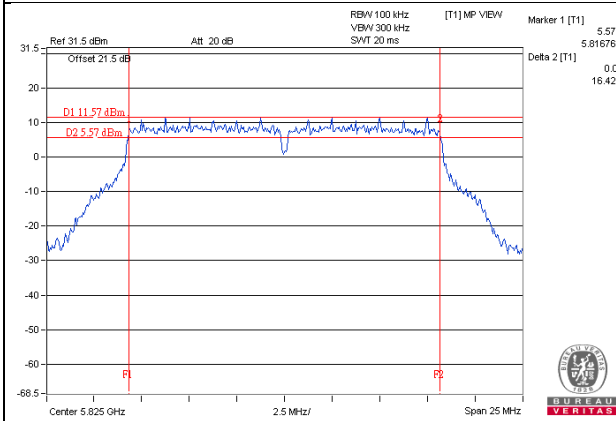

802.11ac (VHT20)_Chain 2 / CH165

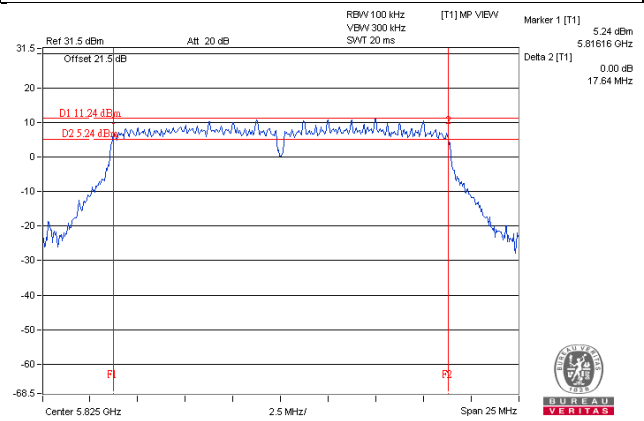

802.11ac (VHT40)_Chain 2 / CH151

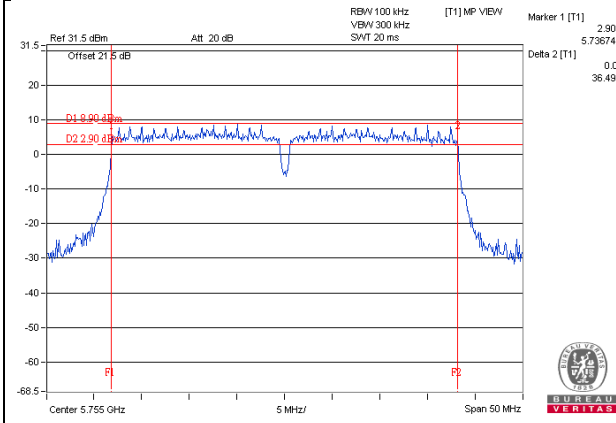

802.11ac (VHT80)_Chain 2 / CH155

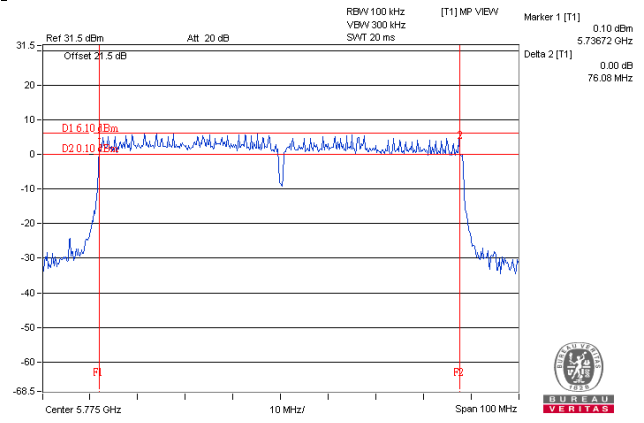

5 Pictures of Test Arrangements

Please refer to the attached file (Test Setup Photo).

Annex A- Radiated Out of Band Emission (OOBE) Measurement (For U-NII-3 band)

802.11a

CH 149 5745 MHz

Horizontal

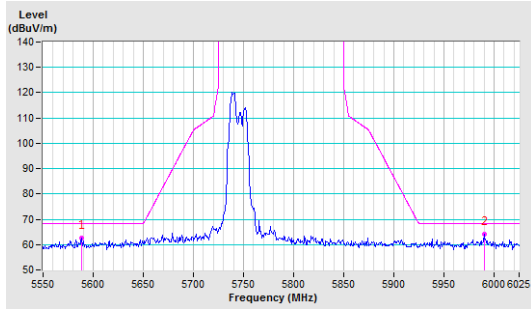

Vertical

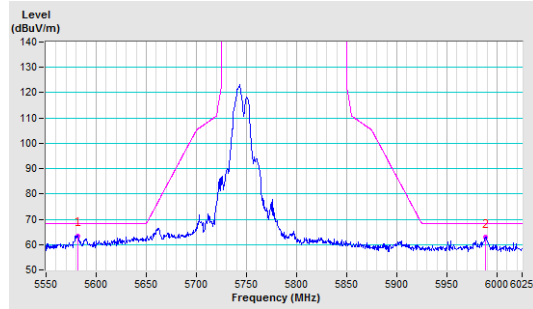

CH 157 5785 MHz

Horizontal

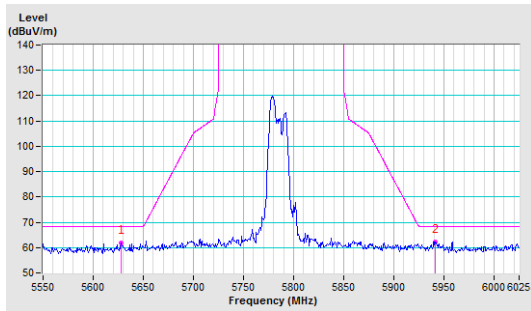

Vertical

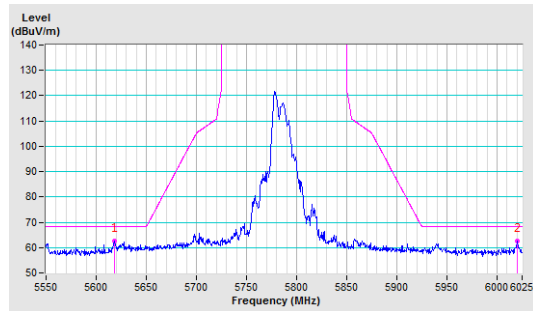

CH 165 5825 MHz

Horizontal

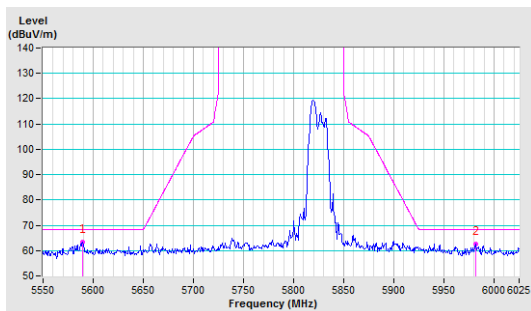

Vertical

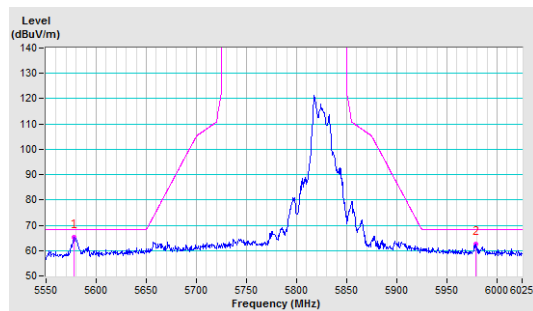

802.11ac (VHT20)

CH 149 5745 MHz

Horizontal

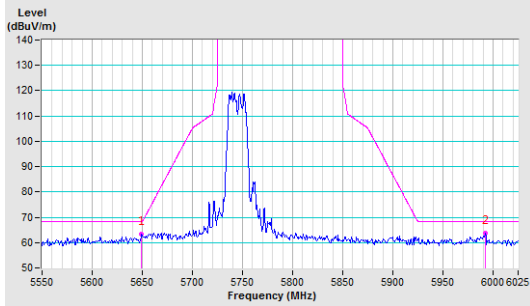

Vertical

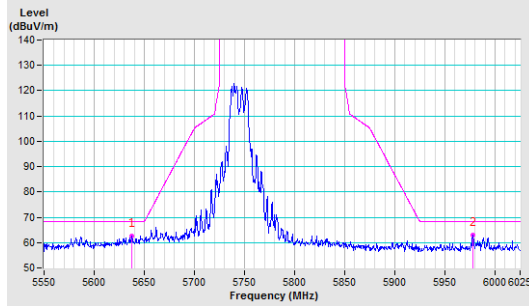

CH 157 5785 MHz

Horizontal

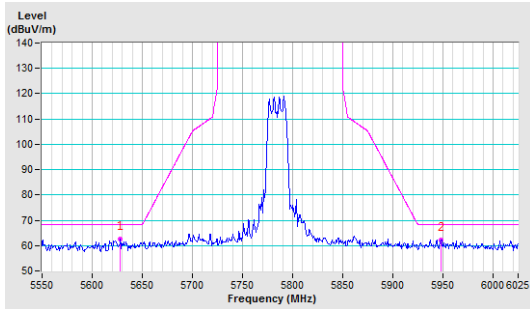

Vertical

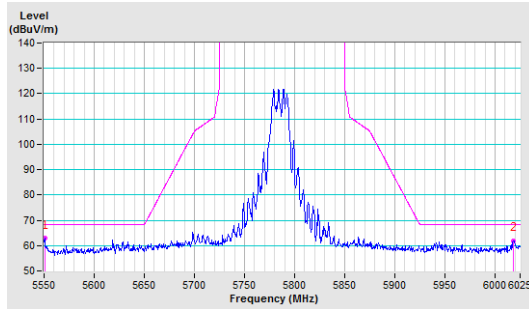

CH 165 5825 MHz

Horizontal

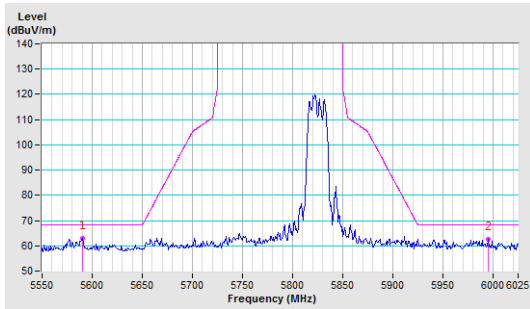

Vertical

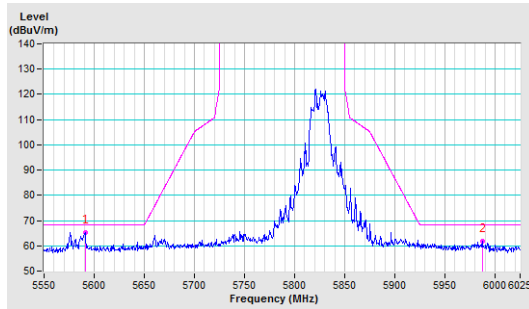

802.11ac (VHT40)

CH 151 5755 MHz

Horizontal

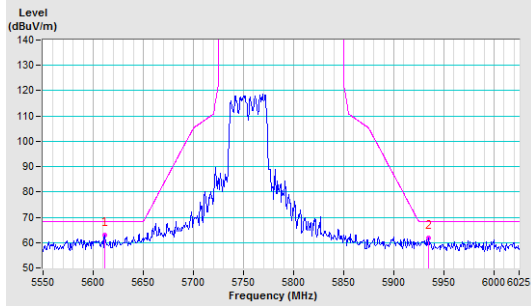

Vertical

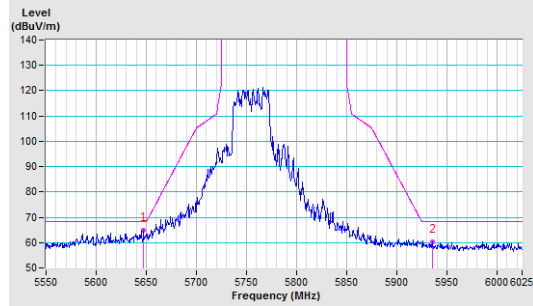

CH 159 5795 MHz

Horizontal

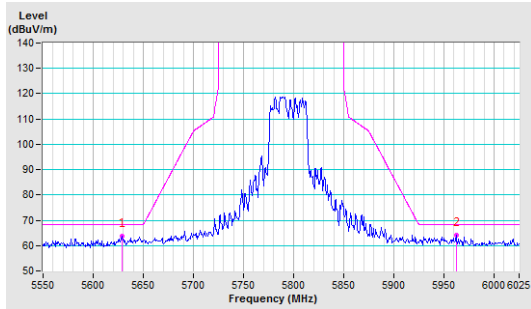

Vertical

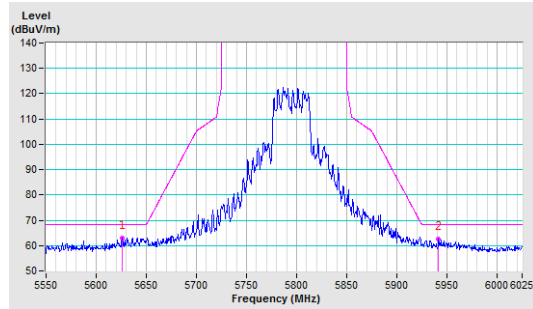

802.11ac (VHT80)

CH 155 5775 MHz

Horizontal

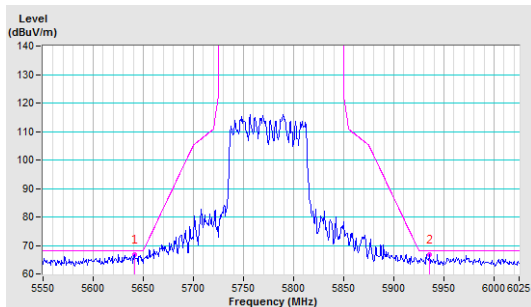

Vertical

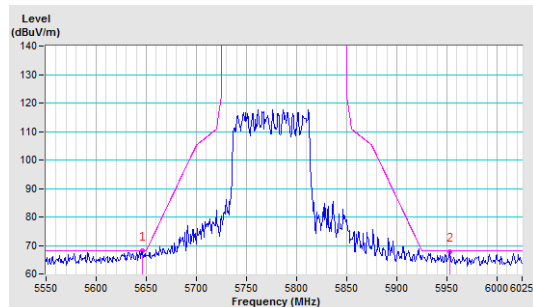

Appendix – Information on the Testing Laboratories

We, Bureau Veritas Consumer Products Services (H.K.) Ltd., Taoyuan Branch, were founded in 1988 to provide our best service in EMC, Radio, Telecom and Safety consultation. Our laboratories are FCC recognized accredited test firms and accredited according to ISO/IEC 17025.

If you have any comments, please feel free to contact us at the following:

Linko EMC/RF Lab

Tel: 886-2-26052180

Fax: 886-2-26051924

Hsin Chu EMC/RF/Telecom Lab

Tel: 886-3-6668565

Fax: 886-3-6668323

Hwa Ya EMC/RF/Safety Lab

Tel: 886-3-3183232

Fax: 886-3-3270892

Email: service.adt@tw.bureauveritas.com

Web Site: www.bureauveritas-adt.com

The address and road map of all our labs can be found in our web site also.

--- END ---