

FCC Test Report

Report No.: RF150907C06 R4

FCC ID: VUI10242HD

Test Model: 10242HD

Series Model: 10XXXHDX (X=0~9 and A~Z or blank)

Received Date: Sep. 06, 2015

Test Date: Sep. 10 to 11, 2015

Issued Date: Oct. 21, 2015

Applicant: PEGATRON CORPORATION

Address: 5F, No. 76 Ligong St., Beitou, Taipei 112, Taiwan

Issued By: Bureau Veritas Consumer Products Services (H.K.) Ltd., Taoyuan Branch
Hsin Chu Laboratory

Lab Address: No. 81-1, Lu Liao Keng, 9th Ling, Wu Lung Tsuen, Chiung Lin Hsiang, Hsin
Chu Hsien 307, Taiwan R.O.C.

Test Location (1): No. 81-1, Lu Liao Keng, 9th Ling, Wu Lung Tsuen, Chiung Lin Hsiang, Hsin
Chu Hsien 307, Taiwan R.O.C.

Test Location (2): No. 49, Ln. 206, Wende Rd., Shangshan Tsuen, Chiung Lin Hsiang, Hsin
Chu Hsien 307, Taiwan R.O.C.

Test Location (3): E-2, No.1, Li Hsin 1st Road, Hsinchu Science Park, Hsinchu City 300,
Taiwan R.O.C.



This report is for your exclusive use. Any copying or replication of this report to or for any other person or entity, or use of our name or trademark, is permitted only with our prior written permission. This report sets forth our findings solely with respect to the test samples identified herein. The results set forth in this report are not indicative or representative of the quality or characteristics of the lot from which a test sample was taken or any similar or identical product unless specifically and expressly noted. Our report includes all of the tests requested by you and the results thereof based upon the information that you provided to us. You have 60 days from date of issuance of this report to notify us of any material error or omission caused by our negligence, provided, however, that such notice shall be in writing and shall specifically address the issue you wish to raise. A failure to raise such issue within the prescribed time shall constitute your unqualified acceptance of the completeness of this report, the tests conducted and the correctness of the report contents. Unless specific mention, the uncertainty of measurement has been explicitly taken into account to declare the compliance or non-compliance to the specification. The report must not be used by the client to claim product certification, approval, or endorsement by TAF or any government agencies.

Table of Contents

Release Control Record	4
1 Certificate of Conformity	5
2 Summary of Test Results	6
2.1 Measurement Uncertainty.....	6
2.2 Modification Record.....	6
3 General Information	7
3.1 General Description of EUT.....	7
3.2 Description of Test Modes.....	8
3.2.1 Test Mode Applicability and Tested Channel Detail.....	9
3.3 Duty Cycle of Test Signal.....	11
3.4 Description of Support Units.....	12
3.4.1 Configuration of System under Test.....	13
3.5 General Description of Applied Standards.....	14
4 Test Types and Results	15
4.1 Radiated Emission and Bandedge Measurement.....	15
4.1.1 Limits of Radiated Emission and Bandedge Measurement.....	15
4.1.2 Test Instruments.....	16
4.1.3 Test Procedures.....	17
4.1.4 Deviation from Test Standard.....	17
4.1.5 Test Setup.....	18
4.1.6 EUT Operating Conditions.....	18
4.1.7 Test Results.....	19
4.2 Conducted Emission Measurement.....	23
4.2.1 Limits of Conducted Emission Measurement.....	23
4.2.2 Test Instruments.....	23
4.2.3 Test Procedures.....	24
4.2.4 Deviation from Test Standard.....	24
4.2.5 Test Setup.....	24
4.2.6 EUT Operating Conditions.....	24
4.2.7 Test Results (Mode 1).....	25
4.2.8 Test Results (Mode 2).....	27
4.3 6dB Bandwidth Measurement.....	29
4.3.1 Limits of 6dB Bandwidth Measurement.....	29
4.3.2 Test Setup.....	29
4.3.3 Test Instruments.....	29
4.3.4 Test Procedures.....	29
4.3.5 Deviation from Test Standard.....	29
4.3.6 EUT Operating Conditions.....	29
4.3.7 Test Results.....	30
4.4 Conducted Output Power Measurement.....	31
4.4.1 Limits of Conducted Output Power Measurement.....	31
4.4.2 Test Setup.....	31
4.4.3 Test Instruments.....	31
4.4.4 Test Procedures.....	31
4.4.5 Deviation from Test Standard.....	31
4.4.6 EUT Operating Conditions.....	31
4.4.7 Test Results.....	32
4.5 Power Spectral Density Measurement.....	33
4.5.1 Limits of Power Spectral Density Measurement.....	33
4.5.2 Test Setup.....	33
4.5.3 Test Instruments.....	33
4.5.4 Test Procedures.....	33
4.5.5 Deviation from Test Standard.....	33



4.5.6 EUT Operating Conditions.....	33
4.5.7 Test Results	34
4.6 Conducted Out of Band Emission Measurement.....	35
4.6.1 Limits of Conducted Out of Band Emission Measurement	35
4.6.2 Test Setup.....	35
4.6.3 Test Instruments	35
4.6.4 Test Procedures.....	35
4.6.5 Deviation from Test Standard	35
4.6.6 EUT Operating Conditions.....	35
4.6.7 Test Results	35
5 Pictures of Test Arrangements.....	37
Appendix – Information on the Testing Laboratories	38



Release Control Record

Issue No.	Description	Date Issued
RF150907C06	Original release.	Sep. 17, 2015
RF150907C06 R1	Modified the FCC ID.	Sep. 21, 2015
RF150907C06 R2	Modified the model name.	Sep. 22, 2015
RF150907C06 R3	Added the PSD plot of section 4.5.7	Sep. 25, 2015
RF150907C06 R4	Modified channel list.	Oct. 21, 2015

2 Summary of Test Results

47 CFR FCC Part 15, Subpart C (SECTION 15.247)			
FCC Clause	Test Item	Result	Remarks
15.207	AC Power Conducted Emission	PASS	Meet the requirement of limit. Minimum passing margin is -12.18dB at 0.17344MHz.
15.205 / 15.209 / 15.247(d)	Radiated Emissions and Band Edge Measurement	PASS	Meet the requirement of limit. Minimum passing margin is -3.2dB at 35.14MHz.
15.247(d)	Antenna Port Emission	PASS	Meet the requirement of limit.
15.247(a)(2)	6dB bandwidth	PASS	Meet the requirement of limit.
15.247(b)	Conducted power	PASS	Meet the requirement of limit.
15.247(e)	Power Spectral Density	PASS	Meet the requirement of limit.
15.203	Antenna Requirement	PASS	No antenna connector is used.

2.1 Measurement Uncertainty

Where relevant, the following measurement uncertainty levels have been estimated for tests performed on the EUT as specified in CISPR 16-4-2:

Measurement	Frequency	Expanded Uncertainty (k=2) (\pm)
Conducted Emissions at mains ports	150kHz ~ 30MHz	2.86 dB
Radiated Emissions up to 1 GHz	30MHz ~ 1GHz	5.43 dB
Radiated Emissions above 1 GHz	1GHz ~ 6GHz	3.72 dB
	6GHz ~ 18GHz	4.00 dB
	18GHz ~ 40GHz	4.11 dB

2.2 Modification Record

There were no modifications required for compliance.

3 General Information

3.1 General Description of EUT

Product	Set Top Box
Brand	CISCO
Test Model	10242HD
Series Model	10XXXHDX (X=0~9 and A~Z or blank)
Status of EUT	ENGINEERING SAMPLE
Power Supply Rating	12Vdc from power adapter
Modulation Type	O-QPSK
Modulation Technology	DTS
Transfer Rate	250kbps
Operating Frequency	2.425GHz ~ 2.475GHz
Number of Channel	11
Output Power	2.972mW
Antenna Type	Refer to Note
Antenna Connector	Refer to Note
Accessory Device	Adapter x 1
Data Cable Supplied	NA

Note:

1. The EUT has different model names, which are identical to each other in all aspects except for the following table:

Brand Name	Model No.	Description
CISCO	10242HD	For marketing requirement
	10XXXHDX (X=0~9 and A~Z or blank)	

From the above models, model: 10242HD was selected as representative model for the test and its data was recorded in this report.

2. The antennas provided to the EUT, please refer to the following table:

Ant. Type	Ant. Gain (dBi)	Frequency (GHz)	Connector Type
PIFA	0.91	2.425	NA
	0.86	2.450	
	0.60	2.475	

3. The EUT must be supplied with a power adapter, and following different model names could be chosen:

No.	Brand	Model No.	Spec.
1	LITEON	PA-1360-8SA2	AC Input: 100-240V, 1.0A, 50/60Hz AC input cable: 1.7m DC Output: 12V, 3.0A DC output cable: 1.45m, unshielded
2	LITEON	PA-1360-07C1	AC Input: 100-240V, 1.0A, 50/60Hz AC input cable: 1.7m DC Output: 12V, 3.0A, 36W MAX. DC output cable: 1.5m, unshielded

From the above adapters, the radiated emission worst case was found in **Adapter 2**. Therefore only the test data of the mode was recorded in this report.

4. The above EUT information is declared by manufacturer and for more detailed features description, please refer to the manufacturer's specifications or user's manual.

3.2 Description of Test Modes

11 channels are provided to the EUT:

Channel	Frequency	Channel	Frequency
15	2425	21	2455
16	2430	22	2460
17	2435	23	2465
18	2440	24	2470
19	2445	25	2475
20	2450		

3.2.1 Test Mode Applicability and Tested Channel Detail

EUT CONFIGURE MODE	APPLICABLE TO				DESCRIPTION
	RE \geq 1G	RE<1G	PLC	APCM	
1	√	√	√	√	With Adapter 2
2	-	-	√	-	With Adapter 1

Where **RE \geq 1G**: Radiated Emission above 1GHz & Bandedge Measurement **RE<1G**: Radiated Emission below 1GHz
PLC: Power Line Conducted Emission **APCM**: Antenna Port Conducted Measurement

NOTE: “-” means no effect.

Radiated Emission Test (Above 1GHz):

- Pre-Scan has been conducted to determine the worst-case mode from all possible combinations between available modulations, data rates and antenna ports (if EUT with antenna diversity architecture).
- Following channel(s) was (were) selected for the final test as listed below.

AVAILABLE CHANNEL	TESTED CHANNEL	MODULATION TECHNOLOGY	MODULATION TYPE	DATA RATE (kbps)
15 to 25	15, 20, 25	DTS	O-QPSK	250

Radiated Emission Test (Below 1GHz):

- Pre-Scan has been conducted to determine the worst-case mode from all possible combinations between available modulations, data rates and antenna ports (if EUT with antenna diversity architecture).
- Following channel(s) was (were) selected for the final test as listed below.

AVAILABLE CHANNEL	TESTED CHANNEL	MODULATION TECHNOLOGY	MODULATION TYPE	DATA RATE (kbps)
15 to 25	25	DTS	O-QPSK	250

Power Line Conducted Emission Test:

- Pre-Scan has been conducted to determine the worst-case mode from all possible combinations between available modulations, data rates and antenna ports (if EUT with antenna diversity architecture).
- Following channel(s) was (were) selected for the final test as listed below.

AVAILABLE CHANNEL	TESTED CHANNEL	MODULATION TECHNOLOGY	MODULATION TYPE	DATA RATE (kbps)
15 to 25	25	DTS	O-QPSK	250

Antenna Port Conducted Measurement:

- This item includes all test value of each mode, but only includes spectrum plot of worst value of each mode.
- Pre-Scan has been conducted to determine the worst-case mode from all possible combinations between available modulations, data rates and antenna ports (if EUT with antenna diversity architecture).
- Following channel(s) was (were) selected for the final test as listed below.

AVAILABLE CHANNEL	TESTED CHANNEL	MODULATION TECHNOLOGY	MODULATION TYPE	DATA RATE (kbps)
15 to 25	15, 20, 25	DTS	O-QPSK	250

Test Condition:

APPLICABLE TO	ENVIRONMENTAL CONDITIONS	INPUT POWER	TESTED BY
RE≥1G	27deg. C, 75%RH	120Vac, 60Hz	Tim Ho
RE<1G	22deg. C, 65%RH	120Vac, 60Hz	Robert Cheng
PLC	26deg. C, 62%RH	120Vac, 60Hz	Timmy Hu
APCM	25deg. C, 60%RH	120Vac, 60Hz	Anderson Chen

3.3 Duty Cycle of Test Signal

Duty cycle of test signal is 100 %, duty factor is not required.

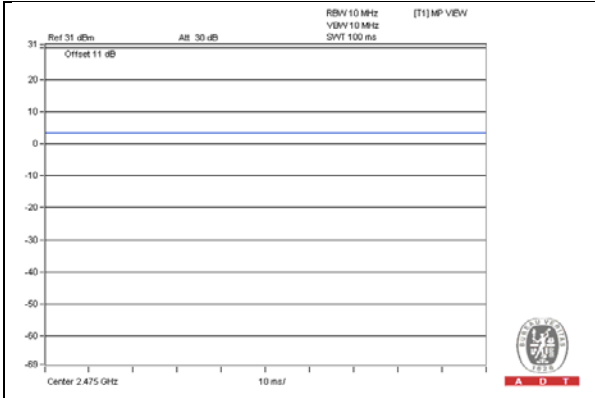

3.4 Description of Support Units

The EUT has been tested as an independent unit together with other necessary accessories or support units. The following support units or accessories were used to form a representative test configuration during the tests.

ID	Product	Brand	Model No.	Serial No.	FCC ID	Remarks
A.	Dongle	Transcend	NA	NA	NA	Provided by Lab
B.	Notebook Computer	DELL	E5430	4YV4VY1	FCC DoC	Provided by Lab
C.	LED PANEL	HERAN	HD-32DD3	A47FH6796	NA	Provided by Lab
D.	Converter	NA	NA	NA	NA	Provided by Lab
E.	Earphone	Hawk	HKC920	H002	NA	Provided by Lab

Note:

1. All power cords of the above support units are non-shielded (1.8m).

ID	Descriptions	Qty.	Length (m)	Shielding (Yes/No)	Cores (Qty.)	Remarks
1.	DC (for Mode 1)	1	1.5	No	0	Supplied by Client
	DC (for Mode 2)	1	1.45	No	0	Supplied by Client
2.	RJ-45	1	10	No	0	Provided by Lab
3.	Coaxial	1	10	Yes	0	Provided by Lab
4.	Video	1	1.2	No	0	Provided by Lab
5.	Audio	1	1.2	No	0	Provided by Lab
6.	Audio	1	1.2	No	0	Provided by Lab
7.	Optical	1	1.5	No	0	Provided by Lab
8.	Audio	1	2.2	No	0	Provided by Lab

3.4.1 Configuration of System under Test

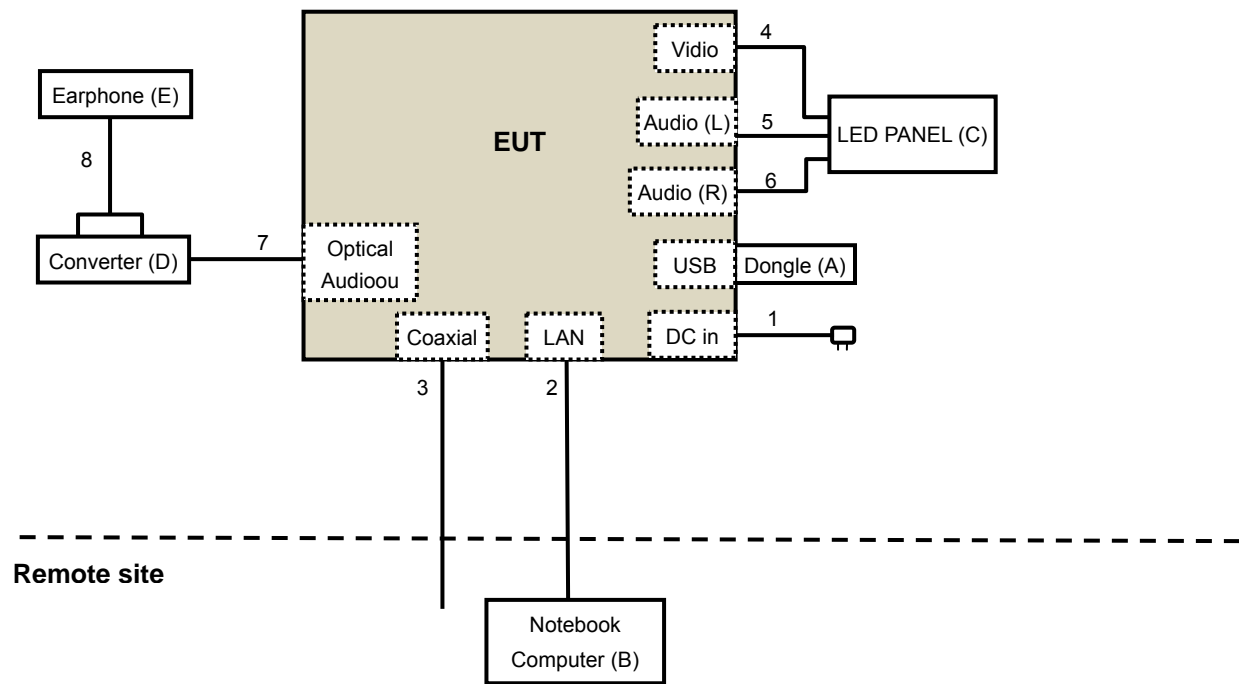

3.5 General Description of Applied Standards

The EUT is a RF Product. According to the specifications of the manufacturer, it must comply with the requirements of the following standards:

FCC Part 15, Subpart C (15.247)

558074 D01 DTS Meas Guidance v03r03

ANSI C63.10-2013

All test items have been performed and recorded as per the above standards.

4 Test Types and Results

4.1 Radiated Emission and Bandedge Measurement

4.1.1 Limits of Radiated Emission and Bandedge Measurement

Radiated emissions which fall in the restricted bands must comply with the radiated emission limits specified as below table. Other emissions shall be at least 20dB below the highest level of the desired power:

Frequencies (MHz)	Field Strength (microvolts/meter)	Measurement Distance (meters)
0.009 ~ 0.490	2400/F(kHz)	300
0.490 ~ 1.705	24000/F(kHz)	30
1.705 ~ 30.0	30	30
30 ~ 88	100	3
88 ~ 216	150	3
216 ~ 960	200	3
Above 960	500	3

NOTE:

1. The lower limit shall apply at the transition frequencies.
2. Emission level (dBuV/m) = 20 log Emission level (uV/m).
3. For frequencies above 1000MHz, the field strength limits are based on average detector, however, the peak field strength of any emission shall not exceed the maximum permitted average limits, specified above by more than 20dB under any condition of modulation.

4.1.2 Test Instruments

DESCRIPTION & MANUFACTURER	MODEL NO.	SERIAL NO.	CALIBRATED DATE	CALIBRATED UNTIL
Test Receiver Agilent	N9038A	MY51210105	July 24, 2015	July 23, 2016
Pre-Amplifier Mini-Circuits	ZFL-1000VH2 B	AMP-ZFL-03	Nov. 12, 2014	Nov. 11, 2015
Trilog Broadband Antenna SCHWARZBECK	VULB 9168	9168-360	Feb. 06, 2015	Feb. 05, 2016
RF Cable	8D-FB	CHGCAB-001 -1 CHGCAB-001 -2	Oct. 04, 2014	Oct. 03, 2015
	RF-141	CHGCAB-004	Oct. 04, 2014	Oct. 03, 2015
Horn_Antenna AISI	AIH.8018	000032009111 0	Feb. 09, 2015	Feb. 08, 2016
Pre-Amplifier Agilent	8449B	3008A02578	June 23, 2015	June 22, 2016
RF Cable	NA	131205 131216 131217 SNMY23684/ 4	Jan. 16, 2015	Jan. 15, 2016
Spectrum Analyzer R&S	FSV40	100964	June 26, 2015	June 25, 2016
Pre-Amplifier SPACEK LABS	SLKKa-48-6	9K16	Dec. 12, 2014	Dec. 11, 2015
Horn_Antenna SCHWARZBECK	BBHA 9170	9170-424	Feb. 05, 2015	Feb. 04, 2016
RF Cable	NA	329751/4 RF104-204	Dec. 11, 2014	Dec. 10, 2015
Software	ADT_Radiated _V8.7.07	NA	NA	NA
Antenna Tower & Turn Table CT	NA	NA	NA	NA
Spectrum Analyzer R&S	FSP 40	100060	May 08, 2015	May 07, 2016
Power meter Anritsu	ML2495A	1014008	Apr. 28, 2015	Apr. 27, 2016
Power sensor Anritsu	MA2411B	0917122	Apr. 28, 2015	Apr. 27, 2016

Note:

1. The calibration interval of the above test instruments is 12 months and the calibrations are traceable to NML/ROC and NIST/USA.
2. The test was performed in 966 Chamber No. G.
3. The FCC Site Registration No. is 966073.
4. The VCCI Site Registration No. is G-137.
5. The CANADA Site Registration No. is IC 7450H-2.
6. Tested Date: Sep. 10 to 11, 2015

4.1.3 Test Procedures

- a. The EUT was placed on the top of a rotating table 0.8 meters (for below 1GHz) / 1.5 meters (for above 1GHz) above the ground at 3 meter chamber room for test. The table was rotated 360 degrees to determine the position of the highest radiation.
- b. The EUT was set 3 meters away from the interference-receiving antenna, which was mounted on the top of a variable-height antenna tower.
- c. The height of antenna is varied from one meter to four meters above the ground to determine the maximum value of the field strength. Both horizontal and vertical polarizations of the antenna are set to make the measurement.
- d. For each suspected emission, the EUT was arranged to its worst case and then the antenna was tuned to heights from 1 meter to 4 meters and the rotatable table was turned from 0 degrees to 360 degrees to find the maximum reading.
- e. The test-receiver system was set to quasi-peak detect function and specified bandwidth with maximum hold mode when the test frequency is below 1 GHz.
- f. The test-receiver system was set to peak and average detect function and specified bandwidth with maximum hold mode when the test frequency is above 1 GHz. If the peak reading value also meets average limit, measurement with the average detector is unnecessary.

Note:

1. The resolution bandwidth and video bandwidth of test receiver/spectrum analyzer is 120kHz for Quasi-peak detection (QP) at frequency below 1GHz.
2. The resolution bandwidth of test receiver/spectrum analyzer is 1 MHz and the video bandwidth is 3 MHz for Peak detection (PK) at frequency above 1GHz.
3. The resolution bandwidth of test receiver/spectrum analyzer is 1MHz and the video bandwidth is 3MHz for RMS Average (Duty cycle < 98%) for Average detection (AV) at frequency above 1GHz, then the measurement results was added to a correction factor ($10 \log(1/\text{duty cycle})$).
4. The resolution bandwidth of test receiver/spectrum analyzer is 1MHz and the video bandwidth is 10Hz (Duty cycle $\geq 98\%$) for Average detection (AV) at frequency above 1GHz.
5. All modes of operation were investigated and the worst-case emissions are reported.

4.1.4 Deviation from Test Standard

No deviation.

4.1.5 Test Setup

<Frequency Range below 1GHz>

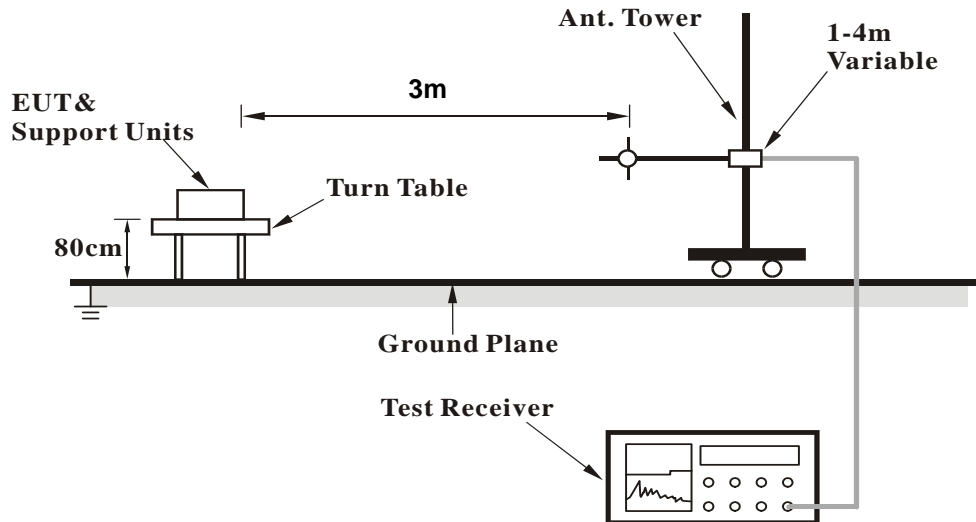

<Frequency Range above 1GHz>

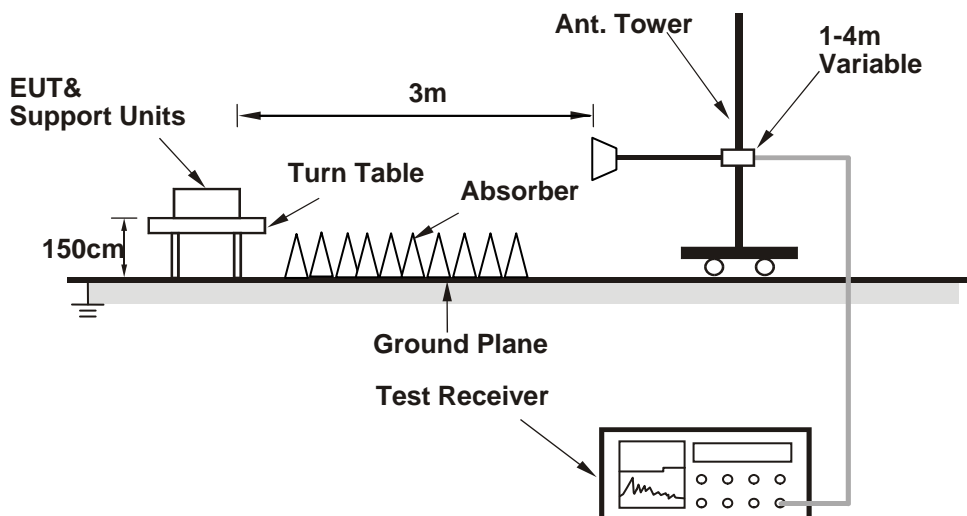

For the actual test configuration, please refer to the attached file (Test Setup Photo).

4.1.6 EUT Operating Conditions

1. Placed the EUT on the testing table.
2. Connect the EUT with the support unit A (Notebook Computer) which is placed in remote site.
3. The communication partner run test program "SmartRF studio 7_V2.1.0" to enable EUT under transmission/receiving condition continuously at specific channel frequency.

4.1.7 Test Results

Above 1GHz Data

CHANNEL	TX Channel 15	DETECTOR FUNCTION	Peak (PK)
FREQUENCY RANGE	1GHz ~ 25GHz		Average (AV)

ANTENNA POLARITY & TEST DISTANCE: HORIZONTAL AT 3 M

NO.	FREQ. (MHz)	EMISSION LEVEL (dBuV/m)	LIMIT (dBuV/m)	MARGIN (dB)	ANTENNA HEIGHT (m)	TABLE ANGLE (Degree)	RAW VALUE (dBuV)	CORRECTION FACTOR (dB/m)
1	2390.00	46.0 PK	74.0	-28.0	1.00 H	240	41.77	4.23
2	2390.00	34.8 AV	54.0	-19.2	1.00 H	240	30.57	4.23
3	*2425.00	97.3 PK			1.00 H	240	92.91	4.39
4	*2425.00	93.7 AV			1.00 H	240	89.31	4.39
5	4850.00	46.8 PK	74.0	-27.2	1.54 H	240	36.19	10.61
6	4850.00	37.3 AV	54.0	-16.7	1.54 H	240	26.69	10.61
7	7320.00	60.3 PK	74.0	-13.7	1.00 H	194	42.55	17.75
8	7320.00	49.9 AV	54.0	-4.1	1.00 H	194	32.15	17.75

ANTENNA POLARITY & TEST DISTANCE: VERTICAL AT 3 M

NO.	FREQ. (MHz)	EMISSION LEVEL (dBuV/m)	LIMIT (dBuV/m)	MARGIN (dB)	ANTENNA HEIGHT (m)	TABLE ANGLE (Degree)	RAW VALUE (dBuV)	CORRECTION FACTOR (dB/m)
1	2390.00	46.2 PK	74.0	-27.8	1.00 V	183	41.97	4.23
2	2390.00	34.4 AV	54.0	-19.6	1.00 V	183	30.17	4.23
3	*2425.00	98.3 PK			1.00 V	183	93.91	4.39
4	*2425.00	94.0 AV			1.00 V	183	89.61	4.39
5	4850.00	48.4 PK	74.0	-25.6	1.58 V	183	37.79	10.61
6	4850.00	40.6 AV	54.0	-13.4	1.58 V	183	29.99	10.61
7	7275.00	56.3 PK	74.0	-17.7	1.00 V	134	38.61	17.69
8	7275.00	46.0 AV	54.0	-8.0	1.00 V	134	28.31	17.69

REMARKS:

1. Emission Level(dBuV/m) = Raw Value(dBuV) + Correction Factor(dB/m)
2. Correction Factor(dB/m) = Antenna Factor(dB/m) + Cable Factor(dB) – Pre-Amplifier Factor(dB)
3. The other emission levels were very low against the limit.
4. Margin value = Emission Level – Limit value
5. " * ": Fundamental frequency.

CHANNEL	TX Channel 20	DETECTOR FUNCTION	Peak (PK)
FREQUENCY RANGE	1GHz ~ 25GHz		Average (AV)

ANTENNA POLARITY & TEST DISTANCE: HORIZONTAL AT 3 M

NO.	FREQ. (MHz)	EMISSION LEVEL (dBuV/m)	LIMIT (dBuV/m)	MARGIN (dB)	ANTENNA HEIGHT (m)	TABLE ANGLE (Degree)	RAW VALUE (dBuV)	CORRECTION FACTOR (dB/m)
1	*2450.00	97.7 PK			1.00 H	242	93.21	4.49
2	*2450.00	93.9 AV			1.00 H	242	89.41	4.49
3	4900.00	45.0 PK	74.0	-29.0	1.40 H	244	34.23	10.77
4	4900.00	37.1 AV	54.0	-16.9	1.40 H	244	26.33	10.77
5	7350.00	60.1 PK	74.0	-13.9	1.00 H	186	42.28	17.82
6	7350.00	49.6 AV	54.0	-4.4	1.00 H	186	31.78	17.82

ANTENNA POLARITY & TEST DISTANCE: VERTICAL AT 3 M

NO.	FREQ. (MHz)	EMISSION LEVEL (dBuV/m)	LIMIT (dBuV/m)	MARGIN (dB)	ANTENNA HEIGHT (m)	TABLE ANGLE (Degree)	RAW VALUE (dBuV)	CORRECTION FACTOR (dB/m)
1	*2450.00	98.4 PK			1.00 V	185	93.91	4.49
2	*2450.00	94.4 AV			1.00 V	185	89.91	4.49
3	4900.00	47.8 PK	74.0	-26.2	1.55 V	150	37.03	10.77
4	4900.00	40.1 AV	54.0	-13.9	1.55 V	150	29.33	10.77
5	7350.00	56.1 PK	74.0	-17.9	1.00 V	135	38.28	17.82
6	7350.00	45.9 AV	54.0	-8.1	1.00 V	135	28.08	17.82

REMARKS:

1. Emission Level(dBuV/m) = Raw Value(dBuV) + Correction Factor(dB/m)
2. Correction Factor(dB/m) = Antenna Factor(dB/m) + Cable Factor(dB) – Pre-Amplifier Factor(dB)
3. The other emission levels were very low against the limit.
4. Margin value = Emission Level – Limit value
5. " * ": Fundamental frequency.

CHANNEL	TX Channel 25	DETECTOR FUNCTION	Peak (PK)
FREQUENCY RANGE	1GHz ~ 25GHz		Average (AV)

ANTENNA POLARITY & TEST DISTANCE: HORIZONTAL AT 3 M

NO.	FREQ. (MHz)	EMISSION LEVEL (dBuV/m)	LIMIT (dBuV/m)	MARGIN (dB)	ANTENNA HEIGHT (m)	TABLE ANGLE (Degree)	RAW VALUE (dBuV)	CORRECTION FACTOR (dB/m)
1	*2475.00	97.2 PK			1.00 H	244	92.59	4.61
2	*2475.00	93.2 AV			1.00 H	244	88.59	4.61
3	2483.50	50.7 PK	74.0	-23.3	1.00 H	244	46.05	4.65
4	2483.50	42.2 AV	54.0	-11.8	1.00 H	244	37.55	4.65
5	4950.00	44.3 PK	74.0	-29.7	1.42 H	215	33.41	10.89
6	4950.00	36.6 AV	54.0	-17.4	1.42 H	215	25.71	10.89
7	7425.00	59.2 PK	74.0	-14.8	1.00 H	188	41.15	18.05
8	7425.00	49.1 AV	54.0	-4.9	1.00 H	188	31.05	18.05

ANTENNA POLARITY & TEST DISTANCE: VERTICAL AT 3 M

NO.	FREQ. (MHz)	EMISSION LEVEL (dBuV/m)	LIMIT (dBuV/m)	MARGIN (dB)	ANTENNA HEIGHT (m)	TABLE ANGLE (Degree)	RAW VALUE (dBuV)	CORRECTION FACTOR (dB/m)
1	*2475.00	97.3 PK			1.00 V	185	92.69	4.61
2	*2475.00	93.3 AV			1.00 V	185	88.69	4.61
3	2483.50	51.1 PK	74.0	-22.9	1.00 V	185	46.45	4.65
4	2483.50	42.5 AV	54.0	-11.5	1.00 V	185	37.85	4.65
5	4950.00	47.1 PK	74.0	-26.9	1.50 V	150	36.21	10.89
6	4950.00	39.8 AV	54.0	-14.2	1.50 V	150	28.91	10.89
7	7425.00	55.5 PK	74.0	-18.5	1.00 V	154	37.45	18.05
8	7425.00	45.6 AV	54.0	-8.4	1.00 V	154	27.55	18.05

REMARKS:

1. Emission Level(dBuV/m) = Raw Value(dBuV) + Correction Factor(dB/m)
2. Correction Factor(dB/m) = Antenna Factor(dB/m) + Cable Factor(dB) – Pre-Amplifier Factor(dB)
3. The other emission levels were very low against the limit.
4. Margin value = Emission Level – Limit value
5. " * ": Fundamental frequency.

Below 1GHz Data

CHANNEL	TX Channel 25	DETECTOR FUNCTION	Quasi-Peak (QP)
FREQUENCY RANGE	Below 1GHz		

ANTENNA POLARITY & TEST DISTANCE: HORIZONTAL AT 3 M

NO.	FREQ. (MHz)	EMISSION LEVEL (dBuV/m)	LIMIT (dBuV/m)	MARGIN (dB)	ANTENNA HEIGHT (m)	TABLE ANGLE (Degree)	RAW VALUE (dBuV)	CORRECTION FACTOR (dB/m)
1	196.31	38.3 QP	43.5	-5.2	1.50 H	7	54.27	-15.96
2	227.20	34.5 QP	46.0	-11.5	1.00 H	335	50.30	-15.78
3	375.03	38.2 QP	46.0	-7.8	1.00 H	59	48.45	-10.22
4	586.93	37.1 QP	46.0	-8.9	1.50 H	289	42.23	-5.15
5	634.50	38.2 QP	46.0	-7.8	1.00 H	302	42.26	-4.04
6	875.02	38.6 QP	46.0	-7.4	1.50 H	226	38.96	-0.33

ANTENNA POLARITY & TEST DISTANCE: VERTICAL AT 3 M

NO.	FREQ. (MHz)	EMISSION LEVEL (dBuV/m)	LIMIT (dBuV/m)	MARGIN (dB)	ANTENNA HEIGHT (m)	TABLE ANGLE (Degree)	RAW VALUE (dBuV)	CORRECTION FACTOR (dB/m)
1	35.14	36.8 QP	40.0	-3.2	1.00 V	230	51.14	-14.34
2	46.68	35.9 QP	40.0	-4.1	1.00 V	330	49.33	-13.40
3	62.64	34.5 QP	40.0	-5.6	1.00 V	28	48.84	-14.39
4	221.19	40.6 QP	46.0	-5.4	1.00 V	153	56.69	-16.08
5	375.03	41.3 QP	46.0	-4.8	2.00 V	274	51.47	-10.22
6	747.32	41.2 QP	46.0	-4.8	1.50 V	360	43.19	-2.03

REMARKS:

1. Emission Level(dBuV/m) = Raw Value(dBuV) + Correction Factor(dB/m)
2. Correction Factor(dB/m) = Antenna Factor(dB/m) + Cable Factor(dB) – Pre-Amplifier Factor(dB)
3. The other emission levels were very low against the limit.
4. Margin value = Emission Level – Limit value

4.2 Conducted Emission Measurement

4.2.1 Limits of Conducted Emission Measurement

Frequency (MHz)	Conducted Limit (dBuV)	
	Quasi-peak	Average
0.15 - 0.5	66 - 56	56 - 46
0.50 - 5.0	56	46
5.0 - 30.0	60	50

Note: 1. The lower limit shall apply at the transition frequencies.

2. The limit decreases in line with the logarithm of the frequency in the range of 0.15 to 0.50MHz.

4.2.2 Test Instruments

DESCRIPTION & MANUFACTURER	MODEL NO.	SERIAL NO.	CALIBRATED DATE	CALIBRATED UNTIL
Test Receiver R&S	ESCS 30	100375	May 06, 2015	May 05, 2016
Line-Impedance Stabilization Network (for EUT) R&S	ENV216	100072	June 11, 2015	June 10, 2016
Line-Impedance Stabilization Network (for Peripheral) R&S	ENV216	100071	Nov. 10, 2014	Nov. 09, 2015
RF Cable	5D-FB	COCCAB-001	Mar. 09, 2015	Mar. 08, 2016
50 ohms Terminator	N/A	EMC-03	Sep. 22, 2014	Sep. 21, 2015
50 ohms Terminator	N/A	EMC-02	Sep. 30, 2014	Sep. 29, 2015
Software BVADT	BVADT_Cond_ V7.3.7.3	NA	NA	NA

Note:

1. The calibration interval of the above test instruments are 12 months and the calibrations are traceable to NML/ROC and NIST/USA.
2. The test was performed in Shielded Room No. C.
- 3 The VCCI Con C Registration No. is C-3611.
- 4 Tested Date: Sep. 10, 2015

4.2.3 Test Procedures

- a. The EUT was placed 0.4 meters from the conducting wall of the shielded room with EUT being connected to the power mains through a line impedance stabilization network (LISN). Other support units were connected to the power mains through another LISN. The two LISNs provide 50 ohm/ 50uH of coupling impedance for the measuring instrument.
- b. Both lines of the power mains connected to the EUT were checked for maximum conducted interference.
- c. The frequency range from 150kHz to 30MHz was searched. Emission levels under (Limit - 20dB) was not recorded.

NOTE: The resolution bandwidth and video bandwidth of test receiver is 9kHz for quasi-peak detection (QP) and average detection (AV) at frequency 0.15MHz-30MHz.

4.2.4 Deviation from Test Standard

No deviation.

4.2.5 Test Setup

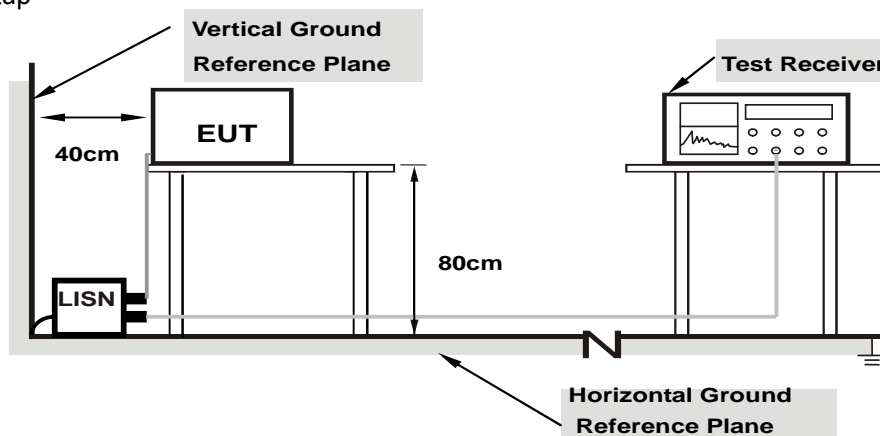

Note: 1.Support units were connected to second LISN.

For the actual test configuration, please refer to the attached file (Test Setup Photo).

4.2.6 EUT Operating Conditions

Same as 4.1.6.

4.2.7 Test Results (Mode 1)

Phase	Line (L)	Detector Function	Quasi-Peak (QP) / Average (AV)
-------	----------	-------------------	--------------------------------

No	Frequency (MHz)	Correction Factor (dB)	Reading Value (dBuV)		Emission Level (dBuV)		Limit (dBuV)		Margin (dB)	
			Q.P.	AV.	Q.P.	AV.	Q.P.	AV.	Q.P.	AV.
1	0.16953	0.08	47.40	36.51	47.48	36.59	64.98	54.98	-17.50	-18.39
2	0.22031	0.09	38.84	25.24	38.93	25.33	62.81	52.81	-23.88	-27.48
3	0.28672	0.09	34.06	21.67	34.15	21.76	60.62	50.62	-26.46	-28.85
4	0.52500	0.11	31.28	21.74	31.39	21.85	56.00	46.00	-24.61	-24.15
5	17.12891	0.63	34.16	26.30	34.79	26.93	60.00	50.00	-25.21	-23.07
6	20.52344	0.71	32.67	27.28	33.38	27.99	60.00	50.00	-26.62	-22.01

Remarks:

1. Q.P. and AV. are abbreviations of quasi-peak and average individually.
2. The emission levels of other frequencies were very low against the limit.
3. Margin value = Emission level – Limit value
4. Correction factor = Insertion loss + Cable loss
5. Emission Level = Correction Factor + Reading Value

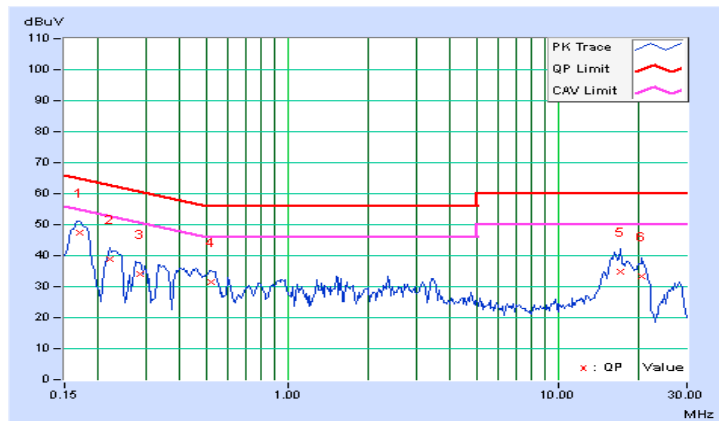

Phase	Neutral (N)	Detector Function	Quasi-Peak (QP) / Average (AV)
-------	-------------	-------------------	--------------------------------

No	Frequency (MHz)	Correction Factor (dB)	Reading Value (dBuV)		Emission Level (dBuV)		Limit (dBuV)		Margin (dB)	
			Q.P.	AV.	Q.P.	AV.	Q.P.	AV.	Q.P.	AV.
1	0.16562	0.08	48.23	37.29	48.31	37.37	65.18	55.18	-16.87	-17.81
2	0.21641	0.08	38.98	22.04	39.06	22.12	62.96	52.96	-23.89	-30.83
3	0.23203	0.08	38.25	27.31	38.33	27.39	62.38	52.38	-24.04	-24.98
4	0.52500	0.11	33.59	26.33	33.70	26.44	56.00	46.00	-22.30	-19.56
5	0.90000	0.12	30.78	19.83	30.90	19.95	56.00	46.00	-25.10	-26.05
6	16.26172	0.64	37.71	28.21	38.35	28.85	60.00	50.00	-21.65	-21.15

Remarks:

1. Q.P. and AV. are abbreviations of quasi-peak and average individually.
2. The emission levels of other frequencies were very low against the limit.
3. Margin value = Emission level – Limit value
4. Correction factor = Insertion loss + Cable loss
5. Emission Level = Correction Factor + Reading Value

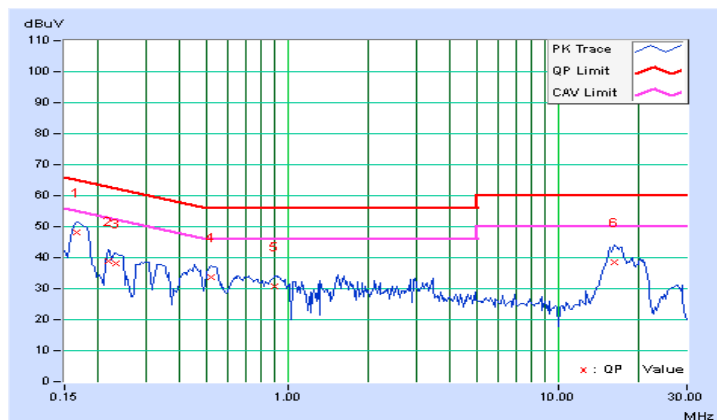

4.2.8 Test Results (Mode 2)

Phase	Line (L)	Detector Function	Quasi-Peak (QP) / Average (AV)
-------	----------	-------------------	--------------------------------

No	Frequency (MHz)	Correction Factor (dB)	Reading Value (dBuV)		Emission Level (dBuV)		Limit (dBuV)		Margin (dB)	
			Q.P.	AV.	Q.P.	AV.	Q.P.	AV.	Q.P.	AV.
1	0.16953	0.08	47.40	36.51	47.48	36.59	64.98	54.98	-17.50	-18.39
2	0.22031	0.09	38.84	25.24	38.93	25.33	62.81	52.81	-23.88	-27.48
3	0.28672	0.09	34.06	21.67	34.15	21.76	60.62	50.62	-26.46	-28.85
4	0.52500	0.11	31.28	21.74	31.39	21.85	56.00	46.00	-24.61	-24.15
5	17.12891	0.63	34.16	26.30	34.79	26.93	60.00	50.00	-25.21	-23.07
6	20.52344	0.71	32.67	27.28	33.38	27.99	60.00	50.00	-26.62	-22.01

Remarks:

1. Q.P. and AV. are abbreviations of quasi-peak and average individually.
2. The emission levels of other frequencies were very low against the limit.
3. Margin value = Emission level – Limit value
4. Correction factor = Insertion loss + Cable loss
5. Emission Level = Correction Factor + Reading Value

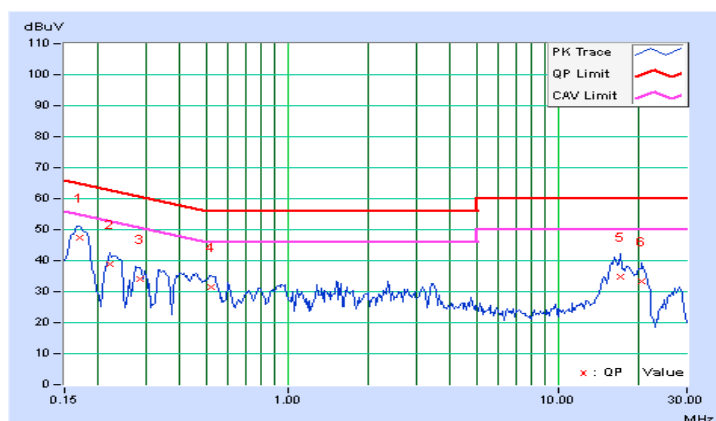

Phase	Neutral (N)	Detector Function	Quasi-Peak (QP) / Average (AV)
-------	-------------	-------------------	--------------------------------

No	Frequency (MHz)	Correction Factor (dB)	Reading Value (dBuV)		Emission Level (dBuV)		Limit (dBuV)		Margin (dB)	
			Q.P.	AV.	Q.P.	AV.	Q.P.	AV.	Q.P.	AV.
1	0.17344	0.08	51.96	42.53	52.04	42.61	64.79	54.79	-12.75	-12.18
2	0.18125	0.08	50.46	36.87	50.54	36.95	64.43	54.43	-13.89	-17.48
3	0.23203	0.08	43.33	32.85	43.41	32.93	62.38	52.38	-18.96	-19.44
4	0.28672	0.09	35.89	26.18	35.98	26.27	60.62	50.62	-24.64	-24.35
5	0.34531	0.09	32.39	20.14	32.48	20.23	59.07	49.07	-26.59	-28.84
6	15.74609	0.62	31.25	24.65	31.87	25.27	60.00	50.00	-28.13	-24.73

Remarks:

1. Q.P. and AV. are abbreviations of quasi-peak and average individually.
2. The emission levels of other frequencies were very low against the limit.
3. Margin value = Emission level – Limit value
4. Correction factor = Insertion loss + Cable loss
5. Emission Level = Correction Factor + Reading Value

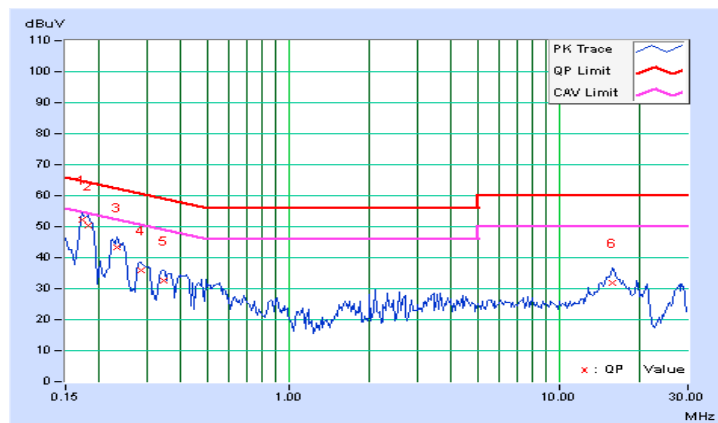

4.3 6dB Bandwidth Measurement

4.3.1 Limits of 6dB Bandwidth Measurement

The minimum of 6dB Bandwidth Measurement is 0.5 MHz.

4.3.2 Test Setup

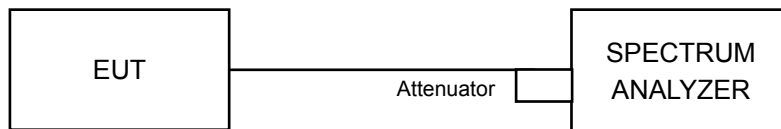

4.3.3 Test Instruments

Refer to section 4.1.2 to get information of above instrument.

4.3.4 Test Procedures

- a. Set resolution bandwidth (RBW) = 100kHz
- b. Set the video bandwidth (VBW) $\geq 3 \times$ RBW, Detector = Peak.
- c. Trace mode = max hold.
- d. Sweep = auto couple.
- e. Measure the maximum width of the emission that is constrained by the frequencies associated with the two amplitude points (upper and lower) that are attenuated by 6 dB relative to the maximum level measured in the fundamental emission

4.3.5 Deviation from Test Standard

No deviation.

4.3.6 EUT Operating Conditions

The software provided by client to enable the EUT under transmission condition continuously at lowest, middle and highest channel frequencies individually.

4.4 Conducted Output Power Measurement

4.4.1 Limits of Conducted Output Power Measurement

For systems using digital modulation in the 2400–2483.5 MHz bands: 1 Watt (30dBm)

4.4.2 Test Setup

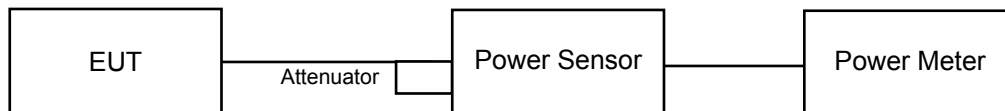

4.4.3 Test Instruments

Refer to section 4.1.2 to get information of above instrument.

4.4.4 Test Procedures

The peak / average power sensor was used on the output port of the EUT. A power meter was used to read the response of the peak / average power sensor. Record the power level.

4.4.5 Deviation from Test Standard

No deviation.

4.4.6 EUT Operating Conditions

Same as Item 4.3.6.

4.4.7 Test Results

FOR PEAK POWER

Channel	Frequency (MHz)	Peak Power (mW)	Peak Power (dBm)	Limit (dBm)	Pass/Fail
15	2425	2.78	4.44	30	Pass
20	2450	2.818	4.50	30	Pass
25	2475	2.972	4.73	30	Pass

FOR AVERAGE POWER

Channel	Frequency (MHz)	Average Power (mW)	Average Power (dBm)
15	2425	2.529	4.03
20	2450	2.63	4.20
25	2475	2.716	4.34

4.5 Power Spectral Density Measurement

4.5.1 Limits of Power Spectral Density Measurement

The Maximum of Power Spectral Density Measurement is 8dBm.

4.5.2 Test Setup

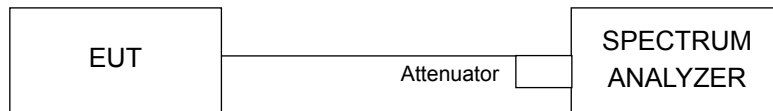

4.5.3 Test Instruments

Refer to section 4.1.2 to get information of above instrument.

4.5.4 Test Procedures

- a. Set analyzer center frequency to DTS channel center frequency.
- b. Set the span to 1.5 times the DTS bandwidth.
- c. Set the RBW to: $3 \text{ kHz} \leq \text{RBW} \leq 100 \text{ kHz}$.
- d. Set the VBW $\geq 3 \times \text{RBW}$.
- e. Detector = peak.
- f. Sweep time = auto couple.
- g. Trace mode = max hold.
- h. Allow trace to fully stabilize.
- i. Use the peak marker function to determine the maximum amplitude level within the RBW.

4.5.5 Deviation from Test Standard

No deviation.

4.5.6 EUT Operating Conditions

Same as Item 4.3.6

4.5.7 Test Results

Channel	Frequency (MHz)	PSD (dBm)	Limit (dBm)	Pass /Fail
15	2425	-11.60	8	Pass
20	2450	-12.13	8	Pass
25	2475	-12.68	8	Pass

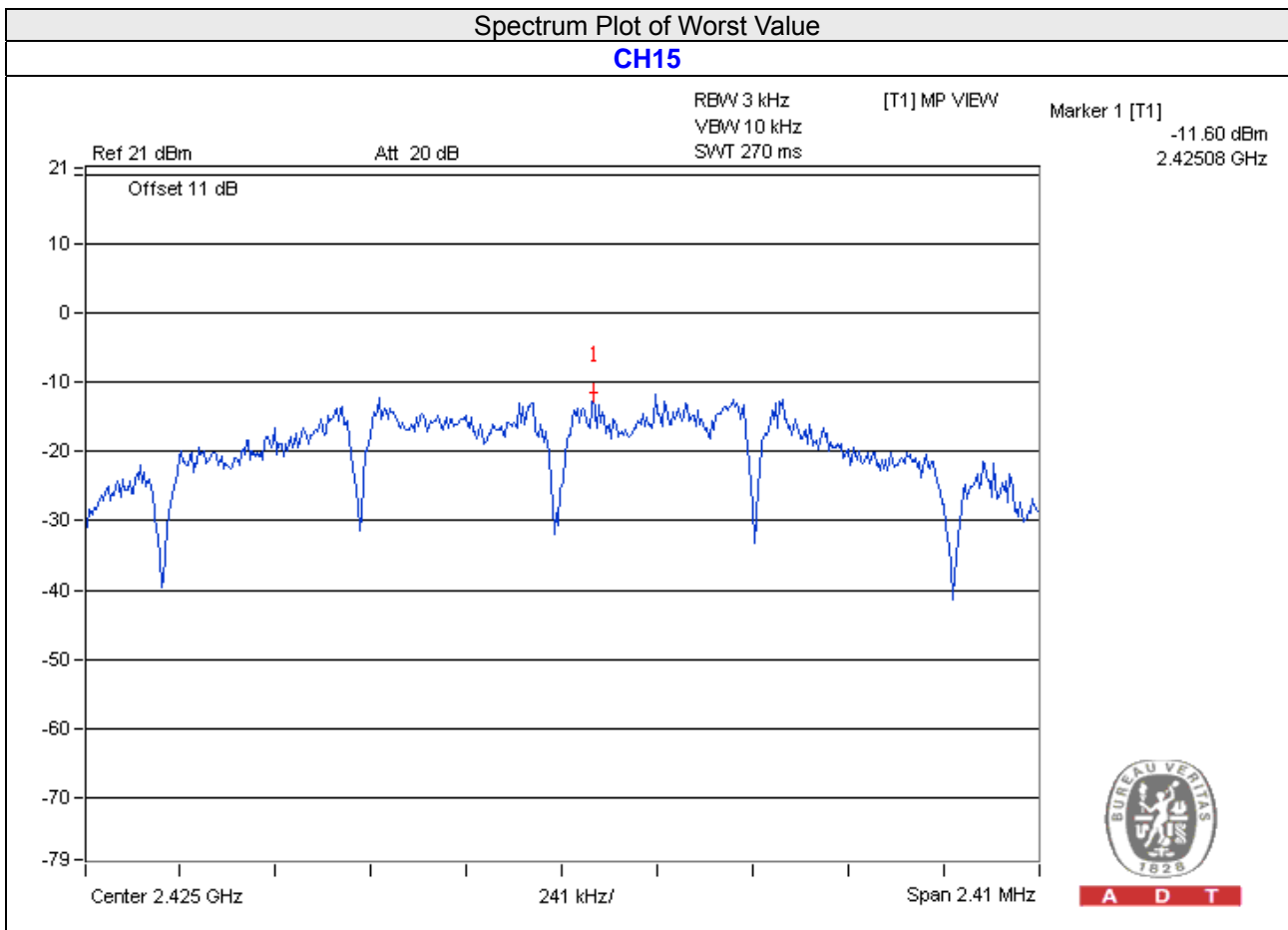

4.6 Conducted Out of Band Emission Measurement

4.6.1 Limits of Conducted Out of Band Emission Measurement

Below 20dB of the highest emission level of operating band (in 100kHz Resolution Bandwidth).

4.6.2 Test Setup

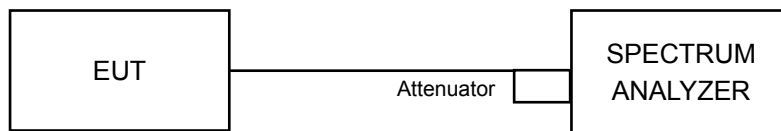

4.6.3 Test Instruments

Refer to section 4.1.2 to get information of above instrument.

4.6.4 Test Procedures

MEASUREMENT PROCEDURE REF

1. Set the RBW = 100 kHz.
2. Set the VBW \geq 300 kHz.
3. Detector = peak.
4. Sweep time = auto couple.
5. Trace mode = max hold.
6. Allow trace to fully stabilize.
7. Use the peak marker function to determine the maximum power level in any 100 kHz band segment within the fundamental EBW.

MEASUREMENT PROCEDURE OOBE

1. Set RBW = 100 kHz.
2. Set VBW \geq 300 kHz.
3. Detector = peak.
4. Sweep = auto couple.
5. Trace Mode = max hold.
6. Allow trace to fully stabilize.
7. Use the peak marker function to determine the maximum amplitude level.

4.6.5 Deviation from Test Standard

No deviation.

4.6.6 EUT Operating Conditions

Same as Item 4.3.6

4.6.7 Test Results

The spectrum plots are attached on the following pages. D1 line indicates the highest level, and D2 line indicates the 20dB offset below D1. It shows compliance with the requirement.

CH 15

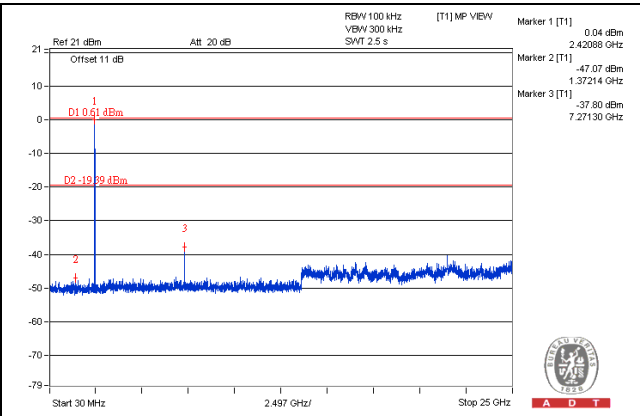
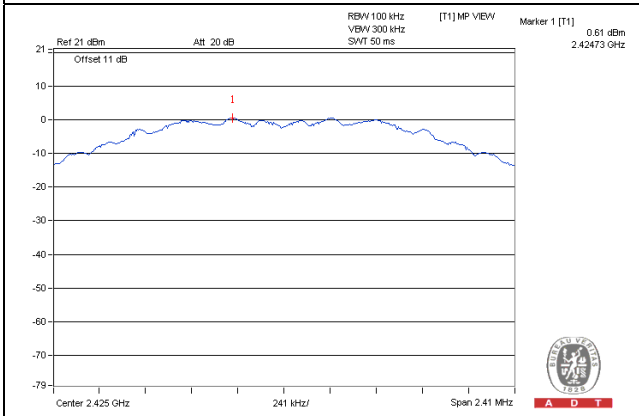

CH 20

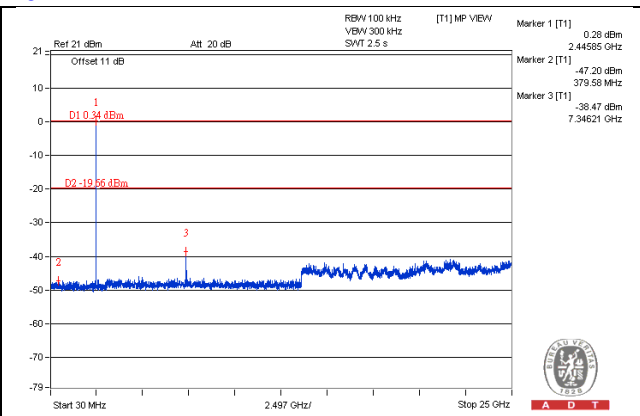
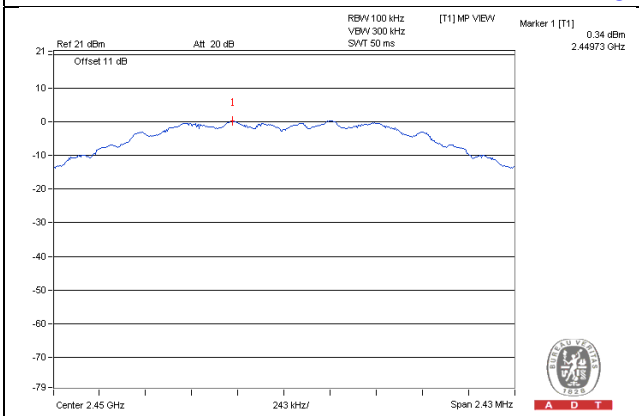

CH 25

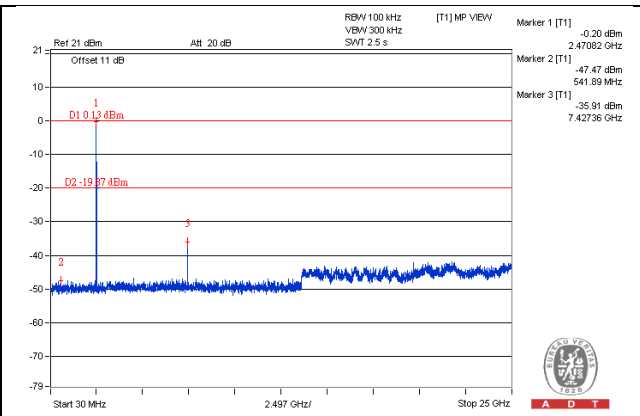
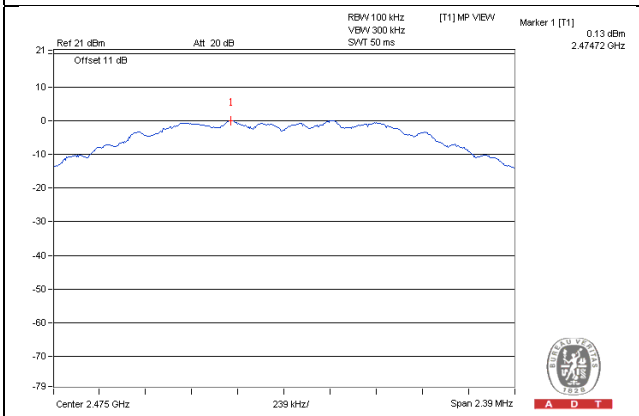

CH 15 Band edge

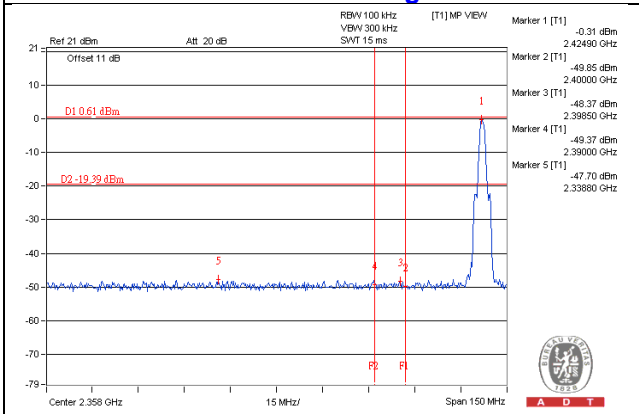

CH 25 Band edge

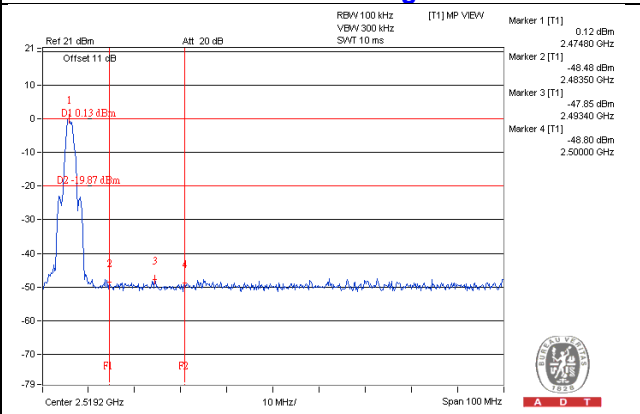



5 Pictures of Test Arrangements

Please refer to the attached file (Test Setup Photo).



Appendix – Information on the Testing Laboratories

We, Bureau Veritas Consumer Products Services (H.K.) Ltd., Taoyuan Branch, were founded in 1988 to provide our best service in EMC, Radio, Telecom and Safety consultation. Our laboratories are accredited and approved according to ISO/IEC 17025.

If you have any comments, please feel free to contact us at the following:

Linko EMC/RF Lab

Tel: 886-2-26052180

Fax: 886-2-26051924

Hsin Chu EMC/RF/Telecom Lab

Tel: 886-3-5935343

Fax: 886-3-5935342

Hwa Ya EMC/RF/Safety Lab

Tel: 886-3-3183232

Fax: 886-3-3270892

Email: service.adt@tw.bureauveritas.com

Web Site: www.bureauveritas-adt.com

The address and road map of all our labs can be found in our web site also.

--- END ---