

Quick Start Guide



Cisco WAP571E Wireless-AC/N Premium Dual Radio Outdoor Access Point

Welcome

Thank you for choosing the Cisco WAP571E Wireless-AC/N Premium Dual Radio Outdoor Access Point. The Cisco WAP571E is an outdoor dual radio 802.11ac + 802.11n access point.

This guide is designed to familiarize you with the general layout of the access point, describe how to deploy the device in your network, and describe how to configure the device. Your access point has more features and functionality than what is described in this guide. For additional information, see the Administration Guide. A link to the Administration Guide is found in [Where to Go From Here](#).

Package Contents

- Wireless Access Point
- Mounting kit
- This Quick Start Guide
- Ethernet cable
- Pointer Card with China RoHS
- Technical Support Contacts
- EU Directives 1999/5/EC Compliance Information (for EU SKU only)

1

Before You Begin

Before you begin the installation, make sure that you have the following equipment and services:

- A computer with browser support for:
 - Internet Explorer v7.0 or later
 - Chrome v5.0 or later
 - Firefox v3.0 or later
 - Safari v3.0 or later
- Tools for installing the hardware
- One or more Ethernet network switches with PoE

Front Panel

The front panel of the device consists of a single system LED. For a full description of the colors of the light and its indications, see [Verifying the Hardware Installation](#).

A Kensington lock slot is found under the lights.

Back Panel

The back panel of the device has a water proof RJ-45 Ethernet port and reset bottom. Facing the side of the device, the right port (labeled "ETH0/PD") is an 802.3at and 802.3af Power over Ethernet (PoE) port which is used to power your device. The left port (labeled "ETH1") is a general Gigabit Ethernet LAN interface. Both are auto-sensing, Gigabit Ethernet (802.3) ports used to connect your WAP devices to network devices, such as computers, routers, or switches. We strongly recommend that you use a Category 5e or better cable for Gigabit connectivity.

Side Panel

The side panel of the device has a Reset button at right. See [Rebooting the Devices or Returning them to their Factory Default Settings](#) for information on the Reset button.

Default Setting

Parameter	Default Value
Username	cisco
Password	cisco
LAN IP Address	DHCP address assigned by server
Fallback LAN IP	192.168.1.245
Subnetwork Mask	255.255.255.0

If you are using a Cisco RV Series router, the default range for the DHCP assigned address is from 192.168.1.100 to 192.168.1.254. Any device connecting to the same LAN will be assigned an IP address in this range.

If your network does not have an existing DHCP server, the WAP571E will start a DHCP server for WLAN stations and stop the DHCP client when WAP571E is in factory default. The DHCP server will assign the IP address from 192.168.1.20 to 192.168.1.100.

3

Mounting the Cisco WAP571E Wireless-AC/N Premium Dual Radio Outdoor Access Point

You can place your access point at an outdoor location and mount it on a wall or pole.

Placement Tips

- **Ambient Temperature**—To prevent the access point from overheating, do not operate it in an area that exceeds an ambient temperature of 122°F (55°C).
- **Mechanical Loading**—The device should be level, stable, and secure to prevent it from sliding or shifting out of position.

Wall and Pole Mounting

The Cisco WAP571E device can be wall or pole-mounted. A mounting kit is packaged with your device. The kit is designed to install your device to the wall or a pole.

The outdoor model includes an adjustable bracket to mount on a flat vertical surface. Adjustments can be made in up/down, left/right direction for signal optimization. Pole-mount allows for mounting to small pole (3" diameter max) and is also adjustable.

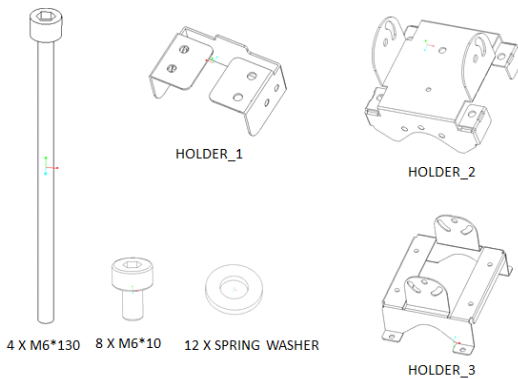

**WARNING**

Insecure mounting might damage the device or cause injury. Cisco is not responsible for damages incurred by insecure wall or pole mounting.

Pole-mounting: To mount the Cisco WAP 571E device on a pole:

STEP 1 Fix Holder_1 and GND wire on WAP571E by 4 M6*10 screws and screw washers. GND wire can provide better ESD protection.

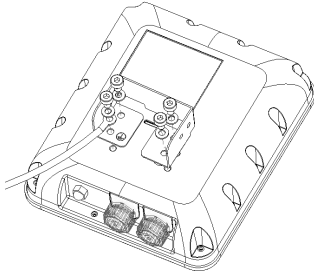

STEP 2 Fix Holder_2 and Holder_3 on Pole by 4 M6*130 screws and screw washers.

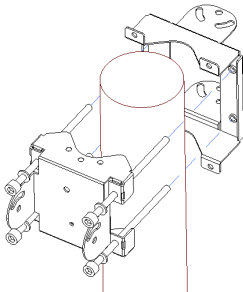

STEP 3 Fix WAP571E and Holder_1 to Holder_2 by 4 M6*10 Screws and screw washers.

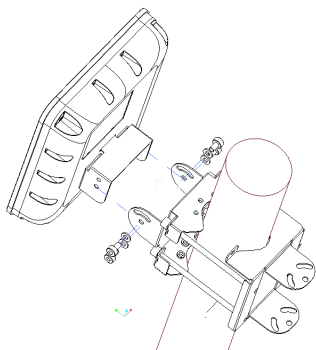

Wall-mounting: To mount the Cisco WAP 571E device on a wall:

STEP 1 Fix Holder_1 and GND wire on WAP571E by 4 M6*10 screws and screw washers. GND wire can provide better ESD protection.

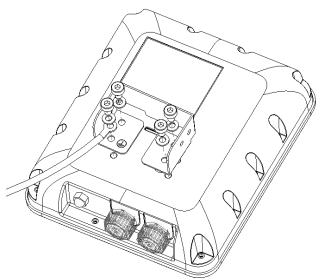

STEP 2 Fix HOLDER_3 on wall by 4 anchors.

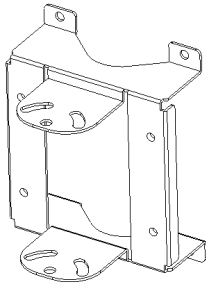

STEP 3 Fix Holder_2 and Holder_3 by 4 M6*10 screws and screw washers.

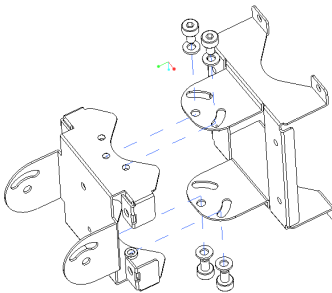

STEP 4 Fix WAP571E and Holder_1 to Holder_2 by 4 M6*10 Screws and screw washers.

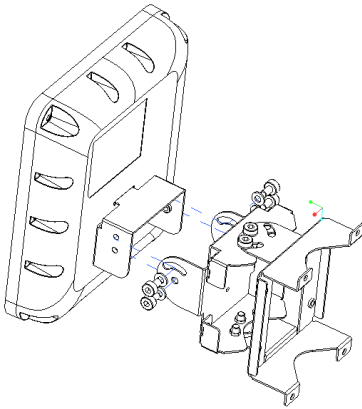

4

Connecting the Cisco WAP571E Wireless-AC/N Premium Dual Radio Outdoor Access Point

You can perform the initial configuration using either a wired or wireless connection. The default configuration of the WAP 571 has the Wi-Fi radio turned on.

To connect the WAP 571E to the wired network:

STEP 1 Connect the Ethernet cable to the Ethernet port of a PoE switch.

STEP 2 Connect the other end of the network Ethernet cable to the Ethernet port (PoE) of the wireless access point.

NOTE WAP571E bundles the two Ethernet ports to be link aggregation mode. If the two Ethernet ports have been connected at the same time, the link partner must also support link aggregation.

This wireless default configuration will not allow traffic between WiFi and Ethernet; users will need to go through the setup wizard to resume the traffic between WiFi and Ethernet.

To connect the WAP 571E to the network wirelessly:

STEP 1 Use wireless clients to locate the WAP571E's SSID (CiscoSB-Setup).

STEP 2 Use the 'cisco123' passkey to access the access point.

NOTE The system provides a one-time-only access to configure the access point using a wireless connection.

After installation, all lights should be active. Refer to [Verifying the Hardware Installation](#) for details about the different lights on the WAP 571E.

5

Verifying the Hardware Installation

To verify the hardware installation, complete the following tasks:

- Check the cable connections.
- Check the state of the indicator lights.

Label	Activity	Description
Power	Off	The WAP571E is out of power.
	Solid (Green)	The Cisco WAP571E is normal; no wireless client connected.
	Solid (Blue)	The Cisco WAP571E is normal; at least one wireless client connected.
	Flashing (Blue)	The Cisco WAP571E is upgrading the firmware.
	Solid (Red)	The Cisco WAP571E fails to boot with both firmware images.

NOTE If you need help resolving a problem, visit the Cisco Support Community at www.cisco.com/go/smallbizsupport.

To configure the wireless access points, you can either use Ethernet or wireless. Please follow these steps to access the Wizard and then the web-based configuration utility from your computer by Ethernet:

STEP 1 Ethernet: Connect the wireless access point to the same network (IP subnet) as your computer. The factory default IP address configuration of the access points is DHCP. Make sure your DHCP server is running and can be reached.

See **Incorrect IP Address** for troubleshooting information, or if you do not have a DHCP server.

Wireless: Search the wireless SSID "CiscoSB-Setup", and connect to this SSID with the passphrase "cisco123".

STEP 2 Locate the IP address of the wireless access point.

- a. The wireless access points can be accessed and managed by Cisco network tools and services including the Cisco FindIT Network Discovery Utility that enables you to automatically discover all supported Cisco devices in the same local network segment as your computer. You can get a snapshot view of each device or launch the product configuration utility to view and configure the settings. For more information, see www.cisco.com/go/findit.
- b. The wireless access points are Bonjour-enabled and automatically broadcast their services and listen for services being advertised by other Bonjour-enabled devices. If you have a Bonjour-enabled browser, such as Microsoft Internet Explorer with a Bonjour plug-in, or the Apple Mac Safari browser, you can find the wireless access point on your local network without knowing its IP address.

You can download the complete Bonjour for Microsoft Internet Explorer browser from Apple's website by visiting: <http://www.apple.com/bonjour/>

- c. Locate the IP address assigned by your DHCP server by accessing your router or DHCP server. See your DHCP server instructions for more information.

STEP 3 Launch a web browser, such as Microsoft Internet Explorer or Mozilla Firefox.

STEP 4 In the Address field, enter the default DHCP address and press the **Enter** key.

- STEP 5** Enter the default user name of cisco and password of cisco in the User Name and Password fields.
- STEP 6** Click Login. The Wireless Access Point Setup Wizard appears.
- STEP 7** Follow the Setup Wizard instructions to finish the WAP device installation. We strongly recommend that you use the Setup Wizard for the first installation. The Setup Wizard turns on the Wi-Fi radio, which allows you to connect wirelessly. For more advanced configurations, see the Administration Guide. A link to the Administration Guide is found in **Where to Go From Here**.
- Congratulations, you can now start using your wireless access point.
-

7

Suggested Next Steps

Smart PoE

Smart PoE is designed for detecting the power level from the PSE (Power Sourcing Equipment) side; it does not matter whether 802.3at or 802.3af mode, the WAP571 will operate at the appropriate mode automatically.

Smart PoE ensures that the WAP571E remains functional once powered by 802.3af PSE, and intelligently to adjust operations below:

- Second Ethernet port disabled
- 2.4-GHz 802.11n radio in 2x2:2 spatial-stream mode
- 5-GHz 802.11ac radio operates without restrictions

In case of an error while installing, try the following troubleshooting procedures described in this section:

Troubleshooting

If you cannot display the configuration utility, you can test the ability of the computer to communicate with the device by using **ping**.

To use **ping** on a computer running Windows:

-
- STEP 1** Verify that the Cisco WAP571E is powered on and the lights indicate the appropriate links.
- STEP 2** Locate the device's IP address. While there are different ways to locate your device's IP address, this procedure uses Cisco FindIT.
- a. If you have previously downloaded Cisco FindIT, open Internet Explorer and launch Cisco FindIT. For more information on downloading Cisco FindIT, see www.cisco.com/go/findit.
 - b. In the Cisco FindIT display, place your mouse over the device's name. The device IP address is displayed along with other device information.
- STEP 3** Open a command window by choosing **Start > Run** and enter **cmd**.
- STEP 4** At the **command** window prompt, enter **ping** and the device IP address. In this example, we **pinged 192.0.2.10**.

If successful, you should get a reply similar to the following:

```
Pinging 192.0.2.10 with 32 bytes of data:  
Reply from 192.0.2.10: bytes=32 time<1ms TTL=128
```

If it fails, you should get a reply similar to the following:

```
Pinging 192.0.2.10 with 32 bytes of data:  
Request timed out.
```

Possible Cause of Installation Failure

No Power

- Power up the switch and your computer if they are turned off.
- Make sure your PoE switch is powered on and the lights indicate that you have a link. See [Verifying the Hardware Installation](#).
- Verify that the devices on your network are not plugged into a switchable outlet.

Bad Ethernet Connection

- Check the state of the indicator lights. See [Verifying the Hardware Installation](#).
- Check the Ethernet cable to ensure that it is firmly connected to your devices. Devices connected by the Ethernet cable can include the WAP device, and routers, any switches, and your computer.
- Verify the connected switch has auto-negotiation enabled. The access point and the switch need the same negotiation parameters set.

Bad Image

After a new firmware installation, if the Power light is solid red, contact system support; see [Where to Go From Here](#).

Incorrect IP Address

The most likely cause of connectivity failure is an incorrect IP address. The Web browser may be pointing to the wrong IP address, or your computer may be configured with an IP address that is not in the same subnet as the device.

Because the factory default IP address configuration is DHCP, make sure that your DHCP server is running and can be reached. You may need to disconnect and reconnect the devices for them to discover their new IP addresses from the DHCP server. You can then query the DHCP server for the new IP address. See [Step 2 of Getting Started with the Configuration](#) for more information on how to find the DHCP address.

If the wireless access points do not receive a DHCP response (there is no DHCP server on your network) after 60 seconds, the access points will fallback to the following default static IP address: 192.168.1.245 and a default mask of 255.255.255.0. To reach that IP address, be sure that your computer is on the 192.168.1.xxx network.

8

Rebooting the Devices or Returning them to their Factory Default Settings

To reboot your device:

- The Cisco WAP571 uses PoE power supply; unplug your Ethernet connection and plug it back in.
or
- With the power on, press the Reset button with an opened paper clip for less than three seconds, or until the lights go off.
 - Release the Reset button as soon as the lights go off, or you will restore the device to factory default settings and lose your configurations.
 - Release the Reset button when the system light turns on.

To reset the device to factory default settings:

- With the power on, press and hold the Reset button with an opened paper clip for more than 10 seconds. The system light will go off.

Where to Go From Here

Support	
Cisco Support Community	www.cisco.com/go/smallbizsupport
Cisco Support and Resources	www.cisco.com/go/smallbizhelp
Phone Support Contacts	www.cisco.com/en/US/support/tsd_cisco_small_business_support_center_contacts.html

Cisco Firmware Downloads	www.cisco.com/go/smallbizfirmware Select a link to download firmware for Cisco Products. No login is required.
Cisco Open Source Requests	www.cisco.com/go/smallbiz_opensource_request
Cisco Partner Central (Partner Login Required)	www.cisco.com/web/partners/sell/smb
Product Documentation	
Cisco WAP571E Administration Guide	www.cisco.com/go/300_wap_resources
Cisco Power Adapters	www.cisco.com/go/wap_accessories

For EU lot 26 related test result, please check this web page:
www.cisco.com/go/eu-lot26-results.

Americas Headquarters

Cisco Systems, Inc.
www.cisco.com



Cisco has more than 200 offices worldwide. Addresses, phone numbers, and fax numbers are listed on the Cisco website at www.cisco.com/go/offices.

78-100813-01 A0

Cisco and the Cisco logo are trademarks or registered trademarks of Cisco and/or its affiliates in the U.S. and other countries. To view a list of Cisco trademarks, go to this URL: www.cisco.com/go/trademarks. Third-party trademarks mentioned are the property of their respective owners. The use of the word partner does not imply a partnership relationship between Cisco and any other company. (1110R)

© 2015 Cisco Systems, Inc. All rights reserved.



Regulatory Compliance and Safety Information for the Cisco WAP571/571E Wireless Access Point (EMC Class B Devices)

This document provides domestic and international regulatory compliance and safety information for the Cisco WAP571/571E Wireless Access Point EMC Class B Devices.

Use this document in conjunction with the documentation available online for the Wireless Access Points.

This document includes the following sections:

- [Translated Safety Warnings, page 1](#)
- [Product Usage Restrictions, page 22](#)
- [Declaration of Conformity Statements, page 22](#)
- [European Directives, page 22](#)
- [EU Battery Disposal and Recycling, page 24](#)
- [Standards Compliance, page 24](#)
- [EMC Class B Notices and Warnings, page 25](#)
- [Japanese Electric Appliance and Radio Laws, page 28](#)
- [Radio, page 28](#)
- [Canadian Radio Warning Statement, page 28](#)
- [Generic Discussion on RF Exposure, page 31](#)
- [Obtaining Documentation and Submitting a Service Request, page 32](#)

Translated Safety Warnings

This section includes translations in multiple languages of the warnings that may appear in your product documents.

- [Statement 1071—Warning Definition](#)



- [Statement 1—Power Disconnection Warning](#)
- [Statement 248—Unit Mounting Warning](#)
- [Statement 1004—Installation Instructions](#)
- [Statement 1005—Circuit Breaker](#)
- [Statement 1040—Product Disposal](#)
- [Statement 1044—Port Connections](#)
- [Statement 1072—Shock Hazard from Interconnections](#)
- [Statement 1073—No User-Serviceable Parts](#)
- [Statement 1074—Comply with Local and National Electrical Codes](#)

Statement 1071—Warning Definition



Warning

IMPORTANT SAFETY INSTRUCTIONS

This warning symbol means danger. You are in a situation that could cause bodily injury. Before you work on any equipment, be aware of the hazards involved with electrical circuitry and be familiar with standard practices for preventing accidents. Use the statement number provided at the end of each warning to locate its translation in the translated safety warnings that accompanied this device. Statement 1071

SAVE THESE INSTRUCTIONS

Waarschuwing

BELANGRIJKE VEILIGHEIDSINSTRUCTIES

Dit waarschuwingssymbool betekent gevaar. U verkeert in een situatie die lichamelijk letsel kan veroorzaken. Voordat u aan enige apparatuur gaat werken, dient u zich bewust te zijn van de bij elektrische schakelingen betrokken risico's en dient u op de hoogte te zijn van de standaard praktijken om ongelukken te voorkomen. Gebruik het nummer van de verklaring onderaan de waarschuwing als u een vertaling van de waarschuwing die bij het apparaat wordt geleverd, wilt raadplegen.

BEWAAR DEZE INSTRUCTIES

Varoitus

TÄRKEITÄ TURVALLISUUSOHJEITA

Tämä varoitusmerkki merkitsee vaaraa. Tilanne voi aiheuttaa ruumiillisia vammoja. Ennen kuin käsittelet laitteistoa, huomioi sähköpiirien käsittelyyn liittyvät riskit ja tutustu onnettomuuksien yleisiin ehkäisytapoihin. Turvallisuusvaroitusten käännökset löytyvät laitteen mukana toimitettujen käännettyjen turvallisuusvaroitusten joukosta varoitusten lopussa näkyvien lausuntonumeroiden avulla.

SÄILYTÄ NÄMÄ OHJEET

Attention IMPORTANTES INFORMATIONS DE SÉCURITÉ

Ce symbole d'avertissement indique un danger. Vous vous trouvez dans une situation pouvant entraîner des blessures ou des dommages corporels. Avant de travailler sur un équipement, soyez conscient des dangers liés aux circuits électriques et familiarisez-vous avec les procédures couramment utilisées pour éviter les accidents. Pour prendre connaissance des traductions des avertissements figurant dans les consignes de sécurité traduites qui accompagnent cet appareil, référez-vous au numéro de l'instruction situé à la fin de chaque avertissement.

CONSERVEZ CES INFORMATIONS

Warnung WICHTIGE SICHERHEITSHINWEISE

Dieses Warnsymbol bedeutet Gefahr. Sie befinden sich in einer Situation, die zu Verletzungen führen kann. Machen Sie sich vor der Arbeit mit Geräten mit den Gefahren elektrischer Schaltungen und den üblichen Verfahren zur Vorbeugung vor Unfällen vertraut. Suchen Sie mit der am Ende jeder Warnung angegebenen Anweisungsnummer nach der jeweiligen Übersetzung in den übersetzten Sicherheitshinweisen, die zusammen mit diesem Gerät ausgeliefert wurden.

BEWAHREN SIE DIESE HINWEISE GUT AUF.

Avvertenza IMPORTANTI ISTRUZIONI SULLA SICUREZZA

Questo simbolo di avvertenza indica un pericolo. La situazione potrebbe causare infortuni alle persone. Prima di intervenire su qualsiasi apparecchiatura, occorre essere al corrente dei pericoli relativi ai circuiti elettrici e conoscere le procedure standard per la prevenzione di incidenti. Utilizzare il numero di istruzione presente alla fine di ciascuna avvertenza per individuare le traduzioni delle avvertenze riportate in questo documento.

CONSERVARE QUESTE ISTRUZIONI

Advarsel VIKTIGE SIKKERHETSINSTRUKSJONER

Dette advarselssymbolet betyr fare. Du er i en situasjon som kan føre til skade på person. Før du begynner å arbeide med noe av utstyret, må du være oppmerksom på farene forbundet med elektriske kretser, og kjenne til standardprosedyrer for å forhindre ulykker. Bruk nummeret i slutten av hver advarsel for å finne oversettelsen i de oversatte sikkerhetsadvarslene som fulgte med denne enheten.

TA VARE PÅ DISSE INSTRUKSJONENE

Aviso INSTRUÇÕES IMPORTANTES DE SEGURANÇA

Este símbolo de aviso significa perigo. Você está em uma situação que poderá ser causadora de lesões corporais. Antes de iniciar a utilização de qualquer equipamento, tenha conhecimento dos perigos envolvidos no manuseio de circuitos elétricos e familiarize-se com as práticas habituais de prevenção de acidentes. Utilize o número da instrução fornecido ao final de cada aviso para localizar sua tradução nos avisos de segurança traduzidos que acompanham este dispositivo.

GUARDE ESTAS INSTRUÇÕES

¡Advertencia! INSTRUCCIONES IMPORTANTES DE SEGURIDAD

Este símbolo de aviso indica peligro. Existe riesgo para su integridad física. Antes de manipular cualquier equipo, considere los riesgos de la corriente eléctrica y familiarícese con los procedimientos estándar de prevención de accidentes. Al final de cada advertencia encontrará el número que le ayudará a encontrar el texto traducido en el apartado de traducciones que acompaña a este dispositivo.

GUARDE ESTAS INSTRUCCIONES**Varning! VIKTIGA SÄKERHETSANVISNINGAR**

Denna varningssignal signalerar fara. Du befinner dig i en situation som kan leda till personskada. Innan du utför arbete på någon utrustning måste du vara medveten om farorna med elkretsar och känna till vanliga förfaranden för att förebygga olyckor. Använd det nummer som finns i slutet av varje varning för att hitta dess översättning i de översatta säkerhetsvarningar som medföljer denna anordning.

SPARA DESSA ANVISNINGAR**FONTOS BIZTONSÁGI ELOÍRÁSOK**

Ez a figyelmeztető jel veszélyre utal. Sérülésveszélyt rejtő helyzetben van. Mielőtt bármely berendezésen munkát végezte, legyen figyelemmel az elektromos áramkörök okozta kockázatokra, és ismerkedjen meg a szokásos balesetvédelmi eljárásokkal. A kiadványban szereplő figyelmeztetések fordítása a készülékhez mellékelte biztonsági figyelmeztetések között található; a fordítás az egyes figyelmeztetések végén látható szám alapján kereshető meg.

ORIZZE MEG EZEKET AZ UTASÍTÁSOKAT!**Предупреждение ВАЖНЫЕ ИНСТРУКЦИИ ПО СОБЛЮДЕНИЮ ТЕХНИКИ БЕЗОПАСНОСТИ**

Этот символ предупреждения обозначает опасность. То есть имеет место ситуация, в которой следует опасаться телесных повреждений. Перед эксплуатацией оборудования выясните, каким опасностям может подвергаться пользователь при использовании электрических цепей, и ознакомьтесь с правилами техники безопасности для предотвращения возможных несчастных случаев. Воспользуйтесь номером заявления, приведенным в конце каждого предупреждения, чтобы найти его переведенный вариант в переводе предупреждений по безопасности, прилагаемом к данному устройству.

СОХРАНИТЕ ЭТИ ИНСТРУКЦИИ**警告 重要的安全性说明**

此警告符号代表危险。您正处于可能受到严重伤害的工作环境中。在您使用设备开始工作之前，必须充分意识到触电的危险，并熟练掌握防止事故发生的标准工作程序。请根据每项警告结尾提供的声明号码来找到此设备的安全性警告说明的翻译文本。

请保存这些安全性说明

警告 安全上の重要な注意事項

「危険」の意味です。人身事故を予防するための注意事項が記述されています。装置の取り扱い作業を行うときは、電気回路の危険性に注意し、一般的な事故防止策に留意してください。警告の各国語版は、各注意事項の番号を基に、装置に付属の「Translated Safety Warnings」を参照してください。

これらの注意事項を保管しておいてください。

주의 중요 안전 지침

이 경고 기호는 위험을 나타냅니다. 작업자가 신체 부상을 일으킬 수 있는 위험한 환경에 있습니다. 장비에 작업을 수행하기 전에 전기 회로와 관련된 위험을 숙지하고 표준 작업 관례를 숙지하여 사고를 방지하십시오. 각 경고의 마지막 부분에 있는 경고문 번호를 참조하여 이 장치와 함께 제공되는 번역된 안전 경고문에서 해당 번역문을 찾으십시오.

이 지시 사항을 보관하십시오.

Aviso INSTRUÇÕES IMPORTANTES DE SEGURANÇA

Este símbolo de aviso significa perigo. Você se encontra em uma situação em que há risco de lesões corporais. Antes de trabalhar com qualquer equipamento, esteja ciente dos riscos que envolvem os circuitos elétricos e familiarize-se com as práticas padrão de prevenção de acidentes. Use o número da declaração fornecido ao final de cada aviso para localizar sua tradução nos avisos de segurança traduzidos que acompanham o dispositivo.

GUARDE ESTAS INSTRUÇÕES**Advarsel** VIGTIGE SIKKERHEDSANVISNINGER

Dette advarselssymbol betyder fare. Du befinder dig i en situation med risiko for legemeskadedigelse. Før du begynder arbejde på udstyr, skal du være opmærksom på de involverede risici, der er ved elektriske kredsløb, og du skal sætte dig ind i standardprocedurer til undgåelse af ulykker. Brug erklæringsnummeret efter hver advarsel for at finde oversættelsen i de oversatte advarsler, der fulgte med denne enhed.

GEM DISSE ANVISNINGER**تحذير****إرشادات الأمان الهامة**

يوضح رمز التحذير هذا وجود خطر. وهذا يعني أنك متواجد في مكان قد ينتج عنه التعرض لإصابات. قبل بدء العمل، احذر مخاطر التعرض للصدمات الكهربائية وكن على علم بالإجراءات القياسية للحيولة دون وقوع أي حوادث. استخدم رقم البيان الموجود في آخر كل تحذير لتحديد مكان ترجمته داخل تحذيرات الأمان المترجمة التي تأتي مع الجهاز. قم بحفظ هذه الإرشادات

Upozorenje VAŽNE SIGURNOSNE NAPOMENE

Ovaj simbol upozorenja predstavlja opasnost. Nalazite se u situaciji koja može prouzročiti tjelesne ozljede. Prije rada s bilo kojim uređajem, morate razumjeti opasnosti vezane uz električne sklopove, te biti upoznati sa standardnim načinima izbjegavanja nesreća. U prevedenim sigurnosnim upozorenjima, priloženima uz uređaj, možete prema broju koji se nalazi uz pojedino upozorenje pronaći i njegov prijevod.

SAČUVAJTE OVE UPUTE**Upozornění DŮLEŽITÉ BEZPEČNOSTNÍ POKYNY**

Tento upozorňující symbol označuje nebezpečí. Jste v situaci, která by mohla způsobit nebezpečí úrazu. Před prací na jakémkoliv vybavení si uvědomte nebezpečí související s elektrickými obvody a seznamte se se standardními opatřeními pro předcházení úrazům. Podle čísla na konci každého upozornění vyhledejte jeho překlad v přeložených bezpečnostních upozorněních, která jsou přiložena k zařízení.

USCHOVEJTE TYTO POKYNY**Προειδοποίηση ΣΗΜΑΝΤΙΚΕΣ ΟΔΗΓΙΕΣ ΑΣΦΑΛΕΙΑΣ**

Αυτό το προειδοποιητικό σύμβολο σημαίνει κίνδυνο. Βρίσκεστε σε κατάσταση που μπορεί να προκαλέσει τραυματισμό. Πριν εργαστείτε σε οποιοδήποτε εξοπλισμό, να έχετε υπόψη σας τους κινδύνους που σχετίζονται με τα ηλεκτρικά κυκλώματα και να έχετε εξοικειωθεί με τις συνήθειες πρακτικές για την αποφυγή ατυχημάτων. Χρησιμοποιήστε τον αριθμό δήλωσης που παρέχεται στο τέλος κάθε προειδοποίησης, για να εντοπίσετε τη μετάφρασή της στις μεταφρασμένες προειδοποιήσεις ασφαλείας που συνοδεύουν τη συσκευή.

ΦΥΛΑΞΤΕ ΑΥΤΕΣ ΤΙΣ ΟΔΗΓΙΕΣ

אזהרה

ВАЖНИ БЕЗБЕДНОСНИ НАПАТСТВИЈА

Симболот за предупредување значи опасност. Се наоѓате во ситуација што може да предизвика телесни повреди. Пред да работите со опремата, бидете свесни за ризикот што постои кај електричните кола и треба да ги познавате стандардните постапки за спречување на несреќни случаи. Искористете го бројот на изјавата што се наоѓа на крајот на секое предупредување за да го најдете неговиот период во преведените безбедносни предупредувања што се испорачани со уредот.

ЧУВАЈТЕ ГИ ОБИЕ НАПАТСТВИЈА

Ostrzeżenie WAŻNE INSTRUKCJE DOTYCZĄCE BEZPIECZEŃSTWA

Ten symbol ostrzeżenia oznacza niebezpieczeństwo. Zachodzi sytuacja, która może powodować obrażenia ciała. Przed przystąpieniem do prac przy urządzeniach należy zapoznać się z zagrożeniami związanymi z układami elektrycznymi oraz ze standardowymi środkami zapobiegania wypadkom. Na końcu każdego ostrzeżenia podano numer, na podstawie którego można odszukać tłumaczenie tego ostrzeżenia w dołączonym do urządzenia dokumencie z tłumaczeniami ostrzeżeń.

NINIEJSZE INSTRUKCJE NALEŻY ZACHOWAĆ**Upozornenie DÔLEŽITÉ BEZPEČNOSTNÉ POKYNY**

Tento varovný symbol označuje nebezpečenstvo. Nachádzate sa v situácii s nebezpečenstvom úrazu. Pred prácou na akomkoľvek vybavení si uvedomte nebezpečenstvo súvisiace s elektrickými obvodmi a oboznámte sa so štandardnými opatreniami na predchádzanie úrazom. Podľa čísla na konci každého upozornenia vyhľadajte jeho preklad v preložených bezpečnostných upozorneniach, ktoré sú priložené k zariadeniu.

USCHOVAJTE SI TENTO NÁVOD**Opozorilo**

警告 重要安全性指示
此警告符號代表危險，表示可能造成人身傷害。使用任何設備前，請留心電路相關危險，並熟悉避免意外的標準作法。您可以使用每項警告後的聲明編號，查詢本裝置隨附之安全性警告譯文中的翻譯。請妥善保留此指示

Statement 1—Power Disconnection Warning

**Warning**

Before working on a system that has an on/off switch, turn OFF the power and unplug the power cord.

Waarschuwing

Voordat u aan een systeem werkt dat een aan/uit schakelaar heeft, dient u de stroomvoorziening UIT te schakelen en de stekker van het netsnoer uit het stopcontact te halen.

Varoitus	Ennen kuin teet mitään sellaiselle järjestelmälle, jossa on kaksiasentokytkin, katkaise siitä virta ja kytke virtajohto irti.
Attention	Avant de travailler sur un système équipé d'un commutateur marche-arrêt, mettre l'appareil à l'arrêt (OFF) et débrancher le cordon d'alimentation.
Warnung	Bevor Sie an einem System mit Ein/Aus-Schalter arbeiten, schalten Sie das System AUS und ziehen das Netzkabel aus der Steckdose.
Avvertenza	Prima di lavorare su un sistema dotato di un interruttore on/off, spegnere (OFF) il sistema e staccare il cavo dell'alimentazione.
Advarsel	Slå AV strømmen og trekk ut strømledningen før det utføres arbeid på et system som er utstyrt med en av/på-bryter.
Aviso	Antes de começar a trabalhar num sistema que tem um interruptor on/off, DESLIGUE a corrente eléctrica e retire o cabo de alimentação da tomada.
¡Advertencia!	Antes de utilizar cualquier sistema equipado con interruptor de Encendido/Apagado (ON/OFF), cortar la alimentación y desenchufar el cable de alimentación.
Varning!	Slå AV strömmen och dra ur nätsladden innan du utför arbete på ett system med strömbrytare.
Figyelem	Ha olyan készüléken dolgozik, amelynek van ki/bekapcsoló gombja, kapcsolja KI a készüléket, és húzza ki a tápkábelt.
Предупреждение	100BaseFX 单模式监督引擎模块的孔径端口有可能发出不可见的激光辐射。请避免接触，且不要向敞开的孔径内直视。
警告	在操作有切换开关的系统以前，请关闭电源并拔出电源线。
警告	オン/オフスイッチのあるシステムで作業を始める場合、はじめに電源スイッチをオフにし、電源コードのプラグを抜いてください。

Statement 248—Unit Mounting Warning



Warning	This unit is intended to be mounted on a wall. Please read the wall mounting instructions carefully before beginning installation. Failure to use the correct hardware or to follow the correct procedures could result in a hazardous situation to people and damage to the system.
Waarschuwing	Deze eenheid dient aan een wand te worden bevestigd. Lees voordat u met de installatie begint, de instructies voor wandmontage aandachtig door. Het niet gebruiken van de juiste apparatuur of het niet volgen van de juiste procedures kan leiden tot gevaarlijke situaties of beschadiging van het systeem.
Varoitus	Tämä laite on tarkoitettu seinälle asennettavaksi. Lue seinäasennusohjeet huolellisesti ennen asennuksen aloittamista. Väärinen työkalujen käyttäminen tai ohjeiden noudattamatta jättäminen voi aiheuttaa henkilövahinkoja ja vioittaa laitetta.
Attention	Cette unité est conçue pour être montée sur un mur. Veuillez lire attentivement les instructions de montage avant de commencer l'installation. L'utilisation d'un matériel incorrect ou l'application inappropriée des procédures peut être à l'origine d'accidents et endommager le système.
Warnung	Diese Einheit ist für die Montage an einer Wand bestimmt. Lesen Sie die Montageanweisungen sorgfältig durch, bevor Sie mit der Installation beginnen. Nichtverwenden der korrekten Hardware oder Nichtbefolgen der korrekten Vorgehensweise stellt eine potentielle Gefahrenquelle dar und könnte das System beschädigen.
Avvertenza	L'unità deve essere montata a parete. Leggere attentamente le istruzioni di montaggio a parete prima di procedere all'installazione. L'impiego di utensili non adeguati o di procedure non corrette può comportare un rischio per le persone e per il sistema stesso.
Advarsel	Denne enheten er beregnet på veggmontering. Les instruksjonene om veggmontering nøye før du begynner installeringen. Hvis du ikke bruker riktig maskinutstyr eller følger de korrekte prosedyrer, kan det medføre risiko for personskade og skade på systemet.
Aviso	Esta unidade foi concebida para ser montada numa parede. Leia atentamente as instruções de montagem em parede antes de iniciar a instalação. A utilização de material incorrecto ou o não seguimento dos procedimentos correctos podem dar origem a uma situação perigosa para o pessoal e danificar o sistema.
¡Advertencia!	Esta unidad está diseñada para ser montada en la pared. Leer las instrucciones de montaje en pared cuidadosamente antes de comenzar la instalación. En caso de no utilizar los materiales apropiados o no seguir el procedimiento correcto, se podría crear una situación peligrosa y ocasionar daños al sistema.
Varning!	Den här enheten är utformad för väggmontering. Läs noga anvisningarna för väggmontering innan du börjar installera. Om du inte använder rätt maskinvara eller inte följer anvisningarna kan det orsaka fara för personskada eller skador på systemet.

Statement 1004—Installation Instructions



Warning Read the installation instructions before connecting the system to the power source. Statement 1004

Waarschuwing Raadpleeg de installatie-instructies voordat u het systeem op de voedingsbron aansluit.

Varoitus Lue asennusohjeet ennen järjestelmän yhdistämistä virtalähteeseen.

Attention Avant de brancher le système sur la source d'alimentation, consulter les directives d'installation.

Warnung Vor dem Anschließen des Systems an die Stromquelle die Installationsanweisungen lesen.

Avvertenza Consultare le istruzioni di installazione prima di collegare il sistema all'alimentatore.

Advarsel Les installasjonsinstruksjonene før systemet kobles til strømkilden.

Aviso Leia as instruções de instalação antes de ligar o sistema à fonte de energia.

¡Advertencia! Lea las instrucciones de instalación antes de conectar el sistema a la red de alimentación.

Varning! Läs installationsanvisningarna innan du kopplar systemet till strömförsörjningsenheten.

Figyelem Mielőtt áramforráshoz csatlakoztatná a rendszert, olvassa el az üzembe helyezési útmutatót!

Предупреждение Перед подключением устройства к источнику электропитания ознакомьтесь с данной инструкцией по установке.

警告 在将系统与电源连接之前，请仔细阅读安装说明。

警告 必ず設置手順を読んでから、システムを電源に接続してください。

주의 시스템을 전원에 연결하기 전에 설치 지침을 읽으십시오.

Aviso Leia as instruções de instalação antes de conectar o sistema à fonte de energia.

Upozornění Před připojením systému k elektrické síti si prostudujte pokyny k instalaci.

אזהרה יש לקרוא את הוראות ההתקנה לפני חיבור המערכת למקור המתח.

Ostrzeżenie	Przed podłączeniem systemu do źródła zasilania należy przeczytać instrukcje dotyczące instalacji.
Upozornenie	Pred pripojením systému k napájacímu zdroju si prečítajte inštalčné pokyny.
Opozorilo	Preden sistem priključite, preberite navodila za priključitev.
警告	將系統連接供電系統前，請先閱讀安裝指南。

Statement 1005—Circuit Breaker



Warning	This product relies on the building's installation for short-circuit (overcurrent) protection. Ensure that the protective device is rated not greater than: 15 A, 125 Vac, or 10A, 240 Vac. Statement 1005
Waarschuwing	Dit product is afhankelijk van de installatie van het gebouw voor beveiliging tegen kortsluiting (overstroom). Controleer of de beschermingsinrichting niet meer dan: 15 A, 125 Vac, or 10A, 240 Vac is.
Varoitus	Tämä tuote on riippuvainen rakennukseen asennetusta oikosulkusuojauksesta (ylivirtasuojauksesta). Varmista, että suojalaitteen mitoitus ei ole yli: 15 A, 125 Vac, or 10A, 240 Vac.
Attention	Pour ce qui est de la protection contre les courts-circuits (surtension), ce produit dépend de l'installation électrique du local. Vérifiez que le courant nominal du dispositif de protection n'est pas supérieur à : 15 A, 125 Vac, or 10A, 240 Vac.
Warnung	Dieses Produkt ist darauf angewiesen, dass im Gebäude ein Kurzschluss- bzw. Überstromschutz installiert ist. Stellen Sie sicher, dass der Nennwert der Schutzvorrichtung nicht mehr als: 15 A, 125 Vac, or 10A, 240 Vac beträgt.
Avvertenza	Questo prodotto dipende dall'impianto dell'edificio per quanto riguarda la protezione contro cortocircuiti (sovracorrente). Assicurarsi che il dispositivo di protezione non abbia un rating superiore a: 15 A, 125 Vac, or 10A, 240 Vac.
Advarsel	Dette produktet er avhengig av bygningens installasjoner av kortslutnings (overstrøm)-beskyttelse. Påse at verneenheten ikke er merket høyere enn: 15 A, 125 Vac, or 10A, 240 Vac.

Aviso	Este produto depende das instalações existentes para proteção contra curto-circuito (sobrecarga). Assegure-se de que o fusível ou disjuntor não seja superior a: 15 A, 125 Vac, or 10A, 240 Vac.
¡Advertencia!	Este equipo utiliza el sistema de protección contra cortocircuitos (o sobrecorrientes) del edificio. Asegúrese de que el dispositivo de protección no sea superior a: 15 A, 125 Vac, or 10A, 240 Vac.
Varning!	Denna produkt är beroende av i byggnaden installerat kortslutningsskydd (överströmsskydd). Kontrollera att skyddsanordningen inte har högre märkvärde än: 15 A, 125 Vac, or 10A, 240 Vac.
Figyelem	A termék védelmi rendszerének része az épület kábelezésébe épített rövidzárlat (túláram) elleni védelem is. Gondoskodjon róla, hogy a készüléket védő eszköz legfeljebb a következő áramerősségre legyen méretezve: 15 A, 125 Vac, or 10A, 240 Vac.
Предупреждение	Защита устройства от короткого замыкания (перегрузки) осуществляется с помощью оборудования, являющегося частью электропроводки здания. Убедитесь, что номинал защитного устройства не превышает: 15 A, 125 Vac, or 10A, 240 Vac.
警告	此产品的短路（过载电流）保护由建筑物的供电系统提供。确保短路保护设备的额定电流不大于：15 A, 125 Vac, or 10A, 240 Vac.
警告	この製品は、設置する建物にショート（過電流）保護機構が備わっていることを前提に設計されています。保護装置の定格が以下の値を超えないことを確認してください。15 A, 125 Vac, or 10A, 240 Vac.

Statement 1040—Product Disposal

	Warning	Ultimate disposal of this product should be handled according to all national laws and regulations. Statement 1040
	Waarschuwing	Het uiteindelijke wegruimen van dit product dient te geschieden in overeenstemming met alle nationale wetten en reglementen.
	Varoitus	Tämä tuote on hävitettävä kansallisten lakien ja määräysten mukaisesti.
	Attention	La mise au rebut ou le recyclage de ce produit sont généralement soumis à des lois et/ou directives de respect de l'environnement. Renseignez-vous auprès de l'organisme compétent.
	Warnung	Die Entsorgung dieses Produkts sollte gemäß allen Bestimmungen und Gesetzen des Landes erfolgen.

Avvertenza	Lo smaltimento di questo prodotto deve essere eseguito secondo le leggi e regolazioni locali.
Advarsel	Endelig kassering av dette produktet skal være i henhold til alle relevante nasjonale lover og bestemmelser.
Aviso	Deitar fora este produto em conformidade com todas as leis e regulamentos nacionais.
Advertencia!	Al deshacerse por completo de este producto debe seguir todas las leyes y reglamentos nacionales.
Varning!	Vid deponering hanteras produkten enligt gällande lagar och bestämmelser.
Figyelem	A készülék végső elhelyezéséről az adott országban érvényes törvények és előírások szerint kell intézkedni.
Предупреждение	
警告	本产品的废弃处理应根据所有国家的法律和规章进行。
警告	この製品を廃棄処分する際は、各国の法律および規制に従って取り扱ってください。
주의	해당 국가의 관련 법규 및 규정에 따라 이 장치를 폐기해야 합니다.
Aviso	O descarte definitivo deste produto deve estar de acordo com todas as leis e regulamentações nacionais.
Advarsel	Endelig bortskaffelse af dette produkt skal ske i henhold til gældende love og regler.
تحذير	عند التخلص من المنتج يجب اتباع القوانين والتشريعات المحلية.
Upozorenje	Zbrinjavanje ovoga proizvoda u otpad treba provesti u skladu s važećim zakonima i odredbama.
Upozornění	Upozornění: Likvidace tohoto výrobku musí být provedena podle platných zákonů a předpisů.
Προειδοποίηση	Η τελική απόρριψη αυτού του προϊόντος πρέπει να γίνεται σύμφωνα με όλους τους εθνικούς νόμους και κανονισμούς.
אזהרה	סילוק סופי של מוצר זה חייב להיות בהתאם להנחיות ולחוקי המדינה.
	Крайното фрлање на овој производ треба да се изврши во согласност со сите национални закони и прописи.

Ostrzeżenie	Ostateczna likwidacja tego urządzenia po jego wycofaniu z eksploatacji powinna odbywać się zgodnie z przepisami krajowymi.
Upozornenie	Upozornenie Likvidácia tohto výrobku musí byť vykonaná podľa platných zákonov a predpisov.
Opozorilo	Uničenje izdelka, ki ni več uporaben, mora potekati po državnih zakonih in predpisih.
警告	本產品的最終處理必須遵照國家/地區的所有法律與法規。

Statement 1044—Port Connections



Warning

**For connections outside the building where the equipment is installed, the following ports must be connected through an approved network termination unit with integral circuit protection.
10/100/1000 Ethernet Statement 1044**

Waarschuwing

**Voor aansluitingen buiten het gebouw waar de apparatuur wordt geïnstalleerd, dienen de volgende poorten aangesloten te worden via een goedgekeurde netwerkafluiteenheid met integrale circuitbescherming.
10/100/1000 Ethernet**

Varoitus

**Asennuksen sisältävän rakennuksen ulkopuolisia liitäntöjä varten seuraavat portit on kytkettävä hyväksytyin verkon päätelaitteen kautta ja virtapiirin on oltava kiinteästi suojattu.
10/100/1000 Ethernet**

Attention

**Pour les connexions extérieures au bâtiment équipé, les ports suivants doivent être connectés à un point approuvé de terminaison de réseau, avec protection complète du circuit.
10/100/1000 Ethernet**

Warnung

**Für Verbindungen außerhalb des Gebäudes, in dem das Gerät installiert ist, müssen die folgenden Anschlüsse über eine zulässige Netzabschlusseinheit mit integrelem Leitungsschutz verbunden werden.
10/100/1000 Ethernet**

Avvertenza

**Per le connessioni esterne all'edificio in cui è installato l'apparecchio, le seguenti porte devono essere connesse a un'unità di terminazione di rete approvata, con protezione completa del circuito.
10/100/1000 Ethernet**

Advarsel

**For tilkoblinger utenfor bygningen der utstyret er montert, må følgende åpninger tilkobles gjennom en godkjent nettverksterminal med integrert kretsbeskyttelse.
10/100/1000 Ethernet**

Aviso	Para ligações fora do edifício onde o equipamento está instalado, é necessário ligar as seguintes portas através de uma unidade de terminal de rede aprovada com protecção de circuito integral. 10/100/1000 Ethernet
;Advertencia!	Para realizar conexiones en el exterior del edificio en el que esté instalado el equipo, deberá conectar los puertos especificados a continuación a una unidad terminal de red aprobada que cuente con protección de circuitos integrales. 10/100/1000 Ethernet
Varning!	För alla anslutningar utanför byggnaden där utrustningen har installerats gäller att följande portar måste anslutas genom en godkänd nätverksavslutningsenhet med integrerat kretsskydd. 10/100/1000 Ethernet
Figyelem	A készülék helyeül szolgáló épületen kívüli csatlakozásokhoz az alábbi portokat beépített áramköri védelmet tartalmazó, engedélyezett hálózati végpontokon keresztül kell csatlakoztatni. 10/100/1000 Ethernet
Предупреждение	При подключении кабелей, ведущих за пределы здания, в котором установлено оборудование, следующие порты необходимо подключать через соответствующий оконечный сетевой модуль, снабженный защитой линии. 10/100/1000 Ethernet
警告	在安装了设备的建筑物进行户外连接时，下列端口应与经认可的、具有集成线路保护性能的网络终端部件相连。 10/100/1000 Ethernet
警告	装置を設置する建物の外部への接続には、回路保護機構が組み込まれた認定済みのネットワーク終端ユニットを使用して、次のポートを接続する必要があります。 10/100/1000 Ethernet
주의	장치가 설치되어 있는 건물 외부에서 연결하는 경우, 다음 포트는 집적 회로 보호 처리가 되어 있는 승인된 네트워크 종단 장치를 통해 연결되어야 합니다. 10/100/1000 Ethernet
Aviso	Para as conexões que estejam na parte externa do edifício no qual o equipamento está instalado, as seguintes portas devem estar conectadas através de um terminal de rede aprovado com protecção integral do circuito. 10/100/1000 Ethernet
Upozornění	Pro připojení mimo budovu, kde je toto zařízení nainstalováno, musí být následující porty připojeny přes schválenou síťovou ukončovací jednotku s integrovanou ochranou. 10/100/1000 Ethernet
אזהרה	לחיבורים מחוץ לבניין שבו הציוד מותקן, יש לחבר את היציאות הבאות דרך יחידת קצה רשת מאושרת הכוללת הגנה על המעגל. 10/100/1000 Ethernet

Ostrzeżenie	Dla połączeń poza budynkiem, gdzie zainstalowany jest sprzęt, poniższe porty muszą być podłączone przez zatwierdzony sieciowy element końcówkowy z integralnym zabezpieczeniem obwodu. 10/100/1000 Ethernet
Upozornenie	Pri pripájaní mimo budovy, v ktorej je nainštalované zariadenie, musia byť nasledujúce porty pripojené cez schválenú ukončovaciu jednotku siete s integrovaným chráničom. 10/100/1000 Ethernet
Opozorilo	Za povezave zunaj poslopja, kjer je priključena oprema, morajo biti navedena vrata povezana prek odobrenega omrežnega priključka z vgrajeno vodovno zaščito. 10/100/1000 Ethernet

Statement 1072—Shock Hazard from Interconnections



Warning

Voltages that present a shock hazard may exist on Power over Ethernet (PoE) circuits if interconnections are made using uninsulated exposed metal contacts, conductors, or terminals. Avoid using such interconnection methods, unless the exposed metal parts are located within a restricted access location and users and service people who are authorized within the restricted access location are made aware of the hazard. A restricted access area can be accessed only through the use of a special tool, lock and key or other means of security. Statement 1072

Waarschuwing

Voltages kunnen elektrische schokken veroorzaken in PoE (Power over Ethernet)-circuits als er verbindingen worden gemaakt met blootliggende metalen contactpunten, geleiders of aansluitingspunten die niet zijn geïsoleerd. Gebruik dit type verbinding niet tenzij de blootliggende metalen onderdelen zich bevinden op een locatie met beperkte toegang en de gebruikers en onderhoudstechnici die toegang tot deze locatie hebben, op het gevaar worden gewezen. De locatie met beperkte toegang kan alleen worden geopend met speciaal gereedschap, slot en sleutel of een andere beveiligingsmethode.

Varoitus

Sisäisissä Ethernet (PoE) -virtapiireissä voi olla sähköiskun vaaran aiheuttavia jännitteitä, jos kytkentöihin käytetään eristämättömiä paljaita metalliliittimiä tai -johtimia. Vältä tällaisia kytkentöjä, elleivät paljaat metalliosat ole rajatussa paikassa. Ilmoita valtuutetuille käyttäjille ja huoltohenkilöille vaarasta. Rajattuun alueeseen pääsee käsiksi ainoastaan erityistyökäluu, lukkoa ja avainta tai muuta turvallista menetelmää käyttämällä.

Attention	Les tensions existant sur les alimentations utilisant la technologie PoE (Power over Ethernet) peuvent constituer un risque d'électrocution si les interconnexions sont effectuées en utilisant des terminaux, conducteurs ou contacts métalliques exposés non isolés. Évitez d'utiliser de telles méthodes d'interconnexion à moins que les pièces métalliques exposées ne se trouvent dans un emplacement d'accès restreint et que les utilisateurs et les responsables du service autorisés dans cet emplacement d'accès restreint ne soient conscients du danger. Une zone d'accès restreint peut être accédée uniquement à l'aide d'une clé, d'un outil et d'un verrou spécial, ou d'autres moyens de sécurité.
Warnung	Bei Power-over-Ethernet-(PoE-)Schaltkreisen besteht u.U. Stromschlaggefahr, wenn Verbindungen unter Verwendung nicht isolierter, freiliegender Metallkontakte, Leiter oder Anschlussklemmen hergestellt werden. Vermeiden Sie das Herstellen solcher Verbindungen, es sei denn, die freiliegenden Metallteile befinden sich an Orten mit beschränktem Zugang, und Personen, die Zugang dazu haben, sind ausdrücklich über diese Gefahr informiert worden. Ein Ort mit beschränktem Zugang ist nur mit Hilfe eines speziellen Werkzeugs, Schloss und Schlüssels oder anderen Sicherheitseinrichtungen zugänglich.
Avvertenza	Nei circuiti con alimentazione via Ethernet (PoE) possono verificarsi pericoli di scosse elettriche se si creano connessioni con contatti metallici, conduttori o terminali scoperti. Evitare di utilizzare i metodi di connessione sopraelencati a meno che le parti metalliche esposte non si trovino in una zona riservata e gli utenti e il personale di assistenza, che sono autorizzati ad accedere nella suddetta zona, siano stati messi al corrente del pericolo. È possibile accedere alla zona riservata solamente utilizzando gli appositi elementi di sicurezza.
Advarsel	I strømkretser med PoE (Power over Ethernet) kan det være spenninger som kan utgjøre støtfare hvis det blir foretatt sammenkoblinger med uisolerte, eksponerte kontakter, ledere eller terminaler av metall. Unngå å bruke slike sammenkoblingsmetoder med mindre de eksponerte metalldelene er i et område med begrenset tilgang, og brukere og servicepersonell som har tilgang til det begrensede området, blir gjort oppmerksom på faren. Et område med begrenset tilgang kan bare åpnes ved hjelp av spesialverktøy, nøkkel eller andre sikkerhetstiltak.
Aviso	Pode haver voltagens que representam perigo de choque em circuitos PoE (Power over Ethernet) se as interconexões forem feitas utilizando-se terminais, condutores ou contatos de metal exposto e sem isolamento. Evite utilizar tais métodos de interconexão a não ser que as partes de metal expostas estejam em um local de acesso restrito e os usuários e o pessoal de serviço com acesso autorizado a este local restrito estejam cientes do perigo. Uma área de acesso restrito só pode ser acessada com o uso de uma ferramenta, fechadura e chave especial ou de outros meios de segurança.
¡Advertencia!	Puede haber voltajes con riesgo de shock en circuitos de alimentación sobre el cableado Ethernet (PoE), si para las interconexiones se utilizan contactos, conductores o terminales metálicos descubiertos. Evite tales métodos de interconexión, a menos que las partes metálicas descubiertas se encuentren en un lugar de acceso restringido y tanto los usuarios como el personal de servicios en dicho lugar sean conscientes de la existencia de tal riesgo. Sólo se puede tener acceso a una zona de acceso restringido mediante el uso de una herramienta especial, un candado y una llave u otros medios de seguridad.

Varning! Det kan finnas spänningar på PoE-kretsarna (Power over Ethernet) som utgör risk för stötar om sammankopplingarna görs med ej isolerade, exponerade kontakter, ledare och/eller terminaler av metall. Undvik att använda sådana sammankopplingsmetoder, såvida inte de exponerade metalldelarna finns i en plats med begränsad åtkomst. Användare och servicepersonal som tillåts inom platsen med begränsad åtkomst måste vara medvetna om risken. Ett begränsat område kan bara nås med ett speciellt verktyg eller lås, en speciell nyckel eller någon annan säkerhetsmetod.

Figyelem Áramütést okozó feszültség keletkezhet a feszültség alatt lévő Ethernet (Power over Ethernet, PoE) áramkörökben, amennyiben összeköttetés jön létre a szigetetlen fém érintkezők, vezetékek vagy csatlakozók között. Ne alkalmazzon ilyen összeköttetéseket, kivéve, ha az érintésnek kitett fém alkatrészek korlátozottan hozzáférhető területen találhatóak, és a terület elérésére felhatalmazott felhasználók és szervizszakemberek tudatában vannak az áramütés veszélyének. A korlátozottan hozzáférhető területekhez csak speciális szerszám, zár és kulcs, vagy más biztonsági berendezés segítségével lehet hozzáférni.

Предупреждение При выполнении соединений с использованием неизолированных металлических контактов, проводников или разъемов в электроцепях Power over Ethernet (PoE) могут возникать напряжения, представляющие опасность поражения электрическим током. Старайтесь не использовать такие способы соединений, если только неизолированные металлические части не находятся в местах, доступ к которым разрешен для ограниченного круга лиц, а пользователи и специалисты по обслуживанию, уполномоченные выполнять работы в таких местах, предупреждены о наличии такой опасности. При работе в местах, доступ к которым разрешен для ограниченного круга лиц, следует использовать только специальные инструменты, закрывать их на ключ или предпринимать другие меры безопасности.

警告 如果使用不绝缘、暴露的金属接头、导体或终端进行互联、在以太网供电 (PoE) 电路中就会产生导致电击危险的电压。只有暴露的金属部件处于限制进入的位置、并且被授权进入此位置的用户和服务人员意识到此危险、才能使用这样的互联方式。要进入受限区域、仅能使用特殊的工具、锁和密钥或其他安全方法。

警告 絶縁処理が施されていない金属製の部品、コンダクタ、またはターミナルを使用して内部接続されている場合、感電を引き起こす電圧が Power over Ethernet (PoE) 回路に存在する可能性があります。絶縁処理が施されていない金属製の部品がアクセス制限区域にのみ存在する場合や、アクセス制限区域への立ち入りが認められているユーザおよびサービス担当者が感電の可能性について熟知している場合を除き、そのような内部接続の方法は避けてください。アクセス制限区域には、特殊な工具、施錠などのセキュリティ手段を使用しなければアクセスできません。

Statement 1073—No User-Serviceable Parts



Warning No user-serviceable parts inside. Do not open. Statement 1073

Waarschuwing Er zijn geen door de gebruiker te vervangen onderdelen. Niet openen.

Varoitus	Ei sisällä käyttäjän huollettavissa olevia osia. Älä avaa.
Attention	Aucune pièce se trouvant à l'intérieur ne peut être réparée ou remplacée par l'utilisateur. Ne pas ouvrir.
Warnung	Enthält keine Teile, die vom Benutzer gewartet werden müssen. Bitte nicht öffnen.
Avvertenza	Non contiene parti riparabili dall'utente. Non aprire.
Advarsel	Inneholder ingen deler som kan repareres av brukeren. Må ikke åpnes.
Aviso	Sem peças sujeitas a manutenção pelo utilizador. Não abrir.
¡Advertencia!	No contiene partes que puedan ser arregladas por el usuario. No abrir.
Varning!	Det finns inga delar som användare kan utföra service på. Öppna inte.
	A készülék nem tartalmaz a felhasználó által javítható alkatrészeket. Ne nyissa fel.
Предупреждение	Внутри нет деталей, обслуживание которых может выполняться пользователем. Не вскрывайте.
警告	内无用户可用的零件。请勿打开。
警告	ユーザによる交換可能な部品は含まれていません。開けないでください。
주의	교체/수리가 가능한 부품이 들어있지 않음. 열지 마십시오.
Aviso	Manutenção somente por técnico especializado. Não abra.
Advarsel	Ingen dele indeni som brugere kan reparere. Åbn ej.
تحذير	لا يوجد بالداخل قطع غيار يمكن للمستخدم استبدالها. الرجاء عدم الفتح.
Upozorenje	Unutar uređaja nema dijelova koje korisnici mogu sami popraviti. Nemojte otvarati uređaj.
Upozornění	Uvnitř zařízení nejsou žádné díly, které by mohl uživatel sám opravit. Zařízení neotevírejte.
Προειδοποίηση	Στο εσωτερικό της συσκευής, δεν περιλαμβάνονται εξαρτήματα που μπορούν να συντηρηθούν από το χρήστη. Μην ανοίγετε τη συσκευή.
אזהרה	אין בפנים חלקים המיועדים לטיפולו של המשתמש. אל תפתח.

Внатре нема делови што ги сервисира корисникот. Не отворајте.

Ostrzeżenie	Wewnątrz urządzenia nie ma elementów, które użytkownik mógłby naprawiać lub obsługiwać samodzielnie. Nie otwierać.
Upozornenie	V zariadení nie sú žiadne súčasti, ktorý by mohol používateľ sám opravovať. Zariadenie neotvárajte.

Statement 1074—Comply with Local and National Electrical Codes



Warning Installation of the equipment must comply with local and national electrical codes.

Waarschuwing Bij installatie van de apparatuur moet worden voldaan aan de lokale en nationale elektriciteitsvoorschriften.

Varoitus Laitteisto tulee asentaa paikallisten ja kansallisten sähkömääräysten mukaisesti.

Attention L'équipement doit être installé conformément aux normes électriques nationales et locales.

Warnung Die Installation der Geräte muss den Sicherheitsstandards entsprechen.

Avvertenza L'installazione dell'impianto deve essere conforme ai codici elettrici locali e nazionali.

Advarsel Installasjon av utstyret må samsvare med lokale og nasjonale elektrisitetsforskrifter.

Aviso A instalação do equipamento tem de estar em conformidade com os códigos eléctricos locais e nacionais.

¡Advertencia! La instalación del equipo debe cumplir con las normativas de electricidad locales y nacionales.

Varning! Installation av utrustningen måste ske i enlighet med gällande elinstallationsföreskrifter.

A berendezés üzembe helyezését a helyi és a nemzeti elektromossági előírások figyelembevételével kell elvégezni.

Предупреждение Установка оборудования должна соответствовать местным и национальным электротехническим нормам.

警告 设备安装必须符合本地与本国电气法规。

警告 機器の取り付けは地域および国内の電気工事規定に遵守する必要があります。

주의	현지 및 국가 전기 규정에 따라 장비를 설치해야 합니다.
Aviso	A instalação do equipamento deve estar em conformidade com os códigos elétricos nacionais.
Upozornění	Instalace zařízení musí splňovat příslušné místní a státní elektrotechnické normy.
אזהרה	התקנת הציוד חייבת להיות תואמת את חוקי החשמל המקומיים והארציים.
Ostrzeżenie	Instalacja sprzętu musi być zgodna z lokalnymi i krajowymi normami elektrycznymi.
Upozornenie	Inštalácia zariadenia sa musí vykonať v súlade s miestnymi a národnými predpismi pre inštaláciu elektrických zariadení.
Opozorilo	Priključitev opreme mora potekati v skladu z lokalnimi in državnimi predpisi o električni opremi.
警告	設備安裝作業必須符合當地或國家電工法。

Product Usage Restrictions

The CISCO WAP571 Wireless Access Point are intended for indoor use only.

Declaration of Conformity Statements

The Declaration of Conformity statements for this product can be found at the following URL:

<http://www.ciscofax.com>



Note

If you still have questions regarding the compliance of these products or you cannot find the information you are looking for, please send an e-mail request to complianceinfo@cisco.com.

European Directives

Statement 287—Declaration of Conformity to R&TTE Directive 1999/5/EC for the European Community, Switzerland, Norway, Iceland and Liechtenstein

English:	This equipment is in compliance with the essential requirements and other relevant provisions of Directive 1999/5/EC.
Български: [Bulgarian]:	Това оборудване отговаря на съществените изисквания и приложими клаузи на Директива 1999/5/EC.
Česky [Czech]:	Toto zařízení je v souladu se základními požadavky a ostatními odpovídajícími ustanoveními Směrnice 1999/5/EC.
Dansk [Danish]:	Dette udstyr er i overensstemmelse med de væsentlige krav og andre relevante bestemmelser i Direktiv 1999/5/EF.
Deutsch [German]:	Dieses Gerät entspricht den grundlegenden Anforderungen und den weiteren entsprechenden Vorgaben der Richtlinie 1999/5/EU.
Eesti [Estonian]:	See seade vastab direktiivi 1999/5/EÜ olulistele nõuetele ja teistele asjakohastele sätetele.
Español [Spanish]:	Este equipo cumple con los requisitos esenciales así como con otras disposiciones de la Directiva 1999/5/CE.
Ελληνική [Greek]:	Αυτός ο εξοπλισμός είναι σε συμμόρφωση με τις ουσιώδεις απαιτήσεις και άλλες σχετικές διατάξεις της Οδηγίας 1999/5/EC.

Français [French]:	Cet appareil est conforme aux exigences essentielles et aux autres dispositions pertinentes de la Directive 1999/5/EC.
Hrvatski [Croatian]:	Ova oprema je u skladnosti s bitnim zahtjevima i drugim relevantnim odredbama Direktive 1999/5/EC.
Íslenska [Icelandic]:	Þetta tæki er samkvæmt grunnkröfum og öðrum viðeigandi ákvæðum Tilskipunar 1999/5/EC.
Italiano [Italian]:	Questo apparato é conforme ai requisiti essenziali ed agli altri principi sanciti dalla Direttiva 1999/5/CE.
Latviski [Latvian]:	Šī iekārta atbilst Direktīvas 1999/5/EK būtiskajām prasībām un citiem ar to saistītajiem noteikumiem.
Lietuvių [Lithuanian]:	Šis įrenginys tenkina 1999/5/EB Direktyvos esminius reikalavimus ir kitas šios direktyvos nuostatas.
Nederlands [Dutch]:	Dit apparaat voldoet aan de essentiële eisen en andere van toepassing zijnde bepalingen van de Richtlijn 1999/5/EC.
Malti [Maltese]:	Dan l-apparat huwa konformi mal-htigiet essenzjali u l-provedimenti l-oħra rilevanti tad-Direttiva 1999/5/EC.
Magyar [Hungarian]:	Ez a készülék teljesíti az alapvető követelményeket és más 1999/5/EK irányelvben meghatározott vonatkozó rendelkezéseket.
Norsk [Norwegian]:	Dette utstyret er i samsvar med de grunnleggende krav og andre relevante bestemmelser i EU-direktiv 1999/5/EF.
Polski [Polish]:	Urządzenie jest zgodne z ogólnymi wymaganiami oraz szczególnymi warunkami określonymi Dyrektywą UE: 1999/5/EC.
Português [Portuguese]:	Este equipamento está em conformidade com os requisitos essenciais e outras provisões relevantes da Directiva 1999/5/EC.
Română [Romanian]:	Acest echipament este în conformitate cu cerințele esențiale și cu alte prevederi relevante ale Directivei 1999/5/EC.
Slovensko [Slovenian]:	Ta naprava je skladna z bistvenimi zahtevami in ostalimi relevantnimi pogoji Direktive 1999/5/EC.
Slovensky [Slovak]:	Toto zariadenie je v zhode so základnými požiadavkami a inými príslušnými nariadeniami direktív: 1999/5/EC.
Suomi [Finnish]:	Tämä laite täyttää direktiivin 1999/5/EY olennaiset vaatimukset ja on siinä asetettujen muiden laitetta koskevien määräysten mukainen.

Türk **Bu cihaz 1999/5/EC Direktifi'nin temel gereklerine ve ilgili diğer hükümlerine uygundur.**
[Turkish]:

Svenska **Denna utrustning är i överensstämmelse med de väsentliga kraven och andra relevanta**
[Swedish]: **bestämmelser i Direktiv 1999/5/EC.**

Declaration of Conformity with Regard to the Directives 2006/95/EC and 2004/108/EC

This equipment complies with the essential requirements and other provisions of Directives 2006/95/EC and 2004/108/EC. For more information, please refer to the Declaration of Conformity.

EU Battery Disposal and Recycling

This product may contain a battery. Recycle or dispose of batteries in accordance with the battery manufacturer's instructions and local/national disposal and recycling regulations.

Standards Compliance

The following CE mark is affixed to the equipment and packaging:



This section includes all regulatory, safety, EMC, telecom, and radio standards used to verify compliance with the EU Directive (Directive 2006/95/EC and 2004/108/EC for products without antenna or antenna connectors and Directive 1995/5/EC for products with antenna or antenna connectors). The Cisco WAP571/571E Wireless Access Points are in compliance with national and international standards as described in [Table 1](#).

Table 1

Specification	Description
EU Compliance (CE Mark)	Products with CE marking indicate compliance with the Low Voltage Directive 2006/95/EC, EMC Directive 2004/108/EC or R&TTE Directive 1999/5/EC.
Safety	UL 60950-1 CAN/CSA-C22.2 No. 60950-1 EN 60950-1 IEC 60950-1 AS/NZS 60950-1

Table 1 (continued)

Specification	Description
EMC	47CFR FCC Part 15B Industry Canada ICES-003 EN 301 489-1, EN 301 489-17 EN55022 EN55024 EN61000-3-2 EN61000-3-3 CISPR 22 CISPR 24 AS/NZS CISPR22
Radio	47CFR FCC Part 15C Industry Canada RSS-247 EN 300 328 EN 301893 AS/NZS 4268
RF Exposure	FCC OET 65, Supplement C RSS-102 EN 50385

For specific details about the years, revisions and relevant amendments please refer to the applicable declaration of conformity available at <http://www.ciscofax.com>.

EMC Class B Notices and Warnings

This section includes the EMC Class B warnings for the Cisco WAP571/571E Wireless Access Point.

Class B Notice for FCC

Modifying the equipment without Cisco's authorization may result in the equipment no longer complying with FCC requirements for Class B digital devices. In that event, your right to use the equipment may be limited by FCC regulations, and you may be required to correct any interference to radio or television communications at your own expense.

This equipment has been tested and found to comply with the limits for a Class B digital device, pursuant to Part 15 of the FCC Rules. These limits are designed to provide reasonable protection against harmful interference in a residential installation. This equipment generates, uses and can radiate radio frequency energy and, if not installed and used in accordance with the instructions, may cause harmful interference to radio communications. However, there is no guarantee that interference will not occur in a particular installation. If this equipment does cause harmful interference to radio or television reception, which can be determined by turning the equipment off and on, the user is encouraged to try to correct the interference by one or more of the following measures:

- Reorient or relocate the receiving antenna.
- Increase the separation between the equipment and receiver.

- Connect the equipment into an outlet on a circuit different from that to which the receiver is connected.
- Consult the dealer or an experienced radio/TV technician for help.

Class B Notice for Canada

This Class B digital apparatus complies with Canadian ICES-003.

Cet appareil numérique de la classe B est conforme à la norme NMB-003 du Canada.

Statement 295—Class B Warning for Korea



Warning

This is a Class B Device and is registered for EMC requirements for residential use. This device can be used not only in residential areas but in all other areas.

주의 B급 기기 이 기기는 가정용으로 전자파 적합 등록을 한 기기로서 주거지역 내에서는 물론 모든 지역에서 사용할 수 있습니다.

Statement 157—VCCI Compliance for Class B Equipment



Warning

This is a Class B product based on the standard of the VCCI Council. If this is used near a radio or television receiver in a domestic environment, it may cause radio Interference. Install and use the equipment according to the instruction manual.

VCCI-B

警告 この装置は、クラスB情報技術装置です。この装置は、家庭環境で使用することを目的としていますが、この装置がラジオやテレビジョン受信機に近接して使用されると、受信障害を引き起こすことがあります。取扱説明書に従って正しい取り扱いをして下さい。

VCCI-B

Japanese Electric Appliance and Radio Laws

Statement 571/571E—Power Cable and AC Adapter



Warning

When installing the product, please use the provided or designated connection cables/power cables/AC adaptors/batteries. Using any other cables/adaptors could cause a malfunction or a fire. Electrical Appliance and Material Safety Law prohibits the use of UL-certified cables (that have the “UL” or “CSA” shown on the cord), not regulated with the subject law by showing “PSE” on the cord, for any other electrical devices than products designated by CISCO.

警告

接続ケーブル、電源コード、ACアダプタ、バッテリーなどの部品は、必ず添付品または指定品をご使用ください。添付品・指定品以外の部品をご使用になると故障や動作不良、火災の原因となります。また、電気用品安全法により、当該法の認定（PSEとコードに表記）でなくUL認定（ULまたはCSAマークがコードに表記）の電源ケーブルは弊社が指定する製品以外の電気機器には使用できないためご注意ください。

Radio

This section describes radio compliance conditions for the Cisco WAP571/571E Wireless Access Points EMC Class B Devices.



Caution

The Part 15 radio device operates on a non-interference basis with other devices operating at this frequency when using the integrated antennas. Any changes or modification to the product not expressly approved by Cisco could void the user’s authority to operate this device.

Canadian Radio Warning Statement

This device complies with RSS-247 of the Industry Canada Rules. Operation is subject to the following two conditions: (1) This device may not cause harmful interference, and (2) this device must accept any interference received, including interference that may cause undesired operation.

Ce dispositif est conforme à la norme CNR-247 d'Industrie Canada applicable aux appareils radio exempts de licence. Son fonctionnement est sujet aux deux conditions suivantes: (1) le dispositif ne doit pas produire de brouillage préjudiciable, et (2) ce dispositif doit accepter tout brouillage reçu, y compris un brouillage susceptible de provoquer un fonctionnement indésirable.

Guidelines for Operating Cisco WAP571/571E Wireless Access Points in Japan

This section provides guidelines for avoiding interference when operating Cisco WAP571/571E Wireless Access Points in Japan. These guidelines are provided in both English and Japanese.

Statement 391—Warning for Low-Power Radio Data Communications Systems (-STD)



Warning

This equipment shares a frequency band with a wide range of equipment: e.g. industrial, scientific, and medical equipment such as microwave ovens, premises radio stations (radio stations requiring licenses), and specified low-power radio stations (radio stations not requiring licenses) for RFID used for factory production lines as well as amateur radio stations (radio stations requiring licenses).

1. Before use, confirm that no premises radio stations and specified low-power radio stations for RFID or amateur radio stations operate in your vicinity.

2. In the event that this equipment causes harmful interference to any premises radio station for RFID, immediately change frequencies or halt radio wave emission and contact us at the information indicated below for consultation on interference avoidance measures (e.g., partition installation).

3. Contact us at the information indicated below if this equipment causes harmful interference to any specified low-power radio stations for RFID or amateur radio stations or if other problems arise. Statement 391

Contact us at : <http://www.cisco.com/web/JP/index.html>

警告

この機器の使用周波数帯では、電子レンジ等の産業・科学・医療用機器のほか工場の製造ライン等で使用されている移動体識別用の構内無線局（免許を要する無線局）及び特定小電力無線局（免許を要しない無線局）並びにアマチュア無線局（免許を要する無線局）が運用されています。

1. この機器を使用する前に、近くで移動体識別用の構内無線局及び特定小電力無線局並びにアマチュア無線局が運用されていないことを確認して下さい。
2. 万一、この機器から移動体識別用の構内無線局に対して有害な電波干渉の事例が発生した場合には、速やかに使用周波数を変更するか又は電波の発射を停止した上、下記連絡先にご連絡頂き、混信回避のための処置等（例えば、パーティションの設置など）についてご相談して下さい。
3. その他、この機器から移動体識別用の特定小電力無線局あるいはアマチュア無線局に対して有害な電波干渉の事例が発生した場合など何かお困りのことが起きたときは、次の URL にあります弊社連絡先までお問い合わせ下さい。

弊社ホームページ URL : <http://www.cisco.com/jp/>

Administrative Rules for Cisco Wireless Devices in Taiwan

This section provides administrative rules for operating Cisco wireless access products in Taiwan. The rules are provided in both Chinese and English.

Wireless Devices with IEEE 802.11a/b/g Radios

Chinese Translation

本設備限於室內使用

English Translation

This equipment is limited for indoor use.

All Access Wireless Products

Chinese Translation

低功率電波輻射性電機管理辦法

第十二條 經型式認證合格之低功率射頻電機，非經許可，公司、商號或使用者均不得擅自變更頻率、加大功率或變更原設計之特性及功能。

第十四條 低功率射頻電機之使用不得影響飛航安全及干擾合法通信；經發現有干擾現象時，應立即停用，並改善至無干擾時方得繼續使用。

前項合法通信，指依電信法規定作業之無線電信。

低功率射頻電機須忍受合法通信或工業、科學及醫療用電波輻射性電機設備之干擾。

English Translation**Administrative Rules for Low-Power Radio-Frequency Devices****Article 12**

For those low-power radio-frequency devices that have already received a type-approval, companies, business units, or users should not change its frequencies, increase its power, or change its original features and functions.

Article 14

The operation of the low-power radio-frequency devices is subject to the conditions that no harmful interference is caused to aviation safety and authorized radio stations; and if interference is caused, the user must stop operating the device immediately and can't re-operate it until the harmful interference is clear.

The authorized radio station means a radio-communication service operating in accordance with the Communication Act.

The operation of the low-power radio-frequency devices is subject to the interference caused by the operation of an authorized radio station, by another intentional or unintentional radiator, by industrial, scientific and medical (ISM) equipment, or by an incidental radiator.

Generic Discussion on RF Exposure

The Cisco WAP571/571E Wireless Access Points are designed to comply with the following national and international standards on Human Exposure to Radio Frequencies.

- US 47 Code of Federal Regulations Part 2 Subpart J
- American National Standards Institute (ANSI) / Institute of Electrical and Electronic Engineers / IEEE C 95.1 (92)
- International Commission on Non Ionizing Radiation Protection (ICNIRP) 98
- Ministry of Health (Canada) Safety Code 6. Limits on Human Exposure to Radio Frequency Fields in the range from 3kHz to 300 GHz
- Australia Radiation Protection Standard

To ensure compliance with various national and international Electromagnetic Field (EMF) standards, the system should only be operated with Cisco approved antennas and accessories.

This equipment complies with FCC radiation exposure limits set forth for an uncontrolled environment. This equipment should be installed and operated with minimum distance 20 cm between the radiator & your body.

US

This device and its antennas(s) must not be co-located or operating in conjunction with any other antenna or transmitter except in accordance with FCC multi-transmitter product procedures.

Canada

EU	This system has been evaluated for RF exposure for Humans in reference to the ICNIRP (International Commission on Non-Ionizing Radiation Protection) limits. The evaluation was based on the EN 50385 Product Standard to Demonstrate Compliance of Radio Base stations and Fixed Terminals for Wireless Telecommunications Systems with basic restrictions or reference levels related to Human Exposure to Radio Frequency Electromagnetic Fields from 300 MHz to 40 GHz. The minimum separation distance from the antenna to general bystander is 20cm (7.9 inches).
Australia	This system has been evaluated for RF exposure for Humans as referenced in the Australian Radiation Protection standard and has been evaluated to the ICNIRP (International Commission on Non-Ionizing Radiation Protection)limits. The minimum separation distance from the antenna to general bystander is 20cm (7.9 inches).
Generic Statements - for other countries	
ANSI C 95.1 (99)	This system has been evaluated for RF exposure for Humans in reference to the ANSI (American National Standards Institute)limits as referenced in C 95.1 (99). The minimum separation distance from the antenna to the user is 7.9 inches (20cm).
ICNIRP Limits	This system has been evaluated for RF exposure for Humans in reference to the ICNIRP (International Commission on Non-Ionizing Radiation Protection) limits. The minimum separation distance from the antenna to the user is 20cm (7.9 inches).

Obtaining Documentation and Submitting a Service Request

For information on obtaining documentation, submitting a service request, and gathering additional information, see the monthly *What's New in Cisco Product Documentation*, which also lists all new and revised Cisco technical documentation, at:

<http://www.cisco.com/en/US/docs/general/whatsnew/whatsnew.html>

Subscribe to the *What's New in Cisco Product Documentation* as a Really Simple Syndication (RSS) feed and set content to be delivered directly to your desktop using a reader application. The RSS feeds are a free service and Cisco currently supports RSS Version 2.0.

Cisco and the Cisco logo are trademarks or registered trademarks of Cisco and/or its affiliates in the U.S. and other countries. To view a list of Cisco trademarks, go to this URL: www.cisco.com/go/trademarks. Third-party trademarks mentioned are the property of their respective owners. The use of the word partner does not imply a partnership relationship between Cisco and any other company. (1110R)

© 2014 Cisco Systems, Inc. All rights reserved.