

FCC Test Report

Report No.: RF180312C26-5

FCC ID: VUITX061AEI

Test Model: TX061AEI

Received Date: Mar. 12, 2018

Test Date: Feb. 10, 2018 ~ Mar. 16, 2018

Issued Date: Mar. 31, 2018

Applicant: PEGATRON CORPORATION

Address: 5F., NO. 76, LIGONG ST., BEITOU DISTRICT, TAIPEI CITY 11259, Taiwan

Issued By: Bureau Veritas Consumer Products Services (H.K.) Ltd., Taoyuan Branch

Lab Address: No. 47-2, 14th Ling, Chia Pau Vil., Lin Kou Dist., New Taipei City, Taiwan
(R.O.C)

Test Location: No. 19, Hwa Ya 2nd Rd, Wen Hwa Tsuen, Kwei Shan Hsiang, Taoyuan
Hsien 333, Taiwan, R.O.C.

**FCC Registration /
Designation Number:** 788550 / TW0003



This report is for your exclusive use. Any copying or replication of this report to or for any other person or entity, or use of our name or trademark, is permitted only with our prior written permission. This report sets forth our findings solely with respect to the test samples identified herein. The results set forth in this report are not indicative or representative of the quality or characteristics of the lot from which a test sample was taken or any similar or identical product unless specifically and expressly noted. Our report includes all of the tests requested by you and the results thereof based upon the information that you provided to us. You have 60 days from date of issuance of this report to notify us of any material error or omission caused by our negligence, provided, however, that such notice shall be in writing and shall specifically address the issue you wish to raise. A failure to raise such issue within the prescribed time shall constitute your unqualified acceptance of the completeness of this report, the tests conducted and the correctness of the report contents. Unless specific mention, the uncertainty of measurement has been explicitly taken into account to declare the compliance or non-compliance to the specification. The report must not be used by the client to claim product certification, approval, or endorsement by TAF or any government agencies.

Table of Contents

Release Control Record	4
1 Certificate of Conformity	5
2 Summary of Test Results	6
2.1 Measurement Uncertainty.....	6
2.2 Modification Record	6
3 General Information	7
3.1 General Description of EUT	7
3.2 Description of Test Modes.....	8
3.2.1 Test Mode Applicability and Tested Channel Detail.....	10
3.3 Duty Cycle of Test Signal	12
3.4 Description of Support Units	13
3.4.1 Configuration of System under Test	13
3.5 General Description of Applied Standards.....	13
4 Test Types and Results	14
4.1 Radiated Emission and Bandedge Measurement	14
4.1.1 Limits of Radiated Emission and Bandedge Measurement	14
4.1.2 Limits of Unwanted Emission Out of the Restricted Bands	15
4.1.3 Test Instruments	16
4.1.4 Test Procedures.....	17
4.1.5 Deviation from Test Standard	17
4.1.6 Test Set Up	18
4.1.7 EUT Operating Conditions.....	19
4.1.8 Test Results	20
4.2 Conducted Emission Measurement.....	59
4.2.1 Limits of Conducted Emission Measurement	59
4.2.2 Test Instruments	59
4.2.3 Test Procedures.....	60
4.2.4 Deviation from Test Standard	60
4.2.5 Test Setup.....	60
4.2.6 EUT Operating Conditions.....	60
4.2.7 Test Results	61
4.3 Transmit Power Measurement.....	63
4.3.1 Limits of Transmit Power Measurement	63
4.3.2 Test Setup.....	63
4.3.3 Test Instruments	64
4.3.4 Test Procedure	64
4.3.5 Deviation from Test Standard	64
4.3.6 EUT Operating Conditions.....	64
4.3.7 Test Result	65
4.4 Occupied Bandwidth Measurement.....	71
4.4.1 Test Setup.....	71
4.4.2 Test Instruments	71
4.4.3 Test Procedure	71
4.4.4 Test Results	72
4.5 Peak Power Spectral Density Measurement	75
4.5.1 Limits of Peak Power Spectral Density Measurement	75
4.5.2 Test Setup.....	75
4.5.3 Test Instruments	75
4.5.4 Test Procedures.....	75
4.5.5 Deviation from Test Standard	76
4.5.6 EUT Operating Conditions.....	76
4.5.7 Test Results	77
4.6 Frequency Stability	83

4.6.1	Limit of Frequency Stability Measurement	83
4.6.2	Test Setup	83
4.6.3	Test Instruments	83
4.6.4	Test Procedure	83
4.6.5	Deviation from Test Standard	83
4.6.6	EUT Operating Condition	83
4.6.7	Test Results	84
4.7	6 dB Bandwidth Measurement.....	85
4.7.1	Limits of 6 dB Bandwidth Measurement.....	85
4.7.2	Test Setup.....	85
4.7.3	Test Instruments	85
4.7.4	Test Procedure	85
4.7.5	Deviation from Test Standard	85
4.7.6	EUT Operating Condition	85
4.7.7	Test Results	86
5	Pictures of Test Arrangements.....	88
	Annex A- Radiated Out of Band Emisison (OOBE) Measurement (For U-NII-3 band)	89
	Appendix – Information on the Testing Laboratories	92

Release Control Record

Issue No.	Description	Date Issued
RF180312C26-5	Original Release	Mar. 31, 2018

1 Certificate of Conformity

Product: Networked Client Set-Top BOX

Brand: technicolor

Test Model: TX061AEI

Sample Status: ENGINEERING SAMPLE

Applicant: PEGATRON CORPORATION

Test Date: Feb. 10, 2018 ~ Mar. 16, 2018

Standards: 47 CFR FCC Part 15, Subpart E (Section 15.407)
ANSI C63.10:2013

The above equipment has been tested by **Bureau Veritas Consumer Products Services (H.K.) Ltd., Taoyuan Branch**, and found compliance with the requirement of the above standards. The test record, data evaluation & Equipment Under Test (EUT) configurations represented herein are true and accurate accounts of the measurements of the sample's RF characteristics under the conditions specified in this report.

Prepared by : Evonne Liu , **Date:** Mar. 31, 2018
Evonne Liu / Specialist

Approved by : Dylan Chiou , **Date:** Mar. 31, 2018
Dylan Chiou / Project Engineer

2 Summary of Test Results

47 CFR FCC Part 15, Subpart E (Section 15.407)			
FCC Clause	Test Item	Result	Remarks
15.407(b)(6)	AC Power Conducted Emissions	Pass	Meet the requirement of limit. Minimum passing margin is -8.89 dB at 0.15000 MHz.
15.407(b) (1/2/3/4(i/ii)/6)	Radiated Emissions & Band Edge Measurement	Pass	Meet the requirement of limit. Minimum passing margin is -0.13 dB at 5648.8 MHz.
15.407(a)(1/2/3)	Max Average Transmit Power	Pass	Meet the requirement of limit.
---	Occupied Bandwidth Measurement	-	Reference only
15.407(a)(1/2/3)	Peak Power Spectral Density	Pass	Meet the requirement of limit.
15.407(e)	6 dB Bandwidth	Pass	Meet the requirement of limit. (U-NII-3 Band only)
15.407(g)	Frequency Stability	Pass	Meet the requirement of limit.
15.203	Antenna Requirement	Pass	No antenna connector is used.

*For U-NII-3 band compliance with rule part 15.407(b)(4)(i), the OOB test plots were recorded in Annex A.

2.1 Measurement Uncertainty

Where relevant, the following measurement uncertainty levels have been estimated for tests performed on the EUT as specified in CISPR 16-4-2:

Measurement	Frequency	Expanded Uncertainty (k=2) (±)
Conducted Emissions at mains ports	150 kHz ~ 30 MHz	2.44 dB
Radiated Emissions up to 1 GHz	30 MHz ~ 200 MHz	2.93 dB
	200 MHz ~ 1000 MHz	2.95 dB
Radiated Emissions above 1 GHz	1 GHz ~ 18 GHz	2.26 dB
	18 GHz ~ 40 GHz	1.94 dB

2.2 Modification Record

There were no modifications required for compliance.

3 General Information

3.1 General Description of EUT

Product	Networked Client Set-Top BOX
Brand	technicolor
Test Model	TX061AEI
Status of EUT	ENGINEERING SAMPLE
Power Supply Rating	5.0 Vdc (adapter)
Modulation Type	256QAM, 64QAM, 16QAM, QPSK, BPSK
Modulation Technology	OFDM
Transfer Rate	802.11a: 54.0/ 48.0/ 36.0/ 24.0/ 18.0/ 12.0/ 9.0/ 6.0 Mbps 802.11n: up to 650Mbps 802.11ac: up to 866.7Mbps
Operating Frequency	5180 ~ 5240 MHz, 5260 ~ 5320 MHz, 5500 ~ 5700 MHz, 5745 ~ 5825 MHz
Number of Channel	5180 ~ 5240 MHz: 4 for 802.11a, 802.11n (HT20) 2 for 802.11n (HT40) 1 for 802.11ac (VHT80) 5260 ~ 5320 MHz: 4 for 802.11a, 802.11n (HT20) 2 for 802.11n (HT40) 1 for 802.11ac (VHT80) 5500 ~ 5700 MHz: 11 for 802.11a, 802.11n (HT20) 5 for 802.11n (HT40) 2 for 802.11ac (VHT80) 5745 ~ 5825 MHz: 5 for 802.11a, 802.11n (HT20) 2 for 802.11n (HT40) 1 for 802.11ac (VHT80)
Output Power	214.67 mW for 5180 ~ 5240 MHz 218.476 mW for 5260 ~ 5320 MHz 183.065 mW for 5500 ~ 5700 MHz 219.152 mW for 5745 ~ 5825 MHz
Antenna Type	PCB antenna with 4.6 dBi gain (Main) / 4.5 dBi gain (Aux.)
Antenna Connector	N/A
Accessory Device	Refer to Note as below
Data Cable Supplied	Refer to Note as below

Note:

- The EUT incorporates a MIMO function. Physically, the EUT provides two completed transmitters and two receivers.

Modulation Mode	Tx Function
802.11a	2TX
802.11n (HT20)	2TX
802.11n (HT40)	2TX
802.11ac (VHT20)	2TX
802.11ac (VHT40)	2TX
802.11ac (VHT80)	2TX

* The modulation and bandwidth are similar for 802.11n mode for HT20 / HT40 and 802.11ac mode for VHT20 / VHT40, therefore investigated worst case to representative mode in test report. (Final test

mode refer section 3.2.1)

2. The EUT contains following accessory devices.

Product	Brand	Model	Description
Adapter 1	Lite-On	EPS-10	I/P: 100-120 Vac, 60 Hz, 0.8 A O/P: 5 Vdc, 3 A
Adapter 2	Comcast	EPS-10	I/P: 100-120 Vac, 60 Hz, 0.8 A O/P: 5 Vdc, 3 A
Adapter 3	AcBel	EPS-10	I/P: 100-120 Vac, 60 Hz, 0.4 A O/P: 5 Vdc, 3 A

3. The above EUT information is declared by manufacturer and for more detailed features description, please refer to the manufacturer's specifications or user's manual.

3.2 Description of Test Modes

For 5180 ~ 5240 MHz

4 channels are provided for 802.11a, 802.11n (HT20):

Channel	Frequency (MHz)	Channel	Frequency (MHz)
36	5180	44	5220
40	5200	48	5240

2 channels are provided for 802.11n (HT40):

Channel	Frequency (MHz)	Channel	Frequency (MHz)
38	5190	46	5230

1 channel is provided for 802.11ac (VHT80):

Channel	Frequency (MHz)
42	5210

For 5260 ~ 5320 MHz

4 channels are provided for 802.11a, 802.11n (HT20):

Channel	Frequency (MHz)	Channel	Frequency (MHz)
52	5260	60	5300
56	5280	64	5320

2 channels are provided for 802.11n (HT40):

Channel	Frequency (MHz)	Channel	Frequency (MHz)
54	5270	62	5310

1 channel is provided for 802.11ac (VHT80):

Channel	Frequency (MHz)
58	5290

For 5500 ~ 5700 MHz

11 channels are provided for 802.11a, 802.11n (HT20):

Channel	Frequency (MHz)	Channel	Frequency (MHz)
100	5500	124	5620
104	5520	128	5640
108	5540	132	5660
112	5560	136	5680
116	5580	140	5700
120	5600		

5 channels are provided for 802.11n (HT40):

Channel	Frequency (MHz)	Channel	Frequency (MHz)
102	5510	126	5630
110	5550	134	5670
118	5590		

2 channels are provided for 802.11ac (VHT80):

Channel	Frequency (MHz)	Channel	Frequency (MHz)
106	5530	122	5610

For 5745 ~ 5825 MHz:

5 channels are provided for 802.11a, 802.11n (HT20):

Channel	Frequency (MHz)	Channel	Frequency (MHz)
149	5745	161	5805
153	5765	165	5825
157	5785		

2 channels are provided for 802.11n (HT40):

Channel	Frequency (MHz)	Channel	Frequency (MHz)
151	5755	159	5795

1 channel is provided for 802.11ac (VHT80):

Channel	Frequency (MHz)
155	5775

3.2.1 Test Mode Applicability and Tested Channel Detail

EUT Configure Mode	Applicable To				Description
	RE \geq 1G	RE $<$ 1G	PLC	APCM	
-	√	√	√	√	-

Where **RE \geq 1G**: Radiated Emission above 1 GHz

RE $<$ 1G: Radiated Emission below 1 GHz

PLC: Power Line Conducted Emission

APCM: Antenna Port Conducted Measurement

Note:

1. The EUT had been pre-tested on the positioned of each 3 axis. The worst case was found when positioned on **Z-plane**.
2. "-" means no effect.

Radiated Emission Test (Above 1 GHz):

- Pre-Scan has been conducted to determine the worst-case mode from all possible combinations between available modulations, data rates and antenna ports (if EUT with antenna diversity architecture).
- Following channel(s) was (were) selected for the final test as listed below.

EUT Configure Mode	Frequency Band (MHz)	Mode	Available Channel	Tested Channel	Modulation Technology	Modulation Type	Data Rate (Mbps)
-	5180-5240	802.11a	36 to 48	36, 44, 48	OFDM	BPSK	6.0
-		802.11n (HT20)	36 to 48	36, 44, 48	OFDM	BPSK	MCS0
-		802.11n (HT40)	38 to 46	38, 46	OFDM	BPSK	MCS0
-		802.11ac (VHT80)	42	42	OFDM	BPSK	MCS0
-	5260-5320	802.11a	52 to 64	52, 60, 64	OFDM	BPSK	6.0
-		802.11n (HT20)	52 to 64	52, 60, 64	OFDM	BPSK	MCS0
-		802.11n (HT40)	54 to 62	54, 62	OFDM	BPSK	MCS0
-		802.11ac (VHT80)	58	58	OFDM	BPSK	MCS0
-	5500-5700	802.11a	100 to 140	100, 116, 140	OFDM	BPSK	6.0
-		802.11n (HT20)	100 to 140	100, 116, 140	OFDM	BPSK	MCS0
-		802.11n (HT40)	102 to 134	102, 110, 134	OFDM	BPSK	MCS0
-		802.11ac (VHT80)	106 to 122	106, 122	OFDM	BPSK	MCS0
-	5745-5825	802.11a	149 to 165	149, 157, 165	OFDM	BPSK	6.0
-		802.11n (HT20)	149 to 165	149, 157, 165	OFDM	BPSK	MCS0
-		802.11n (HT40)	151 to 159	151, 159	OFDM	BPSK	MCS0
-		802.11ac (VHT80)	155	155	OFDM	BPSK	MCS0

Radiated Emission Test (Below 1 GHz):

- Pre-Scan has been conducted to determine the worst-case mode from all possible combinations between available modulations, data rates and antenna ports (if EUT with antenna diversity architecture).
- Following channel(s) was (were) selected for the final test as listed below.

EUT Configure Mode	Frequency Band (MHz)	Mode	Available Channel	Tested Channel	Modulation Technology	Modulation Type	Data Rate (Mbps)
AcBel	5745-5825	802.11ac (VHT80)	155	155	OFDM	BPSK	MCS0

Power Line Conducted Emission Test:

- Pre-Scan has been conducted to determine the worst-case mode from all possible combinations between available modulations, data rates and antenna ports (if EUT with antenna diversity architecture).
- Following channel(s) was (were) selected for the final test as listed below.

EUT Configure Mode	Frequency Band (MHz)	Mode	Available Channel	Tested Channel	Modulation Technology	Modulation Type	Data Rate (Mbps)
-	5745-5825	802.11ac (VHT80)	155	155	OFDM	BPSK	MCS0

Antenna Port Conducted Measurement:

- This item includes all test value of each mode, but only includes spectrum plot of worst value of each mode.
- Pre-Scan has been conducted to determine the worst-case mode from all possible combinations between available modulations, data rates and antenna ports (if EUT with antenna diversity architecture).
- Following channel(s) was (were) selected for the final test as listed below.

EUT Configure Mode	Frequency Band (MHz)	Mode	Available Channel	Tested Channel	Modulation Technology	Modulation Type	Data Rate (Mbps)
-	5180-5240	802.11a	36 to 48	36, 44, 48	OFDM	BPSK	6.0
-		802.11n (HT20)	36 to 48	36, 44, 48	OFDM	BPSK	MCS0
-		802.11n (HT40)	38 to 46	38, 46	OFDM	BPSK	MCS0
-		802.11ac (VHT80)	42	42	OFDM	BPSK	MCS0
-	5260-5320	802.11a	52 to 64	52, 60, 64	OFDM	BPSK	6.0
-		802.11n (HT20)	52 to 64	52, 60, 64	OFDM	BPSK	MCS0
-		802.11n (HT40)	54 to 62	54, 62	OFDM	BPSK	MCS0
-		802.11ac (VHT80)	58	58	OFDM	BPSK	MCS0
-	5500-5700	802.11a	100 to 140	100, 116, 140	OFDM	BPSK	6.0
-		802.11n (HT20)	100 to 140	100, 116, 140	OFDM	BPSK	MCS0
-		802.11n (HT40)	102 to 134	102, 110, 134	OFDM	BPSK	MCS0
-		802.11ac (VHT80)	106 to 122	106, 122	OFDM	BPSK	MCS0
-	5745-5825	802.11a	149 to 165	149, 157, 165	OFDM	BPSK	6.0
-		802.11n (HT20)	149 to 165	149, 157, 165	OFDM	BPSK	MCS0
-		802.11n (HT40)	151 to 159	151, 159	OFDM	BPSK	MCS0
-		802.11ac (VHT80)	155	155	OFDM	BPSK	MCS0

Test Condition:

Applicable To	Environmental Conditions	Input Power	Tested by
RE≥1G	25 deg. C, 65 % RH	120 Vac, 60 Hz	Getaz Yang
RE<1G	25 deg. C, 65 % RH	120 Vac, 60 Hz	Getaz Yang
PLC	25 deg. C, 65 % RH	120 Vac, 60 Hz	Getaz Yang
APCM	25 deg. C, 65 % RH	120 Vac, 60 Hz	Vincent Yang

3.3 Duty Cycle of Test Signal

MODULATION TYPE: BPSK

Duty cycle of test signal is < 98 %, duty factor is required.

802.11a: Duty cycle = 2.064/2.235 = 0.923, Duty factor = $10 * \log(1/0.923) = 0.35$

802.11n (HT20): Duty cycle = 0.982/1.135 = 0.865, Duty factor = $10 * \log(1/0.865) = 0.63$

802.11n (HT40): Duty cycle = 0.496/0.652 = 0.761, Duty factor = $10 * \log(1/0.761) = 1.19$

802.11ac (VHT80): Duty cycle = 0.462/0.57 = 0.811, Duty factor = $10 * \log(1/0.811) = 0.91$

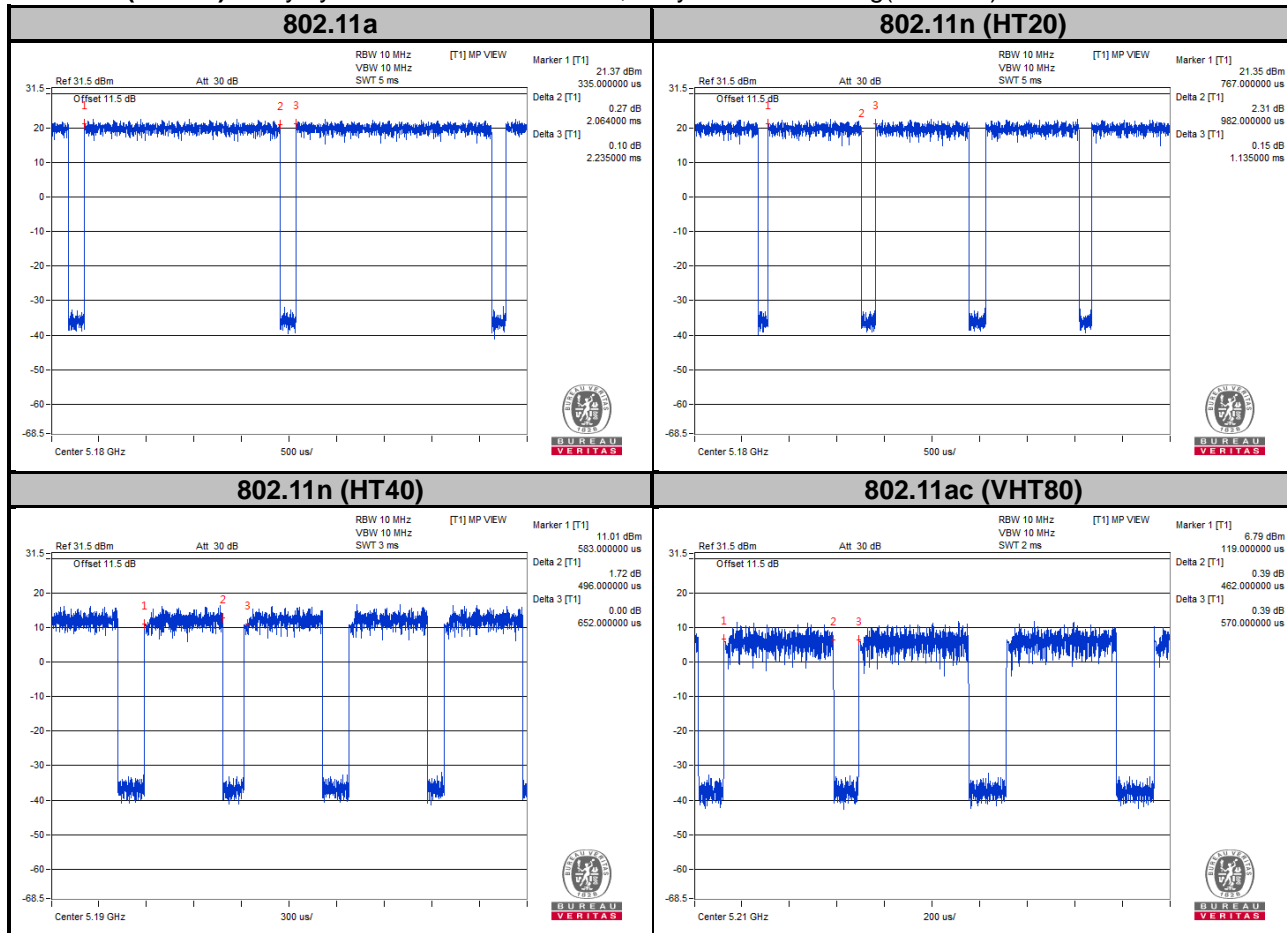

3.4 Description of Support Units

The EUT has been tested as an independent unit together with other necessary accessories or support units.

3.4.1 Configuration of System under Test

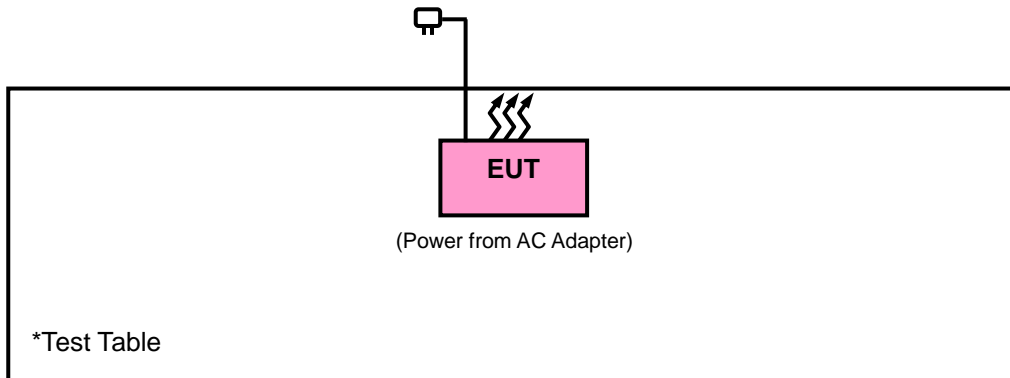

3.5 General Description of Applied Standards

The EUT is a RF Product. According to the specifications of the manufacturer, it must comply with the requirements of the following standards:

FCC Part 15, Subpart E (15.407)

789033 D02 General UNII Test Procedures New Rules v02r01

ANSI C63.10-2013

All test items have been performed and recorded as per the above standards.

4 Test Types and Results

4.1 Radiated Emission and Bandedge Measurement

4.1.1 Limits of Radiated Emission and Bandedge Measurement

Radiated emissions which fall in the restricted bands must comply with the radiated emission limits specified as below table. Other emissions shall be at least 20 dB below the highest level of the desired power:

Frequencies (MHz)	Field Strength (microvolts/meter)	Measurement Distance (meters)
0.009 ~ 0.490	2400/F (kHz)	300
0.490 ~ 1.705	24000/F (kHz)	30
1.705 ~ 30.0	30	30
30 ~ 88	100	3
88 ~ 216	150	3
216 ~ 960	200	3
Above 960	500	3

Note:

1. The lower limit shall apply at the transition frequencies.
2. Emission level (dBuV/m) = 20 log Emission level (uV/m).
3. For frequencies above 1000 MHz, the field strength limits are based on average detector, however, the peak field strength of any emission shall not exceed the maximum permitted average limits, specified above by more than 20 dB under any condition of modulation.

4.1.2 Limits of Unwanted Emission Out of the Restricted Bands

Applicable To		Limit	
789033 D02 General UNII Test Procedures New Rules v02r01		Field Strength at 3 m	
		PK: 74 (dBµV/m)	AV: 54 (dBµV/m)
Frequency Band	Applicable To	EIRP Limit	Equivalent Field Strength at 3 m
5150~5250 MHz	15.407(b)(1)	PK: -27 (dBm/MHz)	PK: 68.2 (dBµV/m)
5250~5350 MHz	15.407(b)(2)		
5470~5725 MHz	15.407(b)(3)		
5725~5850 MHz	15.407(b)(4)(i)	PK:-27 (dBm/MHz) ^{*1} PK:10 (dBm/MHz) ^{*2} PK:15.6 (dBm/MHz) ^{*3} PK:27 (dBm/MHz) ^{*4}	PK: 68.2 (dBµV/m) ^{*1} PK:105.2 (dBµV/m) ^{*2} PK: 110.8 (dBµV/m) ^{*3} PK:122.2 (dBµV/m) ^{*4}
	15.407(b)(4)(ii)	Emission limits in section 15.247(d)	

^{*1} beyond 75 MHz or more above of the band edge.

^{*2} below the band edge increasing linearly to 10 dBm/MHz at 25 MHz above.

^{*3} below the band edge increasing linearly to a level of 15.6 dBm/MHz at 5 MHz above.

^{*4} from 5 MHz above or below the band edge increasing linearly to a level of 27 dBm/MHz at the band edge.

Note:

The following formula is used to convert the equipment isotropic radiated power (eirp) to field strength:

$$E = \frac{1000000\sqrt{30P}}{3} \mu\text{V/m, where P is the eirp (Watts).}$$

4.1.3 Test Instruments

Description & Manufacturer	Model No.	Serial No.	Date of Calibration	Due Date of Calibration
Test Receiver Agilent	N9038A	MY51210137	Jun. 23, 2017	Jun. 22, 2018
Spectrum Analyzer Agilent	N9010A	MY52220314	Nov. 24, 2017	Nov. 23, 2018
Spectrum Analyzer ROHDE & SCHWARZ	FSU43	101261	Jan. 11, 2018	Jan. 10, 2019
BILOG Antenna SCHWARZBECK	VULB9168	9168-472	Dec. 06, 2017	Dec. 05, 2018
HORN Antenna SCHWARZBECK	BBHA 9120 D	9120D-969	Dec. 12, 2017	Dec. 11, 2018
HORN Antenna SCHWARZBECK	BBHA 9170	9170-480	Dec. 01, 2017	Nov. 30, 2018
Fixed Attenuator Mini-Circuits	MDCS18N-10	MDCS18N-10-01	Apr. 17, 2017	Apr. 16, 2018
Loop Antenna	HLA 6121	45745	May 19, 2017	May 18, 2018
Preamplifier EMCI	EMC001340	980201	Nov. 01, 2017	Oct. 31, 2018
Bluetooth Tester	CBT	100946	Jul. 29, 2016	Jul. 28, 2018
Preamplifier EMCI	EMC 012645	980115	Oct. 20, 2017	Oct. 19, 2018
Preamplifier EMCI	EMC 184045	980116	Oct. 20, 2017	Oct. 19, 2018
Preamplifier EMCI	EMC 330H	980112	Oct. 13, 2017	Oct. 12, 2018
Power Meter Anritsu	ML2495A	1012010	Aug. 15, 2017	Aug. 14, 2018
Power Sensor Anritsu	MA2411B	1315050	Aug. 15, 2017	Aug. 14, 2018
RF Coaxial Cable HUBER+SUHNNER	EMC104-SM-SM-8 000&3000	140811+170717	Oct. 20, 2017	Oct. 19, 2018
RF Coaxial Cable HUBER+SUHNNER	SUCOFLEX 104	EMC104-SM-SM- 1000(140807)	Oct. 20, 2017	Oct. 19, 2018
RF Coaxial Cable Worken	8D-FB	Cable-Ch10-01	Oct. 20, 2017	Oct. 19, 2018
Software BV ADT	E3 6.120103	NA	NA	NA
Antenna Tower MF	MFA-440H	NA	NA	NA
Turn Table MF	MFT-201SS	NA	NA	NA
Antenna Tower & Turn Table Controller MF	MF-7802	NA	NA	NA

- Note: 1. The calibration interval of the above test instruments is 12 / 24 months and the calibrations are traceable to NML/ROC and NIST/USA.
2. The test was performed in HwaYa Chamber 10.
3. The horn antenna and preamplifier (model: EMC 184045) are used only for the measurement of emission frequency above 1 GHz if tested.
4. The IC Site Registration No. is IC7450F-10.

4.1.4 Test Procedures

- a. The EUT was placed on the top of a rotating table 0.8 meters (for below 1 GHz) / 1.5 meters (for above 1 GHz) above the ground at 3 meter chamber room for test. The table was rotated 360 degrees to determine the position of the highest radiation.
- b. The EUT was set 3 meters away from the interference-receiving antenna, which was mounted on the top of a variable-height antenna tower.
- c. The height of antenna is varied from one meter to four meters above the ground to determine the maximum value of the field strength. Both horizontal and vertical polarizations of the antenna are set to make the measurement.
- d. For each suspected emission, the EUT was arranged to its worst case and then the antenna was tuned to heights from 1 meter to 4 meters and the rotatable table was turned from 0 degrees to 360 degrees to find the maximum reading.
- e. The test-receiver system was set to quasi-peak detect function and specified bandwidth with maximum hold mode when the test frequency is below 1 GHz.
- f. The test-receiver system was set to peak and average detected function and specified bandwidth with maximum hold mode when the test frequency is above 1 GHz. If the peak reading value also meets average limit, measurement with the average detector is unnecessary.

Note:

1. The resolution bandwidth and video bandwidth of test receiver/spectrum analyzer is 120 kHz & 360 kHz for Quasi-peak detection (QP) at frequency below 1 GHz.
2. The resolution bandwidth of test receiver/spectrum analyzer is 1 MHz and the video bandwidth is 3 MHz for Peak detection (PK) at frequency above 1 GHz.
3. The resolution bandwidth of test receiver/spectrum analyzer is 1 MHz and the video bandwidth is 1/T for Average (Duty cycle < 98 %) detection at frequency above 1 GHz.
4. The resolution bandwidth of test receiver/spectrum analyzer is 1 MHz and the video bandwidth is 10 Hz (Duty cycle \geq 98 %) for Average detection (AV) at frequency above 1 GHz.
5. All modes of operation were investigated and the worst-case emissions are reported.

4.1.5 Deviation from Test Standard

No deviation.

4.1.6 Test Set Up

<Radiated emission below 30 MHz>

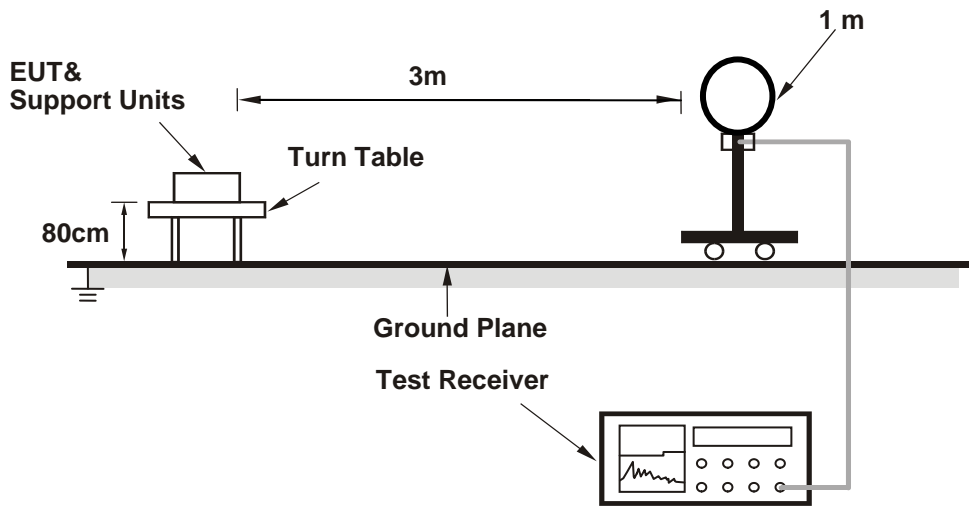

<Frequency Range below 1 GHz>

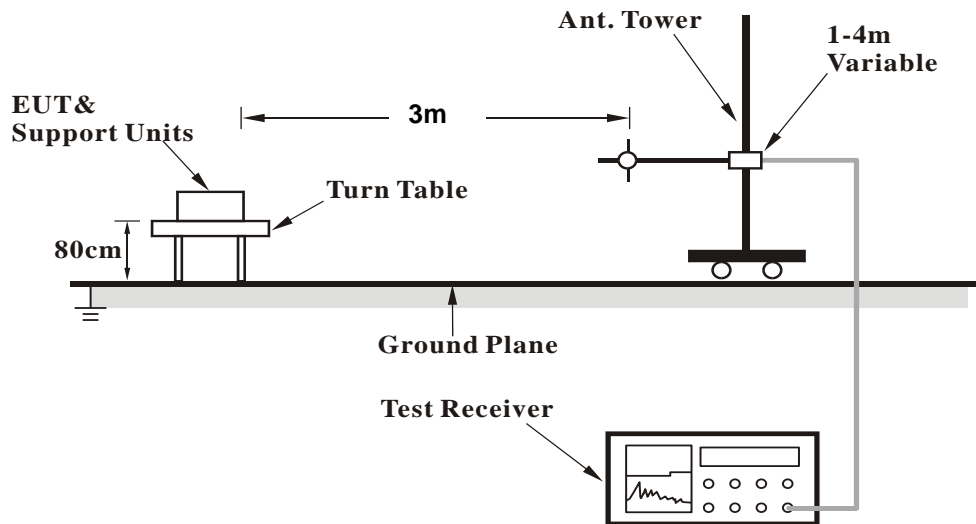

<Frequency Range above 1 GHz>

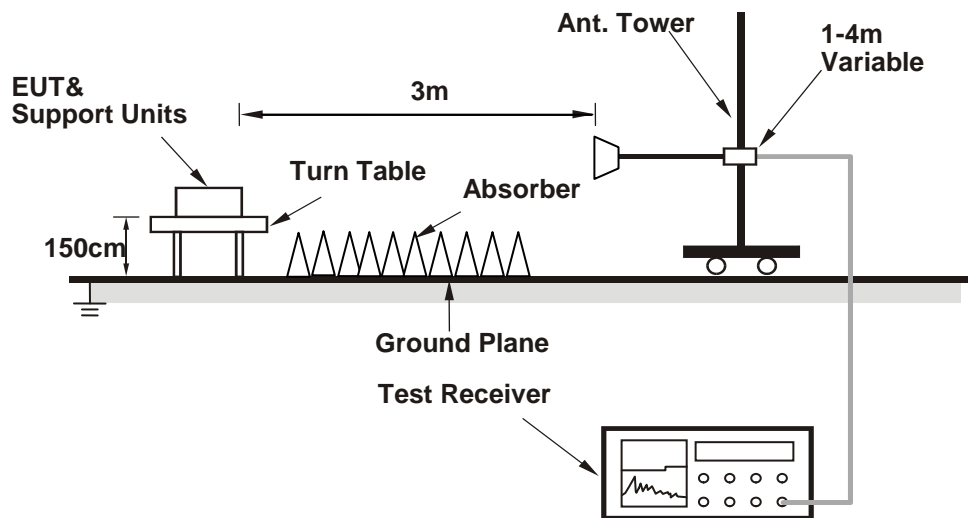

For the actual test configuration, please refer to the attached file (Test Setup Photo).

4.1.7 EUT Operating Conditions

- Placed the EUT on a testing table.
- Use the software to control the EUT under transmission condition continuously at specific channel frequency.

4.1.8 Test Results

Above 1 GHz Data :

802.11a

EUT Test Condition		Measurement Detail	
Channel	Channel 36	Frequency Range	1 GHz ~ 40 GHz
Input Power	120 Vac, 60 Hz	Detector Function	Peak (PK) Average (AV)
Environmental Conditions	25 deg. C, 65 % RH	Tested By	Getaz Yang

Antenna Polarity & Test Distance: Horizontal at 3 m										
Frequency (MHz)	Emission Level (dBuV/m)	Read Level (dBuV)	Limit (dBuV/m)	Margin (dB)	Antenna Factor (dB/m)	Cable Loss (dB)	Preamp Factor (dB)	Antenna Height (cm)	Table Angle (Degree)	Remark
5149.04	51.04	50.46	54	-2.96	31.56	6.34	37.32	204	15	Average
5149.04	64.88	64.3	74	-9.12	31.56	6.34	37.32	204	15	Peak
5180	102.83	102.21			31.59	6.37	37.34	204	15	Average
5180	111.8	111.18			31.59	6.37	37.34	204	15	Peak
*10360	56.07	58.83	68.2	-12.13	39.48	10.21	52.45	125	123	Peak
Antenna Polarity & Test Distance: Vertical at 3 m										
Frequency (MHz)	Emission Level (dBuV/m)	Read Level (dBuV)	Limit (dBuV/m)	Margin (dB)	Antenna Factor (dB/m)	Cable Loss (dB)	Preamp Factor (dB)	Antenna Height (cm)	Table Angle (Degree)	Remark
5149.94	53.65	53.07	54	-0.35	31.56	6.34	37.32	210	289	Average
5149.94	65.66	65.08	74	-8.34	31.56	6.34	37.32	210	289	Peak
5180	104.82	104.2			31.59	6.37	37.34	210	289	Average
5180	113.53	112.91			31.59	6.37	37.34	210	289	Peak
*10360	54.99	57.75	68.2	-13.21	39.48	10.21	52.45	222	236	Peak

Remarks:

- Emission Level = Read Level + Antenna Factor + Cable Loss - Preamp Factor
Margin value = Emission level – Limit value
- 5180 MHz: Fundamental Frequency
- *: Out of Restricted Band

EUT Test Condition		Measurement Detail	
Channel	Channel 44	Frequency Range	1 GHz ~ 40 GHz
Input Power	120 Vac, 60 Hz	Detector Function	Peak (PK) Average (AV)
Environmental Conditions	25 deg. C, 65 % RH	Tested By	Getaz Yang

Antenna Polarity & Test Distance: Horizontal at 3 m										
Frequency (MHz)	Emission Level (dBuV/m)	Read Level (dBuV)	Limit (dBuV/m)	Margin (dB)	Antenna Factor (dB/m)	Cable Loss (dB)	Preamp Factor (dB)	Antenna Height (cm)	Table Angle (Degree)	Remark
5124.02	41.29	40.73	54	-12.71	31.55	6.31	37.3	163	0	Average
5124.02	52.18	51.62	74	-21.82	31.55	6.31	37.3	163	0	Peak
5220	103.66	103.01			31.61	6.4	37.36	163	0	Average
5220	112.05	111.4			31.61	6.4	37.36	163	0	Peak
5364.96	39.66	38.65	54	-14.34	31.72	6.47	37.18	163	0	Average
5364.96	51.9	50.89	74	-22.1	31.72	6.47	37.18	163	0	Peak
*10440	54.47	57.23	68.2	-13.73	39.55	10.21	52.52	236	251	Peak

Antenna Polarity & Test Distance: Vertical at 3 m										
Frequency (MHz)	Emission Level (dBuV/m)	Read Level (dBuV)	Limit (dBuV/m)	Margin (dB)	Antenna Factor (dB/m)	Cable Loss (dB)	Preamp Factor (dB)	Antenna Height (cm)	Table Angle (Degree)	Remark
5127.26	41.42	40.85	54	-12.58	31.55	6.32	37.3	208	273	Average
5127.26	52.69	52.12	74	-21.31	31.55	6.32	37.3	208	273	Peak
5220	105.05	104.4			31.61	6.4	37.36	208	273	Average
5220	113.44	112.79			31.61	6.4	37.36	208	273	Peak
5379.92	39.18	38.16	54	-14.82	31.73	6.47	37.18	208	273	Average
5379.92	52.33	51.31	74	-21.67	31.73	6.47	37.18	208	273	Peak
*10440	54.25	57.01	68.2	-13.95	39.55	10.21	52.52	125	231	Peak

Remarks:

- Emission Level = Read Level + Antenna Factor + Cable Loss - Preamp Factor
Margin value = Emission level – Limit value
- 5220 MHz: Fundamental Frequency
- *: Out of Restricted Band

EUT Test Condition		Measurement Detail	
Channel	Channel 48	Frequency Range	1 GHz ~ 40 GHz
Input Power	120 Vac, 60 Hz	Detector Function	Peak (PK) Average (AV)
Environmental Conditions	25 deg. C, 65 % RH	Tested By	Getaz Yang

Antenna Polarity & Test Distance: Horizontal at 3 m										
Frequency (MHz)	Emission Level (dBuV/m)	Read Level (dBuV)	Limit (dBuV/m)	Margin (dB)	Antenna Factor (dB/m)	Cable Loss (dB)	Preamp Factor (dB)	Antenna Height (cm)	Table Angle (Degree)	Remark
5125.28	41.55	40.98	54	-12.45	31.55	6.32	37.3	161	0	Average
5125.28	52.45	51.88	74	-21.55	31.55	6.32	37.3	161	0	Peak
5240	102.77	102.05			31.62	6.42	37.32	161	0	Average
5240	112.72	112			31.62	6.42	37.32	161	0	Peak
5416.88	39.51	38.46	54	-14.49	31.75	6.48	37.18	161	0	Average
5416.88	52	50.95	74	-22	31.75	6.48	37.18	161	0	Peak
*10480	53.34	56.18	68.2	-14.86	39.6	10.22	52.66	203	251	Peak
Antenna Polarity & Test Distance: Vertical at 3 m										
Frequency (MHz)	Emission Level (dBuV/m)	Read Level (dBuV)	Limit (dBuV/m)	Margin (dB)	Antenna Factor (dB/m)	Cable Loss (dB)	Preamp Factor (dB)	Antenna Height (cm)	Table Angle (Degree)	Remark
5147.6	41.55	40.97	54	-12.45	31.56	6.34	37.32	203	263	Average
5147.6	52.38	51.8	74	-21.62	31.56	6.34	37.32	203	263	Peak
5240	104.21	103.49			31.62	6.42	37.32	203	263	Average
5240	113.88	113.16			31.62	6.42	37.32	203	263	Peak
5390.7	39.03	38.01	54	-14.97	31.73	6.47	37.18	203	263	Average
5390.7	51.96	50.94	74	-22.04	31.73	6.47	37.18	203	263	Peak
*10480	53.14	55.98	68.2	-15.06	39.6	10.22	52.66	256	236	Peak

Remarks:

- Emission Level = Read Level + Antenna Factor + Cable Loss - Preamp Factor
Margin value = Emission level – Limit value
- 5240 MHz: Fundamental Frequency
- *: Out of Restricted Band

EUT Test Condition		Measurement Detail	
Channel	Channel 52	Frequency Range	1 GHz ~ 40 GHz
Input Power	120 Vac, 60 Hz	Detector Function	Peak (PK) Average (AV)
Environmental Conditions	25 deg. C, 65 % RH	Tested By	Getaz Yang

Antenna Polarity & Test Distance: Horizontal at 3 m										
Frequency (MHz)	Emission Level (dBuV/m)	Read Level (dBuV)	Limit (dBuV/m)	Margin (dB)	Antenna Factor (dB/m)	Cable Loss (dB)	Preamp Factor (dB)	Antenna Height (cm)	Table Angle (Degree)	Remark
5090.9	39.27	38.73	54	-14.73	31.53	6.28	37.27	206	352	Average
5090.9	52.49	51.95	74	-21.51	31.53	6.28	37.27	206	352	Peak
5260	103.87	103.06			31.65	6.43	37.27	206	352	Average
5260	112.2	111.39			31.65	6.43	37.27	206	352	Peak
5356.27	40.83	39.84	54	-13.17	31.7	6.47	37.18	206	352	Average
5356.27	53.2	52.21	74	-20.8	31.7	6.47	37.18	206	352	Peak
*10520	54.95	57.75	68.2	-13.25	39.66	10.27	52.73	102	236	Peak
Antenna Polarity & Test Distance: Vertical at 3 m										
Frequency (MHz)	Emission Level (dBuV/m)	Read Level (dBuV)	Limit (dBuV/m)	Margin (dB)	Antenna Factor (dB/m)	Cable Loss (dB)	Preamp Factor (dB)	Antenna Height (cm)	Table Angle (Degree)	Remark
5143.28	39.59	39	54	-14.41	31.56	6.33	37.3	200	339	Average
5143.28	51.95	51.36	74	-22.05	31.56	6.33	37.3	200	339	Peak
5260	105.47	104.66			31.65	6.43	37.27	200	339	Average
5260	113.5	112.69			31.65	6.43	37.27	200	339	Peak
5456.48	40.69	39.49	54	-13.31	31.77	6.51	37.08	200	339	Average
5456.48	51.65	50.45	74	-22.35	31.77	6.51	37.08	200	339	Peak
*10520	56.72	59.52	68.2	-11.48	39.66	10.27	52.73	203	256	Peak

Remarks:

- Emission Level = Read Level + Antenna Factor + Cable Loss - Preamp Factor
Margin value = Emission level – Limit value
- 5260 MHz: Fundamental Frequency
- *: Out of Restricted Band

EUT Test Condition		Measurement Detail	
Channel	Channel 60	Frequency Range	1 GHz ~ 40 GHz
Input Power	120 Vac, 60 Hz	Detector Function	Peak (PK) Average (AV)
Environmental Conditions	25 deg. C, 65 % RH	Tested By	Getaz Yang

Antenna Polarity & Test Distance: Horizontal at 3 m										
Frequency (MHz)	Emission Level (dBuV/m)	Read Level (dBuV)	Limit (dBuV/m)	Margin (dB)	Antenna Factor (dB/m)	Cable Loss (dB)	Preamp Factor (dB)	Antenna Height (cm)	Table Angle (Degree)	Remark
5140.94	39.32	38.73	54	-14.68	31.56	6.33	37.3	215	347	Average
5140.94	51.05	50.46	74	-22.95	31.56	6.33	37.3	215	347	Peak
5300	103.98	103.04			31.67	6.46	37.19	215	347	Average
5300	112.75	111.81			31.67	6.46	37.19	215	347	Peak
5350.22	45.29	44.3	54	-8.71	31.7	6.47	37.18	215	347	Average
5350.22	56.79	55.8	74	-17.21	31.7	6.47	37.18	215	347	Peak
10600	43.69	46.52	54	-10.31	39.85	10.43	53.11	102	236	Average
10600	54.02	56.85	74	-19.98	39.85	10.43	53.11	102	236	Peak

Antenna Polarity & Test Distance: Vertical at 3 m										
Frequency (MHz)	Emission Level (dBuV/m)	Read Level (dBuV)	Limit (dBuV/m)	Margin (dB)	Antenna Factor (dB/m)	Cable Loss (dB)	Preamp Factor (dB)	Antenna Height (cm)	Table Angle (Degree)	Remark
5027.72	40.41	39.94	54	-13.59	31.48	6.23	37.24	196	336	Average
5027.72	51.77	51.3	74	-22.23	31.48	6.23	37.24	196	336	Peak
5300	105.76	104.82			31.67	6.46	37.19	196	336	Average
5300	113.33	112.39			31.67	6.46	37.19	196	336	Peak
5351.43	43.38	42.39	54	-10.62	31.7	6.47	37.18	196	336	Average
5351.43	55.51	54.52	74	-18.49	31.7	6.47	37.18	196	336	Peak
10600	43.42	46.25	54	-10.58	39.85	10.43	53.11	152	236	Average
10600	53.69	56.52	74	-20.31	39.85	10.43	53.11	152	236	Peak

Remarks:

- Emission Level = Read Level + Antenna Factor + Cable Loss - Preamp Factor
Margin value = Emission level – Limit value
- 5300 MHz: Fundamental Frequency
- *: Out of Restricted Band

EUT Test Condition		Measurement Detail	
Channel	Channel 64	Frequency Range	1 GHz ~ 40 GHz
Input Power	120 Vac, 60 Hz	Detector Function	Peak (PK) Average (AV)
Environmental Conditions	25 deg. C, 65 % RH	Tested By	Getaz Yang

Antenna Polarity & Test Distance: Horizontal at 3 m										
Frequency (MHz)	Emission Level (dBuV/m)	Read Level (dBuV)	Limit (dBuV/m)	Margin (dB)	Antenna Factor (dB/m)	Cable Loss (dB)	Preamp Factor (dB)	Antenna Height (cm)	Table Angle (Degree)	Remark
5320	103.78	102.83			31.68	6.46	37.19	213	350	Average
5320	112.77	111.82			31.68	6.46	37.19	213	350	Peak
5350.11	53.71	52.72	54	-0.29	31.7	6.47	37.18	213	350	Average
5350.11	66.35	65.36	74	-7.65	31.7	6.47	37.18	213	350	Peak
10640	44.52	47.3	54	-9.48	39.93	10.36	53.07	255	236	Average
10640	54.42	57.2	74	-19.58	39.93	10.36	53.07	255	236	Peak

Antenna Polarity & Test Distance: Vertical at 3 m										
Frequency (MHz)	Emission Level (dBuV/m)	Read Level (dBuV)	Limit (dBuV/m)	Margin (dB)	Antenna Factor (dB/m)	Cable Loss (dB)	Preamp Factor (dB)	Antenna Height (cm)	Table Angle (Degree)	Remark
5320	105.64	104.69			31.68	6.46	37.19	197	323	Average
5320	113.93	112.98			31.68	6.46	37.19	197	323	Peak
5350.22	53.8	52.81	54	-0.2	31.7	6.47	37.18	197	323	Average
5350.22	65.6	64.61	74	-8.4	31.7	6.47	37.18	197	323	Peak
10640	43.47	46.25	54	-10.53	39.93	10.36	53.07	256	236	Average
10640	53.79	56.57	74	-20.21	39.93	10.36	53.07	256	236	Peak

Remarks:

- Emission Level = Read Level + Antenna Factor + Cable Loss - Preamp Factor
Margin value = Emission level – Limit value
- 5320 MHz: Fundamental Frequency
- *: Out of Restricted Band

EUT Test Condition		Measurement Detail	
Channel	Channel 100	Frequency Range	1 GHz ~ 40 GHz
Input Power	120 Vac, 60 Hz	Detector Function	Peak (PK) Average (AV)
Environmental Conditions	25 deg. C, 65 % RH	Tested By	Getaz Yang

Antenna Polarity & Test Distance: Horizontal at 3 m										
Frequency (MHz)	Emission Level (dBuV/m)	Read Level (dBuV)	Limit (dBuV/m)	Margin (dB)	Antenna Factor (dB/m)	Cable Loss (dB)	Preamp Factor (dB)	Antenna Height (cm)	Table Angle (Degree)	Remark
5459.92	48.88	47.89	54	-5.12	31.56	6.51	37.08	176	6	Average
5459.92	63.92	62.93	74	-10.08	31.56	6.51	37.08	176	6	Peak
*5470	66.69	65.68	68.2	-1.51	31.57	6.52	37.08	176	6	Peak
5500	103.86	102.75			31.6	6.54	37.03	176	6	Average
5500	113.62	112.51			31.6	6.54	37.03	176	6	Peak
*5725	50.45	49.16	68.2	-17.75	31.96	6.76	37.43	176	6	Peak
11000	44.95	46.85	54	-9.05	40.73	10.4	53.03	185	236	Average
11000	55.05	56.95	74	-18.95	40.73	10.4	53.03	185	236	Peak

Antenna Polarity & Test Distance: Vertical at 3 m										
Frequency (MHz)	Emission Level (dBuV/m)	Read Level (dBuV)	Limit (dBuV/m)	Margin (dB)	Antenna Factor (dB/m)	Cable Loss (dB)	Preamp Factor (dB)	Antenna Height (cm)	Table Angle (Degree)	Remark
5458	47.69	46.7	54	-6.31	31.56	6.51	37.08	165	354	Average
5458	61.84	60.85	74	-12.16	31.56	6.51	37.08	165	354	Peak
*5470	67.81	66.8	68.2	-0.39	31.57	6.52	37.08	165	354	Peak
5500	105.5	104.39			31.6	6.54	37.03	165	354	Average
5500	114.36	113.25			31.6	6.54	37.03	165	354	Peak
*5725	50.79	49.5	68.2	-17.41	31.96	6.76	37.43	165	354	Peak
11000	43.35	45.25	54	-10.65	40.73	10.4	53.03	125	236	Average
11000	53.21	55.11	74	-20.79	40.73	10.4	53.03	125	236	Peak

Remarks:

- Emission Level = Read Level + Antenna Factor + Cable Loss - Preamp Factor
Margin value = Emission level – Limit value
- 5500 MHz: Fundamental Frequency
- *: Out of Restricted Band

EUT Test Condition		Measurement Detail	
Channel	Channel 116	Frequency Range	1 GHz ~ 40 GHz
Input Power	120 Vac, 60 Hz	Detector Function	Peak (PK) Average (AV)
Environmental Conditions	25 deg. C, 65 % RH	Tested By	Getaz Yang

Antenna Polarity & Test Distance: Horizontal at 3 m										
Frequency (MHz)	Emission Level (dBuV/m)	Read Level (dBuV)	Limit (dBuV/m)	Margin (dB)	Antenna Factor (dB/m)	Cable Loss (dB)	Preamp Factor (dB)	Antenna Height (cm)	Table Angle (Degree)	Remark
5454.16	39.92	38.93	54	-14.08	31.56	6.51	37.08	170	6	Average
5454.16	52.64	51.65	74	-21.36	31.56	6.51	37.08	170	6	Peak
*5470	51.19	50.18	68.2	-17.01	31.57	6.52	37.08	170	6	Peak
5580	105.28	104.08			31.71	6.65	37.16	170	6	Average
5580	113.48	112.28			31.71	6.65	37.16	170	6	Peak
*5725	50.61	49.32	68.2	-17.59	31.96	6.76	37.43	170	6	Peak
11160	42.46	44.16	54	-11.54	40.56	10.52	52.78	252	111	Average
11160	52.83	54.53	74	-21.17	40.56	10.52	52.78	252	111	Peak

Antenna Polarity & Test Distance: Vertical at 3 m										
Frequency (MHz)	Emission Level (dBuV/m)	Read Level (dBuV)	Limit (dBuV/m)	Margin (dB)	Antenna Factor (dB/m)	Cable Loss (dB)	Preamp Factor (dB)	Antenna Height (cm)	Table Angle (Degree)	Remark
5400.88	39.92	39.11	54	-14.08	31.52	6.47	37.18	165	354	Average
5400.88	52.35	51.54	74	-21.65	31.52	6.47	37.18	165	354	Peak
*5470	51.78	50.77	68.2	-16.42	31.57	6.52	37.08	165	354	Peak
5580	105.79	104.59			31.71	6.65	37.16	165	354	Average
5580	114.7	113.5			31.71	6.65	37.16	165	354	Peak
*5725	50.87	49.58	68.2	-17.33	31.96	6.76	37.43	165	354	Peak
11160	43	44.7	54	-11	40.56	10.52	52.78	152	123	Average
11160	53.01	54.71	74	-20.99	40.56	10.52	52.78	152	123	Peak

Remarks:

- Emission Level = Read Level + Antenna Factor + Cable Loss - Preamp Factor
Margin value = Emission level – Limit value
- 5580 MHz: Fundamental Frequency
- *: Out of Restricted Band

EUT Test Condition		Measurement Detail	
Channel	Channel 140	Frequency Range	1 GHz ~ 40 GHz
Input Power	120 Vac, 60 Hz	Detector Function	Peak (PK) Average (AV)
Environmental Conditions	25 deg. C, 65 % RH	Tested By	Getaz Yang

Antenna Polarity & Test Distance: Horizontal at 3 m										
Frequency (MHz)	Emission Level (dBuV/m)	Read Level (dBuV)	Limit (dBuV/m)	Margin (dB)	Antenna Factor (dB/m)	Cable Loss (dB)	Preamp Factor (dB)	Antenna Height (cm)	Table Angle (Degree)	Remark
5424.56	40.3	39.41	54	-13.7	31.53	6.49	37.13	168	22	Average
5424.56	52.5	51.61	74	-21.5	31.53	6.49	37.13	168	22	Peak
*5470	50.86	49.86	68.2	-17.34	31.57	6.51	37.08	168	22	Peak
5700	104.82	103.59			31.9	6.73	37.4	168	22	Average
5700	113.56	112.33			31.9	6.73	37.4	168	22	Peak
*5725	65.47	64.18	68.2	-2.73	31.96	6.76	37.43	168	22	Peak
11400	44.45	46.35	54	-9.55	40.33	10.47	52.7	152	123	Average
11400	54.95	56.85	74	-19.05	40.33	10.47	52.7	152	123	Peak

Antenna Polarity & Test Distance: Vertical at 3 m										
Frequency (MHz)	Emission Level (dBuV/m)	Read Level (dBuV)	Limit (dBuV/m)	Margin (dB)	Antenna Factor (dB/m)	Cable Loss (dB)	Preamp Factor (dB)	Antenna Height (cm)	Table Angle (Degree)	Remark
5411.12	39.89	39.07	54	-14.11	31.52	6.48	37.18	160	349	Average
5411.12	51.78	50.96	74	-22.22	31.52	6.48	37.18	160	349	Peak
*5470	51.66	50.67	68.2	-16.54	31.56	6.51	37.08	160	349	Peak
5700	105.1	103.87			31.9	6.73	37.4	160	349	Average
5700	113.74	112.51			31.9	6.73	37.4	160	349	Peak
*5725	68.04	66.75	68.2	-0.16	31.96	6.76	37.43	160	349	Peak
11400	44.61	46.51	54	-9.39	40.33	10.47	52.7	152	236	Average
11400	55.06	56.96	74	-18.94	40.33	10.47	52.7	152	236	Peak

Remarks:

- Emission Level = Read Level + Antenna Factor + Cable Loss - Preamp Factor
Margin value = Emission level – Limit value
- 5700 MHz: Fundamental Frequency
- *: Out of Restricted Band

EUT Test Condition		Measurement Detail	
Channel	Channel 149	Frequency Range	1 GHz ~ 40 GHz
Input Power	120 Vac, 60 Hz	Detector Function	Peak (PK) Average (AV)
Environmental Conditions	25 deg. C, 65 % RH	Tested By	Getaz Yang

<Spurious Emission>

Antenna Polarity & Test Distance: Horizontal at 3 m										
Frequency (MHz)	Emission Level (dBuV/m)	Read Level (dBuV)	Limit (dBuV/m)	Margin (dB)	Antenna Factor (dB/m)	Cable Loss (dB)	Preamp Factor (dB)	Antenna Height (cm)	Table Angle (Degree)	Remark
5745	105.43	104.13			31.99	6.78	37.47	167	18	Average
5745	113.76	112.46			31.99	6.78	37.47	167	18	Peak
11490	44.64	46.51	54	-9.36	40.25	10.66	52.78	125	123	Average
11490	54.36	56.23	74	-19.64	40.25	10.66	52.78	125	123	Peak
Antenna Polarity & Test Distance: Vertical at 3 m										
Frequency (MHz)	Emission Level (dBuV/m)	Read Level (dBuV)	Limit (dBuV/m)	Margin (dB)	Antenna Factor (dB/m)	Cable Loss (dB)	Preamp Factor (dB)	Antenna Height (cm)	Table Angle (Degree)	Remark
5745	106.21	104.91			31.99	6.78	37.47	185	343	Average
5745	114.89	113.59			31.99	6.78	37.47	185	343	Peak
11490	44.64	46.51	54	-9.36	40.25	10.66	52.78	203	256	Average
11490	54.61	56.48	74	-19.39	40.25	10.66	52.78	203	256	Peak

<Out of Band Emission (OOBE)>

Antenna Polarity & Test Distance: Horizontal at 3 m										
Frequency (MHz)	Emission Level (dBuV/m)	Read Level (dBuV)	Limit (dBuV/m)	Margin (dB)	Antenna Factor (dB/m)	Cable Loss (dB)	Preamp Factor (dB)	Antenna Height (cm)	Table Angle (Degree)	Remark
5645	53.04	51.8	68.2	-15.16	31.82	6.7	37.28	167	18	Peak
5650.7	53.74	52.46	68.72	-14.98	31.85	6.71	37.28	167	18	Peak
5920.025	51.58	49.96	71.87	-20.29	32.26	6.86	37.5	167	18	Peak
5933.325	51.25	49.6	68.2	-16.95	32.29	6.86	37.5	167	18	Peak
Antenna Polarity & Test Distance: Vertical at 3 m										
Frequency (MHz)	Emission Level (dBuV/m)	Read Level (dBuV)	Limit (dBuV/m)	Margin (dB)	Antenna Factor (dB/m)	Cable Loss (dB)	Preamp Factor (dB)	Antenna Height (cm)	Table Angle (Degree)	Remark
5644.525	52.2	50.96	68.2	-16	31.82	6.7	37.28	185	343	Peak
5651.65	50.57	49.29	69.43	-18.86	31.85	6.71	37.28	185	343	Peak
5922.875	49.84	48.19	69.77	-19.93	32.29	6.86	37.5	185	343	Peak
5935.7	52.42	50.77	68.2	-15.78	32.29	6.86	37.5	185	343	Peak

Remarks:

- Emission Level = Read Level + Antenna Factor + Cable Loss - Preamp Factor
Margin value = Emission level – Limit value
- 5745 MHz: Fundamental Frequency
- *: Out of Restricted Band

EUT Test Condition		Measurement Detail	
Channel	Channel 157	Frequency Range	1 GHz ~ 40 GHz
Input Power	120 Vac, 60 Hz	Detector Function	Peak (PK) Average (AV)
Environmental Conditions	25 deg. C, 65 % RH	Tested By	Getaz Yang

<Spurious Emission>

Antenna Polarity & Test Distance: Horizontal at 3 m										
Frequency (MHz)	Emission Level (dBuV/m)	Read Level (dBuV)	Limit (dBuV/m)	Margin (dB)	Antenna Factor (dB/m)	Cable Loss (dB)	Preamp Factor (dB)	Antenna Height (cm)	Table Angle (Degree)	Remark
5785	105.19	103.87			32.04	6.82	37.54	171	18	Average
5785	113.31	111.99			32.04	6.82	37.54	171	18	Peak
11570	45.14	47.26	54	-8.86	40.13	10.76	53.01	158	236	Average
11570	54.92	57.04	74	-19.08	40.13	10.76	53.01	158	236	Peak
Antenna Polarity & Test Distance: Vertical at 3 m										
Frequency (MHz)	Emission Level (dBuV/m)	Read Level (dBuV)	Limit (dBuV/m)	Margin (dB)	Antenna Factor (dB/m)	Cable Loss (dB)	Preamp Factor (dB)	Antenna Height (cm)	Table Angle (Degree)	Remark
5785	96.35	95.03			32.04	6.82	37.54	173	351	Average
5785	114.59	113.27			32.04	6.82	37.54	173	351	Peak
11570	44.09	46.21	54	-9.91	40.13	10.76	53.01	201	236	Average
11570	54.01	56.13	74	-19.99	40.13	10.76	53.01	201	236	Peak

<Out of Band Emission (OOBE)>

Antenna Polarity & Test Distance: Horizontal at 3 m										
Frequency (MHz)	Emission Level (dBuV/m)	Read Level (dBuV)	Limit (dBuV/m)	Margin (dB)	Antenna Factor (dB/m)	Cable Loss (dB)	Preamp Factor (dB)	Antenna Height (cm)	Table Angle (Degree)	Remark
5602.25	51.63	50.34	68.2	-16.57	31.77	6.68	37.16	171	18	Peak
5651.65	49.68	48.4	69.43	-19.75	31.85	6.71	37.28	171	18	Peak
5923.35	49.67	48.02	69.42	-19.75	32.29	6.86	37.5	171	18	Peak
6011.225	51.93	50.09	68.2	-16.27	32.45	6.89	37.5	171	18	Peak
Antenna Polarity & Test Distance: Vertical at 3 m										
Frequency (MHz)	Emission Level (dBuV/m)	Read Level (dBuV)	Limit (dBuV/m)	Margin (dB)	Antenna Factor (dB/m)	Cable Loss (dB)	Preamp Factor (dB)	Antenna Height (cm)	Table Angle (Degree)	Remark
5628.375	51.95	50.75	68.2	-16.25	31.79	6.69	37.28	173	351	Peak
5651.65	49.37	48.09	69.43	-20.06	31.85	6.71	37.28	173	351	Peak
5922.4	49.53	47.88	70.12	-20.59	32.29	6.86	37.5	173	351	Peak
5934.275	51.92	50.27	68.2	-16.28	32.29	6.86	37.5	173	351	Peak

Remarks:

- Emission Level = Read Level + Antenna Factor + Cable Loss - Preamp Factor
Margin value = Emission level – Limit value
- 5785 MHz: Fundamental Frequency
- *: Out of Restricted Band

EUT Test Condition		Measurement Detail	
Channel	Channel 165	Frequency Range	1 GHz ~ 40 GHz
Input Power	120 Vac, 60 Hz	Detector Function	Peak (PK) Average (AV)
Environmental Conditions	25 deg. C, 65 % RH	Tested By	Getaz Yang

<Spurious Emission>

Antenna Polarity & Test Distance: Horizontal at 3 m										
Frequency (MHz)	Emission Level (dBuV/m)	Read Level (dBuV)	Limit (dBuV/m)	Margin (dB)	Antenna Factor (dB/m)	Cable Loss (dB)	Preamp Factor (dB)	Antenna Height (cm)	Table Angle (Degree)	Remark
5825	105.13	103.7			32.12	6.84	37.53	158	17	Average
5825	113.51	112.08			32.12	6.84	37.53	158	17	Peak
11650	44.21	46.52	54	-9.79	40.03	10.8	53.14	203	256	Average
11650	54.47	56.78	74	-19.53	40.03	10.8	53.14	203	256	Peak
Antenna Polarity & Test Distance: Vertical at 3 m										
Frequency (MHz)	Emission Level (dBuV/m)	Read Level (dBuV)	Limit (dBuV/m)	Margin (dB)	Antenna Factor (dB/m)	Cable Loss (dB)	Preamp Factor (dB)	Antenna Height (cm)	Table Angle (Degree)	Remark
5825	106.7	105.27			32.12	6.84	37.53	176	349	Average
5825	114.14	112.71			32.12	6.84	37.53	176	349	Peak
11650	44.92	47.23	54	-9.08	40.03	10.8	53.14	203	256	Average
11650	55.51	57.82	74	-18.49	40.03	10.8	53.14	203	256	Peak

<Out of Band Emission (OOBE)>

Antenna Polarity & Test Distance: Horizontal at 3 m										
Frequency (MHz)	Emission Level (dBuV/m)	Read Level (dBuV)	Limit (dBuV/m)	Margin (dB)	Antenna Factor (dB/m)	Cable Loss (dB)	Preamp Factor (dB)	Antenna Height (cm)	Table Angle (Degree)	Remark
5636.45	52.5	51.26	68.2	-15.7	31.82	6.7	37.28	158	17	Peak
5650.7	48.95	47.67	68.72	-19.77	31.85	6.71	37.28	158	17	Peak
5922.875	51.06	49.41	69.77	-18.71	32.29	6.86	37.5	158	17	Peak
5988.425	52.08	50.33	68.2	-16.12	32.37	6.89	37.51	158	17	Peak
Antenna Polarity & Test Distance: Vertical at 3 m										
Frequency (MHz)	Emission Level (dBuV/m)	Read Level (dBuV)	Limit (dBuV/m)	Margin (dB)	Antenna Factor (dB/m)	Cable Loss (dB)	Preamp Factor (dB)	Antenna Height (cm)	Table Angle (Degree)	Remark
5565.675	51.4	50.18	68.2	-16.8	31.71	6.63	37.12	176	349	Peak
5651.175	51.15	49.87	69.07	-17.92	31.85	6.71	37.28	176	349	Peak
5923.825	53.01	51.36	69.07	-16.06	32.29	6.86	37.5	176	349	Peak
5927.625	52.99	51.34	68.2	-15.21	32.29	6.86	37.5	176	349	Peak

Remarks:

- Emission Level = Read Level + Antenna Factor + Cable Loss - Preamp Factor
Margin value = Emission level – Limit value
- 5825 MHz: Fundamental Frequency
- *: Out of Restricted Band

802.11n (HT20)

EUT Test Condition		Measurement Detail	
Channel	Channel 36	Frequency Range	1 GHz ~ 40 GHz
Input Power	120 Vac, 60 Hz	Detector Function	Peak (PK) Average (AV)
Environmental Conditions	25 deg. C, 65 % RH	Tested By	Getaz Yang

Antenna Polarity & Test Distance: Horizontal at 3 m

Frequency (MHz)	Emission Level (dBuV/m)	Read Level (dBuV)	Limit (dBuV/m)	Margin (dB)	Antenna Factor (dB/m)	Cable Loss (dB)	Preamp Factor (dB)	Antenna Height (cm)	Table Angle (Degree)	Remark
5147.24	50.38	49.8	54	-3.62	31.56	6.34	37.32	202	2	Average
5147.24	64.35	63.77	74	-9.65	31.56	6.34	37.32	202	2	Peak
5180	102.17	101.55			31.59	6.37	37.34	202	2	Average
5180	111.11	110.49			31.59	6.37	37.34	202	2	Peak
*10360	51.34	54.1	68.2	-16.86	39.48	10.21	52.45	201	256	Peak

Antenna Polarity & Test Distance: Vertical at 3 m

Frequency (MHz)	Emission Level (dBuV/m)	Read Level (dBuV)	Limit (dBuV/m)	Margin (dB)	Antenna Factor (dB/m)	Cable Loss (dB)	Preamp Factor (dB)	Antenna Height (cm)	Table Angle (Degree)	Remark
5149.58	53.28	52.7	54	-0.72	31.56	6.34	37.32	204	267	Average
5149.58	67.01	66.43	74	-6.99	31.56	6.34	37.32	204	267	Peak
5180	104.46	103.84			31.59	6.37	37.34	204	267	Average
5180	114	113.38			31.59	6.37	37.34	204	267	Peak
*10360	51.72	54.48	68.2	-16.48	39.48	10.21	52.45	201	236	Peak

Remarks:

- Emission Level = Read Level + Antenna Factor + Cable Loss - Preamp Factor
Margin value = Emission level – Limit value
- 5180 MHz: Fundamental Frequency
- *: Out of Restricted Band

EUT Test Condition		Measurement Detail	
Channel	Channel 44	Frequency Range	1 GHz ~ 40 GHz
Input Power	120 Vac, 60 Hz	Detector Function	Peak (PK) Average (AV)
Environmental Conditions	25 deg. C, 65 % RH	Tested By	Getaz Yang

Antenna Polarity & Test Distance: Horizontal at 3 m										
Frequency (MHz)	Emission Level (dBuV/m)	Read Level (dBuV)	Limit (dBuV/m)	Margin (dB)	Antenna Factor (dB/m)	Cable Loss (dB)	Preamp Factor (dB)	Antenna Height (cm)	Table Angle (Degree)	Remark
5126	41.61	41.04	54	-12.39	31.55	6.32	37.3	162	0	Average
5126	52.18	51.61	74	-21.82	31.55	6.32	37.3	162	0	Peak
5220	103.3	102.65			31.61	6.4	37.36	162	0	Average
5220	111.71	111.06			31.61	6.4	37.36	162	0	Peak
5387.73	39.56	38.54	54	-14.44	31.73	6.47	37.18	162	0	Average
5387.73	52.01	50.99	74	-21.99	31.73	6.47	37.18	162	0	Peak
*10440	53.93	56.69	68.2	-14.27	39.55	10.21	52.52	102	256	Peak
Antenna Polarity & Test Distance: Vertical at 3 m										
Frequency (MHz)	Emission Level (dBuV/m)	Read Level (dBuV)	Limit (dBuV/m)	Margin (dB)	Antenna Factor (dB/m)	Cable Loss (dB)	Preamp Factor (dB)	Antenna Height (cm)	Table Angle (Degree)	Remark
5145.26	41.21	40.63	54	-12.79	31.56	6.34	37.32	204	267	Average
5145.26	52.52	51.94	74	-21.48	31.56	6.34	37.32	204	267	Peak
5220	104.42	103.77			31.61	6.4	37.36	204	267	Average
5220	113.28	112.63			31.61	6.4	37.36	204	267	Peak
5432.61	39.16	38.04	54	-14.84	31.76	6.49	37.13	204	267	Average
5432.61	51.37	50.25	74	-22.63	31.76	6.49	37.13	204	267	Peak
*10440	53.49	56.25	68.2	-14.71	39.55	10.21	52.52	152	236	Peak

Remarks:

- Emission Level = Read Level + Antenna Factor + Cable Loss - Preamp Factor
Margin value = Emission level – Limit value
- 5220 MHz: Fundamental Frequency
- *: Out of Restricted Band

EUT Test Condition		Measurement Detail	
Channel	Channel 48	Frequency Range	1 GHz ~ 40 GHz
Input Power	120 Vac, 60 Hz	Detector Function	Peak (PK) Average (AV)
Environmental Conditions	25 deg. C, 65 % RH	Tested By	Getaz Yang

Antenna Polarity & Test Distance: Horizontal at 3 m										
Frequency (MHz)	Emission Level (dBuV/m)	Read Level (dBuV)	Limit (dBuV/m)	Margin (dB)	Antenna Factor (dB/m)	Cable Loss (dB)	Preamp Factor (dB)	Antenna Height (cm)	Table Angle (Degree)	Remark
5140.04	41.82	41.23	54	-12.18	31.56	6.33	37.3	169	0	Average
5140.04	52.59	52	74	-21.41	31.56	6.33	37.3	169	0	Peak
5240	103.45	102.73			31.62	6.42	37.32	169	0	Average
5240	112.73	112.01			31.62	6.42	37.32	169	0	Peak
5386.63	39.39	38.37	54	-14.61	31.73	6.47	37.18	169	0	Average
5386.63	51.71	50.69	74	-22.29	31.73	6.47	37.18	169	0	Peak
*10480	53.86	56.7	68.2	-14.34	39.6	10.22	52.66	201	256	Peak
Antenna Polarity & Test Distance: Vertical at 3 m										
Frequency (MHz)	Emission Level (dBuV/m)	Read Level (dBuV)	Limit (dBuV/m)	Margin (dB)	Antenna Factor (dB/m)	Cable Loss (dB)	Preamp Factor (dB)	Antenna Height (cm)	Table Angle (Degree)	Remark
5073.44	41.2	40.68	54	-12.8	31.52	6.27	37.27	204	269	Average
5073.44	52.82	52.3	74	-21.18	31.52	6.27	37.27	204	269	Peak
5240	104.61	103.89			31.62	6.42	37.32	204	269	Average
5240	113.13	112.41			31.62	6.42	37.32	204	269	Peak
5391.91	39.14	38.12	54	-14.86	31.73	6.47	37.18	204	269	Average
5391.91	51.48	50.46	74	-22.52	31.73	6.47	37.18	204	269	Peak
*10480	53.46	56.3	68.2	-14.74	39.6	10.22	52.66	205	145	Peak

Remarks:

- Emission Level = Read Level + Antenna Factor + Cable Loss - Preamp Factor
Margin value = Emission level – Limit value
- 5240 MHz: Fundamental Frequency
- *: Out of Restricted Band

EUT Test Condition		Measurement Detail	
Channel	Channel 52	Frequency Range	1 GHz ~ 40 GHz
Input Power	120 Vac, 60 Hz	Detector Function	Peak (PK) Average (AV)
Environmental Conditions	25 deg. C, 65 % RH	Tested By	Getaz Yang

Antenna Polarity & Test Distance: Horizontal at 3 m										
Frequency (MHz)	Emission Level (dBuV/m)	Read Level (dBuV)	Limit (dBuV/m)	Margin (dB)	Antenna Factor (dB/m)	Cable Loss (dB)	Preamp Factor (dB)	Antenna Height (cm)	Table Angle (Degree)	Remark
5147.96	39.64	39.06	54	-14.36	31.56	6.34	37.32	216	353	Average
5147.96	51.31	50.73	74	-22.69	31.56	6.34	37.32	216	353	Peak
5260	102.5	101.69			31.65	6.43	37.27	216	353	Average
5260	112.06	111.25			31.65	6.43	37.27	216	353	Peak
5356.93	43.55	42.56	54	-10.45	31.7	6.47	37.18	216	353	Average
5356.93	52.69	51.7	74	-21.31	31.7	6.47	37.18	216	353	Peak
10520	53.78	56.58	68.2	-14.42	39.66	10.27	52.73	256	123	Peak
Antenna Polarity & Test Distance: Vertical at 3 m										
Frequency (MHz)	Emission Level (dBuV/m)	Read Level (dBuV)	Limit (dBuV/m)	Margin (dB)	Antenna Factor (dB/m)	Cable Loss (dB)	Preamp Factor (dB)	Antenna Height (cm)	Table Angle (Degree)	Remark
5072.18	40	39.48	54	-14	31.52	6.27	37.27	197	338	Average
5072.18	51.79	51.27	74	-22.21	31.52	6.27	37.27	197	338	Peak
5260	104.97	104.16			31.65	6.43	37.27	197	338	Average
5260	113.21	112.4			31.65	6.43	37.27	197	338	Peak
5427	40.86	39.75	54	-13.14	31.75	6.49	37.13	197	338	Average
5427	51.71	50.6	74	-22.29	31.75	6.49	37.13	197	338	Peak
10520	53.88	56.68	68.2	-14.32	39.66	10.27	52.73	285	124	Peak

Remarks:

- Emission Level = Read Level + Antenna Factor + Cable Loss - Preamp Factor
Margin value = Emission level – Limit value
- 5260 MHz: Fundamental Frequency
- *: Out of Restricted Band

EUT Test Condition		Measurement Detail	
Channel	Channel 60	Frequency Range	1 GHz ~ 40 GHz
Input Power	120 Vac, 60 Hz	Detector Function	Peak (PK) Average (AV)
Environmental Conditions	25 deg. C, 65 % RH	Tested By	Getaz Yang

Antenna Polarity & Test Distance: Horizontal at 3 m										
Frequency (MHz)	Emission Level (dBuV/m)	Read Level (dBuV)	Limit (dBuV/m)	Margin (dB)	Antenna Factor (dB/m)	Cable Loss (dB)	Preamp Factor (dB)	Antenna Height (cm)	Table Angle (Degree)	Remark
5107.82	39.26	38.7	54	-14.74	31.54	6.3	37.28	198	344	Average
5107.82	51.33	50.81	74	-22.67	31.52	6.27	37.27	198	344	Peak
5300	104.03	103.09			31.67	6.46	37.19	198	344	Average
5300	112.99	112.05			31.67	6.46	37.19	198	344	Peak
5350.22	45.39	44.4	54	-8.61	31.7	6.47	37.18	198	344	Average
5350.22	55.69	54.7	74	-18.31	31.7	6.47	37.18	198	344	Peak
10600	42.46	45.29	54	-11.54	39.85	10.43	53.11	125	236	Average
10600	52.65	55.48	74	-21.35	39.85	10.43	53.11	125	236	Peak

Antenna Polarity & Test Distance: Vertical at 3 m										
Frequency (MHz)	Emission Level (dBuV/m)	Read Level (dBuV)	Limit (dBuV/m)	Margin (dB)	Antenna Factor (dB/m)	Cable Loss (dB)	Preamp Factor (dB)	Antenna Height (cm)	Table Angle (Degree)	Remark
5131.76	39.84	39.27	54	-14.16	31.55	6.32	37.3	201	331	Average
5131.76	52.01	51.54	74	-21.99	31.48	6.23	37.24	201	331	Peak
5300	105.93	104.99			31.67	6.46	37.19	201	331	Average
5300	113.56	112.62			31.67	6.46	37.19	201	331	Peak
5351.65	43.67	42.68	54	-10.33	31.7	6.47	37.18	201	331	Average
5351.65	54.53	53.54	74	-19.47	31.7	6.47	37.18	201	331	Peak
10600	44.02	46.85	54	-9.98	39.85	10.43	53.11	285	156	Average
10600	54.13	56.96	74	-19.87	39.85	10.43	53.11	285	156	Peak

Remarks:

- Emission Level = Read Level + Antenna Factor + Cable Loss - Preamp Factor
Margin value = Emission level – Limit value
- 5300 MHz: Fundamental Frequency
- *: Out of Restricted Band

EUT Test Condition		Measurement Detail	
Channel	Channel 64	Frequency Range	1 GHz ~ 40 GHz
Input Power	120 Vac, 60 Hz	Detector Function	Peak (PK) Average (AV)
Environmental Conditions	25 deg. C, 65 % RH	Tested By	Getaz Yang

Antenna Polarity & Test Distance: Horizontal at 3 m										
Frequency (MHz)	Emission Level (dBuV/m)	Read Level (dBuV)	Limit (dBuV/m)	Margin (dB)	Antenna Factor (dB/m)	Cable Loss (dB)	Preamp Factor (dB)	Antenna Height (cm)	Table Angle (Degree)	Remark
5320	103.24	102.29			31.68	6.46	37.19	196	345	Average
5320	111.93	110.98			31.68	6.46	37.19	196	345	Peak
5354.73	53.31	52.32	54	-0.69	31.7	6.47	37.18	196	345	Average
5354.73	67.37	66.38	74	-6.63	31.7	6.47	37.18	196	345	Peak
10640	44.07	46.85	54	-9.93	39.93	10.36	53.07	333	256	Average
10640	54.18	56.96	74	-19.82	39.93	10.36	53.07	333	256	Peak

Antenna Polarity & Test Distance: Vertical at 3 m										
Frequency (MHz)	Emission Level (dBuV/m)	Read Level (dBuV)	Limit (dBuV/m)	Margin (dB)	Antenna Factor (dB/m)	Cable Loss (dB)	Preamp Factor (dB)	Antenna Height (cm)	Table Angle (Degree)	Remark
5320	105.21	104.26			31.68	6.46	37.19	174	329	Average
5320	113.26	112.31			31.68	6.46	37.19	174	329	Peak
5352.64	53.71	52.72	54	-0.29	31.7	6.47	37.18	174	329	Average
5352.64	66.35	65.36	74	-7.65	31.7	6.47	37.18	174	329	Peak
10640	43.47	46.25	54	-10.53	39.93	10.36	53.07	111	165	Average
10640	53.8	56.58	74	-20.2	39.93	10.36	53.07	111	165	Peak

Remarks:

- Emission Level = Read Level + Antenna Factor + Cable Loss - Preamp Factor
Margin value = Emission level – Limit value
- 5320 MHz: Fundamental Frequency
- *: Out of Restricted Band

EUT Test Condition		Measurement Detail	
Channel	Channel 100	Frequency Range	1 GHz ~ 40 GHz
Input Power	120 Vac, 60 Hz	Detector Function	Peak (PK) Average (AV)
Environmental Conditions	25 deg. C, 65 % RH	Tested By	Getaz Yang

Antenna Polarity & Test Distance: Horizontal at 3 m										
Frequency (MHz)	Emission Level (dBuV/m)	Read Level (dBuV)	Limit (dBuV/m)	Margin (dB)	Antenna Factor (dB/m)	Cable Loss (dB)	Preamp Factor (dB)	Antenna Height (cm)	Table Angle (Degree)	Remark
5459.76	49.54	48.55	54	-4.46	31.56	6.51	37.08	179	9	Average
5459.76	63.17	62.18	74	-10.83	31.56	6.51	37.08	179	9	Peak
*5470	67.24	66.23	68.2	-0.96	31.57	6.52	37.08	179	9	Peak
5500	104.29	103.18			31.6	6.54	37.03	179	9	Average
5500	113.13	112.02			31.6	6.54	37.03	179	9	Peak
*5725	51.41	50.12	68.2	-16.79	31.96	6.76	37.43	179	9	Peak
11000	43.35	45.25	54	-10.65	40.73	10.4	53.03	111	165	Average
11000	54.06	55.96	74	-19.94	40.73	10.4	53.03	111	165	Peak

Antenna Polarity & Test Distance: Vertical at 3 m										
Frequency (MHz)	Emission Level (dBuV/m)	Read Level (dBuV)	Limit (dBuV/m)	Margin (dB)	Antenna Factor (dB/m)	Cable Loss (dB)	Preamp Factor (dB)	Antenna Height (cm)	Table Angle (Degree)	Remark
5459.12	47.27	46.28	54	-6.73	31.56	6.51	37.08	170	356	Average
5459.12	59.57	58.58	74	-14.43	31.56	6.51	37.08	170	356	Peak
*5470	67.44	66.43	68.2	-0.76	31.57	6.52	37.08	170	356	Peak
5500	105.11	104			31.6	6.54	37.03	170	356	Average
5500	114.34	113.23			31.6	6.54	37.03	170	356	Peak
*5725	51.73	50.44	68.2	-16.47	31.96	6.76	37.43	170	356	Peak
11000	44.06	45.96	54	-9.94	40.73	10.4	53.03	174	156	Average
11000	53.18	55.08	74	-20.82	40.73	10.4	53.03	174	156	Peak

Remarks:

- Emission Level = Read Level + Antenna Factor + Cable Loss - Preamp Factor
Margin value = Emission level – Limit value
- 5500 MHz: Fundamental Frequency
- *: Out of Restricted Band

EUT Test Condition		Measurement Detail	
Channel	Channel 116	Frequency Range	1 GHz ~ 40 GHz
Input Power	120 Vac, 60 Hz	Detector Function	Peak (PK) Average (AV)
Environmental Conditions	25 deg. C, 65 % RH	Tested By	Getaz Yang

Antenna Polarity & Test Distance: Horizontal at 3 m										
Frequency (MHz)	Emission Level (dBuV/m)	Read Level (dBuV)	Limit (dBuV/m)	Margin (dB)	Antenna Factor (dB/m)	Cable Loss (dB)	Preamp Factor (dB)	Antenna Height (cm)	Table Angle (Degree)	Remark
5447.28	40.38	39.45	54	-13.62	31.56	6.5	37.13	160	14	Average
5447.28	51.49	50.56	74	-22.51	31.56	6.5	37.13	160	14	Peak
*5470	50.41	49.4	68.2	-17.79	31.57	6.52	37.08	160	14	Peak
5580	103.91	102.71			31.71	6.65	37.16	160	14	Average
5580	113.29	112.09			31.71	6.65	37.16	160	14	Peak
*5725	50.44	49.15	68.2	-17.76	31.96	6.76	37.43	160	14	Peak
11160	40.89	42.59	54	-13.11	40.56	10.52	52.78	152	236	Average
11160	51.2	52.9	74	-22.8	40.56	10.52	52.78	152	236	Peak

Antenna Polarity & Test Distance: Vertical at 3 m										
Frequency (MHz)	Emission Level (dBuV/m)	Read Level (dBuV)	Limit (dBuV/m)	Margin (dB)	Antenna Factor (dB/m)	Cable Loss (dB)	Preamp Factor (dB)	Antenna Height (cm)	Table Angle (Degree)	Remark
5379.6	39.88	39.08	54	-14.12	31.51	6.47	37.18	166	354	Average
5379.6	52.02	51.22	74	-21.98	31.51	6.47	37.18	166	354	Peak
*5470	50.98	49.97	68.2	-17.22	31.57	6.52	37.08	166	354	Peak
5580	105.67	104.47			31.71	6.65	37.16	166	354	Average
5580	114.15	112.95			31.71	6.65	37.16	166	354	Peak
*5725	51.1	49.81	68.2	-17.1	31.96	6.76	37.43	166	354	Peak
11160	42.83	44.53	54	-11.17	40.56	10.52	52.78	125	111	Average
11160	53.27	54.97	74	-20.73	40.56	10.52	52.78	125	111	Peak

Remarks:

- Emission Level = Read Level + Antenna Factor + Cable Loss - Preamp Factor
Margin value = Emission level – Limit value
- 5580 MHz: Fundamental Frequency
- *: Out of Restricted Band

EUT Test Condition		Measurement Detail	
Channel	Channel 140	Frequency Range	1 GHz ~ 40 GHz
Input Power	120 Vac, 60 Hz	Detector Function	Peak (PK) Average (AV)
Environmental Conditions	25 deg. C, 65 % RH	Tested By	Getaz Yang

Antenna Polarity & Test Distance: Horizontal at 3 m										
Frequency (MHz)	Emission Level (dBuV/m)	Read Level (dBuV)	Limit (dBuV/m)	Margin (dB)	Antenna Factor (dB/m)	Cable Loss (dB)	Preamp Factor (dB)	Antenna Height (cm)	Table Angle (Degree)	Remark
5371.28	40.24	39.46	54	-13.76	31.49	6.47	37.18	169	19	Average
5371.28	51.44	50.66	74	-22.56	31.49	6.47	37.18	169	19	Peak
*5461.36	50.38	49.39	68.2	-17.82	31.56	6.51	37.08	169	19	Peak
5700	103.37	102.14			31.9	6.73	37.4	169	19	Average
5700	110.71	109.48			31.9	6.73	37.4	169	19	Peak
*5725	65.5	64.21	68.2	-2.7	31.96	6.76	37.43	169	19	Peak
11400	41.35	43.25	54	-12.65	40.33	10.47	52.7	251	236	Average
11400	52.06	53.96	74	-21.94	40.33	10.47	52.7	251	236	Peak

Antenna Polarity & Test Distance: Vertical at 3 m										
Frequency (MHz)	Emission Level (dBuV/m)	Read Level (dBuV)	Limit (dBuV/m)	Margin (dB)	Antenna Factor (dB/m)	Cable Loss (dB)	Preamp Factor (dB)	Antenna Height (cm)	Table Angle (Degree)	Remark
5398.8	39.66	38.85	54	-14.34	31.52	6.47	37.18	151	343	Average
5398.8	51.39	50.58	74	-22.61	31.52	6.47	37.18	151	343	Peak
*5466.48	51.27	50.26	68.2	-16.93	31.57	6.52	37.08	151	343	Peak
5700	104.52	103.29			31.9	6.73	37.4	151	343	Average
5700	113.66	112.43			31.9	6.73	37.4	151	343	Peak
*5725.1	67.78	66.49	68.2	-0.42	31.96	6.76	37.43	151	343	Peak
11400	43.7	45.6	54	-10.3	40.33	10.47	52.7	111	165	Average
11400	53.7	55.6	74	-20.3	40.33	10.47	52.7	111	165	Peak

Remarks:

- Emission Level = Read Level + Antenna Factor + Cable Loss - Preamp Factor
Margin value = Emission level – Limit value
- 5700 MHz: Fundamental Frequency
- *: Out of Restricted Band

EUT Test Condition		Measurement Detail	
Channel	Channel 149	Frequency Range	1 GHz ~ 40 GHz
Input Power	120 Vac, 60 Hz	Detector Function	Peak (PK) Average (AV)
Environmental Conditions	25 deg. C, 65 % RH	Tested By	Getaz Yang

<Spurious Emission>

Antenna Polarity & Test Distance: Horizontal at 3 m										
Frequency (MHz)	Emission Level (dBuV/m)	Read Level (dBuV)	Limit (dBuV/m)	Margin (dB)	Antenna Factor (dB/m)	Cable Loss (dB)	Preamp Factor (dB)	Antenna Height (cm)	Table Angle (Degree)	Remark
5745	102.24	100.94			31.99	6.78	37.47	170	18	Average
5745	113.33	112.03			31.99	6.78	37.47	170	18	Peak
11490	42.75	44.62	54	-11.25	40.25	10.66	52.78	201	236	Average
11490	52.19	54.06	74	-21.81	40.25	10.66	52.78	201	236	Peak

Antenna Polarity & Test Distance: Vertical at 3 m										
Frequency (MHz)	Emission Level (dBuV/m)	Read Level (dBuV)	Limit (dBuV/m)	Margin (dB)	Antenna Factor (dB/m)	Cable Loss (dB)	Preamp Factor (dB)	Antenna Height (cm)	Table Angle (Degree)	Remark
5745	105.84	104.54			31.99	6.78	37.47	170	342	Average
5745	114.34	113.04			31.99	6.78	37.47	170	342	Peak
11490	43.24	45.11	54	-10.76	40.25	10.66	52.78	203	256	Average
11490	53.51	55.38	74	-20.49	40.25	10.66	52.78	203	256	Peak

<Out of Band Emission (OOBE)>

Antenna Polarity & Test Distance: Horizontal at 3 m										
Frequency (MHz)	Emission Level (dBuV/m)	Read Level (dBuV)	Limit (dBuV/m)	Margin (dB)	Antenna Factor (dB/m)	Cable Loss (dB)	Preamp Factor (dB)	Antenna Height (cm)	Table Angle (Degree)	Remark
5645.475	53.88	52.64	68.2	-14.32	31.82	6.7	37.28	170	18	Peak
5651.175	51.63	50.35	69.07	-17.44	31.85	6.71	37.28	170	18	Peak
5923.35	51.05	49.4	69.42	-18.37	32.29	6.86	37.5	170	18	Peak
5972.275	52.16	50.45	68.2	-16.04	32.34	6.88	37.51	170	18	Peak

Antenna Polarity & Test Distance: Vertical at 3 m										
Frequency (MHz)	Emission Level (dBuV/m)	Read Level (dBuV)	Limit (dBuV/m)	Margin (dB)	Antenna Factor (dB/m)	Cable Loss (dB)	Preamp Factor (dB)	Antenna Height (cm)	Table Angle (Degree)	Remark
5643.575	52.49	51.25	68.2	-15.71	31.82	6.7	37.28	170	342	Peak
5652.125	52.05	50.77	69.78	-17.73	31.85	6.71	37.28	170	342	Peak
5923.35	50.79	49.14	69.42	-18.63	32.29	6.86	37.5	170	342	Peak
5947.575	51.61	49.92	68.2	-16.59	32.32	6.87	37.5	170	342	Peak

Remarks:

- Emission Level = Read Level + Antenna Factor + Cable Loss - Preamp Factor
Margin value = Emission level – Limit value
- 5745 MHz: Fundamental Frequency
- *: Out of Restricted Band

EUT Test Condition		Measurement Detail	
Channel	Channel 157	Frequency Range	1 GHz ~ 40 GHz
Input Power	120 Vac, 60 Hz	Detector Function	Peak (PK) Average (AV)
Environmental Conditions	25 deg. C, 65 % RH	Tested By	Getaz Yang

<Spurious Emission>

Antenna Polarity & Test Distance: Horizontal at 3 m										
Frequency (MHz)	Emission Level (dBuV/m)	Read Level (dBuV)	Limit (dBuV/m)	Margin (dB)	Antenna Factor (dB/m)	Cable Loss (dB)	Preamp Factor (dB)	Antenna Height (cm)	Table Angle (Degree)	Remark
5785	105.09	103.77			32.04	6.82	37.54	168	15	Average
5785	113.39	112.07			32.04	6.82	37.54	168	15	Peak
11570	43.13	45.25	54	-10.87	40.13	10.76	53.01	201	123	Average
11570	53.79	55.91	74	-20.21	40.13	10.76	53.01	201	123	Peak
Antenna Polarity & Test Distance: Vertical at 3 m										
Frequency (MHz)	Emission Level (dBuV/m)	Read Level (dBuV)	Limit (dBuV/m)	Margin (dB)	Antenna Factor (dB/m)	Cable Loss (dB)	Preamp Factor (dB)	Antenna Height (cm)	Table Angle (Degree)	Remark
5785	105.73	104.41			32.04	6.82	37.54	168	342	Average
5785	114.15	112.83			32.04	6.82	37.54	168	342	Peak
11570	44.13	46.25	54	-9.87	40.13	10.76	53.01	205	256	Average
11570	54.09	56.21	74	-19.91	40.13	10.76	53.01	205	256	Peak

<Out of Band Emission (OOBE)>

Antenna Polarity & Test Distance: Horizontal at 3 m										
Frequency (MHz)	Emission Level (dBuV/m)	Read Level (dBuV)	Limit (dBuV/m)	Margin (dB)	Antenna Factor (dB/m)	Cable Loss (dB)	Preamp Factor (dB)	Antenna Height (cm)	Table Angle (Degree)	Remark
5603.675	51.46	50.23	68.2	-16.74	31.77	6.68	37.22	168	15	Peak
5650.7	49.45	48.17	68.72	-19.27	31.85	6.71	37.28	168	15	Peak
5922.875	51.02	49.37	69.77	-18.75	32.29	6.86	37.5	168	15	Peak
5961.825	51.41	49.71	68.2	-16.79	32.34	6.87	37.51	168	15	Peak
Antenna Polarity & Test Distance: Vertical at 3 m										
Frequency (MHz)	Emission Level (dBuV/m)	Read Level (dBuV)	Limit (dBuV/m)	Margin (dB)	Antenna Factor (dB/m)	Cable Loss (dB)	Preamp Factor (dB)	Antenna Height (cm)	Table Angle (Degree)	Remark
5633.6	52.33	51.09	68.2	-15.87	31.82	6.7	37.28	168	342	Peak
5652.6	50.03	48.75	70.13	-20.1	31.85	6.71	37.28	168	342	Peak
5923.825	49.6	47.95	69.07	-19.47	32.29	6.86	37.5	168	342	Peak
5975.6	52.08	50.34	68.2	-16.12	32.37	6.88	37.51	168	342	Peak

Remarks:

- Emission Level = Read Level + Antenna Factor + Cable Loss - Preamp Factor
Margin value = Emission level – Limit value
- 5785 MHz: Fundamental Frequency
- *: Out of Restricted Band

EUT Test Condition		Measurement Detail	
Channel	Channel 165	Frequency Range	1 GHz ~ 40 GHz
Input Power	120 Vac, 60 Hz	Detector Function	Peak (PK) Average (AV)
Environmental Conditions	25 deg. C, 65 % RH	Tested By	Getaz Yang

<Spurious Emission>

Antenna Polarity & Test Distance: Horizontal at 3 m										
Frequency (MHz)	Emission Level (dBuV/m)	Read Level (dBuV)	Limit (dBuV/m)	Margin (dB)	Antenna Factor (dB/m)	Cable Loss (dB)	Preamp Factor (dB)	Antenna Height (cm)	Table Angle (Degree)	Remark
5825	105.06	103.63			32.12	6.84	37.53	170	19	Average
5825	112.93	111.5			32.12	6.84	37.53	170	19	Peak
11650	45.21	47.52	54	-8.79	40.03	10.8	53.14	203	251	Average
11650	55.18	57.49	74	-18.82	40.03	10.8	53.14	203	251	Peak
Antenna Polarity & Test Distance: Vertical at 3 m										
Frequency (MHz)	Emission Level (dBuV/m)	Read Level (dBuV)	Limit (dBuV/m)	Margin (dB)	Antenna Factor (dB/m)	Cable Loss (dB)	Preamp Factor (dB)	Antenna Height (cm)	Table Angle (Degree)	Remark
5825	105.17	103.74			32.12	6.84	37.53	169	347	Average
5825	114.23	112.8			32.12	6.84	37.53	169	347	Peak
11650	43.7	46.01	54	-10.3	40.03	10.8	53.14	222	236	Average
11650	53.81	56.12	74	-20.19	40.03	10.8	53.14	222	236	Peak

<Out of Band Emission (OOBE)>

Antenna Polarity & Test Distance: Horizontal at 3 m										
Frequency (MHz)	Emission Level (dBuV/m)	Read Level (dBuV)	Limit (dBuV/m)	Margin (dB)	Antenna Factor (dB/m)	Cable Loss (dB)	Preamp Factor (dB)	Antenna Height (cm)	Table Angle (Degree)	Remark
5624.575	51.06	49.8	68.2	-17.14	31.79	6.69	37.22	170	19	Peak
5653.075	51.05	49.77	70.49	-19.44	31.85	6.71	37.28	170	19	Peak
5924.775	52.83	51.18	68.37	-15.54	32.29	6.86	37.5	170	19	Peak
5957.075	52.04	50.33	68.2	-16.16	32.34	6.87	37.5	170	19	Peak
Antenna Polarity & Test Distance: Vertical at 3 m										
Frequency (MHz)	Emission Level (dBuV/m)	Read Level (dBuV)	Limit (dBuV/m)	Margin (dB)	Antenna Factor (dB/m)	Cable Loss (dB)	Preamp Factor (dB)	Antenna Height (cm)	Table Angle (Degree)	Remark
5649.275	52.09	50.85	68.2	-16.11	31.82	6.7	37.28	169	347	Peak
5651.175	49.98	48.7	69.07	-19.09	31.85	6.71	37.28	169	347	Peak
5922.875	51.2	49.55	69.77	-18.57	32.29	6.86	37.5	169	347	Peak
5939.975	52.11	50.42	68.2	-16.09	32.32	6.87	37.5	169	347	Peak

Remarks:

- Emission Level = Read Level + Antenna Factor + Cable Loss - Preamp Factor
Margin value = Emission level – Limit value
- 5825 MHz: Fundamental Frequency
- *: Out of Restricted Band

802.11n (HT40)

EUT Test Condition		Measurement Detail	
Channel	Channel 38	Frequency Range	1 GHz ~ 40 GHz
Input Power	120 Vac, 60 Hz	Detector Function	Peak (PK) Average (AV)
Environmental Conditions	25 deg. C, 65 % RH	Tested By	Getaz Yang

Antenna Polarity & Test Distance: Horizontal at 3 m

Frequency (MHz)	Emission Level (dBuV/m)	Read Level (dBuV)	Limit (dBuV/m)	Margin (dB)	Antenna Factor (dB/m)	Cable Loss (dB)	Preamp Factor (dB)	Antenna Height (cm)	Table Angle (Degree)	Remark
5150	50.81	50.23	54	-3.19	31.56	6.34	37.32	208	15	Average
5150	63.03	62.45	74	-10.97	31.56	6.34	37.32	208	15	Peak
5190	96.33	95.7			31.59	6.38	37.34	208	15	Average
5190	104.82	104.19			31.59	6.38	37.34	208	15	Peak
5368.15	39.43	38.42	54	-14.57	31.72	6.47	37.18	208	15	Average
5368.15	56.09	55.08	74	-17.91	31.72	6.47	37.18	208	15	Peak
*10380	53.57	56.31	68.2	-14.63	39.5	10.21	52.45	256	125	Peak

Antenna Polarity & Test Distance: Vertical at 3 m

Frequency (MHz)	Emission Level (dBuV/m)	Read Level (dBuV)	Limit (dBuV/m)	Margin (dB)	Antenna Factor (dB/m)	Cable Loss (dB)	Preamp Factor (dB)	Antenna Height (cm)	Table Angle (Degree)	Remark
5149.85	53.66	53.08	54	-0.34	31.56	6.34	37.32	210	294	Average
5149.85	65.73	65.15	74	-8.27	31.56	6.34	37.32	210	294	Peak
5190	99.66	99.03			31.59	6.38	37.34	210	294	Average
5190	108.6	107.97			31.59	6.38	37.34	210	294	Peak
5377.39	56.96	55.95	74	-17.04	31.72	6.47	37.18	210	294	Peak
5377.96	39.79	38.77	54	-14.21	31.73	6.47	37.18	210	294	Average
*10380	54.8	57.54	68.2	-13.4	39.5	10.21	52.45	145	298	Peak

Remarks:

- Emission Level = Read Level + Antenna Factor + Cable Loss - Preamp Factor
Margin value = Emission level – Limit value
- 5190 MHz: Fundamental Frequency
- *: Out of Restricted Band

EUT Test Condition		Measurement Detail	
Channel	Channel 46	Frequency Range	1 GHz ~ 40 GHz
Input Power	120 Vac, 60 Hz	Detector Function	Peak (PK) Average (AV)
Environmental Conditions	25 deg. C, 65 % RH	Tested By	Getaz Yang

Antenna Polarity & Test Distance: Horizontal at 3 m										
Frequency (MHz)	Emission Level (dBuV/m)	Read Level (dBuV)	Limit (dBuV/m)	Margin (dB)	Antenna Factor (dB/m)	Cable Loss (dB)	Preamp Factor (dB)	Antenna Height (cm)	Table Angle (Degree)	Remark
5150	48.06	47.48	54	-5.94	31.56	6.34	37.32	207	19	Average
5150	61.44	60.86	74	-12.56	31.56	6.34	37.32	207	19	Peak
5230	101.83	101.12			31.62	6.41	37.32	207	19	Average
5230	110.31	109.6			31.62	6.41	37.32	207	19	Peak
5380.47	40.74	39.72	54	-13.26	31.73	6.47	37.18	207	19	Average
5380.47	63.12	62.1	74	-10.88	31.73	6.47	37.18	207	19	Peak
*10460	54.36	57.16	68.2	-13.84	39.57	10.22	52.59	295	256	Peak

Antenna Polarity & Test Distance: Vertical at 3 m										
Frequency (MHz)	Emission Level (dBuV/m)	Read Level (dBuV)	Limit (dBuV/m)	Margin (dB)	Antenna Factor (dB/m)	Cable Loss (dB)	Preamp Factor (dB)	Antenna Height (cm)	Table Angle (Degree)	Remark
5149.85	51.63	51.05	54	-2.37	31.56	6.34	37.32	206	297	Average
5149.85	68.56	67.98	74	-5.44	31.56	6.34	37.32	206	297	Peak
5230	104.41	103.7			31.62	6.41	37.32	206	297	Average
5230	113.09	112.38			31.62	6.41	37.32	206	297	Peak
5411.05	41.7	40.66	54	-12.3	31.74	6.48	37.18	206	297	Average
5411.05	64.42	63.38	74	-9.58	31.74	6.48	37.18	206	297	Peak
*10460	53.15	55.95	68.2	-15.05	39.57	10.22	52.59	201	236	Peak

Remarks:

- Emission Level = Read Level + Antenna Factor + Cable Loss - Preamp Factor
Margin value = Emission level – Limit value
- 5230 MHz: Fundamental Frequency
- *: Out of Restricted Band

EUT Test Condition		Measurement Detail	
Channel	Channel 54	Frequency Range	1 GHz ~ 40 GHz
Input Power	120 Vac, 60 Hz	Detector Function	Peak (PK) Average (AV)
Environmental Conditions	25 deg. C, 65 % RH	Tested By	Getaz Yang

Antenna Polarity & Test Distance: Horizontal at 3 m										
Frequency (MHz)	Emission Level (dBuV/m)	Read Level (dBuV)	Limit (dBuV/m)	Margin (dB)	Antenna Factor (dB/m)	Cable Loss (dB)	Preamp Factor (dB)	Antenna Height (cm)	Table Angle (Degree)	Remark
5140.25	41	40.41	54	-13	31.56	6.33	37.3	195	355	Average
5140.25	60.26	59.67	74	-13.74	31.56	6.33	37.3	195	355	Peak
5270	102.2	101.38			31.65	6.44	37.27	195	355	Average
5270	111.23	110.41			31.65	6.44	37.27	195	355	Peak
5351.76	49.55	48.56	54	-4.45	31.7	6.47	37.18	195	355	Average
5351.76	67.71	66.72	74	-6.29	31.7	6.47	37.18	195	355	Peak
*10540	53	55.85	68.2	-15.2	39.7	10.31	52.86	125	231	Peak
Antenna Polarity & Test Distance: Vertical at 3 m										
Frequency (MHz)	Emission Level (dBuV/m)	Read Level (dBuV)	Limit (dBuV/m)	Margin (dB)	Antenna Factor (dB/m)	Cable Loss (dB)	Preamp Factor (dB)	Antenna Height (cm)	Table Angle (Degree)	Remark
5123.6	42.25	41.69	54	-11.75	31.55	6.31	37.3	180	327	Average
5123.6	63.89	63.33	74	-10.11	31.55	6.31	37.3	180	327	Peak
5270	104.12	103.3			31.65	6.44	37.27	180	327	Average
5270	113.04	112.22			31.65	6.44	37.27	180	327	Peak
5357.26	50.22	49.23	54	-3.78	31.7	6.47	37.18	180	327	Average
5357.26	69	68.01	74	-5	31.7	6.47	37.18	180	327	Peak
10540	43.4	46.25	54	-10.6	39.7	10.31	52.86	111	125	Average
*10540	54	56.85	68.2	-14.2	39.7	10.31	52.86	111	125	Peak

Remarks:

- Emission Level = Read Level + Antenna Factor + Cable Loss - Preamp Factor
Margin value = Emission level – Limit value
- 5270 MHz: Fundamental Frequency
- *: Out of Restricted Band

EUT Test Condition		Measurement Detail	
Channel	Channel 62	Frequency Range	1 GHz ~ 40 GHz
Input Power	120 Vac, 60 Hz	Detector Function	Peak (PK) Average (AV)
Environmental Conditions	25 deg. C, 65 % RH	Tested By	Getaz Yang

Antenna Polarity & Test Distance: Horizontal at 3 m										
Frequency (MHz)	Emission Level (dBuV/m)	Read Level (dBuV)	Limit (dBuV/m)	Margin (dB)	Antenna Factor (dB/m)	Cable Loss (dB)	Preamp Factor (dB)	Antenna Height (cm)	Table Angle (Degree)	Remark
5144	39.7	39.13	54	-14.3	31.56	6.33	37.32	164	352	Average
5144	55.56	54.99	74	-18.44	31.56	6.33	37.32	164	352	Peak
5310	98.41	97.46			31.68	6.46	37.19	164	352	Average
5310	106.8	105.85			31.68	6.46	37.19	164	352	Peak
5353.19	52.67	51.68	54	-1.33	31.7	6.47	37.18	164	352	Average
5353.19	68.68	67.69	74	-5.32	31.7	6.47	37.18	164	352	Peak
10620	43.44	46.25	54	-10.56	39.89	10.39	53.09	256	123	Average
10620	53.55	56.36	74	-20.45	39.89	10.39	53.09	256	123	Peak

Antenna Polarity & Test Distance: Vertical at 3 m										
Frequency (MHz)	Emission Level (dBuV/m)	Read Level (dBuV)	Limit (dBuV/m)	Margin (dB)	Antenna Factor (dB/m)	Cable Loss (dB)	Preamp Factor (dB)	Antenna Height (cm)	Table Angle (Degree)	Remark
5125.85	40.2	39.63	54	-13.8	31.55	6.32	37.3	178	323	Average
5125.85	60.17	59.6	74	-13.83	31.55	6.32	37.3	178	323	Peak
5310	101.11	100.16			31.68	6.46	37.19	178	323	Average
5310	109.68	108.73			31.68	6.46	37.19	178	323	Peak
5350.33	53.06	52.07	54	-0.94	31.7	6.47	37.18	178	323	Average
5350.33	71.2	70.21	74	-2.8	31.7	6.47	37.18	178	323	Peak
10620	42.55	45.36	54	-11.45	39.89	10.39	53.09	251	123	Average
10620	53.04	55.85	74	-20.96	39.89	10.39	53.09	251	123	Peak

Remarks:

- Emission Level = Read Level + Antenna Factor + Cable Loss - Preamp Factor
Margin value = Emission level – Limit value
- 5310 MHz: Fundamental Frequency
- *: Out of Restricted Band

EUT Test Condition		Measurement Detail	
Channel	Channel 102	Frequency Range	1 GHz ~ 40 GHz
Input Power	120 Vac, 60 Hz	Detector Function	Peak (PK) Average (AV)
Environmental Conditions	25 deg. C, 65 % RH	Tested By	Getaz Yang

Antenna Polarity & Test Distance: Horizontal at 3 m										
Frequency (MHz)	Emission Level (dBuV/m)	Read Level (dBuV)	Limit (dBuV/m)	Margin (dB)	Antenna Factor (dB/m)	Cable Loss (dB)	Preamp Factor (dB)	Antenna Height (cm)	Table Angle (Degree)	Remark
5457.68	50.42	49.43	54	-3.58	31.56	6.51	37.08	174	22	Average
5457.68	64.93	63.94	74	-9.07	31.56	6.51	37.08	174	22	Peak
*5470	67.02	66.01	68.2	-1.18	31.57	6.52	37.08	174	22	Peak
5510	99.73	98.64			31.6	6.55	37.06	174	22	Average
5510	108.62	107.53			31.6	6.55	37.06	174	22	Peak
*5725	50.59	49.3	68.2	-17.61	31.96	6.76	37.43	174	22	Peak
11020	53.43	55.26	54	-0.57	40.71	10.41	52.95	156	236	Average
11020	55.03	56.86	74	-18.97	40.71	10.41	52.95	156	236	Peak

Antenna Polarity & Test Distance: Vertical at 3 m										
Frequency (MHz)	Emission Level (dBuV/m)	Read Level (dBuV)	Limit (dBuV/m)	Margin (dB)	Antenna Factor (dB/m)	Cable Loss (dB)	Preamp Factor (dB)	Antenna Height (cm)	Table Angle (Degree)	Remark
5459	49.46	48.47	54	-4.54	31.56	6.51	37.08	151	346	Average
5459	66.84	65.85	74	-7.16	31.56	6.51	37.08	151	346	Peak
*5470	67.84	66.83	68.2	-0.36	31.57	6.52	37.08	151	346	Peak
5510	100.52	99.43			31.6	6.55	37.06	151	346	Average
5510	109.5	108.41			31.6	6.55	37.06	151	346	Peak
*5725	49.89	48.6	68.2	-18.31	31.96	6.76	37.43	151	346	Peak
11020	44.43	46.26	54	-9.57	40.71	10.41	52.95	152	123	Average
11020	54.48	56.31	74	-19.52	40.71	10.41	52.95	152	123	Peak

Remarks:

- Emission Level = Read Level + Antenna Factor + Cable Loss - Preamp Factor
Margin value = Emission level – Limit value
- 5510 MHz: Fundamental Frequency
- *: Out of Restricted Band

EUT Test Condition		Measurement Detail	
Channel	Channel 110	Frequency Range	1 GHz ~ 40 GHz
Input Power	120 Vac, 60 Hz	Detector Function	Peak (PK) Average (AV)
Environmental Conditions	25 deg. C, 65 % RH	Tested By	Getaz Yang

Antenna Polarity & Test Distance: Horizontal at 3 m										
Frequency (MHz)	Emission Level (dBuV/m)	Read Level (dBuV)	Limit (dBuV/m)	Margin (dB)	Antenna Factor (dB/m)	Cable Loss (dB)	Preamp Factor (dB)	Antenna Height (cm)	Table Angle (Degree)	Remark
5452.72	47.6	46.61	54	-6.4	31.56	6.51	37.08	183	19	Average
5452.72	65.4	64.41	74	-8.6	31.56	6.51	37.08	183	19	Peak
*5470	62.66	61.65	68.2	-5.54	31.57	6.52	37.08	183	19	Peak
5550	101.7	100.5			31.68	6.61	37.09	183	19	Average
5550	111.4	110.2			31.68	6.61	37.09	183	19	Peak
*5725	52.9	51.61	68.2	-15.3	31.96	6.76	37.43	183	19	Peak
11100	43.64	45.25	54	-10.36	40.63	10.47	52.71	125	236	Average
11100	54.39	56	74	-19.61	40.63	10.47	52.71	125	236	Peak

Antenna Polarity & Test Distance: Vertical at 3 m										
Frequency (MHz)	Emission Level (dBuV/m)	Read Level (dBuV)	Limit (dBuV/m)	Margin (dB)	Antenna Factor (dB/m)	Cable Loss (dB)	Preamp Factor (dB)	Antenna Height (cm)	Table Angle (Degree)	Remark
5458.64	46.49	45.5	54	-7.51	31.56	6.51	37.08	170	345	Average
5458.64	67.54	66.55	74	-6.46	31.56	6.51	37.08	170	345	Peak
*5470	67.21	66.2	68.2	-0.99	31.57	6.52	37.08	170	345	Peak
5550	104	102.8			31.68	6.61	37.09	170	345	Average
5550	112.93	111.73			31.68	6.61	37.09	170	345	Peak
*5725	49.95	48.66	68.2	-18.25	31.96	6.76	37.43	170	345	Peak
11100	43.41	45.02	54	-10.59	40.63	10.47	52.71	256	231	Average
11100	53.56	55.17	74	-20.44	40.63	10.47	52.71	256	231	Peak

Remarks:

- Emission Level = Read Level + Antenna Factor + Cable Loss - Preamp Factor
Margin value = Emission level – Limit value
- 5550 MHz: Fundamental Frequency
- *: Out of Restricted Band

EUT Test Condition		Measurement Detail	
Channel	Channel 134	Frequency Range	1 GHz ~ 40 GHz
Input Power	120 Vac, 60 Hz	Detector Function	Peak (PK) Average (AV)
Environmental Conditions	25 deg. C, 65 % RH	Tested By	Getaz Yang

Antenna Polarity & Test Distance: Horizontal at 3 m										
Frequency (MHz)	Emission Level (dBuV/m)	Read Level (dBuV)	Limit (dBuV/m)	Margin (dB)	Antenna Factor (dB/m)	Cable Loss (dB)	Preamp Factor (dB)	Antenna Height (cm)	Table Angle (Degree)	Remark
5435.44	39.8	38.89	54	-14.2	31.55	6.49	37.13	186	19	Average
5435.44	55.85	54.94	74	-18.15	31.55	6.49	37.13	186	19	Peak
*5470	51.57	50.56	68.2	-16.63	31.57	6.52	37.08	186	19	Peak
5670	97.53	96.27			31.88	6.72	37.34	186	19	Average
5670	106.48	105.22			31.88	6.72	37.34	186	19	Peak
*5725	63.55	62.26	68.2	-4.65	31.96	6.76	37.43	186	19	Peak
11340	43.3	45.1	54	-10.7	40.4	10.52	52.72	251	236	Average
11340	53.44	55.24	74	-20.56	40.4	10.52	52.72	251	236	Peak

Antenna Polarity & Test Distance: Vertical at 3 m										
Frequency (MHz)	Emission Level (dBuV/m)	Read Level (dBuV)	Limit (dBuV/m)	Margin (dB)	Antenna Factor (dB/m)	Cable Loss (dB)	Preamp Factor (dB)	Antenna Height (cm)	Table Angle (Degree)	Remark
5393.04	40.1	39.3	54	-13.9	31.51	6.47	37.18	167	350	Average
5393.04	55.28	54.48	74	-18.72	31.51	6.47	37.18	167	350	Peak
*5470	50.54	49.53	68.2	-17.66	31.57	6.52	37.08	167	350	Peak
5670	99.87	98.61			31.88	6.72	37.34	167	350	Average
5670	108.54	107.28			31.88	6.72	37.34	167	350	Peak
*5725	67.18	65.89	68.2	-1.02	31.96	6.76	37.43	167	350	Peak
11340	41.82	43.62	54	-12.18	40.4	10.52	52.72	201	256	Average
11340	51.48	53.28	74	-22.52	40.4	10.52	52.72	201	256	Peak

Remarks:

- Emission Level = Read Level + Antenna Factor + Cable Loss - Preamp Factor
Margin value = Emission level – Limit value
- 5670 MHz: Fundamental Frequency
- *: Out of Restricted Band

EUT Test Condition		Measurement Detail	
Channel	Channel 151	Frequency Range	1 GHz ~ 40 GHz
Input Power	120 Vac, 60 Hz	Detector Function	Peak (PK) Average (AV)
Environmental Conditions	25 deg. C, 65 % RH	Tested By	Getaz Yang

<Spurious Emission>

Antenna Polarity & Test Distance: Horizontal at 3 m										
Frequency (MHz)	Emission Level (dBuV/m)	Read Level (dBuV)	Limit (dBuV/m)	Margin (dB)	Antenna Factor (dB/m)	Cable Loss (dB)	Preamp Factor (dB)	Antenna Height (cm)	Table Angle (Degree)	Remark
5755	103.47	102.14			32.01	6.79	37.47	168	18	Average
5755	112.67	111.34			32.01	6.79	37.47	168	18	Peak
11510	43.12	45.01	54	-10.88	40.23	10.69	52.81	256	231	Average
11510	53.59	55.48	74	-20.41	40.23	10.69	52.81	256	231	Peak
Antenna Polarity & Test Distance: Vertical at 3 m										
Frequency (MHz)	Emission Level (dBuV/m)	Read Level (dBuV)	Limit (dBuV/m)	Margin (dB)	Antenna Factor (dB/m)	Cable Loss (dB)	Preamp Factor (dB)	Antenna Height (cm)	Table Angle (Degree)	Remark
5755	105.23	103.9			32.01	6.79	37.47	167	350	Average
5755	113.88	112.55			32.01	6.79	37.47	167	350	Peak
11510	44.36	46.25	54	-9.64	40.23	10.69	52.81	203	236	Average
11510	54.2	56.09	74	-19.8	40.23	10.69	52.81	203	236	Peak

<Out of Band Emission (OOBE)>

Antenna Polarity & Test Distance: Horizontal at 3 m										
Frequency (MHz)	Emission Level (dBuV/m)	Read Level (dBuV)	Limit (dBuV/m)	Margin (dB)	Antenna Factor (dB/m)	Cable Loss (dB)	Preamp Factor (dB)	Antenna Height (cm)	Table Angle (Degree)	Remark
5642.15	63.56	62.32	68.2	-4.64	31.82	6.7	37.28	168	18	Peak
5650.225	62.33	61.05	68.37	-6.04	31.85	6.71	37.28	168	18	Peak
5924.3	52.36	50.71	68.72	-16.36	32.29	6.86	37.5	168	18	Peak
5970.375	56.18	54.47	68.2	-12.02	32.34	6.88	37.51	168	18	Peak
Antenna Polarity & Test Distance: Vertical at 3 m										
Frequency (MHz)	Emission Level (dBuV/m)	Read Level (dBuV)	Limit (dBuV/m)	Margin (dB)	Antenna Factor (dB/m)	Cable Loss (dB)	Preamp Factor (dB)	Antenna Height (cm)	Table Angle (Degree)	Remark
5638.35	65.36	64.12	68.2	-2.84	31.82	6.7	37.28	167	350	Peak
5650.7	61.46	60.18	68.72	-7.26	31.85	6.71	37.28	167	350	Peak
5920.5	62.01	60.39	71.52	-9.51	32.26	6.86	37.5	167	350	Peak
5927.15	62.87	61.22	68.2	-5.33	32.29	6.86	37.5	167	350	Peak

Remarks:

- Emission Level = Read Level + Antenna Factor + Cable Loss - Preamp Factor
Margin value = Emission level – Limit value
- 5755 MHz: Fundamental Frequency
- *: Out of Restricted Band

EUT Test Condition		Measurement Detail	
Channel	Channel 159	Frequency Range	1 GHz ~ 40 GHz
Input Power	120 Vac, 60 Hz	Detector Function	Peak (PK) Average (AV)
Environmental Conditions	25 deg. C, 65 % RH	Tested By	Getaz Yang

<Spurious Emission>

Antenna Polarity & Test Distance: Horizontal at 3 m										
Frequency (MHz)	Emission Level (dBuV/m)	Read Level (dBuV)	Limit (dBuV/m)	Margin (dB)	Antenna Factor (dB/m)	Cable Loss (dB)	Preamp Factor (dB)	Antenna Height (cm)	Table Angle (Degree)	Remark
5795	103.29	101.93			32.07	6.83	37.54	172	17	Average
5795	111.53	110.17			32.07	6.83	37.54	172	17	Peak
11590	41.89	44.01	54	-12.11	40.11	10.78	53.01	203	213	Average
11590	52.04	54.16	74	-21.96	40.11	10.78	53.01	203	213	Peak
Antenna Polarity & Test Distance: Vertical at 3 m										
Frequency (MHz)	Emission Level (dBuV/m)	Read Level (dBuV)	Limit (dBuV/m)	Margin (dB)	Antenna Factor (dB/m)	Cable Loss (dB)	Preamp Factor (dB)	Antenna Height (cm)	Table Angle (Degree)	Remark
5795	104.11	102.75			32.07	6.83	37.54	172	350	Average
5795	113.19	111.83			32.07	6.83	37.54	172	350	Peak
11590	43.12	45.24	54	-10.88	40.11	10.78	53.01	203	213	Average
11590	53.4	55.52	74	-20.6	40.11	10.78	53.01	203	213	Peak

<Out of Band Emission (OOBE)>

Antenna Polarity & Test Distance: Horizontal at 3 m										
Frequency (MHz)	Emission Level (dBuV/m)	Read Level (dBuV)	Limit (dBuV/m)	Margin (dB)	Antenna Factor (dB/m)	Cable Loss (dB)	Preamp Factor (dB)	Antenna Height (cm)	Table Angle (Degree)	Remark
5607	61.31	60.08	68.2	-6.89	31.77	6.68	37.22	172	17	Peak
5651.175	59.57	58.29	69.07	-9.5	31.85	6.71	37.28	172	17	Peak
5918.125	60.7	59.08	73.27	-12.57	32.26	6.86	37.5	172	17	Peak
5947.1	58.28	56.59	68.2	-9.92	32.32	6.87	37.5	172	17	Peak
Antenna Polarity & Test Distance: Vertical at 3 m										
Frequency (MHz)	Emission Level (dBuV/m)	Read Level (dBuV)	Limit (dBuV/m)	Margin (dB)	Antenna Factor (dB/m)	Cable Loss (dB)	Preamp Factor (dB)	Antenna Height (cm)	Table Angle (Degree)	Remark
5620.3	60.84	59.58	68.2	-7.36	31.79	6.69	37.22	172	350	Peak
5651.65	62.69	61.41	69.43	-6.74	31.85	6.71	37.28	172	350	Peak
5922.875	63.82	62.17	69.77	-5.95	32.29	6.86	37.5	172	350	Peak
5964.2	63.19	61.48	68.2	-5.01	32.34	6.88	37.51	172	350	Peak

Remarks:

- Emission Level = Read Level + Antenna Factor + Cable Loss - Preamp Factor
Margin value = Emission level – Limit value
- 5795 MHz: Fundamental Frequency
- *: Out of Restricted Band

802.11ac (VHT80)

EUT Test Condition		Measurement Detail	
Channel	Channel 42	Frequency Range	1 GHz ~ 40 GHz
Input Power	120 Vac, 60 Hz	Detector Function	Peak (PK) Average (AV)
Environmental Conditions	25 deg. C, 65 % RH	Tested By	Getaz Yang

Antenna Polarity & Test Distance: Horizontal at 3 m

Frequency (MHz)	Emission Level (dBuV/m)	Read Level (dBuV)	Limit (dBuV/m)	Margin (dB)	Antenna Factor (dB/m)	Cable Loss (dB)	Preamp Factor (dB)	Antenna Height (cm)	Table Angle (Degree)	Remark
5150	50.66	50.08	54	-3.34	31.56	6.34	37.32	193	0	Average
5150	61.26	60.68	74	-12.74	31.56	6.34	37.32	193	0	Peak
5210	91.16	90.51			31.61	6.4	37.36	193	0	Average
5210	100.75	100.1			31.61	6.4	37.36	193	0	Peak
5355.83	44.16	43.17	54	-9.84	31.7	6.47	37.18	193	0	Average
5355.83	55.73	54.74	74	-18.27	31.7	6.47	37.18	193	0	Peak
*10420	52.18	54.89	68.2	-16.02	39.53	10.21	52.45	125	265	Peak

Antenna Polarity & Test Distance: Vertical at 3 m

Frequency (MHz)	Emission Level (dBuV/m)	Read Level (dBuV)	Limit (dBuV/m)	Margin (dB)	Antenna Factor (dB/m)	Cable Loss (dB)	Preamp Factor (dB)	Antenna Height (cm)	Table Angle (Degree)	Remark
5149.85	53.14	52.56	54	-0.86	31.56	6.34	37.32	209	293	Average
5149.85	65.04	64.46	74	-8.96	31.56	6.34	37.32	209	293	Peak
5210	95.12	94.47			31.61	6.4	37.36	209	293	Average
5210	104.88	104.23			31.61	6.4	37.36	209	293	Peak
5355.5	43.76	42.77	54	-10.24	31.7	6.47	37.18	209	293	Average
5355.5	54.27	53.28	74	-19.73	31.7	6.47	37.18	209	293	Peak
*10420	52.37	55.08	68.2	-15.83	39.53	10.21	52.45	185	142	Peak

Remarks:

- Emission Level = Read Level + Antenna Factor + Cable Loss - Preamp Factor
Margin value = Emission level – Limit value
- 5210 MHz: Fundamental Frequency
- *: Out of Restricted Band

EUT Test Condition		Measurement Detail	
Channel	Channel 58	Frequency Range	1 GHz ~ 40 GHz
Input Power	120 Vac, 60 Hz	Detector Function	Peak (PK) Average (AV)
Environmental Conditions	25 deg. C, 65 % RH	Tested By	Getaz Yang

Antenna Polarity & Test Distance: Horizontal at 3 m										
Frequency (MHz)	Emission Level (dBuV/m)	Read Level (dBuV)	Limit (dBuV/m)	Margin (dB)	Antenna Factor (dB/m)	Cable Loss (dB)	Preamp Factor (dB)	Antenna Height (cm)	Table Angle (Degree)	Remark
5147.9	44.29	43.71	54	-9.71	31.56	6.34	37.32	209	353	Average
5147.9	56.07	55.49	74	-17.93	31.56	6.34	37.32	209	353	Peak
5290	94.14	93.26			31.66	6.45	37.23	209	353	Average
5290	103.16	102.28			31.66	6.45	37.23	209	353	Peak
5350.11	52.7	51.71	54	-1.3	31.7	6.47	37.18	209	353	Average
5350.11	64.06	63.07	74	-9.94	31.7	6.47	37.18	209	353	Peak
*10580	52.78	55.69	68.2	-15.42	39.81	10.39	53.11	251	123	Peak
Antenna Polarity & Test Distance: Vertical at 3 m										
Frequency (MHz)	Emission Level (dBuV/m)	Read Level (dBuV)	Limit (dBuV/m)	Margin (dB)	Antenna Factor (dB/m)	Cable Loss (dB)	Preamp Factor (dB)	Antenna Height (cm)	Table Angle (Degree)	Remark
5148.5	46.8	46.22	54	-7.2	31.56	6.34	37.32	188	329	Average
5148.5	57.49	56.91	74	-16.51	31.56	6.34	37.32	188	329	Peak
5290	97.41	96.53			31.66	6.45	37.23	188	329	Average
5290	105.78	104.9			31.66	6.45	37.23	188	329	Peak
5356.6	53.01	52.02	54	-0.99	31.7	6.47	37.18	188	329	Average
5356.6	64.57	63.58	74	-9.43	31.7	6.47	37.18	188	329	Peak
*10580	53.99	56.9	68.2	-14.21	39.81	10.39	53.11	251	223	Peak

Remarks:

- Emission Level = Read Level + Antenna Factor + Cable Loss - Preamp Factor
Margin value = Emission level – Limit value
- 5290 MHz: Fundamental Frequency
- *: Out of Restricted Band

EUT Test Condition		Measurement Detail	
Channel	Channel 106	Frequency Range	1 GHz ~ 40 GHz
Input Power	120 Vac, 60 Hz	Detector Function	Peak (PK) Average (AV)
Environmental Conditions	25 deg. C, 65 % RH	Tested By	Getaz Yang

Antenna Polarity & Test Distance: Horizontal at 3 m										
Frequency (MHz)	Emission Level (dBuV/m)	Read Level (dBuV)	Limit (dBuV/m)	Margin (dB)	Antenna Factor (dB/m)	Cable Loss (dB)	Preamp Factor (dB)	Antenna Height (cm)	Table Angle (Degree)	Remark
5453.04	52.35	51.36	54	-1.65	31.56	6.51	37.08	186	19	Average
5453.04	62.9	61.91	74	-11.1	31.56	6.51	37.08	186	19	Peak
*5470	63.33	62.32	68.2	-4.87	31.57	6.52	37.08	186	19	Peak
5530	94.78	93.66			31.63	6.58	37.09	186	19	Average
5530	104.14	103.02			31.63	6.58	37.09	186	19	Peak
*5725	50.54	49.25	68.2	-17.66	31.96	6.76	37.43	186	19	Peak
11060	45.88	47.57	54	-8.12	40.66	10.44	52.79	201	256	Average
11060	56.22	57.91	74	-17.78	40.66	10.44	52.79	201	256	Peak

Antenna Polarity & Test Distance: Vertical at 3 m										
Frequency (MHz)	Emission Level (dBuV/m)	Read Level (dBuV)	Limit (dBuV/m)	Margin (dB)	Antenna Factor (dB/m)	Cable Loss (dB)	Preamp Factor (dB)	Antenna Height (cm)	Table Angle (Degree)	Remark
5456.72	53.11	52.12	54	-0.89	31.56	6.51	37.08	183	335	Average
5456.72	63.9	62.91	74	-10.1	31.56	6.51	37.08	183	335	Peak
*5470	64.93	63.92	68.2	-3.27	31.57	6.52	37.08	183	335	Peak
5530	95.71	94.59			31.63	6.58	37.09	183	335	Average
5530	104.99	103.87			31.63	6.58	37.09	183	335	Peak
*5725	51.1	49.81	68.2	-17.1	31.96	6.76	37.43	183	335	Peak
11060	43.95	45.64	54	-10.05	40.66	10.44	52.79	203	251	Average
11060	53.97	55.66	74	-20.03	40.66	10.44	52.79	203	251	Peak

Remarks:

- Emission Level = Read Level + Antenna Factor + Cable Loss - Preamp Factor
Margin value = Emission level – Limit value
- 5530 MHz: Fundamental Frequency
- *: Out of Restricted Band

EUT Test Condition		Measurement Detail	
Channel	Channel 122	Frequency Range	1 GHz ~ 40 GHz
Input Power	120 Vac, 60 Hz	Detector Function	Peak (PK) Average (AV)
Environmental Conditions	25 deg. C, 65 % RH	Tested By	Getaz Yang

Antenna Polarity & Test Distance: Horizontal at 3 m										
Frequency (MHz)	Emission Level (dBuV/m)	Read Level (dBuV)	Limit (dBuV/m)	Margin (dB)	Antenna Factor (dB/m)	Cable Loss (dB)	Preamp Factor (dB)	Antenna Height (cm)	Table Angle (Degree)	Remark
5451.12	51.5	50.51	54	-2.5	31.56	6.51	37.08	197	19	Average
5451.12	63.34	62.35	74	-10.66	31.56	6.51	37.08	197	19	Peak
*5470	64	62.99	68.2	-4.2	31.57	6.52	37.08	197	19	Peak
5610	100.91	99.68			31.77	6.68	37.22	197	19	Average
5610	109.1	107.87			31.77	6.68	37.22	197	19	Peak
*5725	67.7	66.41	68.2	-0.5	31.96	6.76	37.43	197	19	Peak
11220	42.94	44.69	54	-11.06	40.51	10.55	52.81	325	123	Average
11220	52.85	54.6	74	-21.15	40.51	10.55	52.81	325	123	Peak

Antenna Polarity & Test Distance: Vertical at 3 m										
Frequency (MHz)	Emission Level (dBuV/m)	Read Level (dBuV)	Limit (dBuV/m)	Margin (dB)	Antenna Factor (dB/m)	Cable Loss (dB)	Preamp Factor (dB)	Antenna Height (cm)	Table Angle (Degree)	Remark
5459.76	53.15	52.16	54	-0.85	31.56	6.51	37.08	159	344	Average
5459.76	64.82	63.83	74	-9.18	31.56	6.51	37.08	159	344	Peak
*5470	65.7	64.69	68.2	-2.5	31.57	6.52	37.08	159	344	Peak
5610	101.67	100.44			31.77	6.68	37.22	159	344	Average
5610	110.98	109.75			31.77	6.68	37.22	159	344	Peak
*5725	67.72	66.43	68.2	-0.48	31.96	6.76	37.43	159	344	Peak
11220	42.37	44.12	54	-11.63	40.51	10.55	52.81	205	236	Average
11220	52.79	54.54	74	-21.21	40.51	10.55	52.81	205	236	Peak

Remarks:

- Emission Level = Read Level + Antenna Factor + Cable Loss - Preamp Factor
Margin value = Emission level – Limit value
- 5610 MHz: Fundamental Frequency
- *: Out of Restricted Band

EUT Test Condition		Measurement Detail	
Channel	Channel 155	Frequency Range	1 GHz ~ 40 GHz
Input Power	120 Vac, 60 Hz	Detector Function	Peak (PK) Average (AV)
Environmental Conditions	25 deg. C, 65 % RH	Tested By	Getaz Yang

<Spurious Emission>

Antenna Polarity & Test Distance: Horizontal at 3 m										
Frequency (MHz)	Emission Level (dBuV/m)	Read Level (dBuV)	Limit (dBuV/m)	Margin (dB)	Antenna Factor (dB/m)	Cable Loss (dB)	Preamp Factor (dB)	Antenna Height (cm)	Table Angle (Degree)	Remark
5775	98.44	97.09			32.04	6.81	37.5	180	17	Average
5775	106.43	105.08			32.04	6.81	37.5	180	17	Peak
11550	42.97	45.01	54	-11.03	40.16	10.74	52.94	203	111	Average
11550	53.11	55.15	74	-20.89	40.16	10.74	52.94	203	111	Peak
Antenna Polarity & Test Distance: Vertical at 3 m										
Frequency (MHz)	Emission Level (dBuV/m)	Read Level (dBuV)	Limit (dBuV/m)	Margin (dB)	Antenna Factor (dB/m)	Cable Loss (dB)	Preamp Factor (dB)	Antenna Height (cm)	Table Angle (Degree)	Remark
5795	101.74	100.38			32.07	6.83	37.54	169	351	Average
5795	110.97	109.61			32.07	6.83	37.54	169	351	Peak
11550	44.2	46.24	54	-9.8	40.16	10.74	52.94	203	256	Average
11550	54.32	56.36	74	-19.68	40.16	10.74	52.94	203	256	Peak

<Out of Band Emission (OOBE)>

Antenna Polarity & Test Distance: Horizontal at 3 m										
Frequency (MHz)	Emission Level (dBuV/m)	Read Level (dBuV)	Limit (dBuV/m)	Margin (dB)	Antenna Factor (dB/m)	Cable Loss (dB)	Preamp Factor (dB)	Antenna Height (cm)	Table Angle (Degree)	Remark
5642.15	67.48	66.24	68.2	-0.72	31.82	6.7	37.28	180	17	Peak
5652.6	67.12	65.84	70.13	-3.01	31.85	6.71	37.28	180	17	Peak
5922.4	59.46	57.81	70.12	-10.66	32.29	6.86	37.5	180	17	Peak
5928.1	60.03	58.38	68.2	-8.17	32.29	6.86	37.5	180	17	Peak
Antenna Polarity & Test Distance: Vertical at 3 m										
Frequency (MHz)	Emission Level (dBuV/m)	Read Level (dBuV)	Limit (dBuV/m)	Margin (dB)	Antenna Factor (dB/m)	Cable Loss (dB)	Preamp Factor (dB)	Antenna Height (cm)	Table Angle (Degree)	Remark
5648.8	68.07	66.83	68.2	-0.13	31.82	6.7	37.28	169	351	Peak
5652.6	68.47	67.19	70.13	-1.66	31.85	6.71	37.28	169	351	Peak
5922.875	61.38	59.73	69.77	-8.39	32.29	6.86	37.5	169	351	Peak
5928.575	62.77	61.12	68.2	-5.43	32.29	6.86	37.5	169	351	Peak

Remarks:

- Emission Level = Read Level + Antenna Factor + Cable Loss - Preamp Factor
Margin value = Emission level – Limit value
- 5775 MHz: Fundamental Frequency
- *: Out of Restricted Band

9 kHz ~ 30 MHz Data:

The amplitude of spurious emissions attenuated more than 20 dB below the permissible value is not required to be report.

30 MHz ~ 1 GHz Worst-Case Data:

802.11ac (VHT80)

EUT Test Condition		Measurement Detail	
Channel	Channel 155	Frequency Range	30 MHz ~ 1 GHz
Input Power	120 Vac, 60 Hz	Detector Function	Peak (PK) Quasi-peak (QP)
Environmental Conditions	25 deg. C, 65 % RH	Tested By	Getaz Yang

Antenna Polarity & Test Distance: Horizontal at 3 m										
Frequency (MHz)	Emission Level (dBuV/m)	Read Level (dBuV)	Limit (dBuV/m)	Margin (dB)	Antenna Factor (dB/m)	Cable Loss (dB)	Preamp Factor (dB)	Antenna Height (cm)	Table Angle (Degree)	Remark
119.24	22.1	42.22	43.5	-21.4	10.93	0.84	31.89	116	332	Peak
216.24	18.29	38.59	46	-27.71	10.05	1.31	31.66	119	99	Peak
322.94	23.79	40.4	46	-22.21	13.5	1.76	31.87	116	51	Peak
544.1	24.52	35.34	46	-21.48	18.33	2.67	31.82	113	69	Peak
629.46	28.21	37.37	46	-17.79	19.96	3.02	32.14	138	233	Peak
900.09	35.66	40.13	46	-10.34	23.51	4.03	32.01	146	208	Peak
Antenna Polarity & Test Distance: Vertical at 3 m										
Frequency (MHz)	Emission Level (dBuV/m)	Read Level (dBuV)	Limit (dBuV/m)	Margin (dB)	Antenna Factor (dB/m)	Cable Loss (dB)	Preamp Factor (dB)	Antenna Height (cm)	Table Angle (Degree)	Remark
41.64	28.31	45.3	40	-11.69	13.56	0.5	31.05	101	139	Peak
119.24	19.71	39.83	43.5	-23.79	10.93	0.84	31.89	114	276	Peak
353.01	18.29	34.06	46	-27.71	14.22	1.89	31.88	119	9	Peak
544.1	28.57	39.39	46	-17.43	18.33	2.67	31.82	149	161	Peak
763.32	26.09	32.24	46	-19.91	21.71	3.55	31.41	150	16	Peak
900.09	28.78	33.25	46	-17.22	23.51	4.03	32.01	126	39	Peak

Remarks:

- Emission Level = Read Level + Antenna Factor + Cable Loss - Preamp Factor
Margin value = Emission level – Limit value

4.2 Conducted Emission Measurement

4.2.1 Limits of Conducted Emission Measurement

Frequency (MHz)	Conducted Limit (dBuV)	
	Quasi-peak	Average
0.15 - 0.5	66 - 56	56 - 46
0.50 - 5.0	56	46
5.0 - 30.0	60	50

- Note: 1. The lower limit shall apply at the transition frequencies.
 2. The limit decreases in line with the logarithm of the frequency in the range of 0.15 to 0.50 MHz.

4.2.2 Test Instruments

Description & Manufacturer	Model No.	Serial No.	Date Of Calibration	Due Date Of Calibration
Test Receiver ROHDE & SCHWARZ	ESCI	100613	Nov. 21, 2016	Nov. 20, 2017
RF signal cable (with 10dB PAD) Woken	5D-FB	Cable-cond1-01	Sep. 05, 2017	Sep. 04, 2018
LISN/AMN ROHDE & SCHWARZ (EUT)	ESH3-Z5	835239/001	Mar. 10, 2017	Mar. 09, 2018
LISN/AMN ROHDE & SCHWARZ (Peripheral)	ENV216	101196	Apr. 20, 2017	Apr. 19, 2018
Software ADT	BV ADT_Cond_ V7.3.7.3	NA	NA	NA

- Note: 1. The calibration interval of the above test instruments is 12 months and the calibrations are traceable to NML/ROC and NIST/USA.
 2. The test was performed in HwaYa Shielded Room 1.
 3. The VCCI Site Registration No. is C-2040.

4.2.3 Test Procedures

- a. The EUT was placed 0.4 meters from the conducting wall of the shielded room with EUT being connected to the power mains through a line impedance stabilization network (LISN). Other support units were connected to the power mains through another LISN. The two LISNs provide 50 ohm/ 50uH of coupling impedance for the measuring instrument.
- b. Both lines of the power mains connected to the EUT were checked for maximum conducted interference.
- c. The frequency range from 150 kHz to 30 MHz was searched. Emission levels under (Limit -20 dB) was not recorded.

Note: All modes of operation were investigated and the worst-case emissions are reported.

4.2.4 Deviation from Test Standard

No deviation.

4.2.5 Test Setup

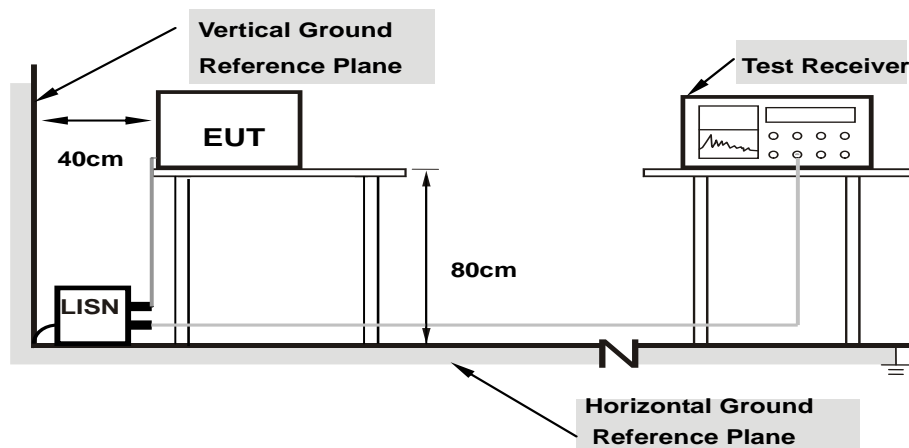

- Note:**
- 1.Support units were connected to second LISN.
 - 2.Both of LISNs (AMN) are 80 cm from EUT and at least 80 from other units and other metal planes

For the actual test configuration, please refer to the attached file (Test Setup Photo).

4.2.6 EUT Operating Conditions

- a. Placed the EUT on a testing table.
- b. Use the software to control the EUT under transmission condition continuously at specific channel frequency.

4.2.7 Test Results

Frequency Range	150kHz ~ 30MHz	Detector Function & Resolution Bandwidth	Quasi-Peak (QP) / Average (AV), 9kHz
Input Power	120Vac, 60Hz	Environmental Conditions	25°C, 65%RH
Tested by	Getaz Yang	Test Date	2018/2/27

Phase Of Power : Line (L)										
No	Frequency (MHz)	Correction Factor (dB)	Reading Value (dBuV)		Emission Level (dBuV)		Limit (dBuV)		Margin (dB)	
			Q.P.	AV.	Q.P.	AV.	Q.P.	AV.	Q.P.	AV.
1	0.15000	10.10	47.01	29.64	57.11	39.74	66.00	56.00	-8.89	-16.26
2	0.19692	10.10	41.00	25.05	51.10	35.15	63.74	53.74	-12.64	-18.59
3	0.23961	10.11	39.35	22.35	49.46	32.46	62.11	52.11	-12.65	-19.65
4	0.49408	10.12	30.79	20.71	40.91	30.83	56.10	46.10	-15.19	-15.27
5	1.28390	10.15	22.00	7.69	32.15	17.84	56.00	46.00	-23.85	-28.16
6	7.28575	10.47	15.47	2.04	25.94	12.51	60.00	50.00	-34.06	-37.49

Remarks:

1. Q.P. and AV. are abbreviations of quasi-peak and average individually.
2. The emission levels of other frequencies were very low against the limit.
3. Margin value = Emission level – Limit value
4. Correction factor = Insertion loss + Cable loss
5. Emission Level = Correction Factor + Reading Value

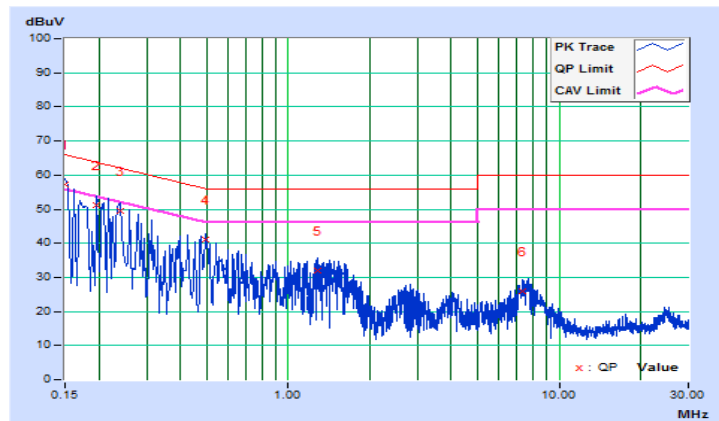

Frequency Range	150kHz ~ 30MHz	Detector Function & Resolution Bandwidth	Quasi-Peak (QP) / Average (AV), 9kHz
Input Power	120Vac, 60Hz	Environmental Conditions	25°C, 65%RH
Tested by	Getaz Yang	Test Date	2018/2/27

Phase Of Power : Neutral (N)										
No	Frequency (MHz)	Correction Factor (dB)	Reading Value (dBuV)		Emission Level (dBuV)		Limit (dBuV)		Margin (dB)	
			Q.P.	AV.	Q.P.	AV.	Q.P.	AV.	Q.P.	AV.
1	0.17737	10.10	43.94	26.52	54.04	36.62	64.61	54.61	-10.57	-17.99
2	0.19301	10.10	42.25	24.48	52.35	34.58	63.91	53.91	-11.56	-19.33
3	0.24775	10.11	37.32	20.48	47.43	30.59	61.83	51.83	-14.40	-21.24
4	0.47453	10.12	30.30	18.67	40.42	28.79	56.43	46.43	-16.01	-17.64
5	1.35819	10.15	21.04	9.85	31.19	20.00	56.00	46.00	-24.81	-26.00
6	7.36395	10.41	13.36	3.72	23.77	14.13	60.00	50.00	-36.23	-35.87

Remarks:

1. Q.P. and AV. are abbreviations of quasi-peak and average individually.
2. The emission levels of other frequencies were very low against the limit.
3. Margin value = Emission level – Limit value
4. Correction factor = Insertion loss + Cable loss
5. Emission Level = Correction Factor + Reading Value

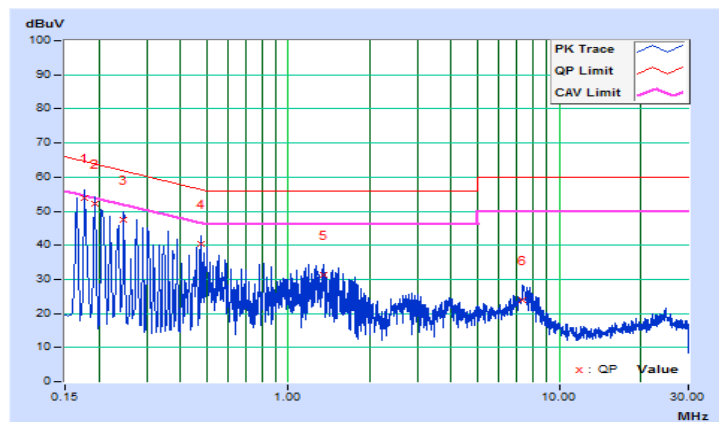

4.3 Transmit Power Measurement

4.3.1 Limits of Transmit Power Measurement

Operation Band	EUT Category	Limit
U-NII-1	Outdoor Access Point	1 Watt (30 dBm) (Max. e.i.r.p \leq 125 mW (21 dBm) at any elevation angle above 30 degrees as measured from the horizon)
	Fixed point-to-point Access Point	1 Watt (30 dBm)
	Indoor Access Point	1 Watt (30 dBm)
	√ Mobile and Portable client device	250 mW (24 dBm)
U-NII-2A	√	250 mW (24 dBm) or 11 dBm + 10 log B*
U-NII-2C	√	250 mW (24 dBm) or 11 dBm + 10 log B*
U-NII-3	√	1 Watt (30 dBm)

*B is the 26 dB emission bandwidth in megahertz

Per KDB 662911 Method of conducted output power measurement on IEEE 802.11 devices,

Array Gain = 0 dB (i.e., no array gain) for $N_{ANT} \leq 4$;

Array Gain = 0 dB (i.e., no array gain) for channel widths ≥ 40 MHz for any N_{ANT} ;

Array Gain = $5 \log(N_{ANT}/N_{SS})$ dB or 3 dB, whichever is less for 20 MHz channel widths with $N_{ANT} \geq 5$.

For power measurements on all other devices: Array Gain = $10 \log(N_{ANT}/N_{SS})$ dB.

4.3.2 Test Setup

<Power Output Measurement>

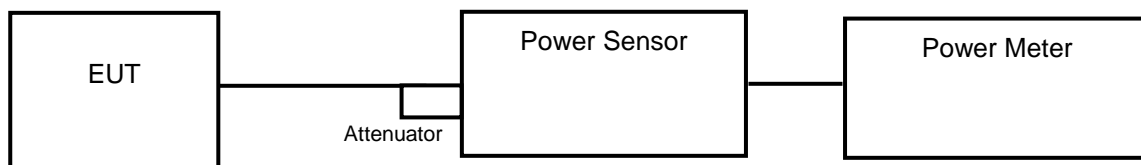

or

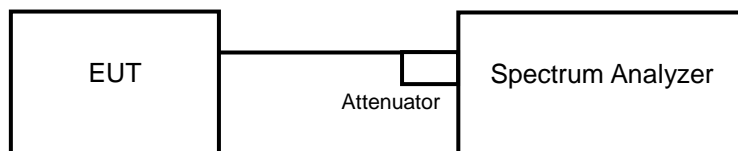

<26 dB Bandwidth>

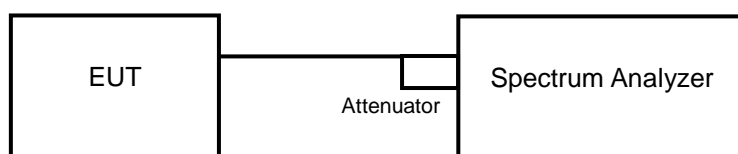

4.3.3 Test Instruments

Refer to section 4.1.2 to get information of above instrument.

4.3.4 Test Procedure

Average Power Measurement

<802.11a, 802.11n (HT20), 802.11n (HT40)>

Method PM is used to perform output power measurement, trigger and gating function of wide band power meter is enabled to measure max output power of TX on burst. Duty factor is not added to measured value.

<802.11ac (VHT80)>

Method SA-1 is used to perform output power measurement, trigger and gating function of spectrum analyzer is enabled to measure max output power of TX on burst. Duty factor is not added to measured value.

26 dB Bandwidth

- 1) Set RBW = approximately 1 % of the emission bandwidth.
- 2) Set the VBW > RBW.
- 3) Detector = Peak.
- 4) Trace mode = max hold.
- 5) Measure the maximum width of the emission that is 26 dB down from the peak of the emission. Compare this with the RBW setting of the analyzer. Readjust RBW and repeat measurement as needed until the RBW/EBW ratio is approximately 1 %.

4.3.5 Deviation from Test Standard

No deviation.

4.3.6 EUT Operating Conditions

The software provided by client to enable the EUT under transmission condition continuously at lowest, middle and highest channel frequencies individually.

4.3.7 Test Result

Power Output:

802.11a

Channel	Frequency (MHz)	Maximum Conducted Power (dBm)		Total Power (mW)	Total Power (dBm)	Power Limit (dBm)	Pass / Fail
		Chain 0	Chain 1				
36	5180	19.08	19.31	166.22	22.21	24	Pass
44	5220	19.55	19.78	185.217	22.68	24	Pass
48	5240	19.37	19.96	185.58	22.69	24	Pass
52	5260	19.54	19.91	187.899	22.74	24	Pass
60	5300	19.68	20.09	194.991	22.90	24	Pass
64	5320	19.59	20.07	192.616	22.85	24	Pass
100	5500	18.67	19.15	155.845	21.93	24	Pass
116	5580	19.23	19.97	183.065	22.63	24	Pass
140	5700	17.66	18.07	122.466	20.88	24	Pass
149	5745	19.45	19.96	187.188	22.72	30	Pass
157	5785	19.39	20.00	186.896	22.72	30	Pass
165	5825	19.21	20.03	184.061	22.65	30	Pass

Note:

For U-NII-2A, U-NII-2C Band:

Chain 0

1. $11 \text{ dBm} + 10\log(21.66) = 24.35 \text{ dBm} > 24 \text{ dBm}$.
2. $11 \text{ dBm} + 10\log(21.53) = 24.33 \text{ dBm} > 24 \text{ dBm}$.
3. $11 \text{ dBm} + 10\log(26.95) = 25.3 \text{ dBm} > 24 \text{ dBm}$.
4. $11 \text{ dBm} + 10\log(25.34) = 25.03 \text{ dBm} > 24 \text{ dBm}$.
5. $11 \text{ dBm} + 10\log(23.47) = 24.7 \text{ dBm} > 24 \text{ dBm}$.
6. $11 \text{ dBm} + 10\log(25.12) = 25 \text{ dBm} > 24 \text{ dBm}$.

Chain 1

1. $11 \text{ dBm} + 10\log(25.75) = 25.1 \text{ dBm} > 24 \text{ dBm}$.
2. $11 \text{ dBm} + 10\log(25.39) = 25.04 \text{ dBm} > 24 \text{ dBm}$.
3. $11 \text{ dBm} + 10\log(29.07) = 25.63 \text{ dBm} > 24 \text{ dBm}$.
4. $11 \text{ dBm} + 10\log(25.36) = 25.04 \text{ dBm} > 24 \text{ dBm}$.
5. $11 \text{ dBm} + 10\log(27.42) = 25.38 \text{ dBm} > 24 \text{ dBm}$.
6. $11 \text{ dBm} + 10\log(25.33) = 25.03 \text{ dBm} > 24 \text{ dBm}$.

802.11n (HT20)

Channel	Frequency (MHz)	Maximum Conducted Power (dBm)		Total Power (mW)	Total Power (dBm)	Power Limit (dBm)	Pass / Fail
		Chain 0	Chain 1				
36	5180	19.11	19.51	170.801	22.32	24	Pass
44	5220	19.72	19.84	190.139	22.79	24	Pass
48	5240	19.65	19.96	191.34	22.82	24	Pass
52	5260	19.76	19.97	193.936	22.88	24	Pass
60	5300	19.75	20.02	194.868	22.90	24	Pass
64	5320	19.74	20.03	194.882	22.90	24	Pass
100	5500	18.75	19.29	159.907	22.04	24	Pass
116	5580	19.23	19.87	180.804	22.57	24	Pass
140	5700	17.34	17.69	112.949	20.53	24	Pass
149	5745	19.43	20.08	189.559	22.78	30	Pass
157	5785	19.51	20.16	193.084	22.86	30	Pass
165	5825	19.24	20.16	187.699	22.73	30	Pass

Note:

For U-NII-2A, U-NII-2C Band:

Chain 0

- $11 \text{ dBm} + 10\log(28.63) = 25.56 \text{ dBm} > 24 \text{ dBm}$.
- $11 \text{ dBm} + 10\log(27.89) = 25.45 \text{ dBm} > 24 \text{ dBm}$.
- $11 \text{ dBm} + 10\log(26.06) = 25.15 \text{ dBm} > 24 \text{ dBm}$.
- $11 \text{ dBm} + 10\log(24.50) = 24.89 \text{ dBm} > 24 \text{ dBm}$.
- $11 \text{ dBm} + 10\log(29.27) = 25.66 \text{ dBm} > 24 \text{ dBm}$.
- $11 \text{ dBm} + 10\log(24.57) = 24.9 \text{ dBm} > 24 \text{ dBm}$.

Chain 1

- $11 \text{ dBm} + 10\log(29.90) = 25.75 \text{ dBm} > 24 \text{ dBm}$.
- $11 \text{ dBm} + 10\log(31.34) = 25.96 \text{ dBm} > 24 \text{ dBm}$.
- $11 \text{ dBm} + 10\log(29.98) = 25.76 \text{ dBm} > 24 \text{ dBm}$.
- $11 \text{ dBm} + 10\log(25.13) = 25 \text{ dBm} > 24 \text{ dBm}$.
- $11 \text{ dBm} + 10\log(32.95) = 26.17 \text{ dBm} > 24 \text{ dBm}$.
- $11 \text{ dBm} + 10\log(22.60) = 24.54 \text{ dBm} > 24 \text{ dBm}$.

802.11n (HT40)

Channel	Frequency (MHz)	Maximum Conducted Power (dBm)		Total Power (mW)	Total Power (dBm)	Power Limit (dBm)	Pass / Fail
		Chain 0	Chain 1				
38	5190	14.65	14.92	60.22	17.80	24	Pass
46	5230	20.16	20.45	214.67	23.32	24	Pass
54	5270	20.20	20.56	218.476	23.39	24	Pass
62	5310	15.87	16.31	81.393	19.11	24	Pass
102	5510	15.14	15.62	69.134	18.40	24	Pass
110	5550	18.75	19.16	157.403	21.97	24	Pass
134	5670	13.87	14.19	50.62	17.04	24	Pass
151	5755	19.97	20.59	213.863	23.30	30	Pass
159	5795	20.06	20.71	219.152	23.41	30	Pass

Note:

For U-NII-2A, U-NII-2C Band:

Chain 0

1. $11 \text{ dBm} + 10\log (70.12) = 29.45 \text{ dBm} > 24 \text{ dBm}$.
2. $11 \text{ dBm} + 10\log (41.55) = 27.18 \text{ dBm} > 24 \text{ dBm}$.
3. $11 \text{ dBm} + 10\log (43.81) = 27.41 \text{ dBm} > 24 \text{ dBm}$.
4. $11 \text{ dBm} + 10\log (49.21) = 27.92 \text{ dBm} > 24 \text{ dBm}$.
5. $11 \text{ dBm} + 10\log (43.04) = 27.33 \text{ dBm} > 24 \text{ dBm}$.

Chain 1

1. $11 \text{ dBm} + 10\log (73.32) = 29.65 \text{ dBm} > 24 \text{ dBm}$.
2. $11 \text{ dBm} + 10\log (41.81) = 27.21 \text{ dBm} > 24 \text{ dBm}$.
3. $11 \text{ dBm} + 10\log (41.56) = 27.18 \text{ dBm} > 24 \text{ dBm}$.
4. $11 \text{ dBm} + 10\log (57.19) = 28.57 \text{ dBm} > 24 \text{ dBm}$.
5. $11 \text{ dBm} + 10\log (41.77) = 27.2 \text{ dBm} > 24 \text{ dBm}$.

802.11ac (VHT80)

Channel	Frequency (MHz)	Maximum Conducted Power (dBm)		Total Power (mW)	Total Power (dBm)	Power Limit (dBm)	Pass / Fail
		Chain 0	Chain 1				
42	5210	12.97	12.55	37.804	15.78	24	Pass
58	5290	14.83	14.85	60.958	17.85	24	Pass
106	5530	13.52	14.13	48.373	16.85	24	Pass
122	5610	19.27	19.11	165.998	22.20	24	Pass
155	5775	18.62	19.24	156.724	21.95	30	Pass

Note:

For U-NII-2A, U-NII-2C Band:

Chain 0

1. $11 \text{ dBm} + 10\log (83.58) = 30.22 \text{ dBm} > 24 \text{ dBm}$.
2. $11 \text{ dBm} + 10\log (83.94) = 30.23 \text{ dBm} > 24 \text{ dBm}$.
3. $11 \text{ dBm} + 10\log (135.24) = 32.31 \text{ dBm} > 24 \text{ dBm}$.

Chain 1

1. $11 \text{ dBm} + 10\log (83.11) = 30.19 \text{ dBm} > 24 \text{ dBm}$.
2. $11 \text{ dBm} + 10\log (83.52) = 30.21 \text{ dBm} > 24 \text{ dBm}$.
3. $11 \text{ dBm} + 10\log (159.17) = 33.01 \text{ dBm} > 24 \text{ dBm}$.

26 dB Bandwidth:
802.11a

Channel	Frequency (MHz)	26 dBc Bandwidth (MHz)	
		Chain 0	Chain 1
36	5180	25.71	27.98
44	5220	27.39	28.13
48	5240	25.12	33.77
52	5260	21.66	25.75
60	5300	21.53	25.39
64	5320	26.95	29.07
100	5500	25.34	25.36
116	5580	23.47	27.42
140	5700	25.12	25.33

802.11n (HT20)

Channel	Frequency (MHz)	26 dBc Bandwidth (MHz)	
		Chain 0	Chain 1
36	5180	25.91	25.87
44	5220	28.82	29.88
48	5240	27.87	29.78
52	5260	28.63	29.90
60	5300	27.89	31.34
64	5320	26.06	29.98
100	5500	24.50	25.13
116	5580	29.27	32.95
140	5700	24.57	22.60

802.11n (HT40)

Channel	Frequency (MHz)	26 dBc Bandwidth (MHz)	
		Chain 0	Chain 1
38	5190	42.52	41.74
46	5230	72.48	73.24
54	5270	70.12	73.32
62	5310	41.55	41.81
102	5510	43.81	41.56
110	5550	49.21	57.19
134	5670	43.04	41.77

802.11ac (VHT80)

Channel	Frequency (MHz)	26 dBc Bandwidth (MHz)	
		Chain 0	Chain 1
42	5210	83.67	82.83
58	5290	83.58	83.11
106	5530	83.94	83.52
122	5610	135.24	159.17

Spectrum Plot of Worst Value

802.11a

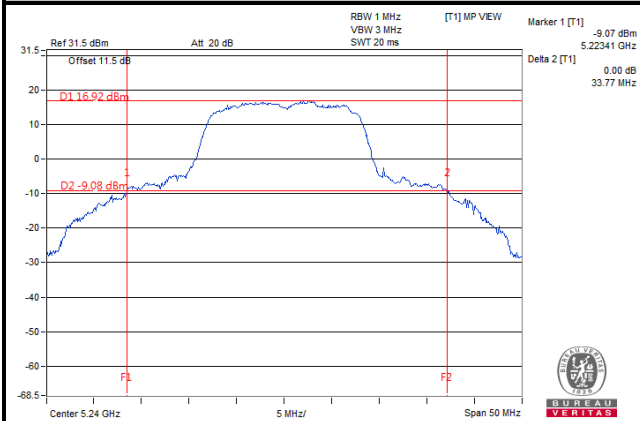

802.11n (HT20)

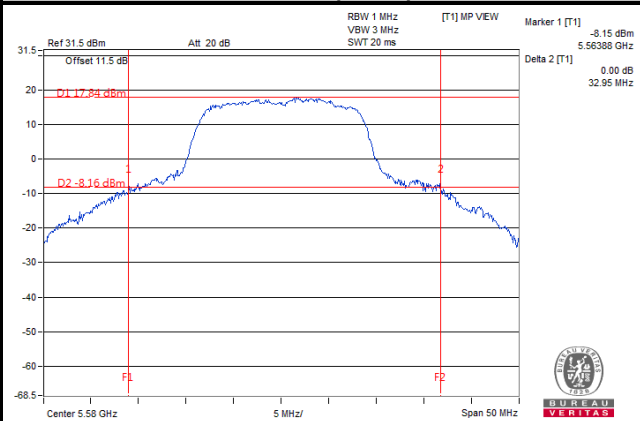

802.11n (HT40)

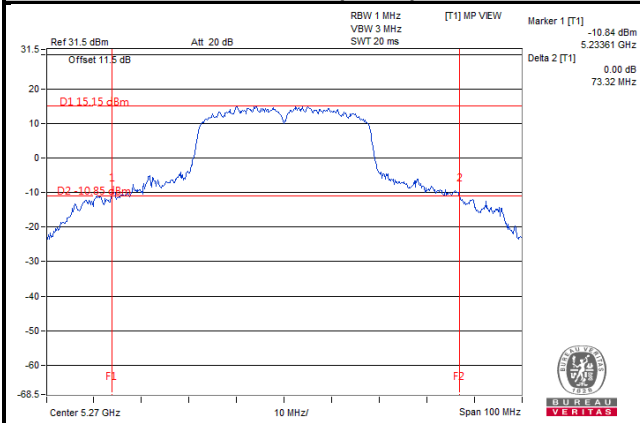

802.11ac (VHT80)

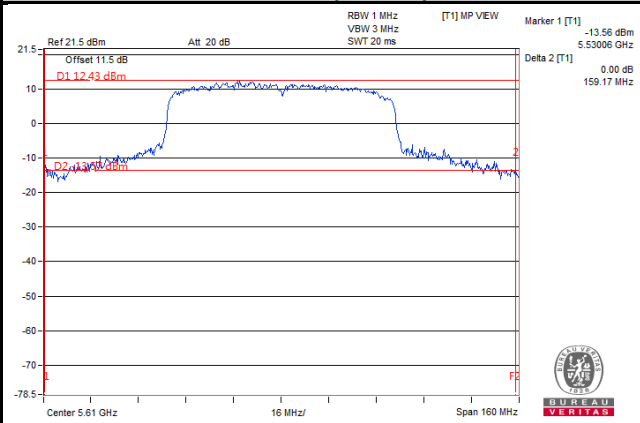

4.4 Occupied Bandwidth Measurement

4.4.1 Test Setup



4.4.2 Test Instruments

Refer to section 4.1.2 to get information of above instrument.

4.4.3 Test Procedure

The transmitter output was connected to the spectrum analyzer through an attenuator. The bandwidth of the fundamental frequency was measured by spectrum analyzer with resolution bandwidth in the range of 1 % to 5 % of the anticipated emission bandwidth, and a video bandwidth at least 3x the resolution bandwidth and set the detector to SAMPLE. The width of a frequency band such that, below the lower and above the upper frequency limits, the mean powers emitted are each equal to a specified percentage 0.5 % of the total mean power of a given emission.

4.4.4 Test Results

802.11a

Channel	Channel Frequency (MHz)	Occupied Bandwidth (MHz)	
		Chain 0	Chain 1
36	5180	16.54	16.59
40	5200	16.64	16.49
48	5240	16.59	16.69
52	5260	16.59	16.69
60	5300	16.64	16.54
64	5320	16.59	16.74
100	5500	16.44	16.39
116	5580	16.73	16.54
140	5700	16.59	16.49
149	5745	20.38	19.56
157	5785	22.20	21.15
165	5825	23.40	22.95

802.11n (HT20)

Channel	Channel Frequency (MHz)	Occupied Bandwidth (MHz)	
		Chain 0	Chain 1
36	5180	17.65	17.65
40	5200	17.70	17.70
48	5240	17.70	17.70
52	5260	17.65	17.70
60	5300	17.60	17.74
64	5320	17.65	17.74
100	5500	17.55	17.60
116	5580	17.74	17.65
140	5700	17.60	17.55
149	5745	18.99	18.75
157	5785	21.45	20.75

802.11n (HT40)

Channel	Channel Frequency (MHz)	Occupied Bandwidth (MHz)	
		Chain 0	Chain 1
38	5190	36.03	36.03
46	5230	37.18	37.82
54	5270	37.05	37.82
62	5310	36.16	36.03
102	5510	36.16	36.03
110	5550	36.42	36.54
134	5670	36.03	36.03
151	5755	40.38	42.78
159	5795	61.86	55.50

802.11ac (VHT80)

Channel	Channel Frequency (MHz)	Occupied Bandwidth (MHz)	
		Chain 0	Chain 1
42	5210	75.00	75.16
58	5290	75.48	75.00
106	5530	75.00	75.32
122	5610	75.64	75.80
155	5775	76.12	76.12

Spectrum Plot of Worst Value

802.11a

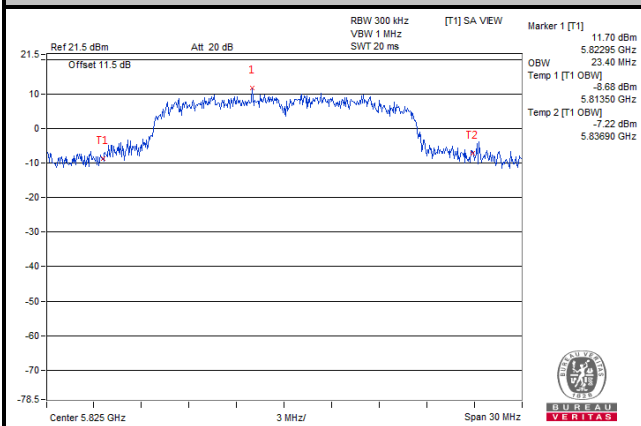

802.11n (HT20)

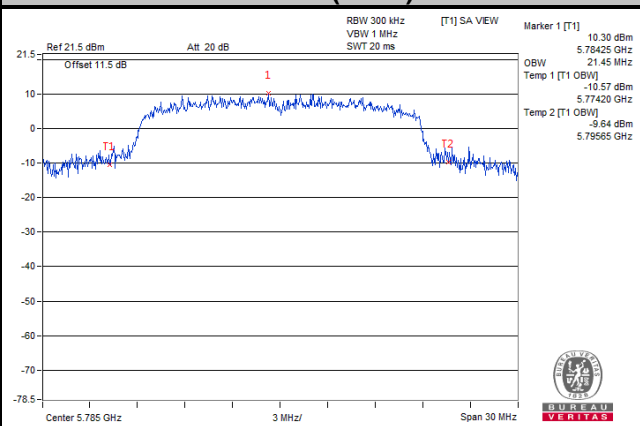

802.11n (HT40)

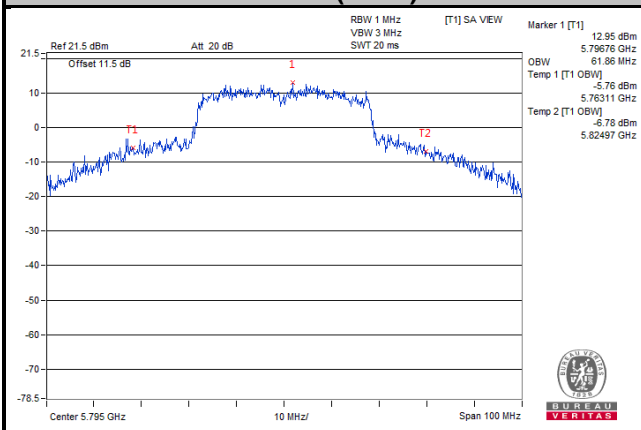

802.11ac (VHT80)

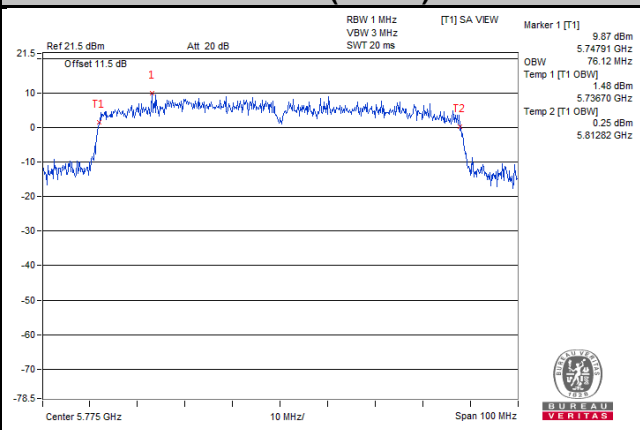

4.5 Peak Power Spectral Density Measurement

4.5.1 Limits of Peak Power Spectral Density Measurement

Operation Band	EUT Category		Limit
U-NII-1		Outdoor Access Point	17 dBm/MHz
		Fixed point-to-point Access Point	
		Indoor Access Point	
	√	Mobile and Portable client device	11 dBm/MHz
U-NII-2A		√	11 dBm/MHz
U-NII-2C		√	11 dBm/MHz
U-NII-3		√	30 dBm/500 kHz

4.5.2 Test Setup

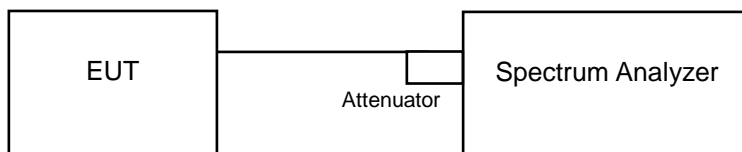

4.5.3 Test Instruments

Refer to section 4.1.3 to get information of above instrument.

4.5.4 Test Procedures

For U-NII-1, U-NII-2A, U-NII-2C band:

Using method SA-2

1. Set span to encompass the entire emission bandwidth (EBW) of the signal.
2. Set RBW = 1 MHz, Set VBW \geq 3 RBW, Detector = RMS
3. Sweep time = auto, trigger set to "free run".
4. Trace average at least 100 traces in power averaging mode.
5. Record the max value and add $10 \log(1/\text{duty cycle})$

※For U-NII-3:

1. Set span to encompass the entire emission bandwidth (EBW) of the signal.
2. Set RBW = 500 kHz, Set VBW \geq 3 RBW, Detector = RMS
3. Use the peak marker function to determine the maximum power level in any 500 kHz band segment within the fundamental EBW.
4. Sweep time = auto, trigger set to "free run".
5. Trace average at least 100 traces in power averaging mode.
6. Record the max value and add 10 log (1/duty cycle)

4.5.5 Deviation from Test Standard

No deviation.

4.5.6 EUT Operating Conditions

The software provided by client to enable the EUT under transmission condition continuously at lowest, middle and highest channel frequencies individually.

4.5.7 Test Results

For U-NII-1, U-NII-2A, U-NII-2C Band

802.11a

Channel	Frequency (MHz)	PSD (dBm/MHz)		Duty Factor (dB)	Total PSD with Duty Factor (dBm/MHz)	Max. Limit (dBm/MHz)	Pass / Fail
		Chain 0	Chain 1				
36	5180	5.74	5.38	0.35	8.92	9.44	Pass
44	5220	5.69	5.35	0.35	8.88	9.44	Pass
48	5240	5.63	5.68	0.35	9.01	9.44	Pass
52	5260	5.99	5.37	0.35	9.05	9.44	Pass
60	5300	6.04	5.66	0.35	9.21	9.44	Pass
64	5320	6.11	5.30	0.35	9.08	9.44	Pass
100	5500	6.23	5.71	0.35	9.34	9.44	Pass
116	5580	6.26	5.76	0.35	9.38	9.44	Pass
140	5700	6.12	5.54	0.35	9.20	9.44	Pass

Note:

- Method 1 of power density measurement of KDB 662911 is using for calculating total power density. Total power density is summing entire spectra across corresponding frequency bins on the various outputs by computer.
- Directional gain = $4.6 \text{ dBi} + 10\log(2) = 7.56 \text{ dBi} > 6 \text{ dBi}$, so the power density limit shall be reduced to $17 - (7.56 - 6) = 9.44 \text{ dBm}$.
- Refer to section 3.3 for duty cycle spectrum plot.

802.11n (HT20)

Channel	Frequency (MHz)	PSD (dBm/MHz)		Duty Factor (dB)	Total PSD with Duty Factor (dBm/MHz)	Max. Limit (dBm/MHz)	Pass / Fail
		Chain 0	Chain 1				
36	5180	5.22	5.89	0.63	9.21	9.44	Pass
44	5220	5.50	5.83	0.63	9.31	9.44	Pass
48	5240	5.35	5.69	0.63	9.16	9.44	Pass
52	5260	5.55	5.62	0.63	9.23	9.44	Pass
60	5300	5.53	5.49	0.63	9.15	9.44	Pass
64	5320	5.51	5.26	0.63	9.03	9.44	Pass
100	5500	5.53	5.25	0.63	9.03	9.44	Pass
116	5580	5.16	5.78	0.63	9.12	9.44	Pass
140	5700	5.26	5.65	0.63	9.10	9.44	Pass

Note:

- Method 1 of power density measurement of KDB 662911 is using for calculating total power density. Total power density is summing entire spectra across corresponding frequency bins on the various outputs by computer.
- Directional gain = $4.6 \text{ dBi} + 10\log(2) = 7.56 \text{ dBi} > 6 \text{ dBi}$, so the power density limit shall be reduced to $17 - (7.56 - 6) = 9.44 \text{ dBm}$.
- Refer to section 3.3 for duty cycle spectrum plot.

802.11n (HT40)

Channel	Frequency (MHz)	PSD (dBm/MHz)		Duty Factor (dB)	Total PSD with Duty Factor (dBm/MHz)	Max. Limit (dBm/MHz)	Pass / Fail
		Chain 0	Chain 1				
38	5190	-0.91	-0.95	1.19	3.27	9.44	Pass
46	5230	4.24	4.29	1.19	8.46	9.44	Pass
54	5270	4.36	4.48	1.19	8.62	9.44	Pass
62	5310	0.25	0.33	1.19	4.49	9.44	Pass
102	5510	0.02	0.29	1.19	4.35	9.44	Pass
110	5550	3.44	4.02	1.19	7.94	9.44	Pass
134	5670	-1.16	-0.61	1.19	3.32	9.44	Pass

Note:

1. Method 1 of power density measurement of KDB 662911 is using for calculating total power density. Total power density is summing entire spectra across corresponding frequency bins on the various outputs by computer.
2. Directional gain = 4.6 dBi + 10log(2) = 7.56 dBi > 6 dBi , so the power density limit shall be reduced to 17-(7.56-6) = 9.44 dBm.
3. Refer to section 3.3 for duty cycle spectrum plot.

802.11ac (VHT80)

Channel	Frequency (MHz)	PSD (dBm/MHz)		Duty Factor (dB)	Total PSD with Duty Factor (dBm/MHz)	Max. Limit (dBm/MHz)	Pass / Fail
		Chain 0	Chain 1				
42	5210	-6.55	-6.42	0.91	-2.56	9.44	Pass
58	5290	-4.40	-3.99	0.91	-0.27	9.44	Pass
106	5530	-5.46	-4.79	0.91	-1.19	9.44	Pass
122	5610	0.78	1.49	0.91	5.07	9.44	Pass

Note:

1. Method 1 of power density measurement of KDB 662911 is using for calculating total power density. Total power density is summing entire spectra across corresponding frequency bins on the various outputs by computer.
2. Directional gain = 4.6 dBi + 10log(2) = 7.56 dBi > 6 dBi , so the power density limit shall be reduced to 17-(7.56-6) = 9.44 dBm.
3. Refer to section 3.3 for duty cycle spectrum plot.

Spectrum Plot of Worst Value

802.11a

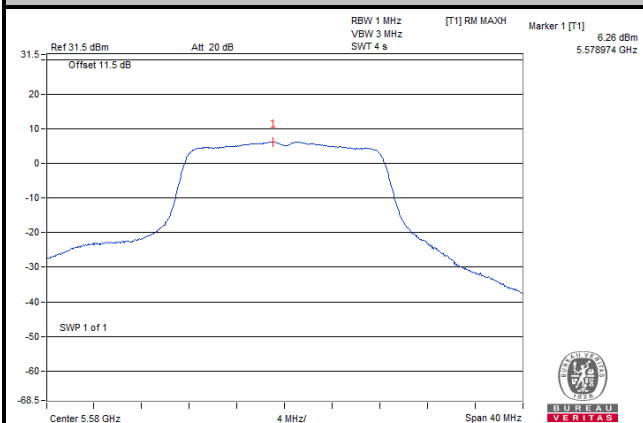

802.11n (HT20)

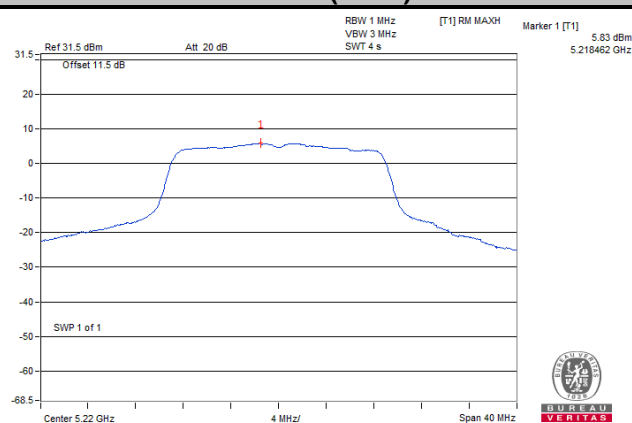

802.11n (HT40)

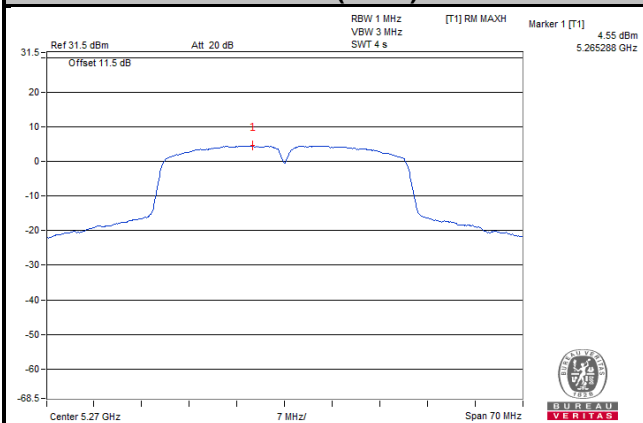

802.11ac (VHT80)

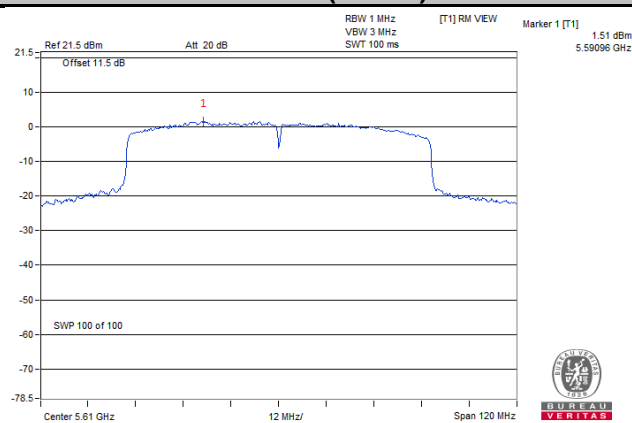

For U-NII-3 Band

802.11a

TX Chain	Channel	Frequency (MHz)	PSD (dBm/500 kHz)	10 log (N=2) dB	Duty Factor (dB)	Total PSD with Duty Factor (dBm/500 kHz)	Limit (dBm/500 kHz)	Pass / Fail
0	149	5745	4.75	3.01	0.35	8.11	28.44	Pass
	157	5785	4.70	3.01	0.35	8.06	28.44	Pass
	165	5825	4.52	3.01	0.35	7.88	28.44	Pass
1	149	5745	5.13	3.01	0.35	8.49	28.44	Pass
	157	5785	5.14	3.01	0.35	8.5	28.44	Pass
	165	5825	5.06	3.01	0.35	8.42	28.44	Pass

Note:

- Method 1 of power density measurement of KDB 662911 is using for calculating total power density. Total power density is summing entire spectra across corresponding frequency bins on the various outputs by computer.
- Directional gain = $4.6 \text{ dBi} + 10\log(2) = 7.56 \text{ dBi} > 6 \text{ dBi}$, so the power density limit shall be reduced to $30 - (7.56 - 6) = 28.44 \text{ dBm}$.
- Refer to section 3.3 for duty cycle spectrum plot.

802.11n (HT20)

TX Chain	Channel	Frequency (MHz)	PSD (dBm/500 kHz)	10 log (N=2) dB	Duty Factor (dB)	Total PSD with Duty Factor (dBm/500 kHz)	Limit (dBm/500 kHz)	Pass / Fail
0	149	5745	4.17	3.01	0.63	7.81	28.44	Pass
	157	5785	4.16	3.01	0.63	7.8	28.44	Pass
	165	5825	3.94	3.01	0.63	7.58	28.44	Pass
1	149	5745	4.77	3.01	0.63	8.41	28.44	Pass
	157	5785	4.64	3.01	0.63	8.28	28.44	Pass
	165	5825	4.61	3.01	0.63	8.25	28.44	Pass

Note:

- Method 1 of power density measurement of KDB 662911 is using for calculating total power density. Total power density is summing entire spectra across corresponding frequency bins on the various outputs by computer.
- Directional gain = $4.6 \text{ dBi} + 10\log(2) = 7.56 \text{ dBi} > 6 \text{ dBi}$, so the power density limit shall be reduced to $30 - (7.56 - 6) = 28.44 \text{ dBm}$.
- Refer to section 3.3 for duty cycle spectrum plot.

802.11n (HT40)

TX Chain	Channel	Frequency (MHz)	PSD (dBm/500 kHz)	10 log (N=2) dB	Duty Factor (dB)	Total PSD with Duty Factor (dBm/500 kHz)	Limit (dBm/500 kHz)	Pass / Fail
0	151	5755	0.70	3.01	1.19	4.9	28.44	Pass
	159	5795	1.29	3.01	1.19	5.49	28.44	Pass
1	151	5755	1.34	3.01	1.19	5.54	28.44	Pass
	159	5795	2.21	3.01	1.19	6.41	28.44	Pass

Note:

- Method 1 of power density measurement of KDB 662911 is using for calculating total power density. Total power density is summing entire spectra across corresponding frequency bins on the various outputs by computer.
- Directional gain = 4.6 dBi + 10log(2) = 7.56 dBi > 6 dBi , so the power density limit shall be reduced to 30-(7.56-6) = 28.44 dBm.
- Refer to section 3.3 for duty cycle spectrum plot.

802.11ac (VHT80)

TX Chain	Channel	Frequency (MHz)	PSD (dBm/500 kHz)	10 log (N=2) dB	Duty Factor (dB)	Total PSD with Duty Factor (dBm/500 kHz)	Limit (dBm/500 kHz)	Pass / Fail
0	155	5775	-3.03	3.01	0.91	0.89	28.44	Pass
1	155	5775	-3.27	3.01	0.91	0.65	28.44	Pass

Note:

- Method 1 of power density measurement of KDB 662911 is using for calculating total power density. Total power density is summing entire spectra across corresponding frequency bins on the various outputs by computer.
- Directional gain = 4.6 dBi + 10log(2) = 7.56 dBi > 6 dBi , so the power density limit shall be reduced to 30-(7.56-6) = 28.44 dBm.
- Refer to section 3.3 for duty cycle spectrum plot.

Spectrum Plot of Worst Value

802.11a

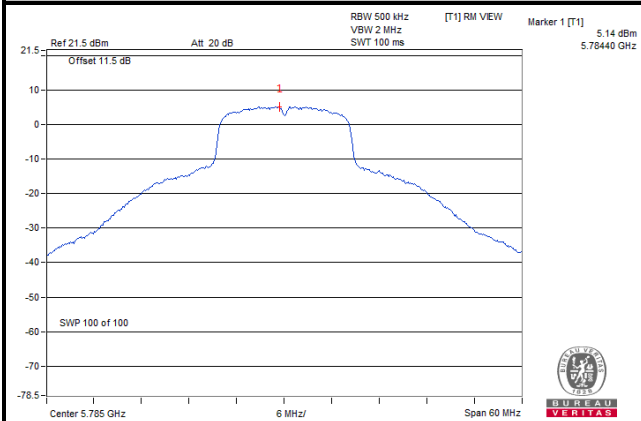

802.11n (HT20)

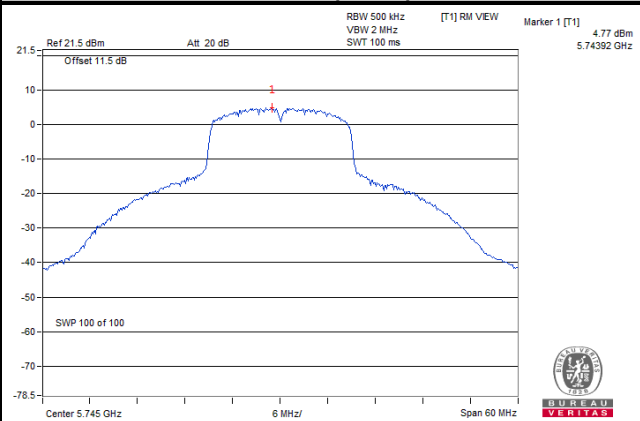

802.11n (HT40)

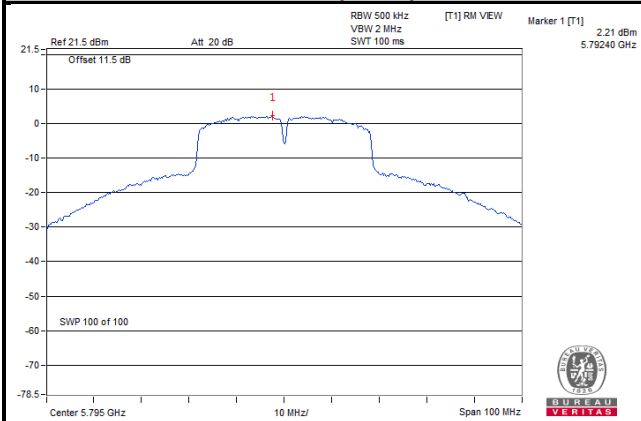

802.11ac (VHT80)

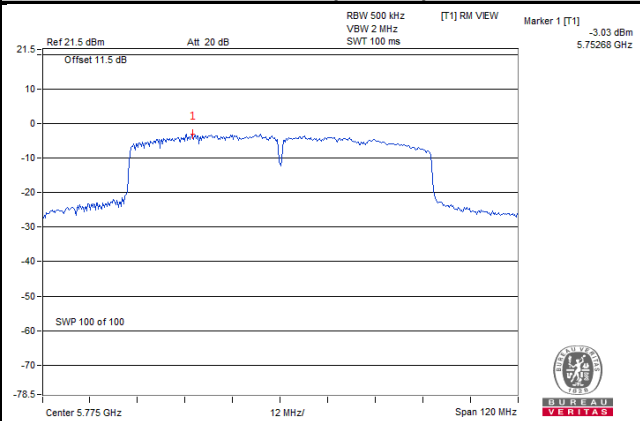

4.6 Frequency Stability

4.6.1 Limit of Frequency Stability Measurement

The frequency of the carrier signal shall be maintained within band of operation.

4.6.2 Test Setup

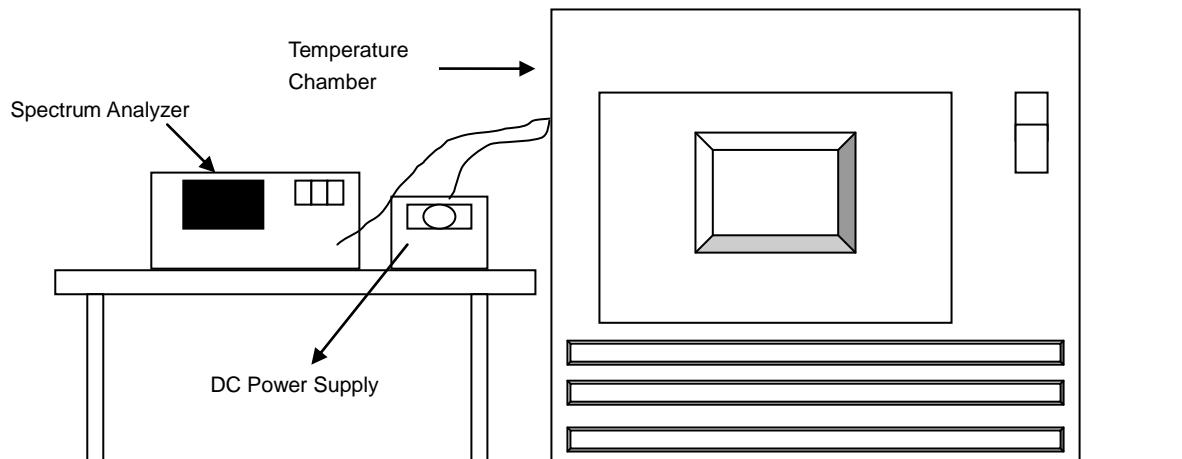

4.6.3 Test Instruments

Refer to section 4.1.3 to get information of above instrument.

4.6.4 Test Procedure

- To ensure emission at the band edge is maintained within the authorized band, those values shall be measured by radiation emissions at upper and lower frequency points, and finally compensated by frequency deviation as procedures below.
- The EUT was operated at the maximum output power, and connected to the spectrum analyzer, which is set to maximum hold function and peak detector. The peak value of the power envelope was measured and noted. The upper and lower frequency points were respectively measured relatively 10 dB lower than the measured peak value.
- The frequency deviation was calculated by adding the upper frequency point and the lower frequency point divided by two. Those detailed values of frequency deviation are provided in table below.

4.6.5 Deviation from Test Standard

No deviation.

4.6.6 EUT Operating Condition

Set the EUT transmit at un-modulation mode to test frequency stability.

4.6.7 Test Results

Frequency Stability Versus Temp.									
Operating Frequency: 5180 MHz									
Temp. (°C)	Power Supply (Vac)	0 Minute		2 Minute		5 Minute		10 Minute	
		Measured Frequency (MHz)	Frequency Drift (ppm)	Measured Frequency (MHz)	Frequency Drift (ppm)	Measured Frequency (MHz)	Frequency Drift (ppm)	Measured Frequency (MHz)	Frequency Drift (ppm)
50	120	5180.0239	4.61000	5180.0233	4.50000	5180.0253	4.88000	5180.0275	5.31000
40	120	5180.0153	2.95000	5180.0142	2.74000	5180.016	3.09000	5180.0145	2.80000
30	120	5179.9953	-0.91000	5179.9948	-1.00000	5179.9961	-0.75000	5179.9938	-1.20000
20	120	5179.9746	-4.90000	5179.974	-5.02000	5179.9727	-5.27000	5179.9727	-5.27000
10	120	5179.979	-4.05000	5179.9749	-4.85000	5179.9746	-4.90000	5179.9752	-4.79000
0	120	5179.976	-4.63000	5179.9785	-4.15000	5179.9769	-4.46000	5179.9794	-3.98000
-10	120	5179.9772	-4.40000	5179.9758	-4.67000	5179.9767	-4.50000	5179.9744	-4.94000
-20	120	5180.0052	1.00000	5180.005	0.97000	5180.0059	1.14000	5180.0048	0.93000
-30	120	5179.9828	-3.32000	5179.9815	-3.57000	5179.9781	-4.23000	5179.9781	-4.23000

Frequency Stability Versus Temp.									
Operating Frequency: 5180 MHz									
Temp. (°C)	Power Supply (Vdc)	0 Minute		2 Minute		5 Minute		10 Minute	
		Measured Frequency (MHz)	Frequency Drift (ppm)	Measured Frequency (MHz)	Frequency Drift (ppm)	Measured Frequency (MHz)	Frequency Drift (ppm)	Measured Frequency (MHz)	Frequency Drift (ppm)
20	138	5179.9755	-4.73000	5179.975	-4.83000	5179.9735	-5.12000	5179.9718	-5.44000
	120	5179.9746	-4.90000	5179.974	-5.02000	5179.9727	-5.27000	5179.9727	-5.27000
	102	5179.9753	-4.77000	5179.974	-5.02000	5179.9723	-5.35000	5179.9725	-5.31000

4.7 6 dB Bandwidth Measurement

4.7.1 Limits of 6 dB Bandwidth Measurement

The minimum of 6 dB Bandwidth Measurement is 0.5 MHz.

4.7.2 Test Setup

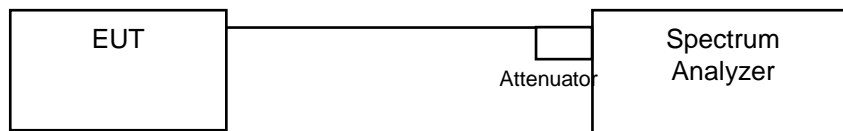

4.7.3 Test Instruments

Refer to section 4.1.3 to get information of above instrument.

4.7.4 Test Procedure

MEASUREMENT PROCEDURE REF

- Set resolution bandwidth (RBW) = 100 kHz
- Set the video bandwidth (VBW) $\geq 3 \times$ RBW, Detector = Peak.
- Trace mode = max hold.
- Sweep = auto couple.
- Measure the maximum width of the emission that is constrained by the frequencies associated with the two amplitude points (upper and lower) that are attenuated by 6 dB relative to the maximum level measured in the fundamental emission

4.7.5 Deviation from Test Standard

No deviation.

4.7.6 EUT Operating Condition

The software provided by client to enable the EUT under transmission condition continuously at lowest, middle and highest channel frequencies individually.

4.7.7 Test Results

802.11a

Channel	Frequency (MHz)	6 dB Bandwidth (MHz)		Minimum Limit (MHz)	Pass / Fail
		Chain 0	Chain 1		
149	5745	15.16	15.15	0.5	Pass
157	5785	15.18	15.12	0.5	Pass
165	5825	15.14	15.14	0.5	Pass

802.11n (HT20)

Channel	Frequency (MHz)	6 dB Bandwidth (MHz)		Minimum Limit (MHz)	Pass / Fail
		Chain 0	Chain 1		
149	5745	15.37	15.74	0.5	Pass
157	5785	15.51	15.75	0.5	Pass
165	5825	15.93	16.33	0.5	Pass

802.11n (HT40)

Channel	Frequency (MHz)	6 dB Bandwidth (MHz)		Minimum Limit (MHz)	Pass / Fail
		Chain 0	Chain 1		
151	5755	35.13	35.12	0.5	Pass
159	5795	32.69	33.88	0.5	Pass

802.11ac (VHT80)

Channel	Frequency (MHz)	6 dB Bandwidth (MHz)		Minimum Limit (MHz)	Pass / Fail
		Chain 0	Chain 1		
155	5775	72.86	72.70	0.5	Pass

5 Pictures of Test Arrangements

Please refer to the attached file (Test Setup Photo).

Annex A- Radiated Out of Band Emisison (OOBE) Measurement (For U-NII-3 band)

802.11a

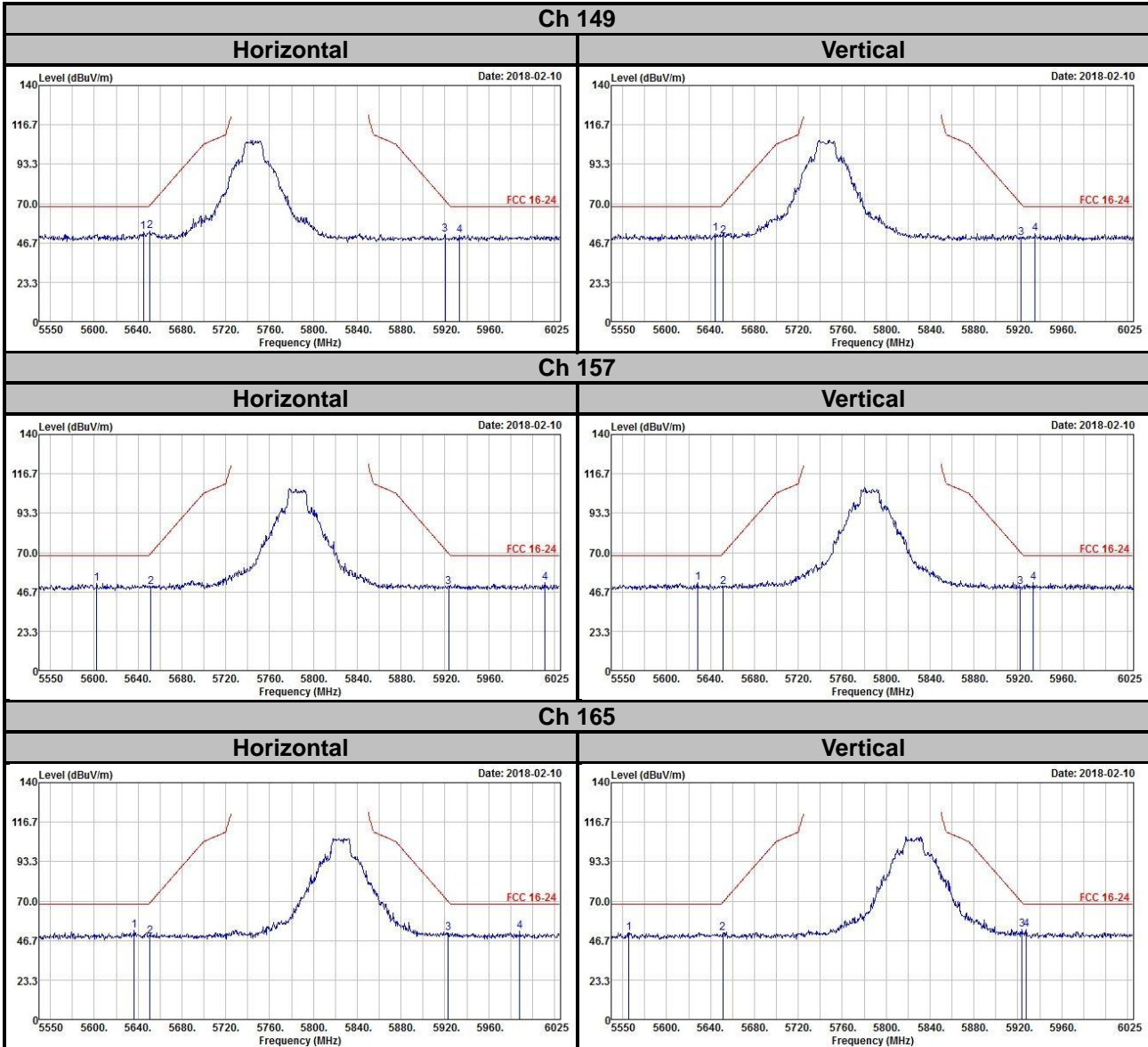

802.11n (HT20)

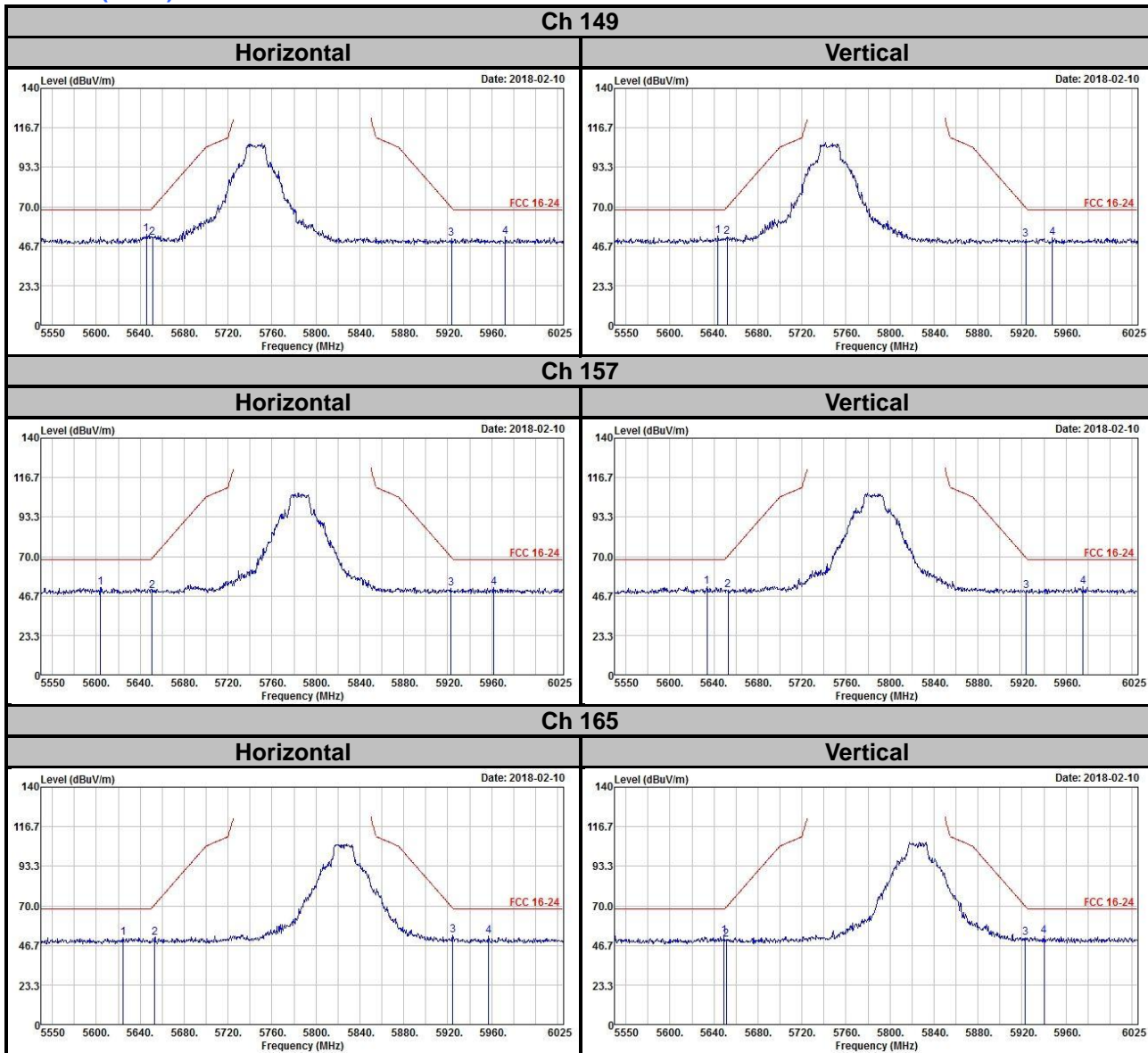

802.11n (HT40)

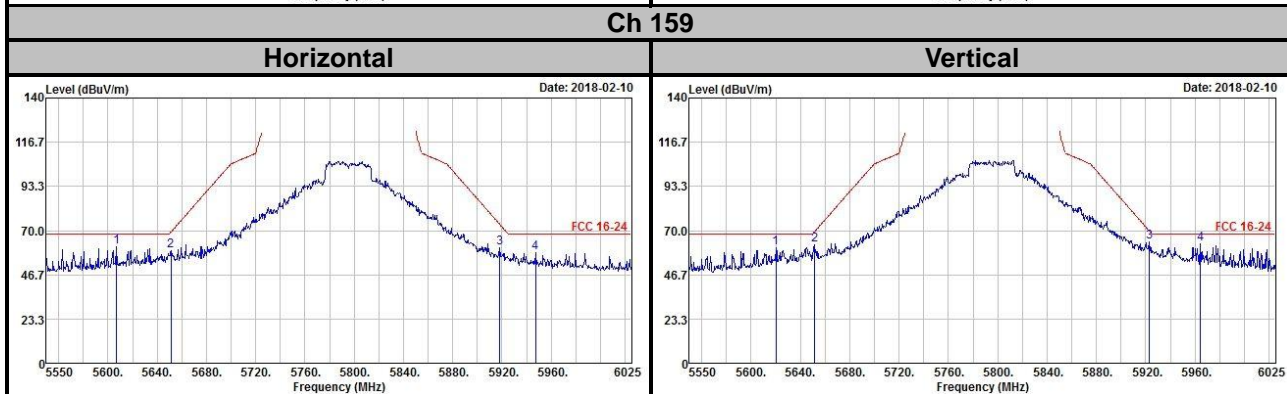
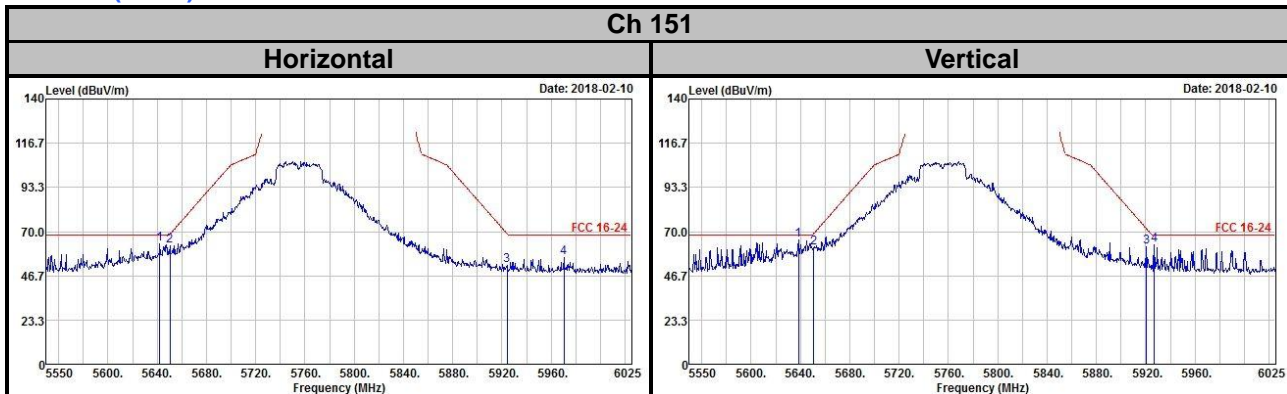

802.11ac (VHT80)

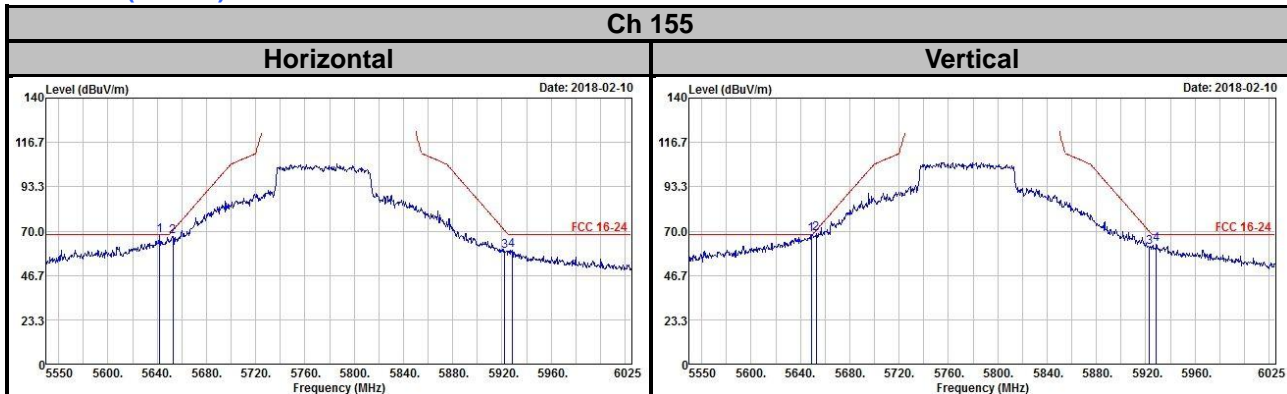

Appendix – Information on the Testing Laboratories

We, Bureau Veritas Consumer Products Services (H.K.) Ltd., Taoyuan Branch, were founded in 1988 to provide our best service in EMC, Radio, Telecom and Safety consultation. Our laboratories are FCC recognized accredited test firms and accredited according to ISO/IEC 17025.

If you have any comments, please feel free to contact us at the following:

Linko EMC/RF Lab

Tel: 886-2-26052180

Fax: 886-2-26051924

Hsin Chu EMC/RF/Telecom Lab

Tel: 886-3-6668565

Fax: 886-3-6668323

Hwa Ya EMC/RF/Safety

Tel: 886-3-3183232

Fax: 886-3-3270892

Email: service.adt@tw.bureauveritas.com

Web Site: www.bureauveritas-adt.com

The address and road map of all our labs can be found in our web site also.

--- END ---