



FCC 47 CFR PART 15 SUBPART E

TEST REPORT

For

Notebook Computer

Model:

Satellite S5***-C*******

Satellite E5***-C*******

Satellite L5***-C*******

Satellite P5***-C*******

Satellite Radius L5***-C*******

Satellite Radius P5***-C*******

Satellite Fusion L5***-C*******

(* means 0-9; a-z; A-Z; / ; - ; no symbol, or blank for marketing purpose)

Trade Name: TOSHIBA

Issued to

Pegatron Corporation

5F, NO. 76, LIGONG ST., BEITOU DISTRICT, TAIPEI CITY 112, TAIWAN (R.O.C.)

Issued by

Compliance Certification Services Inc.

No.11, Wugong 6th Rd., Wugu Dist.,

New Taipei City 24891, Taiwan. (R.O.C.)

<http://www.ccsrf.com>

service@ccsrf.com

Issued Date: February 25, 2015



Testing Laboratory
1309

Note: This report shall not be reproduced except in full, without the written approval of Compliance Certification Services Inc. This document may be altered or revised by Compliance Certification Services Inc. personnel only, and shall be noted in the revision section of the document.



Revision History

Rev.	Issue Date	Revisions	Effect Page	Revised By
00	February 25, 2015	Initial Issue	ALL	Doris Chu



TABLE OF CONTENTS

1. TEST RESULT CERTIFICATION.....	4
2. EUT DESCRIPTION	5
3. TEST METHODOLOGY	7
3.1 EUT CONFIGURATION	7
3.2 EUT EXERCISE	7
3.3 GENERAL TEST PROCEDURES.....	7
3.4 FCC PART 15.205 RESTRICTED BANDS OF OPERATIONS.....	8
3.5 DESCRIPTION OF TEST MODES.....	9
4. INSTRUMENT CALIBRATION.....	11
4.1 MEASURING INSTRUMENT CALIBRATION	11
4.2 MEASUREMENT EQUIPMENT USED.....	11
4.3 MEASUREMENT UNCERTAINTY.....	12
5. FACILITIES AND ACCREDITATIONS	13
5.1 FACILITIES	13
5.2 EQUIPMENT	13
5.3 LABORATORY ACCREDITATIONS AND LISTING.....	13
5.4 TABLE OF ACCREDITATIONS AND LISTINGS	14
6. SETUP OF EQUIPMENT UNDER TEST.....	15
6.1 SETUP CONFIGURATION OF EUT	15
6.2 SUPPORT EQUIPMENT	15
7. FCC PART 15 REQUIREMENTS.....	16
7.1 26 DB EMISSION BANDWIDTH	16
7.2 MAXIMUM CONDUCTED OUTPUT POWER	40
7.3 BAND EDGES MEASUREMENT	44
7.4 PEAK POWER SPECTRAL DENSITY	75
7.5 RADIATED UNDESIRABLE EMISSION.....	99
7.6 POWERLINE CONDUCTED EMISSIONS	133
7.7 FREQUENCY STABILITY	136
APPENDIX I PHOTOGRAPHS OF TEST SETUP	159
APPENDIX 1 - PHOTOGRAPHS OF EUT	



1. TEST RESULT CERTIFICATION

Applicant: Pegatron Corporation
5F, NO. 76, LIGONG ST., BEITOU DISTRICT, TAIPEI CITY 112,
TAIWAN (R.O.C.)

Equipment Under Test: Notebook Computer

Trade Name: TOSHIBA

Model: Satellite S5*****-C*****
Satellite E5*****-C*****
Satellite L5*****-C*****
Satellite P5*****-C*****
Satellite Radius L5*****-C*****
Satellite Radius P5*****-C*****
Satellite Fusion L5*****-C*****
(* means 0-9; a-z; A-Z; / ; - ; no symbol, or blank for marketing purpose)

Date of Test: February 6 ~ 11, 2015

APPLICABLE STANDARDS	
STANDARD	TEST RESULT
FCC 47 CFR Part 15 Subpart E	No non-compliance noted

We hereby certify that:

Compliance Certification Services Inc. tested the above equipment. The test data, data evaluation, test procedures, and equipment configurations shown in this report were made in accordance with the procedures given in ANSI C63.4: 2009 and the energy emitted by the sample EUT tested as described in this report is in compliance with conducted and radiated emission limits of FCC Rules Part 15.407.

The test results of this report relate only to the tested sample identified in this report.

Approved by:

Reviewed by:

Miller Lee
Section Manager
Compliance Certification Services Inc.

Angel Cheng
Section Manager
Compliance Certification Services Inc.



2. EUT DESCRIPTION

Product	Notebook Computer				
Trade Name	TOSHIBA				
Model Number	Satellite S5*****_C***** Satellite E5*****_C***** Satellite L5*****_C***** Satellite P5*****_C***** Satellite Radius L5*****_C***** Satellite Radius P5*****_C***** Satellite Fusion L5*****_C***** (* means 0-9; a-z; A-Z; / ; - ; no symbol, or blank for marketing purpose)				
Model Discrepancy	All the above models are identical except for the designation of model numbers. The suffix of “*” (* means 0-9; a-z; A-Z; / ; - ; no symbol, or blank for marketing purpose) on model number is just for marketing purpose only.				
Received Date	January 23, 2015				
WLAN Manufacturer	Intel	Model	3160NGW		
Power Supply	1. VDC from Power Adapter TOSHIBA / Model: PA5178U-1ACA I/P: 100-240V, 50-60Hz, 1.7A O/P: 19V, 3.42A 2. Power from Battery TOSHIBA / PA5208U-1BRS Rating 10.8Vdc, 45Wh, 3860mAh				
Operating Frequency Range & Number of Channels	UNII Band I	Mode	Frequency Range (MHz)	Number of Channels	
		IEEE 802.11a	5180 – 5240	4 Channels	
		IEEE 802.11n HT 20 MHz	5180 – 5240	4 Channels	
		IEEE 802.11n HT 40 MHz	5190 ~ 5230	2 Channels	
	UNII Band II	IEEE 802.11ac VHT 80 MHz	5210	1 Channels	
		IEEE 802.11a	5260 - 5320	4 Channels	
		IEEE 802.11n HT 20 MHz	5260 - 5320	4 Channels	
		IEEE 802.11n HT 40 MHz	5270 ~ 5310	2 Channels	
	UNII Band III	IEEE 802.11ac VHT 80 MHz	5290	1 Channels	
		IEEE 802.11a	5500 ~ 5700	11 Channels	
		IEEE 802.11n HT 20 MHz	5500 ~ 5700	11 Channels	
		IEEE 802.11n HT 40 MHz	5510 ~ 5670	5 Channels	
Transmit Power	UNII Band I	Mode	Frequency Range (MHz)	Output Power (dBm)	Output Power (w)
		IEEE 802.11a	5180 – 5240	13.43	0.02203
		IEEE 802.11n HT 20 MHz	5180 – 5240	13.41	0.02193
		IEEE 802.11n HT 40 MHz	5190 ~ 5230	13.41	0.02193
	UNII Band II	IEEE 802.11ac VHT 80 MHz	5210	10.69	0.01172
		IEEE 802.11a	5260 - 5320	13.41	0.02193
		IEEE 802.11n HT 20 MHz	5260 - 5320	13.41	0.02193
		IEEE 802.11n HT 40 MHz	5270 ~ 5310	13.41	0.02193
	UNII Band III	IEEE 802.11ac VHT 80 MHz	5290	12.57	0.01807
		IEEE 802.11a	5500 ~ 5700	13.39	0.02183
		IEEE 802.11n HT 20 MHz	5500 ~ 5700	13.41	0.02193
		IEEE 802.11n HT 40 MHz	5510 ~ 5670	13.41	0.02193
IEEE 802.11ac VHT 80 MHz	5530 ~ 5690	11.77	0.01503		
Modulation Technique	OFDM (QPSK, BPSK, 16-QAM, 64-QAM)				



Transmit Data Rate	IEEE 802.11a mode: 54, 48, 36, 24, 18, 12, 9, 6 Mbps IEEE 802.11n HT 20 mode: OFDM (6.5, 7.2, 13, 14.4, 14.44, 19.5, 21.7, 26, 28.89, 28.9, 39, 43.3, 43.33 52, 57.78, 57.8, 58.5, 65.0, 72.2, 78, 86.67, 104, 115.56, 117, 130, 144.44 Mbps) IEEE 802.11n HT 40 mode: OFDM (13.5, 15, 27, 30, 40.5, 45, 54, 60, 81, 90, 108, 120, 121.5, 135, 150, 162, 180, 216, 240, 243, 270, 300 Mbps) IEEE 802.11n HT 80 mode: OFDM (29.3, 58.5, 87.8, 117, 175.5, 234, 263.3, 292.5, 351, 390, 468, 526.5, 585, 702, 780 Mbps)
Antenna Specification	1. Yageo(Metal) ANTA0TP09551WLAN4 (TX1) / 2.14dBi (Worse) 2. Yageo(IMR) ANTA0TP09551WLAN2 (TX1) / -2.48dBi 3. ACON(Metal) APP6Y-700301 (TX1) / -3.98dBi 4. ACON(IMR) APP6Y-700249 (TX1) /-0.67dBi
Antenna Designation	PIFA Antenna

Remark:

1. The sample selected for test was production product and was provided by manufacturer.
2. This submittal(s) (test report) is intended for FCC ID: **VUI-THOR3160** filing to comply with Section 15.207, 15.209 and 15.247 of the FCC Part 15, Subpart C Rules.



3. TEST METHODOLOGY

Both conducted and radiated testing was performed according to the procedures in ANSI C63.4: 2009 Radiated testing was performed at an antenna to EUT distance 3 meters.

The tests documented in this report were performed in accordance with ANSI C63.4: 2009 and FCC CFR 47 Part 15.207, 15.209 and 15.407.

3.1 EUT CONFIGURATION

The EUT configuration for testing is installed for RF field strength measurement to meet the Commissions requirement, and is operated in a manner intended to generate the maximum emission in a continuous normal application.

3.2 EUT EXERCISE

The EUT is operated in the engineering mode to fix the Tx frequency for the purposes of measurement.

According to its specifications, the EUT must comply with the requirements of Section 15.407 under the FCC Rules Part 15 Subpart E.

3.3 GENERAL TEST PROCEDURES

Conducted Emissions

The EUT is placed on the turntable, which is positioned at 0.8 m above the ground plane. According to the requirements in Section 13.1.4.1 of ANSI C63.4, the conducted emission from the EUT is measured in the frequency range between 0.15 MHz and 30MHz, using the CISPR Quasi-Peak detector mode.

Radiated Emissions

The EUT is placed on the turntable, which is 0.8 m above the ground plane. The turntable is then rotated for 360 degrees to determine the proper orientation for the maximum emission level. The EUT is set 3m away from the receiving antenna, which is varied from 1m to 4m to find out the highest emission level. And, each emission is to be maximized by changing the horizontal and vertical polarization of the receiving antenna. In order to find out the maximum emissions, exploratory radiated emission measurements were made according to the requirements in Section 13.1.4.1 of ANSI C63.4: 2003.



3.4 FCC PART 15.205 RESTRICTED BANDS OF OPERATIONS

(a) Except as shown in paragraph (d) of this section, only spurious emissions are permitted in any of the frequency bands listed below:

MHz	MHz	MHz	GHz
0.090 - 0.110	16.42 - 16.423	399.9 - 410	4.5 - 5.15
¹ 0.495 - 0.505	16.69475 - 16.69525	608 - 614	5.35 - 5.46
2.1735 - 2.1905	16.80425 - 16.80475	960 - 1240	7.25 - 7.75
4.125 - 4.128	25.5 - 25.67	1300 - 1427	8.025 - 8.5
4.17725 - 4.17775	37.5 - 38.25	1435 - 1626.5	9.0 - 9.2
4.20725 - 4.20775	73 - 74.6	1645.5 - 1646.5	9.3 - 9.5
6.215 - 6.218	74.8 - 75.2	1660 - 1710	10.6 - 12.7
6.26775 - 6.26825	108 - 121.94	1718.8 - 1722.2	13.25 - 13.4
6.31175 - 6.31225	123 - 138	2200 - 2300	14.47 - 14.5
8.291 - 8.294	149.9 - 150.05	2310 - 2390	15.35 - 16.2
8.362 - 8.366	156.52475 -	2483.5 - 2500	17.7 - 21.4
8.37625 - 8.38675	156.52525	2655 - 2900	22.01 - 23.12
8.41425 - 8.41475	156.7 - 156.9	3260 - 3267	23.6 - 24.0
12.29 - 12.293	162.0125 - 167.17	3332 - 3339	31.2 - 31.8
12.51975 - 12.52025	167.72 - 173.2	3345.8 - 3358	36.43 - 36.5
12.57675 - 12.57725	240 - 285	3600 - 4400	(²)
13.36 - 13.41	322 - 335.4		

¹ Until February 1, 1999, this restricted band shall be 0.490-0.510 MHz.

² Above 38.6

(b) Except as provided in paragraphs (d) and (e), the field strength of emissions appearing within these frequency bands shall not exceed the limits shown in Section 15.209. At frequencies equal to or less than 1000 MHz, compliance with the limits in Section 15.209 shall be demonstrated using measurement instrumentation employing a CISPR quasi-peak detector. Above 1000 MHz, compliance with the emission limits in Section 15.209 shall be demonstrated based on the average value of the measured emissions. The provisions in Section 15.35 apply to these measurements.



3.5 DESCRIPTION OF TEST MODES

The EUT (model: Satellite S50-C) comes with four types of antenna (model: ANTA0TP09551WLAN4 (TX1) / ANTA0TP09551WLAN2 (TX1) / APP6Y-700301 (TX1) / APP6Y-700249 (TX1)) for sale. After the preliminary test, the antenna ANTA0TP09551WLAN4 (TX1) was found to emit the worst emissions and therefore had been tested under operating condition.

Software used to control the EUT for staying in continuous transmitting mode was programmed.

After verification, all tests were carried out with the worst case test modes as shown below except radiated spurious emission below 1GHz, which worst case was in normal link mode only.

UNII Band I:

IEEE 802.11a for 5180 ~ 5240MHz:

Channel Low (5180MHz), Channel Mid (5220MHz) and Channel High (5240MHz) with 6Mbps data rate were chosen for full testing.

IEEE 802.11n HT 20 MHz for 5180 ~ 5240MHz:

Channel Low (5180MHz), Channel Mid (5220MHz) and Channel High (5240MHz) with 6.5Mbps data rate were chosen for full testing.

IEEE 802.11n HT 40 MHz Channel for 5190 ~ 5230MHz:

Channel Low (5190MHz) and Channel High (5230MHz) with 13.5Mbps data rate were chosen for full testing.

IEEE 802.11ac VHT 80 MHz Channel for 5210MHz:

Channel Low(5210MHz) with 29.3Mbps data rate were chosen for full testing.

UNII Band II:

IEEE 802.11a for 5260 ~ 5320MHz:

Channel Low (5260MHz), Channel Mid (5280MHz) and Channel High (5320MHz) with 6Mbps data rate were chosen for full testing.

IEEE 802.11n HT 20 MHz for 5260 ~ 5320MHz:

Channel Low (5260MHz), Channel Mid (5280MHz) and Channel High (5320MHz) with 6.5Mbps data rate were chosen for full testing.

IEEE 802.11n HT 40 MHz for 5270 ~ 5310MHz:

Channel Low (5270MHz) and Channel High (5310MHz) with 13.5Mbps data rate were chosen for full testing.

IEEE 802.11ac VHT 80 MHz for 5290MHz:

Channel Low(5290MHz) with 29.3Mbps data rate were chosen for full testing.



UNII Band III:

IEEE 802.11a for 5500 ~ 5700MHz:

Channel Low (5500MHz), Channel Mid (5580MHz) and Channel High (5700MHz) with 6Mbps data rate were chosen for full testing.

IEEE 802.11n HT 20 MHz for 5500 ~ 5700MHz:

Channel Low (5500MHz), Channel Mid (5580MHz) and Channel High (5700MHz) with 6.5Mbps data rate were chosen for full testing.

IEEE 802.11n HT 40 MHz for 5510 ~ 5670MHz:

Channel Low (5510MHz), Channel Mid (5590MHz) and Channel High (5670MHz) with 13.5Mbps data rate were chosen for full testing.

IEEE 802.11ac VHT 80 MHz for 5530 ~ 5690MHz:

Channel Low (5530MHz) and Channel High (5690MHz) with 29.3Mbps data rate were chosen for full testing.

The field strength of spurious emission was measured in the following position: The EUT has Notebook mode, Flat mode, Tent mode, Stand mode, Tablet X, Y and Z axis modes. The worst emission was found in Notebook mode and the worst case was recorded.

Test items for conducted and radiated emission were performed for report. DFS please refer to module (Brand: Intel, Model: 3160NGW, FCC ID: PD93160NG, PD93160NGU)



4. INSTRUMENT CALIBRATION

4.1 MEASURING INSTRUMENT CALIBRATION

The measuring equipment, which was utilized in performing the tests documented herein, has been calibrated in accordance with the manufacturer's recommendations for utilizing calibration equipment, which is traceable to recognized national standards.

4.2 MEASUREMENT EQUIPMENT USED

Equipment Used for Emissions Measurement

Remark: Each piece of equipment is scheduled for calibration once a year and Loop Antenna is scheduled for calibration once three years.

Conducted Emissions Test Site				
Name of Equipment	Manufacturer	Model	Serial Number	Calibration Due
Spectrum Analyzer	Agilent	E4446A	US42510252	11/23/2015
Thermostatic/Hrgrosatic Chamber	TAICHY	MHG-150LF	930619	10/07/2015
AC Power Source	EXTECH	6205	1140845	N.C.R
DC Power Supply	ABM	8301HD	D011531	N.C.R
Power Meter	Anritsu	ML2495A	1012009	06/03/2015
Power Sensor	Anritsu	MA2411A	0917072	06/03/2015
Spectrum Analyzer	ROHDE&SCHWARZ	FSV40	101073	07/09/2015

Wugu 966 Chamber A				
Name of Equipment	Manufacturer	Model	Serial Number	Calibration Due
Spectrum Analyzer	Agilent	E4446A	US42510268	09/18/2015
EMI Test Receiver	R&S	ESCI	100064	05/30/2015
Bilog Antenna	Sunol Sciences	JB3	A030105	08/19/2015
Horn Antenna	EMCO	3117	00055165	01/26/2016
Horn Antenna	EMCO	3116	26370	12/25/2015
Turn Table	CCS	CC-T-1F	N/A	N.C.R
Antenna Tower	CCS	CC-A-1F	N/A	N.C.R
Controller	CCS	CC-C-1F	N/A	N.C.R
Pre-Amplifier	MITEQ	1652-3000	1490939	08/09/2016
Pre-Amplifier	EMC	EMC 01265	4035	08/09/2016
Pre-Amplifier	MITEQ	AMF-6F-260400-4 0-8P	985646	12/25/2015
Coaxial Cable	Huber+Suhner	102	29212/2	12/25/2015
Coaxial Cable	Huber+Suhner	102	29406/2	12/25/2015
Test S/W	EZ-EMC (CCS-3A1RE)			

Conducted Emission room # B				
Name of Equipment	Manufacturer	Model	Serial Number	Calibration Due
EMI Test Receiver	R&S	ESCI	101073	09/18/2015
LISN	R&S	ENV216	101054	05/18/2015
LISN	SCHWARZBECK	NSLK 8127	8127-541	11/25/2015
Capacitive Voltage Probe	FCC	F-CVP-1	100185	03/09/2015
Test S/W	CCS-3A1-CE			



4.3 MEASUREMENT UNCERTAINTY

PARAMETER	UNCERTAINTY
Powerline Conducted Emission	+/- 1.2575
3M Semi Anechoic Chamber / 30M~200M	+/- 4.0138
3M Semi Anechoic Chamber / 200M~1000M	+/- 3.9483
3M Semi Anechoic Chamber / 1G~8G	+/- 2.5975
3M Semi Anechoic Chamber / 8G~18G	+/- 2.6112
3M Semi Anechoic Chamber / 18G~26G	+/- 2.7389
3M Semi Anechoic Chamber / 26G~40G	+/- 2.9683

Remark: This uncertainty represents an expanded uncertainty expressed at approximately the 95% confidence level using a coverage factor of $k=2$.



5. FACILITIES AND ACCREDITATIONS

5.1 FACILITIES

All measurement facilities used to collect the measurement data are located at

No.139, Wugong Rd., Wugu Dist., New Taipei City 24891, Taiwan (R.O.C.)
Tel: 886-2-2298-4086 / Fax: 886-2-2298-1470

No.11, Wugong 6th Rd., Wugu Dist., New Taipei City 24891, Taiwan. (R.O.C.)
Tel: 886-2-2299-9720 / Fax: 886-2-2298-4045

No.81-1, Lane 210, Bade 2nd Rd., Luchu Hsiang, Taoyuan Hsien 338, Taiwan
Tel: 886-3-324-0332 / Fax: 886-3-324-5235

The sites are constructed in conformance with the requirements of ANSI C63.7, ANSI C63.4 and CISPR Publication 22.

5.2 EQUIPMENT

Radiated emissions are measured with one or more of the following types of linearly polarized antennas: tuned dipole, biconical, log periodic, bi-log, and/or ridged waveguide, horn. Spectrum analyzers with pre-selectors and quasi-peak detectors are used to perform radiated measurements.

Conducted emissions are measured with Line Impedance Stabilization Networks and EMI Test Receivers.

Calibrated wideband preamplifiers, coaxial cables, and coaxial attenuators are also used for making measurements.



All receiving equipment conforms to CISPR Publication 16-1, "Radio Interference Measuring Apparatus and Measurement Methods."

5.3 LABORATORY ACCREDITATIONS AND LISTING

The test facilities used to perform radiated and conducted emissions tests are accredited by American Association for Laboratory Accreditation Program for the specific scope accreditation under Lab Code: 0824-01 to perform Electromagnetic Interference tests according to FCC Part 15 and CISPR 22 requirements. In addition, the test facilities are listed with Industry Canada, Certification and Engineering Bureau, IC 2324G-1 for 3M Semi Anechoic Chamber A, 2324G-2 for 3M Semi Anechoic Chamber B.



5.4 TABLE OF ACCREDITATIONS AND LISTINGS

Country	Agency	Scope of Accreditation	Logo
USA	FCC	3M Semi Anechoic Chamber (FCC MRA: TW1039) to perform FCC Part 15 measurements	 FCC MRA: TW1039
Taiwan	TAF	LP0002, RTTE01, FCC Method-47 CFR Part 15 Subpart C, D, E, RSS-210, RSS-310 IDA TS SRD, AS/NZS 4268, AS/NZS 4771, TS 12.1 & 12.2, ETSI EN 300 440-1, ETSI EN 300 440-2, ETSI EN 300 328, ETSI EN 300 220-1, ETSI EN 300 220-2, ETSI EN 301 893, ETSI EN 301 489-1/3/7/17 FCC OET Bulletin 65 + Supplement C, EN 50360, EN 50361, EN 50371, RSS 102, EN 50383, EN 50385, EN 50392, IEC 62209, CNS 14958-1, CNS 14959 FCC Method -47 CFR Part 15 Subpart B IEC / EN 61000-3-2, IEC / EN 61000-3-3, IEC / EN 61000-4-2/3/4/5/6/8/11	
Canada	Industry Canada	3M Semi Anechoic Chamber (IC 2324G-1 / IC 2324G-2) to perform	 IC 2324G-1 IC 2324G-2

* No part of this report may be used to claim or imply product endorsement by A2LA or any agency of the US Government.



6. SETUP OF EQUIPMENT UNDER TEST

6.1 SETUP CONFIGURATION OF EUT

See test photographs attached in Appendix I for the actual connections between EUT and support equipment.

6.2 SUPPORT EQUIPMENT

No.	Device Type	Brand	Model	Series No.	FCC ID	Data Cable	Power Cord
	N/A						

Remark:

1. *All the equipment/cables were placed in the worst-case configuration to maximize the emission during the test.*
2. *Grounding was established in accordance with the manufacturer's requirements and conditions for the intended use.*



7. FCC PART 15 REQUIREMENTS

7.1 26 dB EMISSION BANDWIDTH

LIMIT

According to §15.303(c), for purposes of this subpart the emission bandwidth shall be determined by measuring the width of the signal between two points, one below the carrier center frequency and one above the carrier center frequency, that are 26 dB down relative to the maximum level of the modulated carrier. Compliance with the emissions limits is based on the use of measurement instrumentation employing a peak detector function with an instrument resolutions bandwidth approximately equal to 1.0 percent of the emission bandwidth of the device under measurement.

Test Configuration

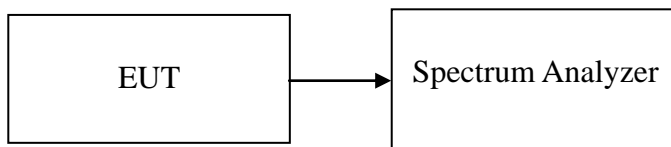

TEST PROCEDURE

1. Place the EUT on the table and set it in the transmitting mode.
2. Remove the antenna from the EUT and then connect a low-loss RF cable from the antenna port to the spectrum analyzer.
3. Set the spectrum analyzer as RBW > 1%EBW, VBW > RBW, Span >26dB bandwidth, and Sweep = auto.
4. Mark the peak frequency and -26dB (upper and lower) frequency.
5. Repeat until all the rest channels were investigated.

TEST RESULTS

No non-compliance noted



Test Data

Test mode: IEEE 802.11a mode / 5180 ~ 5240MHz

Channel	Frequency (MHz)	26db Bandwidth (MHz)	99% Bandwidth (MHz)
Low	5180	26.242	17.2559
Mid	5220	25.398	17.2787
High	5240	24.398	17.1948

Test mode: IEEE 802.11n HT 20 MHz Channel mode / 5180 ~ 5240MHz

Channel	Frequency (MHz)	26db Bandwidth (MHz)	99% Bandwidth (MHz)
Low	5180	23.418	18.2246
Mid	5220	22.956	18.2678
High	5240	23.191	18.1619

Test mode: IEEE 802.11n HT 40 MHz mode / 5190 ~ 5230MHz

Channel	Frequency (MHz)	26db Bandwidth (MHz)	99% Bandwidth (MHz)
Low	5190	41.234	36.1539
High	5230	41.320	36.1341

Test mode: IEEE 802.11ac VHT 80 MHz mode / 5210MHz

Channel	Frequency (MHz)	26db Bandwidth (MHz)	99% Bandwidth (MHz)
Mid	5210	81.255	74.6758



Test mode: IEEE 802.11a mode / 5260 ~ 5320MHz

Channel	Frequency (MHz)	26db Bandwidth (MHz)	99% Bandwidth (MHz)
Low	5260	24.781	17.1792
Mid	5280	24.626	17.2737
High	5320	24.827	17.2353

Test mode: IEEE 802.11n HT 20 MHz Channel mode / 5260 ~ 5320MHz

Channel	Frequency (MHz)	26db Bandwidth (MHz)	99% Bandwidth (MHz)
Low	5260	23.766	18.1230
Mid	5280	23.174	18.1729
High	5320	22.446	17.9976

Test mode: IEEE 802.11n HT 40 MHz mode / 5270 ~ 5310MHz

Channel	Frequency (MHz)	26db Bandwidth (MHz)	99% Bandwidth (MHz)
Low	5270	44.437	36.1759
High	5310	42.201	36.1802

Test mode: IEEE 802.11ac VHT 80 MHz mode / 5290MHz

Channel	Frequency (MHz)	26db Bandwidth (MHz)	99% Bandwidth (MHz)
Mid	5290	98.688	75.1509



Test mode: IEEE 802.11a mode / 5500 ~ 5700MHz

Channel	Frequency (MHz)	26db Bandwidth (MHz)	99% Bandwidth (MHz)
Low	5500	24.709	17.2673
Mid	5580	24.306	17.1654
High	5700	24.775	17.1957

Test mode: IEEE 802.11n HT 20 MHz Channel mode / 5500 ~ 5700MHz

Channel	Frequency (MHz)	26db Bandwidth (MHz)	99% Bandwidth (MHz)
Low	5500	23.165	18.1910
Mid	5580	22.586	18.0784
High	5700	22.781	18.1243

Test mode: IEEE 802.11n HT 40 MHz mode / 5510 ~ 5670MHz

Channel	Frequency (MHz)	26db Bandwidth (MHz)	99% Bandwidth (MHz)
Low	5510	45.575	36.0802
Mid	5550	42.708	36.1555
High	5670	41.358	36.1023

Test mode: IEEE 802.11ac VHT 80 MHz mode / 5530 ~ 5690MHz

Channel	Frequency (MHz)	26db Bandwidth (MHz)	99% Bandwidth (MHz)
Low	5530	80.919	74.7390
High	5690 (Band III)	81.7	75.2751
High	5690 (Band IV)	6	-

Remark:

Band III = 87.7MHz – (mark2 – mark3)

Band IV = mark2 – mark3



Test Plot

IEEE 802.11a for 5180 ~ 5240MHz

CH Low

Agilent

R T

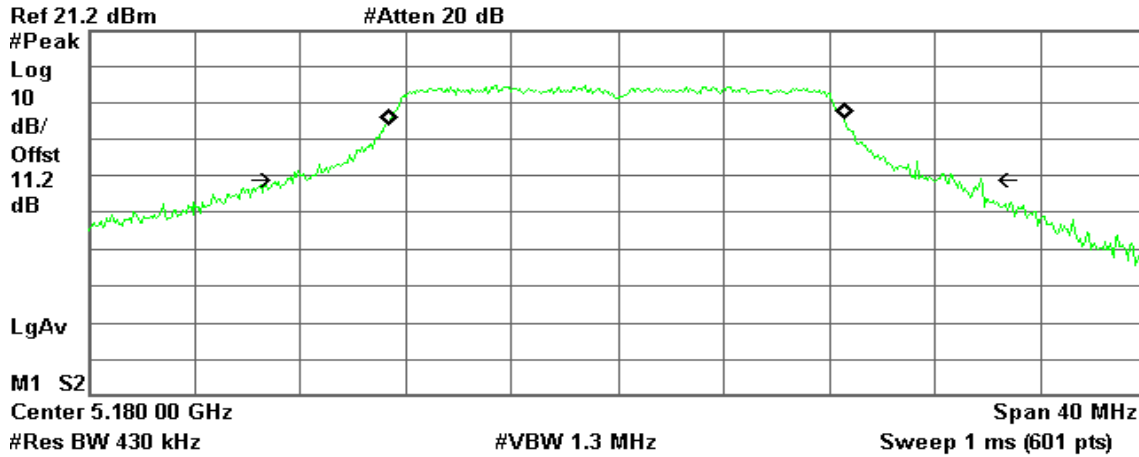

Occupied Bandwidth

17.2559 MHz

Occ BW % Pwr	99.00 %
x dB	-26.00 dB

Transmit Freq Error	-41.836 kHz
x dB Bandwidth	26.242 MHz

CH Mid

Agilent

R T

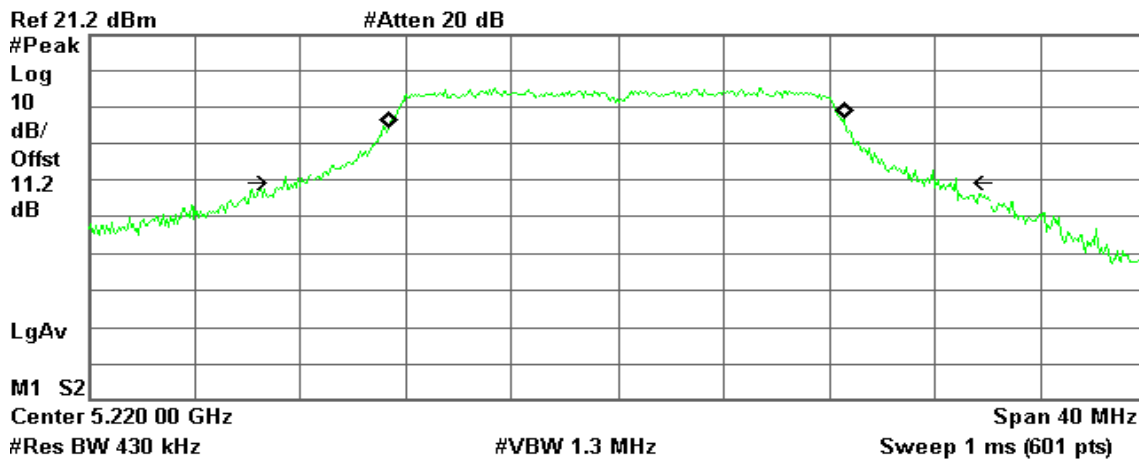

Occupied Bandwidth

17.2787 MHz

Occ BW % Pwr	99.00 %
x dB	-26.00 dB

Transmit Freq Error	-45.149 kHz
x dB Bandwidth	25.398 MHz



CH High

Agilent

R T

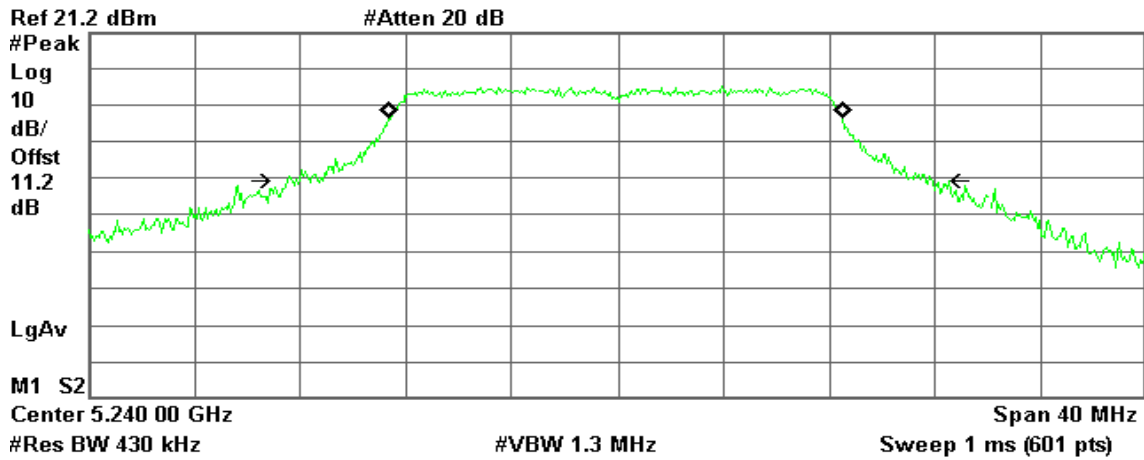

Occupied Bandwidth
17.1948 MHz

Occ BW % Pwr	99.00 %
x dB	-26.00 dB

Transmit Freq Error	-63.317 kHz
x dB Bandwidth	24.398 MHz



IEEE 802.11n HT 20 MHz Channel mode / 5180 ~ 5240MHz

CH Low

Agilent

R T

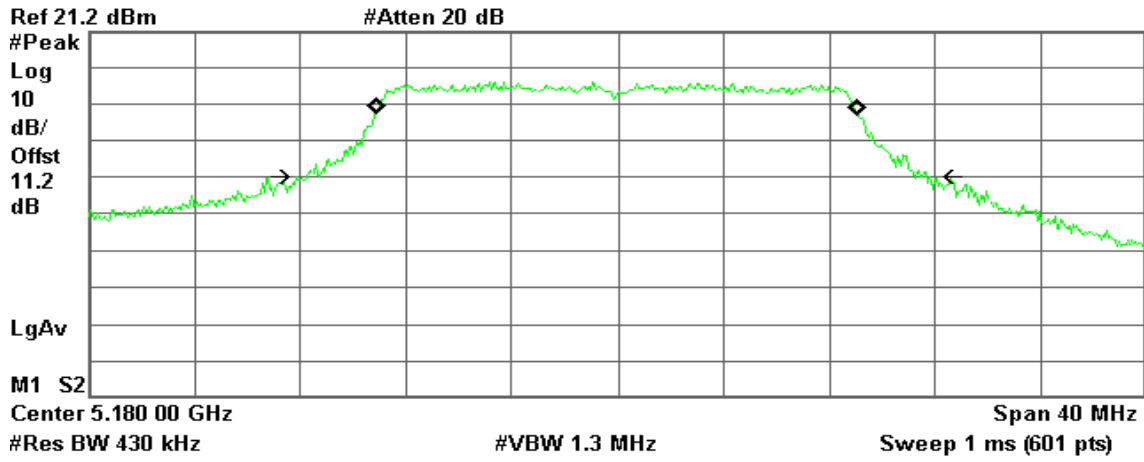

Occupied Bandwidth
18.2246 MHz

Occ BW % Pwr 99.00 %
x dB -26.00 dB

Transmit Freq Error -14.333 kHz
x dB Bandwidth 23.418 MHz

CH Mid

Agilent

R T

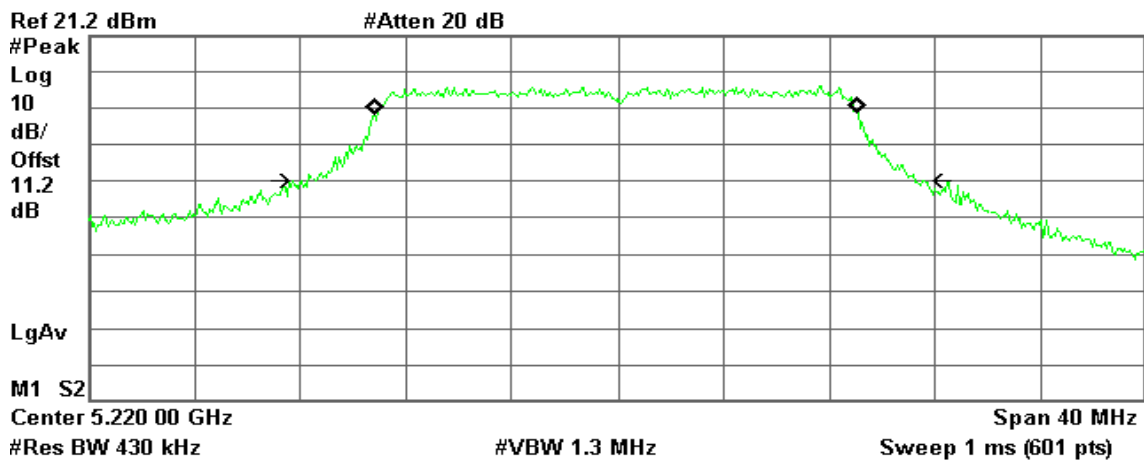

Occupied Bandwidth
18.2678 MHz

Occ BW % Pwr 99.00 %
x dB -26.00 dB

Transmit Freq Error -44.565 kHz
x dB Bandwidth 22.956 MHz



CH High

Agilent

R T

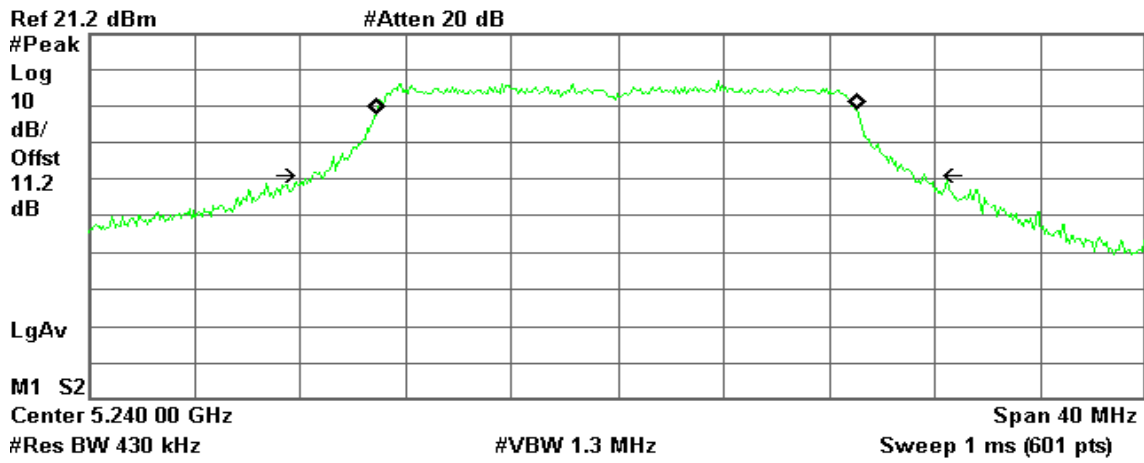

Occupied Bandwidth
18.1619 MHz

Occ BW % Pwr 99.00 %
x dB -26.00 dB

Transmit Freq Error -34.091 kHz
x dB Bandwidth 23.191 MHz



IEEE 802.11n HT 40 MHz mode / 5190 ~ 5230MHz

CH Low

Agilent

R T

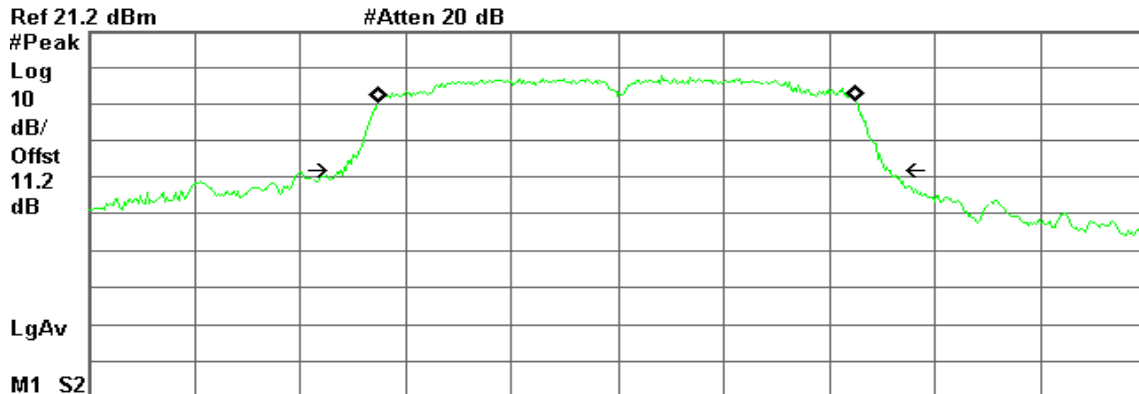

Center 5.190 00 GHz Span 80 MHz
 #Res BW 820 kHz #VBW 2.4 MHz Sweep 1 ms (601 pts)

Occupied Bandwidth

36.1539 MHz

Occ BW % Pwr 99.00 %
 x dB -26.00 dB

Transmit Freq Error -33.943 kHz
 x dB Bandwidth 41.234 MHz

CH High

Agilent

R T

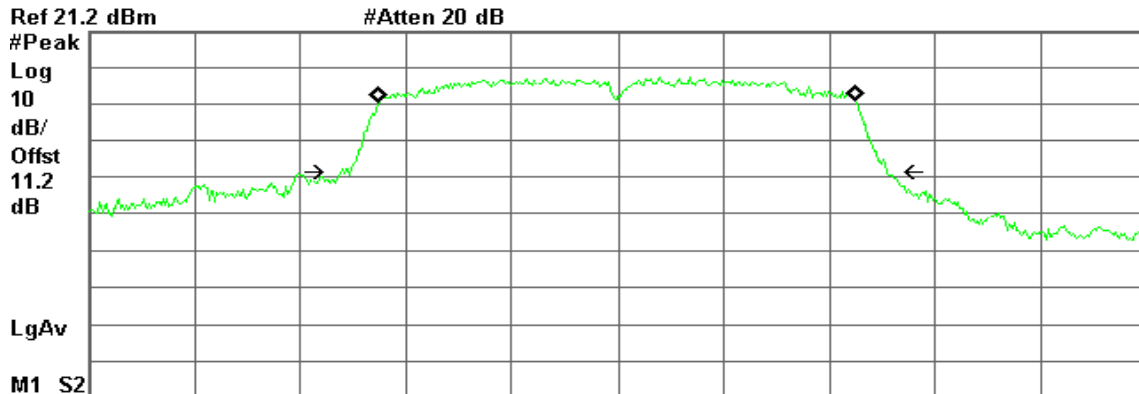

Center 5.230 00 GHz Span 80 MHz
 #Res BW 820 kHz #VBW 2.4 MHz Sweep 1 ms (601 pts)

Occupied Bandwidth

36.1341 MHz

Occ BW % Pwr 99.00 %
 x dB -26.00 dB

Transmit Freq Error -44.254 kHz
 x dB Bandwidth 41.320 MHz



IEEE 802.11ac VHT 80 MHz mode / 5210MHz

CH Mid

Agilent

R T

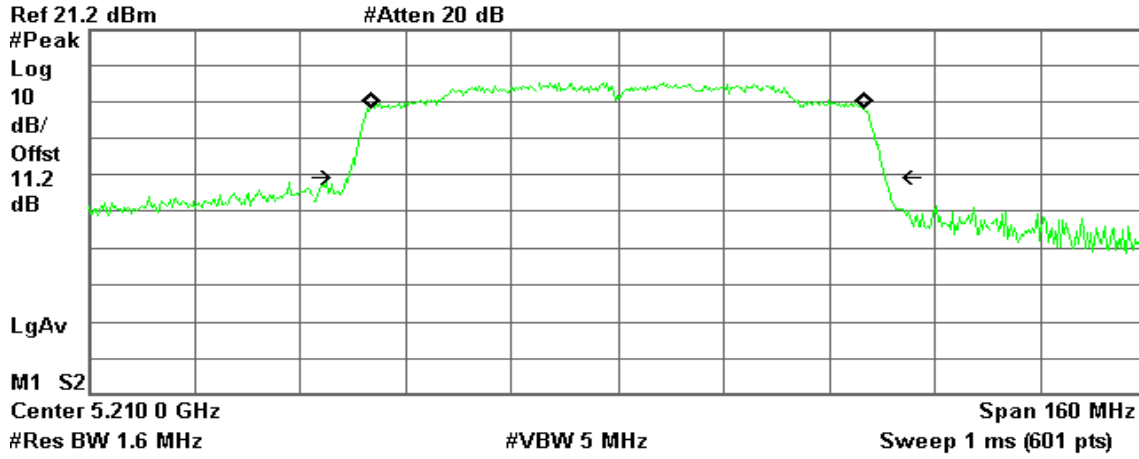

Occupied Bandwidth
74.6758 MHz

Occ BW % Pwr	99.00 %
x dB	-26.00 dB

Transmit Freq Error	-92.024 kHz
x dB Bandwidth	81.255 MHz



IEEE 802.11a mode / 5260 ~ 5320MHz

CH Low

Agilent

R T

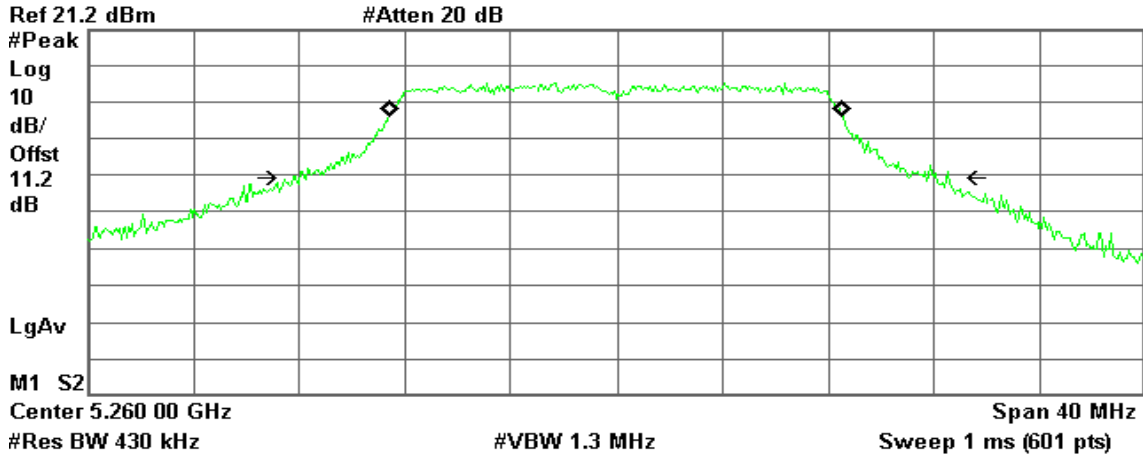

Occupied Bandwidth
17.1792 MHz

Occ BW % Pwr 99.00 %
x dB -26.00 dB

Transmit Freq Error -32.841 kHz
x dB Bandwidth 24.781 MHz

CH Mid

Agilent

R T

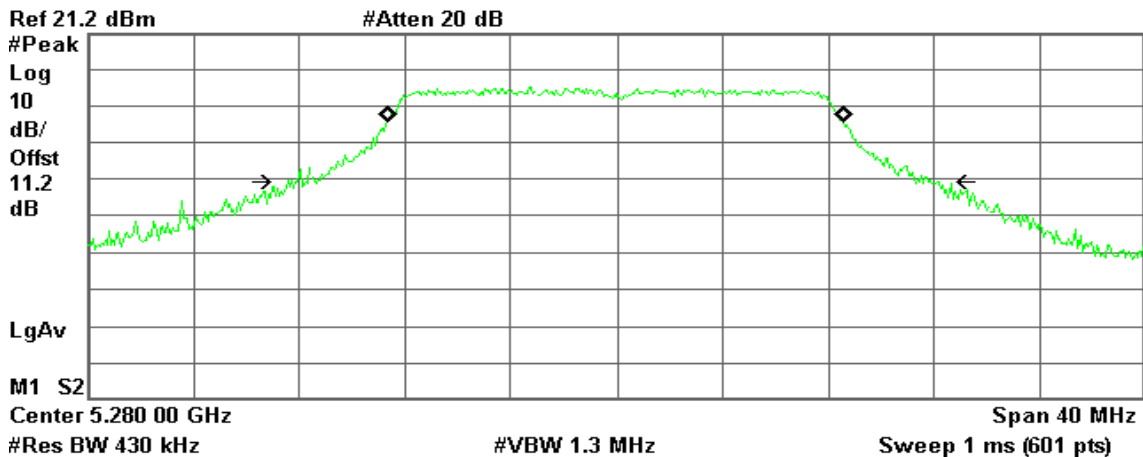

Occupied Bandwidth
17.2737 MHz

Occ BW % Pwr 99.00 %
x dB -26.00 dB

Transmit Freq Error -29.871 kHz
x dB Bandwidth 24.626 MHz



CH High

Agilent

R T

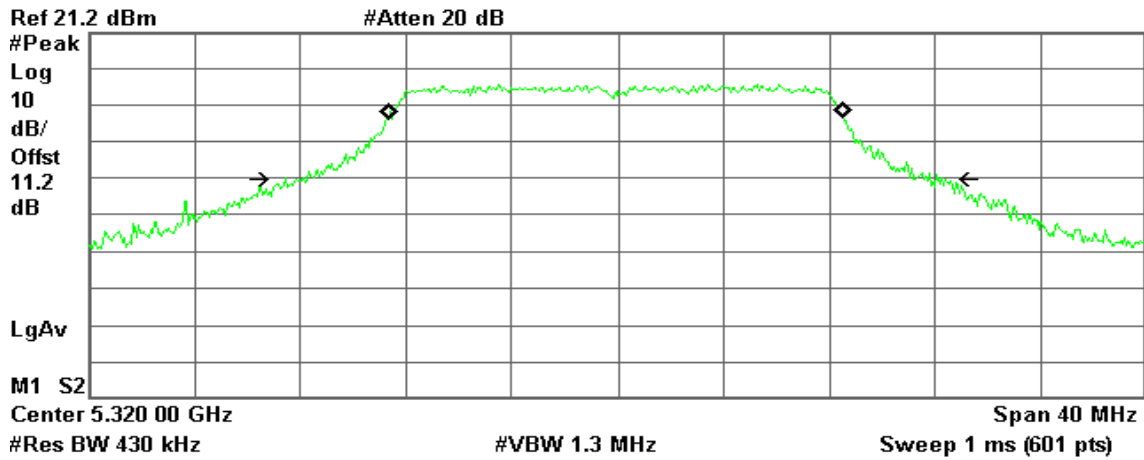

Occupied Bandwidth
17.2353 MHz

Occ BW % Pwr 99.00 %
x dB -26.00 dB

Transmit Freq Error -58.664 kHz
x dB Bandwidth 24.827 MHz



IEEE 802.11n HT 20 MHz Channel mode / 5260 ~ 5320MHz

CH Low

Agilent

R T

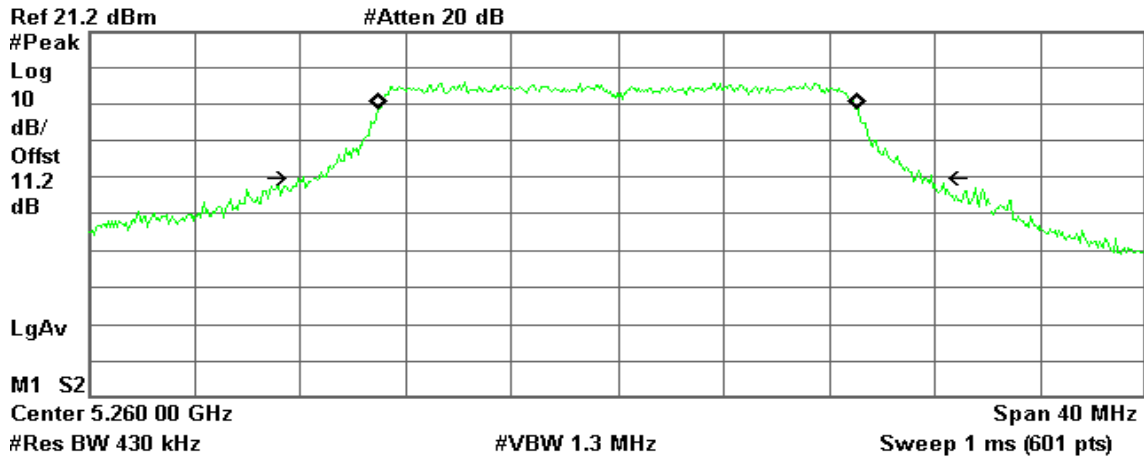

Occupied Bandwidth
18.1230 MHz

Occ BW % Pwr 99.00 %
x dB -26.00 dB

Transmit Freq Error 20.490 kHz
x dB Bandwidth 23.766 MHz

CH Mid

Agilent

R T

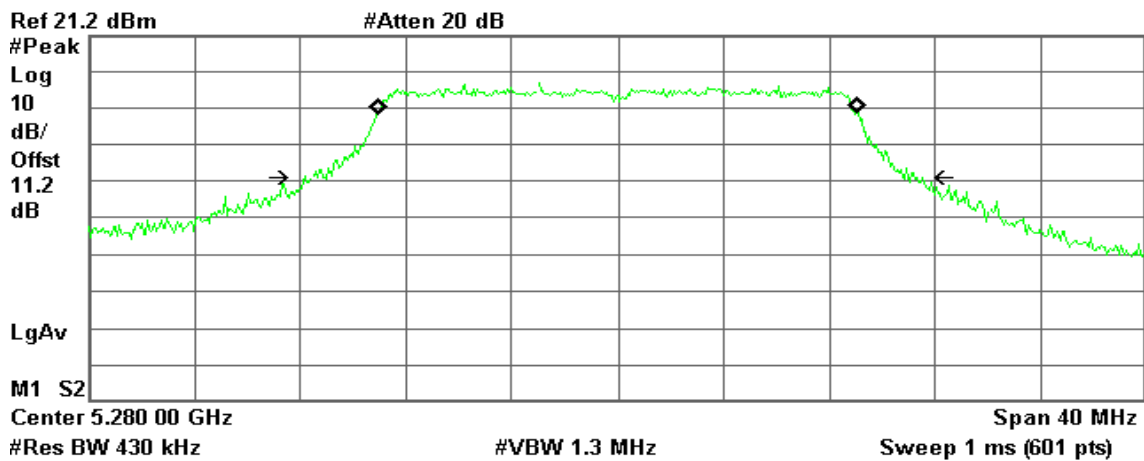

Occupied Bandwidth
18.1729 MHz

Occ BW % Pwr 99.00 %
x dB -26.00 dB

Transmit Freq Error 9.007 kHz
x dB Bandwidth 23.174 MHz



CH High

Agilent

R T

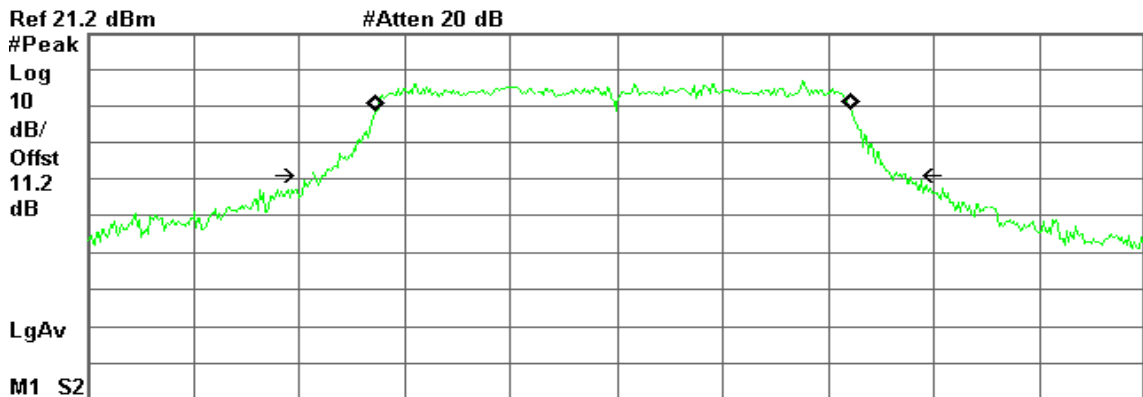

Center 5.320 00 GHz Span 40 MHz
#Res BW 430 kHz #VBW 1.3 MHz Sweep 1 ms (601 pts)

Occupied Bandwidth
17.9976 MHz

Occ BW % Pwr 99.00 %
x dB -26.00 dB

Transmit Freq Error -102.918 kHz
x dB Bandwidth 22.446 MHz



IEEE 802.11n HT 40 MHz mode / 5270 ~ 5310MHz

CH Low

Agilent

R T

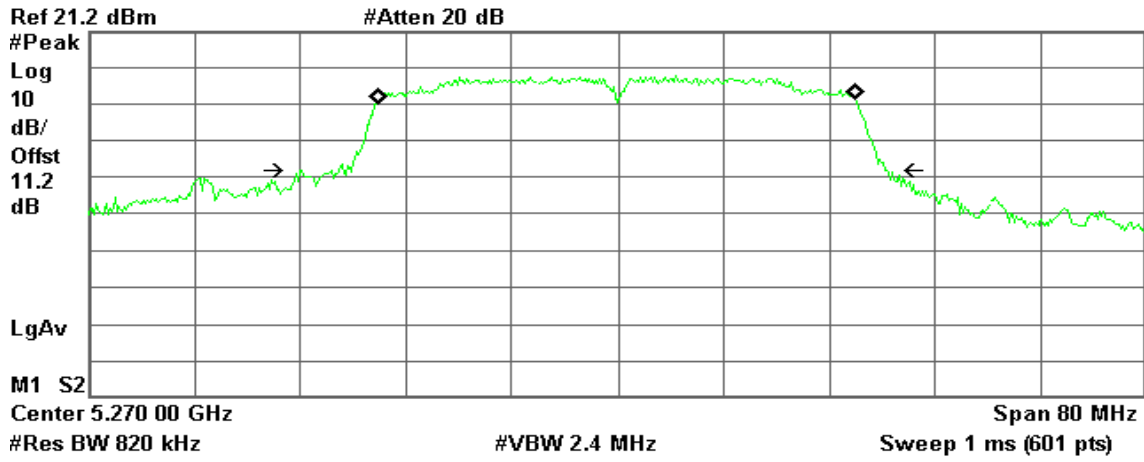

Occupied Bandwidth
36.1759 MHz

Occ BW % Pwr 99.00 %
x dB -26.00 dB

Transmit Freq Error -62.375 kHz
x dB Bandwidth 44.437 MHz

CH High

Agilent

R T

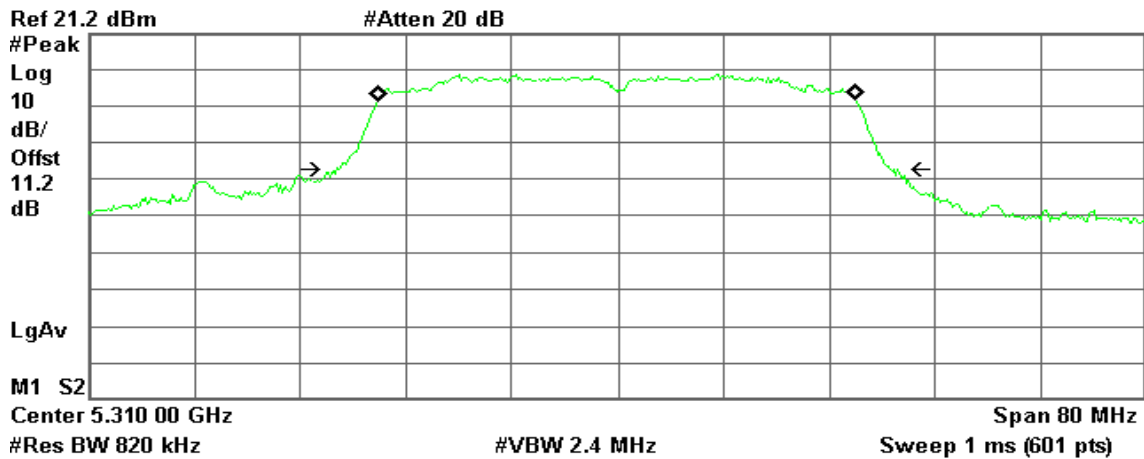

Occupied Bandwidth
36.1802 MHz

Occ BW % Pwr 99.00 %
x dB -26.00 dB

Transmit Freq Error -31.643 kHz
x dB Bandwidth 42.201 MHz



IEEE 802.11ac VHT 80 MHz mode / 5290MHz

CH Mid

Agilent

R T

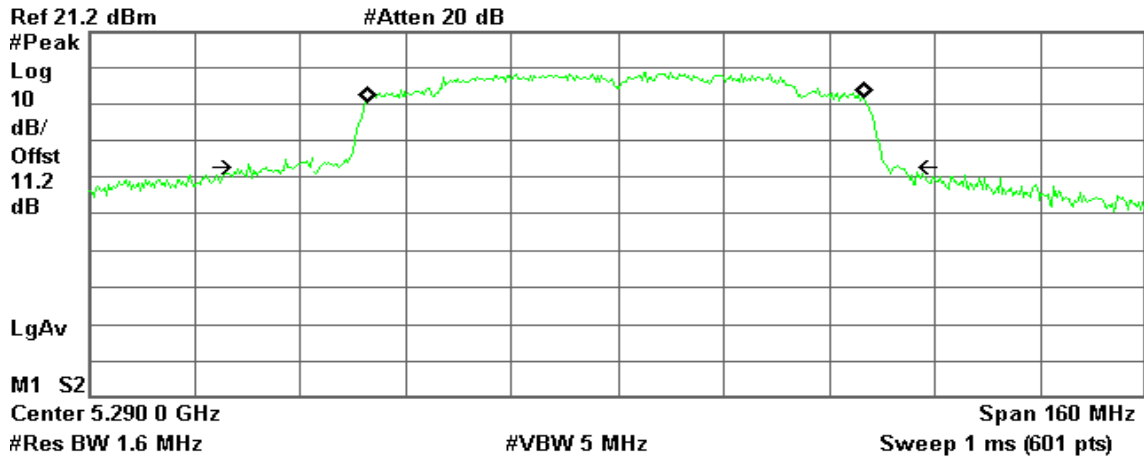

Occupied Bandwidth
75.1509 MHz

Occ BW % Pwr 99.00 %
x dB -26.00 dB

Transmit Freq Error -224.890 kHz
x dB Bandwidth 98.688 MHz



Test mode: IEEE 802.11a mode / 5500 ~ 5700MHz

CH Low

Agilent

R T

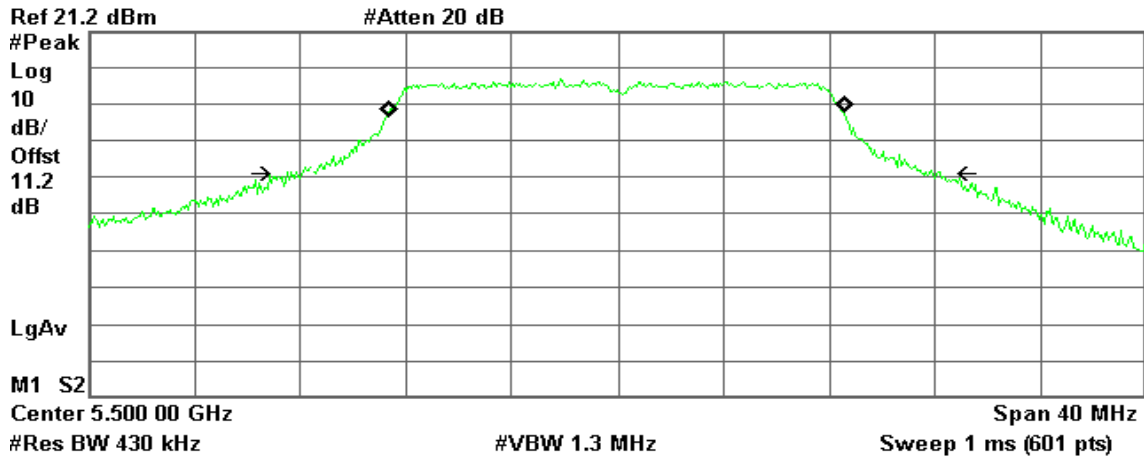

Occupied Bandwidth
17.2673 MHz

Occ BW % Pwr 99.00 %
x dB -26.00 dB

Transmit Freq Error -61.531 kHz
x dB Bandwidth 24.709 MHz

CH Mid

Agilent

R T

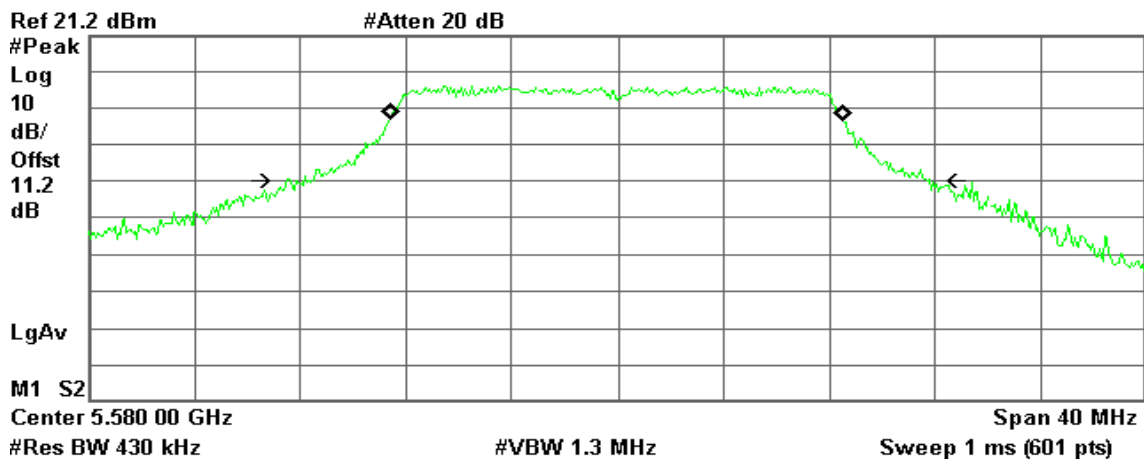

Occupied Bandwidth
17.1654 MHz

Occ BW % Pwr 99.00 %
x dB -26.00 dB

Transmit Freq Error -34.644 kHz
x dB Bandwidth 24.306 MHz



CH High

Agilent

R T

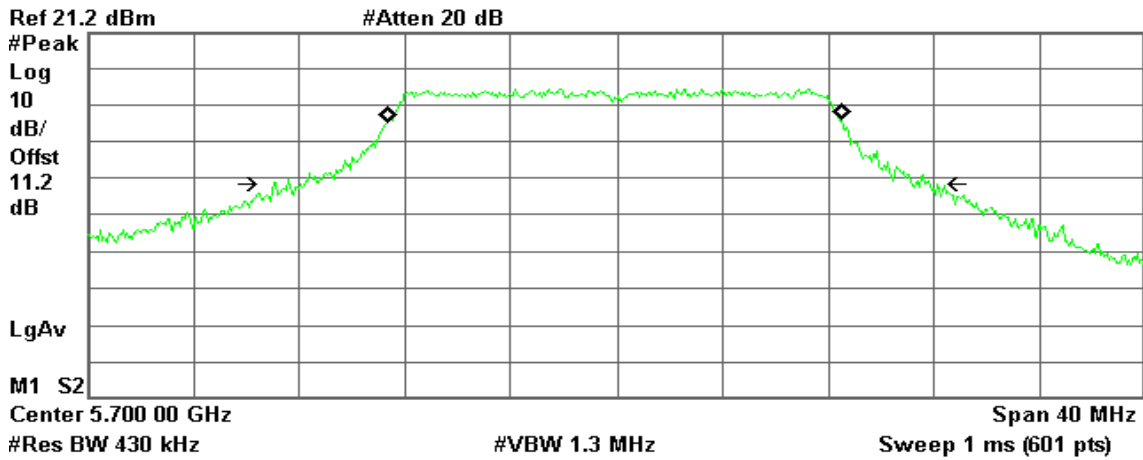

Occupied Bandwidth
17.1957 MHz

Occ BW % Pwr 99.00 %
x dB -26.00 dB

Transmit Freq Error -73.609 kHz
x dB Bandwidth 24.775 MHz



IEEE 802.11n HT 20 MHz Channel mode / 5500 ~ 5700MHz

CH Low

Agilent

R T

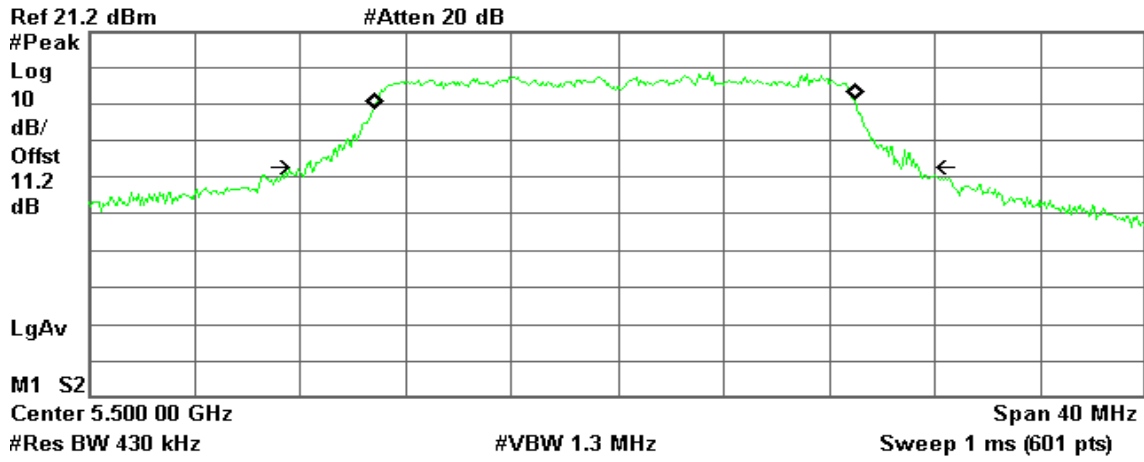

Occupied Bandwidth
18.1910 MHz

Occ BW % Pwr 99.00 %
x dB -26.00 dB

Transmit Freq Error -97.515 kHz
x dB Bandwidth 23.165 MHz

CH Mid

Agilent

R T

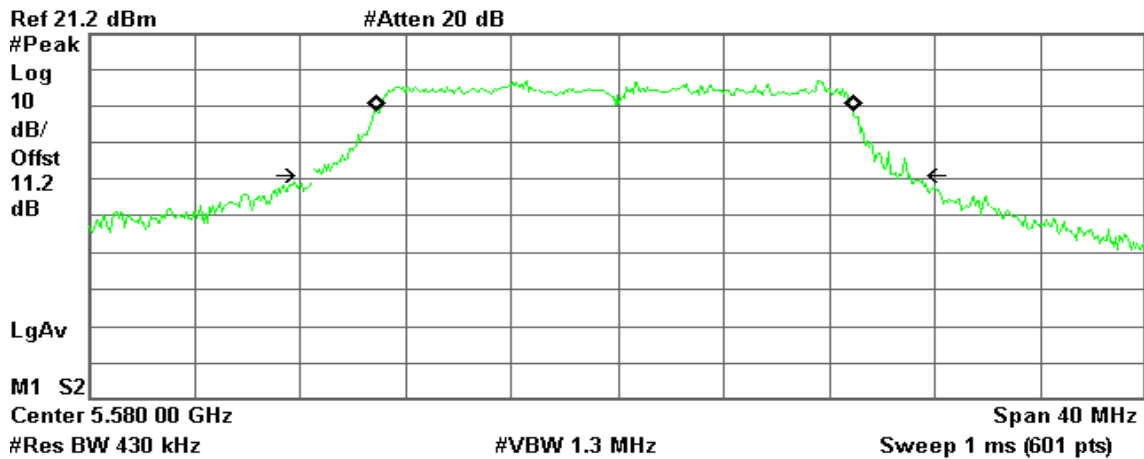

Occupied Bandwidth
18.0784 MHz

Occ BW % Pwr 99.00 %
x dB -26.00 dB

Transmit Freq Error -125.870 kHz
x dB Bandwidth 22.586 MHz



CH High

Agilent

R T

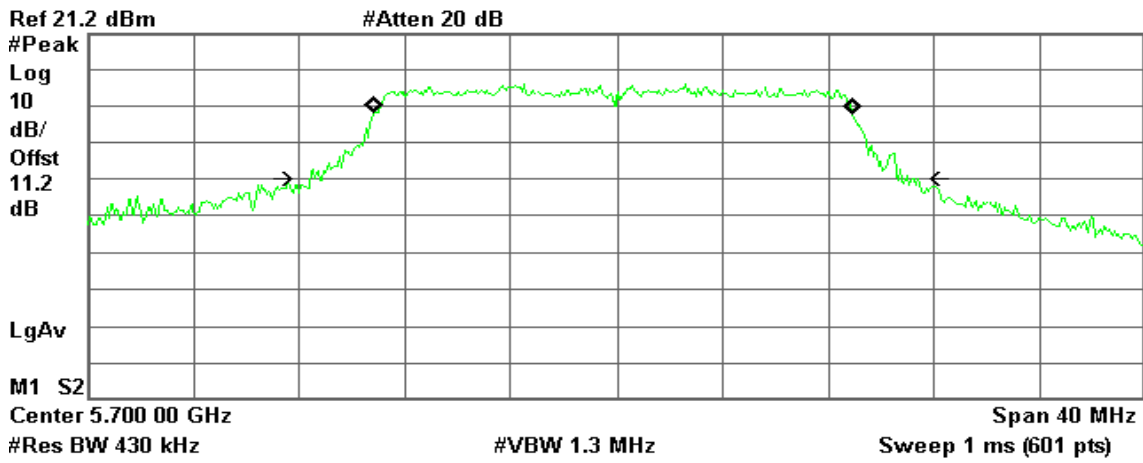

Occupied Bandwidth
18.1243 MHz

Occ BW % Pwr 99.00 %
x dB -26.00 dB

Transmit Freq Error -111.403 kHz
x dB Bandwidth 22.781 MHz



IEEE 802.11n HT 40 MHz mode / 5510 ~ 5670MHz

CH Low

Agilent

R T

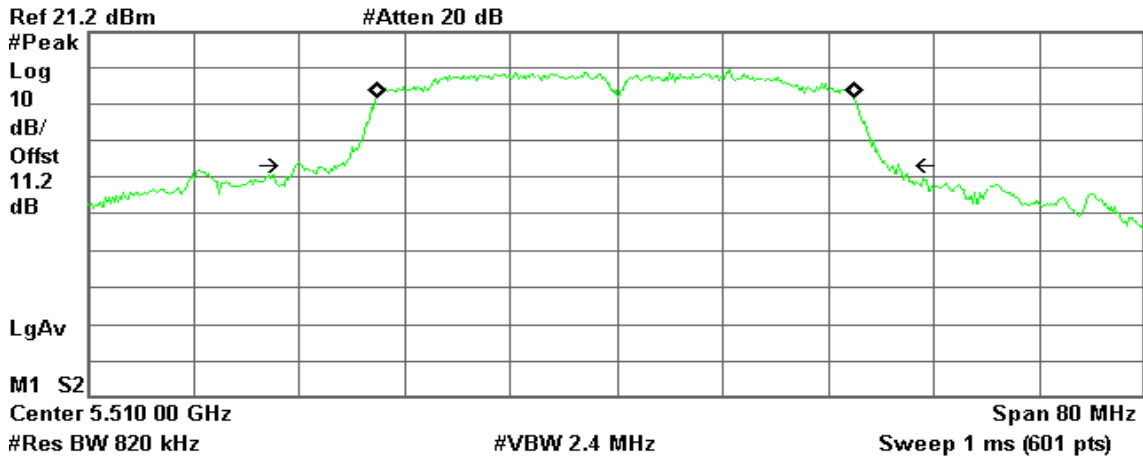

Occupied Bandwidth
36.0802 MHz

Occ BW % Pwr 99.00 %
x dB -26.00 dB

Transmit Freq Error -89.558 kHz
x dB Bandwidth 45.575 MHz

CH Mid

Agilent

R T

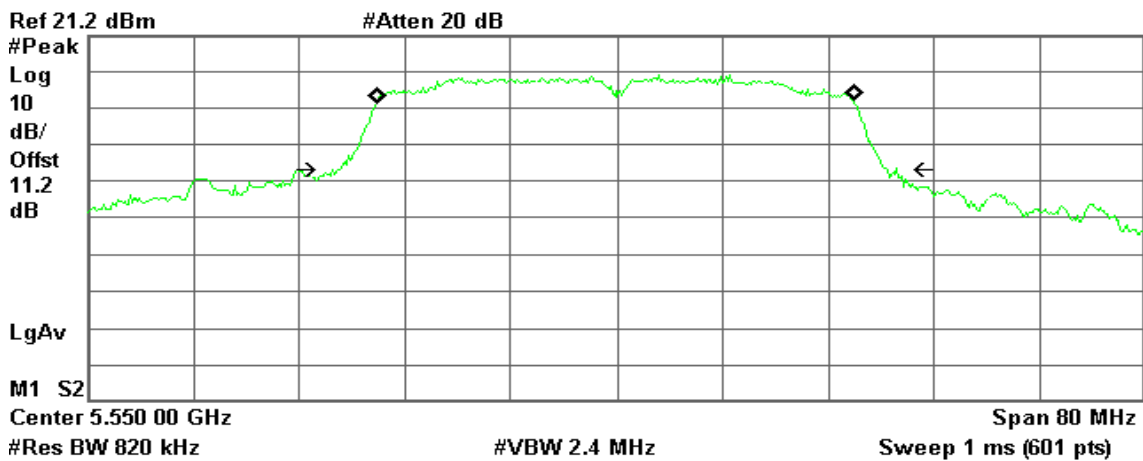

Occupied Bandwidth
36.1555 MHz

Occ BW % Pwr 99.00 %
x dB -26.00 dB

Transmit Freq Error -82.778 kHz
x dB Bandwidth 42.708 MHz



CH High

Agilent

R T

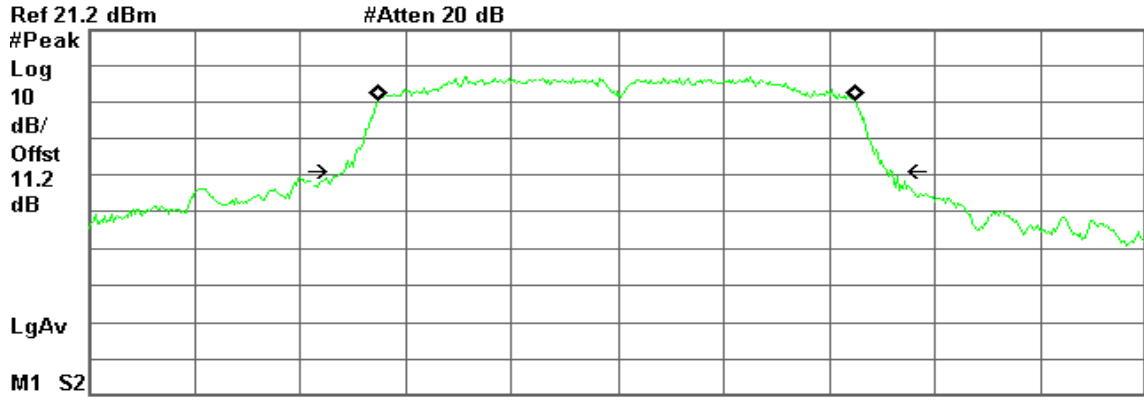

Occupied Bandwidth
36.1023 MHz

Occ BW % Pwr 99.00 %
x dB -26.00 dB

Transmit Freq Error -51.213 kHz
x dB Bandwidth 41.358 MHz



IEEE 802.11ac VHT 80 MHz mode / 5530 ~ 5690MHz

CH Low

Agilent

R T

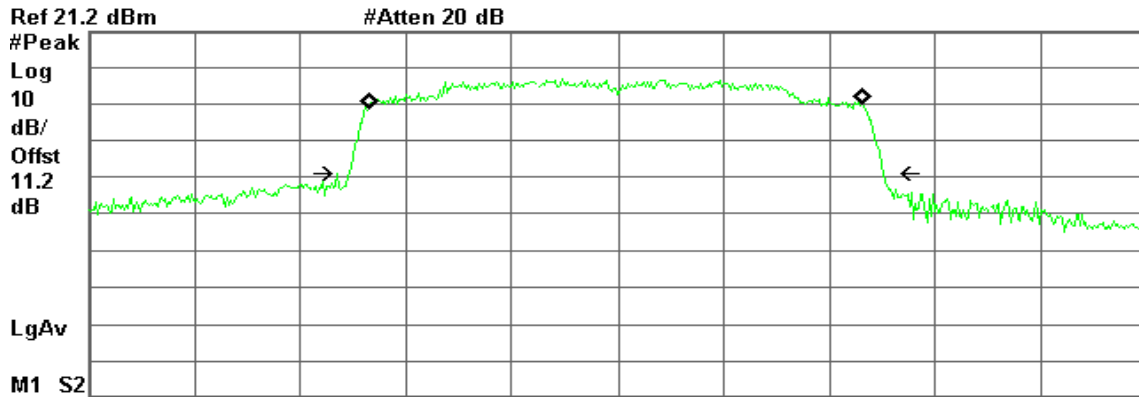

Center 5.530 0 GHz Span 160 MHz

#Res BW 1.6 MHz #VBW 5 MHz Sweep 1 ms (601 pts)

Occupied Bandwidth
74.7390 MHz

Occ BW % Pwr 99.00 %
x dB -26.00 dB

Transmit Freq Error -238.364 kHz
x dB Bandwidth 80.919 MHz

CH High (Band III & Band IV)

Agilent

R T

▲ Mkr2 -87.7 MHz
0.78 dB

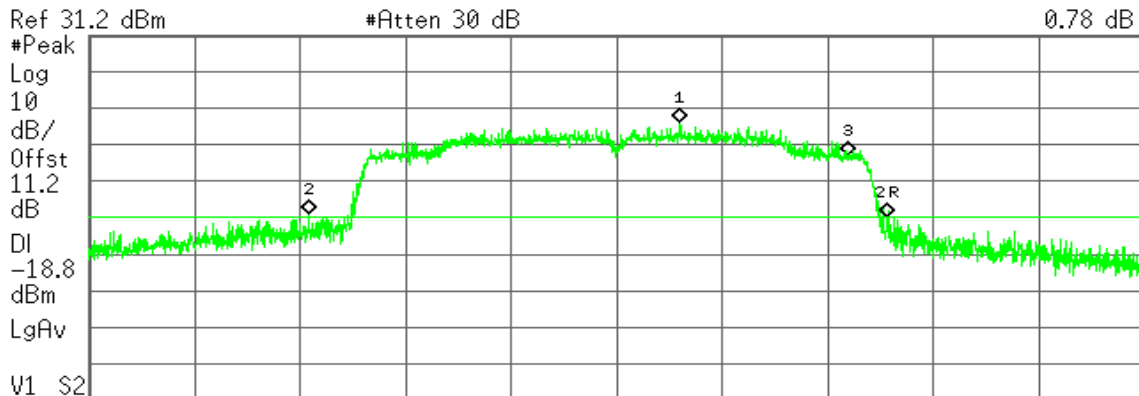

Center 5.690 0 GHz Span 160 MHz

#Res BW 1.6 MHz #VBW 5 MHz Sweep 999.7 μs (3000 pts)

Marker	Trace	Type	X Axis	Amplitude
1	(1)	Freq	5.699 6 GHz	7.25 dBm
2R	(1)	Freq	5.731 0 GHz	-18.54 dBm
2▲	(1)	Freq	-87.7 MHz	0.78 dB
3	(1)	Freq	5.725 0 GHz	-1.63 dBm



IEEE 802.11ac VHT 80 MHz mode / 5690MHz

For 99% Bandwidth

Agilent

R T

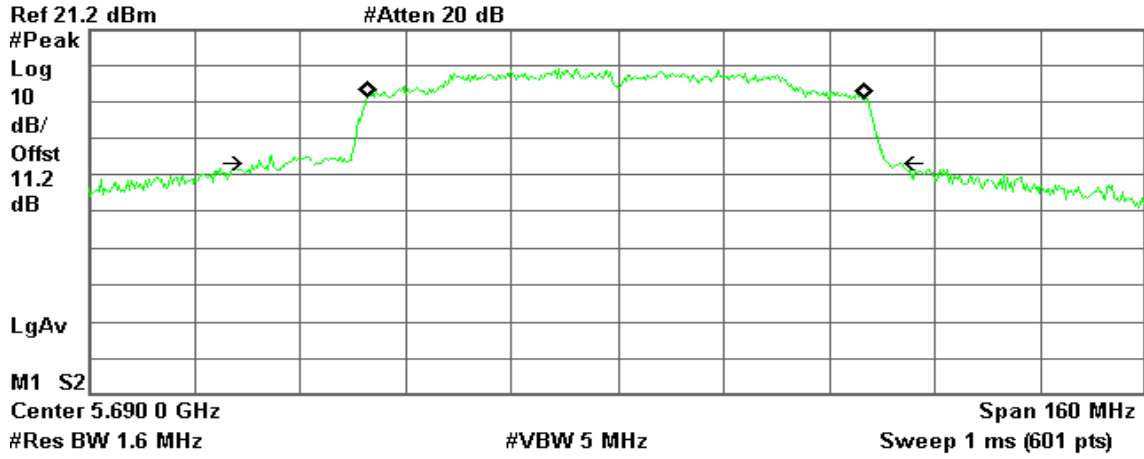

Occupied Bandwidth
75.2751 MHz

Occ BW % Pwr 99.00 %
x dB -26.00 dB

Transmit Freq Error -177.039 kHz
x dB Bandwidth 95.155 MHz



7.2 MAXIMUM CONDUCTED OUTPUT POWER

LIMIT

According to §15.407(a),

- (1) For the band 5.15-5.25 GHz, the maximum conducted output power over the frequency band of operation shall not exceed the lesser of 250 mW, where B is the 26 dB emission bandwidth in MHz.
- (2) For the 5.25-5.35 GHz and 5.47-5.725 GHz bands, the maximum conducted output power over the frequency bands of operation shall not exceed the lesser of 250 mW, where B is the 26 dB emission bandwidth in MHz.

If transmitting antennas of directional gain greater than 6dBi are used, both the peak transmit power and the peak power spectral density shall be reduced by the amount in dB that the directional gain of the antenna exceeds 6dBi.

Specified Limit of the Maximum Output Power Test Configuration

The EUT was connected to a Power Meter through a 50Ω RF cable.

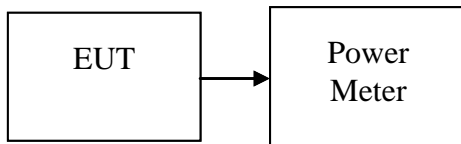

TEST PROCEDURE

The transmitter output is connected to the Power Meter. The Power Meter is set to the avg power detection. The EUT is configured to transmit continuously.

TEST RESULTS

No non-compliance noted



Test Data

Test mode: IEEE 802.11a mode / 5180 ~ 5240MHz

Channel	Frequency (MHz)	Maximum Conducted Output Power (dBm)	Limit (dBm)
Low	5180	13.39	24.00
Mid	5220	13.38	24.00
High	5240	*13.43	24.00

Test mode: IEEE 802.11n HT 20 MHz Channel mode / 5180 ~ 5240MHz

Channel	Frequency (MHz)	Total Maximum Conducted Output Power (dBm)	Limit (dBm)
Low	5180	13.38	24.00
Mid	5220	*13.41	24.00
High	5240	13.38	24.00

Test mode: IEEE 802.11n HT 40 MHz mode / 5190 ~ 5230MHz

Channel	Frequency (MHz)	Total Maximum Conducted Output Power (dBm)	Limit (dBm)
Low	5190	*13.41	24.00
High	5230	13.39	24.00

Test mode: IEEE 802.11ac VHT 80 MHz mode / 5210MHz

Channel	Frequency (MHz)	Total Maximum Conducted Output Power (dBm)	Limit (dBm)
Mid	5210	*10.69	24.00



Test mode: IEEE 802.11a mode / 5260 ~ 5320MHz

Channel	Frequency (MHz)	Maximum Conducted Output Power (dBm)	Limit (dBm)
Low	5260	13.29	24.00
Mid	5280	13.34	24.00
High	5320	*13.41	24.00

Test mode: IEEE 802.11n HT 20 MHz Channel mode / 5260 ~ 5320MHz

Channel	Frequency (MHz)	Total Maximum Conducted Output Power (dBm)	Limit (dBm)
Low	5260	13.38	24.00
Mid	5280	13.39	24.00
High	5320	*13.41	24.00

Test mode: IEEE 802.11n HT 40 MHz mode / 5270 ~ 5310MHz

Channel	Frequency (MHz)	Total Maximum Conducted Output Power (dBm)	Limit (dBm)
Low	5270	*13.41	24.00
High	5310	13.39	24.00

Test mode: IEEE 802.11ac VHT 80 MHz mode / 5290MHz

Channel	Frequency (MHz)	Total Maximum Conducted Output Power (dBm)	Limit (dBm)
Mid	5290	*12.57	24.00



Test mode: IEEE 802.11a mode / 5500 ~ 5700MHz

Channel	Frequency (MHz)	Maximum Conducted Output Power (dBm)	Limit (dBm)
Low	5500	13.38	24.00
Mid	5580	13.37	24.00
High	5700	*13.39	24.00

Test mode: IEEE 802.11n HT 20 MHz Channel mode/ 5500 ~ 5700MHz

Channel	Frequency (MHz)	Total Maximum Conducted Output Power (dBm)	Limit (dBm)
Low	5500	*13.41	24.00
Mid	5580	13.39	24.00
High	5700	13.41	24.00

Test mode: IEEE 802.11n HT 40 MHz mode / 5510 ~ 5670MHz

Channel	Frequency (MHz)	Total Maximum Conducted Output Power (dBm)	Limit (dBm)
Low	5510	*13.41	24.00
Mid	5550	13.39	24.00
High	5670	13.41	24.00

Test mode: IEEE 802.11ac VHT 80 MHz mode / 5530 ~ 5690MHz

Channel	Frequency (MHz)	Total Maximum Conducted Output Power (dBm)	Limit (dBm)
Low	5530	9.74	24.00
High	5690	*11.77 (Band III)	24.00
High	5690	-5.38 (Band IV)	30.00



7.3 BAND EDGES MEASUREMENT

LIMIT

According to §15.407(b)

- (1) The provisions of Section 15.205 of this part apply to intentional radiators operating under this section.
- (2) When measuring the emission limits, the nominal carrier frequency shall be adjusted as close to the upper and lower frequency block edges as the design of the equipment permits.

Test Configuration

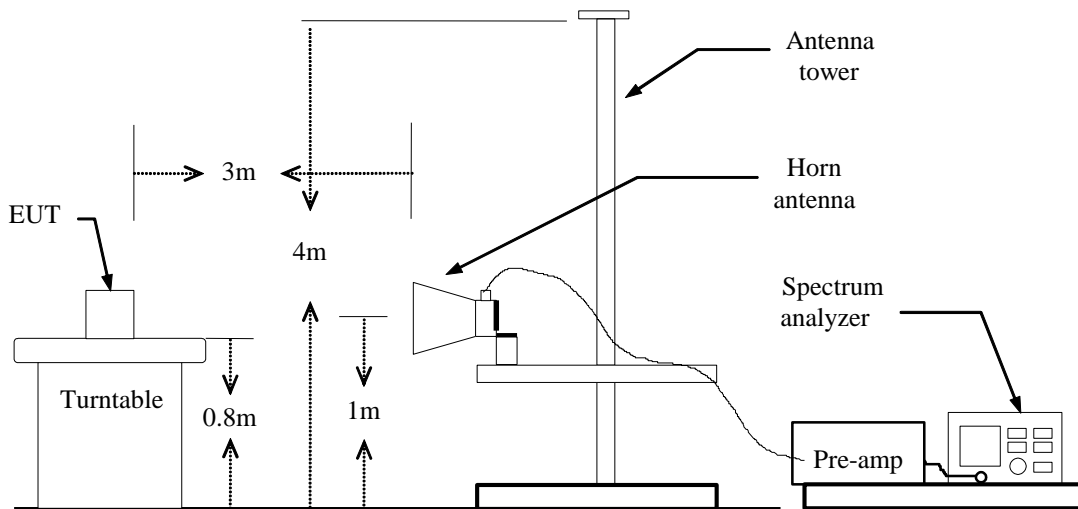

TEST PROCEDURE

1. The EUT is placed on a turntable, which is 0.8m above the ground plane.
2. The turntable shall be rotated for 360 degrees to determine the position of maximum emission level.
3. EUT is set 3m away from the receiving antenna, which is varied from 1m to 4m to find out the highest emission.
4. Set the spectrum analyzer in the following setting in order to capture the lower and upper band-edges of the emission:
 - (a) PEAK: RBW=1MHz / VBW=3MHz / Sweep=AUTO
 - (b) AVERAGE: RBW=1MHz,
if duty cycle $\geq 98\%$, VBW=10Hz.
if duty cycle $< 98\%$ VBW=1/T.
IEEE 802.11b mode: $\geq 98\%$, VBW=10Hz
IEEE 802.11g mode: $\geq 98\%$, VBW=10Hz
IEEE 802.11n HT 20 MHz mode: $\geq 98\%$, VBW=10Hz
IEEE 802.11n HT 40 MHz mode: $96\% = \text{VBW } 2\text{kHz}$
5. Repeat the procedures until all the PEAK and AVERAGE versus POLARIZATION are measured.

TEST RESULTS

Refer to attach spectrum analyzer data chart.



Band Edges (IEEE 802.11a mode / CH 5180 MHz)

Polarity: Vertical

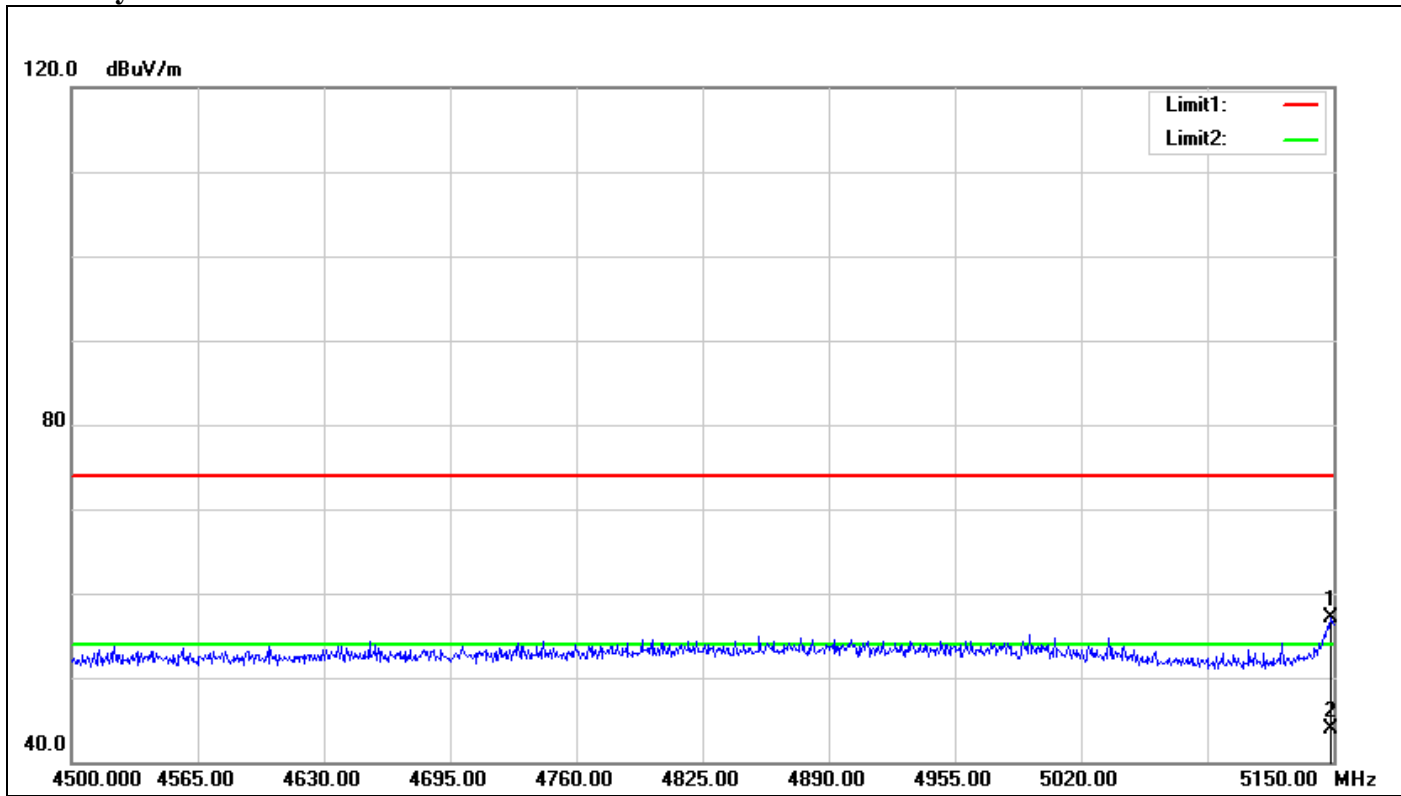

No.	Frequency (MHz)	Reading (dBuV)	Correct Factor(dB/m)	Result (dBuV/m)	Limit (dBuV/m)	Margin (dB)	Height (cm)	Degree (°)	Remark
1	5148.700	54.07	3.03	57.10	74.00	-16.90	100	161	peak
2	5148.700	40.89	3.03	43.92	54.00	-10.08	100	161	AVG



Polarity: Horizontal

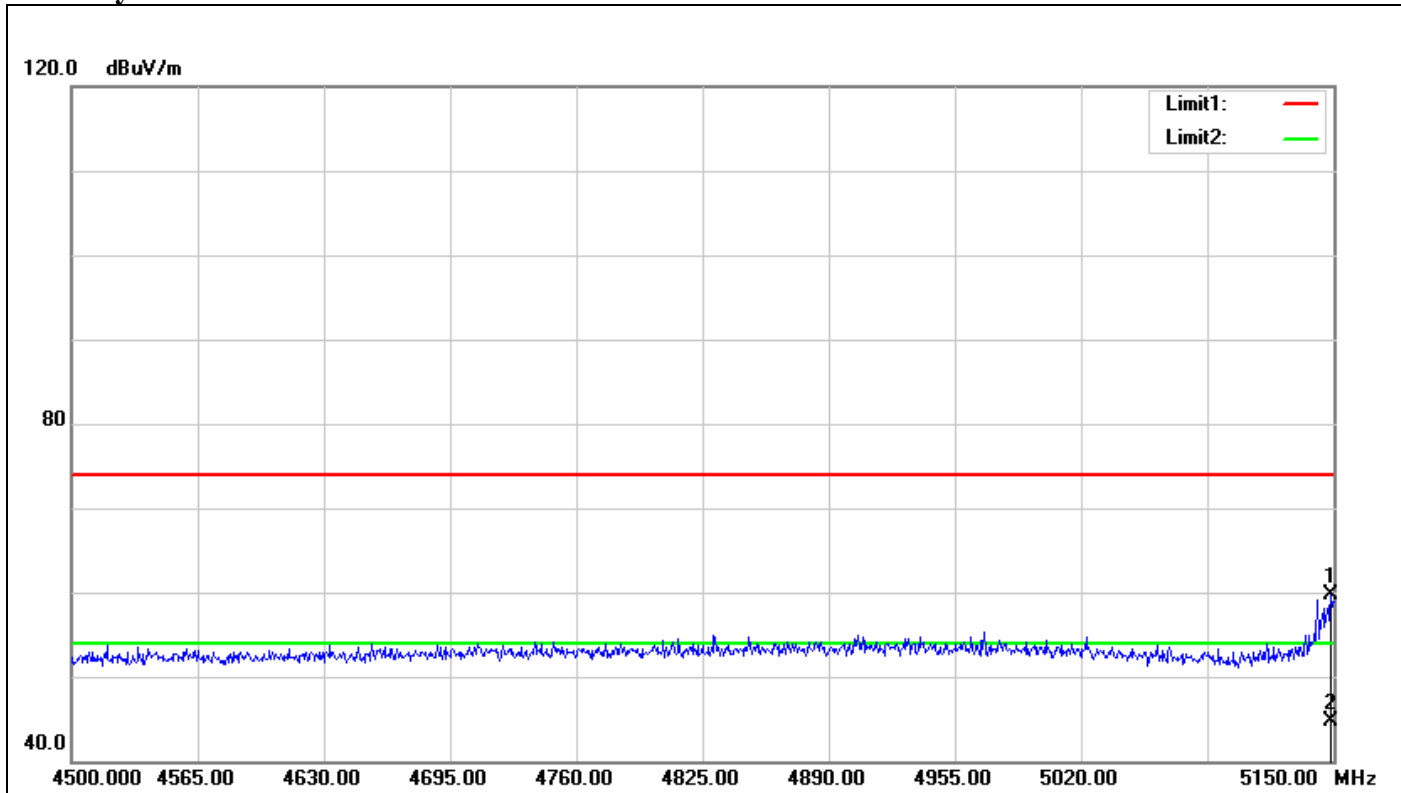

No.	Frequency (MHz)	Reading (dBuV)	Correct Factor(dB/m)	Result (dBuV/m)	Limit (dBuV/m)	Margin (dB)	Height (cm)	Degree (°)	Remark
1	5148.700	56.69	3.03	59.72	74.00	-14.28	100	123	peak
2	5148.700	41.61	3.03	44.64	54.00	-9.36	100	123	AVG



Band Edges (IEEE 802.11a mode / CH 5320 MHz)

Polarity: Vertical

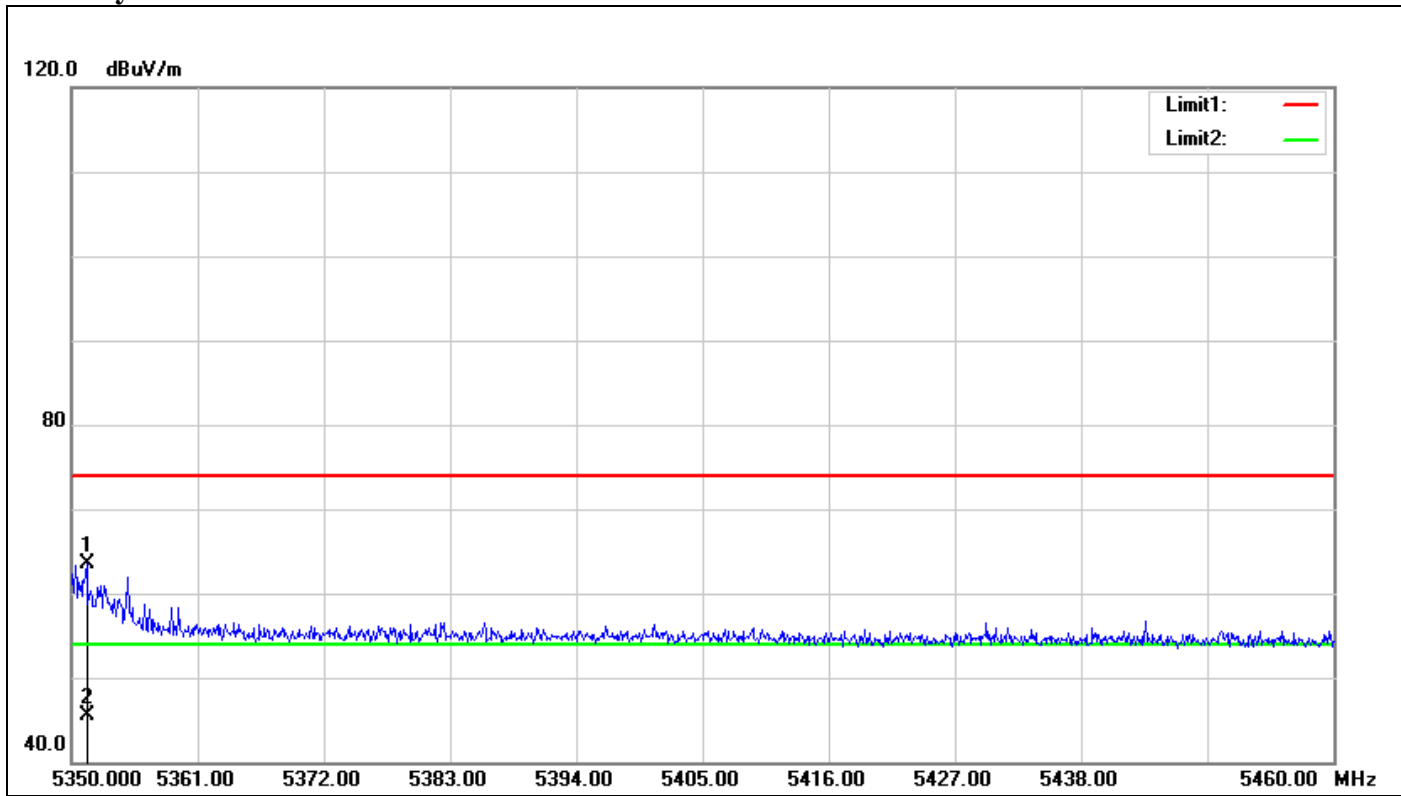

No.	Frequency (MHz)	Reading (dBuV)	Correct Factor(dB/m)	Result (dBuV/m)	Limit (dBuV/m)	Margin (dB)	Height (cm)	Degree (°)	Remark
1	5351.320	58.25	5.32	63.57	74.00	-10.43	100	225	peak
2	5351.320	40.09	5.32	45.41	54.00	-8.59	100	225	AVG



Polarity: Horizontal

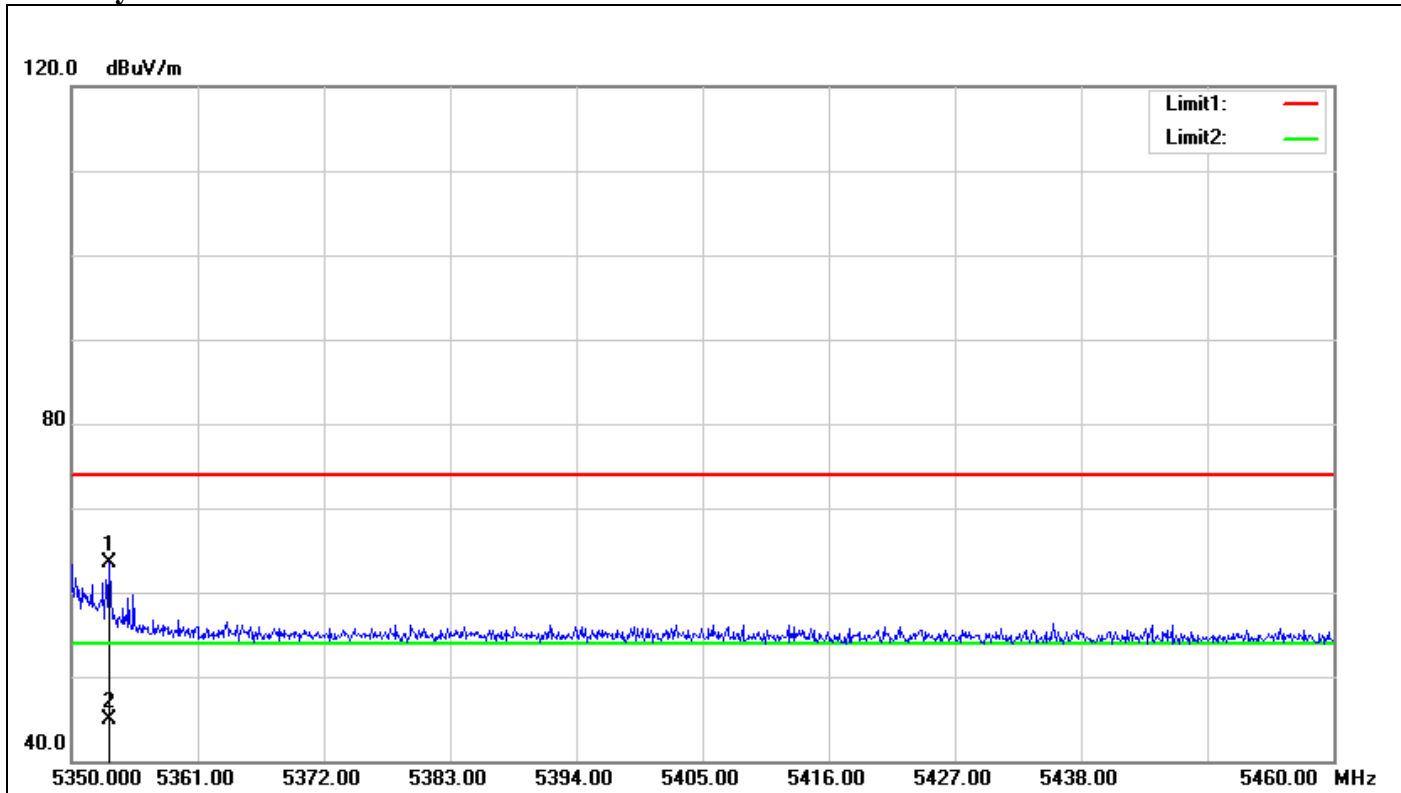

No.	Frequency (MHz)	Reading (dBuV)	Correct Factor(dB/m)	Result (dBuV/m)	Limit (dBuV/m)	Margin (dB)	Height (cm)	Degree (°)	Remark
1	5353.300	58.18	5.34	63.52	74.00	-10.48	100	177	peak
2	5353.300	39.53	5.34	44.87	54.00	-9.13	100	177	AVG



Band Edges (IEEE 802.11a mode / CH 5500 MHz)

Polarity: Vertical

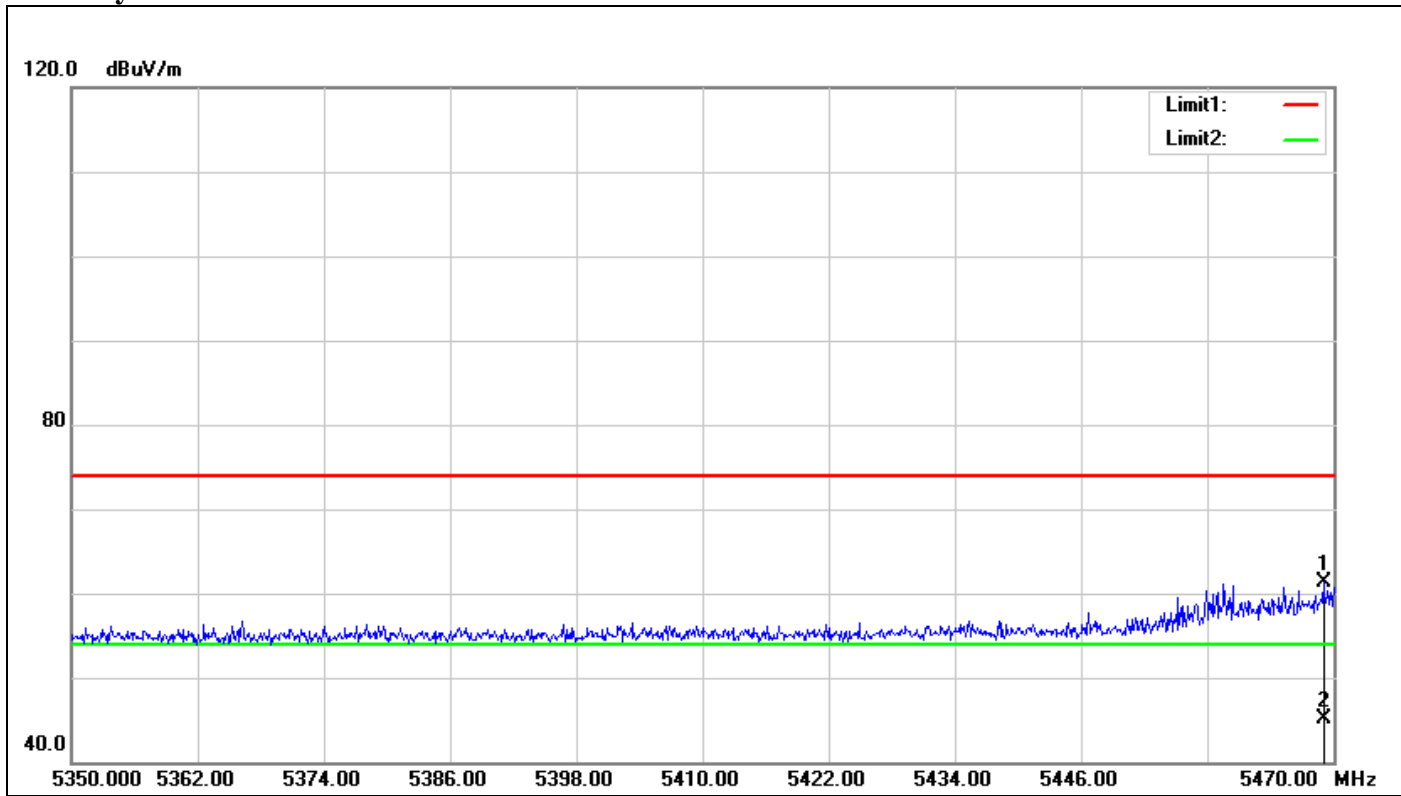

No.	Frequency (MHz)	Reading (dBuV)	Correct Factor(dB/m)	Result (dBuV/m)	Limit (dBuV/m)	Margin (dB)	Height (cm)	Degree (°)	Remark
1	5469.040	55.86	5.40	61.26	74.00	-12.74	100	255	peak
2	5469.040	39.67	5.40	45.07	54.00	-8.93	100	255	AVG



Polarity: Horizontal

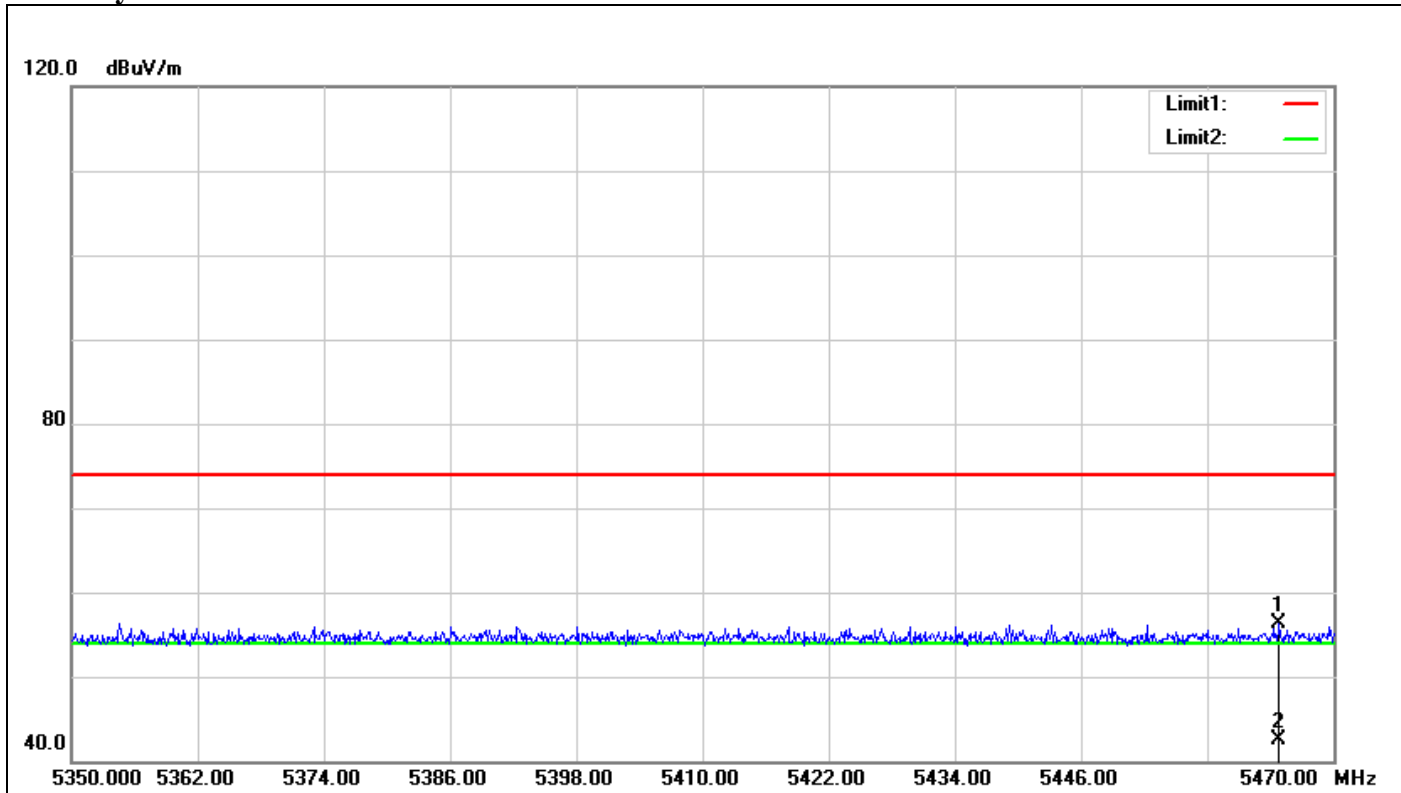

No.	Frequency (MHz)	Reading (dBuV)	Correct Factor(dB/m)	Result (dBuV/m)	Limit (dBuV/m)	Margin (dB)	Height (cm)	Degree (°)	Remark
1	5464.840	50.92	5.42	56.34	74.00	-17.66	100	204	peak
2	5464.840	37.09	5.42	42.51	54.00	-11.49	100	204	AVG



Band Edges (IEEE 802.11a mode / CH 5700 MHz)

Polarity: Vertical

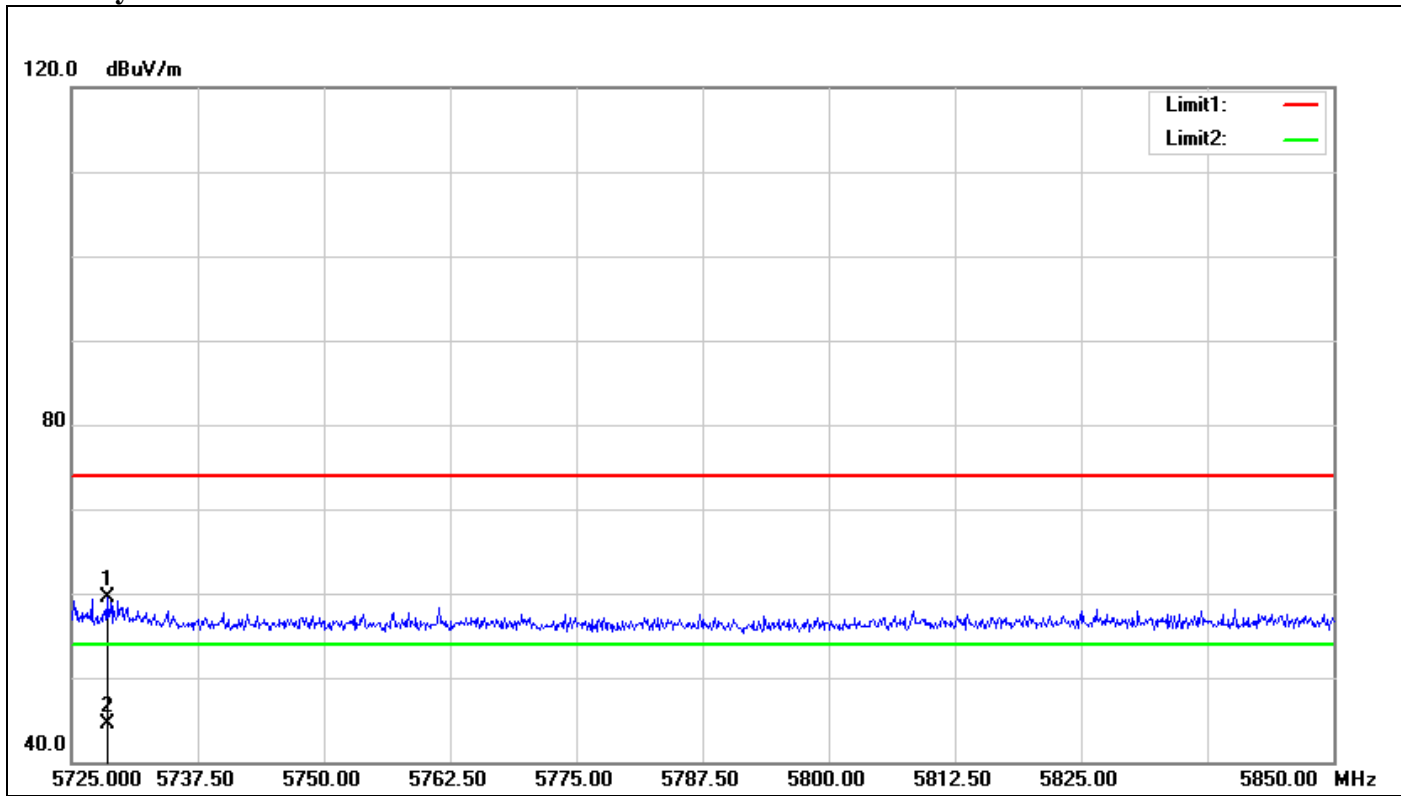

No.	Frequency (MHz)	Reading (dBuV)	Correct Factor(dB/m)	Result (dBuV/m)	Limit (dBuV/m)	Margin (dB)	Height (cm)	Degree (°)	Remark
1	5728.500	53.31	6.22	59.53	74.00	-14.47	100	282	peak
2	5728.500	38.31	6.22	44.53	54.00	-9.47	100	282	AVG



Polarity: Horizontal

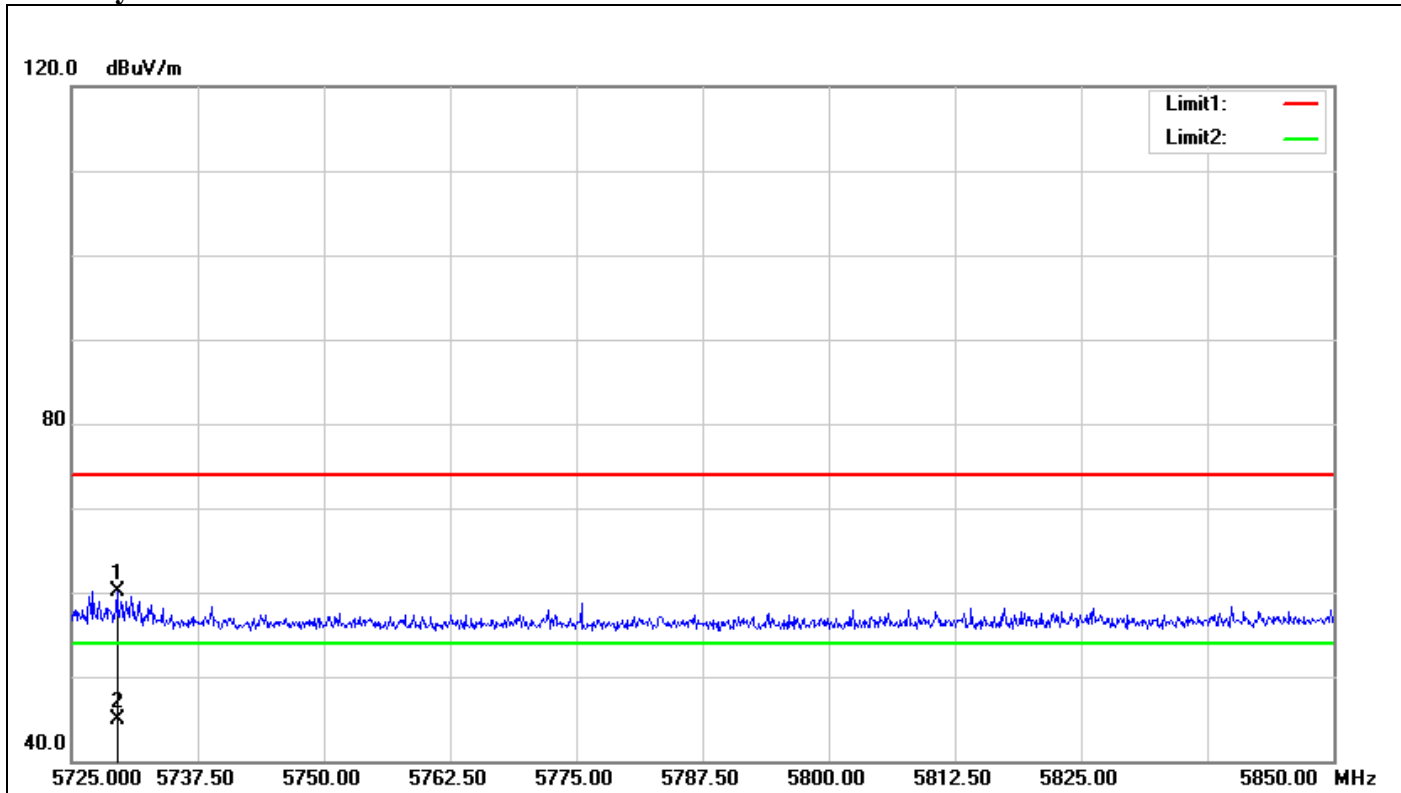

No.	Frequency (MHz)	Reading (dBuV)	Correct Factor(dB/m)	Result (dBuV/m)	Limit (dBuV/m)	Margin (dB)	Height (cm)	Degree (°)	Remark
1	5729.500	53.83	6.23	60.06	74.00	-13.94	100	329	peak
2	5729.500	38.60	6.23	44.83	54.00	-9.17	100	329	AVG



Band Edges (IEEE 802.11n HT 20 MHz Channel mode / CH 5180 MHz)

Polarity: Vertical

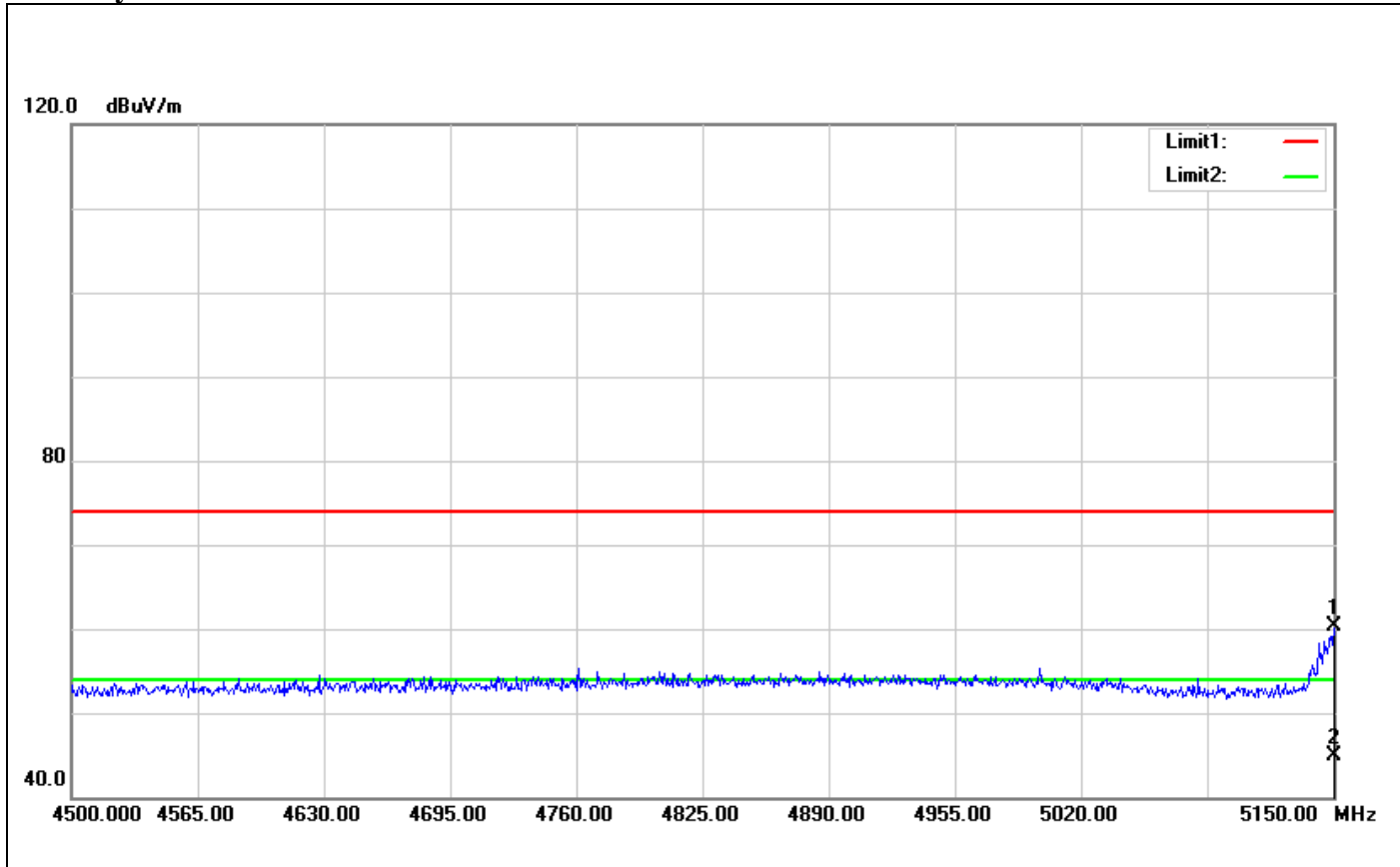

No.	Frequency (MHz)	Reading (dBuV)	Correct Factor(dB/m)	Result (dBuV/m)	Limit (dBuV/m)	Margin (dB)	Height (cm)	Degree (°)	Remark
1	5150.000	57.26	3.04	60.30	74.00	-13.70	100	236	peak
2	5150.000	41.80	3.04	44.84	54.00	-9.16	100	236	AVG



Polarity: Horizontal

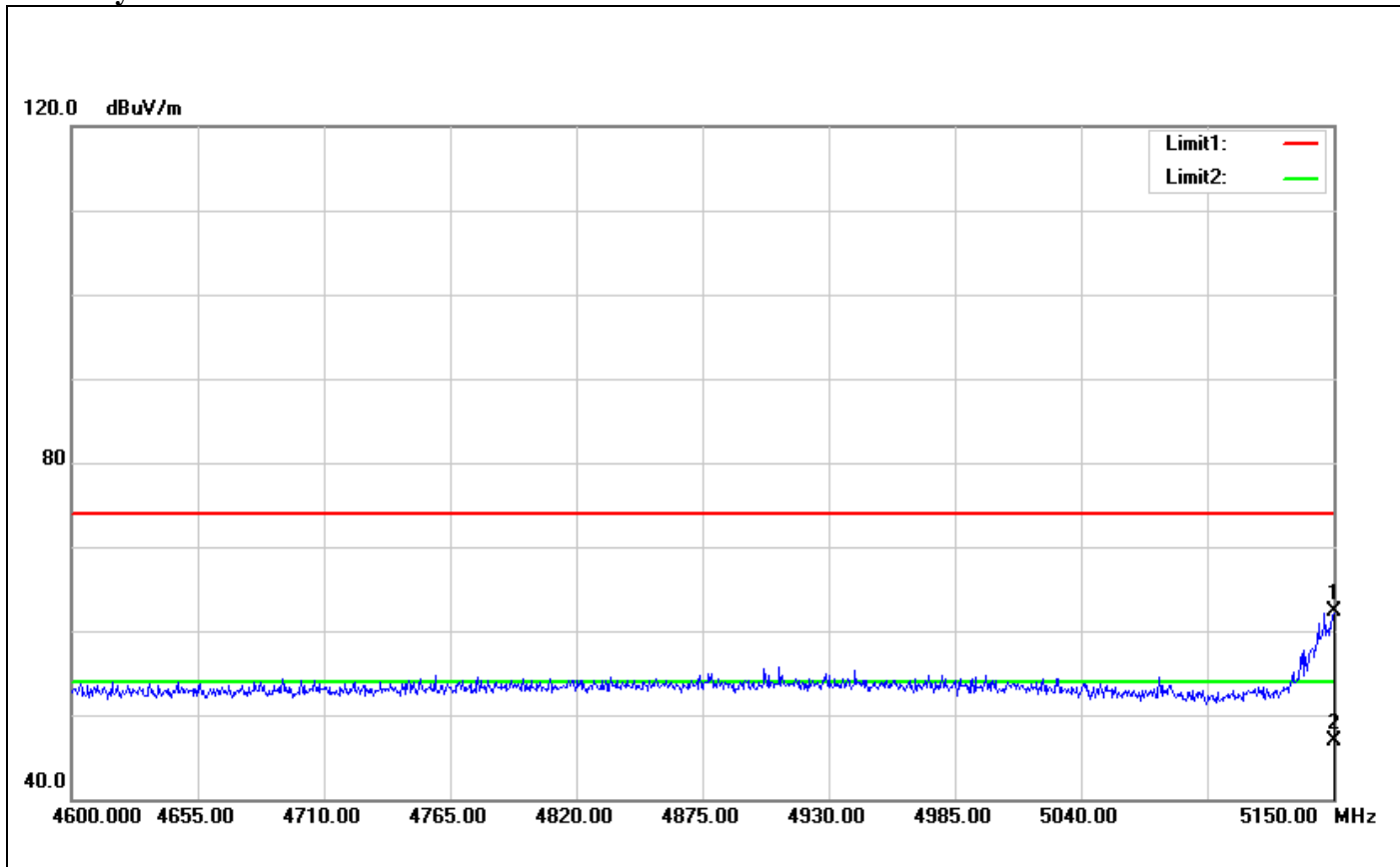

No.	Frequency (MHz)	Reading (dBuV)	Correct Factor(dB/m)	Result (dBuV/m)	Limit (dBuV/m)	Margin (dB)	Height (cm)	Degree (°)	Remark
1	5150.000	59.30	3.04	62.34	74.00	-11.66	100	102	peak
2	5150.000	43.89	3.04	46.93	54.00	-7.07	100	102	AVG



Band Edges (IEEE 802.11n HT 20 MHz Channel mode / CH 5320 MHz)

Polarity: Vertical

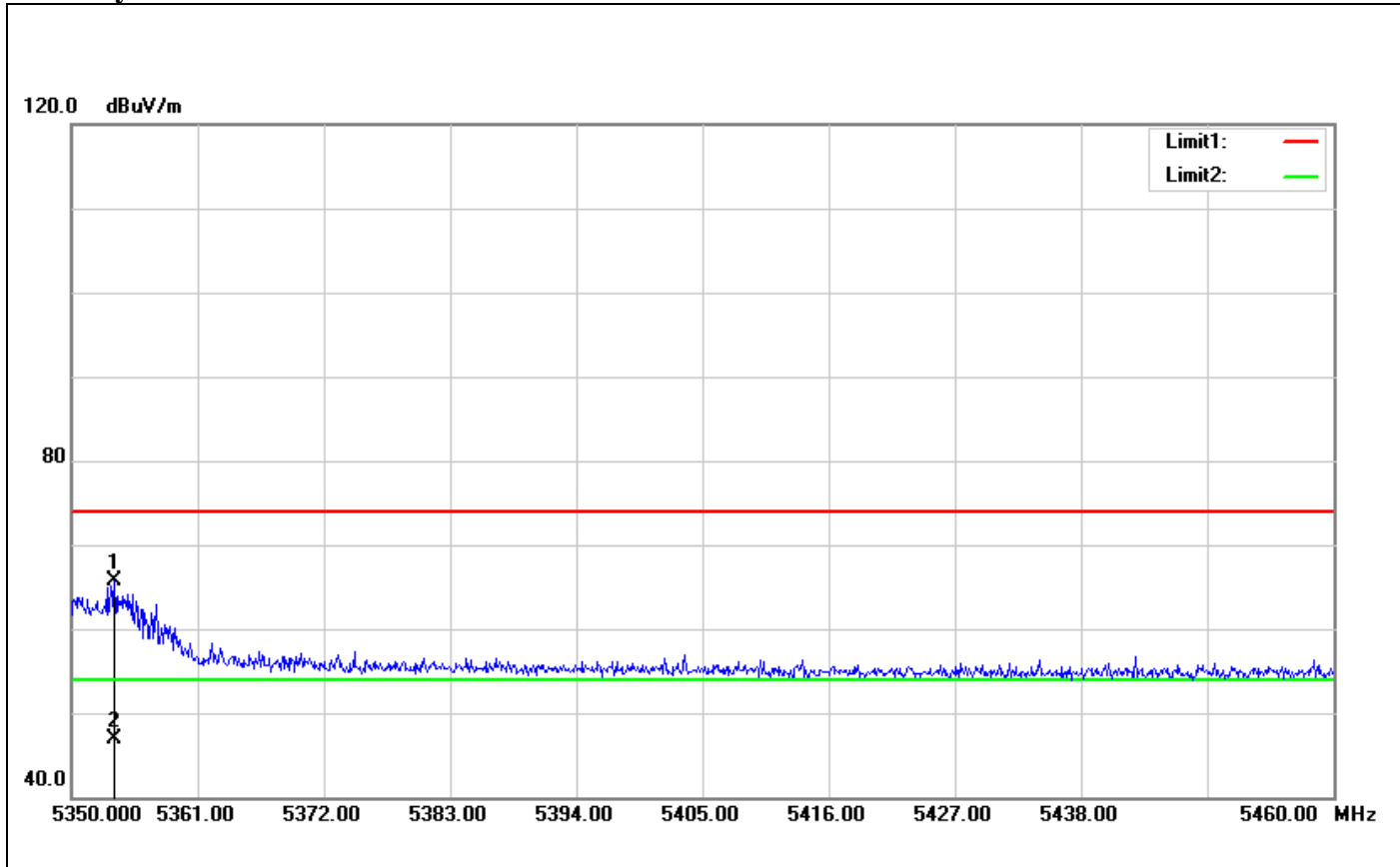

No.	Frequency (MHz)	Reading (dBuV)	Correct Factor(dB/m)	Result (dBuV/m)	Limit (dBuV/m)	Margin (dB)	Height (cm)	Degree (°)	Remark
1	5353.740	60.46	5.34	65.80	74.00	-8.20	100	109	peak
2	5353.740	41.62	5.34	46.96	54.00	-7.04	100	109	AVG



Polarity: Horizontal

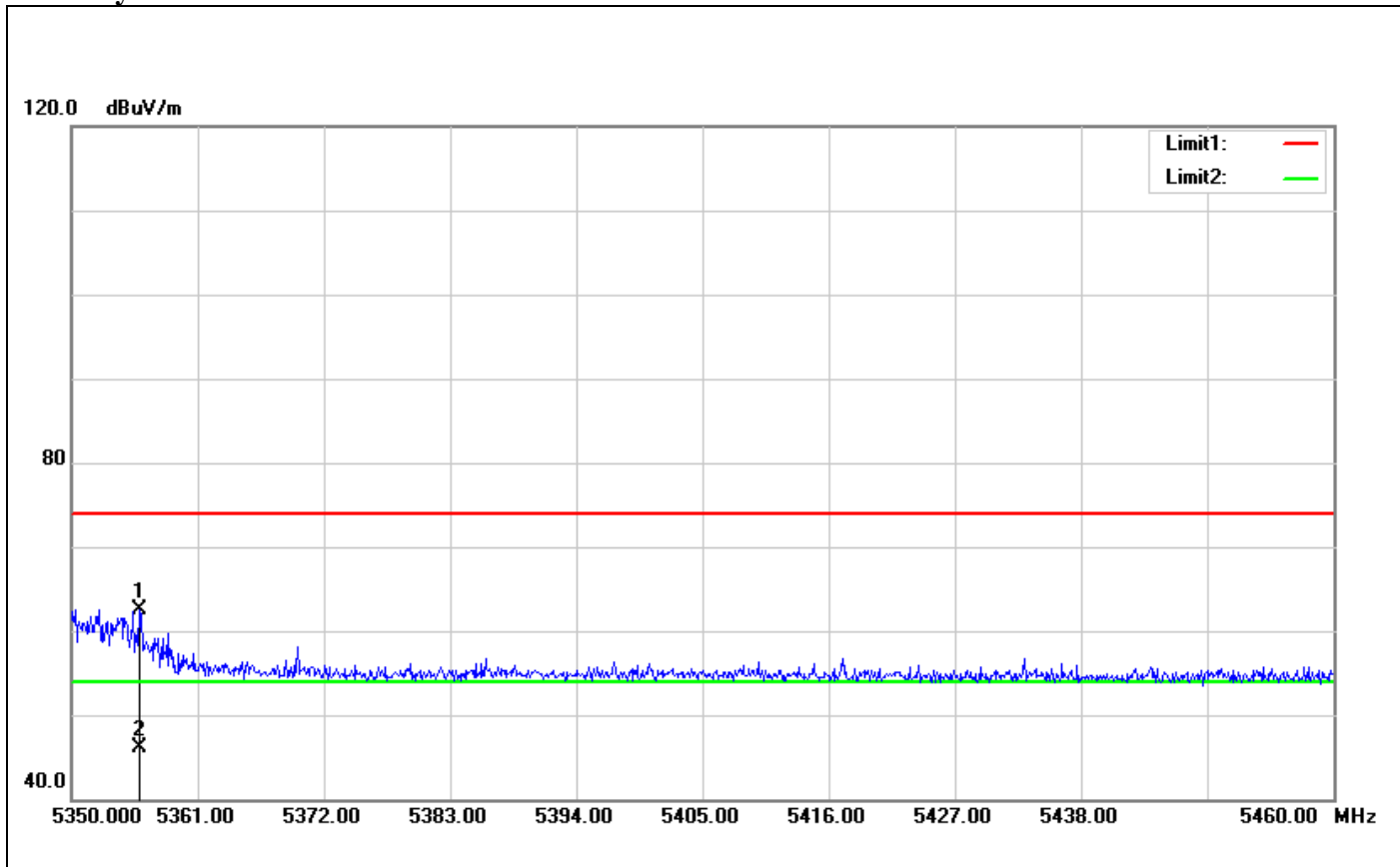

No.	Frequency (MHz)	Reading (dBuV)	Correct Factor(dB/m)	Result (dBuV/m)	Limit (dBuV/m)	Margin (dB)	Height (cm)	Degree (°)	Remark
1	5355.940	57.12	5.36	62.48	74.00	-11.52	100	149	peak
2	5355.940	40.66	5.36	46.02	54.00	-7.98	100	149	AVG



Band Edges (IEEE 802.11n HT 20 MHz Channel mode / CH 5500 MHz)

Polarity: Vertical

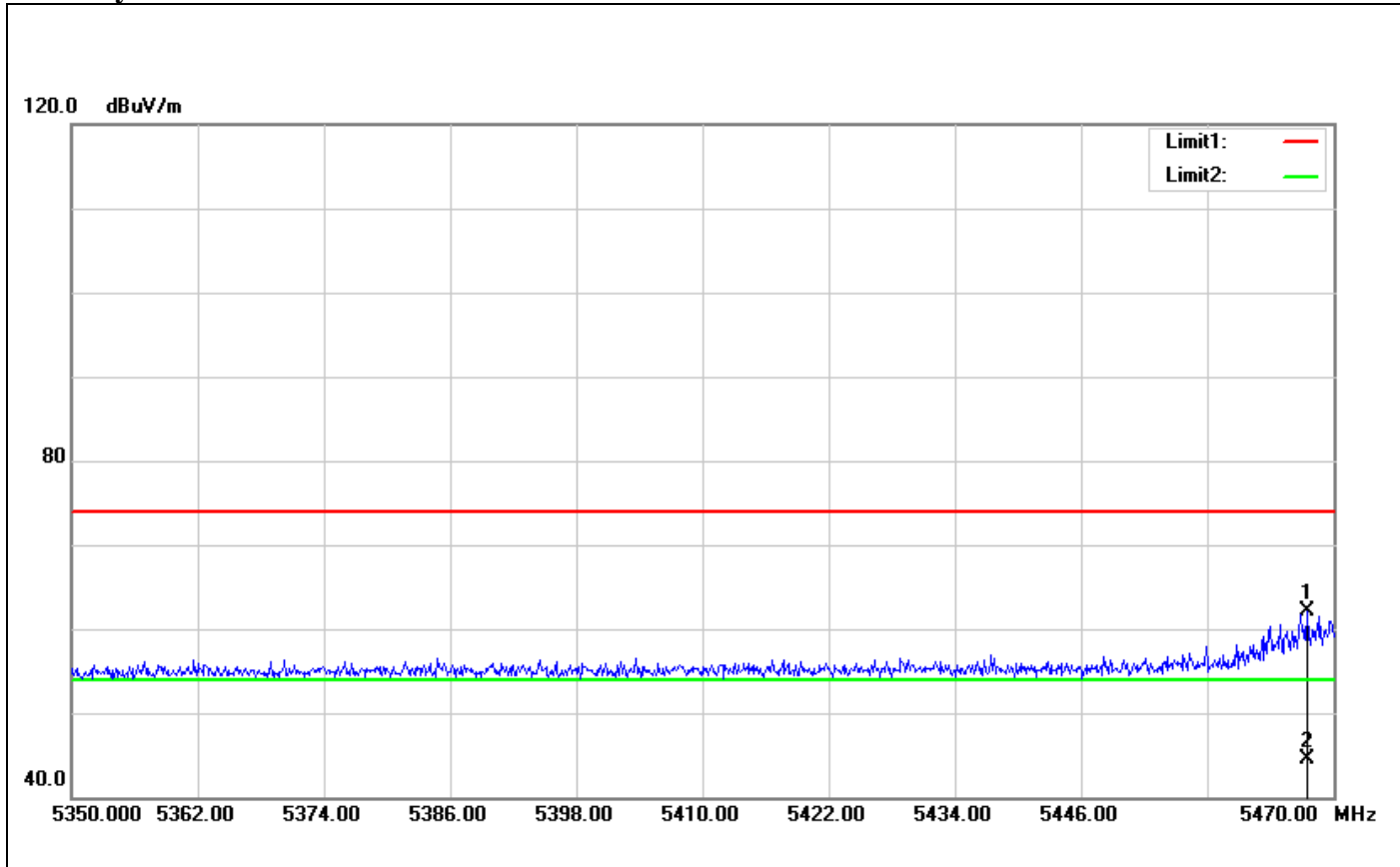

No.	Frequency (MHz)	Reading (dBuV)	Correct Factor(dB/m)	Result (dBuV/m)	Limit (dBuV/m)	Margin (dB)	Height (cm)	Degree (°)	Remark
1	5467.480	56.61	5.40	62.01	74.00	-11.99	100	278	peak
2	5467.480	39.15	5.40	44.55	54.00	-9.45	100	278	AVG



Polarity: Horizontal

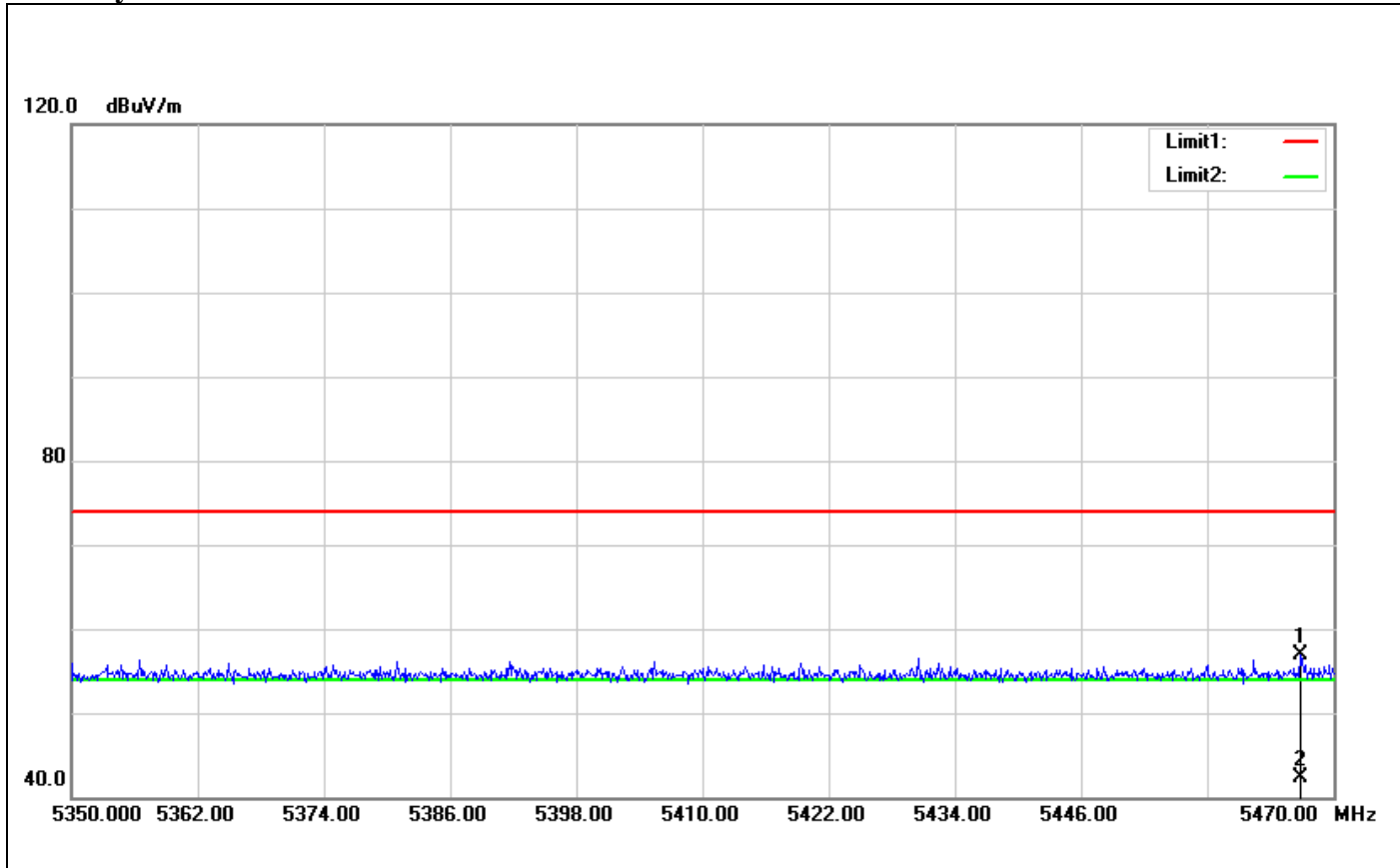

No.	Frequency (MHz)	Reading (dBuV)	Correct Factor(dB/m)	Result (dBuV/m)	Limit (dBuV/m)	Margin (dB)	Height (cm)	Degree (°)	Remark
1	5466.880	51.53	5.41	56.94	74.00	-17.06	100	244	peak
2	5466.880	36.89	5.41	42.30	54.00	-11.70	100	244	AVG



Band Edges (IEEE 802.11n HT 20 MHz Channel mode / CH 5700 MHz)

Polarity: Vertical

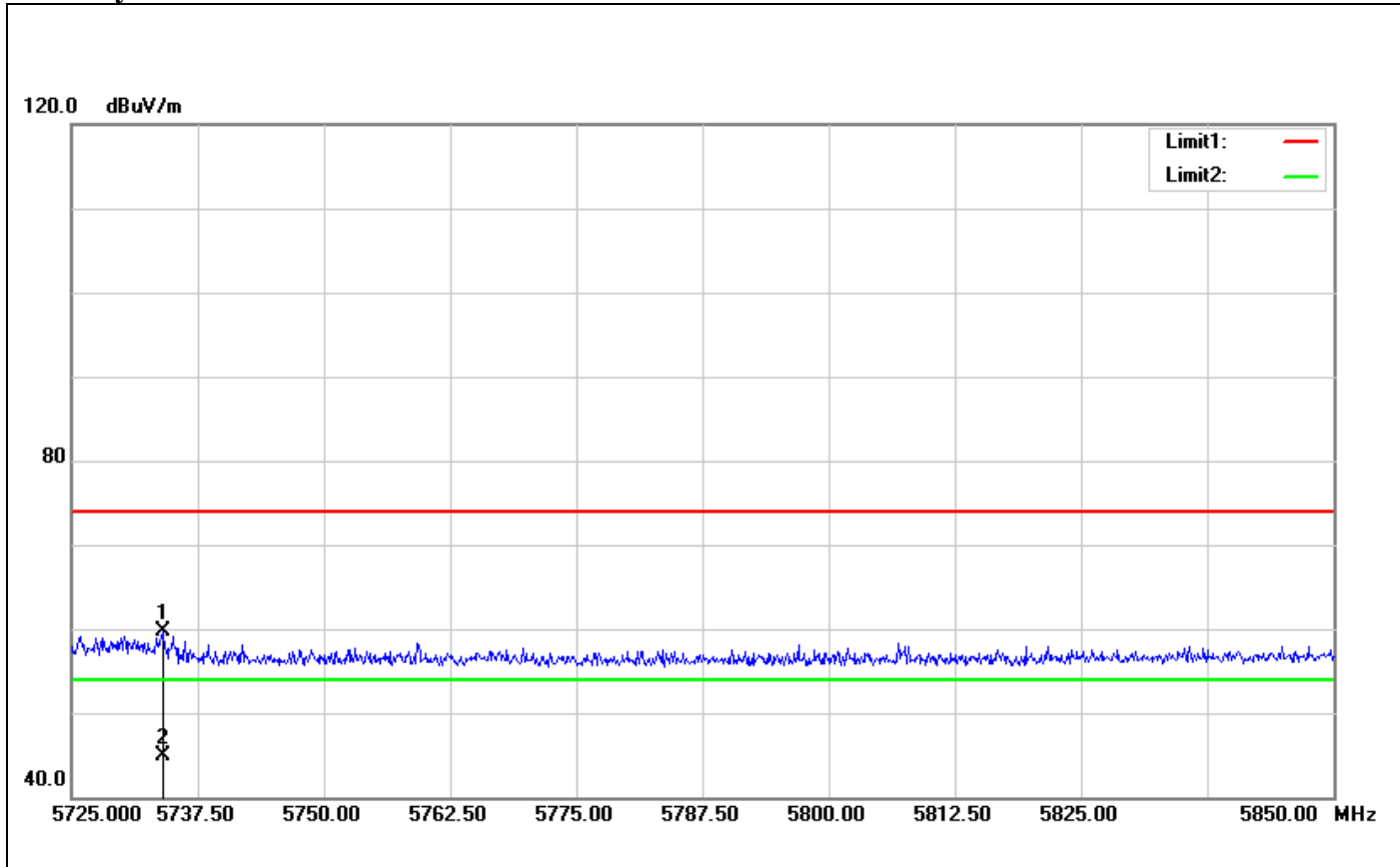

No.	Frequency (MHz)	Reading (dBuV)	Correct Factor(dB/m)	Result (dBuV/m)	Limit (dBuV/m)	Margin (dB)	Height (cm)	Degree (°)	Remark
1	5734.125	53.38	6.25	59.63	74.00	-14.37	100	200	peak
2	5734.125	38.74	6.25	44.99	54.00	-9.01	100	200	AVG



Polarity: Horizontal

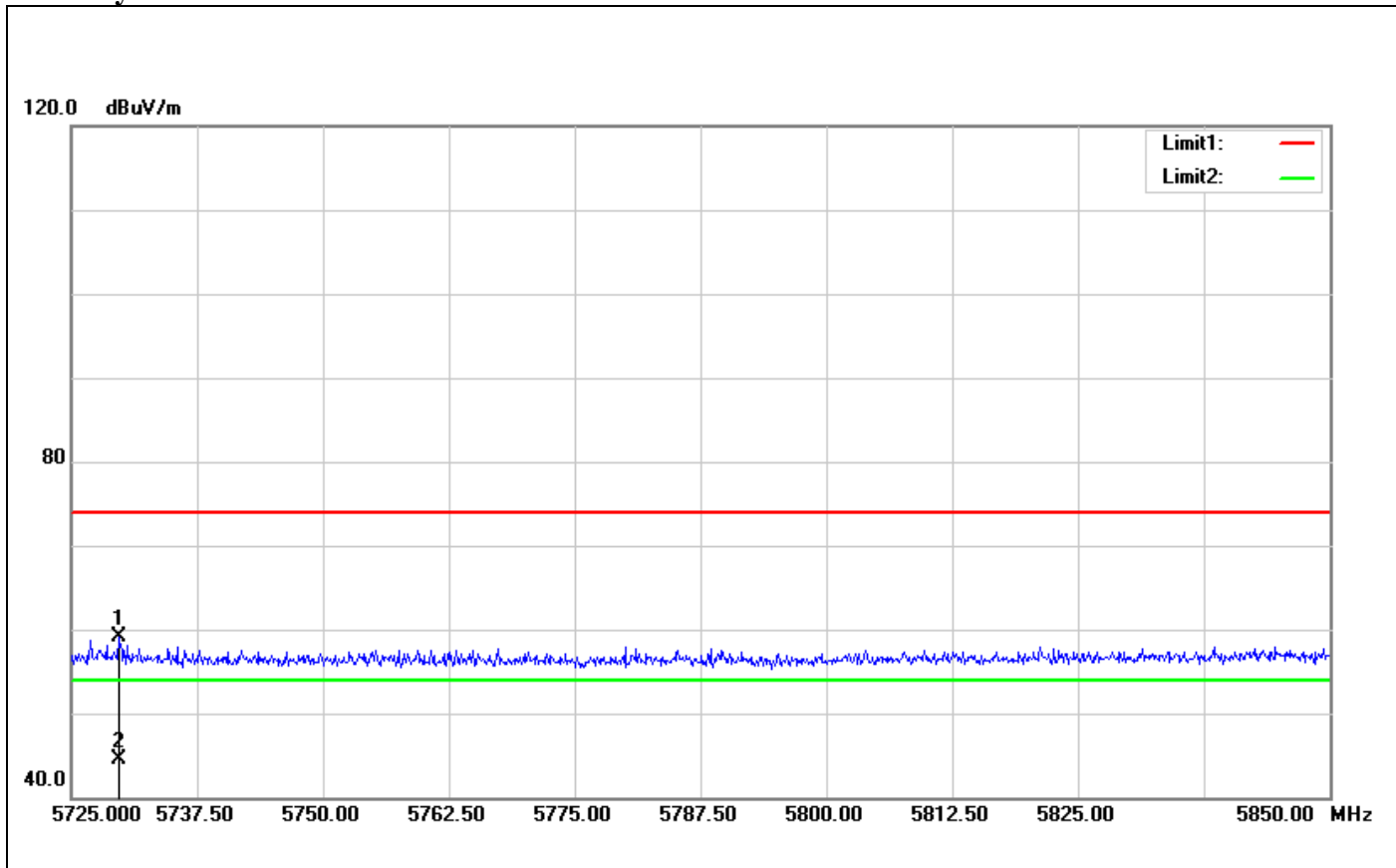

No.	Frequency (MHz)	Reading (dBuV)	Correct Factor(dB/m)	Result (dBuV/m)	Limit (dBuV/m)	Margin (dB)	Height (cm)	Degree (°)	Remark
1	5729.750	52.82	6.23	59.05	74.00	-14.95	100	11	peak
2	5729.750	38.24	6.23	44.47	54.00	-9.53	100	11	AVG



Band Edges (IEEE 802.11n HT 40 MHz mode / CH 5190 MHz)

Polarity: Vertical

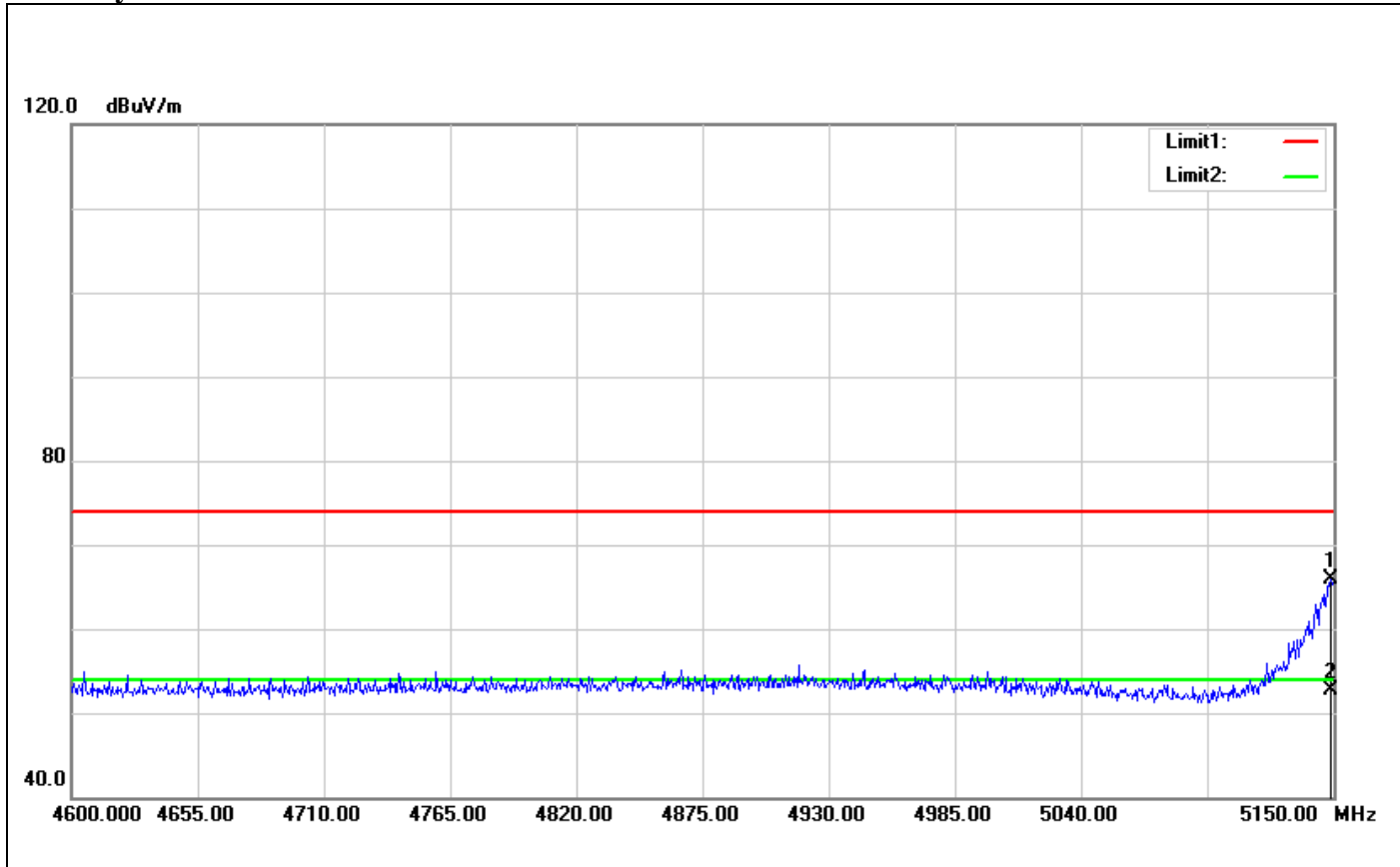

No.	Frequency (MHz)	Reading (dBuV)	Correct Factor(dB/m)	Result (dBuV/m)	Limit (dBuV/m)	Margin (dB)	Height (cm)	Degree (°)	Remark
1	5148.900	62.89	3.03	65.92	74.00	-8.08	100	145	peak
2	5148.900	49.74	3.03	52.77	54.00	-1.23	100	145	AVG



Polarity: Horizontal

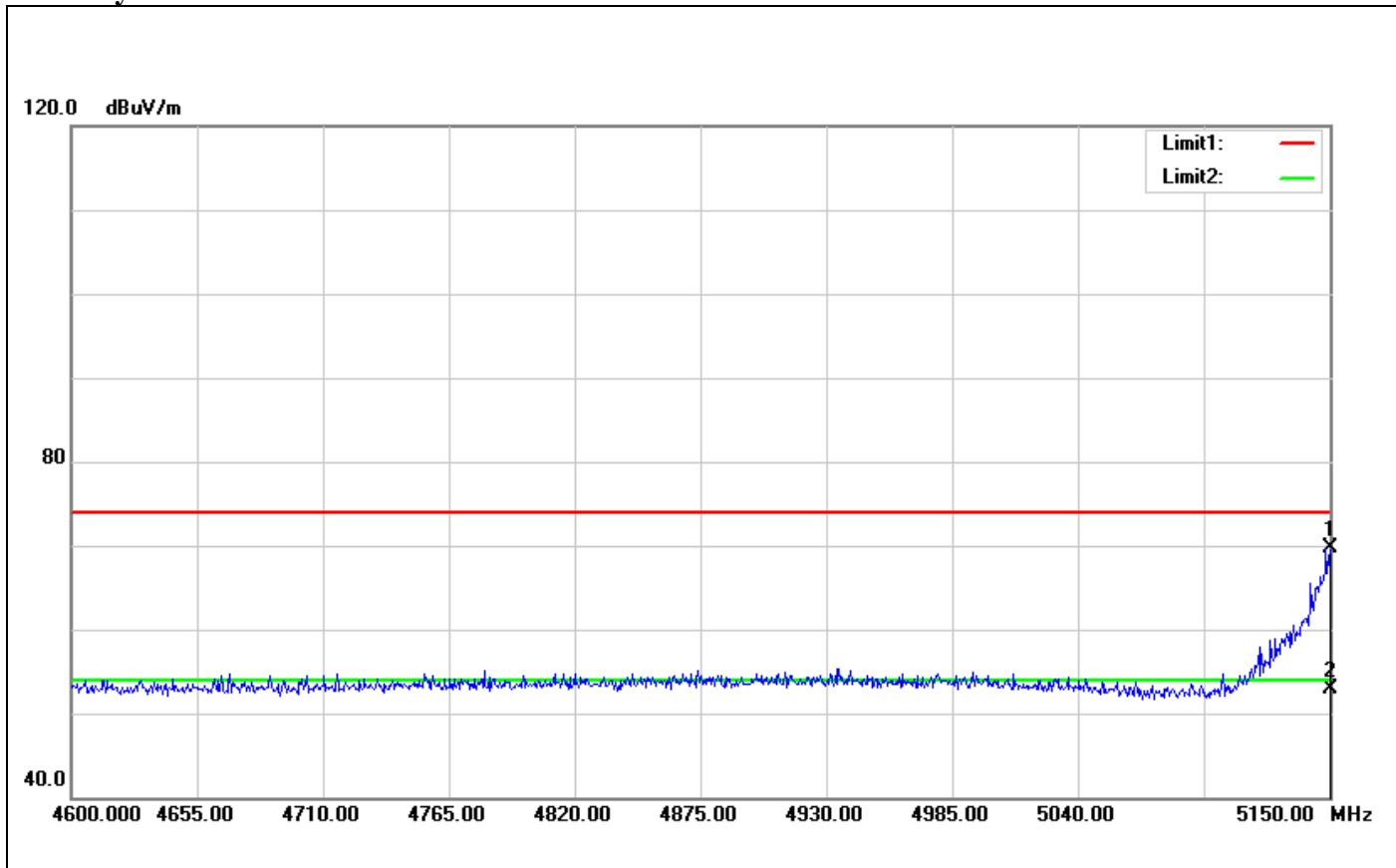

No.	Frequency (MHz)	Reading (dBuV)	Correct Factor(dB/m)	Result (dBuV/m)	Limit (dBuV/m)	Margin (dB)	Height (cm)	Degree (°)	Remark
1	5150.000	66.75	3.04	69.79	74.00	-4.21	100	235	peak
2	5150.000	49.86	3.04	52.90	54.00	-1.10	100	235	AVG



Band Edges (IEEE 802.11n HT 40 MHz mode / CH 5310 MHz)

Polarity: Vertical

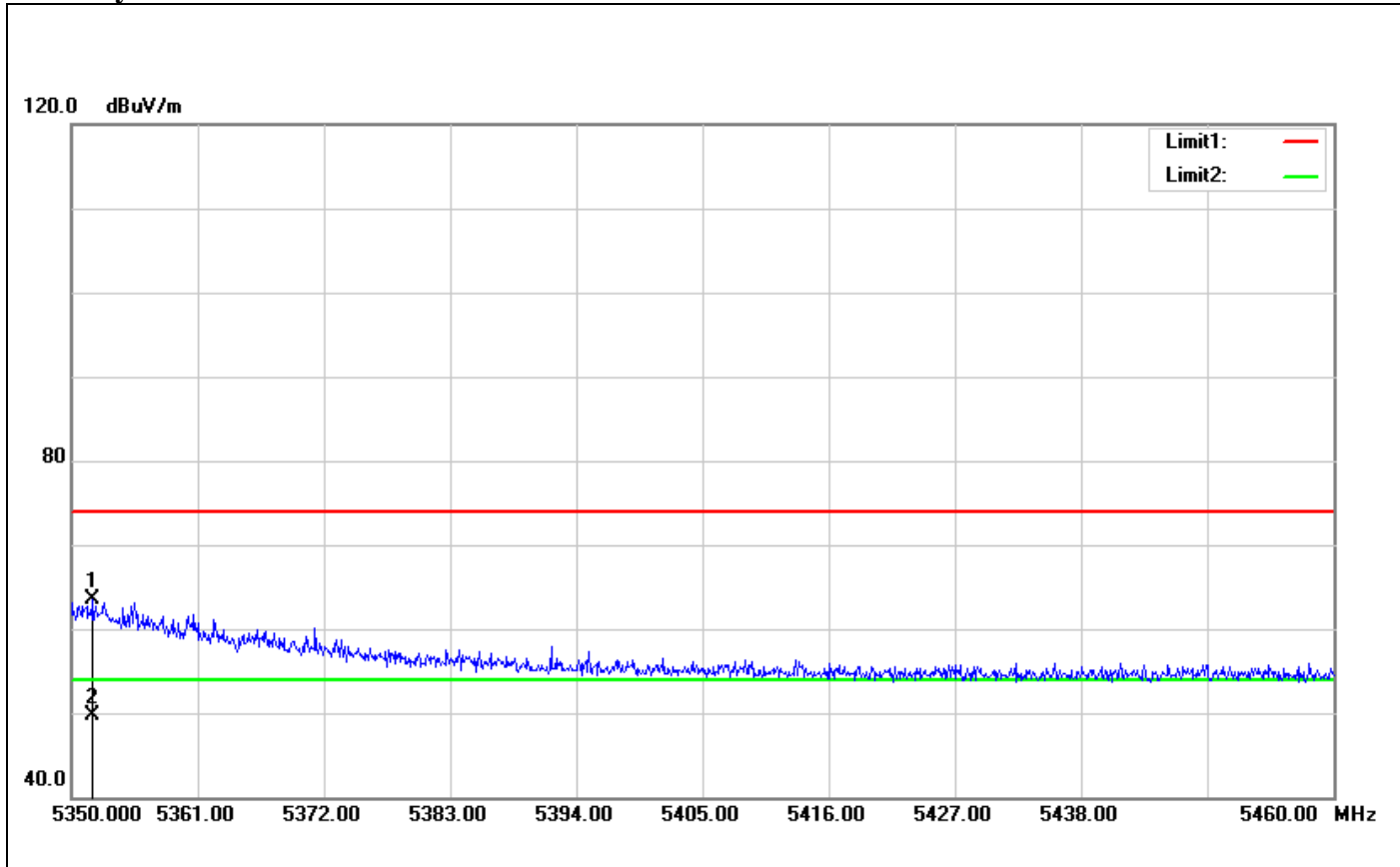

No.	Frequency (MHz)	Reading (dBuV)	Correct Factor(dB/m)	Result (dBuV/m)	Limit (dBuV/m)	Margin (dB)	Height (cm)	Degree (°)	Remark
1	5351.870	58.10	5.33	63.43	74.00	-10.57	100	254	peak
2	5351.870	44.37	5.33	49.70	54.00	-4.30	100	254	AVG



Polarity: Horizontal

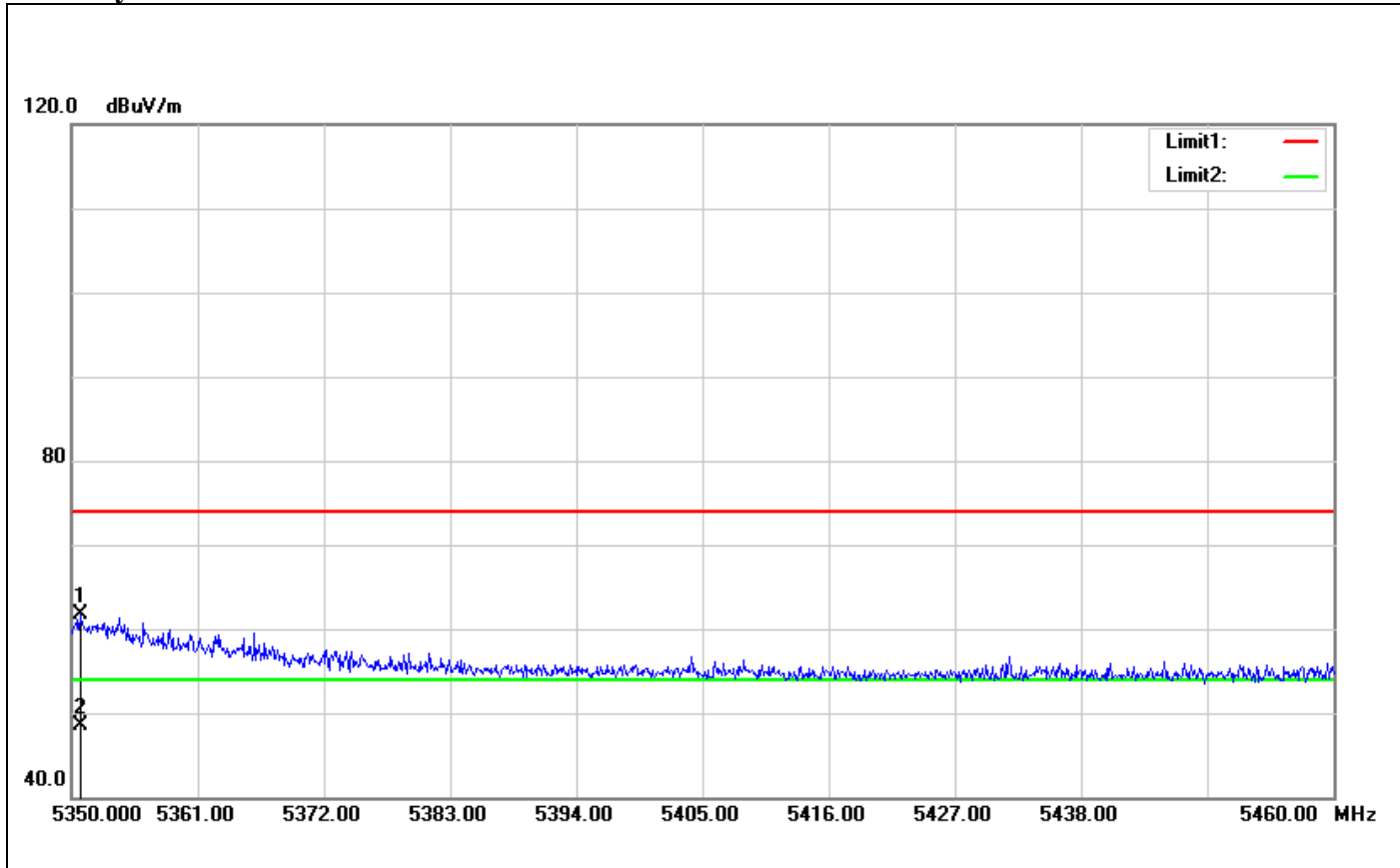

No.	Frequency (MHz)	Reading (dBuV)	Correct Factor(dB/m)	Result (dBuV/m)	Limit (dBuV/m)	Margin (dB)	Height (cm)	Degree (°)	Remark
1	5350.770	56.43	5.32	61.75	74.00	-12.25	100	287	peak
2	5350.770	43.10	5.32	48.42	54.00	-5.58	100	287	AVG



Band Edges (IEEE 802.11n HT 40 MHz mode / CH 5510 MHz)

Polarity: Vertical

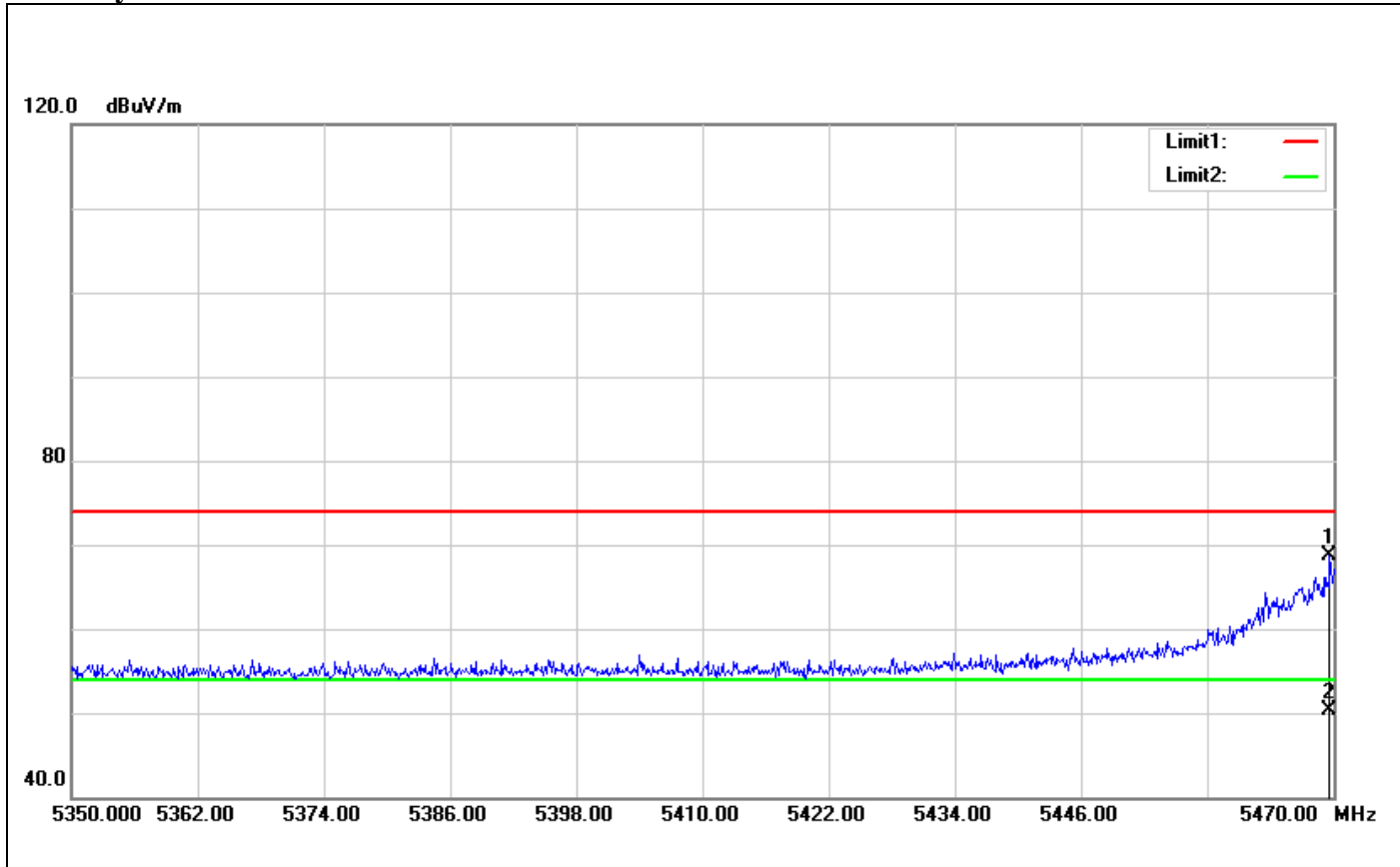

No.	Frequency (MHz)	Reading (dBuV)	Correct Factor(dB/m)	Result (dBuV/m)	Limit (dBuV/m)	Margin (dB)	Height (cm)	Degree (°)	Remark
1	5469.640	63.27	5.39	68.66	74.00	-5.34	100	162	peak
2	5469.640	45.00	5.39	50.39	54.00	-3.61	100	162	AVG



Polarity: Horizontal

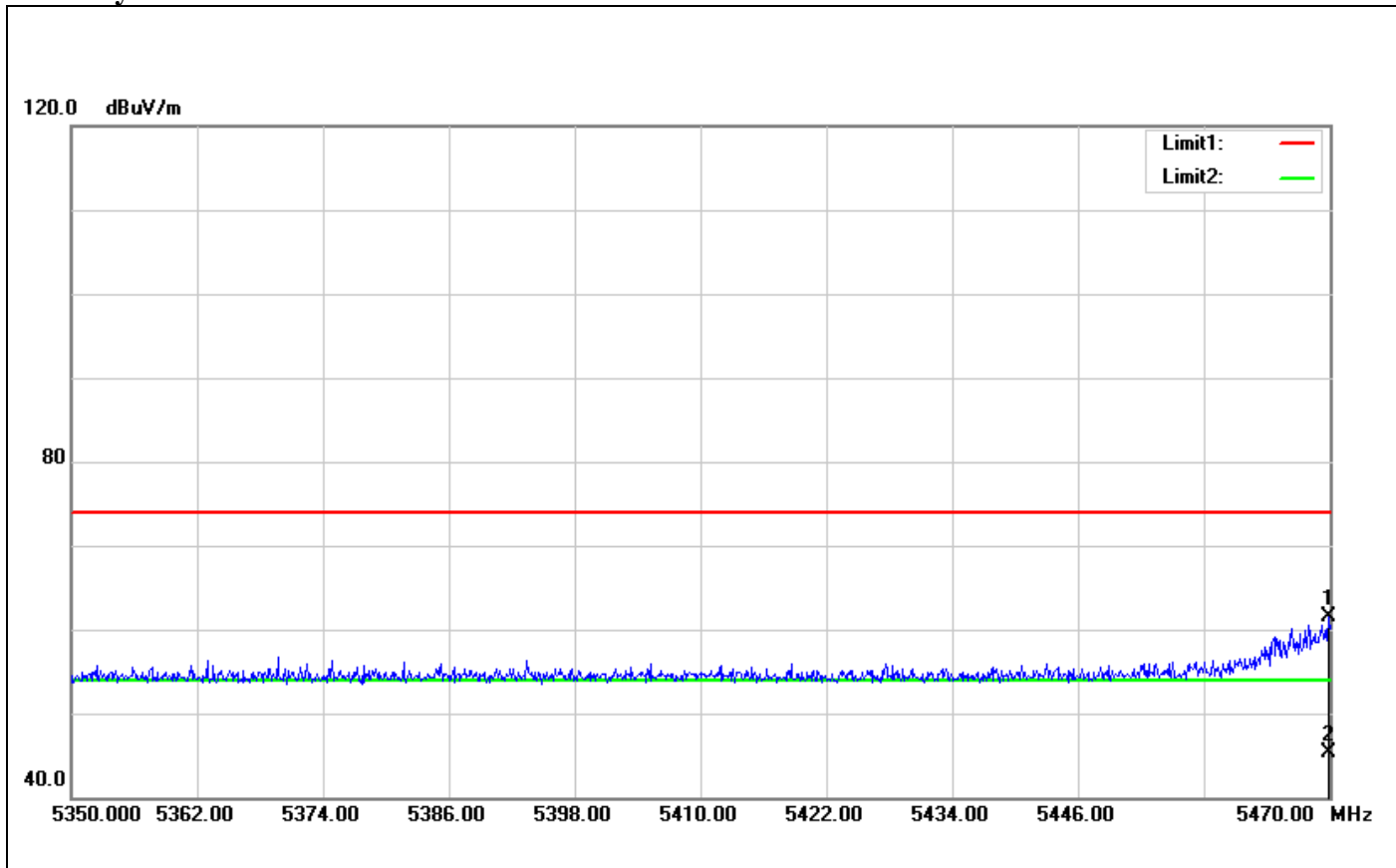

No.	Frequency (MHz)	Reading (dBuV)	Correct Factor(dB/m)	Result (dBuV/m)	Limit (dBuV/m)	Margin (dB)	Height (cm)	Degree (°)	Remark
1	5469.880	56.09	5.39	61.48	74.00	-12.52	100	357	peak
2	5469.880	40.01	5.39	45.40	54.00	-8.60	100	357	AVG



Band Edges (IEEE 802.11n HT 40 MHz mode / CH 5670 MHz)

Polarity: Vertical

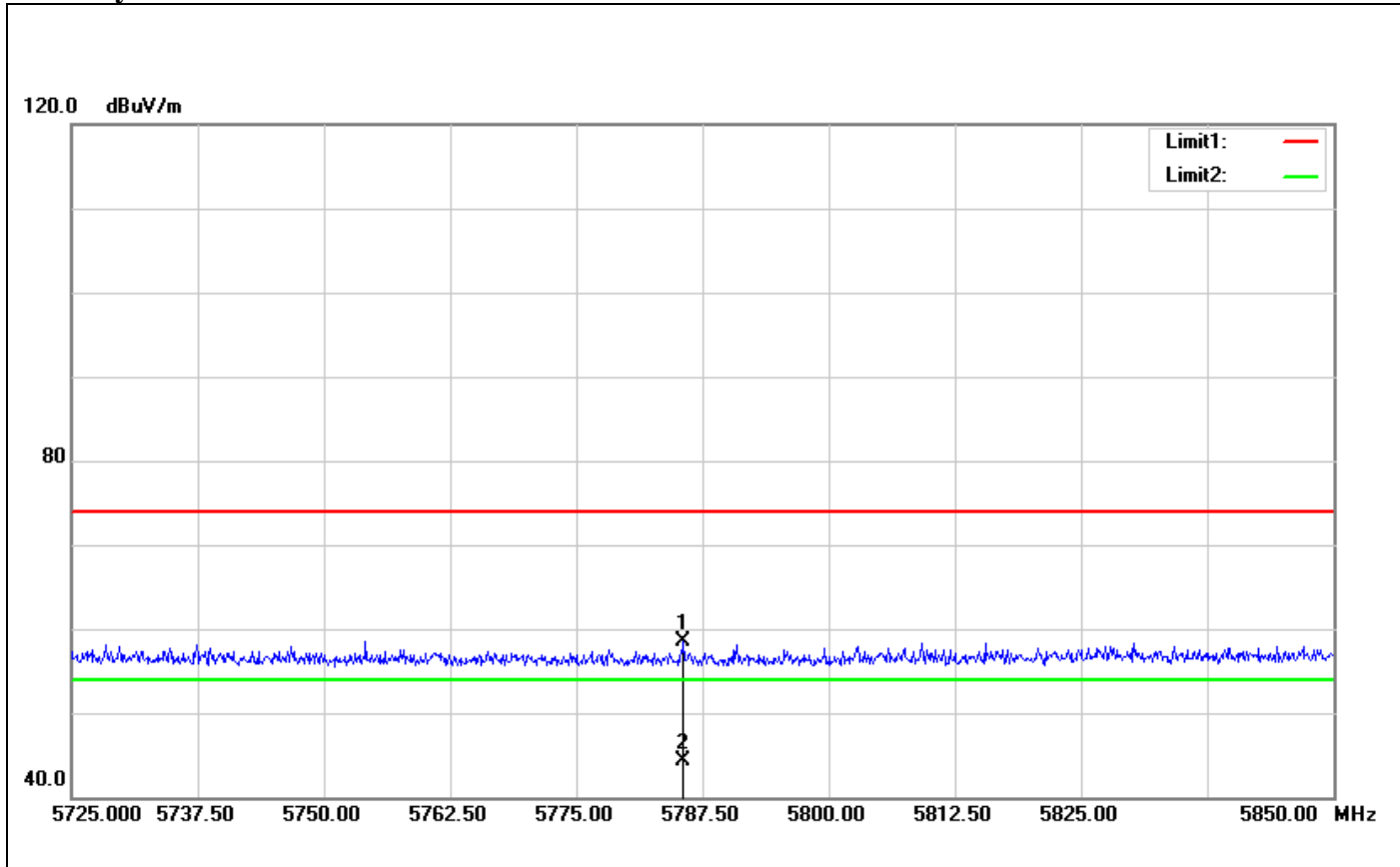

No.	Frequency (MHz)	Reading (dBuV)	Correct Factor(dB/m)	Result (dBuV/m)	Limit (dBuV/m)	Margin (dB)	Height (cm)	Degree (°)	Remark
1	5785.625	52.09	6.47	58.56	74.00	-15.44	100	9	peak
2	5785.625	37.91	6.47	44.38	54.00	-9.62	100	9	AVG



Polarity: Horizontal

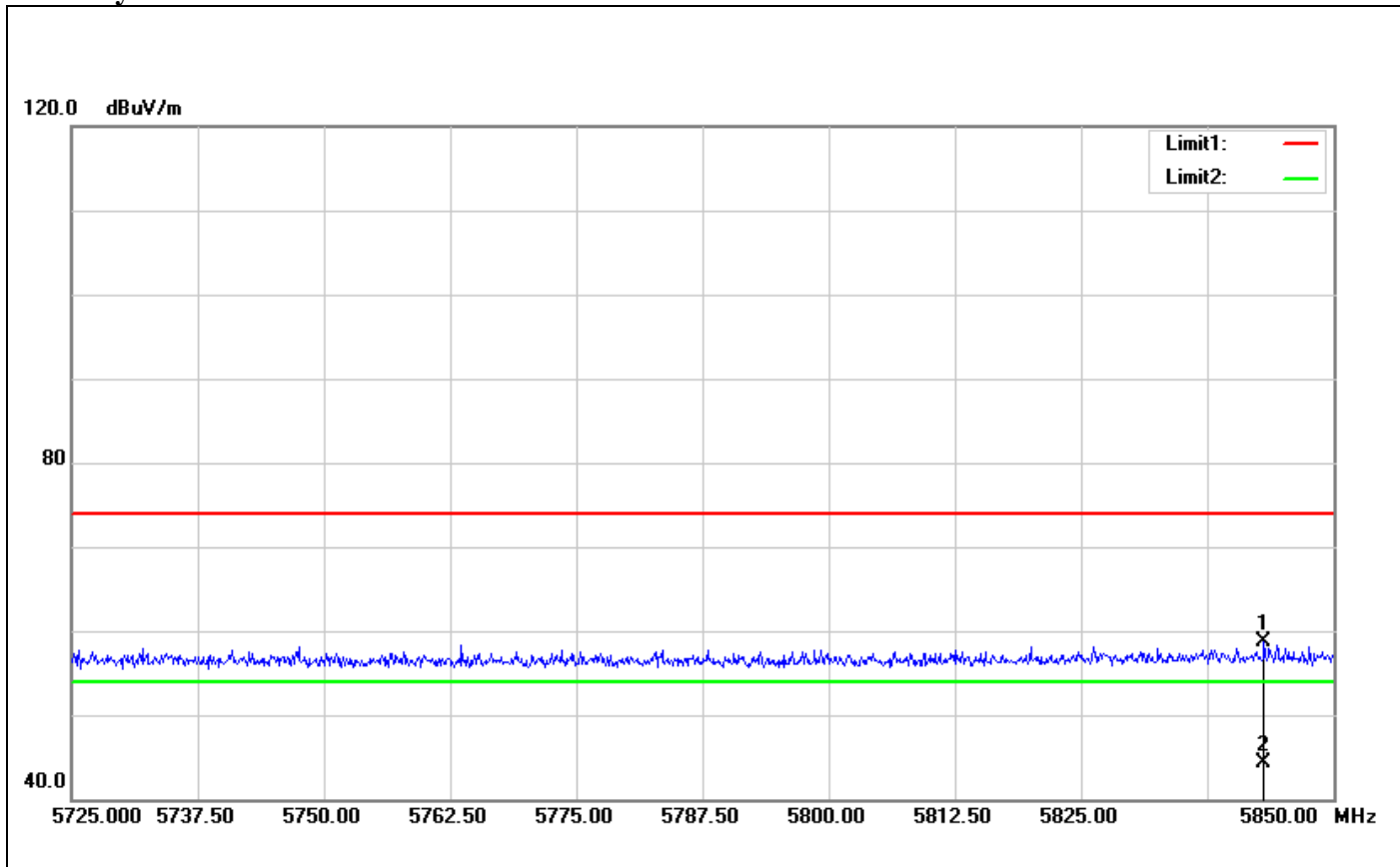

No.	Frequency (MHz)	Reading (dBuV)	Correct Factor(dB/m)	Result (dBuV/m)	Limit (dBuV/m)	Margin (dB)	Height (cm)	Degree (°)	Remark
1	5843.125	51.90	6.71	58.61	74.00	-15.39	100	104	peak
2	5843.125	37.54	6.71	44.25	54.00	-9.75	100	104	AVG



Band Edges (IEEE 802.11ac VHT 80 MHz mode / CH 5210 MHz)

Polarity: Vertical

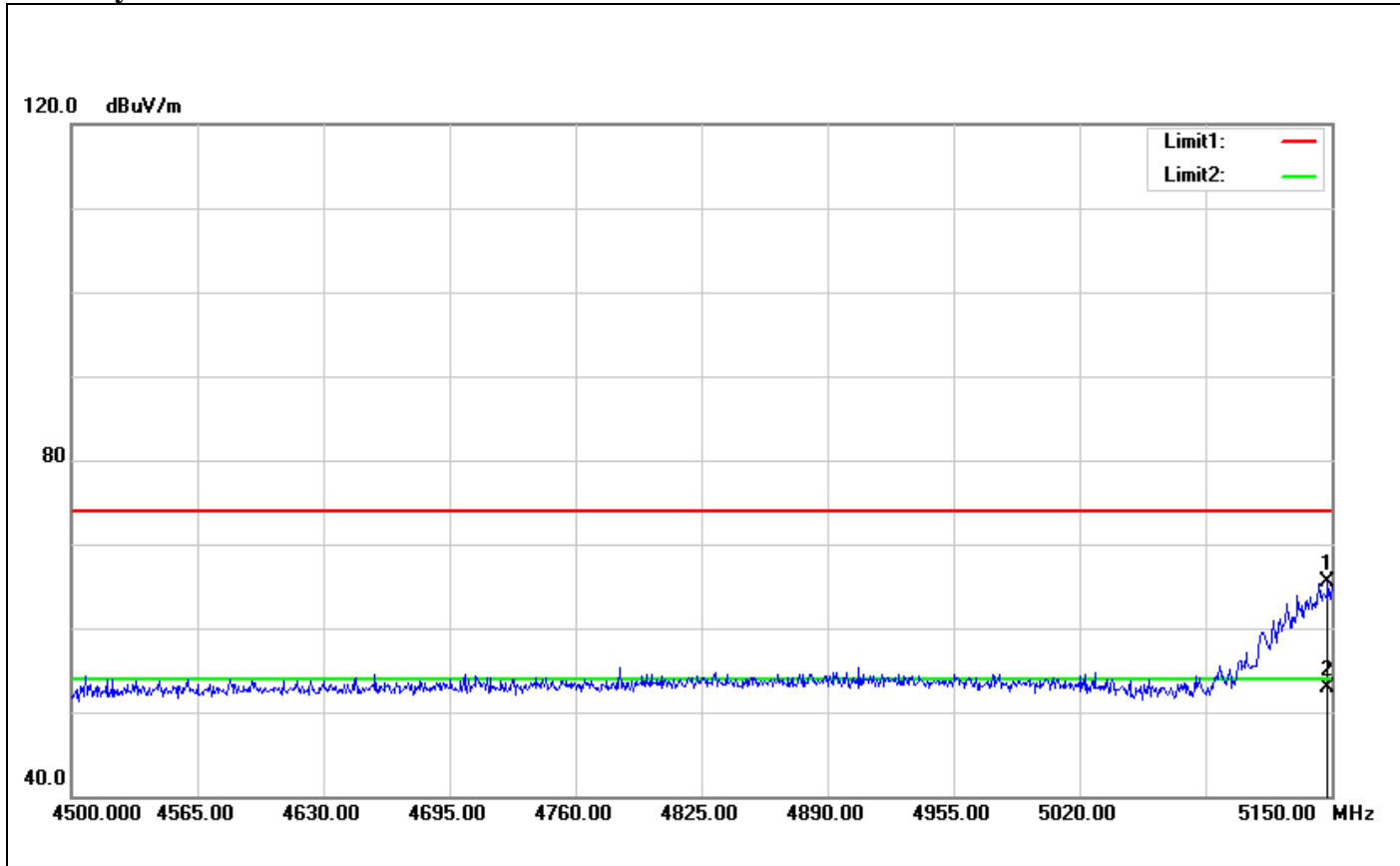

No.	Frequency (MHz)	Reading (dBuV)	Correct Factor(dB/m)	Result (dBuV/m)	Limit (dBuV/m)	Margin (dB)	Height (cm)	Degree (°)	Remark
1	5148.050	62.57	3.03	65.60	74.00	-8.40	100	255	peak
2	5148.050	49.94	3.03	52.97	54.00	-1.03	100	255	AVG



Polarity: Horizontal

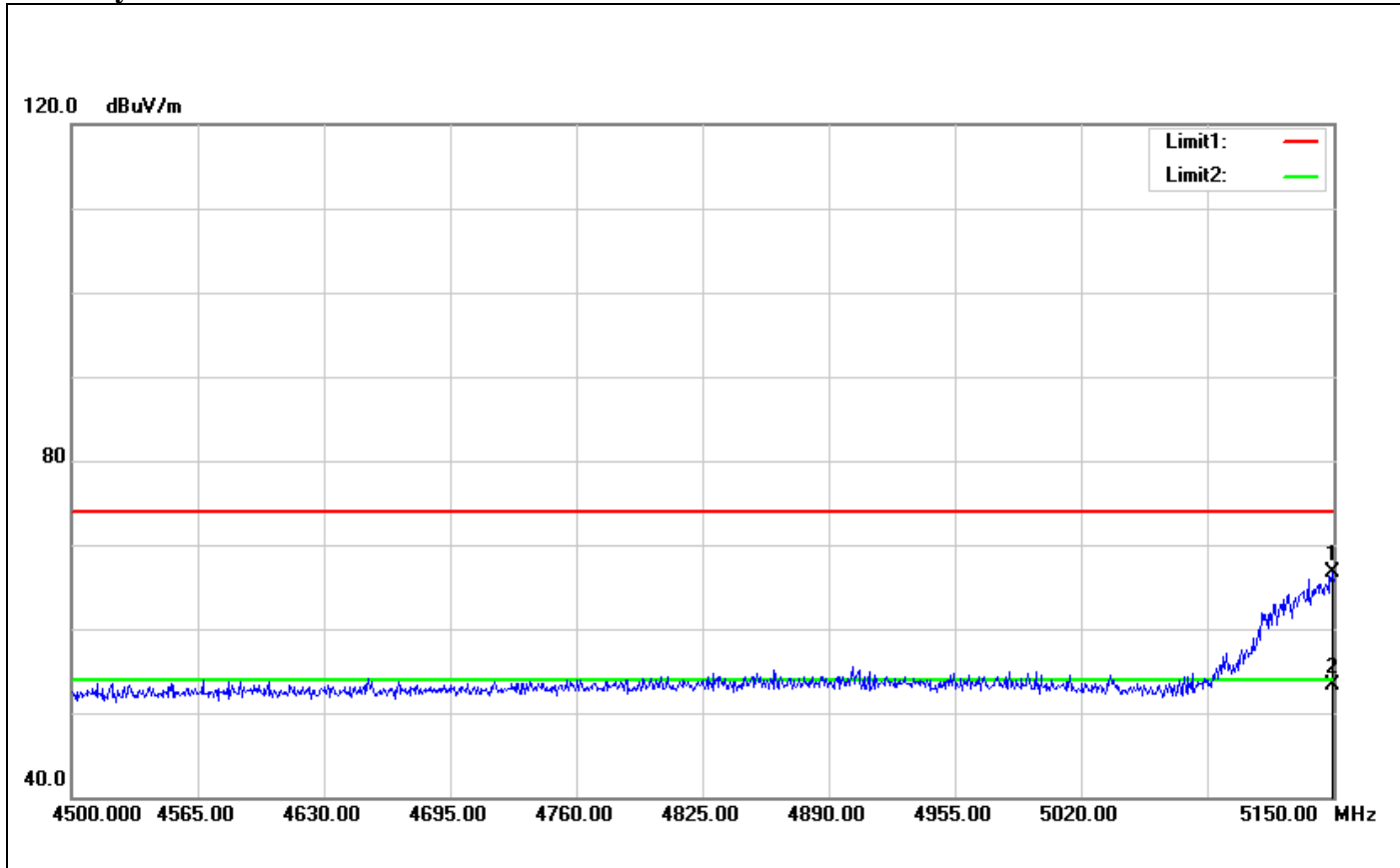

No.	Frequency (MHz)	Reading (dBuV)	Correct Factor(dB/m)	Result (dBuV/m)	Limit (dBuV/m)	Margin (dB)	Height (cm)	Degree (°)	Remark
1	5149.350	63.57	3.04	66.61	74.00	-7.39	100	125	peak
2	5149.350	50.30	3.04	53.34	54.00	-0.66	100	125	AVG



Band Edges (IEEE 802.11ac VHT 80 MHz mode / CH 5290 MHz)

Polarity: Vertical

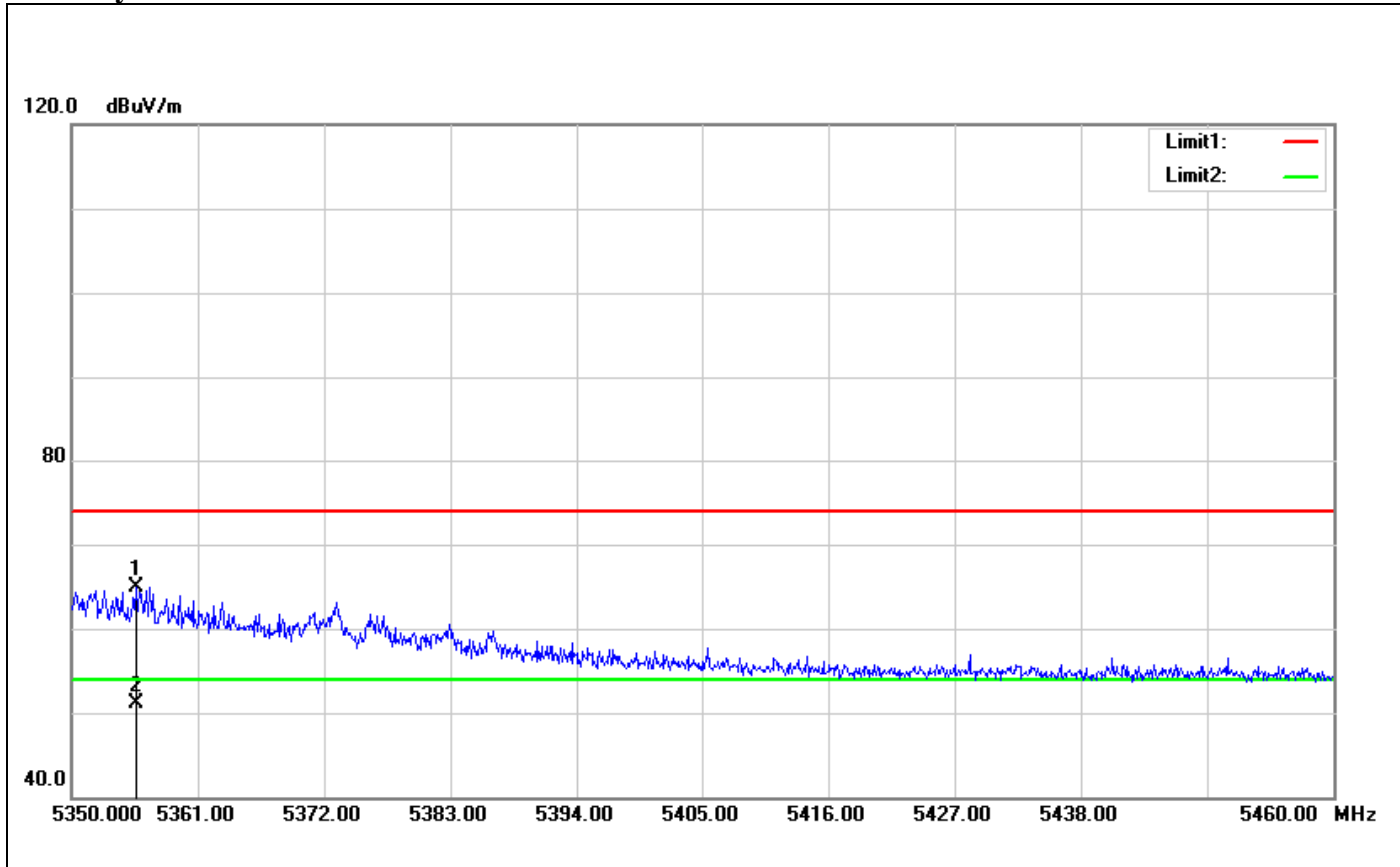

No.	Frequency (MHz)	Reading (dBuV)	Correct Factor(dB/m)	Result (dBuV/m)	Limit (dBuV/m)	Margin (dB)	Height (cm)	Degree (°)	Remark
1	5355.610	59.61	5.36	64.97	74.00	-9.03	100	262	peak
2	5355.610	45.69	5.36	51.05	54.00	-2.95	100	262	AVG



Polarity: Horizontal

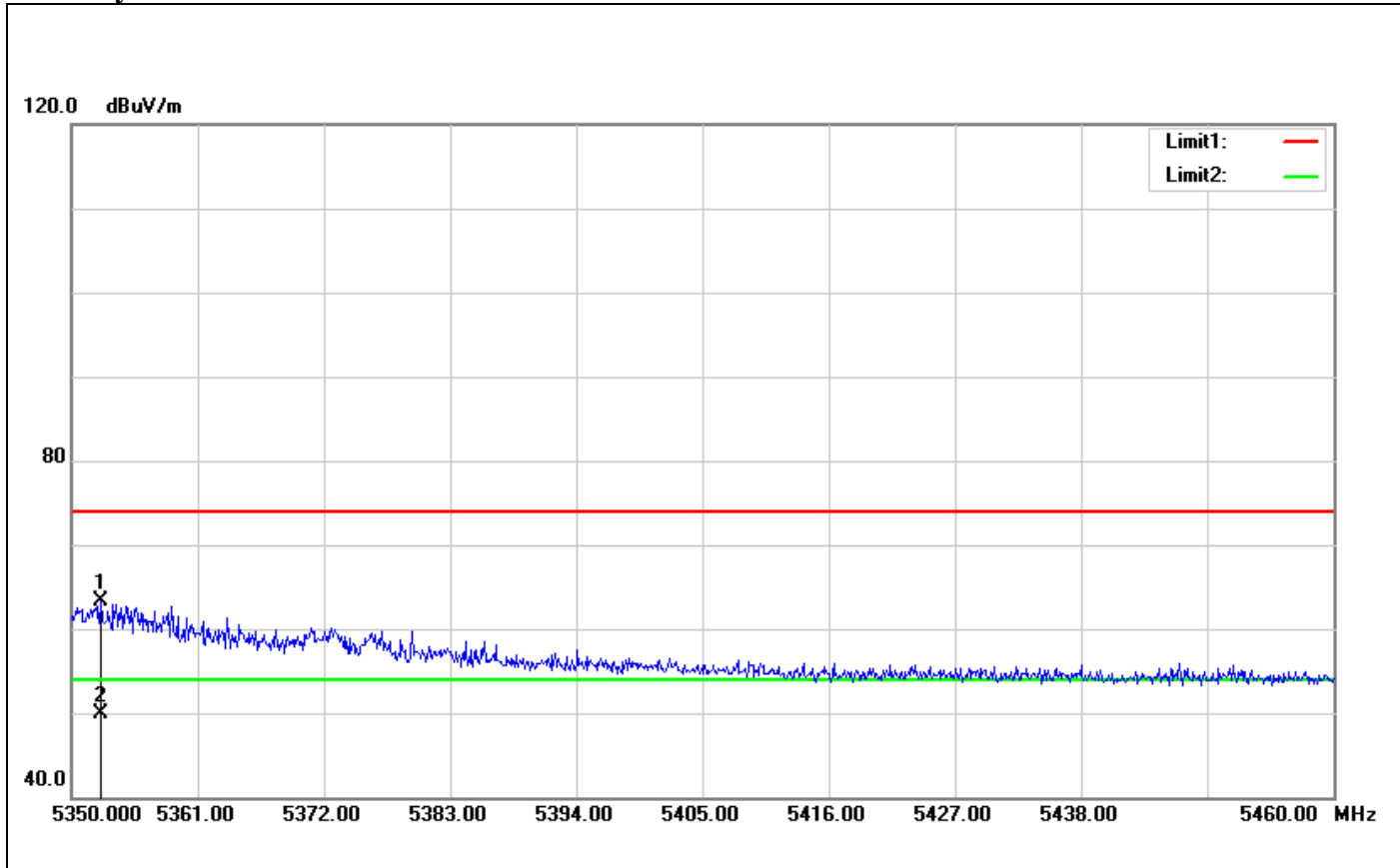

No.	Frequency (MHz)	Reading (dBuV)	Correct Factor(dB/m)	Result (dBuV/m)	Limit (dBuV/m)	Margin (dB)	Height (cm)	Degree (°)	Remark
1	5352.530	58.02	5.33	63.35	74.00	-10.65	100	146	peak
2	5352.530	44.50	5.33	49.83	54.00	-4.17	100	146	AVG



Band Edges (IEEE 802.11ac VHT 80 MHz mode / CH 5530 MHz)

Polarity: Vertical

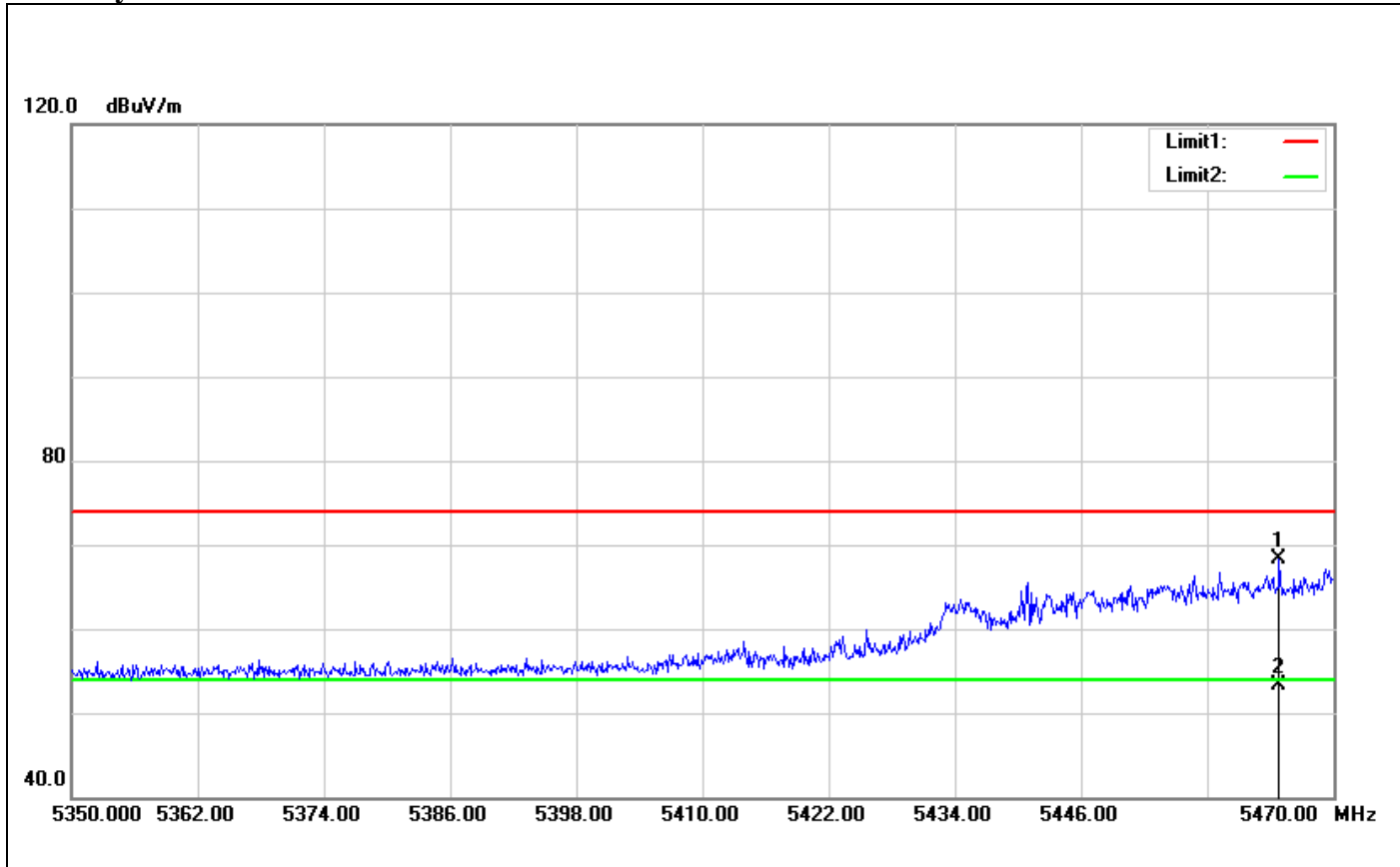

No.	Frequency (MHz)	Reading (dBuV)	Correct Factor(dB/m)	Result (dBuV/m)	Limit (dBuV/m)	Margin (dB)	Height (cm)	Degree (°)	Remark
1	5464.840	62.84	5.42	68.26	74.00	-5.74	100	56	peak
2	5464.840	47.86	5.42	53.28	54.00	-0.72	100	56	AVG



Polarity: Horizontal

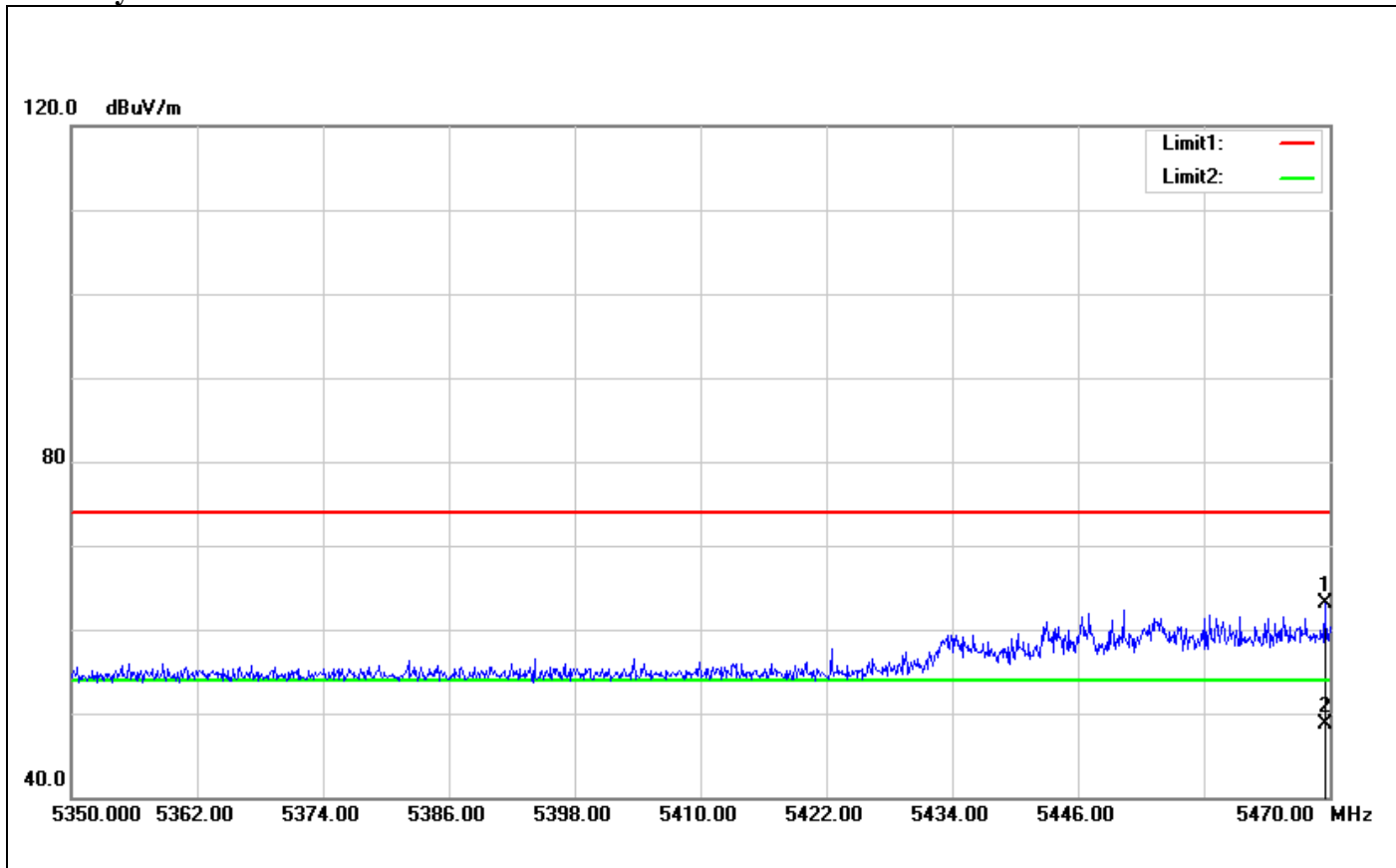

No.	Frequency (MHz)	Reading (dBuV)	Correct Factor(dB/m)	Result (dBuV/m)	Limit (dBuV/m)	Margin (dB)	Height (cm)	Degree (°)	Remark
1	5469.520	57.72	5.39	63.11	74.00	-10.89	100	280	peak
2	5469.520	43.30	5.39	48.69	54.00	-5.31	100	280	AVG



7.4 PEAK POWER SPECTRAL DENSITY

LIMIT

According to §15.407(a)

- (1) For the band 5.15-5.25 GHz, the peak power spectral density shall not exceed 11dBm in any 1MHz band.
- (2) For the band 5.25-5.35 GHz, the peak power spectral density shall not exceed 11dBm in any 1MHz band.

If transmitting antennas of directional gain greater than 6dBi are used, both the peak transmit power and the peak power spectral density shall be reduced by the amount in dB that the directional gain of the antenna exceeds 6dBi.

Test Configuration

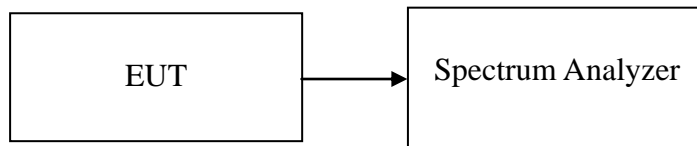

TEST PROCEDURE

1. Place the EUT on the table and set it in transmitting mode.
Remove the antenna from the EUT and then connect a low loss RF cable from the antenna port to the spectrum analyzer.
2. Set the spectrum analyzer as RBW = 1MHz, VBW = 3MHz, Span = Sweep= AUTO
3. Record the max. reading.
4. Repeat the above procedure until the measurements for all frequencies are completed

TEST RESULTS

No non-compliance noted



Test Data

Test mode: IEEE 802.11a mode / 5180 ~ 5240MHz

Channel	Frequency (MHz)	PPSD (dBm)	Limit (dBm)	Margin	Result
Low	5180	1.49	11.00	-9.51	PASS
Mid	5220	1.66	11.00	-9.34	PASS
High	5240	1.86	11.00	-9.14	PASS

Test mode: IEEE 802.11n HT 20 MHz Channel mode / 5180 ~ 5240MHz

Channel	Frequency (MHz)	PPSD (dBm)	Limit (dBm)	Margin	Result
Low	5180	2.80	11.00	-8.2	PASS
Mid	5220	2.91	11.00	-8.09	PASS
High	5240	2.78	11.00	-8.22	PASS

Test mode: IEEE 802.11n HT 40 MHz mode / 5190 ~ 5230MHz

Channel	Frequency (MHz)	PPSD (dBm)	Limit (dBm)	Margin	Result
Low	5190	-0.08	11.00	-11.08	PASS
High	5230	0.05	11.00	-10.95	PASS

Test mode: IEEE 802.11ac VHT 80 MHz mode / 5210MHz

Channel	Frequency (MHz)	PPSD (dBm)	Limit (dBm)	Margin	Result
Mid	5210	-5.18	11.00	-16.18	PASS



Test mode: IEEE 802.11a mode/ 5260 ~ 5320MHz

Channel	Frequency (MHz)	PPSD (dBm)	Limit (dBm)	Margin	Result
Low	5260	1.96	11.00	-9.04	PASS
Mid	5280	2.06	11.00	-8.94	PASS
High	5320	2.31	11.00	-8.69	PASS

Test mode: IEEE 802.11n HT 20 MHz Channel mode / 5260 ~ 5320MHz

Channel	Frequency (MHz)	PPSD (dBm)	Limit (dBm)	Margin	Result
Low	5260	2.69	11.00	-8.31	PASS
Mid	5280	2.68	11.00	-8.32	PASS
High	5320	2.87	11.00	-8.13	PASS

Test mode: IEEE 802.11n HT 40 MHz mode / 5270 ~ 5310MHz

Channel	Frequency (MHz)	PPSD (dBm)	Limit (dBm)	Margin	Result
Low	5270	0.74	11.00	-10.26	PASS
High	5310	0.77	11.00	-10.23	PASS

Test mode: IEEE 802.11ac VHT 80 MHz mode / 5290MHz

Channel	Frequency (MHz)	PPSD (dBm)	Limit (dBm)	Margin	Result
Mid	5290	-2.57	11.00	-13.57	PASS



Test mode: IEEE 802.11a mode / 5500 ~ 5700MHz

Channel	Frequency (MHz)	PPSD (dBm)	Limit (dBm)	Margin	Result
Low	5500	3.38	11.00	-7.62	PASS
Mid	5580	3.53	11.00	-7.47	PASS
High	5700	2.50	11.00	-8.5	PASS

Test mode: IEEE 802.11n HT 20 MHz Channel mode / 5500 ~ 5700MHz

Channel	Frequency (MHz)	PPSD (dBm)	Limit (dBm)	Margin	Result
Low	5500	3.25	11.00	-7.75	PASS
Mid	5580	2.80	11.00	-8.2	PASS
High	5700	2.52	11.00	-8.48	PASS

Test mode: IEEE 802.11n HT 40 MHz mode / 5510 ~ 5670MHz

Channel	Frequency (MHz)	PPSD (dBm)	Limit (dBm)	Margin	Result
Low	5510	1.73	11.00	-9.27	PASS
Mid	5550	1.57	11.00	-9.43	PASS
High	5670	0.24	11.00	-10.76	PASS

Test mode: IEEE 802.11ac VHT 80 MHz mode / 5530 ~ 5690MHz

Channel	Frequency (MHz)	PPSD (dBm)	Limit (dBm)	Margin	Result
Low	5530	-4.26	11.00	-15.26	PASS
High	5690 (Band III)	-2.20	11.00	-13.2	PASS
High	5690 (Band IV)	-12.99	30.00/500kHz	-42.99	PASS



Test Plot
IEEE 802.11a mode / 5180 ~ 5240MHz

CH Low

Agilent

R T

Mkr1 5.183 83 GHz
1.49 dBm

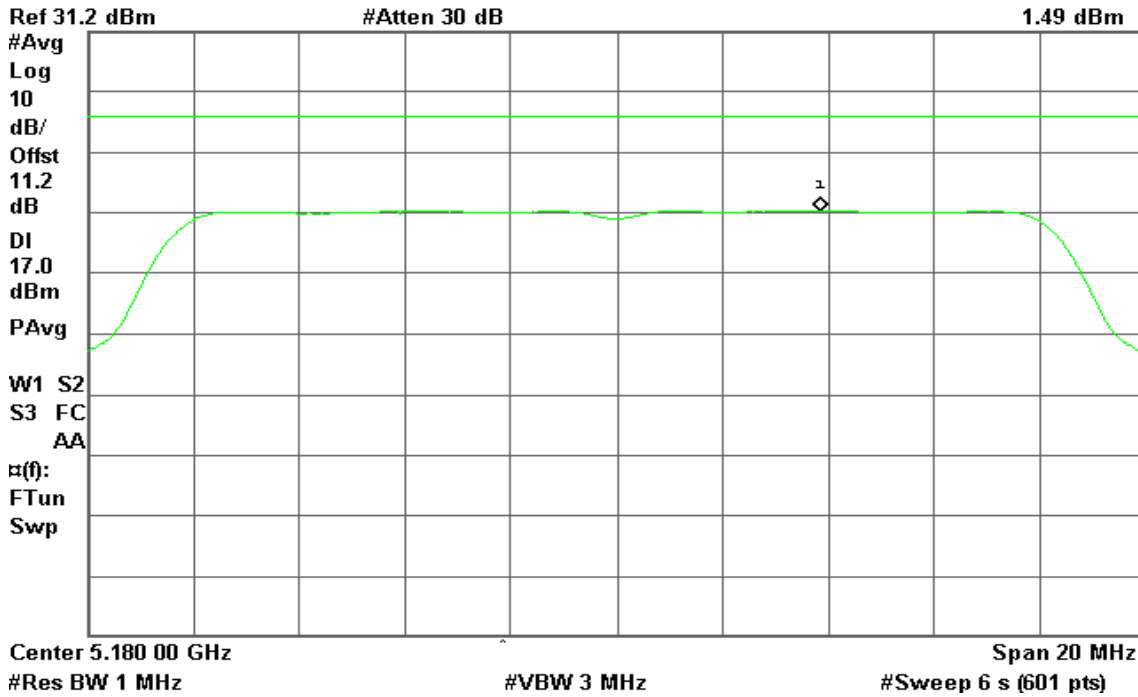

CH Mid

Agilent

R T

Mkr1 5.223 90 GHz
1.66 dBm

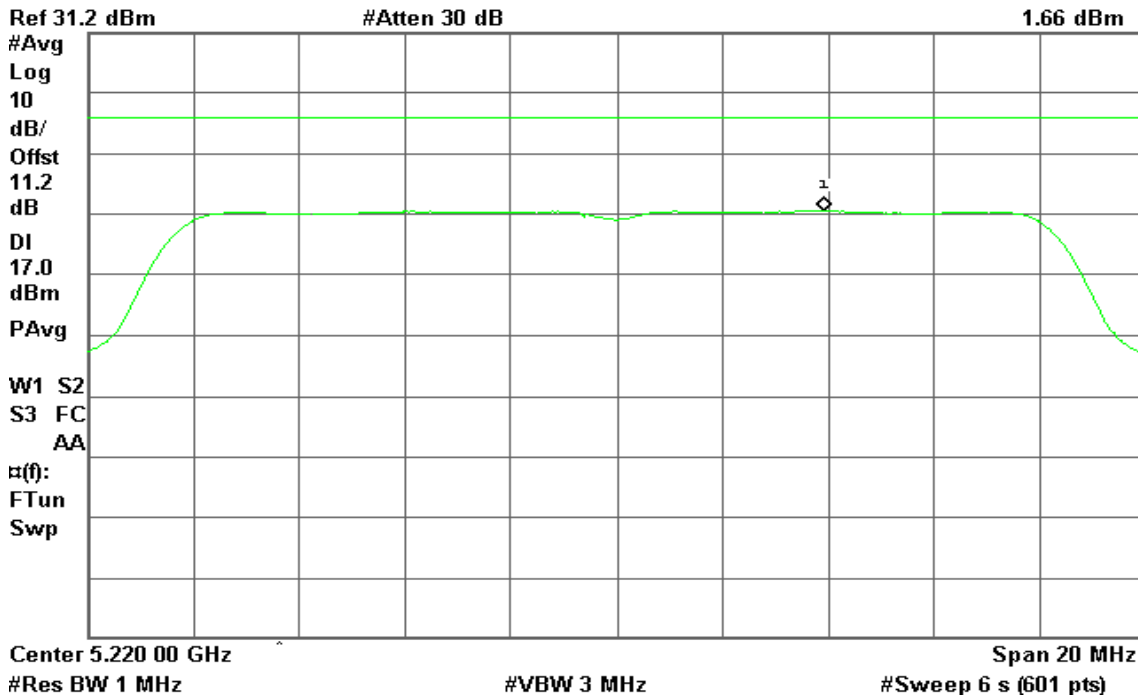



CH High

Agilent

R T

Mkr1 5.243 87 GHz

1.86 dBm

Ref 31.2 dBm

#Atten 30 dB

#Avg

Log

10

dB/

Offst

11.2

dB

DI

17.0

dBm

PAvg

W1 S2

S3 FC

AA

$\alpha(f)$:

FTun

Swp

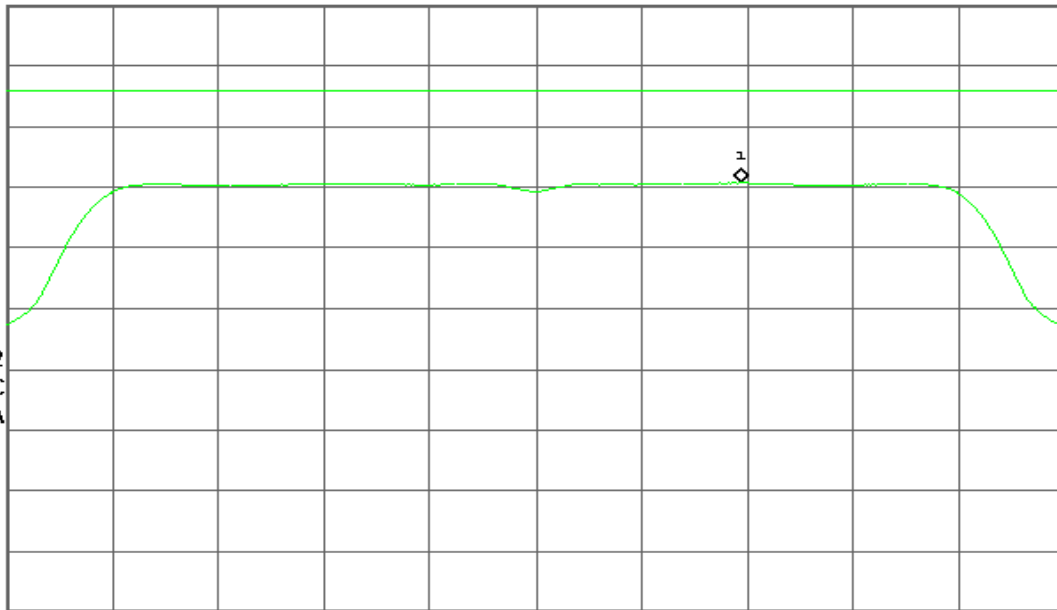

Center 5.240 00 GHz

Span 20 MHz

#Res BW 1 MHz

#VBW 3 MHz

#Sweep 6 s (601 pts)



IEEE 802.11n HT 20 MHz Channel mode / 5180 ~ 5240MHz

CH Low

Agilent

R T

Mkr1 5.176 13 GHz
2.80 dBm

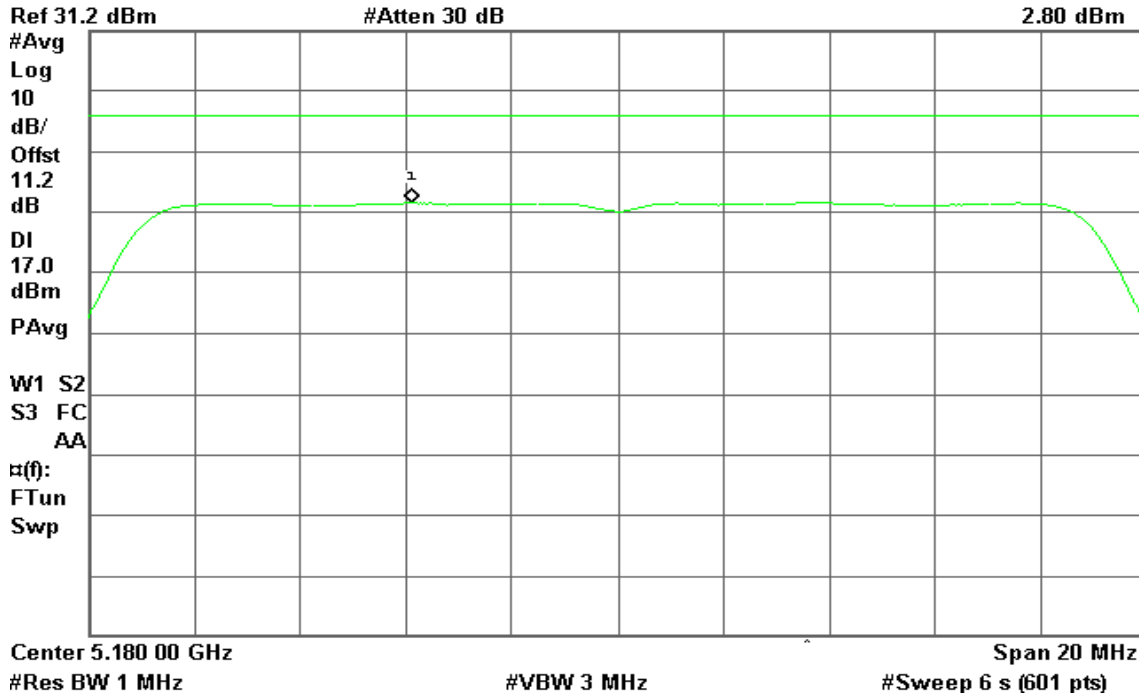

CH Mid

Agilent

R T

Mkr1 5.223 87 GHz
2.91 dBm

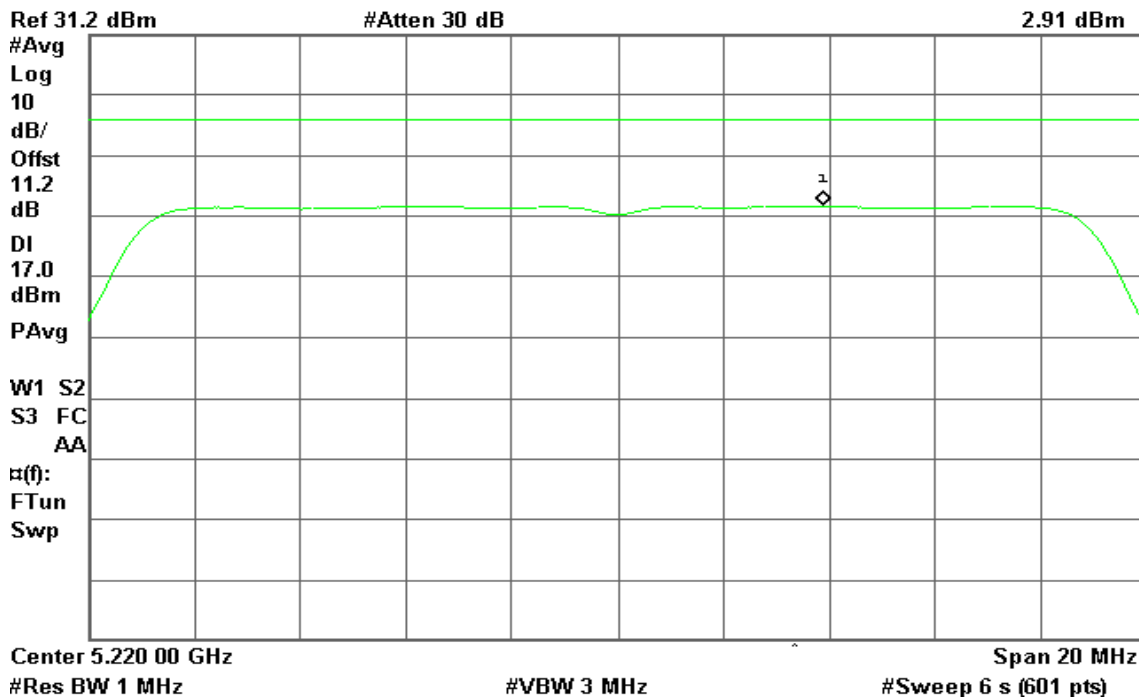



CH High

Agilent

R T

Mkr1 5.243 87 GHz

2.78 dBm

Ref 31.2 dBm

#Atten 30 dB

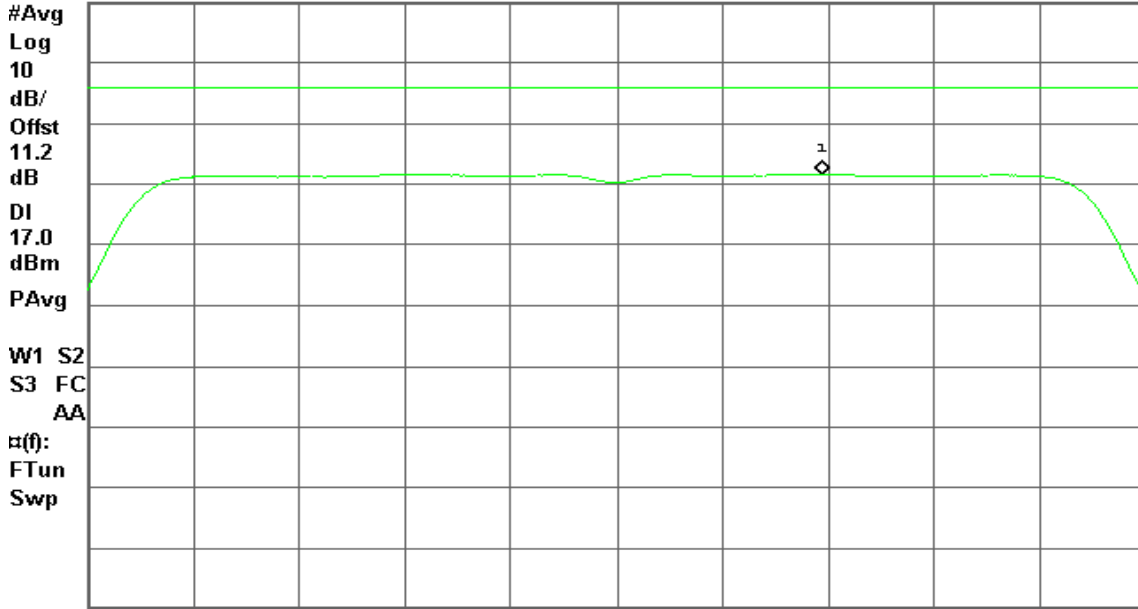

Center 5.240 00 GHz

Span 20 MHz

#Res BW 1 MHz

#VBW 3 MHz

#Sweep 6 s (601 pts)



IEEE 802.11n HT 40 MHz mode / 5190 ~ 5230MHz

CH Low

Agilent

R T

Mkr1 5.193 53 GHz
-0.08 dBm

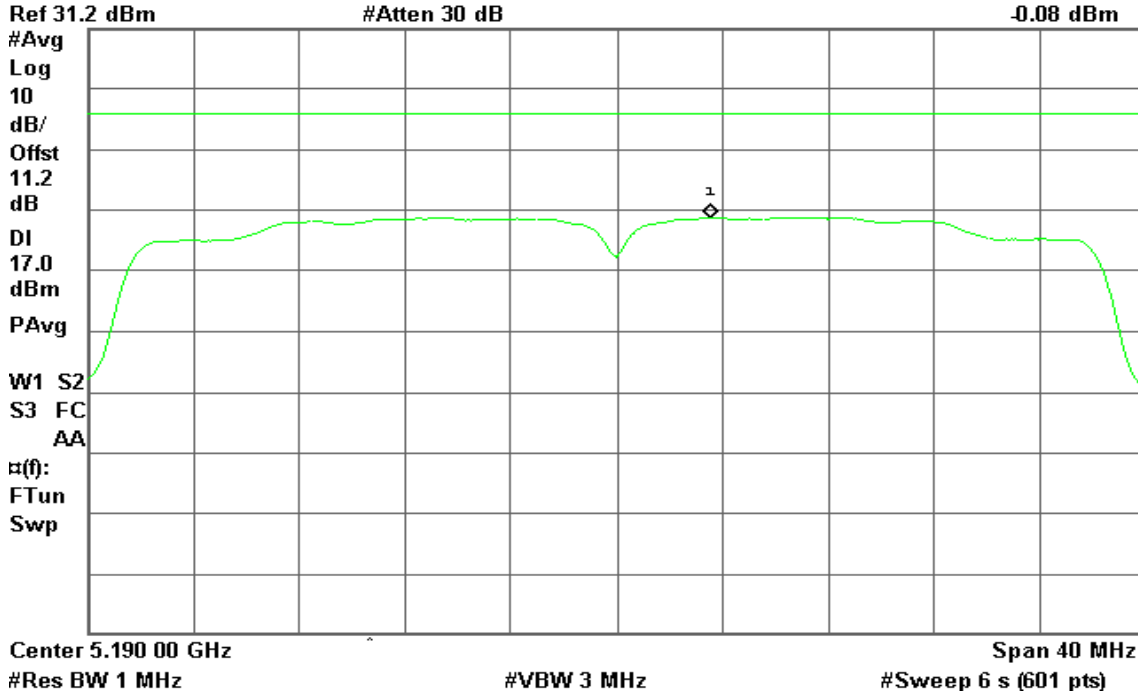

CH High

Agilent

R T

Mkr1 5.233 60 GHz
0.05 dBm

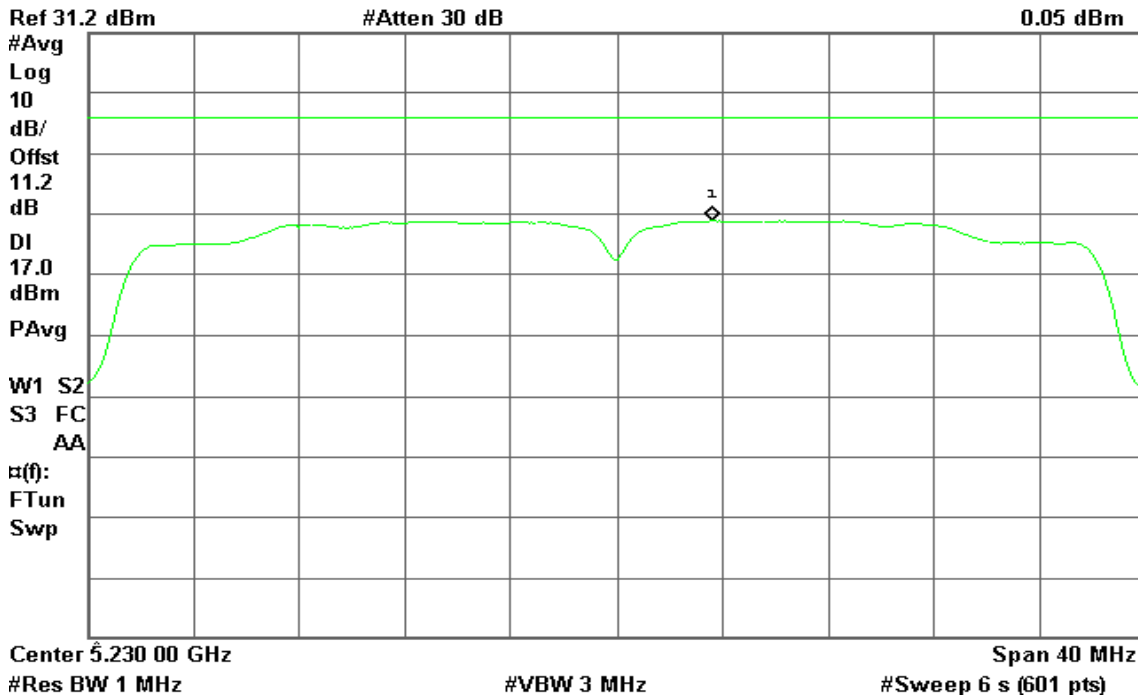



IEEE 802.11ac VHT 80 MHz mode / 5210MHz

CH Mid

Agilent

R T

Mkr1 5.202 53 GHz
-5.18 dBm

Ref 31.2 dBm

#Atten 30 dB

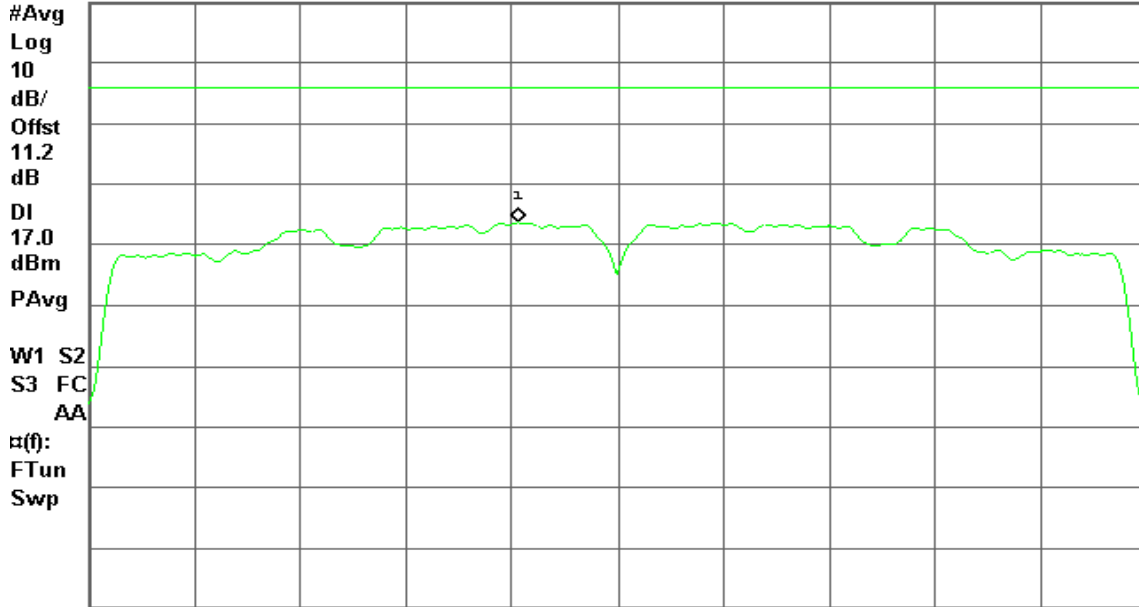

Center 5.210 00 GHz

Span 80 MHz

#Res BW 1 MHz

#VBW 50 MHz

#Sweep 6 s (601 pts)



IEEE 802.11a mode / 5260 ~ 5320MHz

CH Low

Agilent

R T

Mkr1 5.264 03 GHz
1.96 dBm

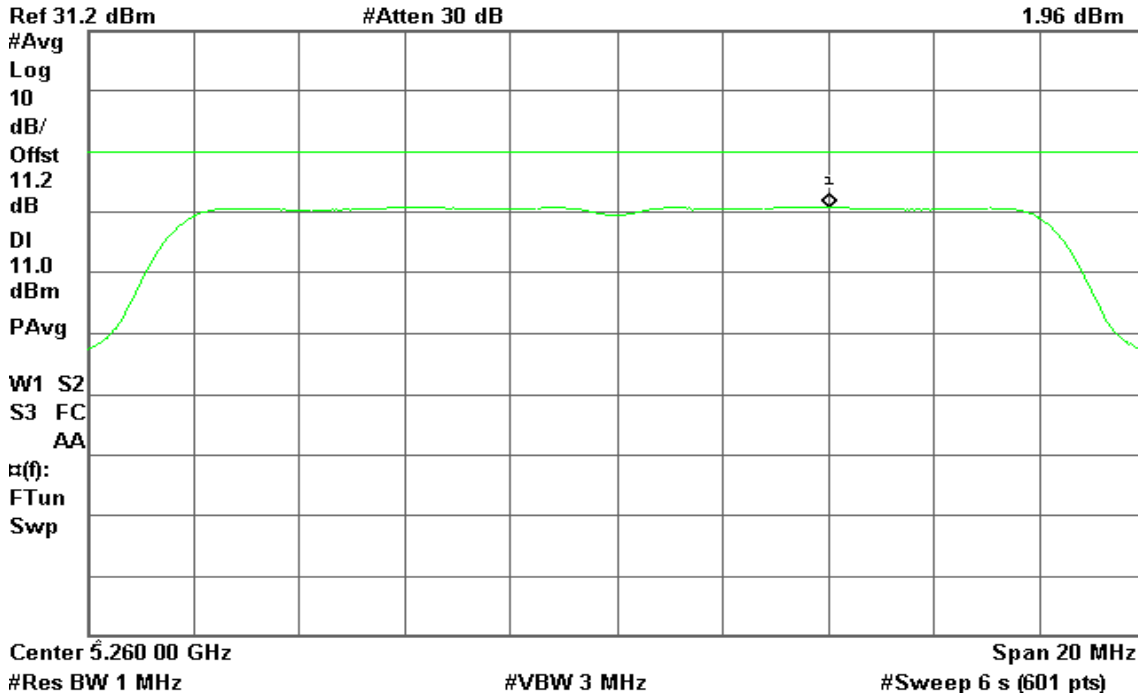

CH Mid

Agilent

R T

Mkr1 5.283 90 GHz
2.06 dBm

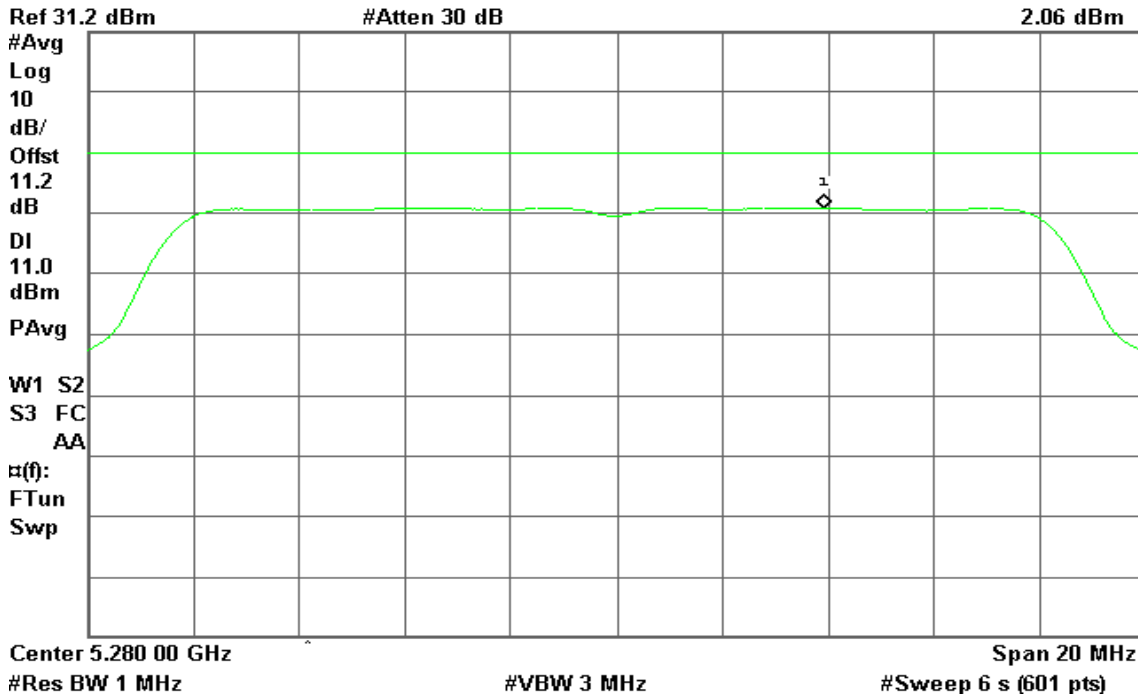



CH High

Agilent

R T

Mkr1 5.316 03 GHz
2.31 dBm

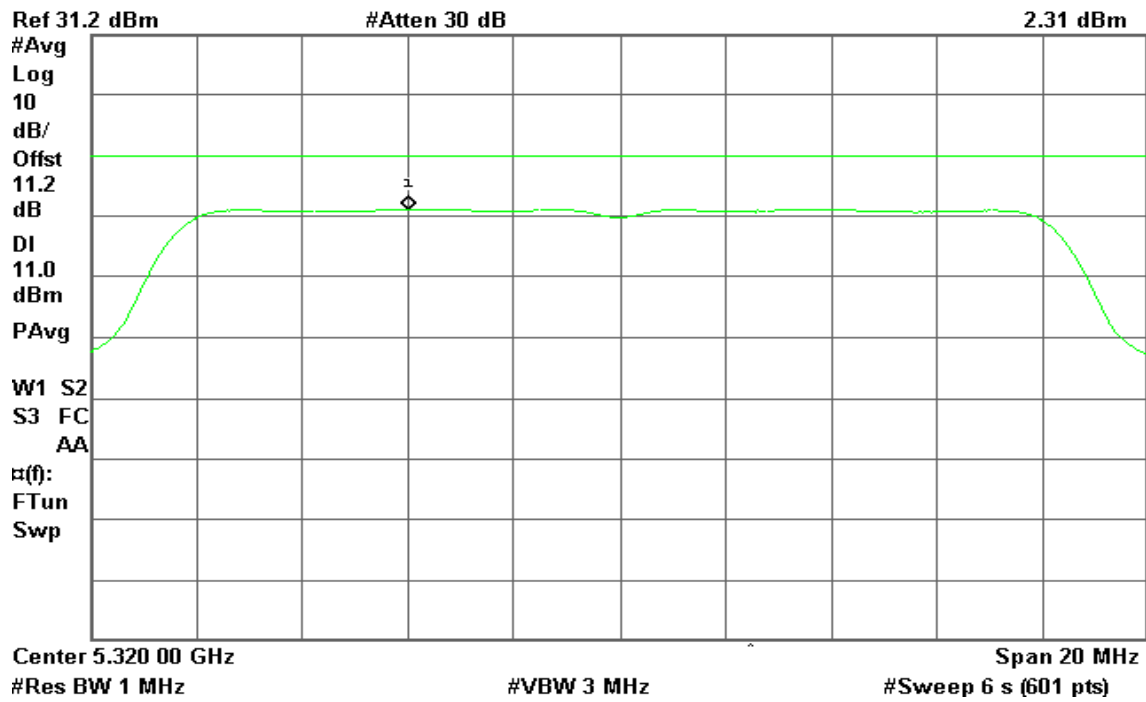



IEEE 802.11n HT 20 MHz Channel mode / 5260 ~ 5320MHz

CH Low

Agilent

R T

Mkr1 5.263 87 GHz
2.69 dBm

Ref 31.2 dBm

#Atten 30 dB

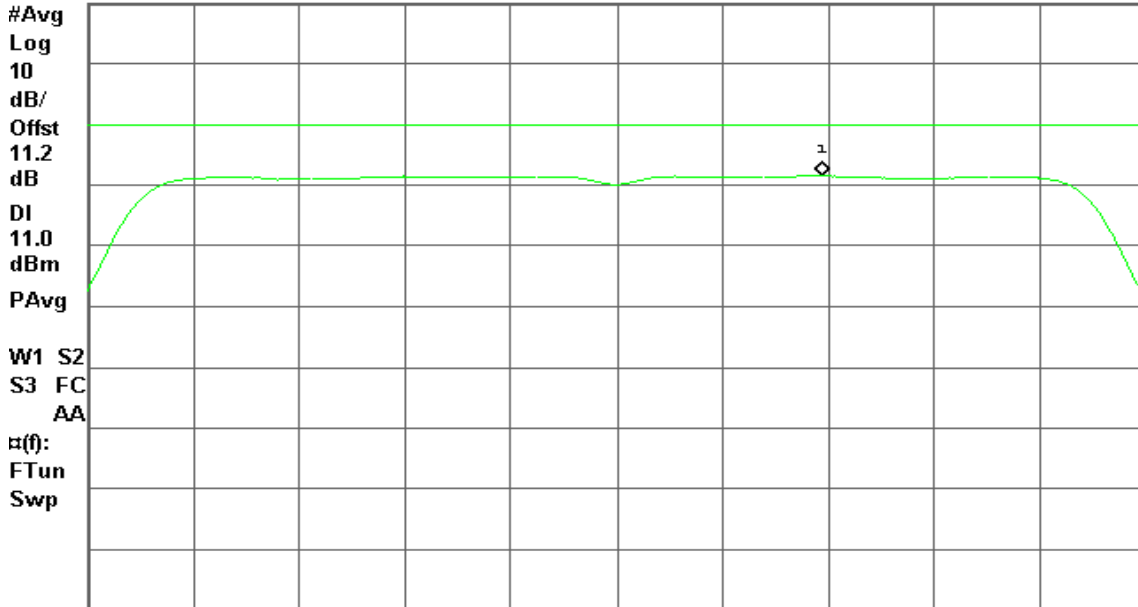

Center 5.260 00 GHz

#Res BW 1 MHz

#VBW 3 MHz

Span 20 MHz
#Sweep 6 s (601 pts)

CH Mid

Agilent

R T

Mkr1 5.276 10 GHz
2.68 dBm

Ref 31.2 dBm

#Atten 30 dB

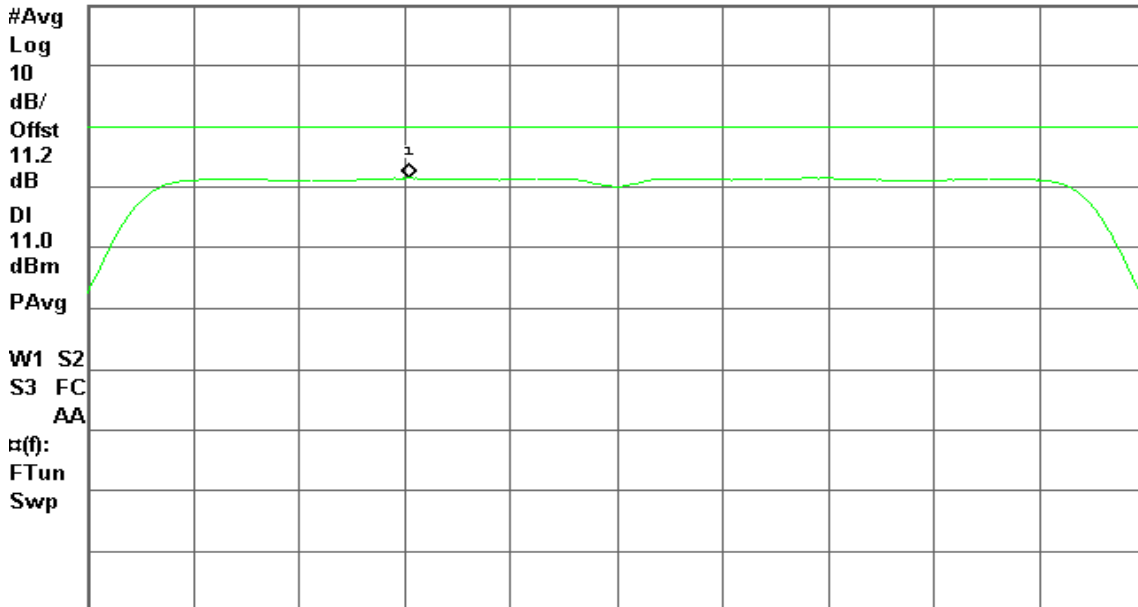

Center 5.280 00 GHz

#Res BW 1 MHz

#VBW 3 MHz

Span 20 MHz
#Sweep 6 s (601 pts)



CH High

Agilent

R T

Mkr1 5.315 97 GHz

2.87 dBm

Ref 31.2 dBm

#Atten 30 dB

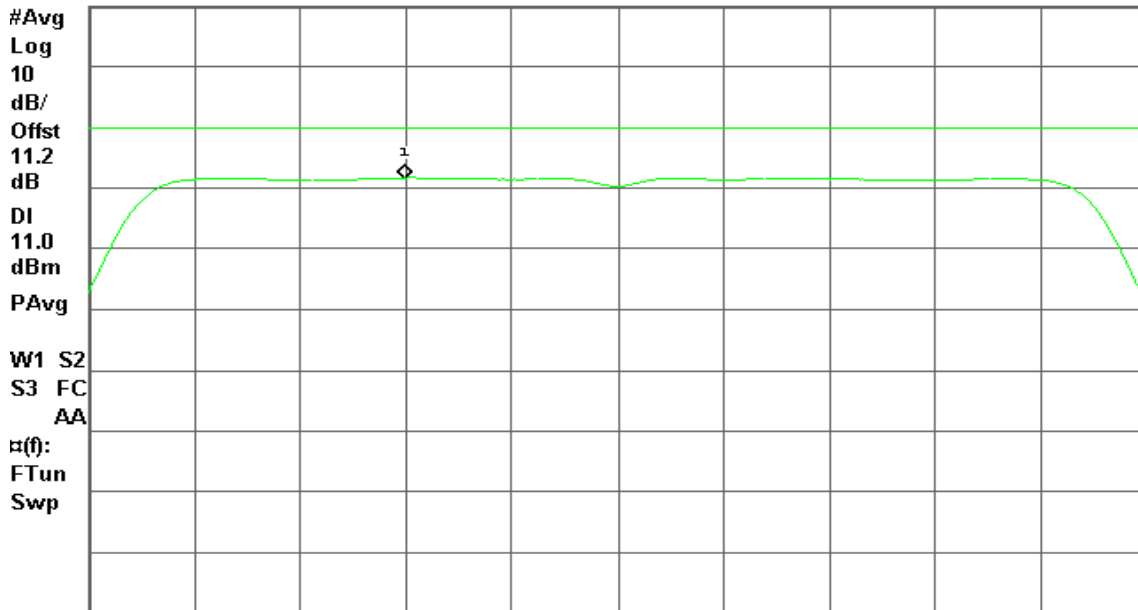

Center 5.320 00 GHz

Span 20 MHz

#Res BW 1 MHz

#VBW 3 MHz

#Sweep 6 s (601 pts)



IEEE 802.11n HT 40 MHz mode / 5270 ~ 5310MHz

CH Low

Agilent

R T

Mkr1 5.273 67 GHz
0.74 dBm

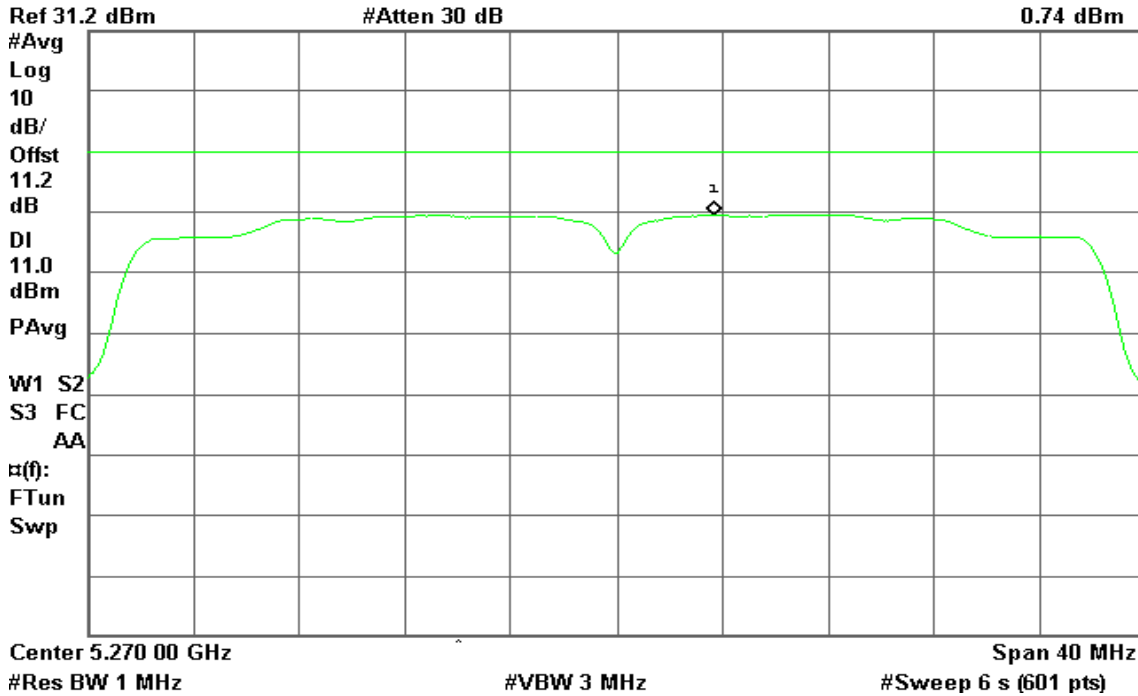

CH High

Agilent

R T

Mkr1 5.303 53 GHz
0.77 dBm

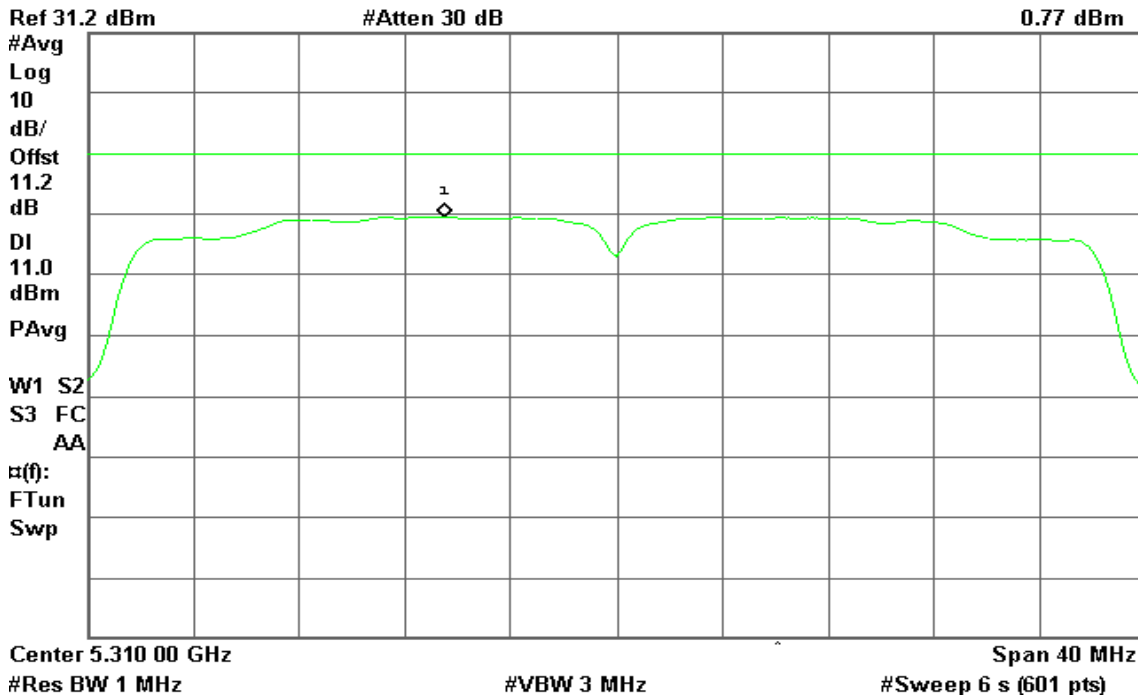



IEEE 802.11ac VHT 80 MHz mode / 5290MHz

CH Mid

Agilent

R T

Mkr1 5.282 53 GHz
-2.57 dBm

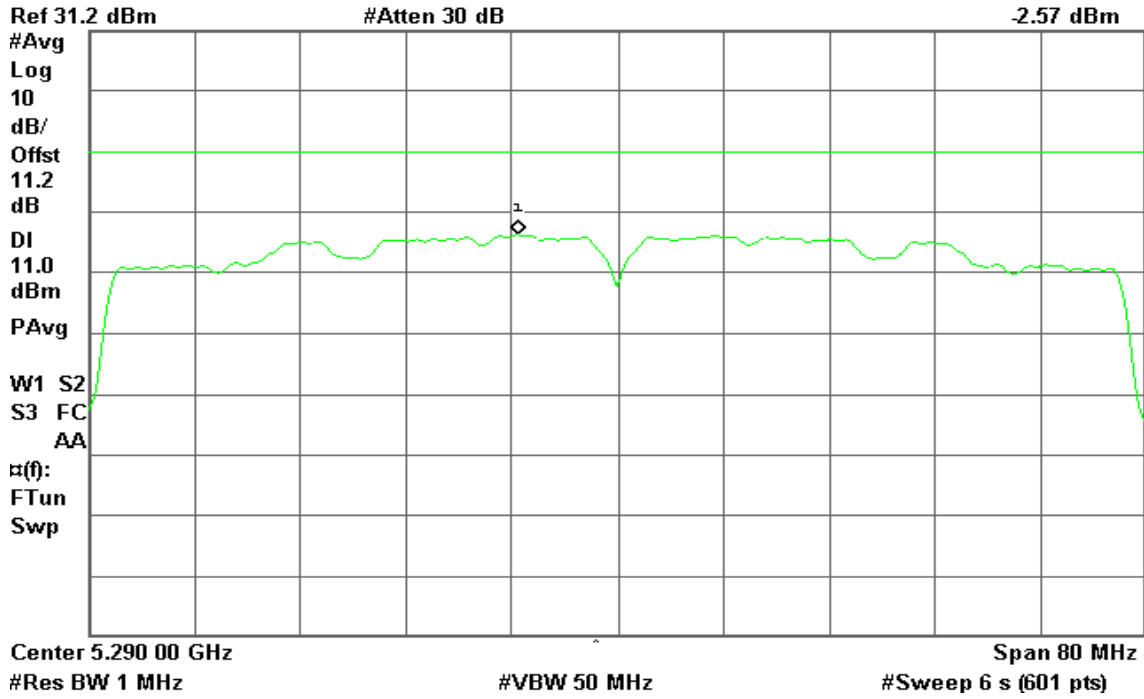



Test mode: IEEE 802.11a mode / 5500 ~ 5700MHz

CH Low

Agilent

R T

Mkr1 5.496 27 GHz
3.38 dBm

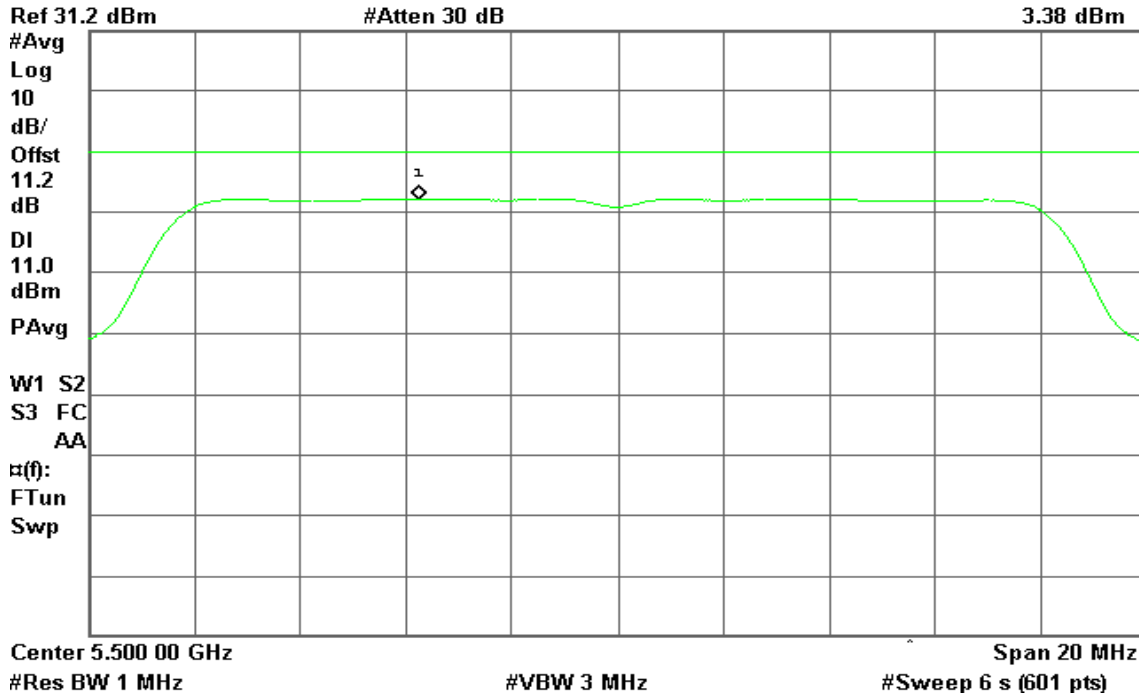

CH Mid

Agilent

R T

Mkr1 5.576 17 GHz
3.53 dBm

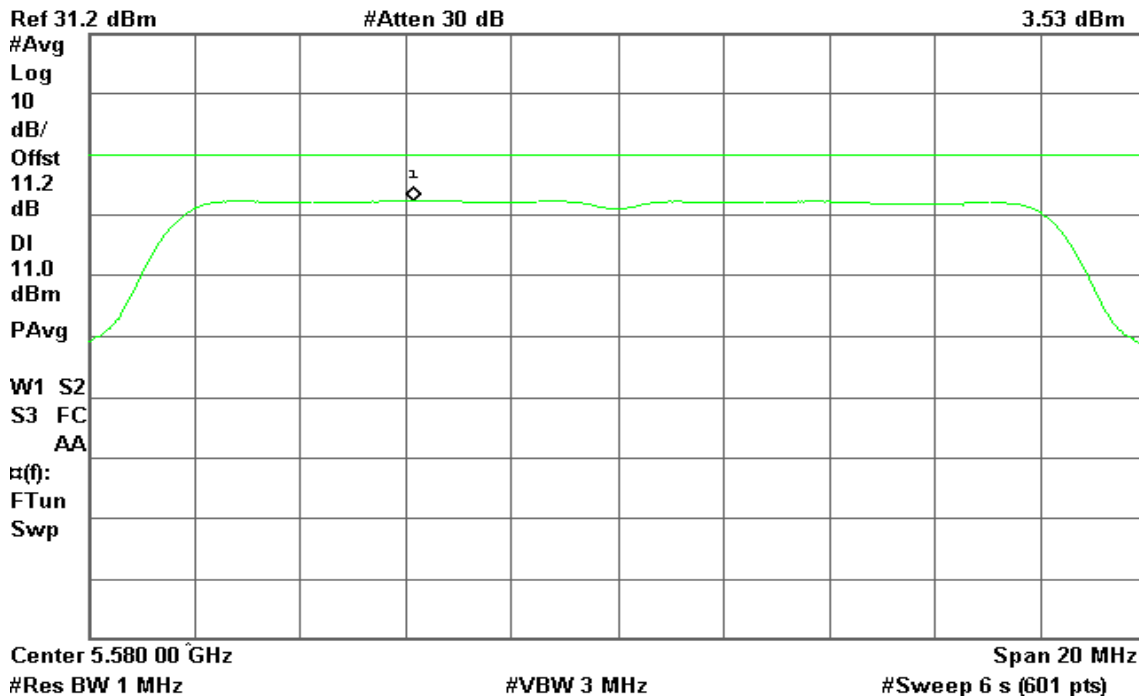



CH High

Agilent

R T

Mkr1 5.696 00 GHz
2.50 dBm

Ref 31.2 dBm

#Atten 30 dB

#Avg

Log

10

dB/

Offst

11.2

dB

DI

11.0

dBm

PAvg

W1 S2

S3 FC

AA

⌘(f):

FTun

Swp

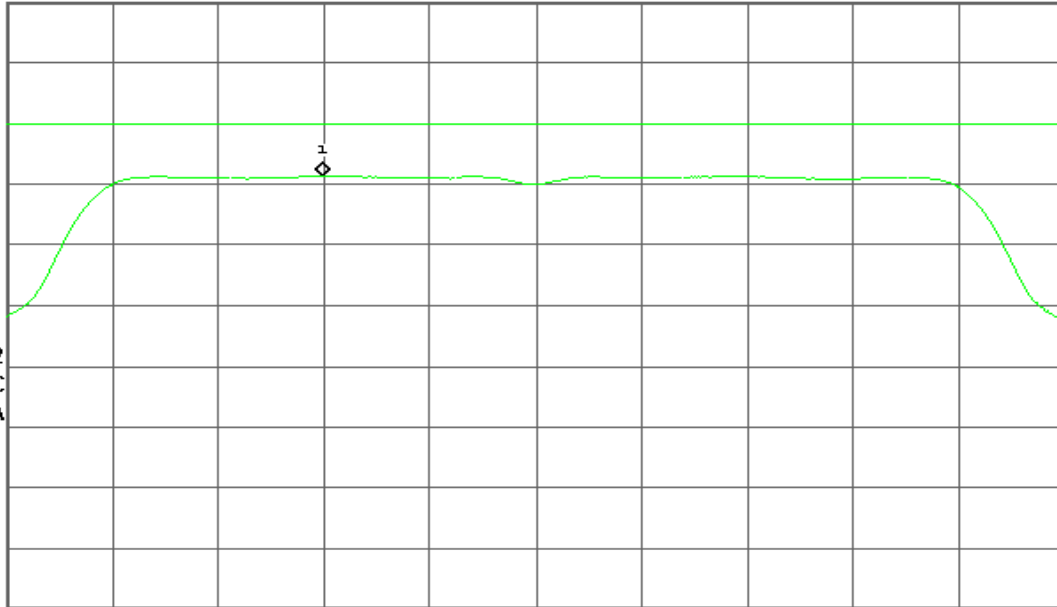

Center 5.700 00 GHz

Span 20 MHz

#Res BW 1 MHz

#VBW 3 MHz

#Sweep 6 s (601 pts)



IEEE 802.11n HT 20 MHz Channel mode / 5500 ~ 5700MHz

CH Low

Agilent

R T

Mkr1 5.496 13 GHz
3.25 dBm

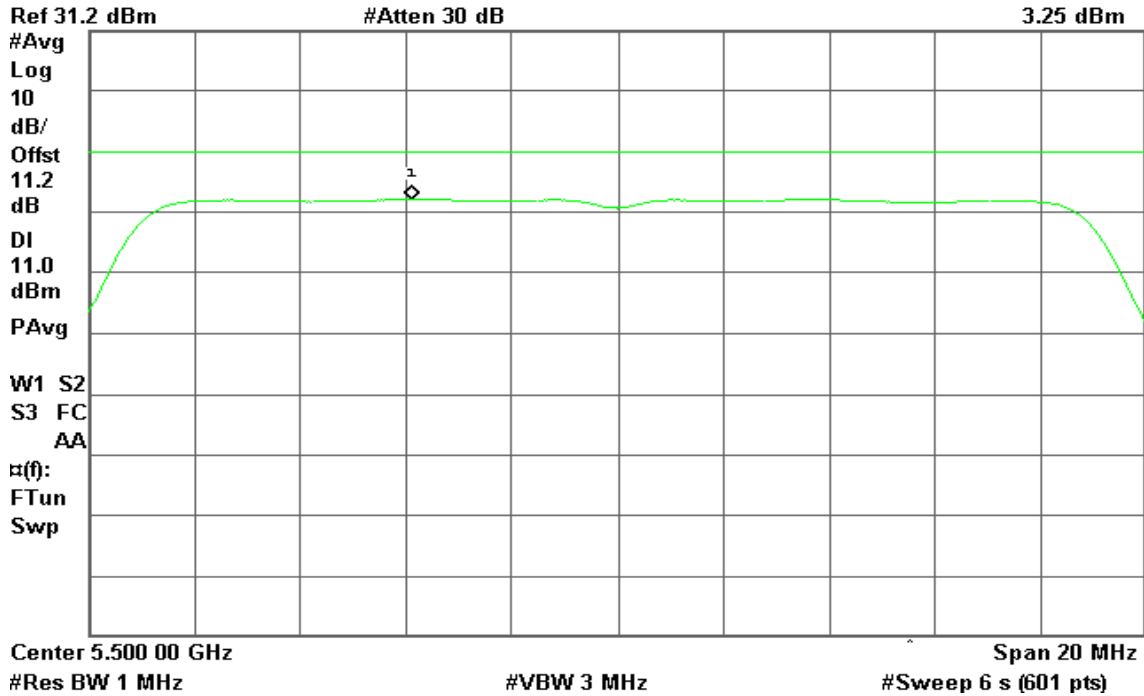

CH Mid

Agilent

R T

Mkr1 5.576 03 GHz
2.80 dBm

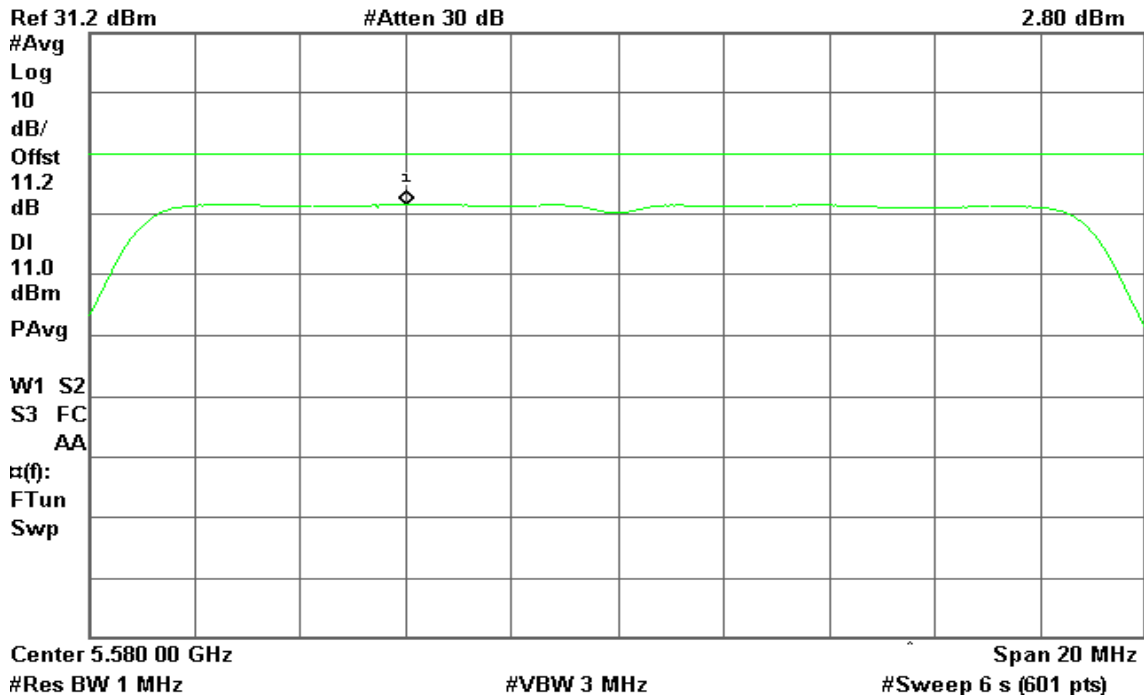



CH High

Agilent

R T

Mkr1 5.696 03 GHz
2.52 dBm

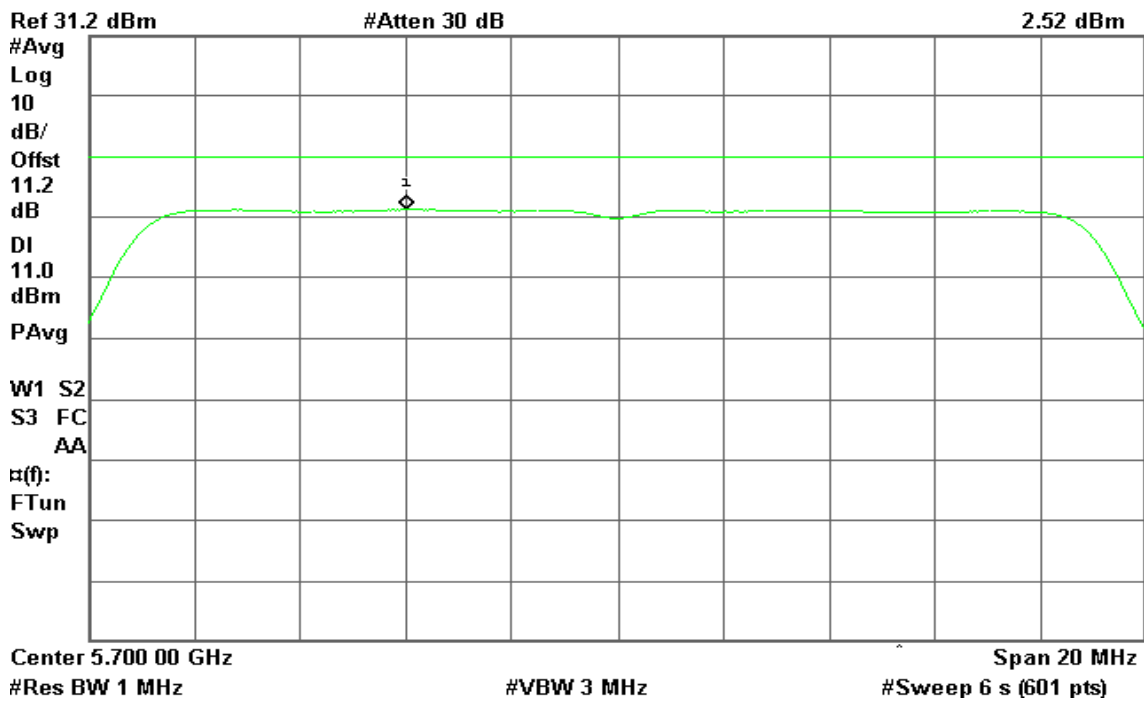



IEEE 802.11n HT 40 MHz mode / 5530 ~ 5690MHz

CH Low

Agilent

R T

Mkr1 5.503 53 GHz
1.73 dBm

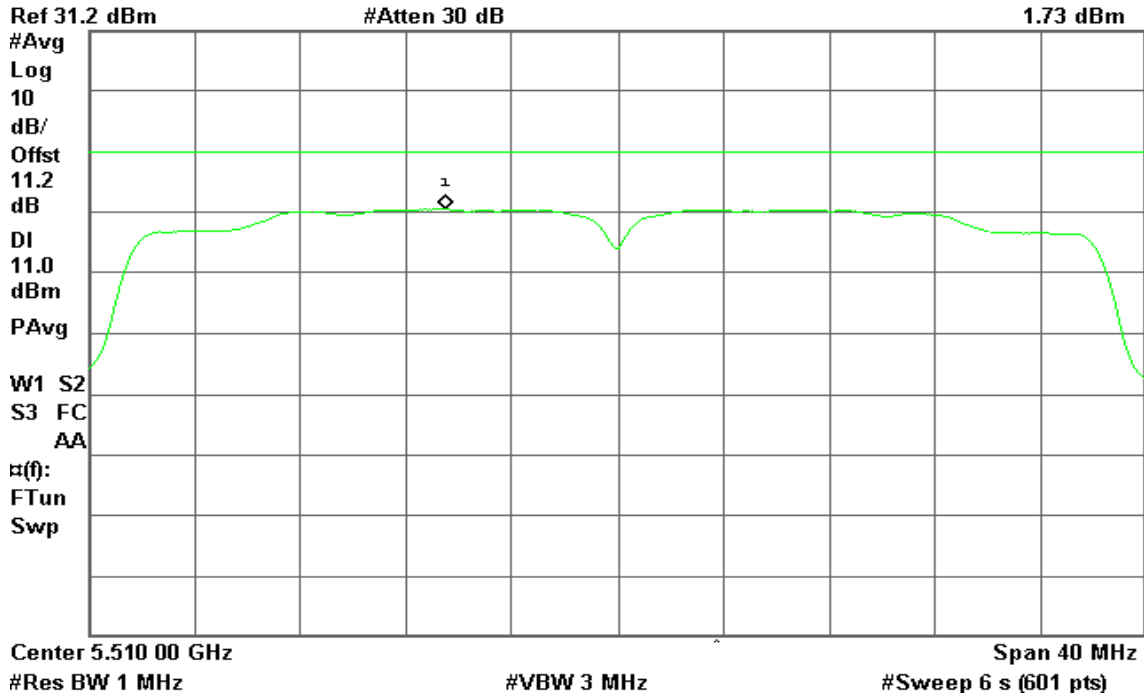

CH Mid

Agilent

R T

Mkr1 5.543 67 GHz
1.57 dBm

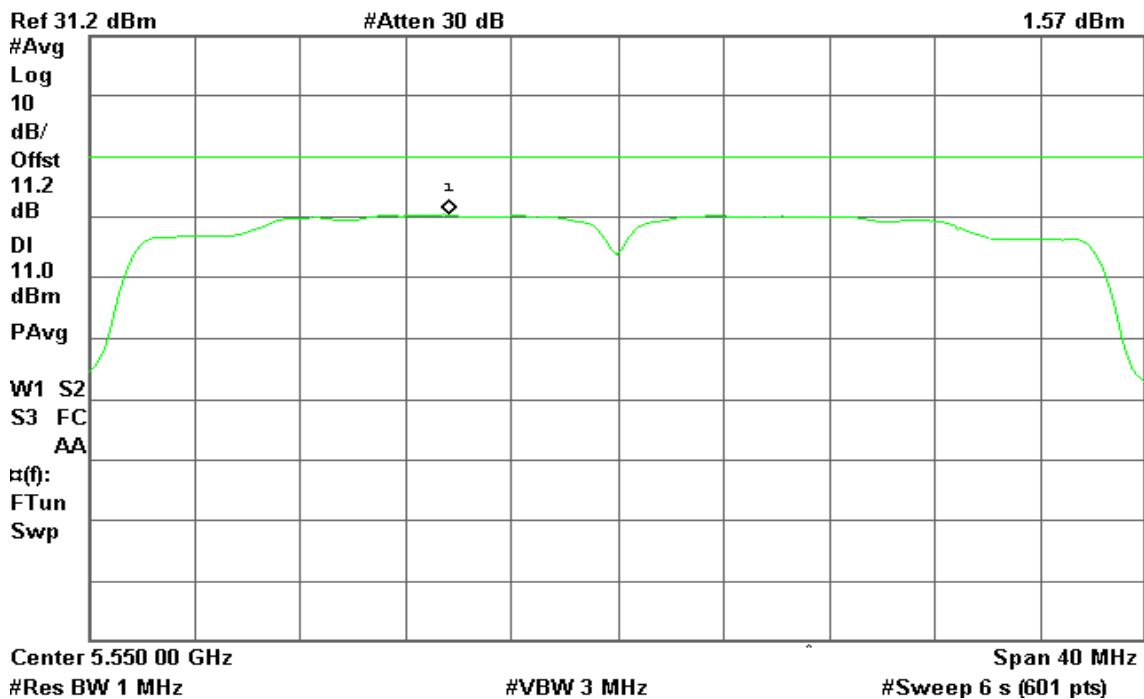



CH High

Agilent

R T

Mkr1 5.663 53 GHz
0.24 dBm

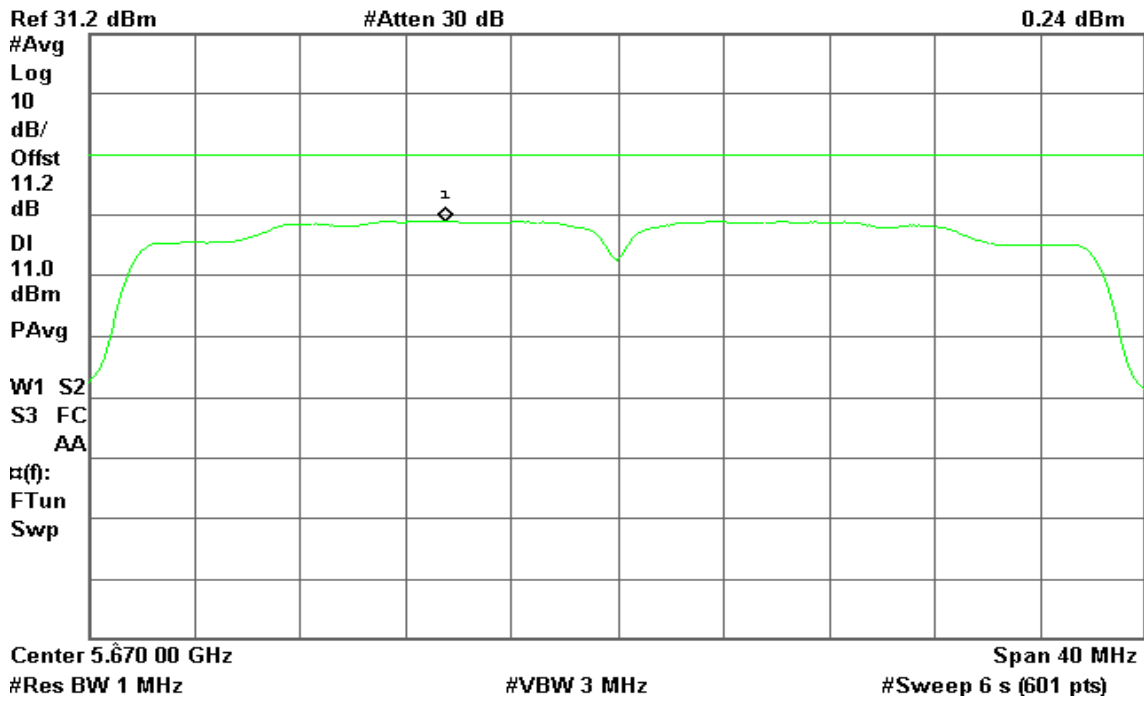



IEEE 802.11ac VHT 80 MHz mode / 5530 ~ 5690MHz

CH Low

Agilent

R T

Mkr1 5.522 40 GHz
-4.26 dBm

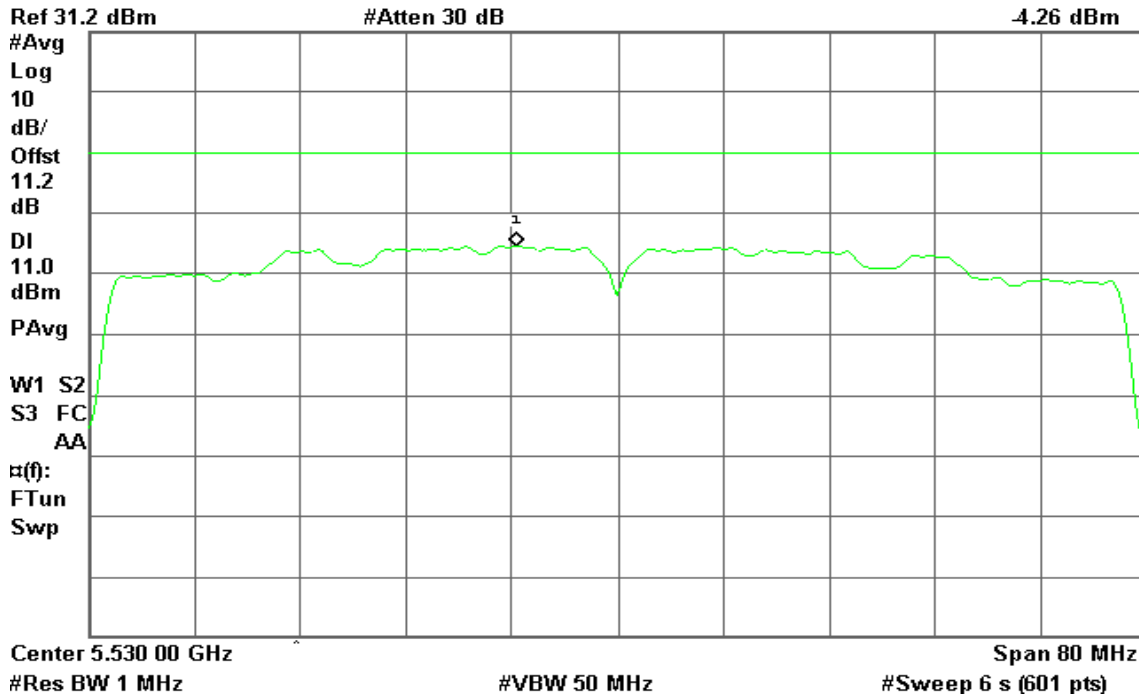

CH High (Band III)

Agilent

R T

Mkr1 5.681 20 GHz
-2.20 dBm

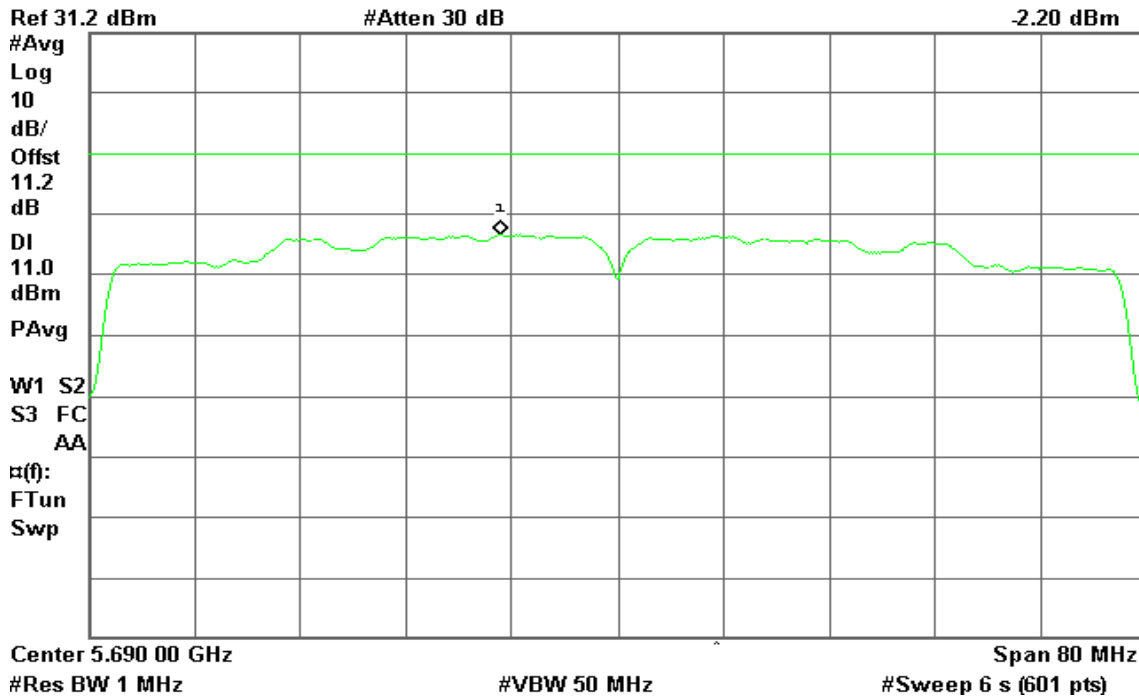



CH High (Band IV)

Agilent

R T

Mkr1 5.727 47 GHz
-12.99 dBm

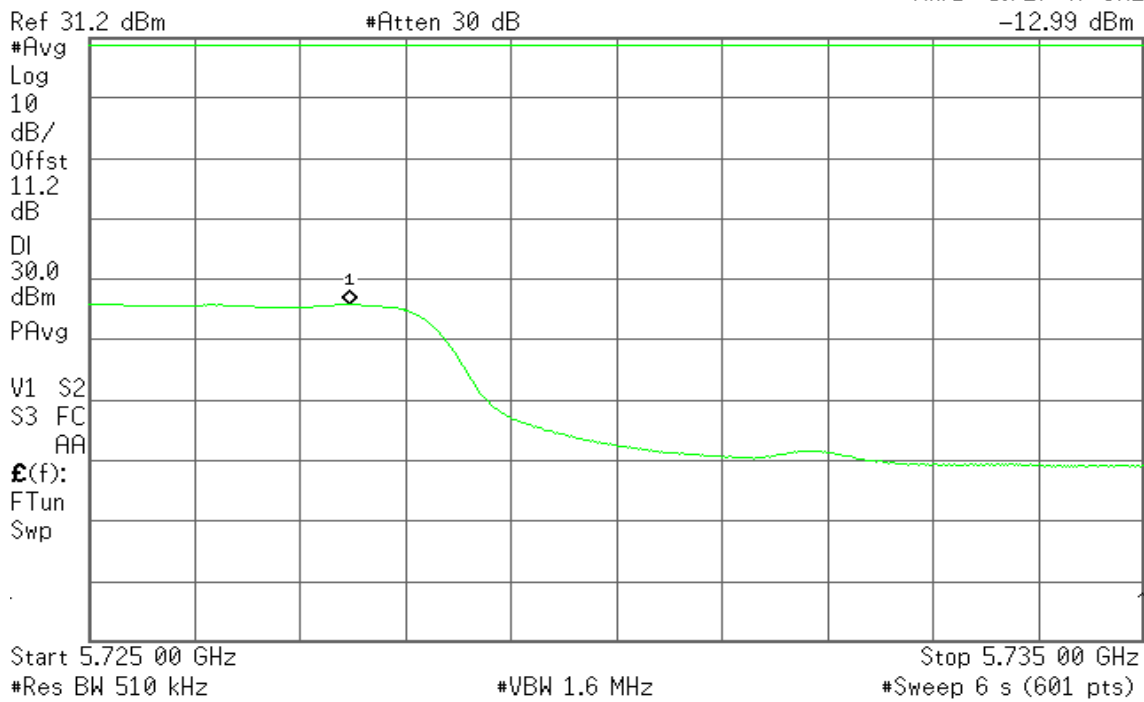



7.5 RADIATED UNDESIRABLE EMISSION

1. According to §15.209(a), except as provided elsewhere in this Subpart, the emissions from an intentional radiator shall not exceed the field strength levels specified in the following table:

Frequency (MHz)	Field Strength ($\mu\text{V/m}$)	Measurement Distance (m)
30-88	100*	3
88-216	150*	3
216-960	200*	3
Above 960	500	3

Remark: Except as provided in paragraph (g), fundamental emissions from intentional radiators operating under this Section shall not be located in the frequency bands 54-72 MHz, 76-88 MHz, 174-216 MHz or 470-806 MHz. However, operation within these frequency bands is permitted under other sections of this Part, e.g., Sections 15.231 and 15.241.

2. In the emission table above, the tighter limit applies at the band edges.

Frequency (MHz)	Field Strength ($\mu\text{V/m}$ at 3-meter)	Field Strength (dB $\mu\text{V/m}$ at 3-meter)
30-88	100	40
88-216	150	43.5
216-960	200	46
Above 960	500	54



Test Configuration

9kHz ~ 30MHz

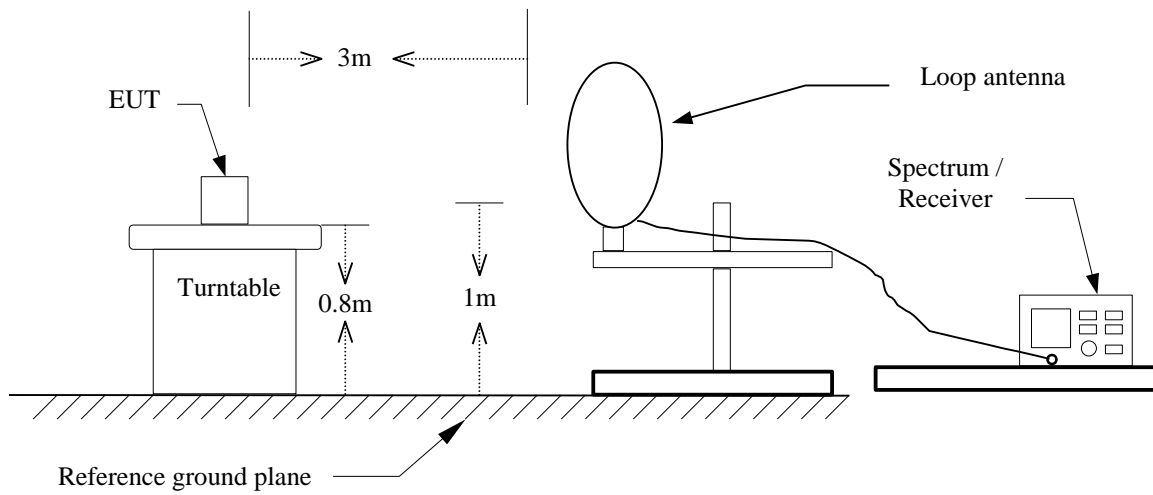

30MHz ~ 1GHz

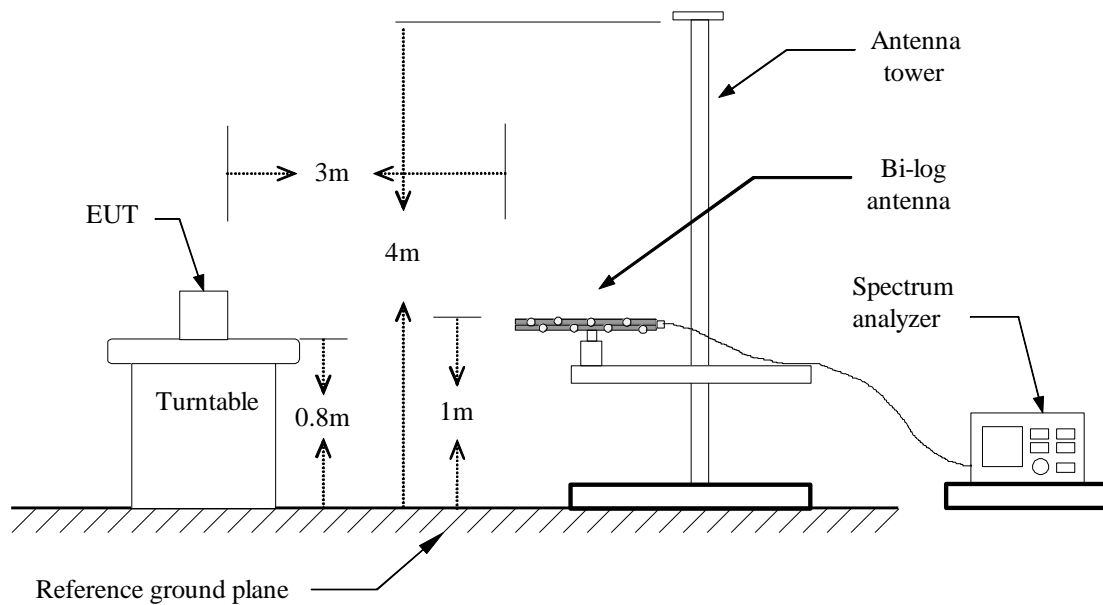



Above 1 GHz

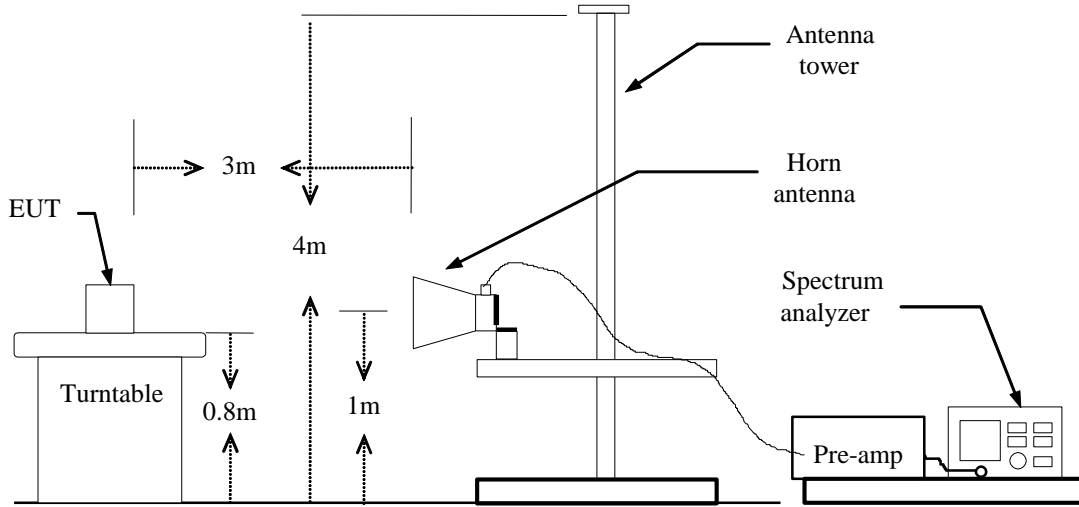



TEST PROCEDURE

1. The EUT is placed on a turntable, which is 0.8m above ground plane.
2. The turntable shall be rotated for 360 degrees to determine the position of maximum emission level.
3. EUT is set 3m away from the receiving antenna, which is varied from 1m to 4m to find out the highest emissions.
4. Maximum procedure was performed on the six highest emissions to ensure EUT compliance.
5. And also, each emission was to be maximized by changing the polarization of receiving antenna both horizontal and vertical.
6. Set the spectrum analyzer in the following setting as:

Below 1GHz:

RBW=100kHz / VBW=300kHz / Sweep=AUTO

Above 1GHz:

(a) PEAK: RBW=1MHz / VBW=3MHz / Sweep=AUTO

(b) AVERAGE: RBW=1MHz,
if duty cycle $\geq 98\%$, VBW=10Hz.
if duty cycle $< 98\%$ VBW=1/T.

IEEE 802.11b mode: $\geq 98\%$, VBW=10Hz

IEEE 802.11g mode: $\geq 98\%$, VBW=10Hz

IEEE 802.11n HT 20 MHz mode: $\geq 98\%$, VBW=10Hz

IEEE 802.11n HT 40 MHz mode: $96\% = \text{VBW } 2\text{kHz}$

7. Repeat above procedures until the measurements for all frequencies are complete.

**TEST RESULTS****Below 1 GHz****Operation Mode:** Normal Link**Test Date:** February 14, 2015**Temperature:** 27°C**Tested by:** Dennis Li**Humidity:** 53% RH**Polarity:** Ver. / Hor.

Frequency (MHz)	Reading (dBuV)	Correction Factor (dB/m)	Result (dBuV/m)	Limit (dBuV/m)	Margin (dB)	Remark	Ant.Pol. (H/V)
36.7900	44.92	-14.85	30.07	40.00	-9.93	Peak	V
157.0700	46.07	-18.19	27.88	43.50	-15.62	Peak	V
233.7000	53.49	-18.73	34.76	46.00	-11.24	Peak	V
268.6200	54.05	-17.04	37.01	46.00	-8.99	Peak	V
450.0100	43.07	-12.66	30.41	46.00	-15.59	Peak	V
594.5400	40.42	-10.56	29.86	46.00	-16.14	Peak	V
36.7900	47.70	-14.85	32.85	40.00	-7.15	Peak	H
157.0700	53.57	-18.19	35.38	43.50	-8.12	Peak	H
234.6700	57.83	-18.71	39.12	46.00	-6.88	Peak	H
255.0400	57.12	-18.04	39.08	46.00	-6.92	Peak	H
366.5900	49.03	-14.80	34.23	46.00	-11.77	Peak	H
450.0100	48.47	-12.66	35.81	46.00	-10.19	Peak	H

Remark:

- 1 Measuring frequencies from 30 MHz to the 1GHz.
- 2 Radiated emissions measured in frequency range from 30 MHz to 1000MHz were made with an instrument using peak/quasi-peak detector mode.
- 3 Quasi-peak test would be performed if the peak result were greater than the quasi-peak limit or as required by the applicant.
- 4 Measurements above show only up to 6 maximum emissions noted, or would be lesser, with " N/A " remark, if no specific emissions from the EUT are recorded (ie: margin>20dB from the applicable limit) and considered that's already beyond the background noise floor.
- 5 Margin (dB) = Remark result (dBuV/m) – Quasi-peak limit (dBuV/m).



Above 1 GHz

Operation Mode: Tx / IEEE 802.11a mode / 5180 ~ 5240MHz / CH Low **Test Date:** February 6, 2015
Temperature: 27°C **Tested by:** Dennis Li
Humidity: 53% RH **Polarity:** Ver. / Hor.

Frequency (MHz)	Reading (dBuV)	Correction (dB/m)	Result (dBuV/m)	Limit (dBuV/m)	Margin (dB)	Remark	Ant.Pol. (H/V)
3275.000	51.35	-1.45	49.90	74.00	-24.10	peak	V
10940.000	32.95	16.78	49.73	74.00	-24.27	peak	V
13280.000	31.78	19.52	51.30	74.00	-22.70	peak	V
N/A							
2596.000	49.95	-2.93	47.02	74.00	-26.98	peak	H
10940.000	35.13	16.78	51.91	74.00	-22.09	peak	H
12500.000	33.30	17.73	51.03	74.00	-22.97	peak	H
N/A							

Remark:

1. Measuring frequencies from 1 GHz to the 10th harmonic of highest fundamental frequency.
2. Radiated emissions measured in frequency above 1000MHz were made with an instrument using peak/average detector mode.
3. Average test would be performed if the peak result were greater than the average limit.
4. Data of measurement within this frequency range shown “ --- ” in the table above means the reading of emissions are attenuated more than 20dB below the permissible limits or the field strength is too small to be measured.
5. Measurements above show only up to 6 maximum emissions noted, or would be lesser, with “ N/A ” remark, if no specific emissions from the EUT are recorded (ie: margin>20dB from the applicable limit) and considered that's already beyond the background noise floor.
6. Margin (dB) = Remark result (dBuV/m) – Average limit (dBuV/m).



Operation Mode: Tx / IEEE 802.11a mode / 5180 ~ 5240MHz / CH Mid **Test Date:** February 11, 2015
Temperature: 27°C **Tested by:** Dennis Li
Humidity: 53% RH **Polarity:** Ver. / Hor.

Frequency (MHz)	Reading (dBuV)	Correction (dB/m)	Result (dBuV/m)	Limit (dBuV/m)	Margin (dB)	Remark	Ant.Pol. (H/V)
1595.000	57.89	-7.03	50.86	74.00	-23.14	peak	V
10310.000	29.95	16.30	46.25	74.00	-27.75	peak	V
12520.000	31.89	17.80	49.69	74.00	-24.31	peak	V
N/A							
1399.000	57.81	-7.97	49.84	74.00	-24.16	peak	H
11870.000	32.94	17.11	50.05	74.00	-23.95	peak	H
14290.000	32.32	20.40	52.72	74.00	-21.28	peak	H
N/A							

Remark:

1. Measuring frequencies from 1 GHz to the 10th harmonic of highest fundamental frequency.
2. Radiated emissions measured in frequency above 1000MHz were made with an instrument using peak/average detector mode.
3. Average test would be performed if the peak result were greater than the average limit.
4. Data of measurement within this frequency range shown “ --- ” in the table above means the reading of emissions are attenuated more than 20dB below the permissible limits or the field strength is too small to be measured.
5. Measurements above show only up to 6 maximum emissions noted, or would be lesser, with “ N/A ” remark, if no specific emissions from the EUT are recorded (ie: margin>20dB from the applicable limit) and considered that's already beyond the background noise floor.
6. Margin (dB) = Remark result (dBuV/m) – Average limit (dBuV/m).



Operation Mode: Tx / IEEE 802.11a mode / 5180 ~ 5240MHz / CH High

Test Date: February 6, 2015

Temperature: 27°C

Tested by: Dennis Li

Humidity: 53% RH

Polarity: Ver. / Hor.

Frequency (MHz)	Reading (dBuV)	Correction (dB/m)	Result (dBuV/m)	Limit (dBuV/m)	Margin (dB)	Remark	Ant.Pol. (H/V)
2589.000	49.69	-2.94	46.75	74.00	-27.25	peak	V
10950.000	33.13	16.77	49.90	74.00	-24.10	peak	V
13370.000	32.99	19.55	52.54	74.00	-21.46	peak	V
N/A							
3093.000	51.38	-1.89	49.49	74.00	-24.51	peak	H
10760.000	32.77	16.94	49.71	74.00	-24.29	peak	H
14290.000	32.19	20.40	52.59	74.00	-21.41	peak	H
N/A							

Remark:

1. Measuring frequencies from 1 GHz to the 10th harmonic of highest fundamental frequency.
2. Radiated emissions measured in frequency above 1000MHz were made with an instrument using peak/average detector mode.
3. Average test would be performed if the peak result were greater than the average limit.
4. Data of measurement within this frequency range shown “ --- ” in the table above means the reading of emissions are attenuated more than 20dB below the permissible limits or the field strength is too small to be measured.
5. Measurements above show only up to 6 maximum emissions noted, or would be lesser, with “ N/A ” remark, if no specific emissions from the EUT are recorded (ie: margin>20dB from the applicable limit) and considered that's already beyond the background noise floor.
6. Margin (dB) = Remark result (dBuV/m) – Average limit (dBuV/m).



Operation Mode: Tx / IEEE 802.11n HT 20 MHz Channel mode / 5180 ~ 5240MHz / CH Low

Test Date: February 6, 2015

Temperature: 27°C

Tested by: Dennis Li

Humidity: 53% RH

Polarity: Ver. / Hor.

Frequency (MHz)	Reading (dBuV)	Correction (dB/m)	Result (dBuV/m)	Limit (dBuV/m)	Margin (dB)	Remark	Ant.Pol. (H/V)
2638.000	50.39	-2.84	47.55	74.00	-26.45	peak	V
10690.000	29.78	17.00	46.78	74.00	-27.22	peak	V
12960.000	30.65	19.29	49.94	74.00	-24.06	peak	V
N/A							
2757.000	49.11	-2.60	46.51	74.00	-27.49	peak	H
10680.000	30.84	17.01	47.85	74.00	-26.15	peak	H
12560.000	31.66	17.93	49.59	74.00	-24.41	peak	H
N/A							

Remark:

1. Measuring frequencies from 1 GHz to the 10th harmonic of highest fundamental frequency.
2. Radiated emissions measured in frequency above 1000MHz were made with an instrument using peak/average detector mode.
3. Average test would be performed if the peak result were greater than the average limit.
4. Data of measurement within this frequency range shown " --- " in the table above means the reading of emissions are attenuated more than 20dB below the permissible limits or the field strength is too small to be measured.
5. Measurements above show only up to 6 maximum emissions noted, or would be lesser, with " N/A " remark, if no specific emissions from the EUT are recorded (ie: margin>20dB from the applicable limit) and considered that's already beyond the background noise floor.
6. Margin (dB) = Remark result (dBuV/m) – Average limit (dBuV/m).



Operation Mode: Tx / IEEE 802.11n HT 20 MHz Channel mode / 5180 ~ 5240MHz / CH Mid

Test Date: February 11, 2015

Temperature: 27°C

Tested by: Dennis Li

Humidity: 53% RH

Polarity: Ver. / Hor.

Frequency (MHz)	Reading (dBuV)	Correction (dB/m)	Result (dBuV/m)	Limit (dBuV/m)	Margin (dB)	Remark	Ant.Pol. (H/V)
1595.000	57.47	-7.03	50.44	74.00	-23.56	peak	V
9160.000	34.09	13.89	47.98	74.00	-26.02	peak	V
14260.000	31.46	20.38	51.84	74.00	-22.16	peak	V
N/A							
1399.000	57.91	-7.97	49.94	74.00	-24.06	peak	H
10920.000	32.75	16.80	49.55	74.00	-24.45	peak	H
15200.000	32.51	18.94	51.45	74.00	-22.55	peak	H
N/A							

Remark:

1. Measuring frequencies from 1 GHz to the 10th harmonic of highest fundamental frequency.
2. Radiated emissions measured in frequency above 1000MHz were made with an instrument using peak/average detector mode.
3. Average test would be performed if the peak result were greater than the average limit.
4. Data of measurement within this frequency range shown " --- " in the table above means the reading of emissions are attenuated more than 20dB below the permissible limits or the field strength is too small to be measured.
5. Measurements above show only up to 6 maximum emissions noted, or would be lesser, with " N/A " remark, if no specific emissions from the EUT are recorded (ie: margin>20dB from the applicable limit) and considered that's already beyond the background noise floor.
6. Margin (dB) = Remark result (dBuV/m) – Average limit (dBuV/m).



Operation Mode: Tx / IEEE 802.11n HT 20 MHz Channel mode / 5180 ~ 5240MHz / CH High **Test Date:** February 7, 2015
Temperature: 27°C **Tested by:** Dennis Li
Humidity: 53% RH **Polarity:** Ver. / Hor.

Frequency (MHz)	Reading (dBuV)	Correction (dB/m)	Result (dBuV/m)	Limit (dBuV/m)	Margin (dB)	Remark	Ant.Pol. (H/V)
2267.000	51.76	-4.34	47.42	74.00	-26.58	peak	V
10880.000	32.56	16.83	49.39	74.00	-24.61	peak	V
14420.000	32.26	20.51	52.77	74.00	-21.23	peak	V
N/A							
3072.000	51.52	-1.94	49.58	74.00	-24.42	peak	H
10880.000	32.31	16.83	49.14	74.00	-24.86	peak	H
12670.000	31.97	18.31	50.28	74.00	-23.72	peak	H
N/A							

Remark:

1. Measuring frequencies from 1 GHz to the 10th harmonic of highest fundamental frequency.
2. Radiated emissions measured in frequency above 1000MHz were made with an instrument using peak/average detector mode.
3. Average test would be performed if the peak result were greater than the average limit.
4. Data of measurement within this frequency range shown " --- " in the table above means the reading of emissions are attenuated more than 20dB below the permissible limits or the field strength is too small to be measured.
5. Measurements above show only up to 6 maximum emissions noted, or would be lesser, with " N/A " remark, if no specific emissions from the EUT are recorded (ie: margin>20dB from the applicable limit) and considered that's already beyond the background noise floor.
6. Margin (dB) = Remark result (dBuV/m) – Average limit (dBuV/m).



Operation Mode: Tx / IEEE 802.11n HT 40 MHz mode / 5190 ~ 5230MHz / CH Low **Test Date:** February 6, 2015
Temperature: 27°C **Tested by:** Dennis Li
Humidity: 53% RH **Polarity:** Ver. / Hor.

Frequency (MHz)	Reading (dBuV)	Correction (dB/m)	Result (dBuV/m)	Limit (dBuV/m)	Margin (dB)	Remark	Ant.Pol. (H/V)
3324.000	50.61	-1.33	49.28	74.00	-24.72	peak	V
10960.000	33.07	16.76	49.83	74.00	-24.17	peak	V
16130.000	32.71	19.94	52.65	74.00	-21.35	peak	V
N/A							
2792.000	50.81	-2.53	48.28	74.00	-25.72	peak	H
9170.000	35.47	13.89	49.36	74.00	-24.64	peak	H
11840.000	33.60	17.08	50.68	74.00	-23.32	peak	H
N/A							

Remark:

1. Measuring frequencies from 1 GHz to the 10th harmonic of highest fundamental frequency.
2. Radiated emissions measured in frequency above 1000MHz were made with an instrument using peak/average detector mode.
3. Average test would be performed if the peak result were greater than the average limit.
4. Data of measurement within this frequency range shown “ --- ” in the table above means the reading of emissions are attenuated more than 20dB below the permissible limits or the field strength is too small to be measured.
5. Measurements above show only up to 6 maximum emissions noted, or would be lesser, with “ N/A ” remark, if no specific emissions from the EUT are recorded (ie: margin>20dB from the applicable limit) and considered that's already beyond the background noise floor.
6. Margin (dB) = Remark result (dBuV/m) – Average limit (dBuV/m).



Operation Mode: Tx / IEEE 802.11n HT 40 MHz mode / 5190 ~ 5230MHz / CH High **Test Date:** February 7, 2015
Temperature: 27°C **Tested by:** Dennis Li
Humidity: 53% RH **Polarity:** Ver. / Hor.

Frequency (MHz)	Reading (dBuV)	Correction (dB/m)	Result (dBuV/m)	Limit (dBuV/m)	Margin (dB)	Remark	Ant.Pol. (H/V)
2792.000	49.61	-2.53	47.08	74.00	-26.92	peak	V
11010.000	31.52	16.73	48.25	74.00	-25.75	peak	V
14080.000	32.10	20.23	52.33	74.00	-21.67	peak	V
N/A							
1595.000	52.63	-7.03	45.60	74.00	-28.40	peak	H
8450.000	34.37	13.65	48.02	74.00	-25.98	peak	H
13440.000	32.61	19.57	52.18	74.00	-21.82	peak	H
N/A							

Remark:

1. Measuring frequencies from 1 GHz to the 10th harmonic of highest fundamental frequency.
2. Radiated emissions measured in frequency above 1000MHz were made with an instrument using peak/average detector mode.
3. Average test would be performed if the peak result were greater than the average limit.
4. Data of measurement within this frequency range shown " --- " in the table above means the reading of emissions are attenuated more than 20dB below the permissible limits or the field strength is too small to be measured.
5. Measurements above show only up to 6 maximum emissions noted, or would be lesser, with " N/A " remark, if no specific emissions from the EUT are recorded (ie: margin>20dB from the applicable limit) and considered that's already beyond the background noise floor.
6. Margin (dB) = Remark result (dBuV/m) – Average limit (dBuV/m).



Operation Mode: Tx / IEEE 802.11ac VHT 80 MHz mode / 5210MHz / CH Mid

Test Date: February 6, 2015

Temperature: 27°C

Tested by: Dennis Li

Humidity: 53% RH

Polarity: Ver. / Hor.

Frequency (MHz)	Reading (dBuV)	Correction (dB/m)	Result (dBuV/m)	Limit (dBuV/m)	Margin (dB)	Remark	Ant.Pol. (H/V)
2484.000	49.76	-3.27	46.49	74.00	-27.51	peak	V
10970.000	33.56	16.76	50.32	74.00	-23.68	peak	V
14950.000	33.94	19.07	53.01	74.00	-20.99	peak	V
N/A							
3079.000	50.16	-1.92	48.24	74.00	-25.76	peak	H
11080.000	33.37	16.74	50.11	74.00	-23.89	peak	H
14120.000	32.30	20.27	52.57	74.00	-21.43	peak	H
N/A							

Remark:

1. Measuring frequencies from 1 GHz to the 10th harmonic of highest fundamental frequency.
2. Radiated emissions measured in frequency above 1000MHz were made with an instrument using peak/average detector mode.
3. Average test would be performed if the peak result were greater than the average limit.
4. Data of measurement within this frequency range shown " --- " in the table above means the reading of emissions are attenuated more than 20dB below the permissible limits or the field strength is too small to be measured.
5. Measurements above show only up to 6 maximum emissions noted, or would be lesser, with " N/A " remark, if no specific emissions from the EUT are recorded (ie: margin>20dB from the applicable limit) and considered that's already beyond the background noise floor.
6. Margin (dB) = Remark result (dBuV/m) – Average limit (dBuV/m).



Operation Mode: Tx / IEEE 802.11a mode / 5260 ~ 5320MHz / CH Low **Test Date:** February 6, 2015
Temperature: 27°C **Tested by:** Dennis Li
Humidity: 53% RH **Polarity:** Ver. / Hor.

Frequency (MHz)	Reading (dBuV)	Correction (dB/m)	Result (dBuV/m)	Limit (dBuV/m)	Margin (dB)	Remark	Ant.Pol. (H/V)
3366.000	51.06	-1.23	49.83	74.00	-24.17	peak	V
11690.000	32.54	16.95	49.49	74.00	-24.51	peak	V
13320.000	32.39	19.53	51.92	74.00	-22.08	peak	V
N/A							
3289.000	50.86	-1.42	49.44	74.00	-24.56	peak	H
10930.000	33.80	16.79	50.59	74.00	-23.41	peak	H
13300.000	31.73	19.53	51.26	74.00	-22.74	peak	H
N/A							

Remark:

1. Measuring frequencies from 1 GHz to the 10th harmonic of highest fundamental frequency.
2. Radiated emissions measured in frequency above 1000MHz were made with an instrument using peak/average detector mode.
3. Average test would be performed if the peak result were greater than the average limit.
4. Data of measurement within this frequency range shown “ --- ” in the table above means the reading of emissions are attenuated more than 20dB below the permissible limits or the field strength is too small to be measured.
5. Measurements above show only up to 6 maximum emissions noted, or would be lesser, with “ N/A ” remark, if no specific emissions from the EUT are recorded (ie: margin>20dB from the applicable limit) and considered that's already beyond the background noise floor.
6. Margin (dB) = Remark result (dBuV/m) – Average limit (dBuV/m).



Operation Mode: Tx / IEEE 802.11a mode / 5260 ~ 5320MHz / CH Mid **Test Date:** February 6, 2015
Temperature: 27°C **Tested by:** Dennis Li
Humidity: 53% RH **Polarity:** Ver. / Hor.

Frequency (MHz)	Reading (dBuV)	Correction (dB/m)	Result (dBuV/m)	Limit (dBuV/m)	Margin (dB)	Remark	Ant.Pol. (H/V)
1952.000	53.47	-5.13	48.34	74.00	-25.66	peak	V
10910.000	33.30	16.81	50.11	74.00	-23.89	peak	V
14300.000	31.82	20.41	52.23	74.00	-21.77	peak	V
N/A							
1952.000	51.12	-5.13	45.99	74.00	-28.01	peak	H
10930.000	31.62	16.79	48.41	74.00	-25.59	peak	H
13990.000	30.95	20.16	51.11	74.00	-22.89	peak	H
N/A							

Remark:

1. Measuring frequencies from 1 GHz to the 10th harmonic of highest fundamental frequency.
2. Radiated emissions measured in frequency above 1000MHz were made with an instrument using peak/average detector mode.
3. Average test would be performed if the peak result were greater than the average limit.
4. Data of measurement within this frequency range shown " --- " in the table above means the reading of emissions are attenuated more than 20dB below the permissible limits or the field strength is too small to be measured.
5. Measurements above show only up to 6 maximum emissions noted, or would be lesser, with " N/A " remark, if no specific emissions from the EUT are recorded (ie: margin>20dB from the applicable limit) and considered that's already beyond the background noise floor.
6. Margin (dB) = Remark result (dBuV/m) – Average limit (dBuV/m).



Operation Mode: Tx / IEEE 802.11a mode / 5260 ~ 5320MHz / CH High

Test Date: February 6, 2015

Temperature: 27°C

Tested by: Dennis Li

Humidity: 53% RH

Polarity: Ver. / Hor.

Frequency (MHz)	Reading (dBuV)	Correction (dB/m)	Result (dBuV/m)	Limit (dBuV/m)	Margin (dB)	Remark	Ant.Pol. (H/V)
3051.000	50.02	-1.99	48.03	74.00	-25.97	peak	V
10920.000	33.17	16.80	49.97	74.00	-24.03	peak	V
14040.000	32.01	20.20	52.21	74.00	-21.79	peak	V
N/A							
3030.000	49.24	-2.04	47.20	74.00	-26.80	peak	H
10920.000	32.06	16.80	48.86	74.00	-25.14	peak	H
14150.000	31.98	20.29	52.27	74.00	-21.73	peak	H
N/A							

Remark:

1. Measuring frequencies from 1 GHz to the 10th harmonic of highest fundamental frequency.
2. Radiated emissions measured in frequency above 1000MHz were made with an instrument using peak/average detector mode.
3. Average test would be performed if the peak result were greater than the average limit.
4. Data of measurement within this frequency range shown " --- " in the table above means the reading of emissions are attenuated more than 20dB below the permissible limits or the field strength is too small to be measured.
5. Measurements above show only up to 6 maximum emissions noted, or would be lesser, with " N/A " remark, if no specific emissions from the EUT are recorded (ie: margin>20dB from the applicable limit) and considered that's already beyond the background noise floor.
6. Margin (dB) = Remark result (dBuV/m) – Average limit (dBuV/m).



Operation Mode: Tx / IEEE 802.11n HT 20 MHz Channel mode / 5260 ~ 5320MHz / CH Low

Test Date: February 7, 2015

Temperature: 27°C

Tested by: Dennis Li

Humidity: 53% RH

Polarity: Ver. / Hor.

Frequency (MHz)	Reading (dBuV)	Correction (dB/m)	Result (dBuV/m)	Limit (dBuV/m)	Margin (dB)	Remark	Ant.Pol. (H/V)
3100.000	50.16	-1.87	48.29	74.00	-25.71	peak	V
10850.000	32.23	16.86	49.09	74.00	-24.91	peak	V
14320.000	31.87	20.43	52.30	74.00	-21.70	peak	V
N/A							
1595.000	54.28	-7.03	47.25	74.00	-26.75	peak	H
10910.000	31.99	16.81	48.80	74.00	-25.20	peak	H
14020.000	31.74	20.19	51.93	74.00	-22.07	peak	H
N/A							

Remark:

1. Measuring frequencies from 1 GHz to the 10th harmonic of highest fundamental frequency.
2. Radiated emissions measured in frequency above 1000MHz were made with an instrument using peak/average detector mode.
3. Average test would be performed if the peak result were greater than the average limit.
4. Data of measurement within this frequency range shown " --- " in the table above means the reading of emissions are attenuated more than 20dB below the permissible limits or the field strength is too small to be measured.
5. Measurements above show only up to 6 maximum emissions noted, or would be lesser, with " N/A " remark, if no specific emissions from the EUT are recorded (ie: margin>20dB from the applicable limit) and considered that's already beyond the background noise floor.
6. Margin (dB) = Remark result (dBuV/m) – Average limit (dBuV/m).



Operation Mode: Tx / IEEE 802.11n HT 20 MHz Channel mode / 5260 ~ 5320MHz / CH Mid

Test Date: February 7, 2015

Temperature: 27°C

Tested by: Dennis Li

Humidity: 53% RH

Polarity: Ver. / Hor.

Frequency (MHz)	Reading (dBuV)	Correction (dB/m)	Result (dBuV/m)	Limit (dBuV/m)	Margin (dB)	Remark	Ant.Pol. (H/V)
1952.000	51.30	-5.13	46.17	74.00	-27.83	peak	V
10880.000	32.20	16.83	49.03	74.00	-24.97	peak	V
13310.000	31.70	19.53	51.23	74.00	-22.77	peak	V
N/A							
							V
1994.000	50.94	-4.91	46.03	74.00	-27.97	peak	H
10640.000	31.08	17.04	48.12	74.00	-25.88	peak	H
13210.000	31.17	19.50	50.67	74.00	-23.33	peak	H
N/A							

Remark:

1. Measuring frequencies from 1 GHz to the 10th harmonic of highest fundamental frequency.
2. Radiated emissions measured in frequency above 1000MHz were made with an instrument using peak/average detector mode.
3. Average test would be performed if the peak result were greater than the average limit.
4. Data of measurement within this frequency range shown " --- " in the table above means the reading of emissions are attenuated more than 20dB below the permissible limits or the field strength is too small to be measured.
5. Measurements above show only up to 6 maximum emissions noted, or would be lesser, with " N/A " remark, if no specific emissions from the EUT are recorded (ie: margin>20dB from the applicable limit) and considered that's already beyond the background noise floor.
6. Margin (dB) = Remark result (dBuV/m) – Average limit (dBuV/m).



Operation Mode: Tx / IEEE 802.11n HT 20 MHz Channel mode / 5260 ~ 5320MHz / CH High **Test Date:** February 6, 2015
Temperature: 27°C **Tested by:** Dennis Li
Humidity: 53% RH **Polarity:** Ver. / Hor.

Frequency (MHz)	Reading (dBuV)	Correction (dB/m)	Result (dBuV/m)	Limit (dBuV/m)	Margin (dB)	Remark	Ant.Pol. (H/V)
2841.000	49.79	-2.43	47.36	74.00	-26.64	peak	V
10870.000	32.12	16.84	48.96	74.00	-25.04	peak	V
12980.000	31.05	19.36	50.41	74.00	-23.59	peak	V
N/A							
3156.000	52.08	-1.74	50.34	74.00	-23.66	peak	H
10690.000	33.33	17.00	50.33	74.00	-23.67	peak	H
13370.000	32.14	19.55	51.69	74.00	-22.31	peak	H
N/A							

Remark:

1. Measuring frequencies from 1 GHz to the 10th harmonic of highest fundamental frequency.
2. Radiated emissions measured in frequency above 1000MHz were made with an instrument using peak/average detector mode.
3. Average test would be performed if the peak result were greater than the average limit.
4. Data of measurement within this frequency range shown " --- " in the table above means the reading of emissions are attenuated more than 20dB below the permissible limits or the field strength is too small to be measured.
5. Measurements above show only up to 6 maximum emissions noted, or would be lesser, with " N/A " remark, if no specific emissions from the EUT are recorded (ie: margin>20dB from the applicable limit) and considered that's already beyond the background noise floor.
6. Margin (dB) = Remark result (dBuV/m) – Average limit (dBuV/m).



Operation Mode: Tx / IEEE 802.11n HT 40 MHz mode / 5270 ~ 5310MHz / CH Low **Test Date:** February 7, 2015
Temperature: 27°C **Tested by:** Dennis Li
Humidity: 53% RH **Polarity:** Ver. / Hor.

Frequency (MHz)	Reading (dBuV)	Correction (dB/m)	Result (dBuV/m)	Limit (dBuV/m)	Margin (dB)	Remark	Ant.Pol. (H/V)
3114.000	51.29	-1.84	49.45	74.00	-24.55	peak	V
10830.000	32.47	16.88	49.35	74.00	-24.65	peak	V
12870.000	31.75	18.99	50.74	74.00	-23.26	peak	V
N/A							
1595.000	53.69	-7.03	46.66	74.00	-27.34	peak	H
10800.000	31.58	16.90	48.48	74.00	-25.52	peak	H
13430.000	32.42	19.57	51.99	74.00	-22.01	peak	H
N/A							

Remark:

1. Measuring frequencies from 1 GHz to the 10th harmonic of highest fundamental frequency.
2. Radiated emissions measured in frequency above 1000MHz were made with an instrument using peak/average detector mode.
3. Average test would be performed if the peak result were greater than the average limit.
4. Data of measurement within this frequency range shown “ --- ” in the table above means the reading of emissions are attenuated more than 20dB below the permissible limits or the field strength is too small to be measured.
5. Measurements above show only up to 6 maximum emissions noted, or would be lesser, with “ N/A ” remark, if no specific emissions from the EUT are recorded (ie: margin>20dB from the applicable limit) and considered that's already beyond the background noise floor.
6. Margin (dB) = Remark result (dBuV/m) – Average limit (dBuV/m).



Operation Mode: Tx / IEEE 802.11n HT 40 MHz mode / 5270 ~ 5310MHz / CH High **Test Date:** February 6, 2015
Temperature: 27°C **Tested by:** Dennis Li
Humidity: 53% RH **Polarity:** Ver. / Hor.

Frequency (MHz)	Reading (dBuV)	Correction (dB/m)	Result (dBuV/m)	Limit (dBuV/m)	Margin (dB)	Remark	Ant.Pol. (H/V)
2505.000	49.59	-3.11	46.48	74.00	-27.52	peak	V
9050.000	34.21	13.88	48.09	74.00	-25.91	peak	V
12740.000	31.98	18.55	50.53	74.00	-23.47	peak	V
N/A							
3205.000	50.98	-1.62	49.36	74.00	-24.64	peak	H
10950.000	33.27	16.77	50.04	74.00	-23.96	peak	H
13430.000	32.25	19.57	51.82	74.00	-22.18	peak	H
N/A							

Remark:

1. Measuring frequencies from 1 GHz to the 10th harmonic of highest fundamental frequency.
2. Radiated emissions measured in frequency above 1000MHz were made with an instrument using peak/average detector mode.
3. Average test would be performed if the peak result were greater than the average limit.
4. Data of measurement within this frequency range shown " --- " in the table above means the reading of emissions are attenuated more than 20dB below the permissible limits or the field strength is too small to be measured.
5. Measurements above show only up to 6 maximum emissions noted, or would be lesser, with " N/A " remark, if no specific emissions from the EUT are recorded (ie: margin>20dB from the applicable limit) and considered that's already beyond the background noise floor.
6. Margin (dB) = Remark result (dBuV/m) – Average limit (dBuV/m).



Operation Mode: Tx / IEEE 802.11ac VHT 80 MHz mode / 5290 MHz / CH High

Test Date: February 6, 2015

Temperature: 27°C

Tested by: Dennis Li

Humidity: 53% RH

Polarity: Ver. / Hor.

Frequency (MHz)	Reading (dBuV)	Correction (dB/m)	Result (dBuV/m)	Limit (dBuV/m)	Margin (dB)	Remark	Ant.Pol. (H/V)
3177.000	50.60	-1.69	48.91	74.00	-25.09	peak	V
10820.000	33.31	16.88	50.19	74.00	-23.81	peak	V
13370.000	32.16	19.55	51.71	74.00	-22.29	peak	V
N/A							
2554.000	50.74	-3.01	47.73	74.00	-26.27	peak	H
9240.000	36.48	13.90	50.38	74.00	-23.62	peak	H
12630.000	33.18	18.17	51.35	74.00	-22.65	peak	H
N/A							

Remark:

1. Measuring frequencies from 1 GHz to the 10th harmonic of highest fundamental frequency.
2. Radiated emissions measured in frequency above 1000MHz were made with an instrument using peak/average detector mode.
3. Average test would be performed if the peak result were greater than the average limit.
4. Data of measurement within this frequency range shown " --- " in the table above means the reading of emissions are attenuated more than 20dB below the permissible limits or the field strength is too small to be measured.
5. Measurements above show only up to 6 maximum emissions noted, or would be lesser, with " N/A " remark, if no specific emissions from the EUT are recorded (ie: margin>20dB from the applicable limit) and considered that's already beyond the background noise floor.
6. Margin (dB) = Remark result (dBuV/m) – Average limit (dBuV/m).



Operation Mode: Tx / IEEE 802.11a mode / 5500 ~ 5700MHz / CH Low
Temperature: 27°C
Humidity: 53% RH

Test Date: February 6, 2015
Tested by: Dennis Li
Polarity: Ver. / Hor.

Frequency (MHz)	Reading (dBuV)	Correction (dB/m)	Result (dBuV/m)	Limit (dBuV/m)	Margin (dB)	Remark	Ant.Pol. (H/V)
3275.000	50.51	-1.45	49.06	74.00	-24.94	peak	V
10960.000	33.59	16.76	50.35	74.00	-23.65	peak	V
13420.000	32.41	19.56	51.97	74.00	-22.03	peak	V
N/A							
2645.000	51.43	-2.83	48.60	74.00	-25.40	peak	H
11930.000	32.60	17.16	49.76	74.00	-24.24	peak	H
15010.000	33.89	18.90	52.79	74.00	-21.21	peak	H
N/A							

Remark:

1. Measuring frequencies from 1 GHz to the 10th harmonic of highest fundamental frequency.
2. Radiated emissions measured in frequency above 1000MHz were made with an instrument using peak/average detector mode.
3. Average test would be performed if the peak result were greater than the average limit or as required by the applicant.
4. Data of measurement within this frequency range shown “ --- ” in the table above means the reading of emissions are attenuated more than 20dB below the permissible limits or the field strength is too small to be measured.
5. Measurements above show only up to 6 maximum emissions noted, or would be lesser, with “ N/A ” remark, if no specific emissions from the EUT are recorded (ie: margin>20dB from the applicable limit) and considered that's already beyond the background noise floor.
6. Margin (dB) = Remark result (dBuV/m) – Average limit (dBuV/m).



Operation Mode: Tx / IEEE 802.11a mode / 5500 ~ 5700MHz /CH Mid **Test Date:** February 6, 2015
Temperature: 27°C **Tested by:** Dennis Li
Humidity: 53% RH **Polarity:** Ver. / Hor.

Frequency (MHz)	Reading (dBuV)	Correction (dB/m)	Result (dBuV/m)	Limit (dBuV/m)	Margin (dB)	Remark	Ant.Pol. (H/V)
1595.000	54.38	-7.03	47.35	74.00	-26.65	peak	V
9210.000	34.73	13.90	48.63	74.00	-25.37	peak	V
13470.000	31.68	19.58	51.26	74.00	-22.74	peak	V
N/A							
3240.000	50.63	-1.53	49.10	74.00	-24.90	peak	H
10920.000	32.61	16.80	49.41	74.00	-24.59	peak	H
13410.000	32.14	19.56	51.70	74.00	-22.30	peak	H
N/A							

Remark:

1. Measuring frequencies from 1 GHz to the 10th harmonic of highest fundamental frequency.
2. Radiated emissions measured in frequency above 1000MHz were made with an instrument using peak/average detector mode.
3. Average test would be performed if the peak result were greater than the average limit or as required by the applicant.
4. Data of measurement within this frequency range shown “ --- ” in the table above means the reading of emissions are attenuated more than 20dB below the permissible limits or the field strength is too small to be measured.
5. Measurements above show only up to 6 maximum emissions noted, or would be lesser, with “ N/A ” remark, if no specific emissions from the EUT are recorded (ie: margin>20dB from the applicable limit) and considered that's already beyond the background noise floor.
6. Margin (dB) = Remark result (dBuV/m) – Average limit (dBuV/m).



Operation Mode: Tx / IEEE 802.11a mode / 5500 ~ 5700MHz / CH High **Test Date:** February 6, 2015
Temperature: 27°C **Tested by:** Dennis Li
Humidity: 53% RH **Polarity:** Ver. / Hor.

Frequency (MHz)	Reading (dBuV)	Correction (dB/m)	Result (dBuV/m)	Limit (dBuV/m)	Margin (dB)	Remark	Ant.Pol. (H/V)
3107.000	50.11	-1.85	48.26	74.00	-25.74	peak	V
11050.000	32.83	16.73	49.56	74.00	-24.44	peak	V
13400.000	32.19	19.56	51.75	74.00	-22.25	peak	V
N/A							
1399.000	55.50	-7.97	47.53	74.00	-26.47	peak	H
10980.000	33.17	16.75	49.92	74.00	-24.08	peak	H
14360.000	31.66	20.46	52.12	74.00	-21.88	peak	H
N/A							

Remark:

1. Measuring frequencies from 1 GHz to the 10th harmonic of highest fundamental frequency.
2. Radiated emissions measured in frequency above 1000MHz were made with an instrument using peak/average detector mode.
3. Average test would be performed if the peak result were greater than the average limit or as required by the applicant.
4. Data of measurement within this frequency range shown “ --- ” in the table above means the reading of emissions are attenuated more than 20dB below the permissible limits or the field strength is too small to be measured.
5. Measurements above show only up to 6 maximum emissions noted, or would be lesser, with “ N/A ” remark, if no specific emissions from the EUT are recorded (ie: margin>20dB from the applicable limit) and considered that's already beyond the background noise floor.
6. Margin (dB) = Remark result (dBuV/m) – Average limit (dBuV/m).



Operation Mode: Tx / IEEE 802.11n HT 20 MHz Channel mode / 5500 ~ 5700MHz / CH Low

Test Date: February 7, 2015

Temperature: 27°C

Tested by: Dennis Li

Humidity: 53% RH

Polarity: Ver. / Hor.

Frequency (MHz)	Reading (dBuV)	Correction (dB/m)	Result (dBuV/m)	Limit (dBuV/m)	Margin (dB)	Remark	Ant.Pol. (H/V)
1595.000	53.83	-7.03	46.80	74.00	-27.20	peak	V
11610.000	32.30	16.88	49.18	74.00	-24.82	peak	V
13370.000	31.67	19.55	51.22	74.00	-22.78	peak	V
N/A							
2561.000	48.62	-3.00	45.62	74.00	-28.38	peak	H
10890.000	33.63	16.82	50.45	74.00	-23.55	peak	H
12990.000	31.95	19.40	51.35	74.00	-22.65	peak	H
N/A							

Remark:

1. Measuring frequencies from 1 GHz to the 10th harmonic of highest fundamental frequency.
2. Radiated emissions measured in frequency above 1000MHz were made with an instrument using peak/average detector mode.
3. Average test would be performed if the peak result were greater than the average limit or as required by the applicant.
4. Data of measurement within this frequency range shown “ --- ” in the table above means the reading of emissions are attenuated more than 20dB below the permissible limits or the field strength is too small to be measured.
5. Measurements above show only up to 6 maximum emissions noted, or would be lesser, with “ N/A ” remark, if no specific emissions from the EUT are recorded (ie: margin>20dB from the applicable limit) and considered that's already beyond the background noise floor.
6. Margin (dB) = Remark result (dBuV/m) – Average limit (dBuV/m).



Operation Mode: Tx / IEEE 802.11n HT 20 MHz Channel mode / 5500 ~ 5700MHz / CH Mid

Test Date: February 6, 2015

Temperature: 27°C

Tested by: Dennis Li

Humidity: 53% RH

Polarity: Ver. / Hor.

Frequency (MHz)	Reading (dBuV)	Correction (dB/m)	Result (dBuV/m)	Limit (dBuV/m)	Margin (dB)	Remark	Ant.Pol. (H/V)
2596.000	49.88	-2.93	46.95	74.00	-27.05	peak	V
10650.000	31.79	17.03	48.82	74.00	-25.18	peak	V
13360.000	31.33	19.55	50.88	74.00	-23.12	peak	V
N/A							
1392.000	55.01	-8.01	47.00	74.00	-27.00	peak	H
9180.000	34.32	13.90	48.22	74.00	-25.78	peak	H
13540.000	32.08	19.64	51.72	74.00	-22.28	peak	H
N/A							

Remark:

1. Measuring frequencies from 1 GHz to the 10th harmonic of highest fundamental frequency.
2. Radiated emissions measured in frequency above 1000MHz were made with an instrument using peak/average detector mode.
3. Average test would be performed if the peak result were greater than the average limit or as required by the applicant.
4. Data of measurement within this frequency range shown “ --- ” in the table above means the reading of emissions are attenuated more than 20dB below the permissible limits or the field strength is too small to be measured.
5. Measurements above show only up to 6 maximum emissions noted, or would be lesser, with “ N/A ” remark, if no specific emissions from the EUT are recorded (ie: margin>20dB from the applicable limit) and considered that's already beyond the background noise floor.
6. Margin (dB) = Remark result (dBuV/m) – Average limit (dBuV/m).



Operation Mode: Tx / IEEE 802.11n HT 20 MHz Channel mode / 5500 ~ 5700MHz / CH High

Test Date: February 6, 2015

Temperature: 27°C

Tested by: Dennis Li

Humidity: 53% RH

Polarity: Ver. / Hor.

Frequency (MHz)	Reading (dBuV)	Correction (dB/m)	Result (dBuV/m)	Limit (dBuV/m)	Margin (dB)	Remark	Ant.Pol. (H/V)
1798.000	52.69	-5.95	46.74	74.00	-27.26	peak	V
10580.000	30.65	17.09	47.74	74.00	-26.26	peak	V
13270.000	33.08	19.52	52.60	74.00	-21.40	peak	V
N/A							
2596.000	49.20	-2.93	46.27	74.00	-27.73	peak	H
9260.000	34.63	13.91	48.54	74.00	-25.46	peak	H
12730.000	32.71	18.51	51.22	74.00	-22.78	peak	H
N/A							

Remark:

1. Measuring frequencies from 1 GHz to the 10th harmonic of highest fundamental frequency.
2. Radiated emissions measured in frequency above 1000MHz were made with an instrument using peak/average detector mode.
3. Average test would be performed if the peak result were greater than the average limit or as required by the applicant.
4. Data of measurement within this frequency range shown “ --- ” in the table above means the reading of emissions are attenuated more than 20dB below the permissible limits or the field strength is too small to be measured.
5. Measurements above show only up to 6 maximum emissions noted, or would be lesser, with “ N/A ” remark, if no specific emissions from the EUT are recorded (ie: margin>20dB from the applicable limit) and considered that's already beyond the background noise floor.
6. Margin (dB) = Remark result (dBuV/m) – Average limit (dBuV/m).



Operation Mode: Tx / IEEE 802.11n HT 40 MHz mode / 5510 ~ 5670MHz / CH Low **Test Date:** February 7, 2015
Temperature: 27°C **Tested by:** Dennis Li
Humidity: 53% RH **Polarity:** Ver. / Hor.

Frequency (MHz)	Reading (dBuV)	Correction (dB/m)	Result (dBuV/m)	Limit (dBuV/m)	Margin (dB)	Remark	Ant.Pol. (H/V)
3107.000	50.33	-1.85	48.48	74.00	-25.52	peak	V
10840.000	33.98	16.87	50.85	74.00	-23.15	peak	V
13420.000	33.19	19.56	52.75	74.00	-21.25	peak	V
N/A							
3100.000	50.75	-1.87	48.88	74.00	-25.12	peak	H
10900.000	31.88	16.82	48.70	74.00	-25.30	peak	H
12750.000	32.51	18.58	51.09	74.00	-22.91	peak	H
N/A							

Remark:

1. Measuring frequencies from 1 GHz to the 10th harmonic of highest fundamental frequency.
2. Radiated emissions measured in frequency above 1000MHz were made with an instrument using peak/average detector mode.
3. Average test would be performed if the peak result were greater than the average limit or as required by the applicant.
4. Data of measurement within this frequency range shown “ --- ” in the table above means the reading of emissions are attenuated more than 20dB below the permissible limits or the field strength is too small to be measured.
5. Measurements above show only up to 6 maximum emissions noted, or would be lesser, with “ N/A ” remark, if no specific emissions from the EUT are recorded (ie: margin>20dB from the applicable limit) and considered that's already beyond the background noise floor.
6. Margin (dB) = Remark result (dBuV/m) – Average limit (dBuV/m).



Operation Mode: Tx / IEEE 802.11n HT 40 MHz mode / 5510 ~ 5670MHz / CH Mid **Test Date:** February 7, 2015
Temperature: 27°C **Tested by:** Dennis Li
Humidity: 53% RH **Polarity:** Ver. / Hor.

Frequency (MHz)	Reading (dBuV)	Correction (dB/m)	Result (dBuV/m)	Limit (dBuV/m)	Margin (dB)	Remark	Ant.Pol. (H/V)
2477.000	51.92	-3.32	48.60	74.00	-25.40	peak	V
8530.000	36.14	13.65	49.79	74.00	-24.21	peak	V
12920.000	30.66	19.16	49.82	74.00	-24.18	peak	V
N/A							
3072.000	51.71	-1.94	49.77	74.00	-24.23	peak	H
10910.000	32.83	16.81	49.64	74.00	-24.36	peak	H
13360.000	32.52	19.55	52.07	74.00	-21.93	peak	H
N/A							

Remark:

1. Measuring frequencies from 1 GHz to the 10th harmonic of highest fundamental frequency.
2. Radiated emissions measured in frequency above 1000MHz were made with an instrument using peak/average detector mode.
3. Average test would be performed if the peak result were greater than the average limit or as required by the applicant.
4. Data of measurement within this frequency range shown “ --- ” in the table above means the reading of emissions are attenuated more than 20dB below the permissible limits or the field strength is too small to be measured.
5. Measurements above show only up to 6 maximum emissions noted, or would be lesser, with “ N/A ” remark, if no specific emissions from the EUT are recorded (ie: margin>20dB from the applicable limit) and considered that's already beyond the background noise floor.
6. Margin (dB) = Remark result (dBuV/m) – Average limit (dBuV/m).



Operation Mode: Tx / IEEE 802.11n HT 40 MHz mode / 5510 ~ 5670MHz / CH High **Test Date:** February 7, 2015
Temperature: 27°C **Tested by:** Dennis Li
Humidity: 53% RH **Polarity:** Ver. / Hor.

Frequency (MHz)	Reading (dBuV)	Correction (dB/m)	Result (dBuV/m)	Limit (dBuV/m)	Margin (dB)	Remark	Ant.Pol. (H/V)
3212.000	50.24	-1.60	48.64	74.00	-25.36	peak	V
10700.000	31.26	16.99	48.25	74.00	-25.75	peak	V
13380.000	32.78	19.55	52.33	74.00	-21.67	peak	V
N/A							
2001.000	52.22	-4.88	47.34	74.00	-26.66	peak	H
10940.000	33.07	16.78	49.85	74.00	-24.15	peak	H
14350.000	31.75	20.45	52.20	74.00	-21.80	peak	H
N/A							

Remark:

1. Measuring frequencies from 1 GHz to the 10th harmonic of highest fundamental frequency.
2. Radiated emissions measured in frequency above 1000MHz were made with an instrument using peak/average detector mode.
3. Average test would be performed if the peak result were greater than the average limit or as required by the applicant.
4. Data of measurement within this frequency range shown “ --- ” in the table above means the reading of emissions are attenuated more than 20dB below the permissible limits or the field strength is too small to be measured.
5. Measurements above show only up to 6 maximum emissions noted, or would be lesser, with “ N/A ” remark, if no specific emissions from the EUT are recorded (ie: margin>20dB from the applicable limit) and considered that's already beyond the background noise floor.
6. Margin (dB) = Remark result (dBuV/m) – Average limit (dBuV/m).



Operation Mode: Tx / IEEE 802.11ac VHT 80 MHz mode / 5530 ~ 5690MHz / CH Low

Test Date: February 7, 2015

Temperature: 27°C

Tested by: Dennis Li

Humidity: 53% RH

Polarity: Ver. / Hor.

Frequency (MHz)	Reading (dBuV)	Correction (dB/m)	Result (dBuV/m)	Limit (dBuV/m)	Margin (dB)	Remark	Ant.Pol. (H/V)
1952.000	51.70	-5.13	46.57	74.00	-27.43	peak	V
10930.000	34.30	16.79	51.09	74.00	-22.91	peak	V
13210.000	32.77	19.50	52.27	74.00	-21.73	peak	V
N/A							
1392.000	54.37	-8.01	46.36	74.00	-27.64	peak	H
11930.000	33.04	17.16	50.20	74.00	-23.80	peak	H
14550.000	34.32	20.40	54.72	74.00	-19.28	peak	H
N/A							

Remark:

1. Measuring frequencies from 1 GHz to the 10th harmonic of highest fundamental frequency.
2. Radiated emissions measured in frequency above 1000MHz were made with an instrument using peak/average detector mode.
3. Average test would be performed if the peak result were greater than the average limit or as required by the applicant.
4. Data of measurement within this frequency range shown “ --- ” in the table above means the reading of emissions are attenuated more than 20dB below the permissible limits or the field strength is too small to be measured.
5. Measurements above show only up to 6 maximum emissions noted, or would be lesser, with “ N/A ” remark, if no specific emissions from the EUT are recorded (ie: margin>20dB from the applicable limit) and considered that's already beyond the background noise floor.
6. Margin (dB) = Remark result (dBuV/m) – Average limit (dBuV/m).



Operation Mode: Tx / IEEE 802.11ac VHT 80 MHz mode / 5530 ~ 5690MHz / CH High

Test Date: February 7, 2015

Temperature: 27°C

Tested by: Dennis Li

Humidity: 53% RH

Polarity: Ver. / Hor.

Frequency (MHz)	Reading (dBuV)	Correction (dB/m)	Result (dBuV/m)	Limit (dBuV/m)	Margin (dB)	Remark	Ant.Pol. (H/V)
1952.000	53.23	-5.13	48.10	74.00	-25.90	peak	V
10960.000	34.12	16.76	50.88	74.00	-23.12	peak	V
14950.000	34.59	19.07	53.66	74.00	-20.34	peak	V
N/A							
2540.000	50.85	-3.04	47.81	74.00	-26.19	peak	H
10960.000	34.37	16.76	51.13	74.00	-22.87	peak	H
14310.000	34.25	20.42	54.67	74.00	-19.33	peak	H
N/A							

Remark:

1. Measuring frequencies from 1 GHz to the 10th harmonic of highest fundamental frequency.
2. Radiated emissions measured in frequency above 1000MHz were made with an instrument using peak/average detector mode.
3. Average test would be performed if the peak result were greater than the average limit or as required by the applicant.
4. Data of measurement within this frequency range shown “ --- ” in the table above means the reading of emissions are attenuated more than 20dB below the permissible limits or the field strength is too small to be measured.
5. Measurements above show only up to 6 maximum emissions noted, or would be lesser, with “ N/A ” remark, if no specific emissions from the EUT are recorded (ie: margin>20dB from the applicable limit) and considered that's already beyond the background noise floor.
6. Margin (dB) = Remark result (dBuV/m) – Average limit (dBuV/m).



7.6 POWERLINE CONDUCTED EMISSIONS

LIMIT

According to §15.207(a), except as shown in paragraphs (b) and (c) of this section, for an intentional radiator that is designed to be connected to the public utility (AC) power line, the radio frequency voltage that is conducted back onto the AC power line on any frequency or frequencies within the band 150 kHz to 30 MHz shall not exceed the limits in the following table, as measured using a 50 μ H/50 ohms line impedance stabilization network (LISN). Compliance with the provisions of this paragraph shall be based on the measurement of the radio frequency voltage between each power line and ground at the power terminal. The lower limit applies at the boundary between the frequency ranges.

Frequency Range (MHz)	Limits (dB μ V)	
	Quasi-peak	Average
0.15 to 0.50	66 to 56*	56 to 46*
0.50 to 5	56	46
5 to 30	60	50

* Decreases with the logarithm of the frequency.

Test Configuration

See test photographs attached in Appendix II for the actual connections between EUT and support equipment.

TEST PROCEDURE

1. The EUT was placed on a table, which is 0.8m above ground plane.
2. Maximum procedure was performed on the six highest emissions to ensure EUT compliance.
3. Repeat above procedures until all frequency measured were complete.



TEST RESULTS

The initial step in collecting conducted data is a spectrum analyzer peak scan of the measurement range. Significant peaks are then marked as shown on the following data page, and these signals are then quasi-peaked.

Test Data

Operation Mode: Normal Link **Test Date:** February 14, 2015
Temperature: 24°C **Tested by:** Ken Tsai
Humidity: 50% RH

Freq. (MHz)	QP Reading (dBuV)	AV Reading (dBuV)	Corr. factor (dB/m)	QP Result (dBuV/m)	AV Result (dBuV/m)	QP Limit (dBuV)	AV Limit (dBuV)	QP Margin (dB)	AV Margin (dB)	Note
0.2678	33.00	31.98	9.58	42.58	41.56	61.18	51.19	-18.60	-9.63	L1
0.4876	22.71	16.02	9.58	32.29	25.60	56.21	46.21	-23.92	-20.61	L1
0.5197	36.26	27.46	9.58	45.84	37.04	56.00	46.00	-10.16	-8.96	L1
0.7229	28.38	17.64	9.59	37.97	27.23	56.00	46.00	-18.03	-18.77	L1
0.8562	28.61	17.66	9.59	38.20	27.25	56.00	46.00	-17.80	-18.75	L1
2.5752	26.91	16.17	9.60	36.51	25.77	56.00	46.00	-19.49	-20.23	L1
0.2679	32.58	31.73	9.63	42.21	41.36	61.18	51.18	-18.97	-9.82	L2
0.5039	28.72	19.06	9.63	38.35	28.69	56.00	46.00	-17.65	-17.31	L2
0.5917	26.90	17.19	9.63	36.53	26.82	56.00	46.00	-19.47	-19.18	L2
0.7316	22.93	13.73	9.64	32.57	23.37	56.00	46.00	-23.43	-22.63	L2
1.4299	18.52	11.75	9.64	28.16	21.39	56.00	46.00	-27.84	-24.61	L2
2.5111	20.16	12.60	9.65	29.81	22.25	56.00	46.00	-26.19	-23.75	L2

Remark:

1. Measuring frequencies from 0.15 MHz to 30MHz.
2. The emissions measured in frequency range from 0.15 MHz to 30MHz were made with an instrument using Quasi-peak detector and average detector.
3. The IF bandwidth of SPA between 0.15MHz to 30MHz was 10kHz; the IF bandwidth of Test Receiver between 0.15MHz to 30MHz was 9kHz;
4. L1 = Line One (Live Line) / L2 = Line Two (Neutral Line)



Test Plots

Conducted emissions (Line 1)

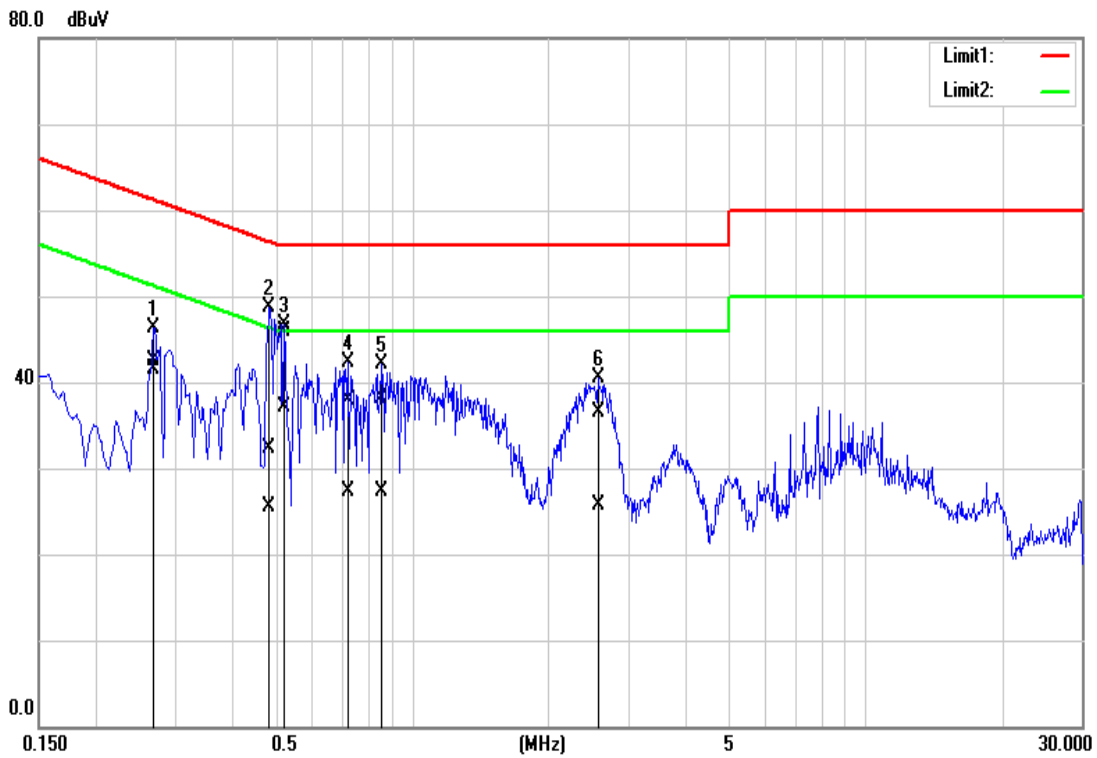

Conducted emissions (Line 2)

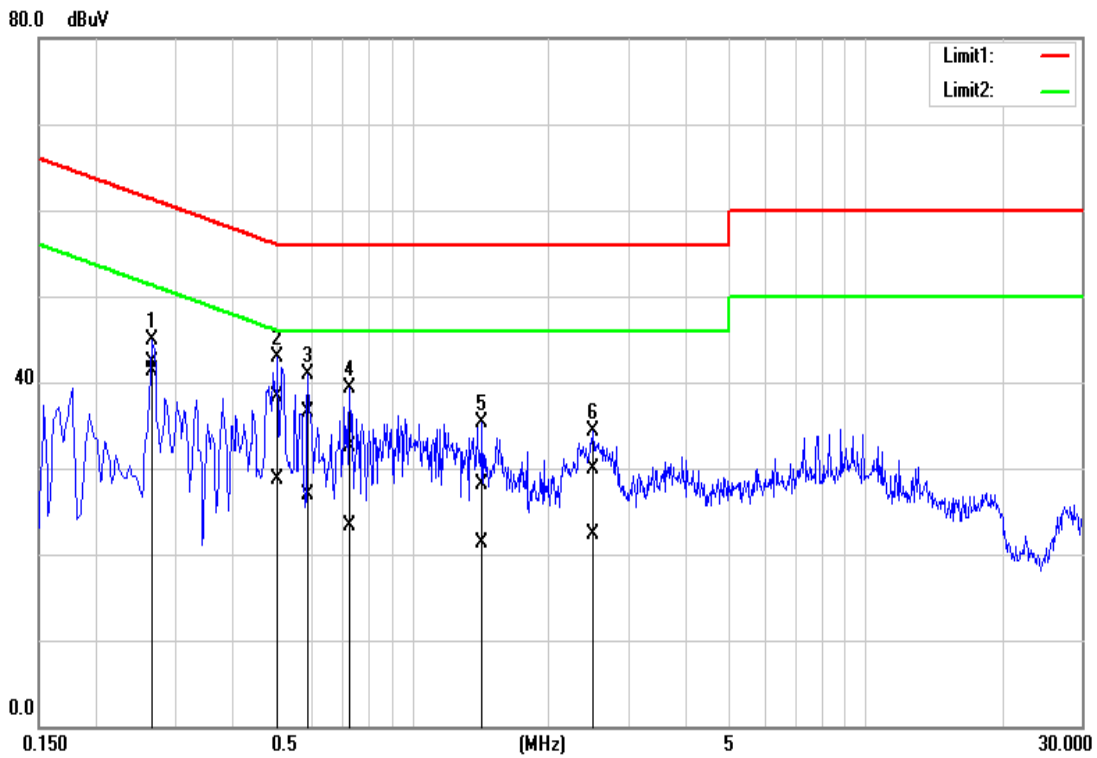



7.7 FREQUENCY STABILITY

LIMIT

According to §15.407(g), manufacturers of U-NII devices are responsible for ensuring frequency stability such that an emission is maintained within the band of operation under all conditions of normal operation as specified in the operational description.

Test Configuration

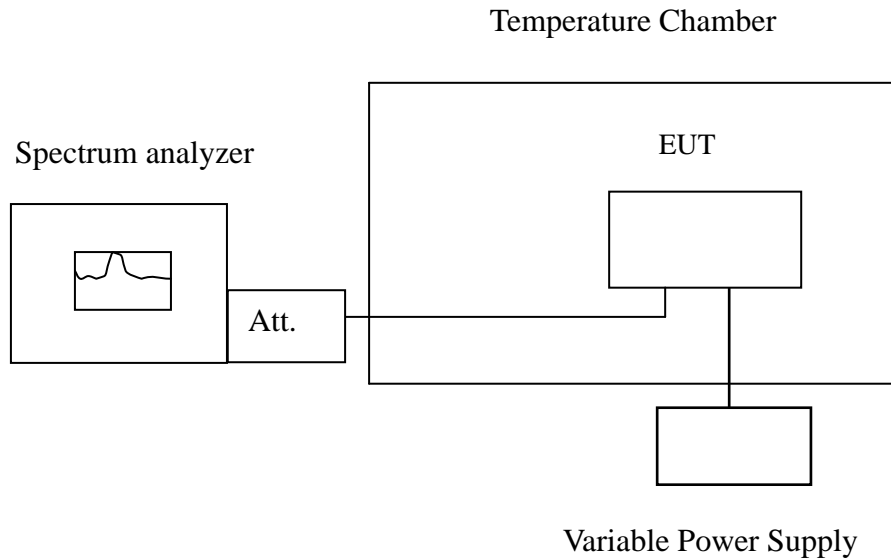

Remark: Measurement setup for testing on Antenna connector



TEST PROCEDURE

The equipment under test was connected to an external AC or DC power supply and input rated voltage. RF output was connected to a frequency counter or spectrum analyzer via feed through attenuators. The EUT was placed inside the temperature chamber. Set the spectrum analyzer RBW low enough to obtain the desired frequency resolution and measure EUT 20°C operating frequency as reference frequency. Turn EUT off and set the chamber temperature to -20°C. After the temperature stabilized for approximately 30 minutes recorded the frequency. Repeat step measure with 10°C increased per stage until the highest temperature of +50°C reached.

TEST RESULTS

No non-compliance noted.

IEEE 802.11a mode / 5180 ~ 5240 MHz:

CH Low

Operating Frequency: 5180 MHz				
Environment Temperature (°C)	Voltage (V)	Measured Frequency (MHz)	Limit Range	Test Result
50	110	5180.004301	5150~5250	Pass
40	110	5180.004425	5150~5250	Pass
30	110	5180.003250	5150~5250	Pass
20	110	5180.001933	5150~5250	Pass
10	110	5180.002111	5150~5250	Pass
0	110	5180.003310	5150~5250	Pass
-10	110	5180.004223	5150~5250	Pass
-20	110	5180.005521	5150~5250	Pass

Operating Frequency: 5180 MHz				
Environment Temperature (°C)	Voltage (V)	Measured Frequency (MHz)	Limit Range	Test Result
20	93.5	5180.002533	5150~5250	Pass
	110	5180.001933	5150~5250	Pass
	126.5	5180.001963	5150~5250	Pass



CH High

Operating Frequency: 5240 MHz				
Environment Temperature (°C)	Voltage (V)	Measured Frequency (MHz)	Limit Range	Test Result
50	110	5240.005443	5150~5250	Pass
40	110	5240.004487	5150~5250	Pass
30	110	5240.004511	5150~5250	Pass
20	110	5240.003533	5150~5250	Pass
10	110	5240.003811	5150~5250	Pass
0	110	5240.004322	5150~5250	Pass
-10	110	5240.004418	5150~5250	Pass
-20	110	5240.005651	5150~5250	Pass

Operating Frequency: 5240 MHz				
Environment Temperature (°C)	Voltage (V)	Measured Frequency (MHz)	Limit Range	Test Result
20	102	93.5	5240.003318	Pass
	120	110	5240.003533	Pass
	138	126.5	5240.003711	Pass



IEEE 802.11n HT 20 MHz Channel mode / 5180 ~ 5240 MHz:

CH Low

Operating Frequency: 5180 MHz				
Environment Temperature (°C)	Voltage (V)	Measured Frequency (MHz)	Limit Range	Test Result
50	110	5180.005301	5150~5250	Pass
40	110	5180.004412	5150~5250	Pass
30	110	5180.003431	5150~5250	Pass
20	110	5180.002140	5150~5250	Pass
10	110	5180.002822	5150~5250	Pass
0	110	5180.003651	5150~5250	Pass
-10	110	5180.004111	5150~5250	Pass
-20	110	5180.005025	5150~5250	Pass

Operating Frequency: 5180 MHz				
Environment Temperature (°C)	Voltage (V)	Measured Frequency (MHz)	Limit Range	Test Result
20	93.5	5180.002487	5150~5250	Pass
	110	5180.002140	5150~5250	Pass
	126.5	5180.002311	5150~5250	Pass



CH High

Operating Frequency: 5240 MHz				
Environment Temperature (°C)	Voltage (V)	Measured Frequency (MHz)	Limit Range	Test Result
50	110	5240.006020	5150~5250	Pass
40	110	5240.004852	5150~5250	Pass
30	110	5240.004113	5150~5250	Pass
20	110	5240.004235	5150~5250	Pass
10	110	5240.003521	5150~5250	Pass
0	110	5240.004255	5150~5250	Pass
-10	110	5240.005012	5150~5250	Pass
-20	110	5240.005783	5150~5250	Pass

Operating Frequency: 5240 MHz				
Environment Temperature (°C)	Voltage (V)	Measured Frequency (MHz)	Limit Range	Test Result
20	93.5	5240.004225	5150~5250	Pass
	110	5240.004235	5150~5250	Pass
	126.5	5240.003968	5150~5250	Pass



IEEE 802.11n HT 40 MHz mode / 5190 ~ 5230 MHz:

CH Low

Operating Frequency: 5190 MHz				
Environment Temperature (°C)	Voltage (V)	Measured Frequency (MHz)	Limit Range	Test Result
50	110	5190.006235	5150~5250	Pass
40	110	5190.005122	5150~5250	Pass
30	110	5190.004322	5150~5250	Pass
20	110	5190.003321	5150~5250	Pass
10	110	5190.003369	5150~5250	Pass
0	110	5190.003866	5150~5250	Pass
-10	110	5190.005122	5150~5250	Pass
-20	110	5190.005355	5150~5250	Pass

Operating Frequency: 5190 MHz				
Environment Temperature (°C)	Voltage (V)	Measured Frequency (MHz)	Limit Range	Test Result
20	93.5	5190.003658	5150~5250	Pass
	110	5190.003321	5150~5250	Pass
	126.5	5190.003214	5150~5250	Pass



CH High

Operating Frequency: 5230 MHz				
Environment Temperature (°C)	Voltage (V)	Measured Frequency (MHz)	Limit Range	Test Result
50	110	5230.005422	5150~5250	Pass
40	110	5230.005104	5150~5250	Pass
30	110	5230.003254	5150~5250	Pass
20	110	5230.002245	5150~5250	Pass
10	110	5230.002884	5150~5250	Pass
0	110	5230.004861	5150~5250	Pass
-10	110	5230.004247	5150~5250	Pass
-20	110	5230.005122	5150~5250	Pass

Operating Frequency: 5230 MHz				
Environment Temperature (°C)	Voltage (V)	Measured Frequency (MHz)	Limit Range	Test Result
20	93.5	5230.002369	5150~5250	Pass
	110	5230.002245	5150~5250	Pass
	126.5	5230.002269	5150~5250	Pass



IEEE 802.11ac VHT 80 MHz mode / 5210 MHz:

CH Mid

Operating Frequency: 5210 MHz				
Environment Temperature (°C)	Voltage (V)	Measured Frequency (MHz)	Limit Range	Test Result
50	110	5210.006321	5150~5250	Pass
40	110	5210.005481	5150~5250	Pass
30	110	5210.003168	5150~5250	Pass
20	110	5210.002811	5150~5250	Pass
10	110	5210.003212	5150~5250	Pass
0	110	5210.004563	5150~5250	Pass
-10	110	5210.005841	5150~5250	Pass
-20	110	5210.006211	5150~5250	Pass

Operating Frequency: 5210 MHz				
Environment Temperature (°C)	Voltage (V)	Measured Frequency (MHz)	Limit Range	Test Result
20	93.5	5210.003144	5150~5250	Pass
	110	5210.002811	5150~5250	Pass
	126.5	5210.002955	5150~5250	Pass



IEEE 802.11a mode / 5260 ~ 5320 MHz:

CH Low

Operating Frequency: 5260 MHz				
Environment Temperature (°C)	Voltage (V)	Measured Frequency (MHz)	Limit Range	Test Result
50	110	5260.002300	5250~5350	Pass
40	110	5260.001633	5250~5350	Pass
30	110	5260.001251	5250~5350	Pass
20	110	5260.001211	5250~5350	Pass
10	110	5260.001222	5250~5350	Pass
0	110	5260.002802	5250~5350	Pass
-10	110	5260.003133	5250~5350	Pass
-20	110	5260.005471	5250~5350	Pass

Operating Frequency: 5260 MHz				
Environment Temperature (°C)	Voltage (V)	Measured Frequency (MHz)	Limit Range	Test Result
20	93.5	5260.001252	5250~5350	Pass
	110	5260.001211	5250~5350	Pass
	126.5	5262.001202	5250~5350	Pass



CH High

Operating Frequency: 5320 MHz				
Environment Temperature (°C)	Voltage (V)	Measured Frequency (MHz)	Limit Range	Test Result
50	110	5320.006210	5250~5350	Pass
40	110	5320.004866	5250~5350	Pass
30	110	5320.003422	5250~5350	Pass
20	110	5320.002811	5250~5350	Pass
10	110	5320.003102	5250~5350	Pass
0	110	5320.002865	5250~5350	Pass
-10	110	5320.004123	5250~5350	Pass
-20	110	5320.005511	5250~5350	Pass

Operating Frequency: 5320 MHz				
Environment Temperature (°C)	Voltage (V)	Measured Frequency (MHz)	Limit Range	Test Result
20	93.5	5320.003155	5250~5350	Pass
	110	5320.002811	5250~5350	Pass
	126.5	5320.002833	5250~5350	Pass



IEEE 802.11n HT 20 MHz Channel mode / 5260 ~ 5320 MHz:

CH Low

Operating Frequency: 5260 MHz				
Environment Temperature (°C)	Voltage (V)	Measured Frequency (MHz)	Limit Range	Test Result
50	110	5260.004250	5250~5350	Pass
40	110	5260.003866	5250~5350	Pass
30	110	5260.002856	5250~5350	Pass
20	110	5260.001285	5250~5350	Pass
10	110	5260.002212	5250~5350	Pass
0	110	5260.002968	5250~5350	Pass
-10	110	5260.003128	5250~5350	Pass
-20	110	5260.004863	5250~5350	Pass

Operating Frequency: 5260 MHz				
Environment Temperature (°C)	Voltage (V)	Measured Frequency (MHz)	Limit Range	Test Result
20	93.5	5260.002245	5250~5350	Pass
	110	5260.001285	5250~5350	Pass
	126.5	5262.001299	5250~5350	Pass



CH High

Operating Frequency: 5320 MHz				
Environment Temperature (°C)	Voltage (V)	Measured Frequency (MHz)	Limit Range	Test Result
50	110	5320.005863	5250~5350	Pass
40	110	5320.005217	5250~5350	Pass
30	110	5320.004211	5250~5350	Pass
20	110	5320.002755	5250~5350	Pass
10	110	5320.003365	5250~5350	Pass
0	110	5320.003887	5250~5350	Pass
-10	110	5320.004514	5250~5350	Pass
-20	110	5320.005711	5250~5350	Pass

Operating Frequency: 5320 MHz				
Environment Temperature (°C)	Voltage (V)	Measured Frequency (MHz)	Limit Range	Test Result
20	93.5	5320.004213	5250~5350	Pass
	110	5320.002811	5250~5350	Pass
	126.5	5320.002988	5250~5350	Pass



IEEE 802.11n HT 40 MHz mode / 5270 ~ 5310 MHz:

CH Low

Operating Frequency: 5270 MHz				
Environment Temperature (°C)	Voltage (V)	Measured Frequency (MHz)	Limit Range	Test Result
50	110	5270.003895	5250~5350	Pass
40	110	5270.004587	5250~5350	Pass
30	110	5270.003211	5250~5350	Pass
20	110	5270.002355	5250~5350	Pass
10	110	5270.002268	5250~5350	Pass
0	110	5270.003365	5250~5350	Pass
-10	110	5270.001358	5250~5350	Pass
-20	110	5270.004458	5250~5350	Pass

Operating Frequency: 5270 MHz				
Environment Temperature (°C)	Voltage (V)	Measured Frequency (MHz)	Limit Range	Test Result
20	93.5	5270.002587	5250~5350	Pass
	110	5270.002355	5250~5350	Pass
	126.5	5270.003654	5250~5350	Pass



CH High

Operating Frequency: 5310 MHz				
Environment Temperature (°C)	Voltage (V)	Measured Frequency (MHz)	Limit Range	Test Result
50	110	5310.006841	5250~5350	Pass
40	110	5310.004726	5250~5350	Pass
30	110	5310.002763	5250~5350	Pass
20	110	5310.002244	5250~5350	Pass
10	110	5310.003584	5250~5350	Pass
0	110	5310.003215	5250~5350	Pass
-10	110	5310.004423	5250~5350	Pass
-20	110	5310.005587	5250~5350	Pass

Operating Frequency: 5310 MHz				
Environment Temperature (°C)	Voltage (V)	Measured Frequency (MHz)	Limit Range	Test Result
20	93.5	5310.002855	5250~5350	Pass
	110	5310.002244	5250~5350	Pass
	126.5	5310.004125	5250~5350	Pass



IEEE 802.11ac VHT 80 MHz mode / 5290 MHz:

CH Mid

Operating Frequency: 5290 MHz				
Environment Temperature (°C)	Voltage (V)	Measured Frequency (MHz)	Limit Range	Test Result
50	110	5290.005211	5150~5250	Pass
40	110	5290.004432	5150~5250	Pass
30	110	5290.003321	5150~5250	Pass
20	110	5290.003125	5150~5250	Pass
10	110	5290.002866	5150~5250	Pass
0	110	5290.004125	5150~5250	Pass
-10	110	5290.004236	5150~5250	Pass
-20	110	5290.004483	5150~5250	Pass

Operating Frequency: 5290 MHz				
Environment Temperature (°C)	Voltage (V)	Measured Frequency (MHz)	Limit Range	Test Result
20	93.5	5290.002896	5150~5250	Pass
	110	5290.003125	5150~5250	Pass
	126.5	5290.003311	5150~5250	Pass



IEEE 802.11a mode / 5500 ~ 5700 MHz:

CH Low

Operating Frequency: 5500 MHz				
Environment Temperature (°C)	Voltage (V)	Measured Frequency (MHz)	Limit Range	Test Result
50	110	5500.006321	5470~5725	Pass
40	110	5500.005422	5470~5725	Pass
30	110	5500.003311	5470~5725	Pass
20	110	5500.001932	5470~5725	Pass
10	110	5500.002132	5470~5725	Pass
0	110	5500.004322	5470~5725	Pass
-10	110	5500.004155	5470~5725	Pass
-20	110	5500.004939	5470~5725	Pass

Operating Frequency: 5500 MHz				
Environment Temperature (°C)	Voltage (V)	Measured Frequency (MHz)	Limit Range	Test Result
20	93.5	5500.002334	5470~5725	Pass
	110	5500.001932	5470~5725	Pass
	126.5	5500.001955	5470~5725	Pass



CH High

Operating Frequency: 5700 MHz				
Environment Temperature (°C)	Voltage (V)	Measured Frequency (MHz)	Limit Range	Test Result
50	110	5700.006511	5470~5725	Pass
40	110	5700.004511	5470~5725	Pass
30	110	5700.003422	5470~5725	Pass
20	110	5700.002588	5470~5725	Pass
10	110	5700.002622	5470~5725	Pass
0	110	5700.002933	5470~5725	Pass
-10	110	5700.003511	5470~5725	Pass
-20	110	5700.004522	5470~5725	Pass

Operating Frequency: 5700 MHz				
Environment Temperature (°C)	Voltage (V)	Measured Frequency (MHz)	Limit Range	Test Result
20	93.5	5700.002555	5470~5725	Pass
	110	5700.002588	5470~5725	Pass
	126.5	5700.002499	5470~5725	Pass



IEEE 802.11n HT 20 MHz Channel mode / 5500 ~ 5700 MHz:

CH Low

Operating Frequency: 5500 MHz				
Environment Temperature (°C)	Voltage (V)	Measured Frequency (MHz)	Limit Range	Test Result
50	110	5500.005874	5470~5725	Pass
40	110	5500.005212	5470~5725	Pass
30	110	5500.004311	5470~5725	Pass
20	110	5500.002555	5470~5725	Pass
10	110	5500.002635	5470~5725	Pass
0	110	5500.003332	5470~5725	Pass
-10	110	5500.004288	5470~5725	Pass
-20	110	5500.004696	5470~5725	Pass

Operating Frequency: 5500 MHz				
Environment Temperature (°C)	Voltage (V)	Measured Frequency (MHz)	Limit Range	Test Result
20	93.5	5500.002758	5470~5725	Pass
	110	5500.002555	5470~5725	Pass
	126.5	5500.002945	5470~5725	Pass



CH High

Operating Frequency: 5700 MHz				
Environment Temperature (°C)	Voltage (V)	Measured Frequency (MHz)	Limit Range	Test Result
50	110	5700.005847	5470~5725	Pass
40	110	5700.005124	5470~5725	Pass
30	110	5700.003155	5470~5725	Pass
20	110	5700.002156	5470~5725	Pass
10	110	5700.002369	5470~5725	Pass
0	110	5700.003258	5470~5725	Pass
-10	110	5700.004118	5470~5725	Pass
-20	110	5700.004638	5470~5725	Pass

Operating Frequency: 5700 MHz				
Environment Temperature (°C)	Voltage (V)	Measured Frequency (MHz)	Limit Range	Test Result
20	93.5	5700.002759	5470~5725	Pass
	110	5700.002156	5470~5725	Pass
	126.5	5700.002886	5470~5725	Pass



IEEE 802.11n HT 40 MHz mode / 5510 ~ 5670 MHz:

CH Low

Operating Frequency: 5510 MHz				
Environment Temperature (°C)	Voltage (V)	Measured Frequency (MHz)	Limit Range	Test Result
50	110	5510.004421	5470~5725	Pass
40	110	5510.003566	5470~5725	Pass
30	110	5510.004112	5470~5725	Pass
20	110	5510.003110	5470~5725	Pass
10	110	5510.003321	5470~5725	Pass
0	110	5510.365200	5470~5725	Pass
-10	110	5510.514200	5470~5725	Pass
-20	110	5510.485500	5470~5725	Pass

Operating Frequency: 5510 MHz				
Environment Temperature (°C)	Voltage (V)	Measured Frequency (MHz)	Limit Range	Test Result
20	93.5	5510.002455	5470~5725	Pass
	110	5510.003110	5470~5725	Pass
	126.5	5510.003655	5470~5725	Pass



CH High

Operating Frequency: 5670 MHz				
Environment Temperature (°C)	Voltage (V)	Measured Frequency (MHz)	Limit Range	Test Result
50	110	5670.003658	5470~5725	Pass
40	110	5670.004863	5470~5725	Pass
30	110	5670.003365	5470~5725	Pass
20	110	5670.002355	5470~5725	Pass
10	110	5670.002845	5470~5725	Pass
0	110	5670.003365	5470~5725	Pass
-10	110	5670.004412	5470~5725	Pass
-20	110	5670.005884	5470~5725	Pass

Operating Frequency: 5670 MHz				
Environment Temperature (°C)	Voltage (V)	Measured Frequency (MHz)	Limit Range	Test Result
20	93.5	5670.002231	5470~5725	Pass
	110	5670.002355	5470~5725	Pass
	126.5	5670.003585	5470~5725	Pass



IEEE 802.11ac VHT 80 MHz mode / 5530 ~ 5690 MHz:

CH Low

Operating Frequency: 5530 MHz				
Environment Temperature (°C)	Voltage (V)	Measured Frequency (MHz)	Limit Range	Test Result
50	110	5530.004580	5470~5725	Pass
40	110	5530.004412	5470~5725	Pass
30	110	5530.003214	5470~5725	Pass
20	110	5530.002878	5470~5725	Pass
10	110	5530.003125	5470~5725	Pass
0	110	5530.004211	5470~5725	Pass
-10	110	5530.005211	5470~5725	Pass
-20	110	5530.005183	5470~5725	Pass

Operating Frequency: 5530 MHz				
Environment Temperature (°C)	Voltage (V)	Measured Frequency (MHz)	Limit Range	Test Result
20	93.5	5530.002933	5470~5725	Pass
	110	5530.002878	5470~5725	Pass
	126.5	5530.003012	5470~5725	Pass



CH High

Operating Frequency: 5690 MHz				
Environment Temperature (°C)	Voltage (V)	Measured Frequency (MHz)	Limit Range	Test Result
50	110	5690.006122	5470~5725	Pass
40	110	5690.005411	5470~5725	Pass
30	110	5690.004486	5470~5725	Pass
20	110	5690.002546	5470~5725	Pass
10	110	5690.003652	5470~5725	Pass
0	110	5690.003482	5470~5725	Pass
-10	110	5690.004835	5470~5725	Pass
-20	110	5690.005318	5470~5725	Pass

Operating Frequency: 5690 MHz				
Environment Temperature (°C)	Voltage (V)	Measured Frequency (MHz)	Limit Range	Test Result
20	93.5	5690.002588	5470~5725	Pass
	110	5690.002546	5470~5725	Pass
	126.5	5690.003215	5470~5725	Pass