

FCC Test Report

Report No.: RF161004C22

FCC ID: VUI-RCSCON

Test Model: SCON

Received Date: Oct. 04, 2016

Test Date: Oct. 07 ~ Oct. 27, 2016

Issued Date: Nov. 02, 2016

Applicant: PEGATRON Corporation

Address: 5F NO 76 LIGONG ST BEITOU DISTRICT TAIPEI 112 TAIWAN

Issued By: Bureau Veritas Consumer Products Services (H.K.) Ltd., Taoyuan Branch

Lab Address: No. 47-2, 14th Ling, Chia Pau Vil., Lin Kou Dist., New Taipei City, Taiwan, R.O.C.

Test Location: No.19, Hwa Ya 2nd Rd., Wen Hwa Vil., Kwei Shan Dist., Taoyuan City 33383, TAIWAN (R.O.C.)



This report is for your exclusive use. Any copying or replication of this report to or for any other person or entity, or use of our name or trademark, is permitted only with our prior written permission. This report sets forth our findings solely with respect to the test samples identified herein. The results set forth in this report are not indicative or representative of the quality or characteristics of the lot from which a test sample was taken or any similar or identical product unless specifically and expressly noted. Our report includes all of the tests requested by you and the results thereof based upon the information that you provided to us. You have 60 days from date of issuance of this report to notify us of any material error or omission caused by our negligence, provided, however, that such notice shall be in writing and shall specifically address the issue you wish to raise. A failure to raise such issue within the prescribed time shall constitute your unqualified acceptance of the completeness of this report, the tests conducted and the correctness of the report contents. Unless specific mention, the uncertainty of measurement has been explicitly taken into account to declare the compliance or non-compliance to the specification. This report should not be used by the client to claim product certification, approval, or endorsement by TAF or any government agencies.

Table of Contents

Release Control Record	4
1 Certificate of Conformity	5
2 Summary of Test Results	6
2.1 Measurement Uncertainty.....	6
2.2 Modification Record.....	6
3 General Information	7
3.1 General Description of EUT.....	7
3.2 Description of Test Modes.....	8
3.2.1 Test Mode Applicability and Tested Channel Detail.....	9
3.3 Duty Cycle of Test Signal.....	11
3.4 Description of Support Units.....	12
3.4.1 Configuration of System under Test.....	12
3.5 General Description of Applied Standards.....	12
4 Test Types and Results	13
4.1 Radiated Emission and Bandedge Measurement.....	13
4.1.1 Limits of Radiated Emission and Bandedge Measurement.....	13
4.1.2 Test Instruments.....	14
4.1.3 Test Procedures.....	15
4.1.4 Deviation from Test Standard.....	15
4.1.5 Test Set Up.....	16
4.1.6 EUT Operating Conditions.....	17
4.1.7 Test Results.....	18
4.2 Conducted Emission Measurement.....	28
4.2.1 Limits of Conducted Emission Measurement.....	28
4.2.2 Test Instruments.....	28
4.2.3 Test Procedures.....	29
4.2.4 Deviation from Test Standard.....	29
4.2.5 Test Setup.....	29
4.2.6 EUT Operating Conditions.....	29
4.2.7 Test Results.....	30
4.3 6dB Bandwidth Measurement.....	32
4.3.1 Limits of 6dB Bandwidth Measurement.....	32
4.3.2 Test Setup.....	32
4.3.3 Test Instruments.....	32
4.3.4 Test Procedure.....	32
4.3.5 Deviation from Test Standard.....	32
4.3.6 EUT Operating Conditions.....	32
4.3.7 Test Result.....	33
4.4 Conducted Output Power Measurement.....	35
4.4.1 Limits of Conducted Output Power Measurement.....	35
4.4.2 Test Setup.....	35
4.4.3 Test Instruments.....	35
4.4.4 Test Procedures.....	35
4.4.5 Deviation from Test Standard.....	35
4.4.6 EUT Operating Conditions.....	35
4.4.7 Test Results.....	36
4.5 Power Spectral Density Measurement.....	37
4.5.1 Limits of Power Spectral Density Measurement.....	37
4.5.2 Test Setup.....	37
4.5.3 Test Instruments.....	37
4.5.4 Test Procedure.....	37
4.5.5 Deviation from Test Standard.....	38
4.5.6 EUT Operating Condition.....	38

4.5.7 Test Results	39
4.6 Conducted Out of Band Emission Measurement.....	41
4.6.1 Limits of Conducted Out of Band Emission Measurement	41
4.6.2 Test Setup.....	41
4.6.3 Test Instruments	41
4.6.4 Test Procedure	41
4.6.5 Deviation from Test Standard	42
4.6.6 EUT Operating Condition	42
4.6.7 Test Results	42
5 Pictures of Test Arrangements.....	46
Appendix – Information on the Testing Laboratories	47

Release Control Record

Issue No.	Description	Date Issued
RF161004C22	Original release	Nov. 02, 2016

1 Certificate of Conformity

Product: Rear Seat Remote

Brand: AUDI

Test Model: SCON

Sample Status: Engineering sample

Applicant: PEGATRON Corporation

Test Date: Oct. 07 ~ Oct. 27, 2016

Standards: 47 CFR FCC Part 15, Subpart C (Section 15.247)
ANSI C63.10:2013

The above equipment has been tested by **Bureau Veritas Consumer Products Services (H.K.) Ltd., Taoyuan Branch**, and found compliance with the requirement of the above standards. The test record, data evaluation & Equipment Under Test (EUT) configurations represented herein are true and accurate accounts of the measurements of the sample's EMC characteristics under the conditions specified in this report.

Prepared by : Celine Chou , **Date:** Nov. 02, 2016
Celine Chou / Specialist

Approved by : Ken Liu , **Date:** Nov. 02, 2016
Ken Liu / Senior Manager

2 Summary of Test Results

47 CFR FCC Part 15, Subpart C (Section 15.247)			
FCC Clause	Test Item	Result	Remarks
15.207	AC Power Conducted Emission	Pass	Meet the requirement of limit. Minimum passing margin is -10.61dB at 0.41588MHz
15.205 / 15.209 / 15.247(d)	Radiated Emissions and Band Edge Measurement	Pass	Meet the requirement of limit. Minimum passing margin is -4.3dB at 30.00MHz.
15.247(d)	Antenna Port Emission	Pass	Meet the requirement of limit.
15.247(a)(2)	6dB bandwidth	Pass	Meet the requirement of limit.
15.247(b)	Conducted power	Pass	Meet the requirement of limit.
15.247(e)	Power Spectral Density	Pass	Meet the requirement of limit.
15.203	Antenna Requirement	Pass	Antenna connector is MHF not a standard connector.

2.1 Measurement Uncertainty

Where relevant, the following measurement uncertainty levels have been estimated for tests performed on the EUT as specified in CISPR 16-4-2:

Measurement	Frequency	Expanded Uncertainty (k=2) (\pm)
Conducted Emissions at mains ports	150kHz ~ 30MHz	2.44 dB
Radiated Emissions up to 1 GHz	30MHz ~ 200MHz	3.59 dB
	200MHz ~ 1000MHz	3.60 dB
Radiated Emissions above 1 GHz	1GHz ~ 18GHz	2.29 dB
	18GHz ~ 40GHz	2.29 dB

2.2 Modification Record

There were no modifications required for compliance.

3 General Information

3.1 General Description of EUT

Product	Rear Seat Remote
Brand	AUDI
Test Model	SCON
Sample Status	Engineering sample
Power Supply Rating	24Vdc (DC power supply) 3.8Vdc (Battery)
Modulation Type	CCK, DQPSK, DBPSK for DSSS 64QAM, 16QAM, QPSK, BPSK for OFDM
Modulation Technology	DSSS, OFDM
Transfer Rate	802.11b:11.0/ 5.5/ 2.0/ 1.0Mbps 802.11g: 54.0/ 48.0/ 36.0/ 24.0/ 18.0/ 12.0/ 9.0/ 6.0Mbps 802.11n: up to 65Mbps
Operating Frequency	2412 ~ 2462MHz
Number of Channel	11
Output Power	32.434mW
Antenna Type	PIFA antenna with -0.30dBi gain
Antenna Connector	MHF
Accessory Device	Battery
Data Cable Supplied	NA

Note:

1. The EUT provides 1 completed transmitter and 1 receiver.

Modulation Mode	TX Function
802.11b	1TX
802.11g	1TX
802.11n (HT20)	1TX

2. The EUT consumes power from the following battery

Model	JS 4HS007P
Power Rating	3.8Vdc, 2700mAh 10.26Wh

3. The following RF Chipset used in the EUT.

RF Chipset Vendor Name	Model Name	SPEC
Broadcom	BCM43353	IEEE 802.11 a/b/g/n/ac

3.2 Description of Test Modes

11 channels are provided for 802.11b, 802.11g and 802.11n (HT20):

Channel	Frequency	Channel	Frequency
1	2412MHz	7	2442MHz
2	2417MHz	8	2447MHz
3	2422MHz	9	2452MHz
4	2427MHz	10	2457MHz
5	2432MHz	11	2462MHz
6	2437MHz		

3.2.1 Test Mode Applicability and Tested Channel Detail

EUT CONFIGURE MODE	APPLICABLE TO				DESCRIPTION
	RE≥1G	RE<1G	PLC	APCM	
-	√	√	√	√	-

Where **RE≥1G**: Radiated Emission above 1GHz & Bandedge Measurement
RE<1G: Radiated Emission below 1GHz
PLC: Power Line Conducted Emission
APCM: Antenna Port Conducted Measurement

Radiated Emission Test (Above 1GHz):

Pre-Scan has been conducted to determine the worst-case mode from all possible combinations between available modulations, data rates and antenna ports (if EUT with antenna diversity architecture).

Following channel(s) was (were) selected for the final test as listed below.

EUT CONFIGURE MODE	MODE	AVAILABLE CHANNEL	TESTED CHANNEL	MODULATION TECHNOLOGY	MODULATION TYPE	DATA RATE (Mbps)
-	802.11b	1 to 11	1, 6, 11	DSSS	DBPSK	1.0
-	802.11g	1 to 11	1, 6, 11	OFDM	BPSK	6.0
-	802.11n (HT20)	1 to 11	1, 6, 11	OFDM	BPSK	6.5

Radiated Emission Test (Below 1GHz):

Pre-Scan has been conducted to determine the worst-case mode from all possible combinations between available modulations, data rates and antenna ports (if EUT with antenna diversity architecture).

Following channel(s) was (were) selected for the final test as listed below.

EUT CONFIGURE MODE	MODE	AVAILABLE CHANNEL	TESTED CHANNEL	MODULATION TECHNOLOGY	MODULATION TYPE	DATA RATE (Mbps)
-	802.11b	1 to 11	6	DSSS	DBPSK	1.0

Power Line Conducted Emission Test:

Pre-Scan has been conducted to determine the worst-case mode from all possible combinations between available modulations, data rates and antenna ports (if EUT with antenna diversity architecture).

Following channel(s) was (were) selected for the final test as listed below.

EUT CONFIGURE MODE	MODE	AVAILABLE CHANNEL	TESTED CHANNEL	MODULATION TECHNOLOGY	MODULATION TYPE	DATA RATE (Mbps)
-	802.11b	1 to 11	6	DSSS	DBPSK	1.0

Antenna Port Conducted Measurement:

- This item includes all test value of each mode, but only includes spectrum plot of worst value of each mode.
- Pre-Scan has been conducted to determine the worst-case mode from all possible combinations between available modulations, data rates and antenna ports (if EUT with antenna diversity architecture).
- Following channel(s) was (were) selected for the final test as listed below.

EUT CONFIGURE MODE	MODE	AVAILABLE CHANNEL	TESTED CHANNEL	MODULATION TECHNOLOGY	MODULATION TYPE	DATA RATE (Mbps)
-	802.11b	1 to 11	1, 6, 11	DSSS	DBPSK	1.0
-	802.11g	1 to 11	1, 6, 11	OFDM	BPSK	6.0
-	802.11n (HT20)	1 to 11	1, 6, 11	OFDM	BPSK	6.5

Test Condition:

APPLICABLE TO	ENVIRONMENTAL CONDITIONS	INPUT POWER	TESTED BY
RE \geq 1G	23deg. C, 70%RH	24Vdc	Matthew Yang
RE<1G	23deg. C, 70%RH	24Vdc	Matthew Yang
PLC	25deg. C, 70%RH	24Vdc	Matthew Yang
APCM	25deg. C, 70%RH	24Vdc	Jun Wu

3.3 Duty Cycle of Test Signal

802.11b: Duty cycle of test signal is > 98%, duty factor is not required.

802.11g, 802.11n (HT20): Duty cycle of test signal is < 98 %, duty factor is required.

802.11g: Duty cycle = $1.422/1.452 = 0.979$, Duty factor = $10 * \log(1/0.979) = 0.09$

802.11n (HT20): Duty cycle = $1.333/1.365 = 0.977$, Duty factor = $10 * \log(1/0.977) = 0.10$

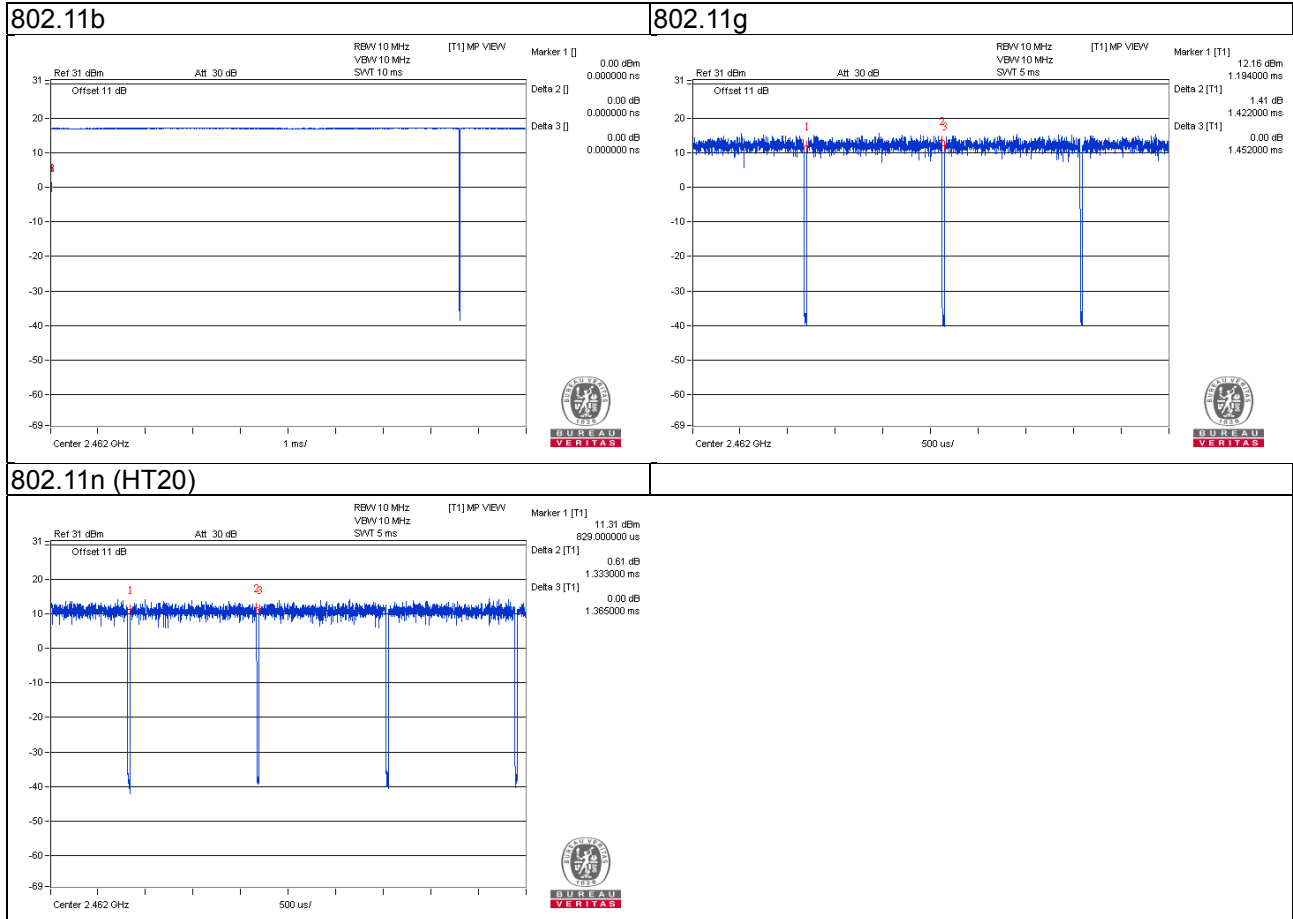

3.4 Description of Support Units

The EUT has been tested as an independent unit together with other necessary accessories or support units. The following support units or accessories were used to form a representative test configuration during the tests.

ID	Product	Brand	Model No.	Serial No.	FCC ID	Remarks
A.	DC Power Supply	TOPWARD	6303D	802236	NA	-

Note: All power cords of the above support units are non-shielded (1.8m).

ID	Descriptions	Qty.	Length (m)	Shielding (Yes/No)	Cores (Qty.)	Remarks
1.	Power cable	1	1.8	N	0	-

3.4.1 Configuration of System under Test

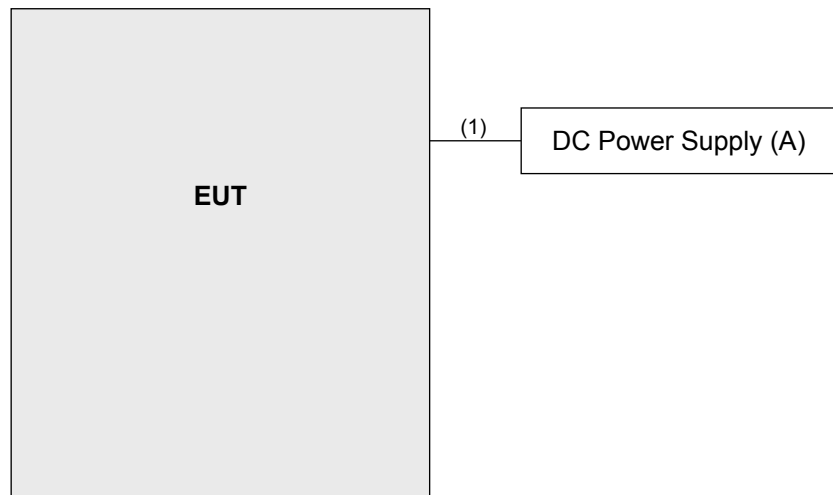

3.5 General Description of Applied Standards

The EUT is a RF Product. According to the specifications of the manufacturer, it must comply with the requirements of the following standards:

FCC Part 15, Subpart C (15.247)

KDB 558074 D01 DTS Meas Guidance v03r05

ANSI C63.10-2013

All test items have been performed and recorded as per the above standards.

Note: The EUT has been verified to comply with the requirements of FCC Part 15, Subpart B, Class B (DoC). The test report has been issued separately.

4 Test Types and Results

4.1 Radiated Emission and Bandedge Measurement

4.1.1 Limits of Radiated Emission and Bandedge Measurement

Radiated emissions which fall in the restricted bands must comply with the radiated emission limits specified as below table. Other emissions shall be at least 30dB below the highest level of the desired power:

Frequencies (MHz)	Field Strength (microvolts/meter)	Measurement Distance (meters)
0.009 ~ 0.490	2400/F(kHz)	300
0.490 ~ 1.705	24000/F(kHz)	30
1.705 ~ 30.0	30	30
30 ~ 88	100	3
88 ~ 216	150	3
216 ~ 960	200	3
Above 960	500	3

Note:

1. The lower limit shall apply at the transition frequencies.
2. Emission level (dBuV/m) = 20 log Emission level (uV/m).
3. For frequencies above 1000MHz, the field strength limits are based on average detector, however, the peak field strength of any emission shall not exceed the maximum permitted average limits, specified above by more than 30dB under any condition of modulation.

4.1.2 Test Instruments

Description & Manufacturer	Model No.	Serial No.	Cal. Date	Cal. Due
Test Receiver ROHDE & SCHWARZ	ESCI	100424	Oct. 24, 2015	Oct. 23, 2016
			Oct. 24, 2016	Oct. 23, 2017
Spectrum Analyzer ROHDE & SCHWARZ	FSP40	100040	Aug. 16, 2016	Aug. 15, 2017
BILOG Antenna SCHWARZBECK	VULB9168	9168-155	Jan. 07, 2016	Jan. 06, 2017
HORN Antenna SCHWARZBECK	BBHA 9120D	9120D-1170	Jan. 08, 2016	Jan. 07, 2017
HORN Antenna SCHWARZBECK	BBHA 9170	BBHA9170241	Jan. 18, 2016	Jan. 17, 2017
Loop Antenna	EM-6879	269	Aug. 11, 2016	Aug. 10, 2017
Preamplifier Agilent	8449B	3008A01960	Aug. 09, 2016	Aug. 08, 2017
Preamplifier Agilent	8447D	2944A10631	Aug. 09, 2016	Aug. 08, 2017
RF signal cable HUBER+SUHNER	SUCOFLEX 104	MY 13380+295012/04	Aug. 09, 2016	Aug. 08, 2017
RF signal cable HUBER+SUHNER	SUCOFLEX 104	Cable-CH4-03 (250724)	Aug. 09, 2016	Aug. 08, 2017
Software BV ADT	ADT_Radiated_ V7.6.15.9.4	NA	NA	NA
Antenna Tower inn-co GmbH	MA 4000	010303	NA	NA
Antenna Tower Controller BV ADT	AT100	AT93021703	NA	NA
Turn Table BV ADT	TT100	TT93021703	NA	NA
Turn Table Controller BV ADT	SC100	SC93021703	NA	NA
High Speed Peak Power Meter	ML2495A	0824012	Aug. 11, 2016	Aug. 10, 2017
Power Sensor	MA2411B	0738171	Aug. 11, 2016	Aug. 10, 2017

- Note:
1. The calibration interval of the above test instruments is 12 months and the calibrations are traceable to NML/ROC and NIST/USA.
 2. The test was performed in HwaYa Chamber 4.
 3. The horn antenna and preamplifier (model: 8449B) are used only for the measurement of emission frequency above 1GHz if tested.
 4. The FCC Site Registration No. is 460141.
 5. The IC Site Registration No. is IC7450F-4.
 6. The calibration interval of the loop antenna is 24 months and the calibrations are traceable to NML/ROC and NIST/USA.

4.1.3 Test Procedures

For Radiated emission below 30MHz

- a. The EUT was placed on the top of a rotating table 0.8 meters above the ground at a 3 meter chamber room. The table was rotated 360 degrees to determine the position of the highest radiation.
- b. The EUT was set 3 meters away from the interference-receiving antenna, which was mounted on the top of a variable-height antenna tower.
- c. Both X and Y axes of the antenna are set to make the measurement.
- d. For each suspected emission, the EUT was arranged to its worst case and the rotatable table was turned from 0 degrees to 360 degrees to find the maximum reading.
- e. The test-receiver system was set to Quasi-Peak Detect Function and Specified Bandwidth with Maximum Hold Mode.

Note:

1. The resolution bandwidth and video bandwidth of test receiver/spectrum analyzer is 9kHz at frequency below 30MHz.

For Radiated emission above 30MHz

- a. The EUT was placed on the top of a rotating table 0.8 meters (for 30MHz ~ 1GHz) / 1.5 meters (for above 1GHz) above the ground at 3 meter chamber room for test. The table was rotated 360 degrees to determine the position of the highest radiation.
- b. The EUT was set 3 meters away from the interference-receiving antenna, which was mounted on the top of a variable-height antenna tower.
- c. The height of antenna is varied from one meter to four meters above the ground to determine the maximum value of the field strength. Both horizontal and vertical polarizations of the antenna are set to make the measurement.
- d. For each suspected emission, the EUT was arranged to its worst case and then the antenna was tuned to heights from 1 meter to 4 meters and the rotatable table was turned from 0 degrees to 360 degrees to find the maximum reading.
- e. The test-receiver system was set to quasi-peak detect function and specified bandwidth with maximum hold mode when the test frequency is below 1 GHz.
- f. The test-receiver system was set to peak and average detect function and specified bandwidth with maximum hold mode when the test frequency is above 1 GHz. If the peak reading value also meets average limit, measurement with the average detector is unnecessary.

Note:

1. The resolution bandwidth and video bandwidth of test receiver/spectrum analyzer is 120kHz for Quasi-peak detection (QP) at frequency below 1GHz.
2. The resolution bandwidth of test receiver/spectrum analyzer is 1 MHz and the video bandwidth is 3 MHz for Peak detection (PK) at frequency above 1GHz.
3. The resolution bandwidth of test receiver/spectrum analyzer is 1MHz and the video bandwidth is $\geq 1/T$ (Duty cycle < 98%) or 10Hz (Duty cycle $\geq 98\%$) for Average detection (AV) at frequency above 1GHz.
4. All modes of operation were investigated and the worst-case emissions are reported.

4.1.4 Deviation from Test Standard

No deviation.

4.1.5 Test Set Up

For Radiated emission below 30MHz

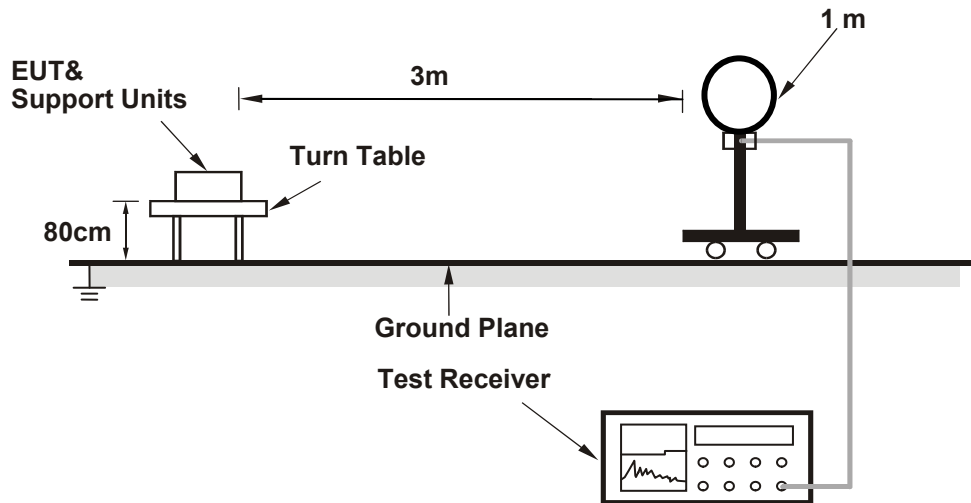

For Radiated emission 30MHz to 1GHz

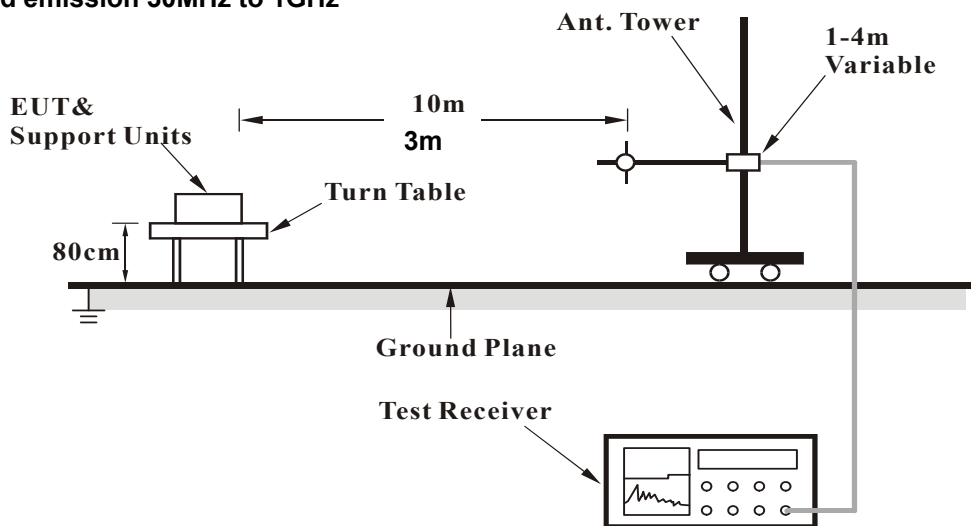

For Radiated emission above 1GHz

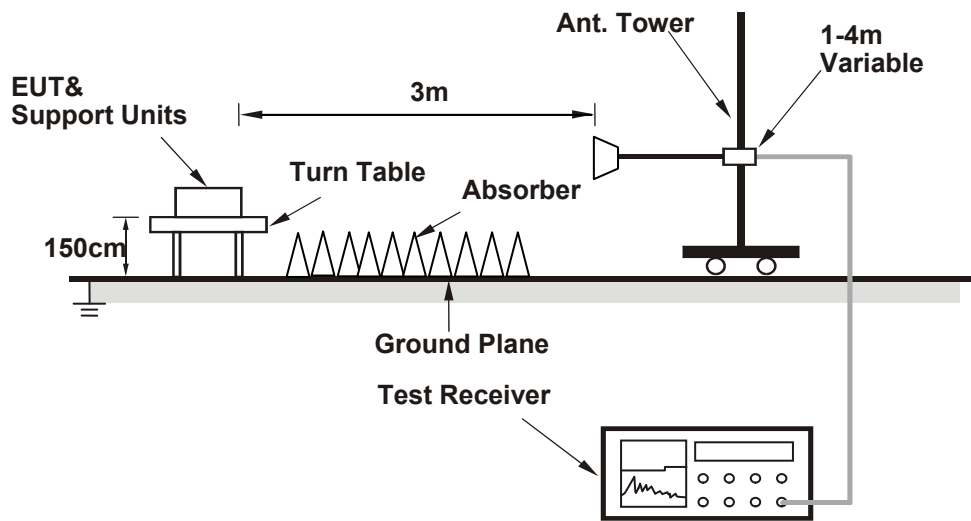

For the actual test configuration, please refer to the attached file (Test Setup Photo).

4.1.6 EUT Operating Conditions

Set the EUT under transmission condition continuously at specific channel frequency.

4.1.7 Test Results

Above 1GHz worst-Case data:

802.11b

CHANNEL	TX Channel 1	DETECTOR	Peak (PK)
FREQUENCY RANGE	1GHz ~ 25GHz	FUNCTION	Average (AV)

ANTENNA POLARITY & TEST DISTANCE: HORIZONTAL AT 3 M								
NO.	FREQ. (MHz)	EMISSION LEVEL (dBuV/m)	LIMIT (dBuV/m)	MARGIN (dB)	ANTENNA HEIGHT (m)	TABLE ANGLE (Degree)	RAW VALUE (dBuV)	CORRECTION FACTOR (dB/m)
1	2390.00	56.2 PK	74.0	-17.8	1.50 H	190	23.5	32.7
2	2390.00	47.8 AV	54.0	-6.2	1.50 H	190	15.1	32.7
3	*2412.00	99.8 PK			1.52 H	187	67.0	32.8
4	*2412.00	95.8 AV			1.52 H	187	63.0	32.8
5	4824.00	49.0 PK	74.0	-25.0	1.00 H	112	42.1	6.9
6	4824.00	38.0 AV	54.0	-16.0	1.00 H	112	31.1	6.9
ANTENNA POLARITY & TEST DISTANCE: VERTICAL AT 3 M								
NO.	FREQ. (MHz)	EMISSION LEVEL (dBuV/m)	LIMIT (dBuV/m)	MARGIN (dB)	ANTENNA HEIGHT (m)	TABLE ANGLE (Degree)	RAW VALUE (dBuV)	CORRECTION FACTOR (dB/m)
1	2390.00	56.2 PK	74.0	-17.8	1.05 V	170	23.5	32.7
2	2390.00	45.2 AV	54.0	-8.8	1.05 V	170	12.5	32.7
3	*2412.00	94.9 PK			1.09 V	155	62.1	32.8
4	*2412.00	91.1 AV			1.09 V	155	58.3	32.8
5	4824.00	48.7 PK	74.0	-25.3	1.22 V	252	41.8	6.9
6	4824.00	35.5 AV	54.0	-18.5	1.22 V	252	28.6	6.9

Remarks:

1. Emission Level(dBuV/m) = Raw Value(dBuV) + Correction Factor(dB/m)
2. Correction Factor(dB/m) = Antenna Factor(dB/m) + Cable Factor(dB) – Pre-Amplifier Factor(dB)
3. The other emission levels were very low against the limit.
4. Margin value = Emission Level – Limit value
5. " * ": Fundamental frequency.

CHANNEL	TX Channel 6	DETECTOR FUNCTION	Peak (PK)
FREQUENCY RANGE	1GHz ~ 25GHz		Average (AV)

ANTENNA POLARITY & TEST DISTANCE: HORIZONTAL AT 3 M

NO.	FREQ. (MHz)	EMISSION LEVEL (dBuV/m)	LIMIT (dBuV/m)	MARGIN (dB)	ANTENNA HEIGHT (m)	TABLE ANGLE (Degree)	RAW VALUE (dBuV)	CORRECTION FACTOR (dB/m)
1	*2437.00	99.5 PK			1.50 H	180	66.5	33.0
2	*2437.00	95.9 AV			1.50 H	180	62.9	33.0
3	4874.00	48.9 PK	74.0	-25.1	1.00 H	222	41.9	7.0
4	4874.00	37.6 AV	54.0	-16.4	1.00 H	222	30.6	7.0

ANTENNA POLARITY & TEST DISTANCE: VERTICAL AT 3 M

NO.	FREQ. (MHz)	EMISSION LEVEL (dBuV/m)	LIMIT (dBuV/m)	MARGIN (dB)	ANTENNA HEIGHT (m)	TABLE ANGLE (Degree)	RAW VALUE (dBuV)	CORRECTION FACTOR (dB/m)
1	*2437.00	95.2 PK			1.07 V	153	62.2	33.0
2	*2437.00	91.4 AV			1.07 V	153	58.4	33.0
3	4874.00	48.6 PK	74.0	-25.4	1.12 V	169	41.6	7.0
4	4874.00	36.4 AV	54.0	-17.6	1.12 V	169	29.4	7.0

Remarks:

1. Emission Level(dBuV/m) = Raw Value(dBuV) + Correction Factor(dB/m)
2. Correction Factor(dB/m) = Antenna Factor(dB/m) + Cable Factor(dB) – Pre-Amplifier Factor(dB)
3. The other emission levels were very low against the limit.
4. Margin value = Emission Level – Limit value
5. " * ": Fundamental frequency.

CHANNEL	TX Channel 11	DETECTOR FUNCTION	Peak (PK)
FREQUENCY RANGE	1GHz ~ 25GHz		Average (AV)

ANTENNA POLARITY & TEST DISTANCE: HORIZONTAL AT 3 M								
NO.	FREQ. (MHz)	EMISSION LEVEL (dBuV/m)	LIMIT (dBuV/m)	MARGIN (dB)	ANTENNA HEIGHT (m)	TABLE ANGLE (Degree)	RAW VALUE (dBuV)	CORRECTION FACTOR (dB/m)
1	*2462.00	99.0 PK			1.45 H	185	65.9	33.1
2	*2462.00	95.9 AV			1.45 H	185	62.8	33.1
3	2483.50	57.4 PK	74.0	-16.6	1.42 H	176	24.2	33.2
4	2483.50	46.5 AV	54.0	-7.5	1.42 H	176	13.3	33.2
5	4924.00	48.9 PK	74.0	-25.1	1.00 H	131	41.8	7.1
6	4924.00	37.5 AV	54.0	-16.5	1.00 H	131	30.4	7.1
ANTENNA POLARITY & TEST DISTANCE: VERTICAL AT 3 M								
NO.	FREQ. (MHz)	EMISSION LEVEL (dBuV/m)	LIMIT (dBuV/m)	MARGIN (dB)	ANTENNA HEIGHT (m)	TABLE ANGLE (Degree)	RAW VALUE (dBuV)	CORRECTION FACTOR (dB/m)
1	*2462.00	94.4 PK			1.19 V	142	61.3	33.1
2	*2462.00	90.8 AV			1.19 V	142	57.7	33.1
3	2483.50	57.5 PK	74.0	-16.5	1.16 V	134	24.3	33.2
4	2483.50	45.3 AV	54.0	-8.7	1.16 V	134	12.1	33.2
5	4924.00	48.7 PK	74.0	-25.3	1.23 V	244	41.6	7.1
6	4924.00	35.9 AV	54.0	-18.1	1.23 V	244	28.8	7.1

Remarks:

1. Emission Level(dBuV/m) = Raw Value(dBuV) + Correction Factor(dB/m)
2. Correction Factor(dB/m) = Antenna Factor(dB/m) + Cable Factor(dB) – Pre-Amplifier Factor(dB)
3. The other emission levels were very low against the limit.
4. Margin value = Emission Level – Limit value
5. " * ": Fundamental frequency.

802.11g

CHANNEL	TX Channel 1	DETECTOR FUNCTION	Peak (PK)
FREQUENCY RANGE	1GHz ~ 25GHz		Average (AV)

ANTENNA POLARITY & TEST DISTANCE: HORIZONTAL AT 3 M								
NO.	FREQ. (MHz)	EMISSION LEVEL (dBuV/m)	LIMIT (dBuV/m)	MARGIN (dB)	ANTENNA HEIGHT (m)	TABLE ANGLE (Degree)	RAW VALUE (dBuV)	CORRECTION FACTOR (dB/m)
1	2390.00	56.6 PK	74.0	-17.4	1.49 H	178	23.9	32.7
2	2390.00	45.0 AV	54.0	-9.0	1.49 H	178	12.3	32.7
3	*2412.00	96.2 PK			1.52 H	184	63.4	32.8
4	*2412.00	86.3 AV			1.52 H	184	53.5	32.8
5	4824.00	48.2 PK	74.0	-25.8	1.00 H	98	41.3	6.9
6	4824.00	35.4 AV	54.0	-18.6	1.00 H	98	28.5	6.9
ANTENNA POLARITY & TEST DISTANCE: VERTICAL AT 3 M								
NO.	FREQ. (MHz)	EMISSION LEVEL (dBuV/m)	LIMIT (dBuV/m)	MARGIN (dB)	ANTENNA HEIGHT (m)	TABLE ANGLE (Degree)	RAW VALUE (dBuV)	CORRECTION FACTOR (dB/m)
1	2390.00	56.0 PK	74.0	-18.0	1.13 V	166	23.3	32.7
2	2390.00	45.2 AV	54.0	-8.8	1.13 V	166	12.5	32.7
3	*2412.00	91.4 PK			1.10 V	160	58.6	32.8
4	*2412.00	81.8 AV			1.10 V	160	49.0	32.8
5	4824.00	48.3 PK	74.0	-25.7	1.18 V	267	41.4	6.9
6	4824.00	36.0 AV	54.0	-18.0	1.18 V	267	29.1	6.9

Remarks:

1. Emission Level(dBuV/m) = Raw Value(dBuV) + Correction Factor(dB/m)
2. Correction Factor(dB/m) = Antenna Factor(dB/m) + Cable Factor(dB) – Pre-Amplifier Factor(dB)
3. The other emission levels were very low against the limit.
4. Margin value = Emission Level – Limit value
5. " * ": Fundamental frequency.

CHANNEL	TX Channel 6	DETECTOR FUNCTION	Peak (PK)
FREQUENCY RANGE	1GHz ~ 25GHz		Average (AV)

ANTENNA POLARITY & TEST DISTANCE: HORIZONTAL AT 3 M

NO.	FREQ. (MHz)	EMISSION LEVEL (dBuV/m)	LIMIT (dBuV/m)	MARGIN (dB)	ANTENNA HEIGHT (m)	TABLE ANGLE (Degree)	RAW VALUE (dBuV)	CORRECTION FACTOR (dB/m)
1	*2437.00	95.9 PK			1.48 H	183	62.9	33.0
2	*2437.00	86.2 AV			1.48 H	183	53.2	33.0
3	4874.00	48.1 PK	74.0	-25.9	1.00 H	90	41.1	7.0
4	4874.00	35.3 AV	54.0	-18.7	1.00 H	90	28.3	7.0

ANTENNA POLARITY & TEST DISTANCE: VERTICAL AT 3 M

NO.	FREQ. (MHz)	EMISSION LEVEL (dBuV/m)	LIMIT (dBuV/m)	MARGIN (dB)	ANTENNA HEIGHT (m)	TABLE ANGLE (Degree)	RAW VALUE (dBuV)	CORRECTION FACTOR (dB/m)
1	*2437.00	92.5 PK			1.08 V	155	59.5	33.0
2	*2437.00	82.2 AV			1.08 V	155	49.2	33.0
3	4874.00	48.2 PK	74.0	-25.8	1.16 V	170	41.2	7.0
4	4874.00	36.0 AV	54.0	-18.0	1.16 V	170	29.0	7.0

Remarks:

1. Emission Level(dBuV/m) = Raw Value(dBuV) + Correction Factor(dB/m)
2. Correction Factor(dB/m) = Antenna Factor(dB/m) + Cable Factor(dB) – Pre-Amplifier Factor(dB)
3. The other emission levels were very low against the limit.
4. Margin value = Emission Level – Limit value
5. " * ": Fundamental frequency.

CHANNEL	TX Channel 11	DETECTOR	Peak (PK)
FREQUENCY RANGE	1GHz ~ 25GHz	FUNCTION	Average (AV)

ANTENNA POLARITY & TEST DISTANCE: HORIZONTAL AT 3 M								
NO.	FREQ. (MHz)	EMISSION LEVEL (dBuV/m)	LIMIT (dBuV/m)	MARGIN (dB)	ANTENNA HEIGHT (m)	TABLE ANGLE (Degree)	RAW VALUE (dBuV)	CORRECTION FACTOR (dB/m)
1	*2462.00	96.0 PK			1.46 H	185	62.9	33.1
2	*2462.00	86.2 AV			1.46 H	185	53.1	33.1
3	2483.50	57.4 PK	74.0	-16.6	1.40 H	189	24.2	33.2
4	2483.50	45.4 AV	54.0	-8.6	1.40 H	189	12.2	33.2
5	4924.00	48.3 PK	74.0	-25.7	1.00 H	92	41.2	7.1
6	4924.00	35.5 AV	54.0	-18.5	1.00 H	92	28.4	7.1
ANTENNA POLARITY & TEST DISTANCE: VERTICAL AT 3 M								
NO.	FREQ. (MHz)	EMISSION LEVEL (dBuV/m)	LIMIT (dBuV/m)	MARGIN (dB)	ANTENNA HEIGHT (m)	TABLE ANGLE (Degree)	RAW VALUE (dBuV)	CORRECTION FACTOR (dB/m)
1	*2462.00	92.5 PK			1.23 V	141	59.4	33.1
2	*2462.00	82.7 AV			1.23 V	141	49.6	33.1
3	2483.50	57.1 PK	74.0	-16.9	1.26 V	149	23.9	33.2
4	2483.50	45.3 AV	54.0	-8.7	1.26 V	149	12.1	33.2
5	4924.00	48.3 PK	74.0	-25.7	1.30 V	277	41.2	7.1
6	4924.00	36.1 AV	54.0	-17.9	1.30 V	277	29.0	7.1

Remarks:

1. Emission Level(dBuV/m) = Raw Value(dBuV) + Correction Factor(dB/m)
2. Correction Factor(dB/m) = Antenna Factor(dB/m) + Cable Factor(dB) – Pre-Amplifier Factor(dB)
3. The other emission levels were very low against the limit.
4. Margin value = Emission Level – Limit value
5. " * ": Fundamental frequency.

802.11n (HT20)

CHANNEL	TX Channel 1	DETECTOR FUNCTION	Peak (PK)
FREQUENCY RANGE	1GHz ~ 25GHz		Average (AV)

ANTENNA POLARITY & TEST DISTANCE: HORIZONTAL AT 3 M

NO.	FREQ. (MHz)	EMISSION LEVEL (dBuV/m)	LIMIT (dBuV/m)	MARGIN (dB)	ANTENNA HEIGHT (m)	TABLE ANGLE (Degree)	RAW VALUE (dBuV)	CORRECTION FACTOR (dB/m)
1	2390.00	56.1 PK	74.0	-17.9	1.53 H	188	23.4	32.7
2	2390.00	45.3 AV	54.0	-8.7	1.53 H	188	12.6	32.7
3	*2412.00	95.9 PK			1.51 H	181	63.1	32.8
4	*2412.00	84.9 AV			1.51 H	181	52.1	32.8
5	4824.00	48.9 PK	74.0	-25.1	1.00 H	109	42.0	6.9
6	4824.00	35.7 AV	54.0	-18.3	1.00 H	109	28.8	6.9

ANTENNA POLARITY & TEST DISTANCE: VERTICAL AT 3 M

NO.	FREQ. (MHz)	EMISSION LEVEL (dBuV/m)	LIMIT (dBuV/m)	MARGIN (dB)	ANTENNA HEIGHT (m)	TABLE ANGLE (Degree)	RAW VALUE (dBuV)	CORRECTION FACTOR (dB/m)
1	2390.00	56.9 PK	74.0	-17.1	1.39 V	139	24.2	32.7
2	2390.00	45.1 AV	54.0	-8.9	1.39 V	139	12.4	32.7
3	*2412.00	91.6 PK			1.42 V	157	58.8	32.8
4	*2412.00	81.2 AV			1.42 V	157	48.4	32.8
5	4824.00	48.6 PK	74.0	-25.4	1.26 V	287	41.7	6.9
6	4824.00	36.1 AV	54.0	-17.9	1.26 V	287	29.2	6.9

Remarks:

1. Emission Level(dBuV/m) = Raw Value(dBuV) + Correction Factor(dB/m)
2. Correction Factor(dB/m) = Antenna Factor(dB/m) + Cable Factor(dB) – Pre-Amplifier Factor(dB)
3. The other emission levels were very low against the limit.
4. Margin value = Emission Level – Limit value
5. " * ": Fundamental frequency.

CHANNEL	TX Channel 6	DETECTOR FUNCTION	Peak (PK)
FREQUENCY RANGE	1GHz ~ 25GHz		Average (AV)

ANTENNA POLARITY & TEST DISTANCE: HORIZONTAL AT 3 M

NO.	FREQ. (MHz)	EMISSION LEVEL (dBuV/m)	LIMIT (dBuV/m)	MARGIN (dB)	ANTENNA HEIGHT (m)	TABLE ANGLE (Degree)	RAW VALUE (dBuV)	CORRECTION FACTOR (dB/m)
1	*2437.00	96.2 PK			1.49 H	179	63.2	33.0
2	*2437.00	85.4 AV			1.49 H	179	52.4	33.0
3	4874.00	49.1 PK	74.0	-24.9	1.00 H	104	42.1	7.0
4	4874.00	36.1 AV	54.0	-17.9	1.00 H	104	29.1	7.0

ANTENNA POLARITY & TEST DISTANCE: VERTICAL AT 3 M

NO.	FREQ. (MHz)	EMISSION LEVEL (dBuV/m)	LIMIT (dBuV/m)	MARGIN (dB)	ANTENNA HEIGHT (m)	TABLE ANGLE (Degree)	RAW VALUE (dBuV)	CORRECTION FACTOR (dB/m)
1	*2437.00	92.0 PK			1.56 V	153	59.0	33.0
2	*2437.00	81.6 AV			1.56 V	153	48.6	33.0
3	4874.00	48.9 PK	74.0	-25.1	1.20 V	264	41.9	7.0
4	4874.00	36.1 AV	54.0	-17.9	1.20 V	264	29.1	7.0

Remarks:

1. Emission Level(dBuV/m) = Raw Value(dBuV) + Correction Factor(dB/m)
2. Correction Factor(dB/m) = Antenna Factor(dB/m) + Cable Factor(dB) – Pre-Amplifier Factor(dB)
3. The other emission levels were very low against the limit.
4. Margin value = Emission Level – Limit value
5. " * ": Fundamental frequency.

CHANNEL	TX Channel 11	DETECTOR FUNCTION	Peak (PK)
FREQUENCY RANGE	1GHz ~ 25GHz		Average (AV)

ANTENNA POLARITY & TEST DISTANCE: HORIZONTAL AT 3 M								
NO.	FREQ. (MHz)	EMISSION LEVEL (dBuV/m)	LIMIT (dBuV/m)	MARGIN (dB)	ANTENNA HEIGHT (m)	TABLE ANGLE (Degree)	RAW VALUE (dBuV)	CORRECTION FACTOR (dB/m)
1	*2462.00	95.7 PK			1.31 H	186	62.6	33.1
2	*2462.00	85.1 AV			1.31 H	186	52.0	33.1
3	2483.50	57.7 PK	74.0	-16.3	1.36 H	169	24.5	33.2
4	2483.50	45.5 AV	54.0	-8.5	1.36 H	169	12.3	33.2
5	4924.00	48.7 PK	74.0	-25.3	1.00 H	112	41.6	7.1
6	4924.00	35.7 AV	54.0	-18.3	1.00 H	112	28.6	7.1
ANTENNA POLARITY & TEST DISTANCE: VERTICAL AT 3 M								
NO.	FREQ. (MHz)	EMISSION LEVEL (dBuV/m)	LIMIT (dBuV/m)	MARGIN (dB)	ANTENNA HEIGHT (m)	TABLE ANGLE (Degree)	RAW VALUE (dBuV)	CORRECTION FACTOR (dB/m)
1	*2462.00	91.4 PK			1.22 V	141	58.3	33.1
2	*2462.00	81.2 AV			1.22 V	141	48.1	33.1
3	2483.50	56.6 PK	74.0	-17.4	1.28 V	149	23.4	33.2
4	2483.50	45.4 AV	54.0	-8.6	1.28 V	149	12.2	33.2
5	4924.00	48.6 PK	74.0	-25.4	1.31 V	288	41.5	7.1
6	4924.00	35.7 AV	54.0	-18.3	1.31 V	288	28.6	7.1

Remarks:

1. Emission Level(dBuV/m) = Raw Value(dBuV) + Correction Factor(dB/m)
2. Correction Factor(dB/m) = Antenna Factor(dB/m) + Cable Factor(dB) – Pre-Amplifier Factor(dB)
3. The other emission levels were very low against the limit.
4. Margin value = Emission Level – Limit value
5. " * ": Fundamental frequency.

Below 1GHz worst-case data:

802.11b

CHANNEL	TX Channel 6	DETECTOR FUNCTION	Quasi-Peak (QP)
FREQUENCY RANGE	9kHz ~ 1GHz		

ANTENNA POLARITY & TEST DISTANCE: HORIZONTAL AT 3 M								
NO.	FREQ. (MHz)	EMISSION LEVEL (dBuV/m)	LIMIT (dBuV/m)	MARGIN (dB)	ANTENNA HEIGHT (m)	TABLE ANGLE (Degree)	RAW VALUE (dBuV)	CORRECTION FACTOR (dB/m)
1	47.36	25.4 QP	40.0	-14.6	2.00 H	263	39.5	-14.1
2	101.69	23.5 QP	43.5	-20.0	1.24 H	12	41.8	-18.3
3	208.42	17.7 QP	43.5	-25.8	2.00 H	193	34.1	-16.4
4	336.48	26.0 QP	46.0	-20.0	2.00 H	293	37.6	-11.6
5	714.86	38.4 QP	46.0	-7.6	1.24 H	187	42.6	-4.2
6	936.07	31.9 QP	46.0	-14.1	2.00 H	13	32.0	-0.1
ANTENNA POLARITY & TEST DISTANCE: VERTICAL AT 3 M								
NO.	FREQ. (MHz)	EMISSION LEVEL (dBuV/m)	LIMIT (dBuV/m)	MARGIN (dB)	ANTENNA HEIGHT (m)	TABLE ANGLE (Degree)	RAW VALUE (dBuV)	CORRECTION FACTOR (dB/m)
1	30.00	35.7 QP	40.0	-4.3	1.50 V	15	51.2	-15.5
2	165.73	25.3 QP	43.5	-18.2	1.00 V	24	39.3	-14.0
3	239.46	25.4 QP	46.0	-20.6	1.50 V	262	40.0	-14.6
4	365.59	30.6 QP	46.0	-15.4	2.00 V	124	41.8	-11.2
5	827.40	27.2 QP	46.0	-18.8	2.00 V	219	29.1	-1.9
6	936.07	31.1 QP	46.0	-14.9	2.00 V	237	31.2	-0.1

Remarks:

1. Emission Level(dBuV/m) = Raw Value(dBuV) + Correction Factor(dB/m)
2. Correction Factor(dB/m) = Antenna Factor(dB/m) + Cable Factor(dB) – Pre-Amplifier Factor(dB)
3. The other emission levels were very low against the limit.
4. Margin value = Emission Level – Limit value

4.2 Conducted Emission Measurement

4.2.1 Limits of Conducted Emission Measurement

Frequency (MHz)	Conducted Limit (dBuV)	
	Quasi-peak	Average
0.15 - 0.5	66 - 56	56 - 46
0.50 - 5.0	56	46
5.0 - 30.0	60	50

- Note:** 1. The lower limit shall apply at the transition frequencies.
 2. The limit decreases in line with the logarithm of the frequency in the range of 0.15 to 0.50MHz.

4.2.2 Test Instruments

Description & Manufacturer	Model No.	Serial No.	Cal. Date	Cal. Due
Test Receiver ROHDE & SCHWARZ	ESCI	100613	Nov. 16, 2015	Nov. 15, 2016
RF signal cable (with 10dB PAD) Woken	5D-FB	Cable-cond1-01	Dec. 26, 2015	Dec. 25, 2016
LISN ROHDE & SCHWARZ (EUT)	ESH3-Z5	835239/001	Feb. 26, 2016	Feb. 25, 2017
LISN ROHDE & SCHWARZ (Peripheral)	ESH3-Z5	100311	Jul. 28, 2016	Jul. 27, 2017
Software ADT	BV ADT_Cond_ V7.3.7.3	NA	NA	NA

- Note:** 1. The calibration interval of the above test instruments is 12 months and the calibrations are traceable to NML/ROC and NIST/USA.
 2. The test was performed in HwaYa Shielded Room 1.
 3. The VCCI Site Registration No. is C-2040.

4.2.3 Test Procedures

- The EUT was placed 0.4 meters from the conducting wall of the shielded room with EUT being connected to the power mains through a line impedance stabilization network (LISN). Other support units were connected to the power mains through another LISN. The two LISNs provide 50 ohm/ 50uH of coupling impedance for the measuring instrument.
- Both lines of the power mains connected to the EUT were checked for maximum conducted interference.
- The frequency range from 150kHz to 30MHz was searched. Emission levels under (Limit - 20dB) was not recorded.

Note: The resolution bandwidth and video bandwidth of test receiver is 9kHz for quasi-peak detection (QP) and average detection (AV) at frequency 0.15MHz-30MHz.

4.2.4 Deviation from Test Standard

No deviation.

4.2.5 Test Setup

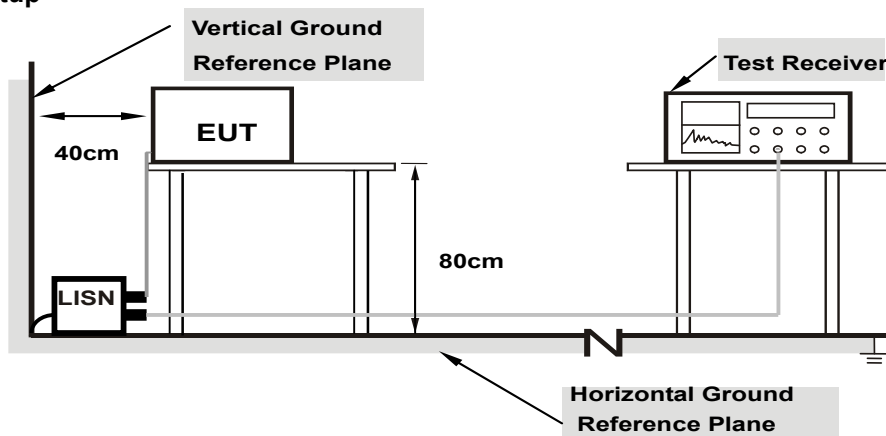

Note: 1.Support units were connected to second LISN.

For the actual test configuration, please refer to the attached file (Test Setup Photo).

4.2.6 EUT Operating Conditions

Same as 4.1.6.

4.2.7 Test Results

Phase	Line (L)	Detector Function	Quasi-Peak (QP) / Average (AV)							
No	Freq. [MHz]	Corr. Factor (dB)	Reading Value [dB (uV)]		Emission Level [dB (uV)]		Limit [dB (uV)]		Margin (dB)	
			Q.P.	AV.	Q.P.	AV.	Q.P.	AV.	Q.P.	AV.
1	0.20474	10.14	38.34	9.97	48.48	20.11	63.42	53.42	-14.94	-33.31
2	0.27512	10.15	37.42	9.32	47.57	19.47	60.96	50.96	-13.39	-31.49
3	0.34550	10.16	36.58	9.02	46.74	19.18	59.07	49.07	-12.33	-29.89
4	0.37287	10.17	35.98	8.87	46.15	19.04	58.44	48.44	-12.29	-29.40
5	0.41588	10.17	36.75	8.33	46.92	18.50	57.53	47.53	-10.61	-29.03
6	0.44325	10.17	35.40	7.81	45.57	17.98	57.00	47.00	-11.43	-29.02
7	0.68176	10.17	23.94	0.63	34.11	10.80	56.00	46.00	-21.89	-35.20
8	1.08840	10.19	17.13	1.99	27.32	12.18	56.00	46.00	-28.68	-33.82
9	4.30633	10.39	4.25	-3.91	14.64	6.48	56.00	46.00	-41.36	-39.52
10	17.69417	11.27	11.40	8.92	22.67	20.19	60.00	50.00	-37.33	-29.81

Remarks:

1. Q.P. and AV. are abbreviations of quasi-peak and average individually.
2. The emission levels of other frequencies were very low against the limit.
3. Margin value = Emission level - Limit value
4. Correction factor = Insertion loss + Cable loss
5. Emission Level = Correction Factor + Reading Value.

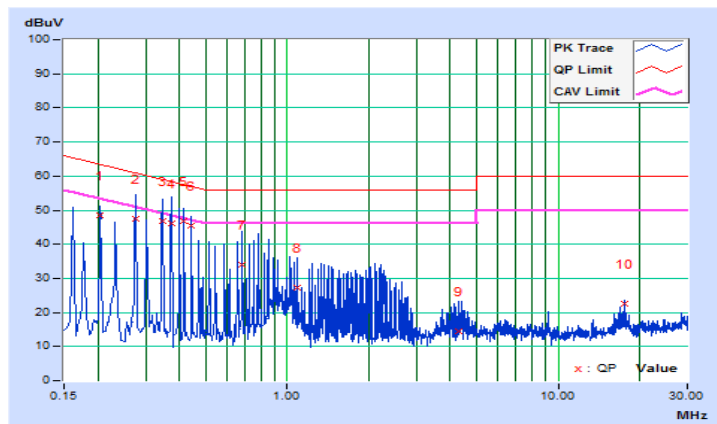

Phase	Neutral (N)	Detector Function	Quasi-Peak (QP) / Average (AV)
-------	-------------	-------------------	--------------------------------

No	Freq. [MHz]	Corr. Factor (dB)	Reading Value [dB (uV)]		Emission Level [dB (uV)]		Limit [dB (uV)]		Margin (dB)	
			Q.P.	AV.	Q.P.	AV.	Q.P.	AV.	Q.P.	AV.
			1	0.15000	10.12	42.34	13.17	52.46	23.29	66.00
2	0.18519	10.14	37.65	9.57	47.79	19.71	64.25	54.25	-16.46	-34.54
3	0.21256	10.15	37.49	9.32	47.64	19.47	63.10	53.10	-15.46	-33.63
4	0.28294	10.16	36.49	9.67	46.65	19.83	60.73	50.73	-14.08	-30.90
5	0.34550	10.17	35.98	8.47	46.15	18.64	59.07	49.07	-12.92	-30.43
6	0.38851	10.18	35.29	8.57	45.47	18.75	58.10	48.10	-12.63	-29.35
7	0.45889	10.18	35.17	8.22	45.35	18.40	56.71	46.71	-11.36	-28.31
8	0.87335	10.19	24.68	8.15	34.87	18.34	56.00	46.00	-21.13	-27.66
9	2.18711	10.27	16.67	-0.54	26.94	9.73	56.00	46.00	-29.06	-36.27
10	4.35325	10.41	6.46	-2.61	16.87	7.80	56.00	46.00	-39.13	-38.20
11	17.38528	11.36	5.44	2.42	16.80	13.78	60.00	50.00	-43.20	-36.22

Remarks:

1. Q.P. and AV. are abbreviations of quasi-peak and average individually.
2. The emission levels of other frequencies were very low against the limit.
3. Margin value = Emission level - Limit value
4. Correction factor = Insertion loss + Cable loss
5. Emission Level = Correction Factor + Reading Value.

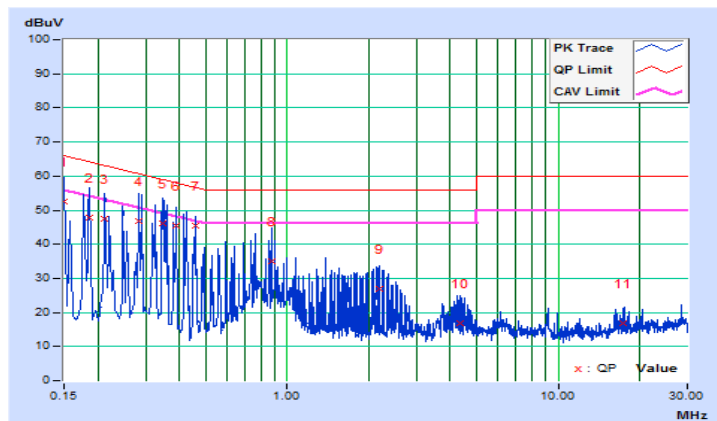

4.3 6dB Bandwidth Measurement

4.3.1 Limits of 6dB Bandwidth Measurement

The minimum of 6dB Bandwidth Measurement is 0.5 MHz.

4.3.2 Test Setup

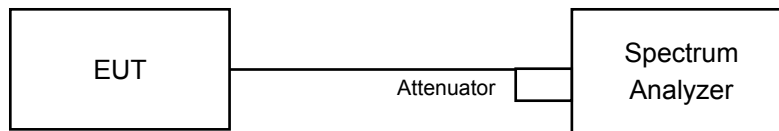

4.3.3 Test Instruments

Refer to section 4.1.2 to get information of above instrument.

4.3.4 Test Procedure

- Set resolution bandwidth (RBW) = 100kHz
- Set the video bandwidth (VBW) $\geq 3 \times$ RBW, Detector = average.
- Trace mode = max hold.
- Sweep = auto couple.
- Measure the maximum width of the emission that is constrained by the frequencies associated with the two amplitude points (upper and lower) that are attenuated by 6 dB relative to the maximum level measured in the fundamental emission

4.3.5 Deviation from Test Standard

No deviation.

4.3.6 EUT Operating Conditions

The software provided by client to enable the EUT under transmission condition continuously at lowest, middle and highest channel frequencies individually.

4.3.7 Test Result

802.11b

Channel	Frequency (MHz)	6dB Bandwidth (MHz)	Minimum Limit (MHz)	Pass / Fail
1	2412	9.02	0.5	Pass
6	2437	8.57	0.5	Pass
11	2462	9.05	0.5	Pass

802.11g

Channel	Frequency (MHz)	6dB Bandwidth (MHz)	Minimum Limit (MHz)	Pass / Fail
1	2412	16.41	0.5	Pass
6	2437	16.40	0.5	Pass
11	2462	16.40	0.5	Pass

802.11n (HT20)

Channel	Frequency (MHz)	6dB Bandwidth (MHz)	Minimum Limit (MHz)	Pass / Fail
1	2412	17.63	0.5	Pass
6	2437	17.64	0.5	Pass
11	2462	17.63	0.5	Pass

Spectrum Plot of Worst Value

802.11b

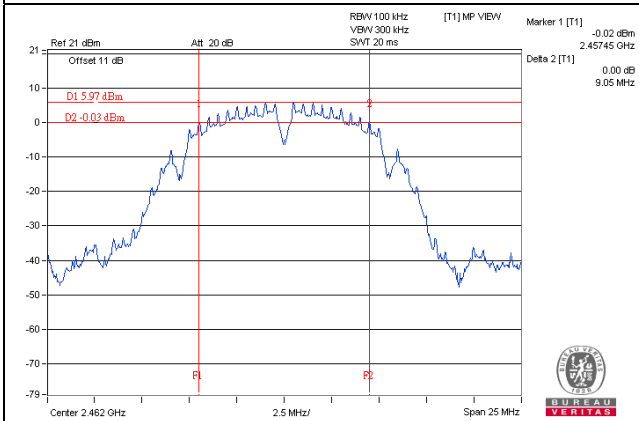

802.11g

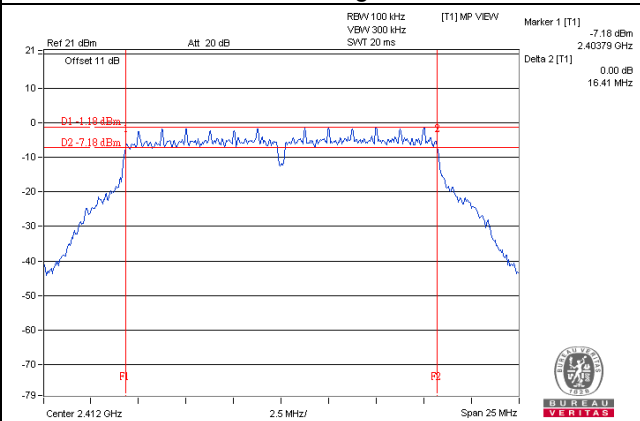

802.11n (HT20)

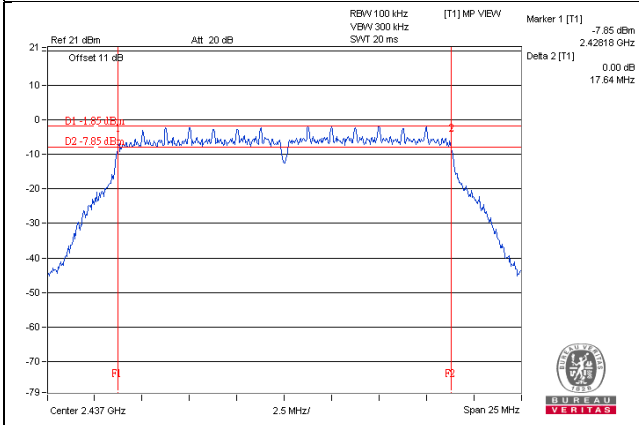

4.4 Conducted Output Power Measurement

4.4.1 Limits of Conducted Output Power Measurement

For systems using digital modulation in the 2400–2483.5 MHz bands: 1 Watt (30dBm)

4.4.2 Test Setup

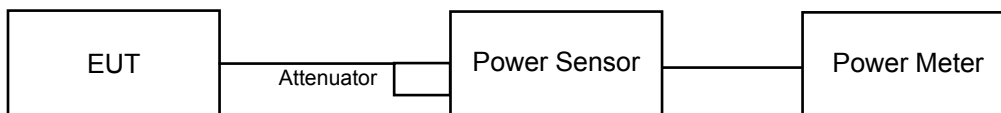

4.4.3 Test Instruments

Refer to section 4.1.2 to get information of above instrument.

4.4.4 Test Procedures

An average power sensor was used on the output port of the EUT. A power meter was used to read the response of the average power sensor. Record the power level.

4.4.5 Deviation from Test Standard

No deviation.

4.4.6 EUT Operating Conditions

Same as Item 4.3.6.

4.4.7 Test Results

802.11b

Channel	Frequency (MHz)	Average Power (mW)	Average Power (dBm)	Limit (dBm)	Pass / Fail
1	2412	30.974	14.91	30	Pass
6	2437	32.211	15.08	30	Pass
11	2462	32.434	15.11	30	Pass

802.11g

Channel	Frequency (MHz)	Average Power (mW)	Average Power (dBm)	Limit (dBm)	Pass / Fail
1	2412	11.885	10.75	30	Pass
6	2437	12.359	10.92	30	Pass
11	2462	12.388	10.93	30	Pass

802.11n (HT20)

Channel	Frequency (MHz)	Average Power (mW)	Average Power (dBm)	Limit (dBm)	Pass / Fail
1	2412	9.886	9.95	30	Pass
6	2437	10.069	10.03	30	Pass
11	2462	9.863	9.94	30	Pass

4.5 Power Spectral Density Measurement

4.5.1 Limits of Power Spectral Density Measurement

The Maximum of Power Spectral Density Measurement is 8dBm.

4.5.2 Test Setup

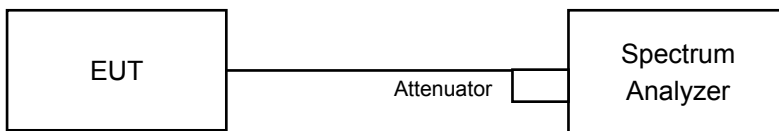

4.5.3 Test Instruments

Refer to section 4.1.2 to get information of above instrument.

4.5.4 Test Procedure

Duty cycle $\geq 98\%$

- Set instrument center frequency to DTS channel center frequency.
- Set span to at least 1.5 times the OBW.
- Set RBW to: $3 \text{ kHz} \leq \text{RBW} \leq 100 \text{ kHz}$.
- Set VBW $\geq 3 \times \text{RBW}$.
- Detector = power averaging (RMS) or sample detector (when RMS not available).
- Ensure that the number of measurement points in the sweep $\geq 2 \times \text{span}/\text{RBW}$.
- Sweep time = auto couple.
- Employ trace averaging (RMS) mode over a minimum of 100 traces.
- Use the peak marker function to determine the maximum amplitude level.

Duty cycle $< 98\%$

- Measure the duty cycle (x).
- Set instrument center frequency to DTS channel center frequency.
- Set span to at least 1.5 times the OBW.
- Set RBW to: $3 \text{ kHz} \leq \text{RBW} \leq 100 \text{ kHz}$.
- Set VBW $\geq 3 \times \text{RBW}$.
- Detector = power averaging (RMS) or sample detector (when RMS not available).
- Ensure that the number of measurement points in the sweep $\geq 2 \times \text{span}/\text{RBW}$.
- Sweep time = auto couple.
- Do not use sweep triggering. Allow sweep to "free run".
- Employ trace averaging (RMS) mode over a minimum of 100 traces.
- Use the peak marker function to determine the maximum amplitude level.
- Add $10 \log(1/x)$, where x is the duty cycle measured in step (a), to the measured PSD to compute the average PSD during the actual transmission time.

4.5.5 Deviation from Test Standard

No deviation.

4.5.6 EUT Operating Condition

Same as Item 4.3.6

4.5.7 Test Results

802.11b

Channel	Freq. (MHz)	PSD (dBm/10kHz)	Limit (dBm/3kHz)	Pass / Fail
1	2412	-13.66	8.00	Pass
6	2437	-14.04	8.00	Pass
11	2462	-13.91	8.00	Pass

802.11g

Channel	Frequency (MHz)	PSD w/o Duty Factor (dBm/10kHz)	Duty Factor (dB)	Total PSD With Duty Factor (dBm/10kHz)	Limit (dBm/3kHz)	Pass / Fail
1	2412	-20.03	0.09	-19.94	8.00	Pass
6	2437	-19.58	0.09	-19.49	8.00	Pass
11	2462	-19.65	0.09	-19.56	8.00	Pass

Note: Refer to section 3.3 for duty cycle spectrum plot.

802.11n (HT20)

Channel	Frequency (MHz)	PSD w/o Duty Factor (dBm/10kHz)	Duty Factor (dB)	Total PSD With Duty Factor (dBm/10kHz)	Limit (dBm/3kHz)	Pass / Fail
1	2412	-22.19	0.10	-22.09	8.00	Pass
6	2437	-22.16	0.10	-22.06	8.00	Pass
11	2462	-22.13	0.10	-22.03	8.00	Pass

Note: Refer to section 3.3 for duty cycle spectrum plot.

Spectrum Plot of Worst Value

802.11b

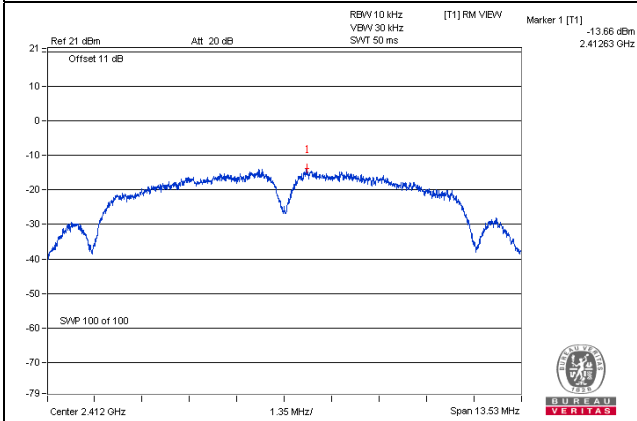

802.11g

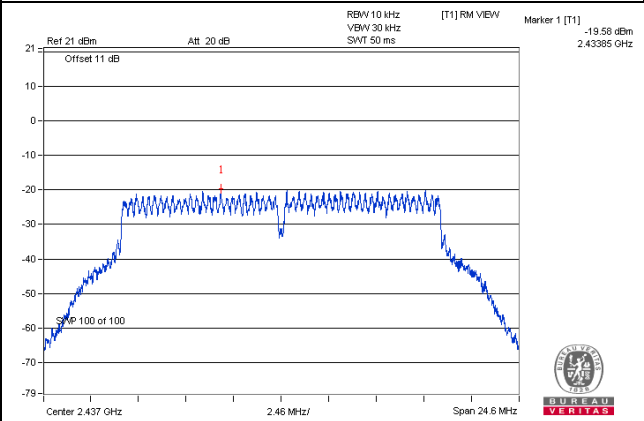

802.11n (HT20)

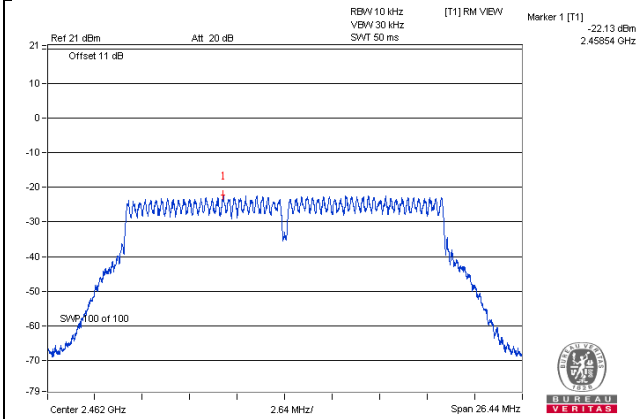

4.6 Conducted Out of Band Emission Measurement

4.6.1 Limits of Conducted Out of Band Emission Measurement

Below 30dB of the highest emission level of operating band (in 100kHz Resolution Bandwidth).

4.6.2 Test Setup

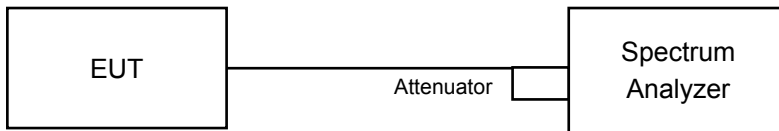

4.6.3 Test Instruments

Refer to section 4.1.2 to get information of above instrument.

4.6.4 Test Procedure

MEASUREMENT PROCEDURE REF

- Set the RBW = 100 kHz.
- Set the VBW \geq 300 kHz.
- Detector = average.
- Sweep time = auto couple.
- Trace mode = max hold.
- Allow trace to fully stabilize.
- Use the peak marker function to determine the maximum power level in any 100 kHz band segment within the fundamental EBW.

MEASUREMENT PROCEDURE OOBE

- Set RBW = 100 kHz.
- Set VBW \geq 300 kHz.
- Ensure that the number of measurement points \geq span/RBW
- According to measurement points to set differ measurement span.
- Detector = average.
- Trace Mode = max hold.
- Sweep = auto couple.

4.6.5 Deviation from Test Standard

No deviation.

4.6.6 EUT Operating Condition

Same as Item 4.3.6

4.6.7 Test Results

The spectrum plots are attached on the following pages. D1 line indicates the highest level, and D2 line indicates the 30dB offset below D1. It shows compliance with the requirement.

802.11b

CH 1

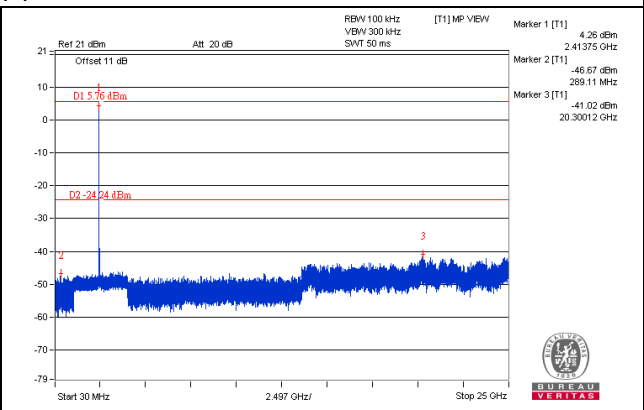
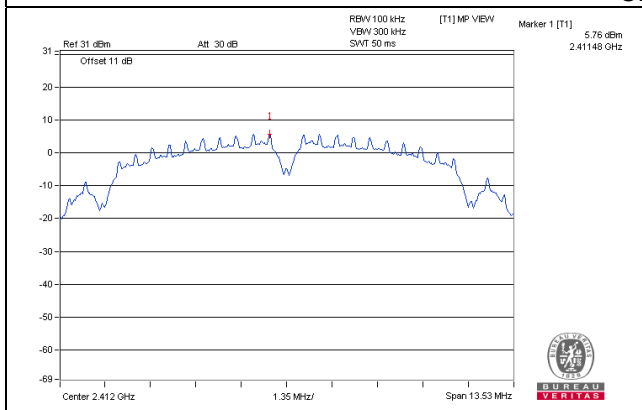

CH 6

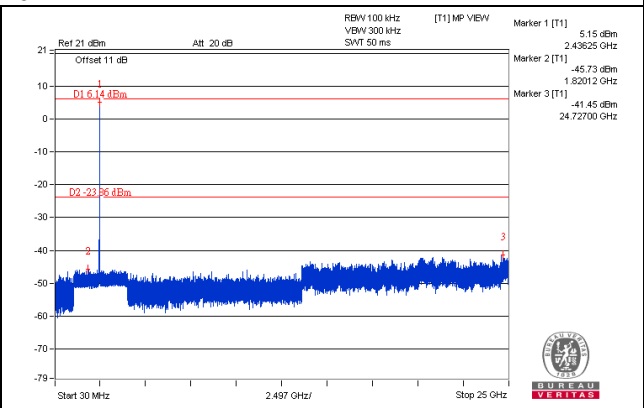
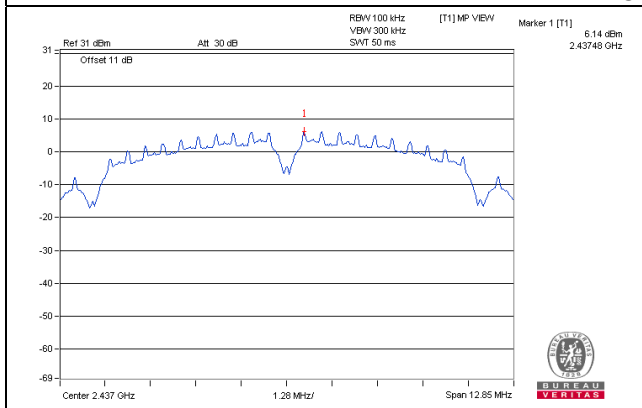

CH 11

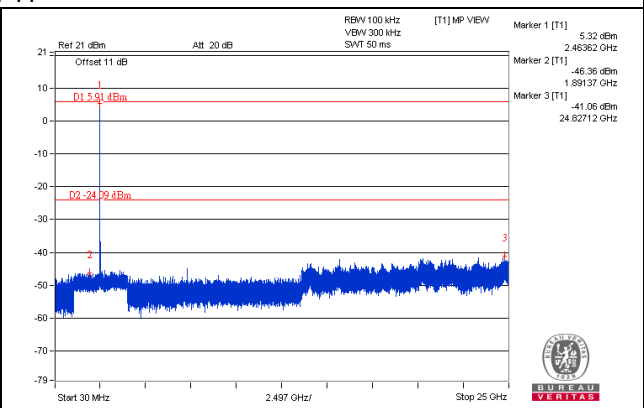
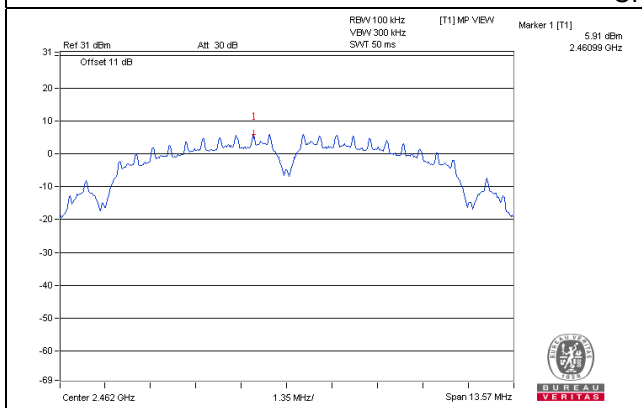

CH 1 Band edge

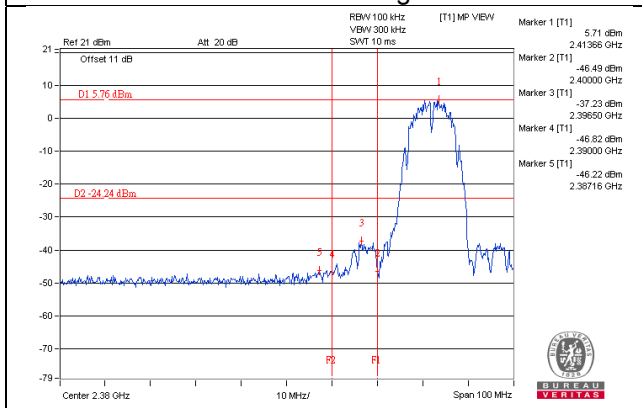

CH 11 Band edge

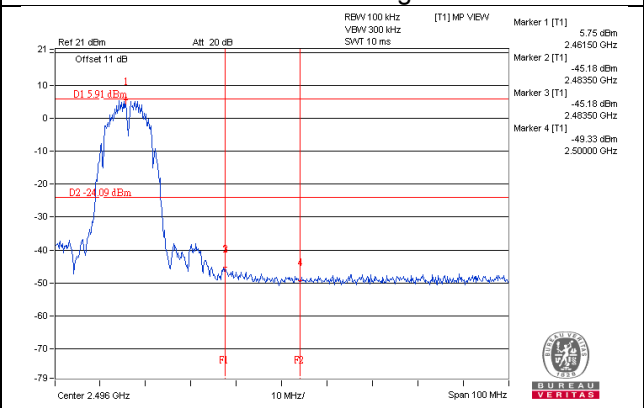

802.11g

CH 1

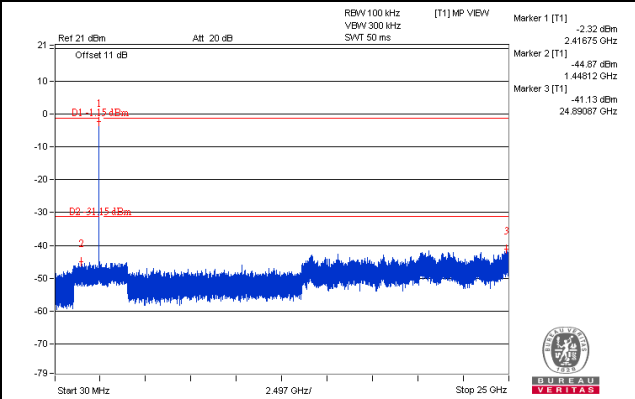
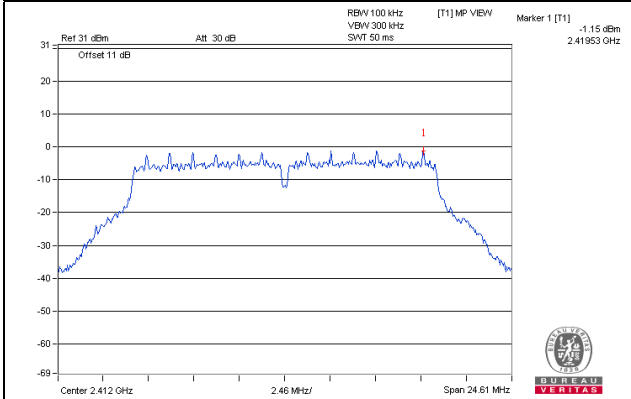

CH 6

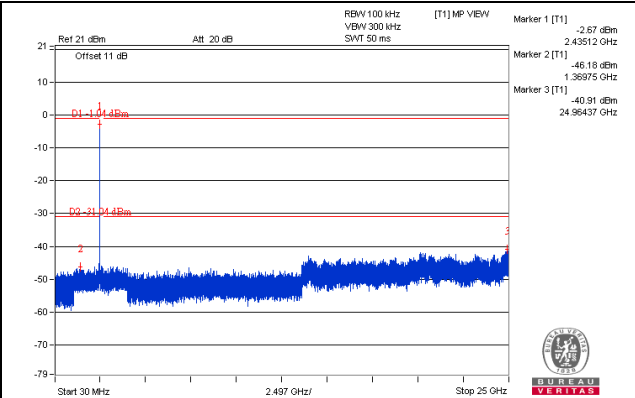
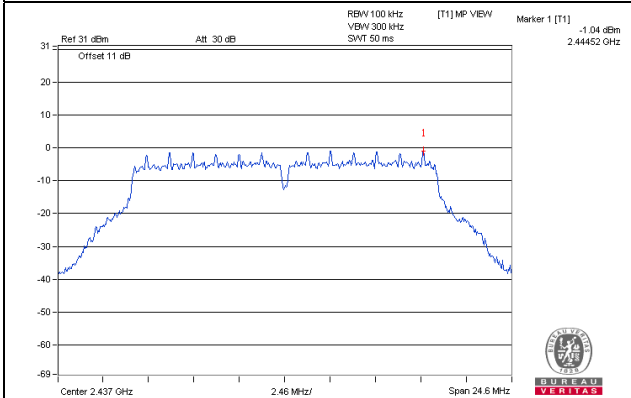

CH 11

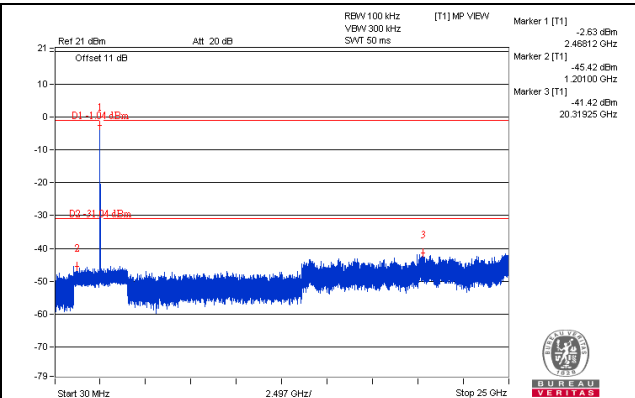
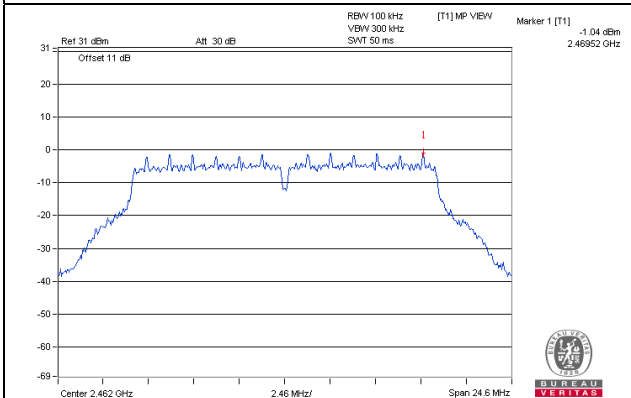

CH 1 Band edge

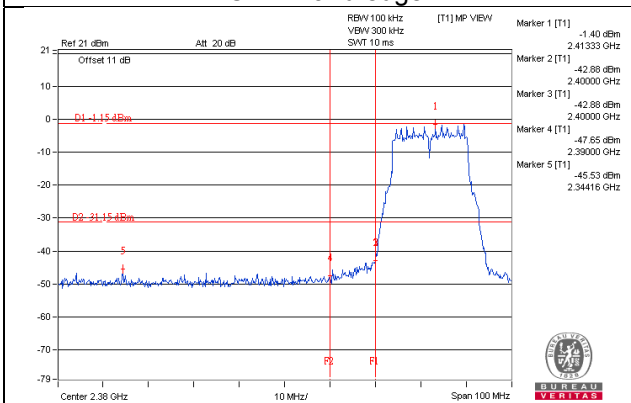

CH 11 Band edge

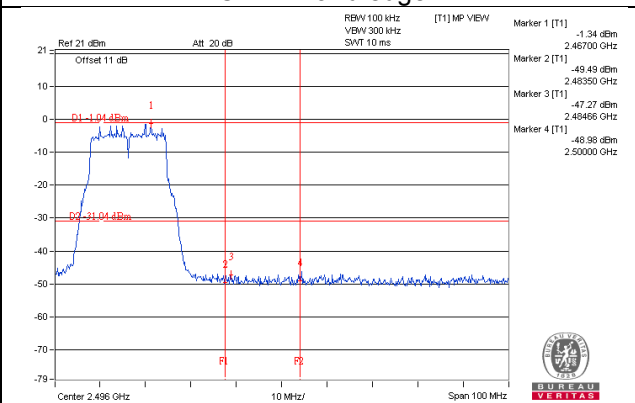

802.11n (HT20)

CH 1

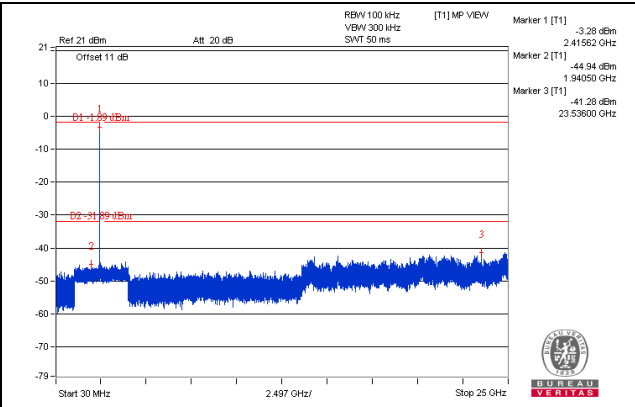
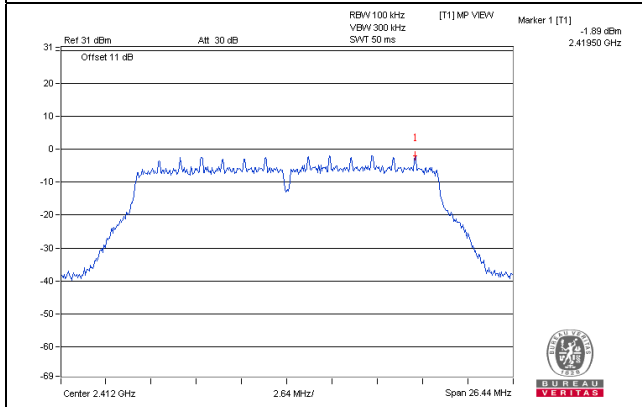

CH 6

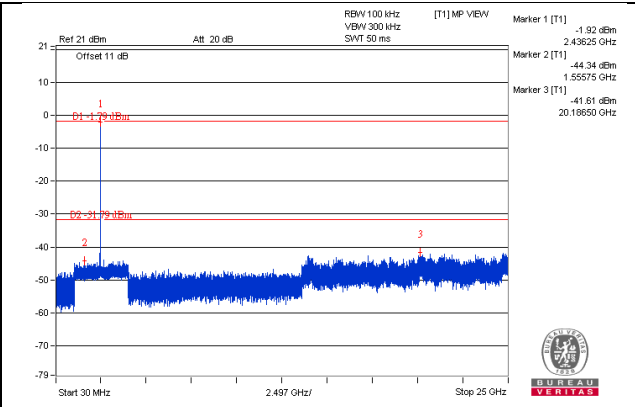
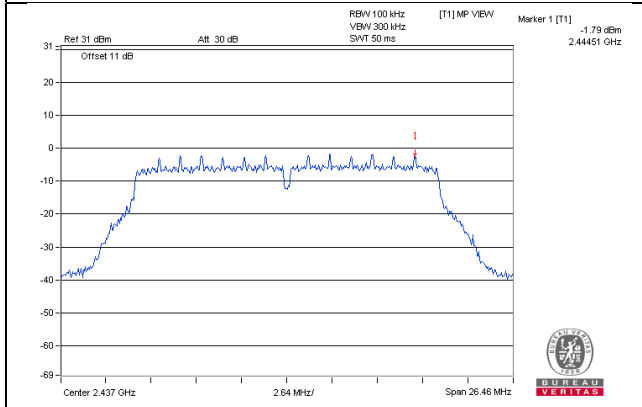

CH 11

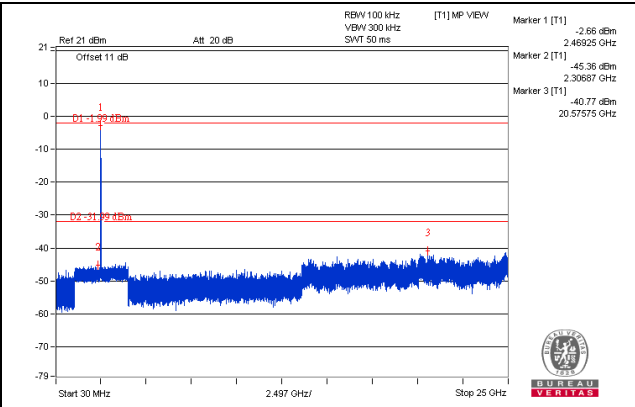
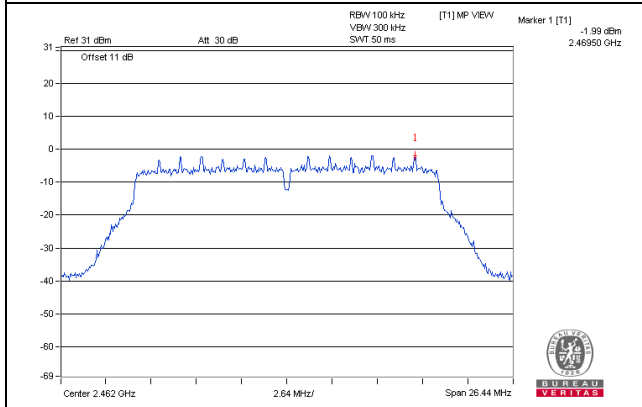

CH 1 Band edge

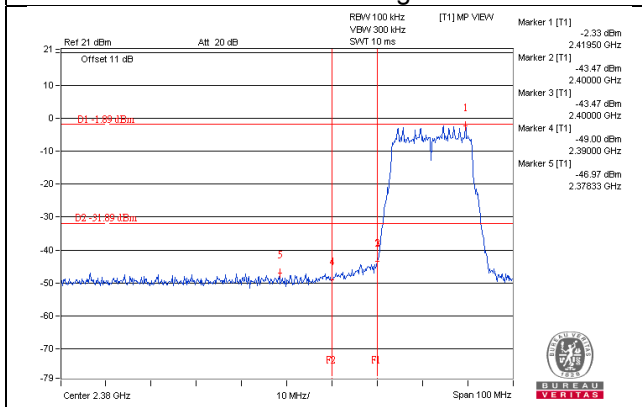

CH 11 Band edge

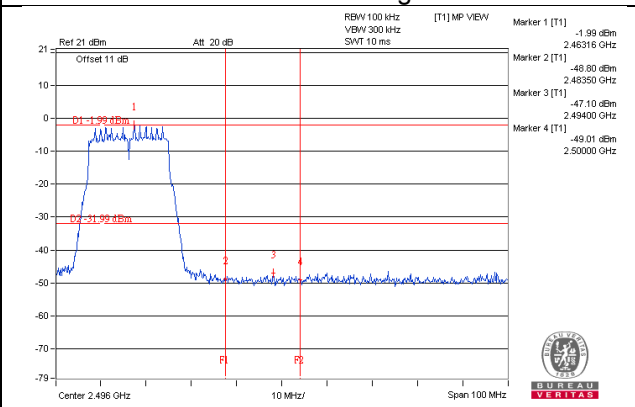

5 Pictures of Test Arrangements

Please refer to the attached file (Test Setup Photo).

Appendix – Information on the Testing Laboratories

We, Bureau Veritas Consumer Products Services (H.K.) Ltd., Taoyuan Branch, were founded in 1988 to provide our best service in EMC, Radio, Telecom and Safety consultation. Our laboratories are accredited and approved according to ISO/IEC 17025.

If you have any comments, please feel free to contact us at the following:

Linko EMC/RF Lab

Tel: 886-2-26052180

Fax: 886-2-26051924

Hsin Chu EMC/RF/Telecom Lab

Tel: 886-3-6668565

Fax: 886-3-6668323

Hwa Ya EMC/RF/Safety Lab

Tel: 886-3-3183232

Fax: 886-3-3270892

Email: service.adt@tw.bureauveritas.com

Web Site: www.bureauveritas-adt.com

The address and road map of all our labs can be found in our web site also.

--- END ---