



FCC 47 CFR PART 15 SUBPART C

TEST REPORT

For

Notebook Computer

Model:

Satellite L4***-C***** ,**

Satellite Radius L4***-C***** ,**

Satellite Radius E4***-C*******

(* means 0-9; a-z; A-Z; / ; - ; no symbol, or blank for marketing purpose)

Trade Name: TOSHIBA

Issued to

Pegatron Corporation

5F, NO. 76, LIGONG ST., BEITOU DISTRICT, TAIPEI CITY 112, TAIWAN (R.O.C.)

Issued by

Compliance Certification Services Inc.

No.11, Wugong 6th Rd., Wugu Dist.,

New Taipei City 24891, Taiwan. (R.O.C.)

<http://www.ccsrf.com>

service@ccsrf.com

Issued Date: April 21, 2015



Note: This report shall not be reproduced except in full, without the written approval of Compliance Certification Services Inc. This document may be altered or revised by Compliance Certification Services Inc. personnel only, and shall be noted in the revision section of the document.



Revision History

| Rev. | Issue Date | Revisions | Effect Page | Revised By |
|------|----------------|---------------|-------------|------------|
| 00 | April 21, 2015 | Initial Issue | ALL | Becca Chen |



TABLE OF CONTENTS

| | |
|--|-----------|
| 1. TEST RESULT CERTIFICATION..... | 4 |
| 2. EUT DESCRIPTION | 5 |
| 3. TEST METHODOLOGY | 7 |
| 3.1 EUT CONFIGURATION..... | 7 |
| 3.2 EUT EXERCISE..... | 7 |
| 3.3 GENERAL TEST PROCEDURES | 7 |
| 3.4 FCC PART 15.205 RESTRICTED BANDS OF OPERATIONS | 8 |
| 3.5 DESCRIPTION OF TEST MODES..... | 9 |
| 4. INSTRUMENT CALIBRATION..... | 10 |
| 4.1 MEASURING INSTRUMENT CALIBRATION | 10 |
| 4.2 MEASUREMENT EQUIPMENT USED..... | 10 |
| 4.3 MEASUREMENT UNCERTAINTY | 11 |
| 5. FACILITIES AND ACCREDITATIONS | 12 |
| 5.1 FACILITIES | 12 |
| 5.2 EQUIPMENT | 12 |
| 5.3 TABLE OF ACCREDITATIONS AND LISTINGS..... | 13 |
| 6. SETUP OF EQUIPMENT UNDER TEST | 14 |
| 6.1 SETUP CONFIGURATION OF EUT..... | 14 |
| 6.2 SUPPORT EQUIPMENT..... | 14 |
| 7. FCC PART 15.247 REQUIREMENTS..... | 15 |
| 7.1 20 DB BANDWIDTH | 15 |
| 7.2 PEAK POWER | 22 |
| 7.3 AVERAGE POWER | 23 |
| 7.4 BAND EDGES MEASUREMENT..... | 24 |
| 7.5 FREQUENCY SEPARATION..... | 42 |
| 7.6 NUMBER OF HOPPING FREQUENCY | 47 |
| 7.7 TIME OF OCCUPANCY (DWELL TIME)..... | 52 |
| 7.8 SPURIOUS EMISSIONS | 60 |
| 7.9 POWERLINE CONDUCTED EMISSIONS..... | 78 |
| APPENDIX I PHOTOGRAPHS OF TEST SETUP..... | 81 |
| APPENDIX 1 - PHOTOGRAPHS OF EUT | |



1. TEST RESULT CERTIFICATION

Applicant: Pegatron Corporation
5F, NO. 76, LIGONG ST., BEITOU DISTRICT, TAIPEI CITY
112, TAIWAN (R.O.C.)

Equipment Under Test: Notebook Computer

Trade Name: TOSHIBA

Model: Satellite L4*****-C***** ,
Satellite Radius L4*****-C***** ,
Satellite Radius E4*****-C*****
(* means 0-9; a-z; A-Z; / ; - ; no symbol, or blank for marketing purpose)

Date of Test: April 20, 2015

| APPLICABLE STANDARDS | |
|------------------------------|-------------------------|
| STANDARD | TEST RESULT |
| FCC 47 CFR Part 15 Subpart C | No non-compliance noted |

We hereby certify that:

The above equipment was tested by Compliance Certification Services Inc. The test data, data evaluation, test procedures, and equipment configurations shown in this report were made in accordance with the procedures given in **ANSI C63.10: 2013** and the energy emitted by the sample EUT tested as described in this report is in compliance with the requirements set forth in the above standards. The test results of this report relate only to the tested sample EUT identified in this report.

Approved by:

Reviewed by:

Miller Lee
Section Manager
Compliance Certification Services Inc.

Angel Cheng
Section Manager
Compliance Certification Services Inc.



2. EUT DESCRIPTION

| | | | |
|---|--|---|-----------|
| Product | Notebook Computer | | |
| Trade Name | TOSHIBA | | |
| Model Number | Satellite L4*****-C***** , Satellite Radius L4*****-C***** , Satellite Radius E4*****-C***** (* means 0-9; a-z; A-Z; / ; - ; no symbol, or blank for marketing purpose) | | |
| Model Discrepancy | All the above models are identical except for the designation of model numbers. The suffix of "*" (* means 0-9; a-z; A-Z; / ; - ; no symbol, or blank for marketing purpose) on model number is just for marketing purpose only. | | |
| WLAN Manufacturer | Realtek | Model | RTL8723BE |
| Received Date | March 31, 2015 | | |
| Power Rating | 1. VDC from Power Adapter 2. Power from Battery | | |
| Power Adaptor Power Rating / Manufacturer | TOSHIBA (Vendor: Delta) / PA5177U-1ACA I/P: 100-240Vac, 50/60Hz, 1.2A O/P: 19Vdc, 2.37A | | |
| | TOSHIBA (Vendor: Liteon) / PA5177U-1ACA I/P: 100-240Vac, 50-60Hz, 1.3A O/P: 19Vdc, 2.37A | | |
| | TOSHIBA (Vendor: Chicony) / PA5177U-1ACA I/P: 100-240Vac, 50-60Hz, 1.3A O/P: 19Vdc, 2.37A | | |
| | TOSHIBA (Vendor: Liteon) / PA5177E-1AC3 I/P: 100-240Vac, 50-60Hz, 1.3A O/P: 19Vdc, 2.37A | | |
| | TOSHIBA (Vendor: Delta) / PA5177E-1AC3 I/P: 100-240Vac, 50/60Hz, 1.2A O/P: 19Vdc, 2.37A | | |
| | TOSHIBA (Vendor: Chicony) / PA5177E-1AC3 I/P: 100-240Vac, 50-60Hz, 1.3A O/P: 19Vdc, 2.37A | | |
| | Battery Rating / Manufacturer | TOSHIBA (Sanyo) / PA5208U-1BRS 10.8Vdc, 45Wh, 3860mAh | |
| TOSHIBA (LG) / PA5208U-1BRS 10.8Vdc, 45Wh, 3860mAh | | | |
| TOSHIBA (Samsung) (SDI) / PA5208U-1BRS 10.8Vdc, 45Wh, 3860mAh | | | |
| TOSHIBA (BYD) / PA5208U-1BRS 10.8Vdc,45Wh, 3860mAh | | | |
| Frequency Range | 2402 ~ 2480 MHz | | |
| Transmit Power | 9.88 dBm | | |
| Modulation Technique | GFSK for 1Mbps; $\pi/4$ -DQPSK for 2Mbps; 8DPSK for 3Mbps | | |



| | |
|------------------------------|--|
| Number of Channels | 79 Channels |
| Antenna Specification | 1. PIFA Antenna / ACON ANP6Y-100012 (TX1) / 1.31 dBi ANP6Y-100013 (TX2) / 0.33 dBi 2. PIFA Antenna / INPAQ WA-P-LB-01-126 (TX1) / 0.39 dBi WA-P-LB-02-257 (TX2) / -0.59 dBi |

Remark:

1. *The sample selected for test was engineering sample that approximated to production product and was provided by manufacturer.*
2. *This submittal(s) (test report) is intended for FCC ID: VUI-EOS8723 filing to comply with Section 15.207, 15.209 and 15.247 of the FCC Part 15, Subpart C Rules.*



3. TEST METHODOLOGY

The tests documented in this report were performed in accordance with ANSI C63.10 and FCC CFR 47 2.1046, 2.1047, 2.1049, 2.1051, 2.1053, 2.1055, 2.1057, 15.207, 15.209, 15.247 and DA00-705.

3.1 EUT CONFIGURATION

The EUT configuration for testing is installed on RF field strength measurement to meet the Commissions requirement and operating in a manner that intends to maximize its emission characteristics in a continuous normal application.

3.2 EUT EXERCISE

The EUT was operated in the engineering mode to fix the TX frequency that was for the purpose of the measurements.

According to its specifications, the EUT must comply with the requirements of the Section 15.207, 15.209 and 15.247 under the FCC Rules Part 15 Subpart C.

3.3 GENERAL TEST PROCEDURES

Conducted Emissions

The EUT is placed on the turntable, which is 0.8 m above ground plane. According to the requirements in Section 13.1.4.1 of ANSI C63.10 Conducted emissions from the EUT measured in the frequency range between 0.15 MHz and 30MHz using CISPR Quasi-peak and average detector modes.

Radiated Emissions

The EUT is placed on a turn table, which is 0.8 m above ground plane. The turntable shall rotate 360 degrees to determine the position of maximum emission level. EUT is set 3m away from the receiving antenna, which varied from 1m to 4m to find out the highest emission. And also, each emission was to be maximized by changing the polarization of receiving antenna both horizontal and vertical. In order to find out the maximum emissions, exploratory radiated emission measurements were made according to the requirements in Section 13.1.4.1 of ANSI C63.10: 2013.



3.4 FCC PART 15.205 RESTRICTED BANDS OF OPERATIONS

(a) Except as shown in paragraph (d) of this section, only spurious emissions are permitted in any of the frequency bands listed below:

| MHz | MHz | MHz | GHz |
|----------------------------|---------------------|-----------------|------------------|
| 0.090 - 0.110 | 16.42 - 16.423 | 399.9 - 410 | 4.5 - 5.15 |
| ¹ 0.495 - 0.505 | 16.69475 - 16.69525 | 608 - 614 | 5.35 - 5.46 |
| 2.1735 - 2.1905 | 16.80425 - 16.80475 | 960 - 1240 | 7.25 - 7.75 |
| 4.125 - 4.128 | 25.5 - 25.67 | 1300 - 1427 | 8.025 - 8.5 |
| 4.17725 - 4.17775 | 37.5 - 38.25 | 1435 - 1626.5 | 9.0 - 9.2 |
| 4.20725 - 4.20775 | 73 - 74.6 | 1645.5 - 1646.5 | 9.3 - 9.5 |
| 6.215 - 6.218 | 74.8 - 75.2 | 1660 - 1710 | 10.6 - 12.7 |
| 6.26775 - 6.26825 | 108 - 121.94 | 1718.8 - 1722.2 | 13.25 - 13.4 |
| 6.31175 - 6.31225 | 123 - 138 | 2200 - 2300 | 14.47 - 14.5 |
| 8.291 - 8.294 | 149.9 - 150.05 | 2310 - 2390 | 15.35 - 16.2 |
| 8.362 - 8.366 | 156.52475 - | 2483.5 - 2500 | 17.7 - 21.4 |
| 8.37625 - 8.38675 | 156.52525 | 2655 - 2900 | 22.01 - 23.12 |
| 8.41425 - 8.41475 | 156.7 - 156.9 | 3260 - 3267 | 23.6 - 24.0 |
| 12.29 - 12.293 | 162.0125 - 167.17 | 3332 - 3339 | 31.2 - 31.8 |
| 12.51975 - 12.52025 | 167.72 - 173.2 | 3345.8 - 3358 | 36.43 - 36.5 |
| 12.57675 - 12.57725 | 240 - 285 | 3600 - 4400 | (²) |
| 13.36 - 13.41 | 322 - 335.4 | | |

¹ Until February 1, 1999, this restricted band shall be 0.490-0.510 MHz.

² Above 38.6

(b) Except as provided in paragraphs (d) and (e), the field strength of emissions appearing within these frequency bands shall not exceed the limits shown in Section 15.209. At frequencies equal to or less than 1000 MHz, compliance with the limits in Section 15.209 shall be demonstrated using measurement instrumentation employing a CISPR quasi-peak detector. Above 1000 MHz, compliance with the emission limits in Section 15.209 shall be demonstrated based on the average value of the measured emissions. The provisions in Section 15.35 apply to these measurements.



3.5 DESCRIPTION OF TEST MODES

The EUT (model: Satellite L4-C) had been tested under operating condition.

Test program used to control the EUT for staying in continuous transmitting mode was programmed.

After verification, all tests were carried out with the worst case test modes as shown below except radiated spurious emission below 1GHz and power line conducted emissions below 30MHz, which worst case was in normal link mode only.

Channel Low (2402MHz), Mid (2441MHz) and High (2480MHz) with 1Mbps data rate was chosen for full testing.

During the preliminary test, GFSK, $\pi/4$ -QPSK & 8DPSK with DH1 were pre-tested and found that 8DPSK emits the highest output power. Then the tests were carried on with DH1 compare to DH3 & DH5 and found that 8DPSK with DH5 emit the highest output power, and therefore had been tested under operating condition.

Following channels were selected for the radiated emission testing only as listed below:

| Tested Channel | Modulation Type | Packet Type | Data Rate |
|----------------|-----------------|-------------|-----------|
| Low, Mid, High | GFSK | DH 5 | 1 |
| Low, Mid, High | 8DPSK | DH 5 | 3 |

The field strength of spurious emission was measured in the following position: The EUT has Notebook mode, Flat mode, and Tent mode, Stand mode, Tablet X, Y and Z axis modes. The worst emission was found in Notebook mode and the worst case was recorded.



4. INSTRUMENT CALIBRATION

4.1 MEASURING INSTRUMENT CALIBRATION

The measuring equipment, which was utilized in performing the tests documented herein, has been calibrated in accordance with the manufacturer's recommendations for utilizing calibration equipment, which is traceable to recognized national standards.

4.2 MEASUREMENT EQUIPMENT USED

Equipment Used for Emissions Measurement

Remark: Each piece of equipment is scheduled for calibration once a year.

| Conducted Emissions Test Site | | | | |
|---------------------------------|--------------------|-----------|---------------|-----------------|
| Name of Equipment | Manufacturer | Model | Serial Number | Calibration Due |
| Spectrum Analyzer | Agilent | E4446A | US42510252 | 11/23/2015 |
| Thermostatic/Hrgrosatic Chamber | TAICHY | MHG-150LF | 930619 | 10/07/2015 |
| AC Power Source | EXTECH | 6205 | 1140845 | N.C.R |
| DC Power Supply | ABM | 8301HD | D011531 | N.C.R |
| Power Meter | Anritsu | ML2495A | 1012009 | 06/03/2015 |
| Power Sensor | Anritsu | MA2411A | 0917072 | 06/03/2015 |
| Spectrum Analyzer | ROHDE&SCHWARZ | FSV40 | 101073 | 07/09/2015 |
| Test S/W | EZ-EMC (CCS-3A1RE) | | | |

| Wugu 966 Chamber A | | | | |
|--------------------|--------------------|-------------------------|---------------|-----------------|
| Name of Equipment | Manufacturer | Model | Serial Number | Calibration Due |
| Spectrum Analyzer | Agilent | E4446A | US42510268 | 09/18/2015 |
| EMI Test Receiver | R&S | ESCI | 100064 | 05/30/2015 |
| Bilog Antenna | Sunol Sciences | JB3 | A030105 | 08/19/2015 |
| Horn Antenna | EMCO | 3117 | 00055165 | 01/26/2016 |
| Horn Antenna | EMCO | 3116 | 26370 | 12/25/2015 |
| Turn Table | CCS | CC-T-1F | N/A | N.C.R |
| Antenna Tower | CCS | CC-A-1F | N/A | N.C.R |
| Controller | CCS | CC-C-1F | N/A | N.C.R |
| Pre-Amplifier | MITEQ | 1652-3000 | 1490939 | 08/09/2016 |
| Pre-Amplifier | EMC | EMC 01265 | 4035 | 08/09/2016 |
| Pre-Amplifier | MITEQ | AMF-6F-260400-4 0-8P | 985646 | 12/25/2015 |
| Coaxial Cable | Huber+Suhner | 102 | 29212/2 | 12/25/2015 |
| Coaxial Cable | Huber+Suhner | 102 | 29406/2 | 12/25/2015 |
| Test S/W | EZ-EMC (CCS-3A1RE) | | | |

| Conducted Emission room #A | | | | |
|----------------------------|--------------|-----------|---------------|-----------------|
| Name of Equipment | Manufacturer | Model | Serial Number | Calibration Due |
| EMI Test Receiver | R&S | ESI | 101203 | 09/11/2015 |
| LISN | R&S | ESH3-Z5 | 848773/014 | 12/04/2015 |
| Coaxial Cable | Commate | CFD300-NL | NA | 12/04/2015 |
| Test S/W | CCS-3A1-CE | | | |

NOTE: 1. The calibration interval of the above test instruments is 12 months and the calibrations are traceable to NML/ROC and NIST/USA.

2. N.C.R = No Calibration Request.



4.3 MEASUREMENT UNCERTAINTY

| PARAMETER | UNCERTAINTY |
|---------------------------------------|-------------|
| Powerline Conducted Emission | +/- 1.2159 |
| 3M Semi Anechoic Chamber / <200M | +/- 4.0138 |
| 3M Semi Anechoic Chamber / 200M~1000M | +/- 3.9483 |
| 3M Semi Anechoic Chamber / 1G~8G | +/- 2.5975 |
| 3M Semi Anechoic Chamber / 8G~18G | +/- 2.6112 |
| 3M Semi Anechoic Chamber / 18G~26G | +/- 2.7389 |
| 3M Semi Anechoic Chamber / 26G~40G | +/- 2.9683 |

Remark: This uncertainty represents an expanded uncertainty expressed at approximately the 95% confidence level using a coverage factor of $k=2$.



5. FACILITIES AND ACCREDITATIONS

5.1 FACILITIES

All measurement facilities used to collect the measurement data are located at

No.199, Chunghsen Road, Hsintien City, Taipei Hsien, Taiwan, R.O.C.

Tel: 886-2-2217-0894 / Fax: 886-2-2217-1029

No.11, Wugong 6th Rd., Wugu Dist., New Taipei City 24891, Taiwan. (R.O.C.)

Tel: 886-2-2299-9720 / Fax: 886-2-2298-4045

No.81-1, Lane 210, Bade 2nd Rd., Lujhu Township, Taoyuan County 33841, TAIWAN,
R.O.C.

Tel: 886-3-324-0332 / Fax: 886-3-324-5235

The sites are constructed in conformance with the requirements of ANSI C63.7, ANSI C63.10 and CISPR Publication 22.

5.2 EQUIPMENT

Radiated emissions are measured with one or more of the following types of linearly polarized antennas: tuned dipole, biconical, log periodic, bi-log, and/or ridged waveguide, horn. Spectrum analyzers with pre-selectors and quasi-peak detectors are used to perform radiated measurements.



Conducted emissions are measured with Line Impedance Stabilization Networks and EMI Test Receivers.

Calibrated wideband preamplifiers, coaxial cables, and coaxial attenuators are also used for making measurements.

All receiving equipment conforms to CISPR Publication 16-1, "Radio Interference Measuring Apparatus and Measurement Methods."



5.3 TABLE OF ACCREDITATIONS AND LISTINGS

| Country | Agency | Scope of Accreditation | Logo |
|---------|-----------------|--|---|
| USA | FCC | 3M Semi Anechoic Chamber (FCC MRA: TW1039) to perform FCC Part 15 measurements |  FCC MRA: TW1039 |
| Taiwan | TAF | LP0002, RTTE01, FCC Method-47 CFR Part 15 Subpart C, D, E, RSS-210, RSS-310 IDA TS SRD, AS/NZS 4268, AS/NZS 4771, TS 12.1 & 12.2, ETSI EN 300 440-1, ETSI EN 300 440-2, ETSI EN 300 328, ETSI EN 300 220-1, ETSI EN 300 220-2, ETSI EN 301 893, ETSI EN 301 489-1/3/7/17 FCC OET Bulletin 65 + Supplement C, EN 50360, EN 50361, EN 50371, RSS 102, EN 50383, EN 50385, EN 50392, IEC 62209, CNS 14958-1, CNS 14959 FCC Method -47 CFR Part 15 Subpart B IEC / EN 61000-3-2, IEC / EN 61000-3-3, IEC / EN 61000-4-2/3/4/5/6/8/11 |  |
| Canada | Industry Canada | 3M Semi Anechoic Chamber (IC 2324G-1 / IC 2324G-2) to perform |  IC 2324G-1 IC 2324G-2 |

* No part of this report may be used to claim or imply product endorsement by A2LA or any agency of the US Government.



6. SETUP OF EQUIPMENT UNDER TEST

6.1 SETUP CONFIGURATION OF EUT

See test photographs attached in Appendix II for the actual connections between EUT and support equipment.

6.2 SUPPORT EQUIPMENT

| No | Device Type | Brand | Model | Series No. | FCC ID | Data Cable | Power Cord |
|----|-------------|-------|-------|------------|--------|------------|------------|
| | N/A | | | | | | |

Remark:

1. *All the equipment/cables were placed in the worst-case configuration to maximize the emission during the test.*
2. *Grounding was established in accordance with the manufacturer's requirements and conditions for the intended use.*



7. FCC PART 15.247 REQUIREMENTS

7.1 20 DB BANDWIDTH

LIMIT

None; for reporting purposes only.

Test Configuration

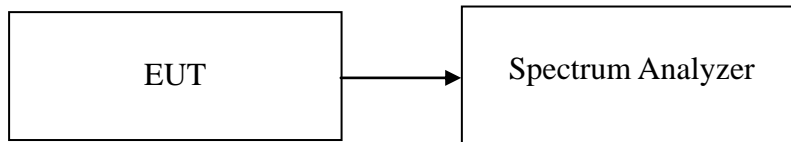

TEST PROCEDURE

1. Place the EUT on the table and set it in the transmitting mode.
2. Remove the antenna from the EUT and then connect a low loss RF cable from the antenna port to the spectrum analyzer.
3. Set the spectrum analyzer as RBW=30 kHz, VBW = 100 kHz, Sweep = 3.2 ms.
4. Mark the peak frequency and 20dB (upper and lower) frequency.
5. Repeat until all the rest channels are investigated.

TEST RESULTS

No non-compliance noted.

Test Data

For GFSK / DH5

| Channel | Frequency (MHz) | 20dB Bandwidth (MHz) |
|---------|-----------------|----------------------|
| Low | 2402 | 1.05 |
| Mid | 2441 | 1.06 |
| High | 2480 | 1.035 |

For 8DPSK / DH5

| Channel | Frequency (MHz) | 20dB Bandwidth (MHz) |
|---------|-----------------|----------------------|
| Low | 2402 | 1.295 |
| Mid | 2441 | 1.295 |
| High | 2480 | 1.32 |



Test Plot

For GFSK / DH5

20dB Bandwidth (CH Low)

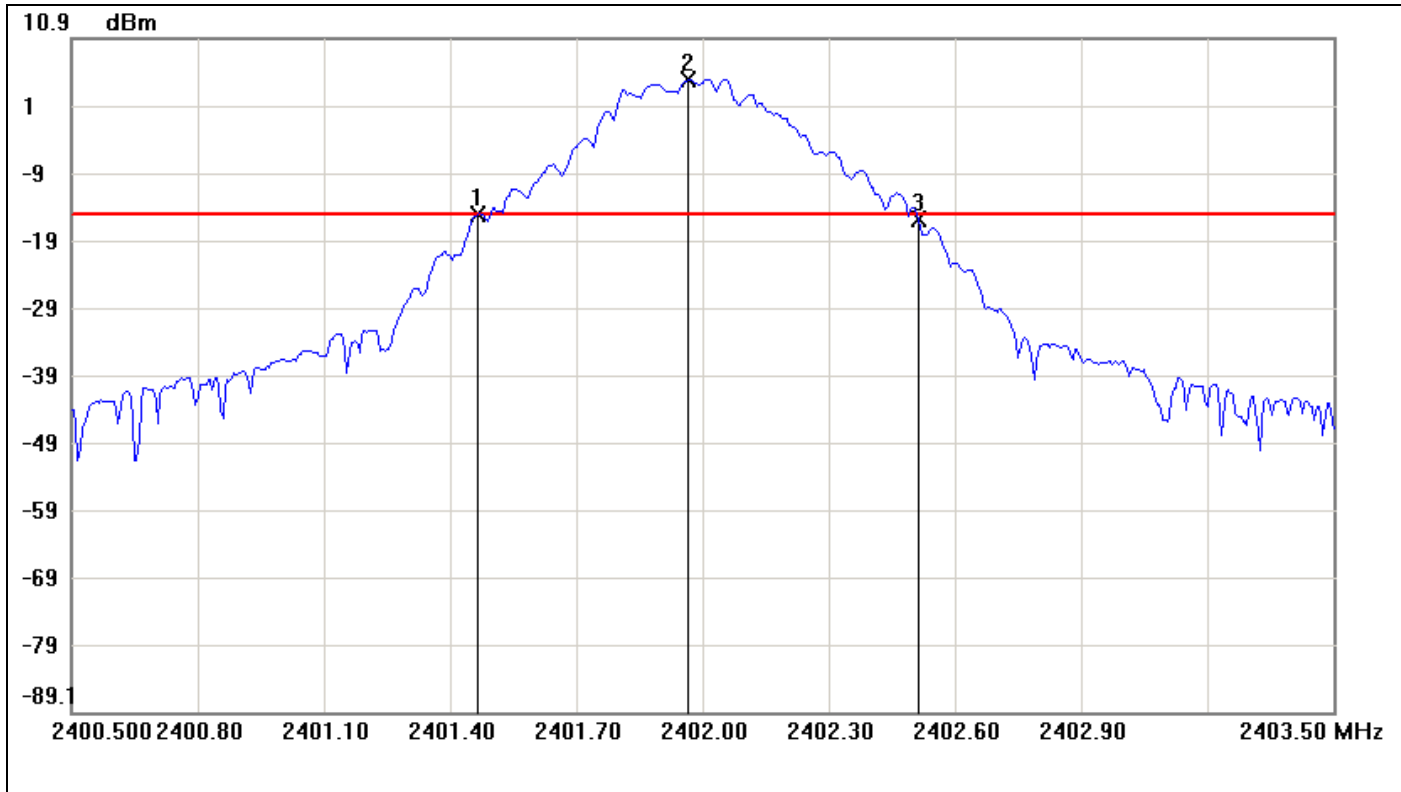

| No. | Frequency(MHz) | Result(dBm) | Limit(dBm) | Margin(dBm) |
|-----|----------------|-------------|------------|-------------|
| 1 | 2401.4650 | -15.14 | -15.14 | 0.00 |
| 2 | 2401.9650 | 4.86 | -15.14 | 20.00 |
| 3 | 2402.5150 | -15.96 | -15.14 | -0.82 |

| No. | | Δ Frequency(MHz) | Δ Level(dB) |
|-----|---------|-------------------------|--------------------|
| 1 | mk3-mk1 | 1.05 | -0.82 |



20dB Bandwidth (CH Mid)

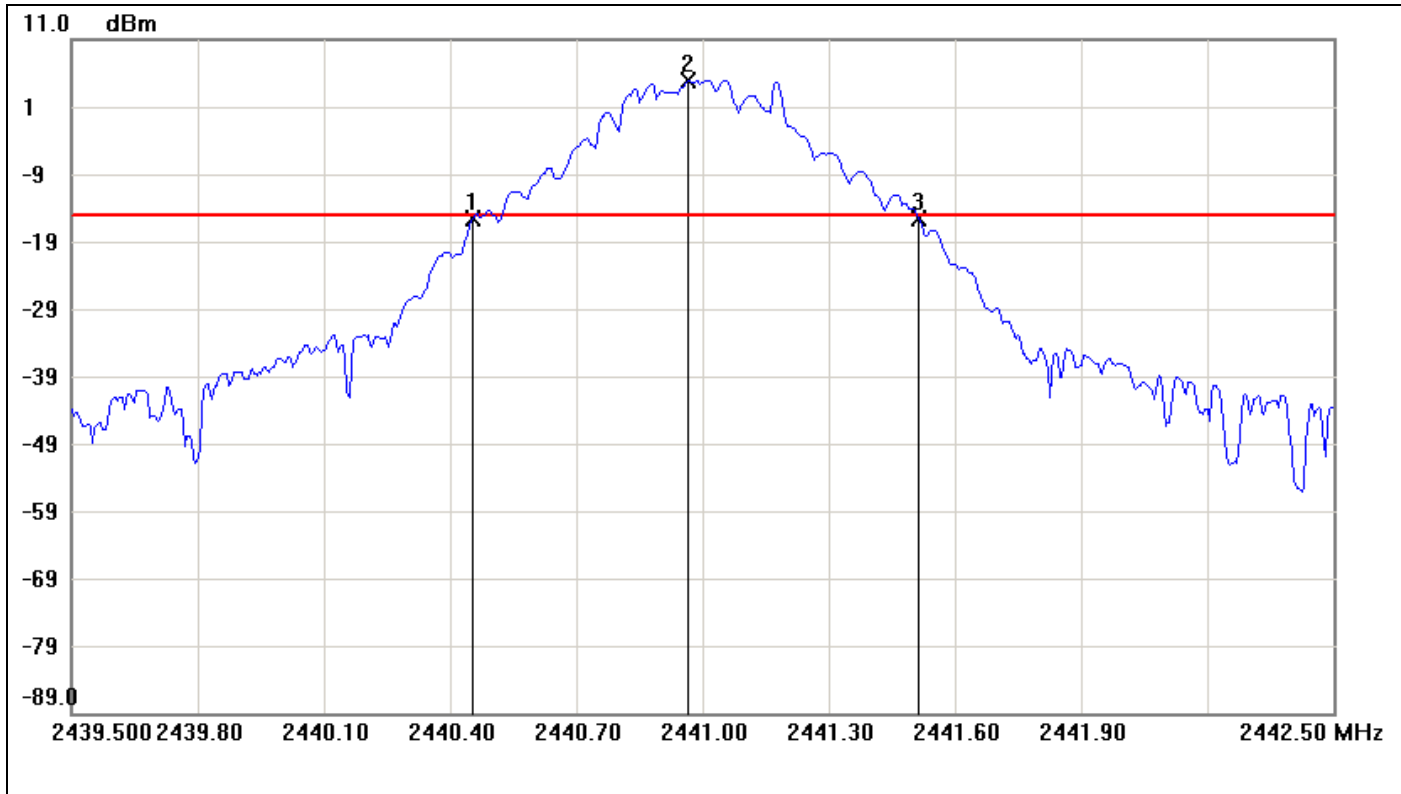

| No. | Frequency(MHz) | Result(dBm) | Limit(dBm) | Margin(dBm) |
|-----|----------------|-------------|------------|-------------|
| 1 | 2440.4550 | -15.68 | -15.10 | -0.58 |
| 2 | 2440.9650 | 4.90 | -15.10 | 20.00 |
| 3 | 2441.5150 | -15.61 | -15.10 | -0.51 |

| No. | | Δ Frequency(MHz) | Δ Level(dB) |
|-----|---------|-------------------------|--------------------|
| 1 | mk3-mk1 | 1.06 | 0.07 |



20dB Bandwidth (CH High)

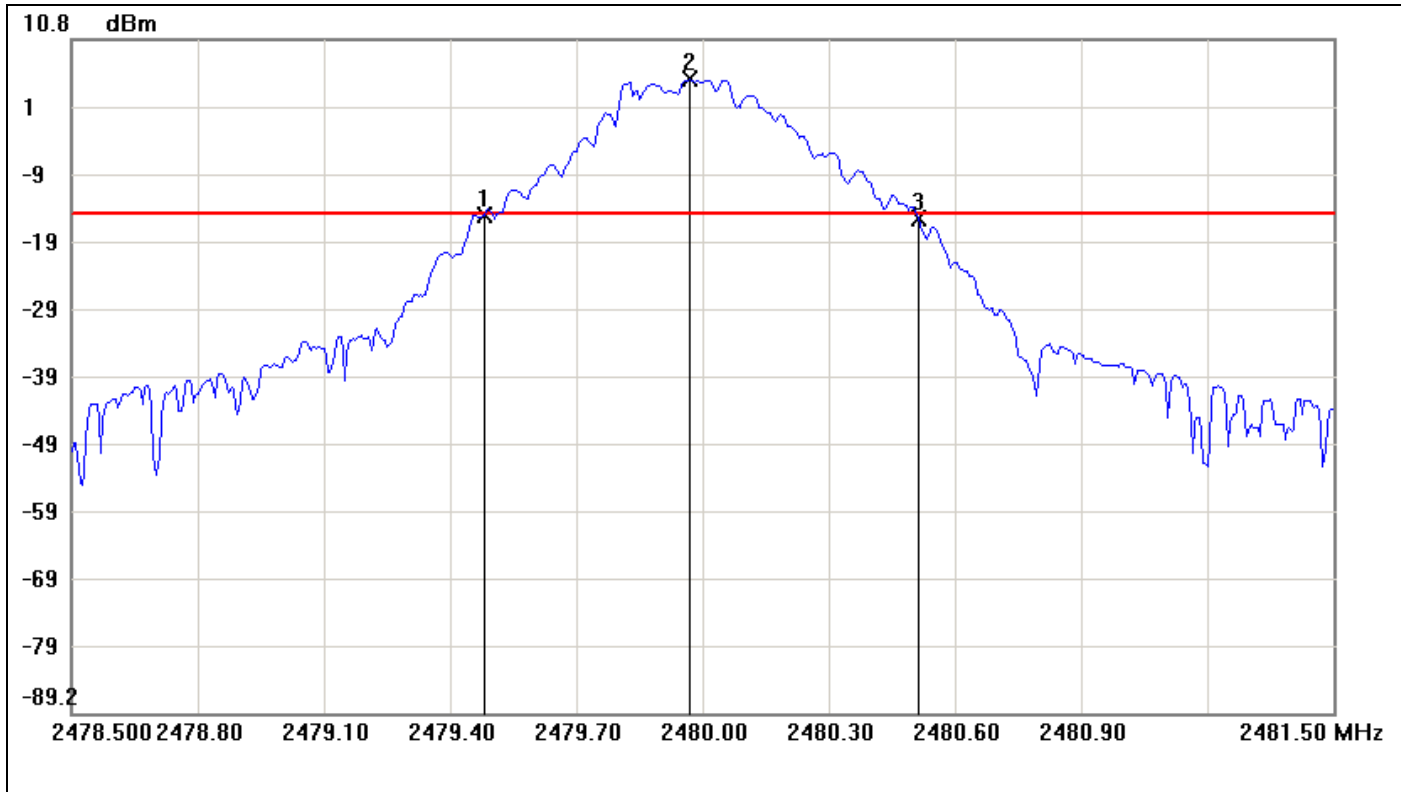

| No. | Frequency(MHz) | Result(dBm) | Limit(dBm) | Margin(dBm) |
|-----|----------------|-------------|------------|-------------|
| 1 | 2479.4800 | -15.29 | -15.18 | -0.11 |
| 2 | 2479.9700 | 4.82 | -15.18 | 20.00 |
| 3 | 2480.5150 | -15.75 | -15.18 | -0.57 |

| No. | | Δ Frequency(MHz) | Δ Level(dB) |
|-----|---------|-------------------------|--------------------|
| 1 | mk3-mk1 | 1.035 | -0.46 |



For 8DPSK / DH5

20dB Bandwidth (CH Low)

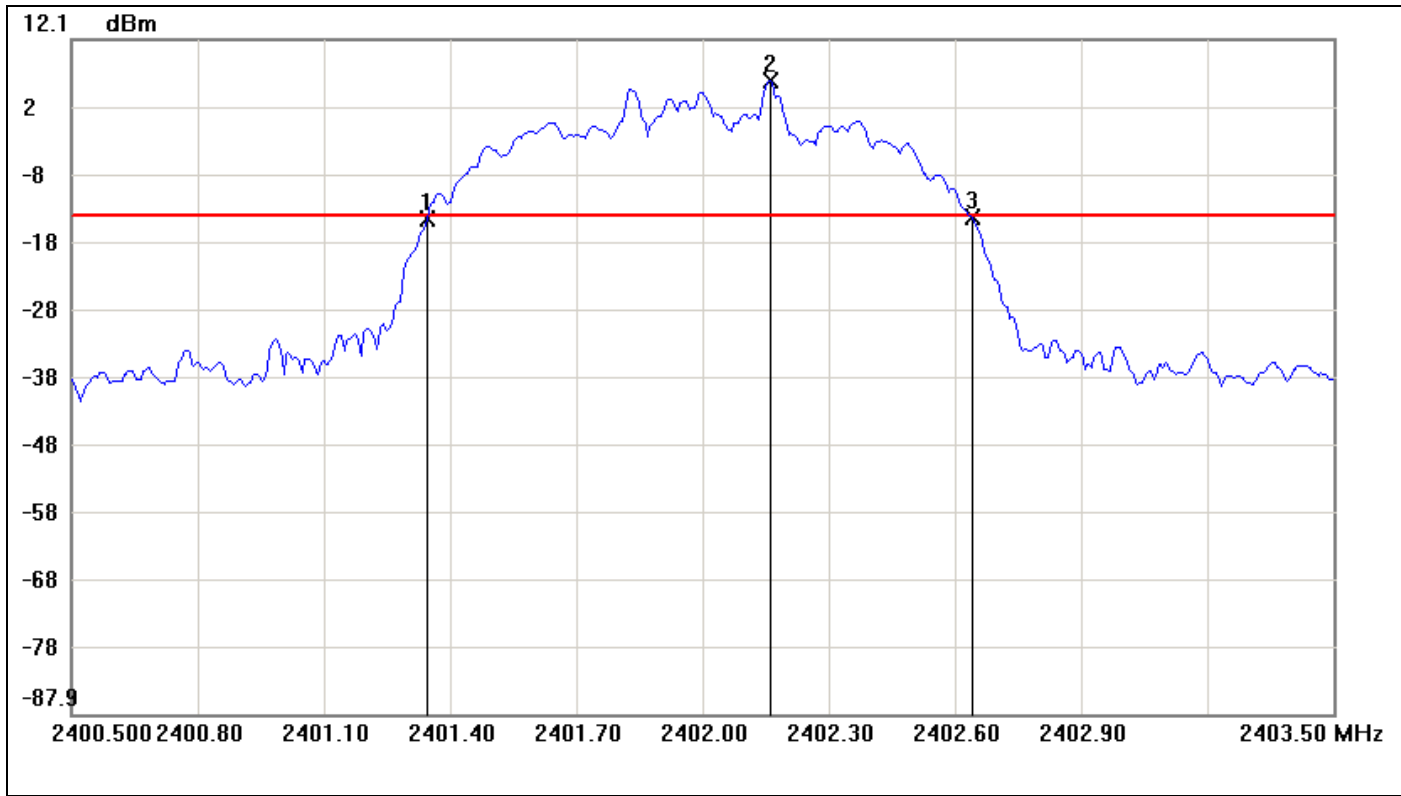

| No. | Frequency(MHz) | Result(dBm) | Limit(dBm) | Margin(dBm) |
|-----|----------------|-------------|------------|-------------|
| 1 | 2401.3450 | -14.44 | -14.08 | -0.36 |
| 2 | 2402.1600 | 5.92 | -14.08 | 20.00 |
| 3 | 2402.6400 | -14.23 | -14.08 | -0.15 |

| No. | | Δ Frequency(MHz) | Δ Level(dB) |
|-----|---------|-------------------------|--------------------|
| 1 | mk3-mk1 | 1.295 | 0.21 |



20dB Bandwidth (CH Mid)

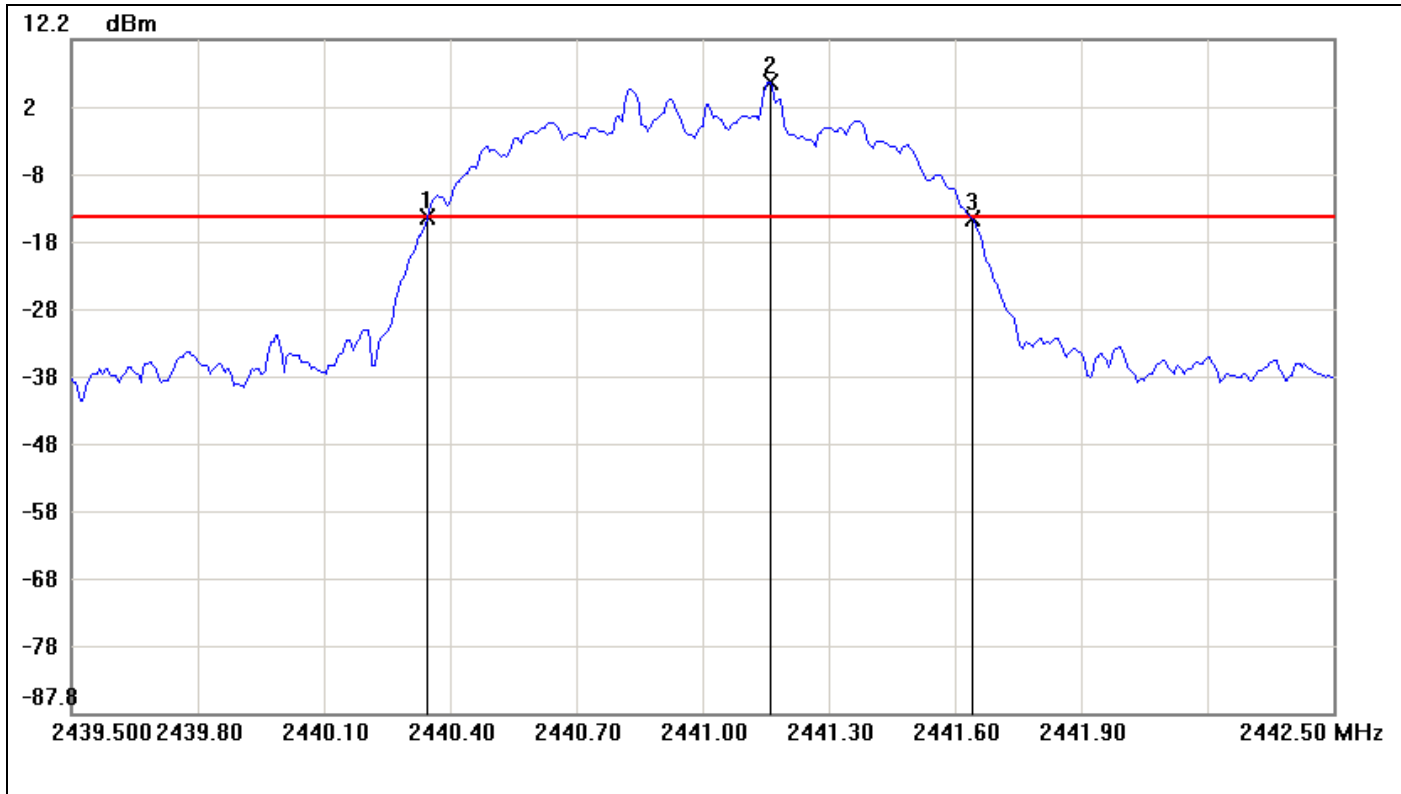

| No. | Frequency(MHz) | Result(dBm) | Limit(dBm) | Margin(dBm) |
|-----|----------------|-------------|------------|-------------|
| 1 | 2440.3450 | -14.19 | -14.17 | -0.02 |
| 2 | 2441.1600 | 5.83 | -14.17 | 20.00 |
| 3 | 2441.6400 | -14.37 | -14.17 | -0.20 |

| No. | | Δ Frequency(MHz) | Δ Level(dB) |
|-----|---------|-------------------------|--------------------|
| 1 | mk3-mk1 | 1.295 | -0.18 |



20dB Bandwidth (CH High)

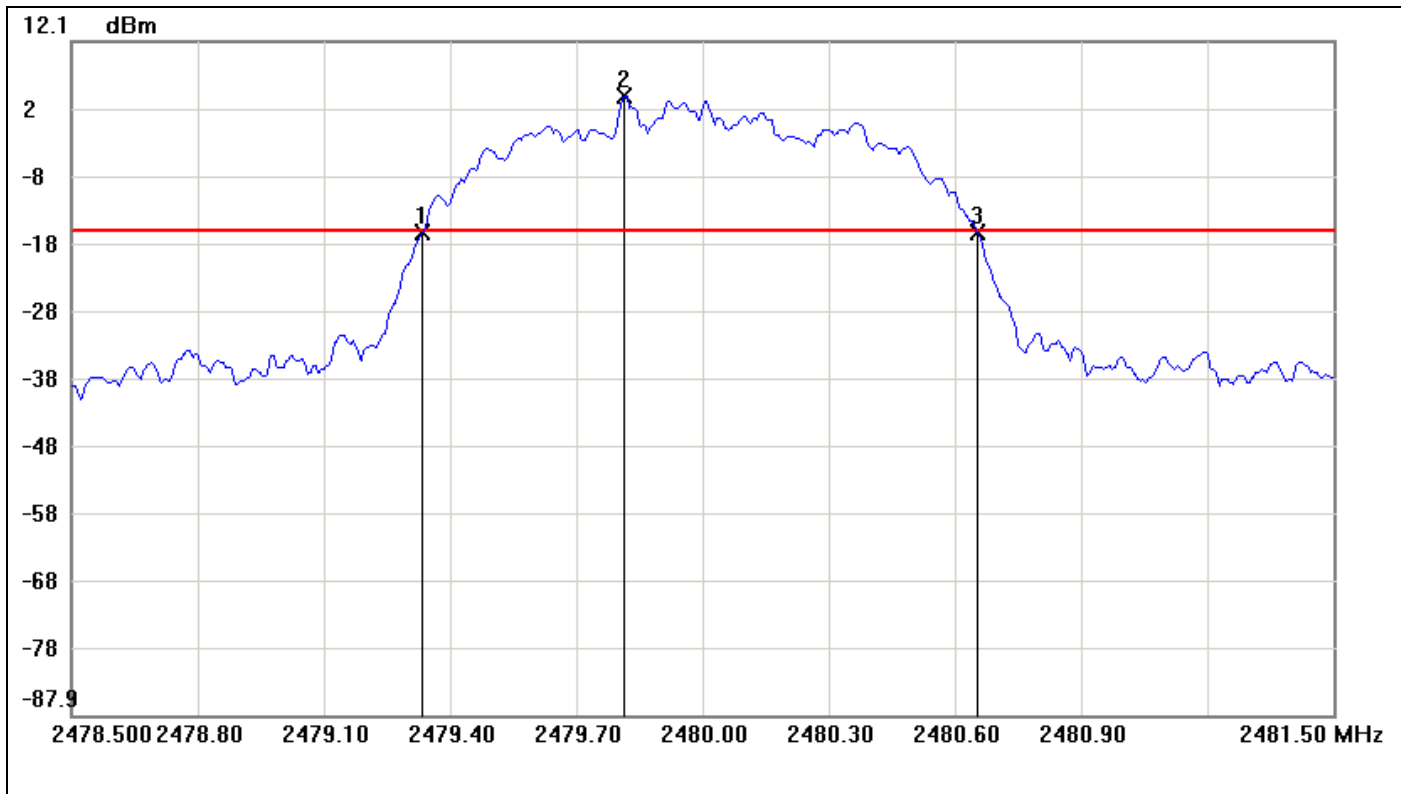

| No. | Frequency(MHz) | Result(dBm) | Limit(dBm) | Margin(dBm) |
|-----|----------------|-------------|------------|-------------|
| 1 | 2479.3350 | -16.26 | -15.97 | -0.29 |
| 2 | 2479.8150 | 4.03 | -15.97 | 20.00 |
| 3 | 2480.6550 | -16.21 | -15.97 | -0.24 |

| No. | | Δ Frequency(MHz) | Δ Level(dB) |
|-----|---------|-------------------------|--------------------|
| 1 | mk3-mk1 | 1.32 | 0.05 |



7.2 PEAK POWER

LIMIT

The maximum peak output power of the intentional radiator shall not exceed the following:

1. According to §15.247(a)(1), Frequency hopping systems shall have hopping channel carrier frequencies separated by a minimum of 25 kHz or the 20 dB bandwidth of the hopping channel, whichever is greater. Alternatively, frequency hopping systems operating in the 2400-2483.5 MHz band may have hopping channel carrier frequencies that are separated by 25 kHz or two-thirds of the 20 dB bandwidth of the hopping channel, whichever is greater, provided the systems operate with an output power no greater than 125 mW.
2. According to §15.247(b)(3), for systems using digital modulation in the bands of 902-928 MHz, 2400-2483.5 MHz, and 5725-5850 MHz: 1 Watt.

Test Configuration

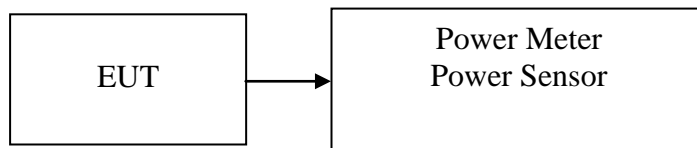

TEST PROCEDURE

The transmitter output is connected to the Power Meter. The Power Meter is set to the peak power detection.

TEST RESULTS

No non-compliance noted.

Test Data

For GFSK / DH5

| Channel | Frequency (MHz) | Output Power (dBm) | Output Power (W) | Limit (W) | Result |
|---------|-----------------|--------------------|------------------|-----------|--------|
| Low | 2402 | 8.01 | 0.0063 | 0.125 | PASS |
| Mid | 2441 | 8.13 | 0.0065 | | PASS |
| High | 2480 | 8.12 | 0.0065 | | PASS |

For 8DPSK / DH5

| Channel | Frequency (MHz) | Output Power (dBm) | Output Power (W) | Limit (W) | Result |
|---------|-----------------|--------------------|------------------|-----------|--------|
| Low | 2402 | 9.57 | 0.0091 | 0.125 | PASS |
| Mid | 2441 | 9.88 | 0.0097 | | PASS |
| High | 2480 | 9.82 | 0.0096 | | PASS |



7.3 AVERAGE POWER

LIMIT

None; for reporting purposes only.

Test Configuration

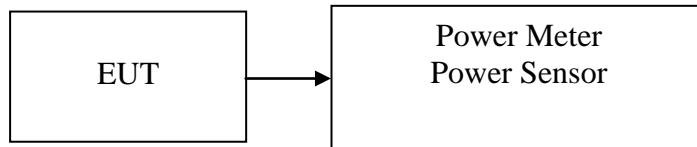

TEST PROCEDURE

The transmitter output is connected to the Power Meter. The Power Meter is set to the average power detection.

TEST RESULTS

No non-compliance noted.

Test Data

For GFSK / DH5

| Channel | Frequency (MHz) | Output Power (dBm) | Output Power (W) |
|---------|-----------------|--------------------|------------------|
| Low | 2402 | 6.59 | 0.0046 |
| Mid | 2441 | 6.73 | 0.0047 |
| High | 2480 | 6.67 | 0.0046 |

For 8DPSK / DH5

| Channel | Frequency (MHz) | Output Power (dBm) | Output Power (W) |
|---------|-----------------|--------------------|------------------|
| Low | 2402 | 5.74 | 0.0037 |
| Mid | 2441 | 5.99 | 0.0040 |
| High | 2480 | 5.92 | 0.0039 |



7.4 BAND EDGES MEASUREMENT

LIMIT

According to §15.247(d), in any 100 kHz bandwidth outside the frequency band in which the spread spectrum or digitally modulated intentional radiator is operating, the radio frequency power that is produced by the intentional radiator shall be at least 20 dB below that in the 100 kHz bandwidth within the band that contains the highest level of the desired power, based on either an RF conducted or a radiated measurement, provided the transmitter demonstrates compliance with the peak conducted power limits. If the transmitter complies with the conducted power limits based on the use of RMS averaging over a time interval, as permitted under paragraph (b)(3) of this section, the attenuation required under this paragraph shall be 30 dB instead of 20 dB. Attenuation below the general limits specified in §15.209(a) is not required. In addition, radiated emissions which fall in the restricted bands, as defined in §15.205(a), must also comply with the radiated emission limits specified in §15.209(a) (see §15.205(c)).

Test Configuration

For Radiated

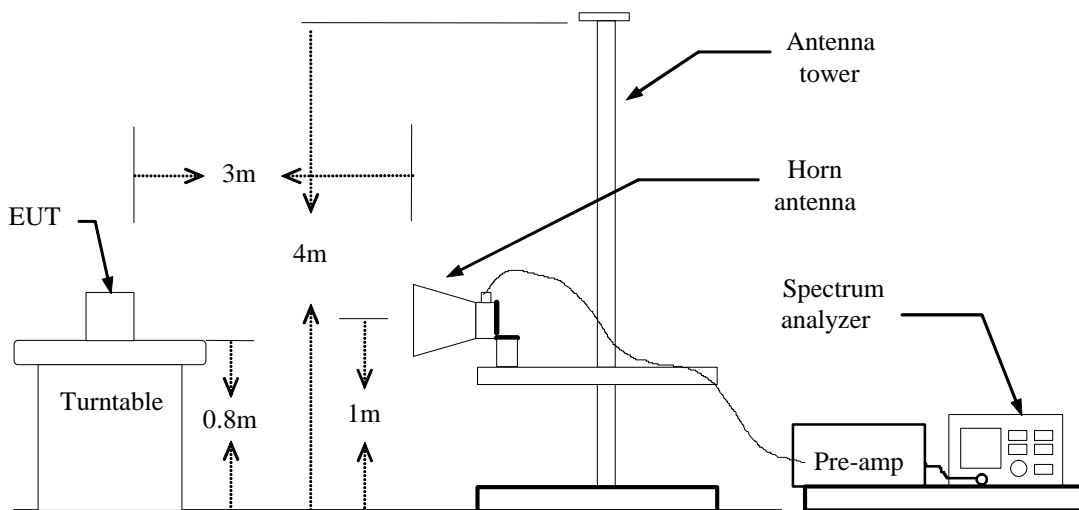

For Conducted

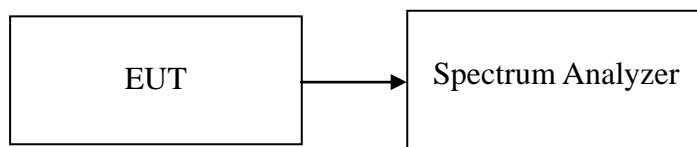



TEST PROCEDURE

For Radiated

1. The EUT is placed on a turntable, which is 0.8m above the ground plane.
2. The turntable shall be rotated for 360 degrees to determine the position of maximum emission level.
3. EUT is set 3m away from the receiving antenna, which is varied from 1m to 4m to find out the highest emission.
4. Set the spectrum analyzer in the following setting in order to capture the lower and upper band-edges of the emission:
 - (a) PEAK: RBW=1MHz / VBW=3MHz / Sweep=AUTO
 - (b) AVERAGE: RBW=1MHz / VBW=300Hz / Sweep=AUTO
 - (c) if duty cycle $\geq 98\%$, VBW=10Hz.
if duty cycle $< 98\%$ VBW=1/T.
BT<98%, VBW= 360Hz
EDR<98%, VBW=360Hz
5. Repeat the procedures until all the PEAK and AVERAGE versus POLARIZATION are measured.

For Conducted

Conducted RF measurements of the transmitter output were made to confirm that the EUT antenna port conducted emissions meet the specified limit and to identify any spurious signals that require further investigation or measurements on the radiated emissions site.

The transmitter output is connected to the spectrum analyzer. The resolution bandwidth is set to 300 kHz. The video bandwidth is set to 300 kHz.

TEST RESULTS

Refer to attach spectrum analyzer data chart.



For GFSK / DH5

Band Edges (CH Low)

Polarity: Vertical

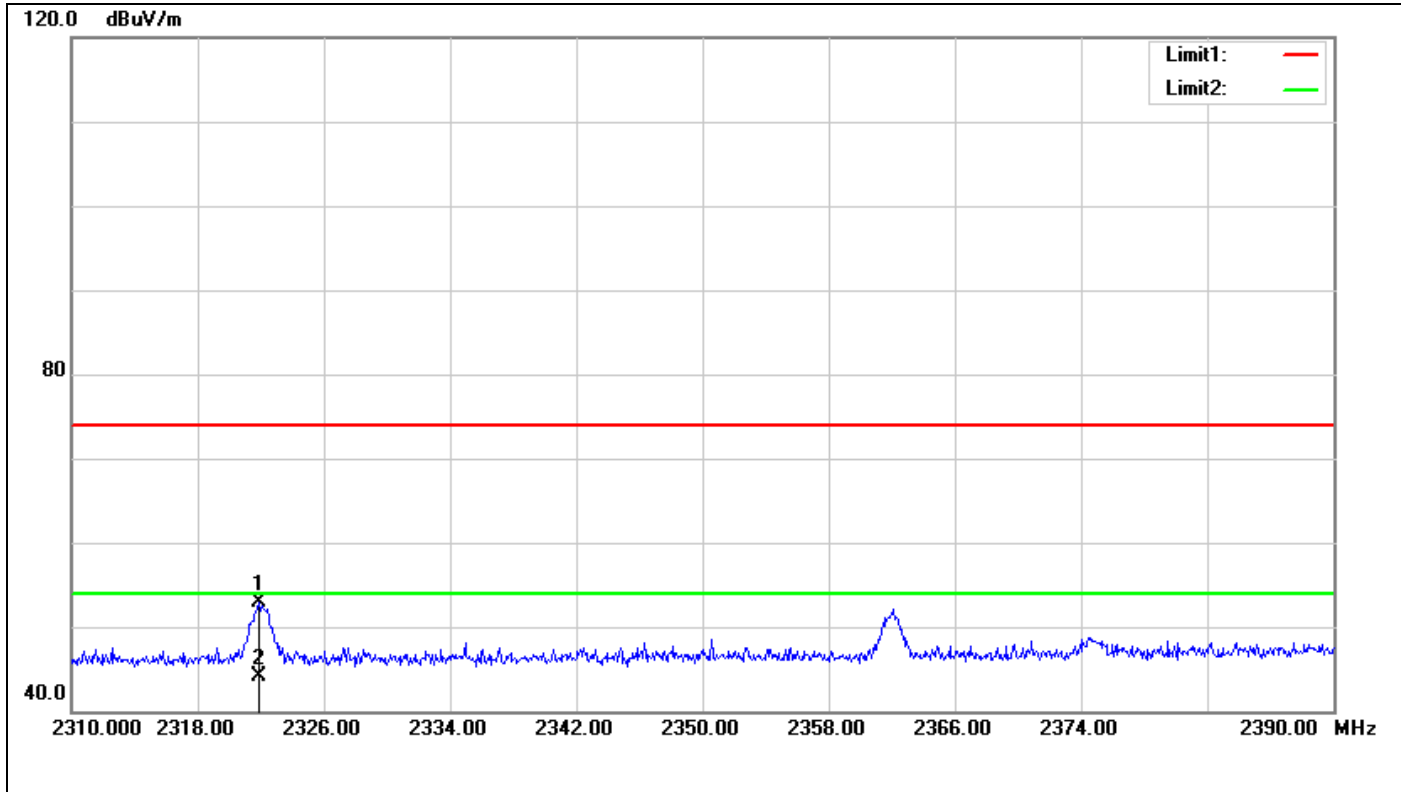

| No. | Frequency (MHz) | Reading (dBuV) | Correct Factor(dB/m) | Result (dBuV/m) | Limit (dBuV/m) | Margin (dB) | Height (cm) | Degree (°) | Remark |
|-----|--------------------|-------------------|-------------------------|--------------------|-------------------|----------------|----------------|---------------|--------|
| 1 | 2321.840 | 57.10 | -4.24 | 52.86 | 74.00 | -21.14 | 100 | 26 | peak |
| 2 | 2321.840 | 48.35 | -4.24 | 44.11 | 54.00 | -9.89 | 100 | 26 | AVG |



Polarity: Horizontal

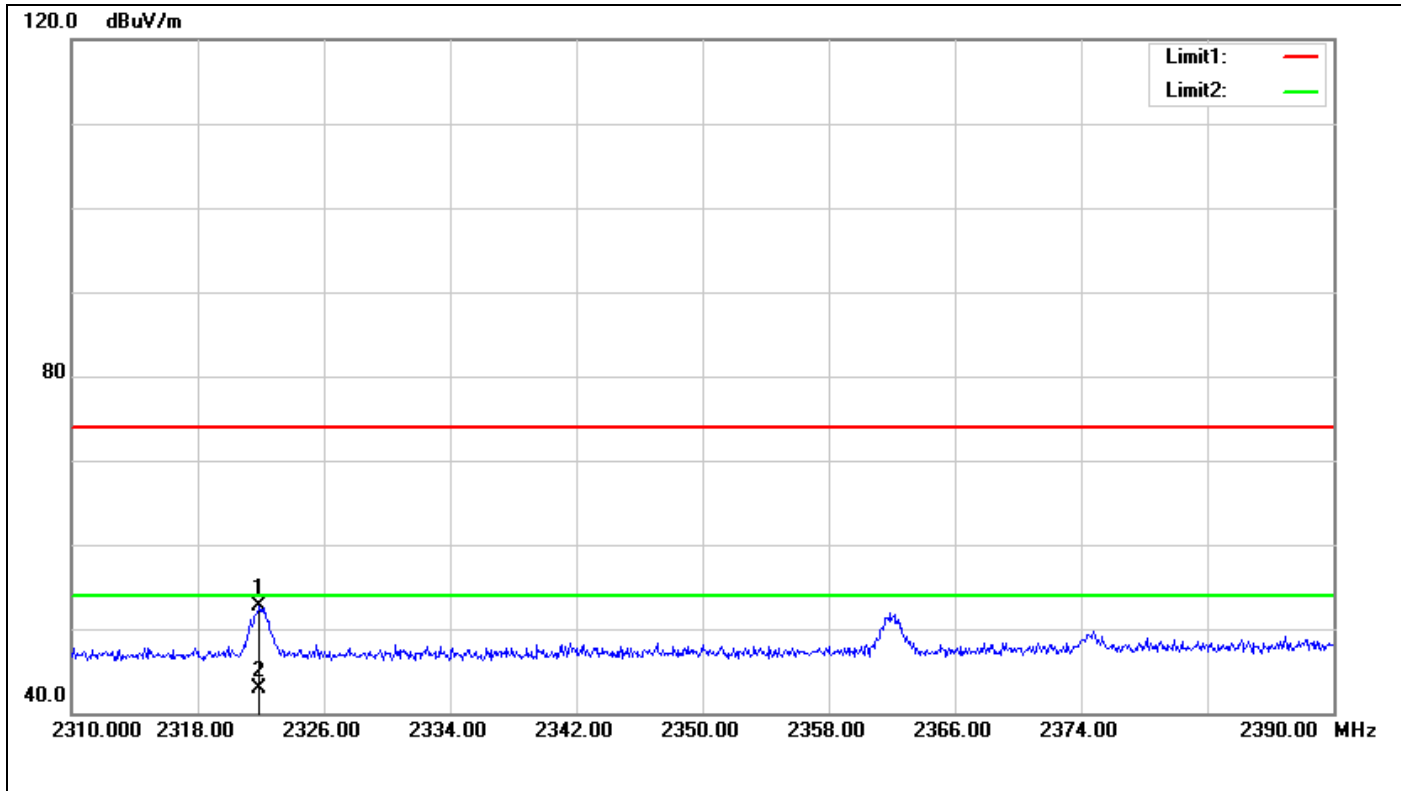

| No. | Frequency (MHz) | Reading (dBuV) | Correct Factor(dB/m) | Result (dBuV/m) | Limit (dBuV/m) | Margin (dB) | Height (cm) | Degree (°) | Remark |
|-----|--------------------|-------------------|-------------------------|--------------------|-------------------|----------------|----------------|---------------|--------|
| 1 | 2321.920 | 56.90 | -4.24 | 52.66 | 74.00 | -21.34 | 100 | 5 | peak |
| 2 | 2321.920 | 47.08 | -4.24 | 42.84 | 54.00 | -11.16 | 100 | 5 | AVG |



Band Edges (CH High)

Polarity: Vertical

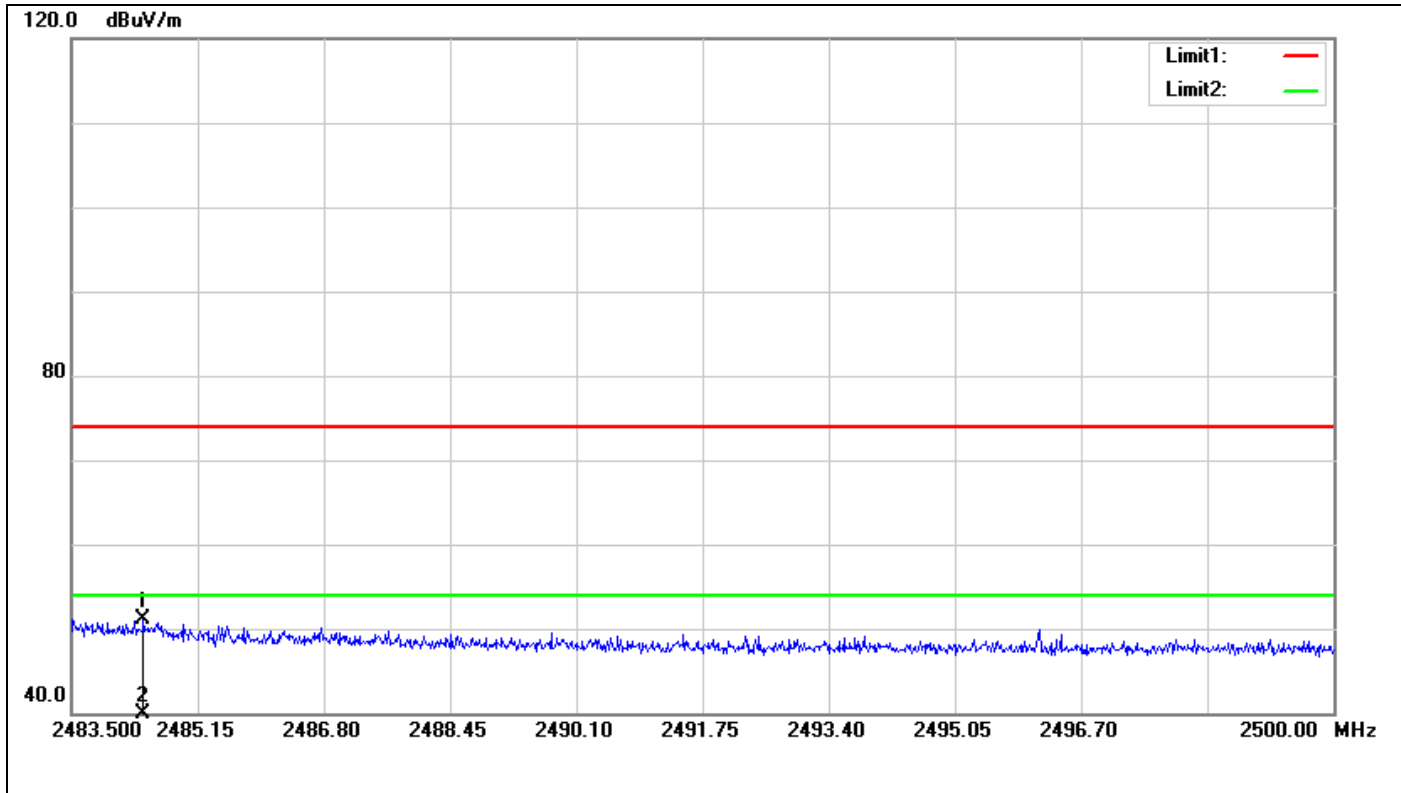

| No. | Frequency (MHz) | Reading (dBuV) | Correct Factor(dB/m) | Result (dBuV/m) | Limit (dBuV/m) | Margin (dB) | Height (cm) | Degree (°) | Remark |
|-----|--------------------|-------------------|-------------------------|--------------------|-------------------|----------------|----------------|-----------------|--------|
| 1 | 2484.441 | 54.34 | -3.27 | 51.07 | 74.00 | -22.93 | 100 | 359 | peak |
| 2 | 2484.441 | 40.77 | -3.27 | 37.50 | 54.00 | -16.50 | 100 | 359 | AVG |



Polarity: Horizontal

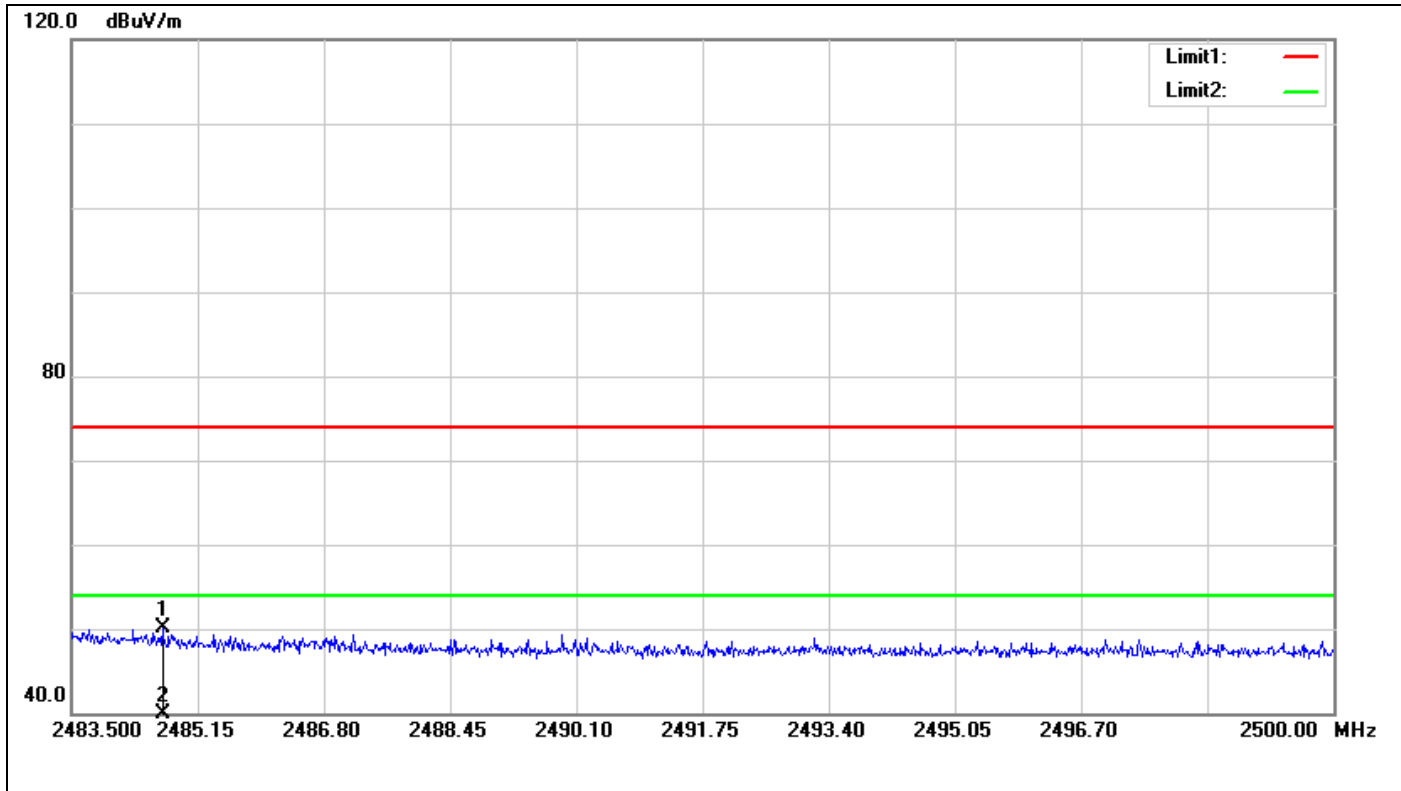

| No. | Frequency (MHz) | Reading (dBuV) | Correct Factor(dB/m) | Result (dBuV/m) | Limit (dBuV/m) | Margin (dB) | Height (cm) | Degree (°) | Remark |
|-----|--------------------|-------------------|-------------------------|--------------------|-------------------|----------------|----------------|---------------|--------|
| 1 | 2484.688 | 53.33 | -3.26 | 50.07 | 74.00 | -23.93 | 100 | 33 | peak |
| 2 | 2484.688 | 39.98 | -3.26 | 36.72 | 54.00 | -17.28 | 100 | 33 | AVG |



For 8DPSK / DH5

Band Edges (CH Low)

Polarity: Vertical

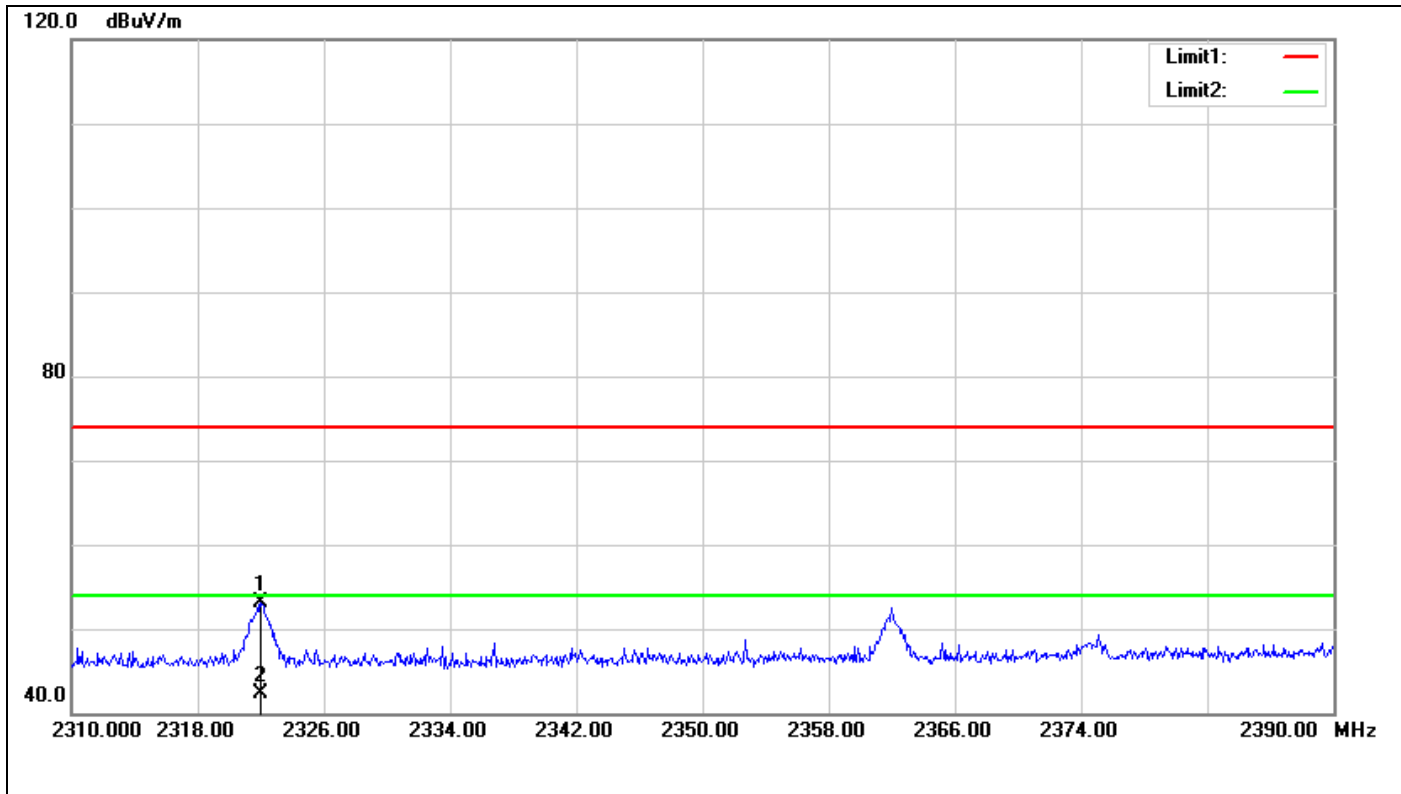

| No. | Frequency (MHz) | Reading (dBuV) | Correct Factor(dB/m) | Result (dBuV/m) | Limit (dBuV/m) | Margin (dB) | Height (cm) | Degree (°) | Remark |
|-----|--------------------|-------------------|-------------------------|--------------------|-------------------|----------------|----------------|---------------|--------|
| 1 | 2322.000 | 57.36 | -4.24 | 53.12 | 74.00 | -20.88 | 100 | 97 | peak |
| 2 | 2322.000 | 46.59 | -4.24 | 42.35 | 54.00 | -11.65 | 100 | 97 | AVG |



Polarity: Horizontal

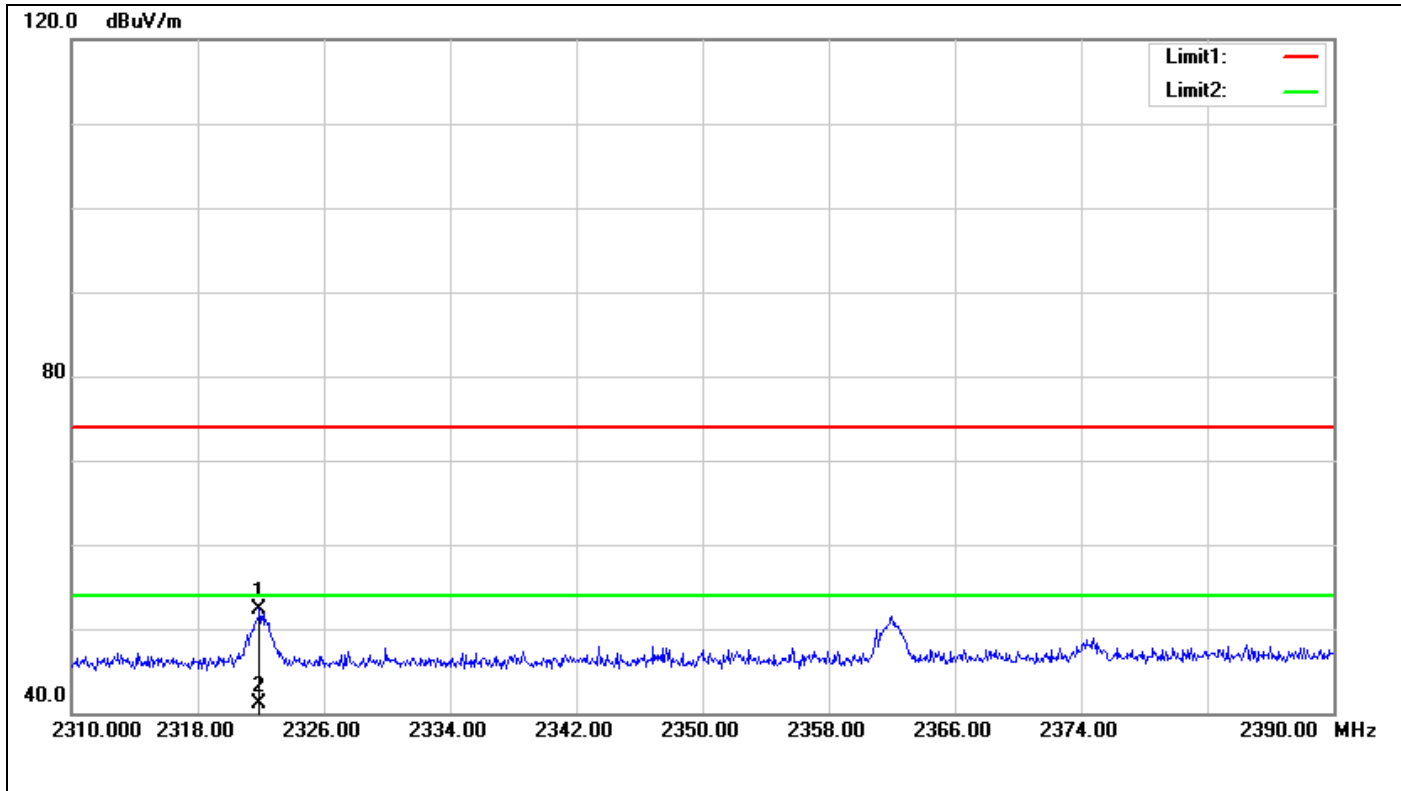

| No. | Frequency (MHz) | Reading (dBuV) | Correct Factor(dB/m) | Result (dBuV/m) | Limit (dBuV/m) | Margin (dB) | Height (cm) | Degree (°) | Remark |
|-----|--------------------|-------------------|-------------------------|--------------------|-------------------|----------------|----------------|---------------|--------|
| 1 | 2321.920 | 56.64 | -4.24 | 52.40 | 74.00 | -21.60 | 100 | 27 | peak |
| 2 | 2321.920 | 45.43 | -4.24 | 41.19 | 54.00 | -12.81 | 100 | 27 | AVG |



Band Edges (CH High)

Polarity: Vertical

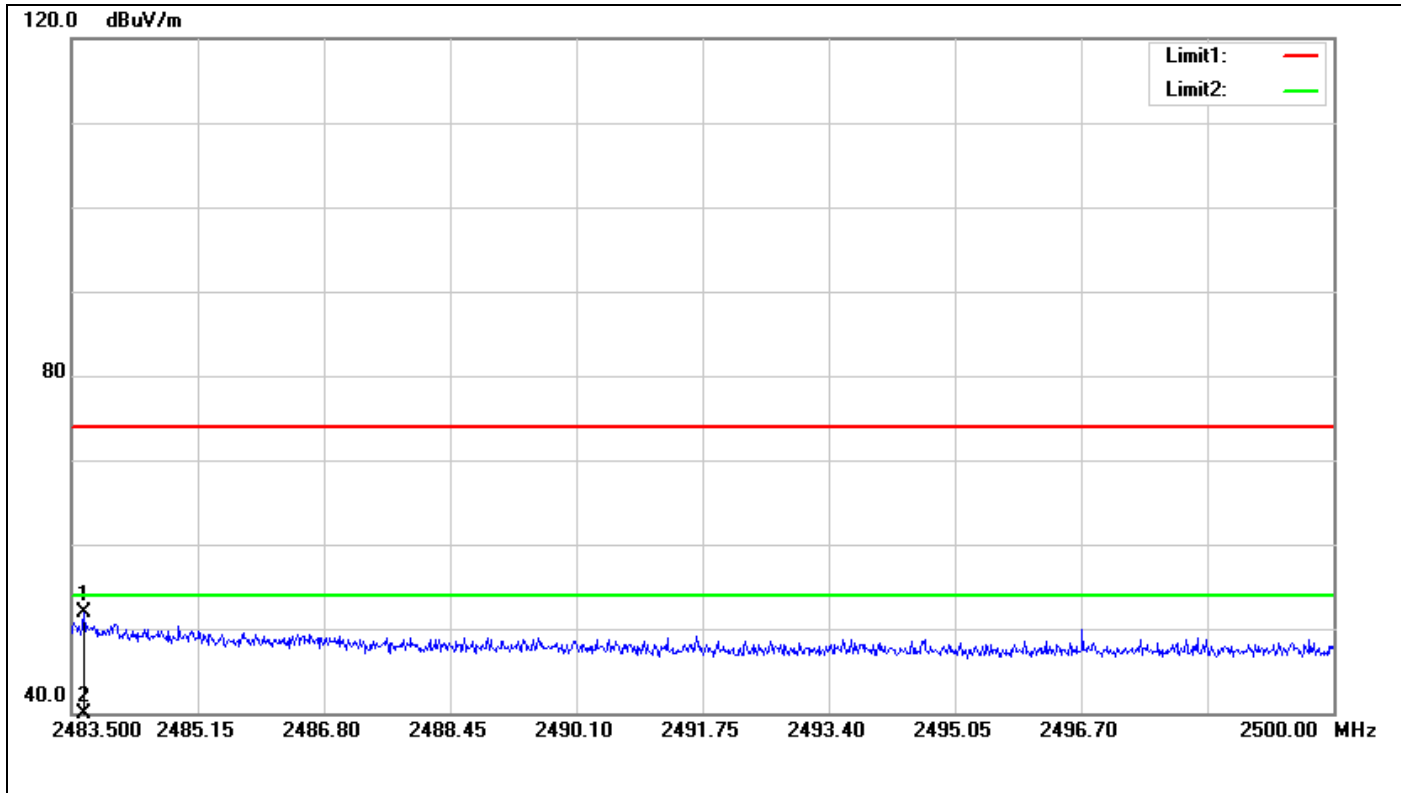

| No. | Frequency (MHz) | Reading (dBuV) | Correct Factor(dB/m) | Result (dBuV/m) | Limit (dBuV/m) | Margin (dB) | Height (cm) | Degree (°) | Remark |
|-----|--------------------|-------------------|-------------------------|--------------------|-------------------|----------------|----------------|-----------------|--------|
| 1 | 2483.665 | 55.22 | -3.27 | 51.95 | 74.00 | -22.05 | 100 | 60 | peak |
| 2 | 2483.665 | 40.63 | -3.27 | 37.36 | 54.00 | -16.64 | 100 | 30 | AVG |



Polarity: Horizontal

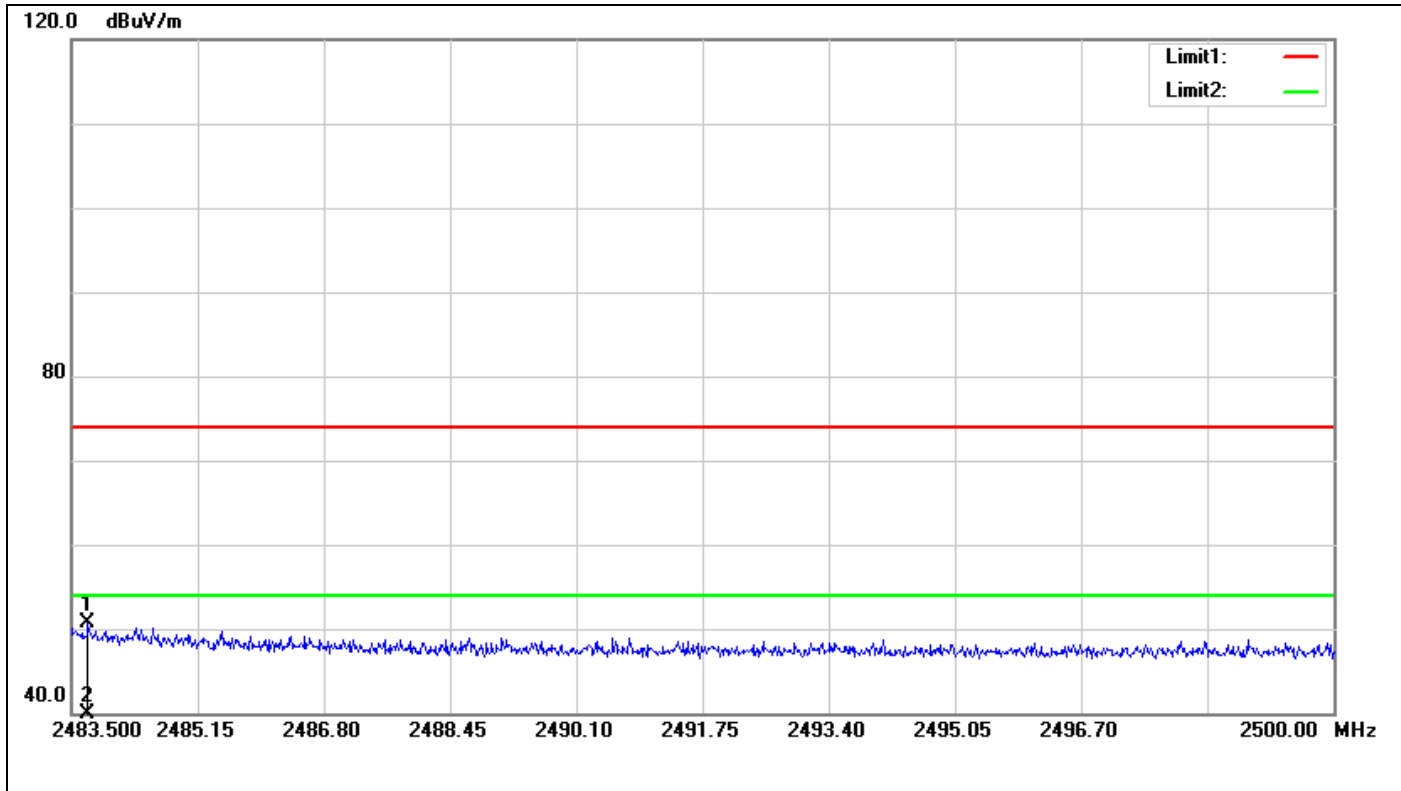

| No. | Frequency (MHz) | Reading (dBuV) | Correct Factor(dB/m) | Result (dBuV/m) | Limit (dBuV/m) | Margin (dB) | Height (cm) | Degree (°) | Remark |
|-----|--------------------|-------------------|-------------------------|--------------------|-------------------|----------------|----------------|---------------|--------|
| 1 | 2483.715 | 54.07 | -3.27 | 50.80 | 74.00 | -23.20 | 100 | 248 | peak |
| 2 | 2483.715 | 40.15 | -3.27 | 36.88 | 54.00 | -17.12 | 100 | 248 | AVG |



GFSK

Conducted Band Edges (CH Low)

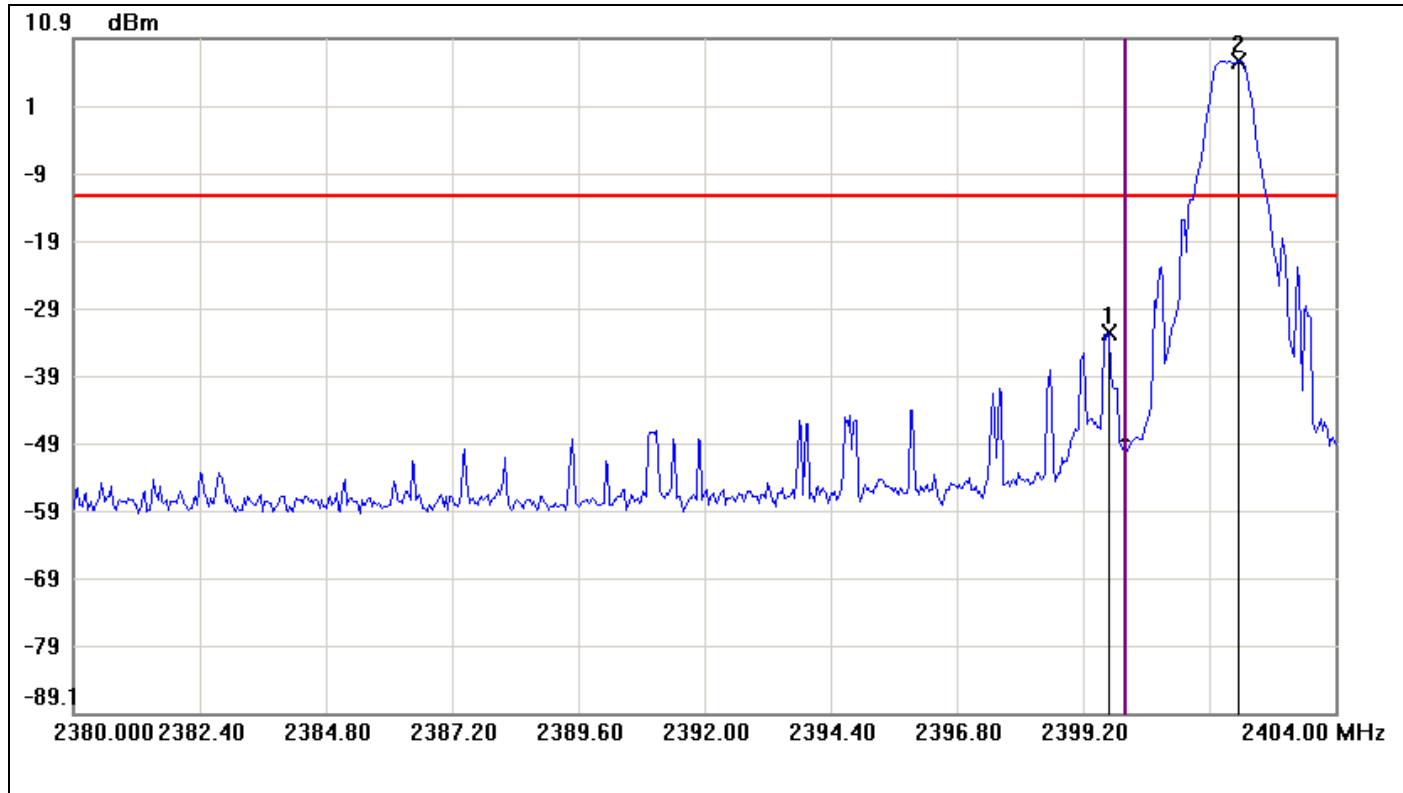

| No. | Frequency(MHz) | Result(dBm) | Limit(dBm) | Margin(dBm) |
|-----|----------------|-------------|------------|-------------|
| 1 | 2399.6800 | -32.75 | -12.41 | -20.34 |
| 2 | 2402.1600 | 7.59 | -12.41 | 20.00 |



Band Edges (CH High)

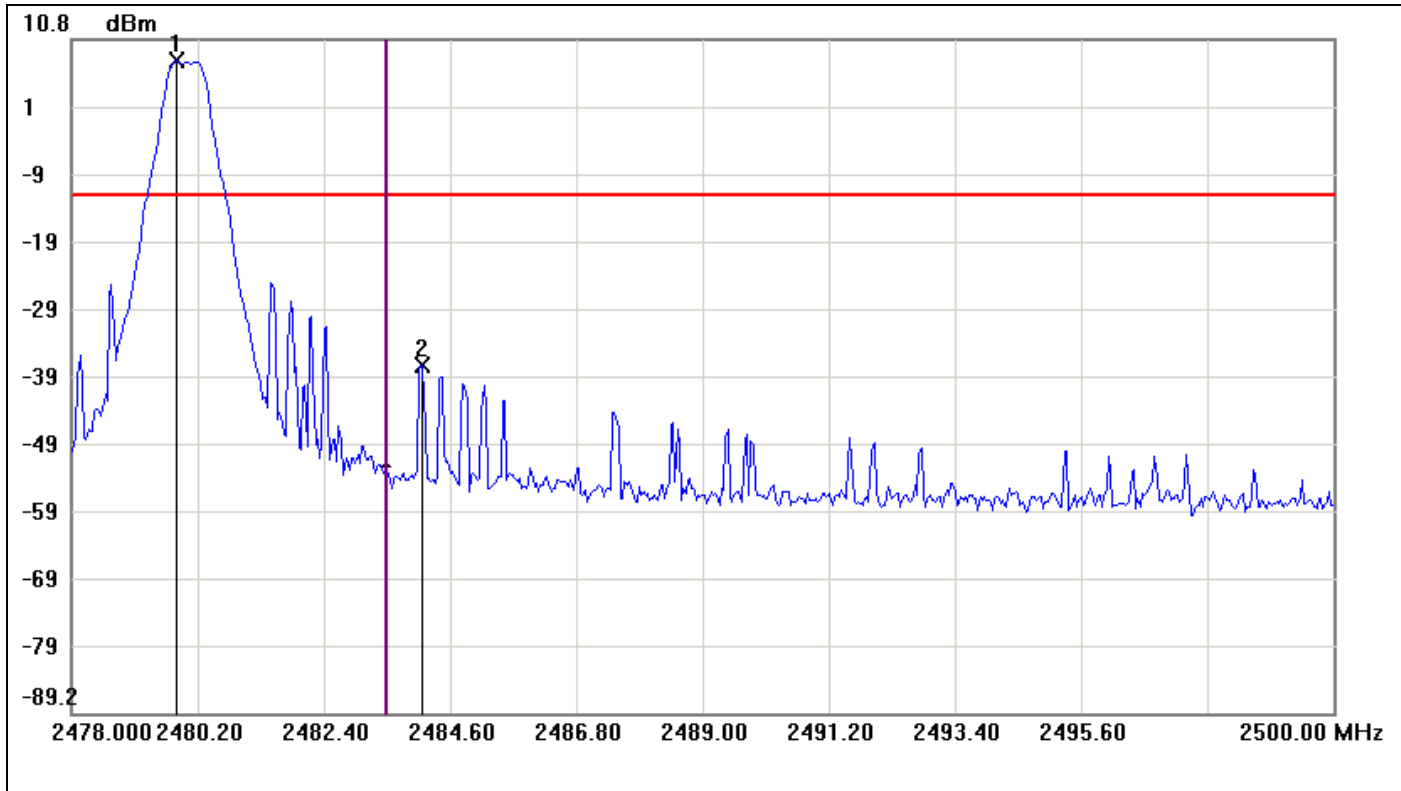

| No. | Frequency(MHz) | Result(dBm) | Limit(dBm) | Margin(dBm) |
|-----|----------------|-------------|------------|-------------|
| 1 | 2479.8333 | 7.60 | -12.40 | 20.00 |
| 2 | 2484.1233 | -37.59 | -12.40 | -25.19 |



Hopping Mode (CH Low)

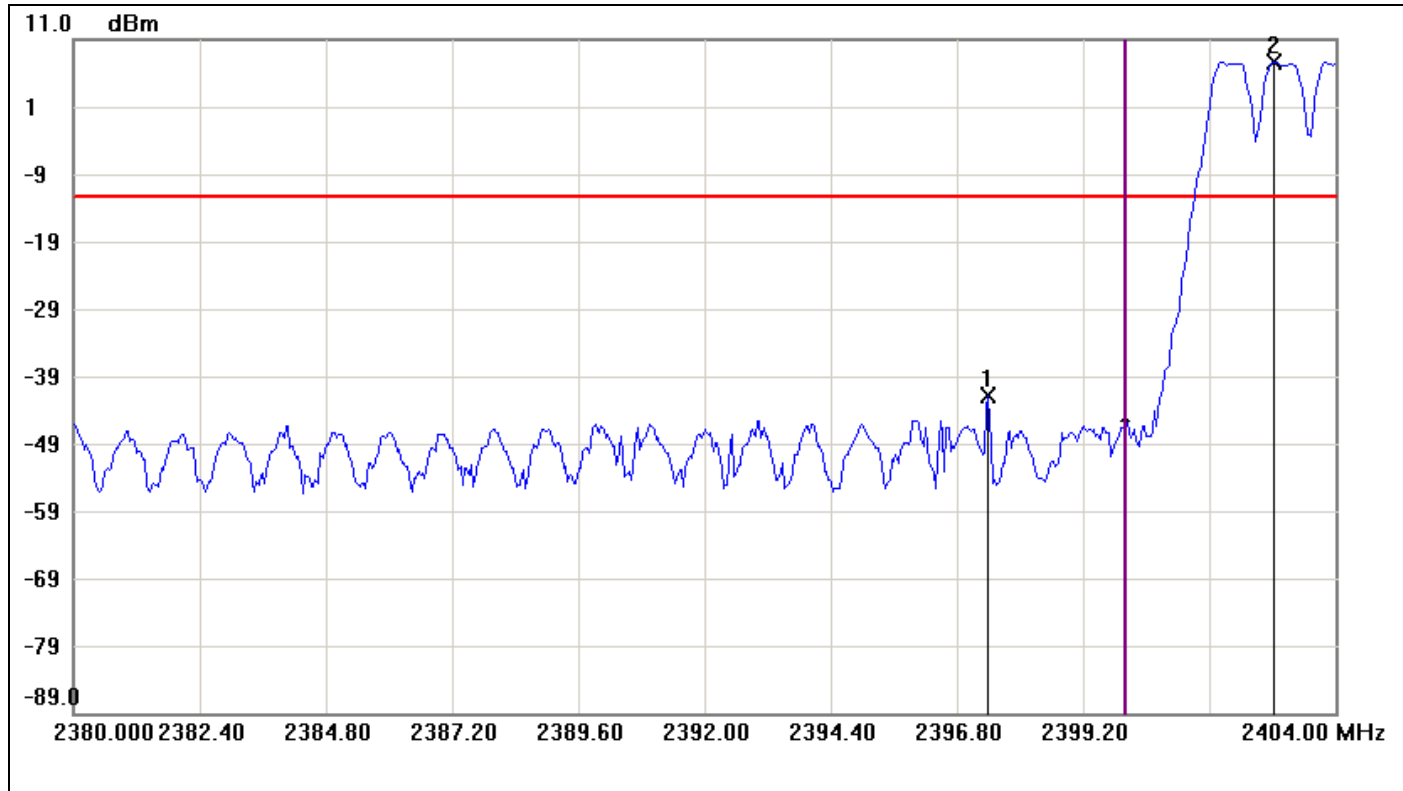

| No. | Frequency(MHz) | Result(dBm) | Limit(dBm) | Margin(dBm) |
|-----|----------------|-------------|------------|-------------|
| 1 | 2397.4000 | -41.94 | -12.33 | -29.61 |
| 2 | 2402.8400 | 7.67 | -12.33 | 20.00 |



Hopping Mode (CH High)

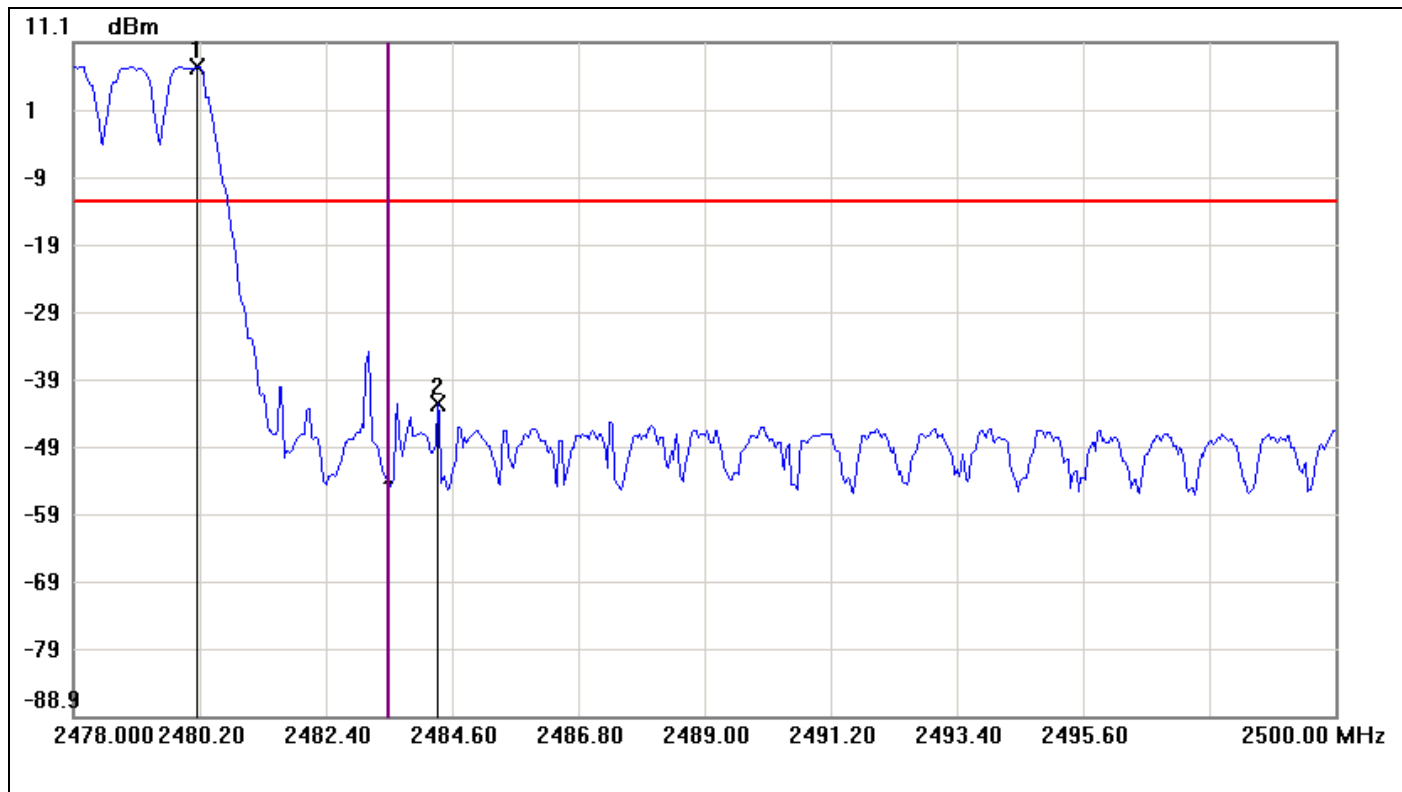

| No. | Frequency(MHz) | Result(dBm) | Limit(dBm) | Margin(dBm) |
|-----|----------------|-------------|------------|-------------|
| 1 | 2480.1633 | 7.59 | -12.41 | 20.00 |
| 2 | 2484.3433 | -42.55 | -12.41 | -30.14 |



8DPSK

Band Edges (CH Low)

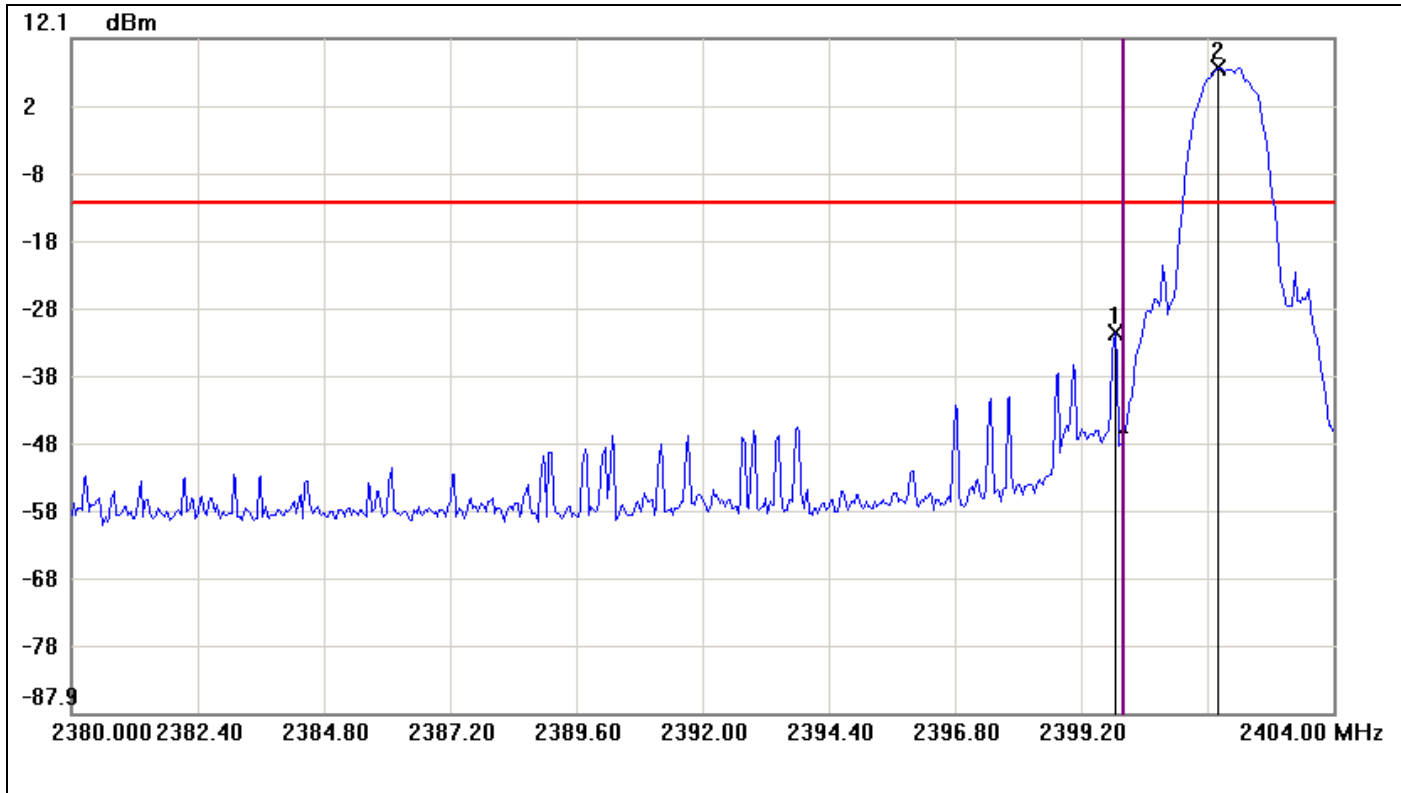

| No. | Frequency(MHz) | Result(dBm) | Limit(dBm) | Margin(dBm) |
|-----|----------------|-------------|------------|-------------|
| 1 | 2399.8400 | -31.56 | -12.19 | -19.37 |
| 2 | 2401.8000 | 7.81 | -12.19 | 20.00 |



Band Edges (CH High)

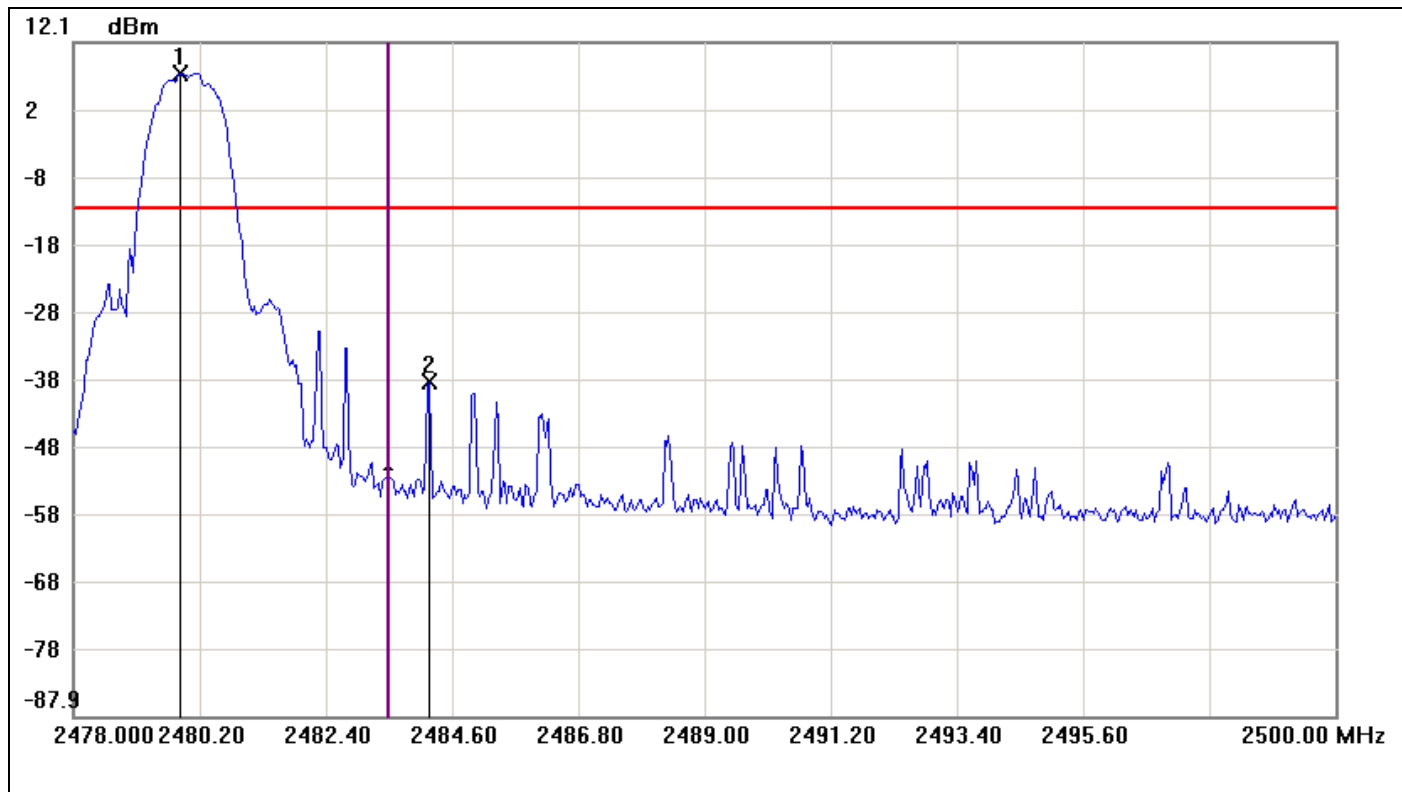

| No. | Frequency(MHz) | Result(dBm) | Limit(dBm) | Margin(dBm) |
|-----|----------------|-------------|------------|-------------|
| 1 | 2479.8700 | 7.58 | -12.42 | 20.00 |
| 2 | 2484.1967 | -38.19 | -12.42 | -25.77 |



Hopping Mode (CH Low)

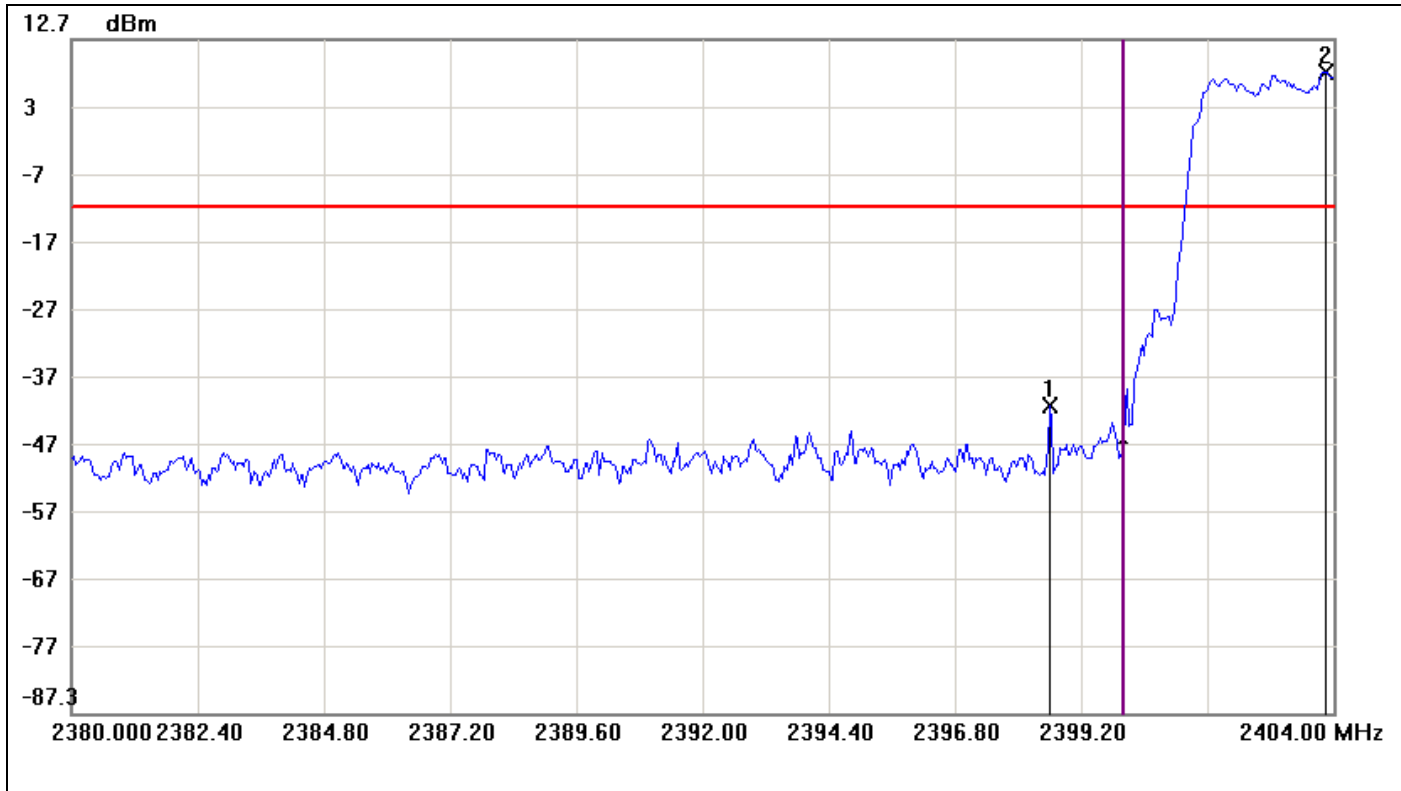

| No. | Frequency(MHz) | Result(dBm) | Limit(dBm) | Margin(dBm) |
|-----|----------------|-------------|------------|-------------|
| 1 | 2398.6000 | -41.72 | -12.21 | -29.51 |
| 2 | 2403.8400 | 7.79 | -12.21 | 20.00 |



Hopping Mode (CH High)

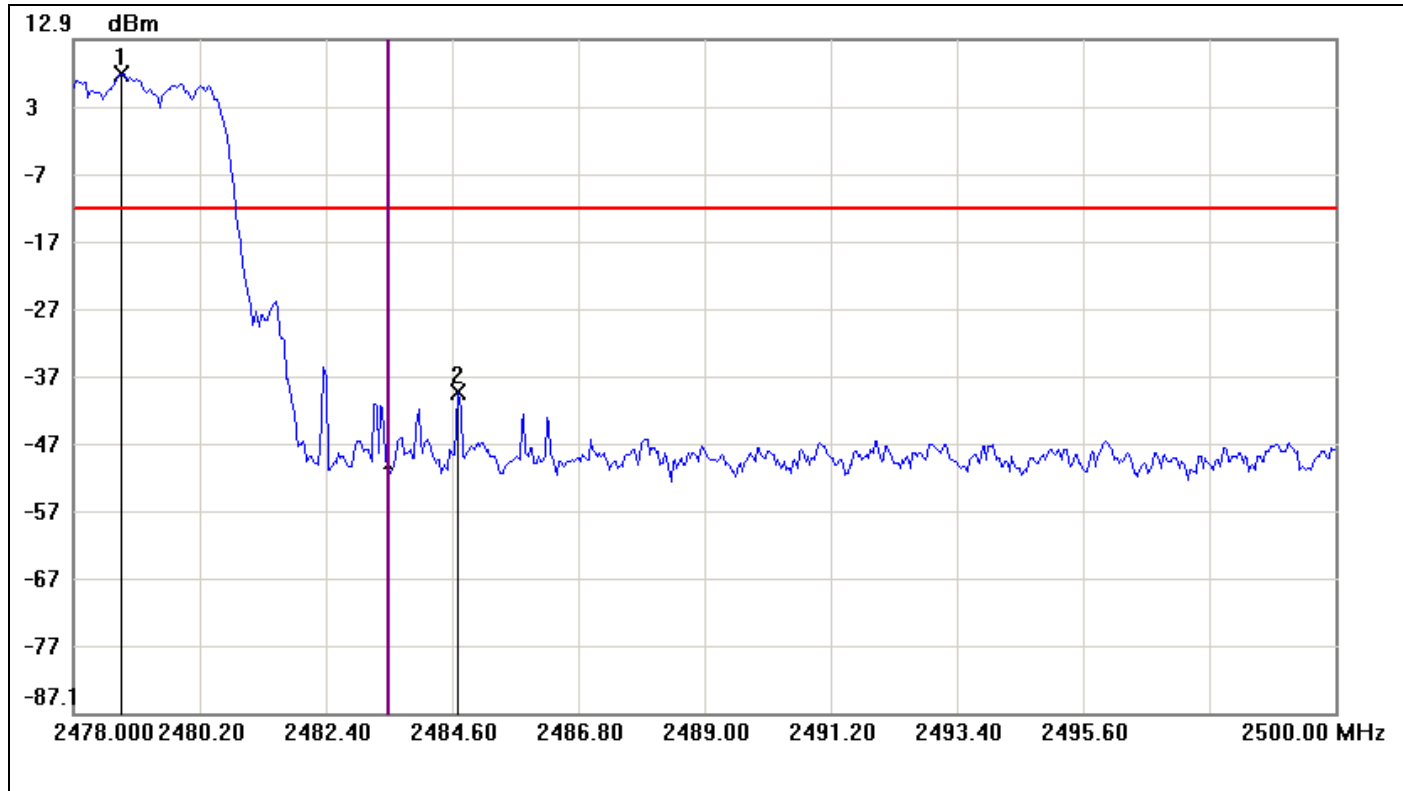

| No. | Frequency(MHz) | Result(dBm) | Limit(dBm) | Margin(dBm) |
|-----|----------------|-------------|------------|-------------|
| 1 | 2478.8433 | 7.76 | -12.24 | 20.00 |
| 2 | 2484.7100 | -39.51 | -12.24 | -27.27 |



7.5 FREQUENCY SEPARATION

LIMIT

According to §15.247(a)(1), Frequency hopping systems shall have hopping channel carrier frequencies separated by a minimum of 25 kHz or the 20 dB bandwidth of the hopping channel, whichever is greater. Alternatively, frequency hopping systems operating in the 2400-2483.5 MHz band may have hopping channel carrier frequencies that are separated by 25 kHz or two-thirds of the 20 dB bandwidth of the hopping channel, whichever is greater, provided the systems operate with an output power no greater than 125 mW.

Test Configuration

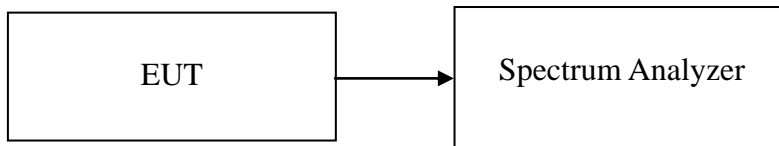

TEST PROCEDURE

1. Place the EUT on the table and set it in transmitting mode.
2. Remove the antenna from the EUT and then connect a low loss RF cable from the antenna port to the spectrum analyzer.
3. Set center frequency of spectrum analyzer = middle of hopping channel.
4. Set the spectrum analyzer as RBW = 30kHz, VBW = 100kHz, Sweep = 3.2 ms.
5. Max hold, mark 3 peaks of hopping channel and record the 3 peaks frequency.

TEST RESULTS

No non-compliance noted

Test Data

For GFSK / DH5

| Channel Separation (MHz) | two-thirds of the 20 dB bandwidth | Channel Separation Limit | Result |
|--------------------------|-----------------------------------|------------------------------------|--------|
| 1.19 | 0.7066 | >two-thirds of the 20 dB bandwidth | Pass |

For 8DPSK / DH5

| Channel Separation (MHz) | two-thirds of the 20 dB bandwidth | Channel Separation Limit | Result |
|--------------------------|-----------------------------------|------------------------------------|--------|
| 1.15 | 0.88 | >two-thirds of the 20 dB bandwidth | Pass |



Test Plot

For GFSK / DH5

Measurement of Channel Separation

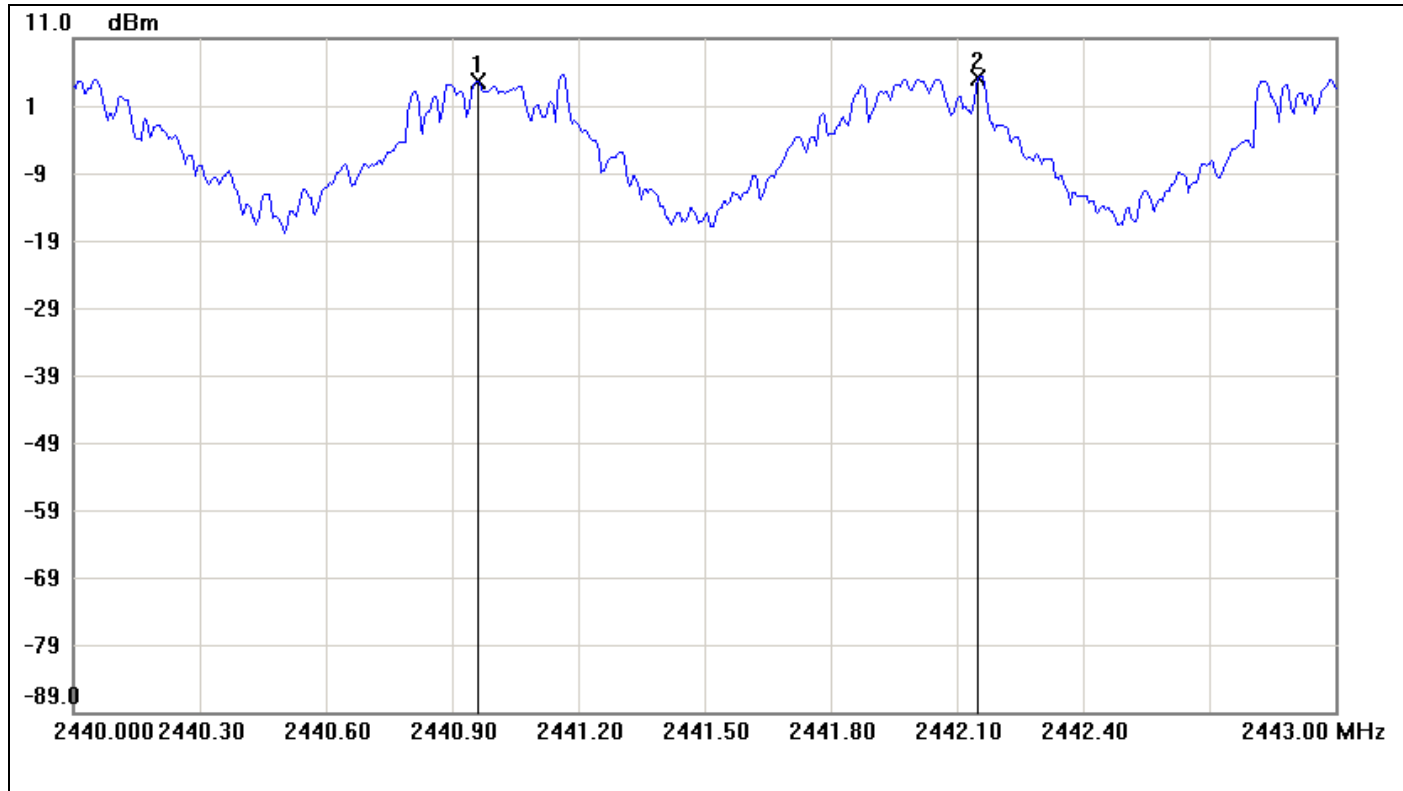

| No. | Frequency(MHz) | Result(dBm) | Limit(dBm) | Margin(dBm) |
|-----|----------------|-------------|------------|-------------|
| 1 | 2440.9600 | 4.51 | | |
| 2 | 2442.1500 | 5.21 | | |

| No. | | Δ Frequency(MHz) | Δ Level(dB) |
|-----|---------|-------------------------|--------------------|
| 1 | mk2-mk1 | 1.19 | 0.7 |



Measurement of 20dB Bandwidth

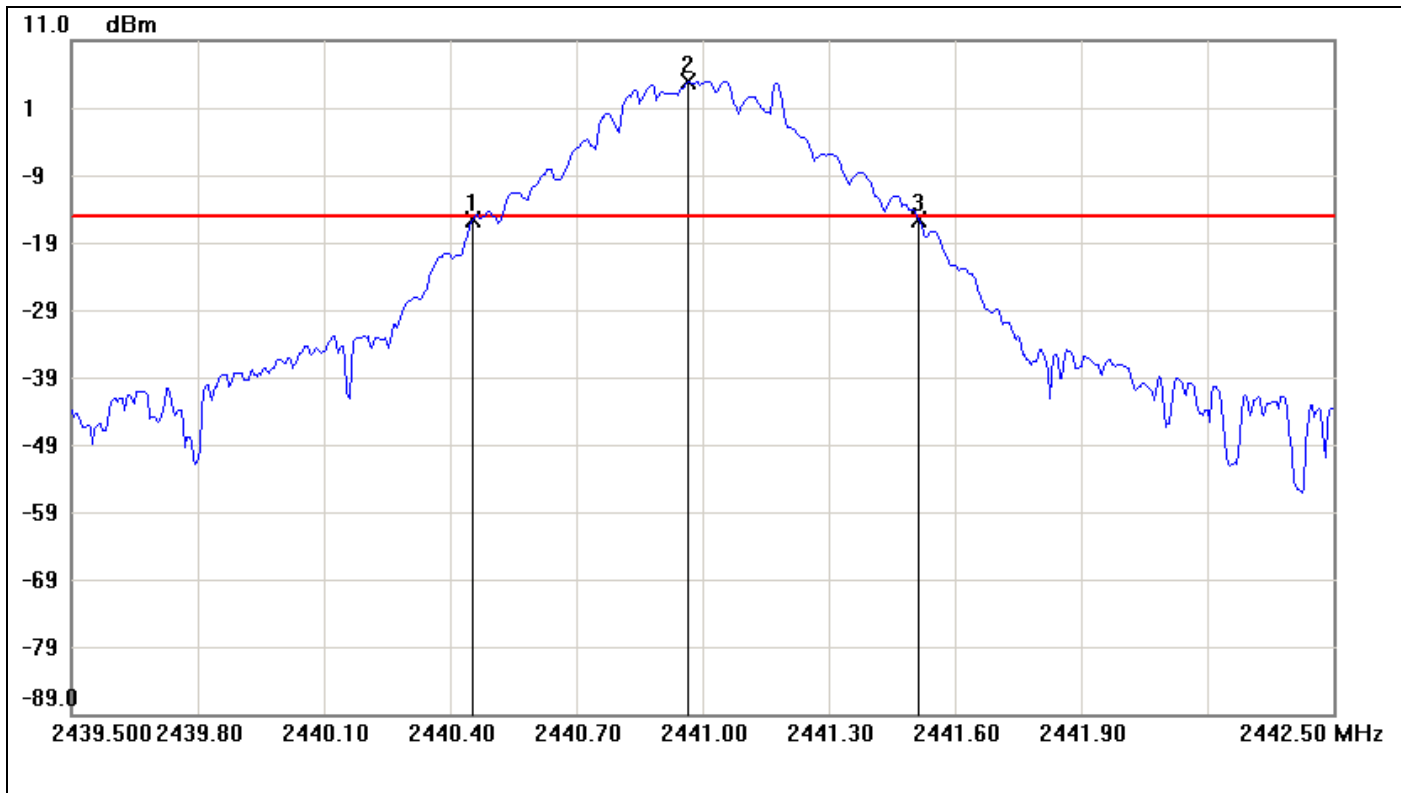

| No. | Frequency(MHz) | Result(dBm) | Limit(dBm) | Margin(dBm) |
|-----|----------------|-------------|------------|-------------|
| 1 | 2440.4550 | -15.68 | -15.10 | -0.58 |
| 2 | 2440.9650 | 4.90 | -15.10 | 20.00 |
| 3 | 2441.5150 | -15.61 | -15.10 | -0.51 |

| No. | | Δ Frequency(MHz) | Δ Level(dB) |
|-----|---------|-------------------------|--------------------|
| 1 | mk3-mk1 | 1.06 | 0.07 |



For 8DPSK / DH5

Measurement of Channel Separation

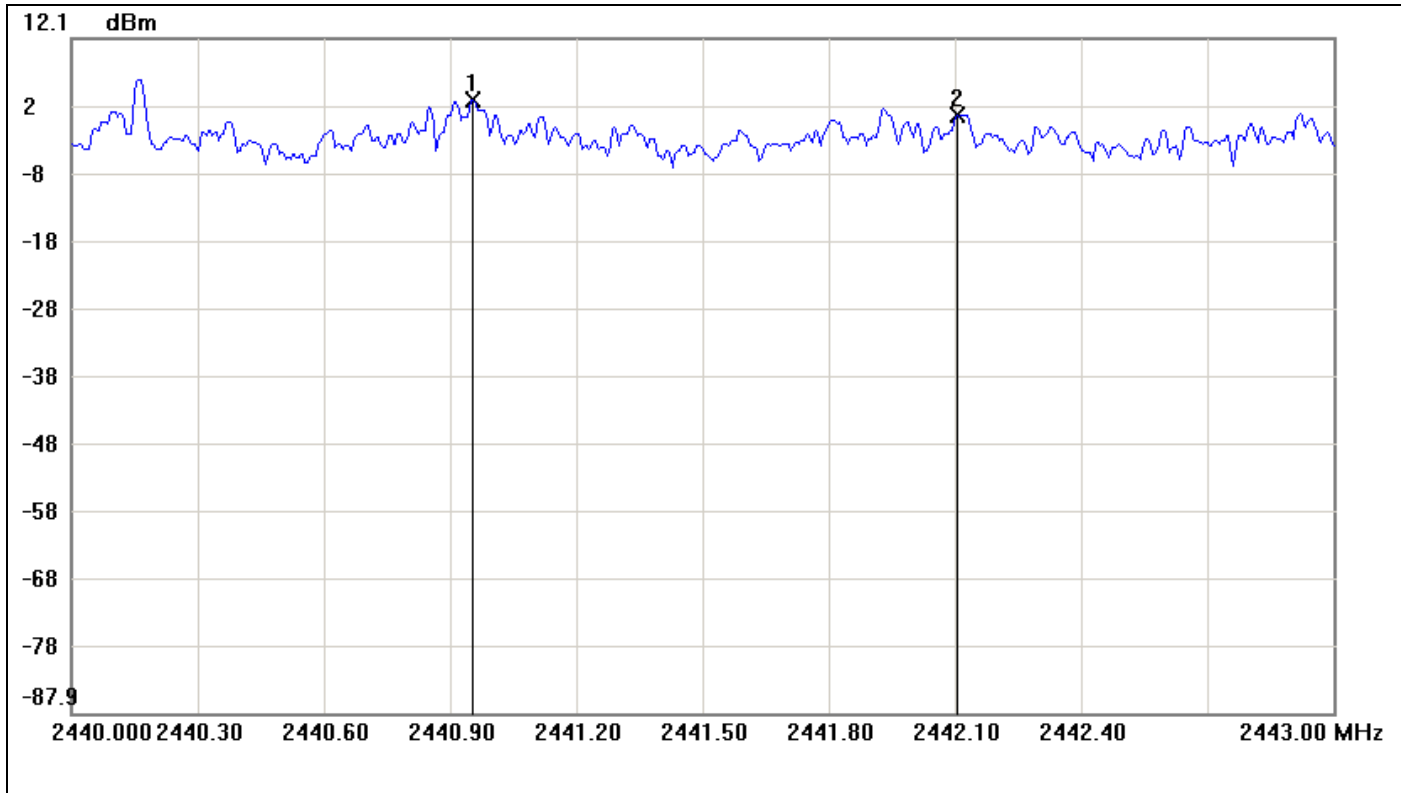

| No. | Frequency(MHz) | Result(dBm) | Limit(dBm) | Margin(dBm) |
|-----|----------------|-------------|------------|-------------|
| 1 | 2440.9550 | 3.02 | | |
| 2 | 2442.1050 | 0.84 | | |

| No. | | Δ Frequency(MHz) | Δ Level(dB) |
|-----|---------|-------------------------|--------------------|
| 1 | mk2-mk1 | 1.15 | -2.18 |



Measurement of 20dB Bandwidth

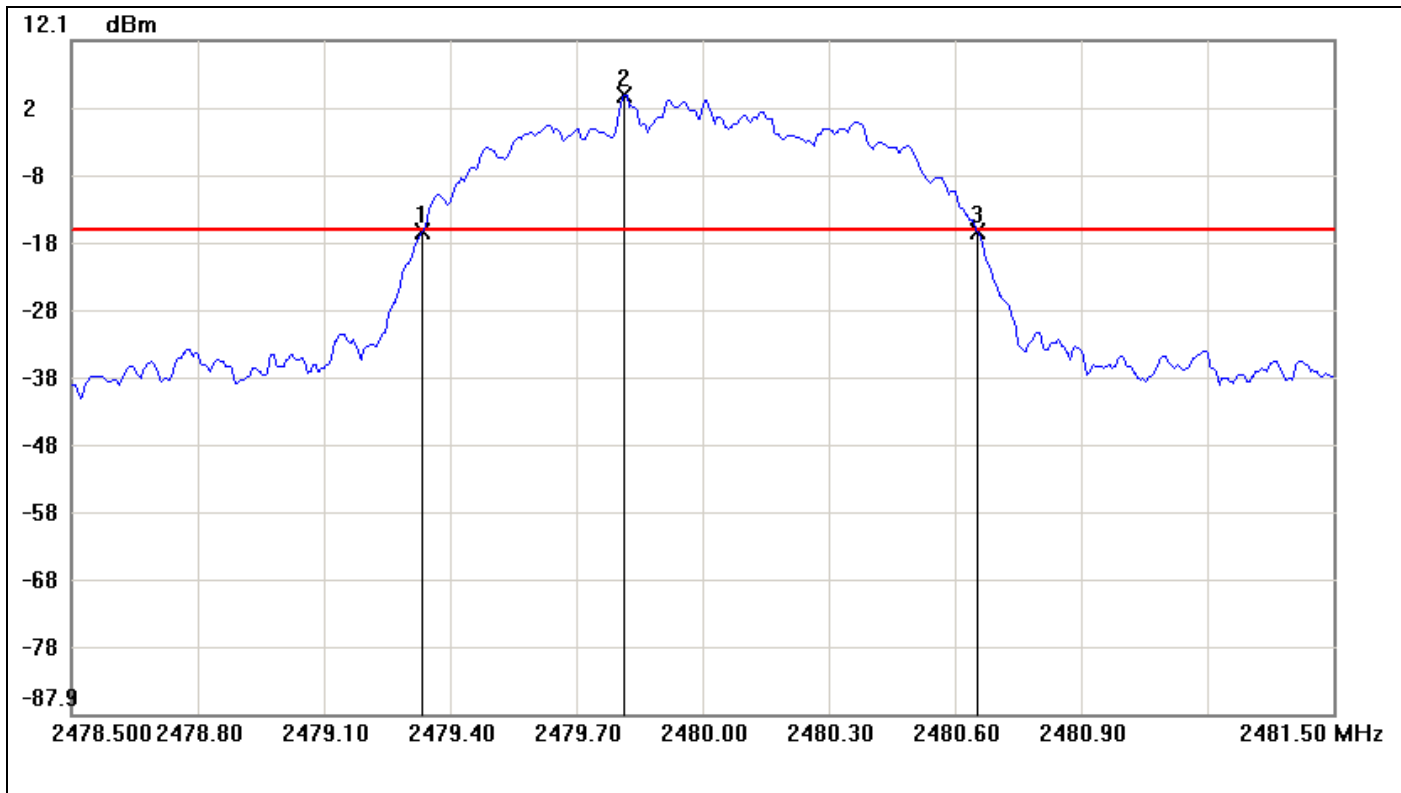

| No. | Frequency(MHz) | Result(dBm) | Limit(dBm) | Margin(dBm) |
|-----|----------------|-------------|------------|-------------|
| 1 | 2479.3350 | -16.26 | -15.97 | -0.29 |
| 2 | 2479.8150 | 4.03 | -15.97 | 20.00 |
| 3 | 2480.6550 | -16.21 | -15.97 | -0.24 |

| No. | | Δ Frequency(MHz) | Δ Level(dB) |
|-----|---------|-------------------------|--------------------|
| 1 | mk3-mk1 | 1.32 | 0.05 |



7.6 NUMBER OF HOPPING FREQUENCY

LIMIT

According to §15.247(a)(1)(ii), Frequency hopping systems operating in the 2400MHz-2483.5 MHz bands shall use at least 75 hopping frequencies.

According to §15.247(a)(1)(iii), Frequency hopping systems operating in the 2400MHz-2483.5 MHz bands shall use at least 15 hopping frequencies.

Test Configuration

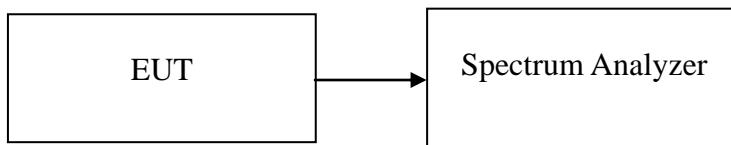

TEST PROCEDURE

1. Place the EUT on the table and set it in transmitting mode.
2. Remove the antenna from the EUT and then connect a low loss RF cable from the antenna port to the spectrum analyzer.
3. Set spectrum analyzer Start=2400MHz, Stop = 2430.5MHz, Sweep = auto
Start=2430.5MHz, Stop = 2460.5MHz, Sweep = auto and Start=2460.5MHz, Stop = 2485.5MHz, Sweep = auto.
4. Set the spectrum analyzer as RBW, VBW=510kHz.
5. Max hold, view and count how many channel in the band.

TEST RESULTS

No non-compliance noted

Test Data

| Result (No. of CH) | Limit (No. of CH) | Result |
|--------------------|-------------------|--------|
| 79 | >15 | PASS |



Test Plot

For GFSK

Channel Number

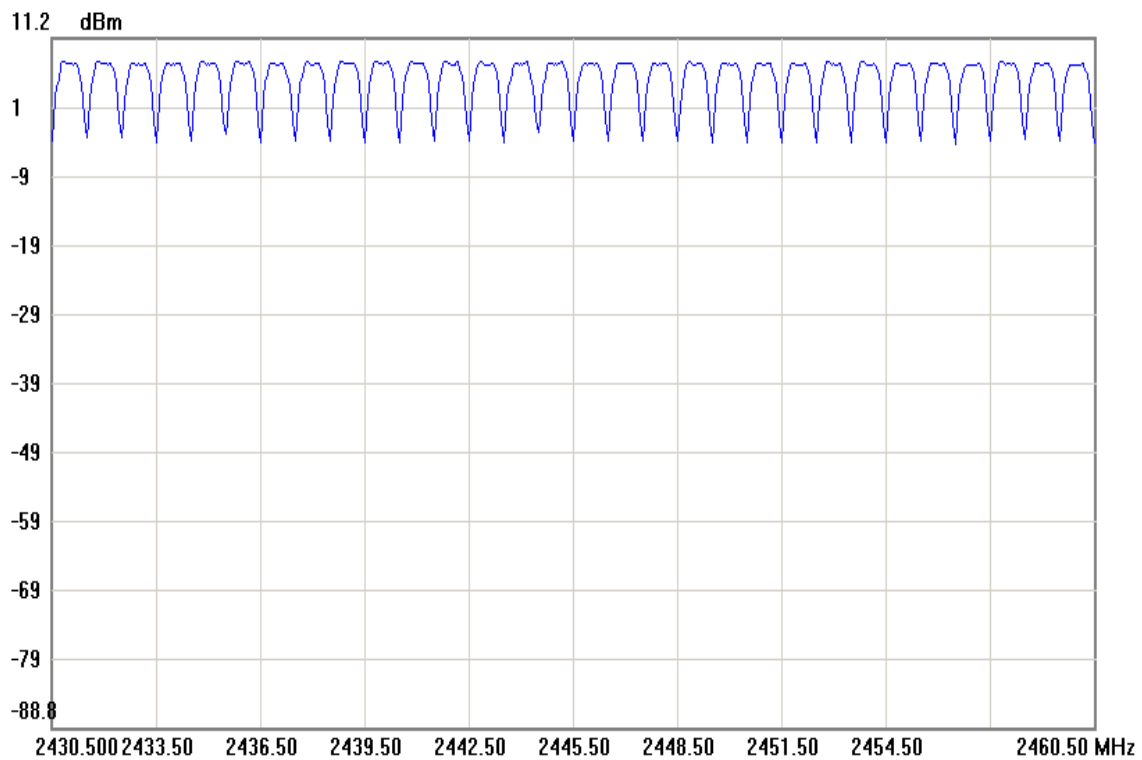
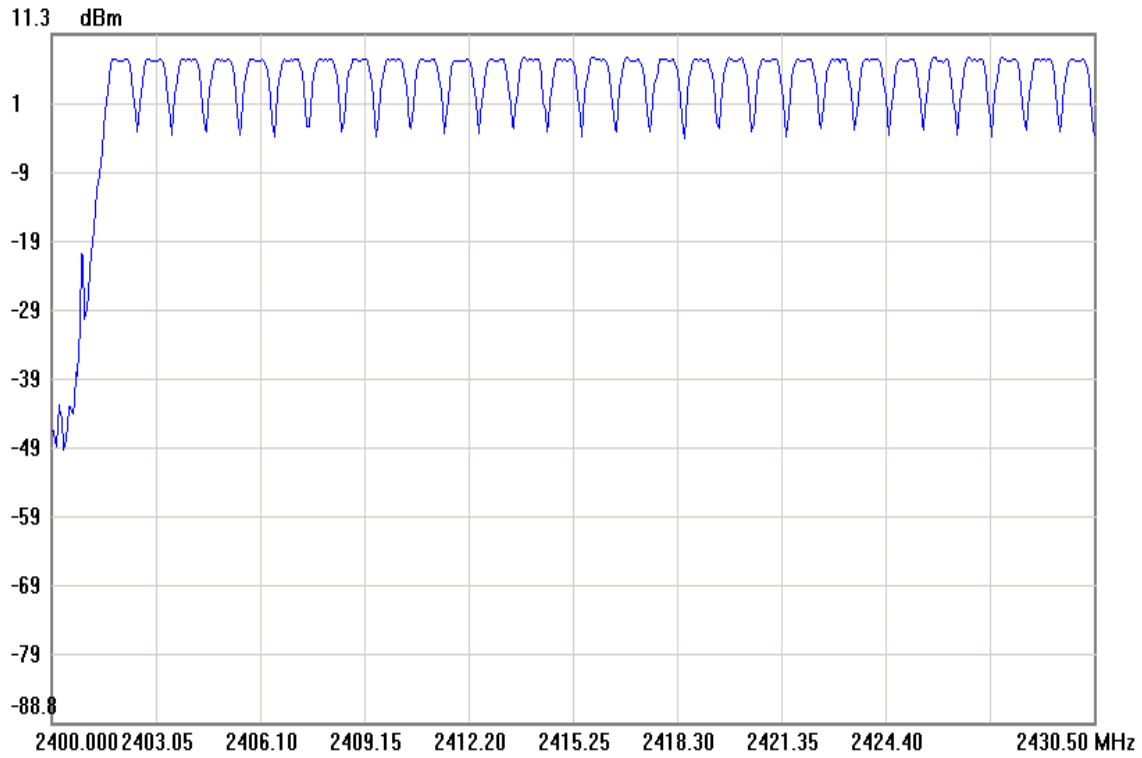

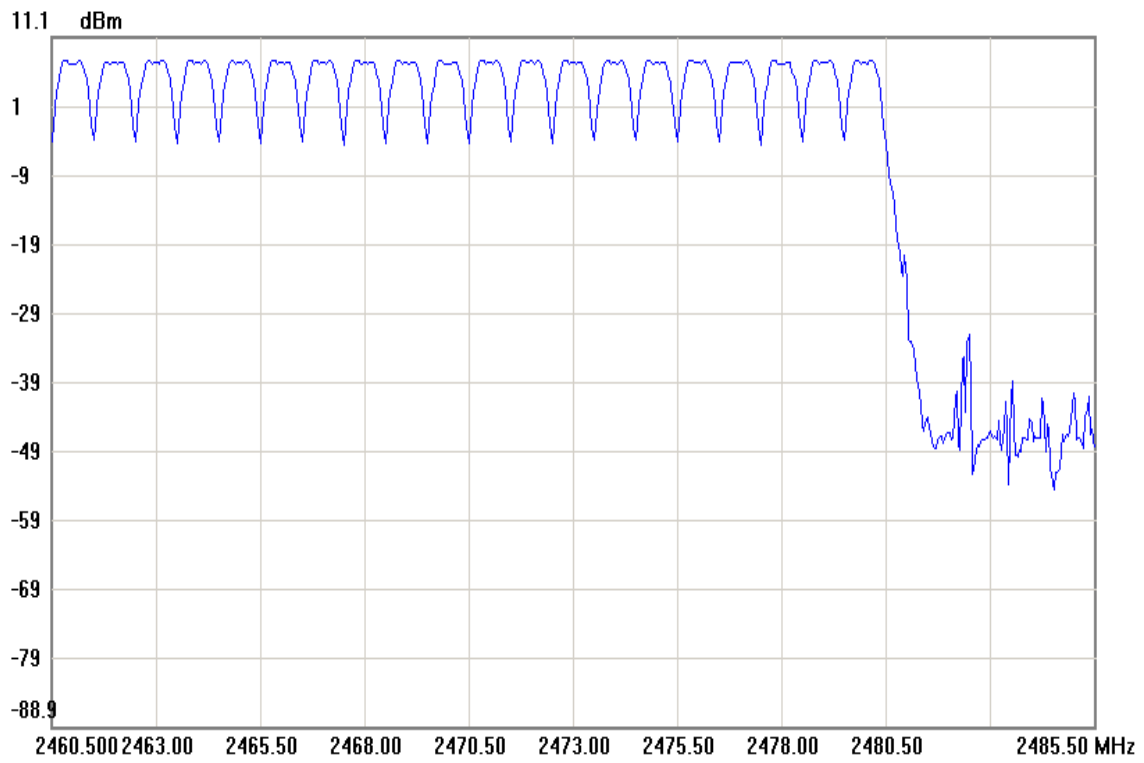



For 8DPSK

Channel Number

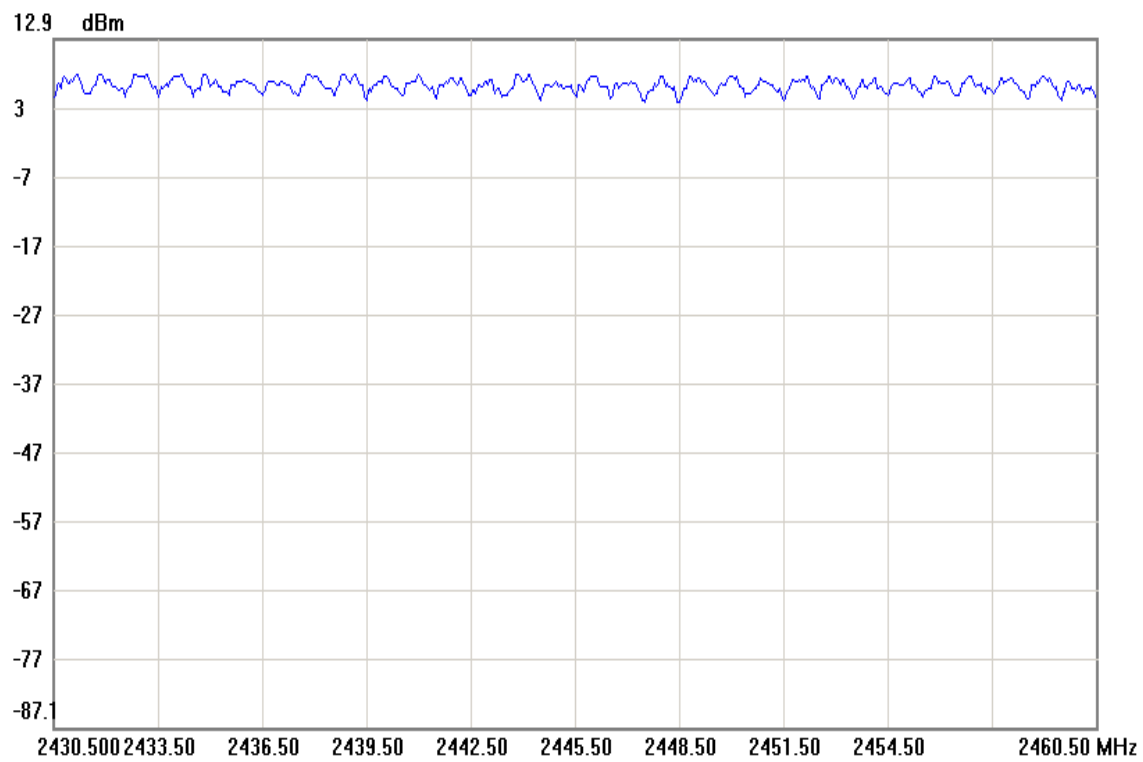
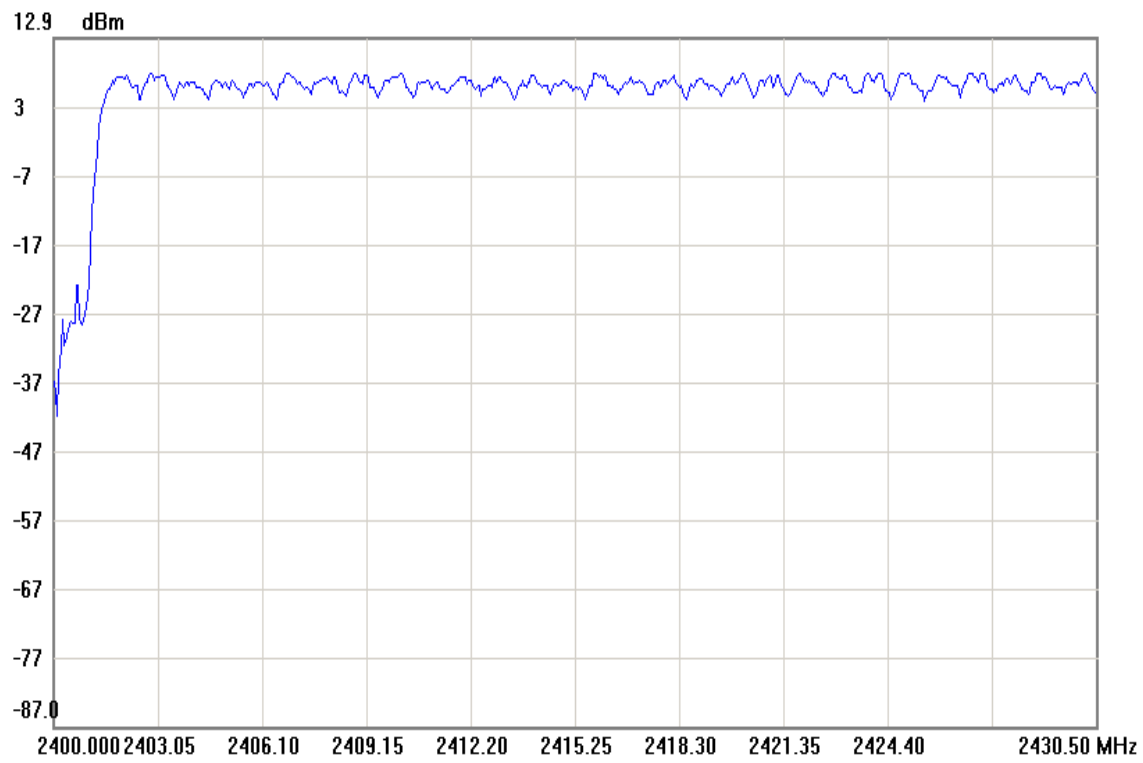

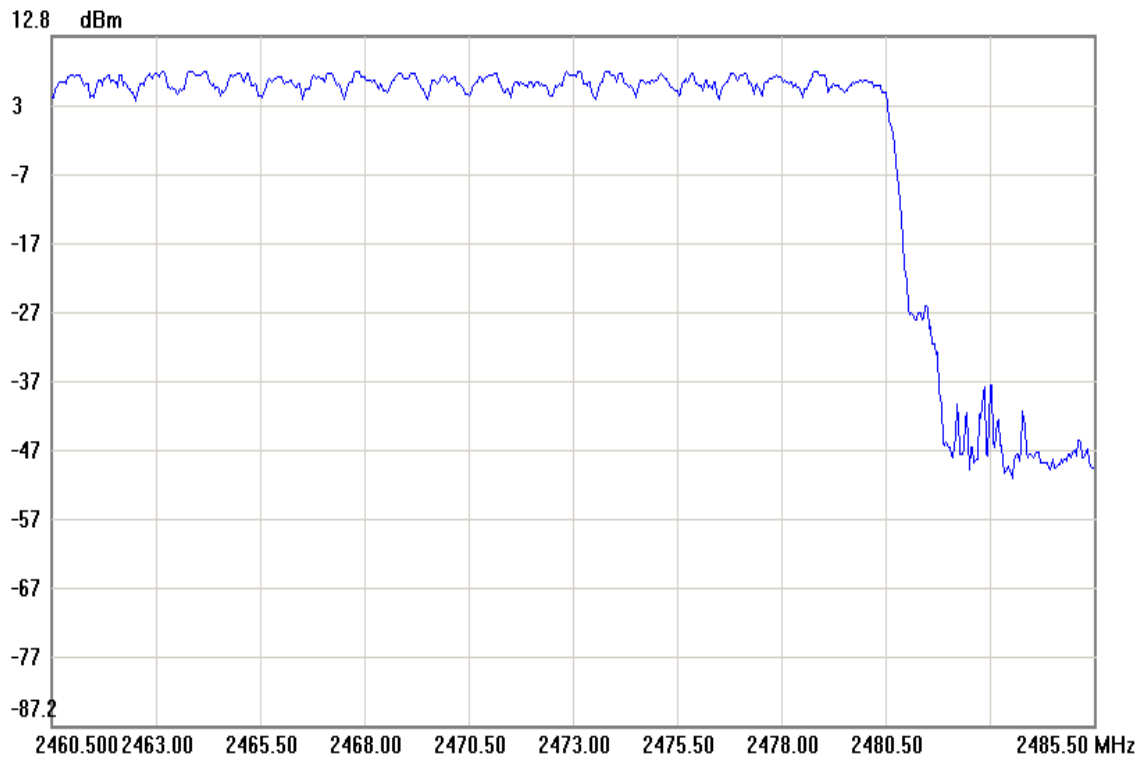



7.7 TIME OF OCCUPANCY (DWELL TIME)

LIMIT

According to §15.247(a)(1)(iii), Frequency hopping systems operating in the 2400MHz-2483.5 MHz bands. The average time of occupancy on any channels shall not greater than 0.4 s within a period 0.4 s multiplied by the number of hopping channels employed.

Test Configuration

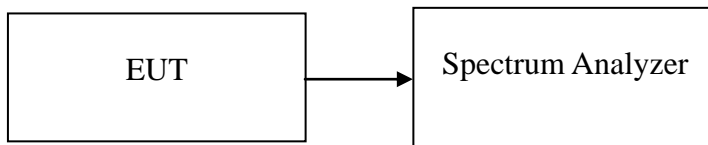

TEST PROCEDURE

1. Place the EUT on the table and set it in transmitting mode.
2. Remove the antenna from the EUT and then connect a low loss RF cable from the antenna port to the spectrum analyzer.
3. Set center frequency of spectrum analyzer = operating frequency.
4. Set the spectrum analyzer as RBW, VBW=1MHz, Sweep = 1 ms.
5. Repeat above procedures until all frequency measured were complete.

TEST RESULTS

No non-compliance noted



Test Data

For GFSK

DH 1: $0.3966 * (1600/2)/79 * 31.6 = 126.912$ (ms)

DH 3: $1.66 * (1600/4)/79 * 31.6 = 265.600$ (ms)

DH 5: $2.9167 * (1600/6)/79 * 31.6 = 311.115$ (ms)

| | Pulse Time (ms) | Total of Dwell (ms) | Period Time (s) | Limit (ms) | Result |
|------|----------------------------|--------------------------------|----------------------------|-----------------------|---------------|
| DH 1 | 0.3966 | 126.912 | 31.60 | 400.00 | PASS |
| DH 3 | 1.66 | 265.600 | 31.60 | | PASS |
| DH 5 | 2.9167 | 311.115 | 31.60 | | PASS |

For 8DPSK

DH 1: $0.4083 * (1600/2)/79 * 31.6 = 130.656$ (ms)

DH 3: $1.665 * (1600/4)/79 * 31.6 = 266.400$ (ms)

DH 5: $2.925 * (1600/6)/79 * 31.6 = 312.000$ (ms)

| | Pulse Time (ms) | Total of Dwell (ms) | Period Time (s) | Limit (ms) | Result |
|------|----------------------------|--------------------------------|----------------------------|-----------------------|---------------|
| DH 1 | 0.4083 | 130.656 | 31.60 | 400.00 | PASS |
| DH 3 | 1.665 | 266.400 | 31.60 | | PASS |
| DH 5 | 2.925 | 312.000 | 31.60 | | PASS |



Test Plot
For GFSK
DH 1

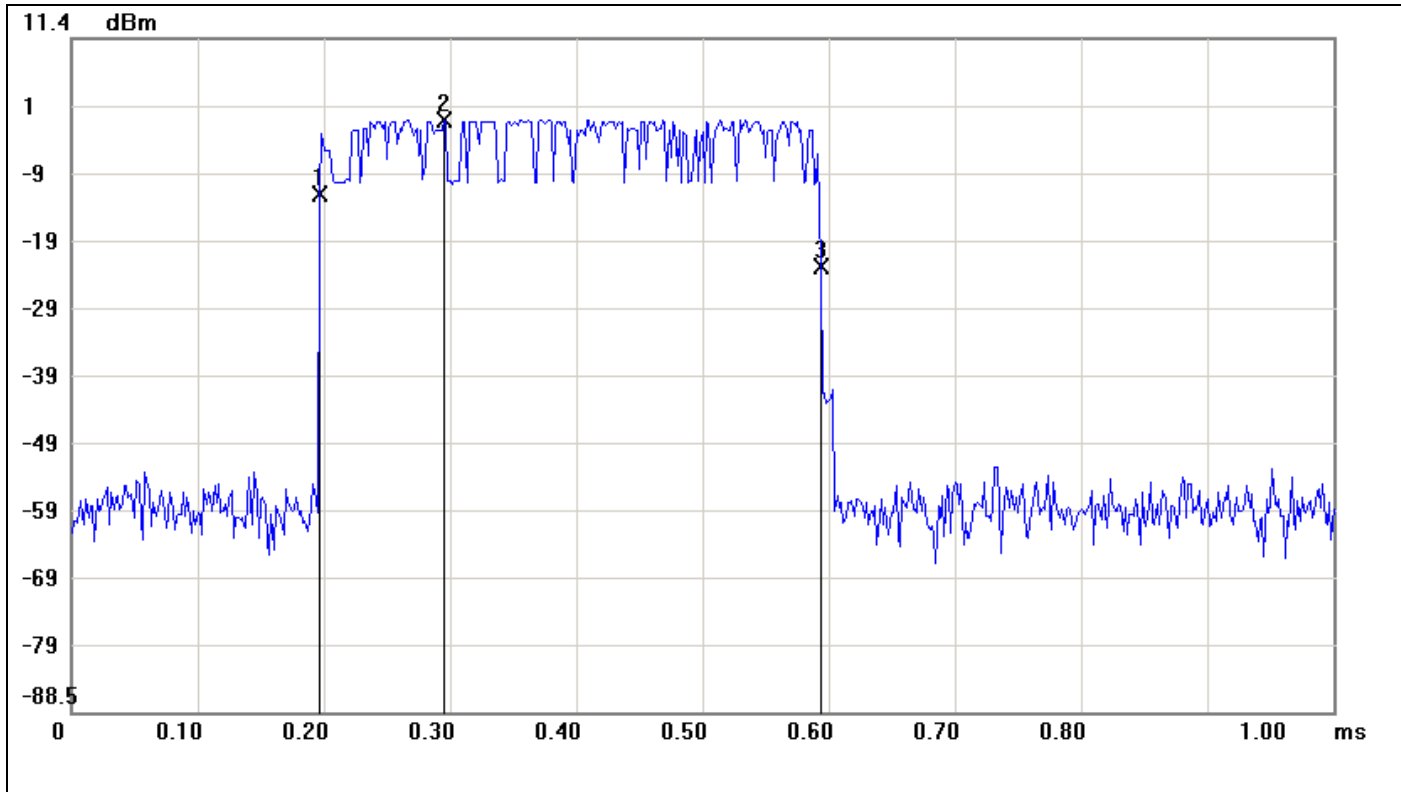

| No. | Sweep time(ms) | Result(dBm) | Limit(dBm) | Margin(dBm) |
|-----|----------------|-------------|------------|-------------|
| 1 | 0.1967 | -11.55 | | |
| 2 | 0.2950 | -0.70 | | |
| 3 | 0.5933 | -22.30 | | |

| No. | | Δ Time(ms) | Δ Level(dB) |
|-----|---------|-------------------|--------------------|
| 1 | mk3-mk1 | 0.3966 | -10.75 |



DH 3

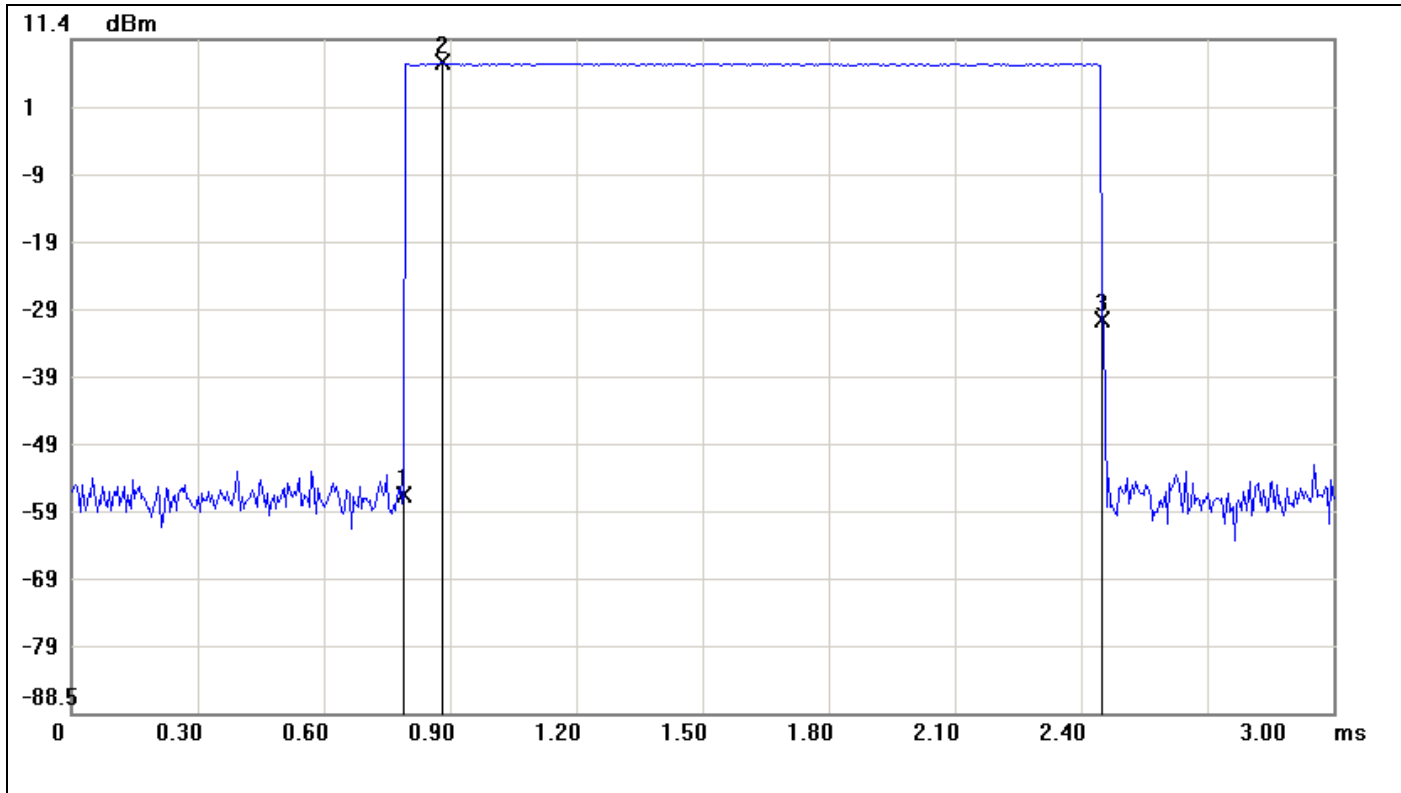

| No. | Sweep time(ms) | Result(dBm) | Limit(dBm) | Margin(dBm) |
|-----|----------------|-------------|------------|-------------|
| 1 | 0.7900 | -56.21 | | |
| 2 | 0.8800 | 7.96 | | |
| 3 | 2.4500 | -30.17 | | |

| No. | | Δ Time(ms) | Δ Level(dB) |
|-----|---------|-------------------|--------------------|
| 1 | mk3-mk1 | 1.66 | 26.04 |



DH 5

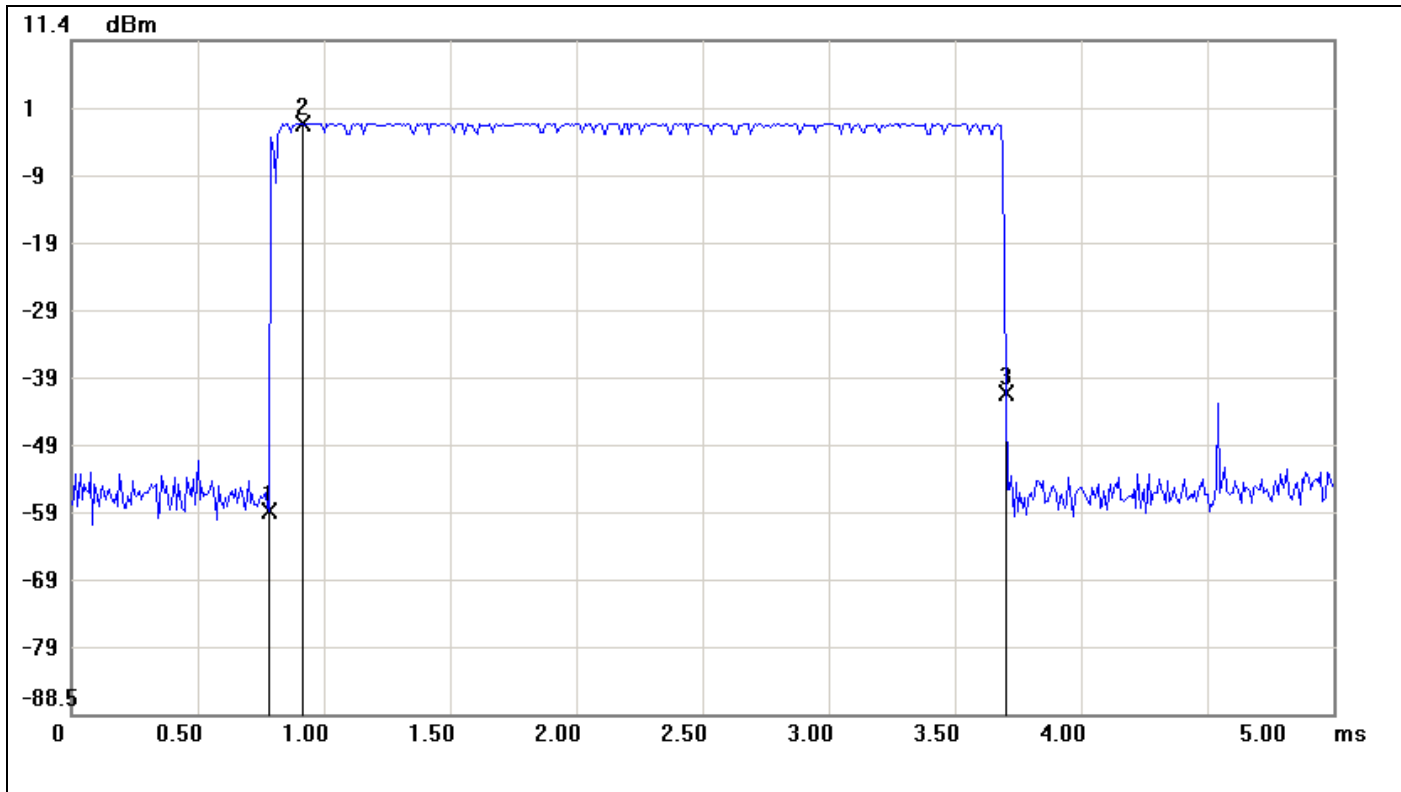

| No. | Sweep time(ms) | Result(dBm) | Limit(dBm) | Margin(dBm) |
|-----|----------------|-------------|------------|-------------|
| 1 | 0.7833 | -58.39 | | |
| 2 | 0.9167 | -0.88 | | |
| 3 | 3.7000 | -41.02 | | |

| No. | | Δ Time(ms) | Δ Level(dB) |
|-----|---------|-------------------|--------------------|
| 1 | mk3-mk1 | 2.9167 | 17.37 |



For 8DPSK

DH 1

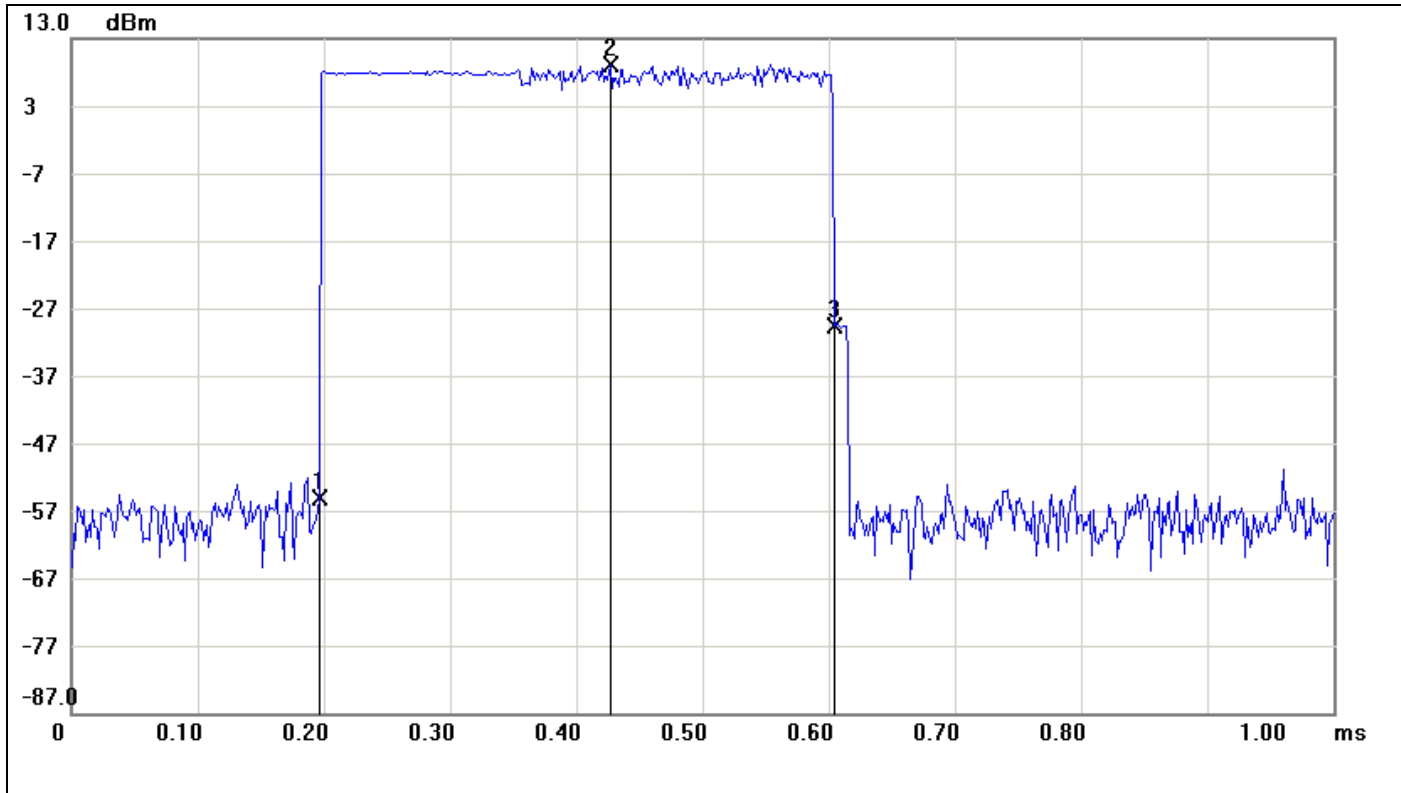

| No. | Sweep time(ms) | Result(dBm) | Limit(dBm) | Margin(dBm) |
|-----|----------------|-------------|------------|-------------|
| 1 | 0.1967 | -55.18 | | |
| 2 | 0.4267 | 9.17 | | |
| 3 | 0.6050 | -29.60 | | |

| No. | | Δ Time(ms) | Δ Level(dB) |
|-----|---------|-------------------|--------------------|
| 1 | mk3-mk1 | 0.4083 | 25.58 |



DH 3

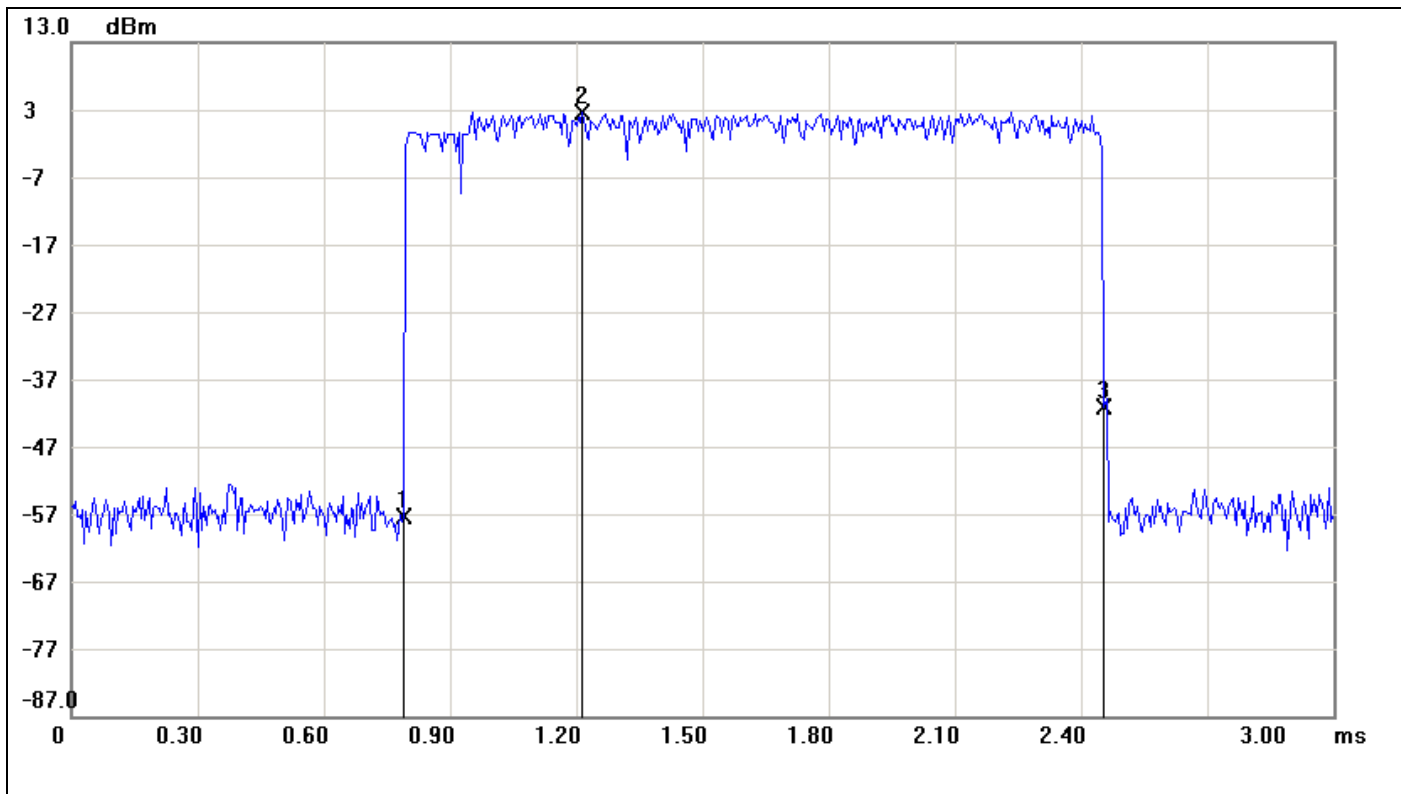

| No. | Sweep time(ms) | Result(dBm) | Limit(dBm) | Margin(dBm) |
|-----|----------------|-------------|------------|-------------|
| 1 | 0.7900 | -57.26 | | |
| 2 | 1.2150 | 2.62 | | |
| 3 | 2.4550 | -41.06 | | |

| No. | | Δ Time(ms) | Δ Level(dB) |
|-----|---------|-------------------|--------------------|
| 1 | mk3-mk1 | 1.665 | 16.2 |



DH 5

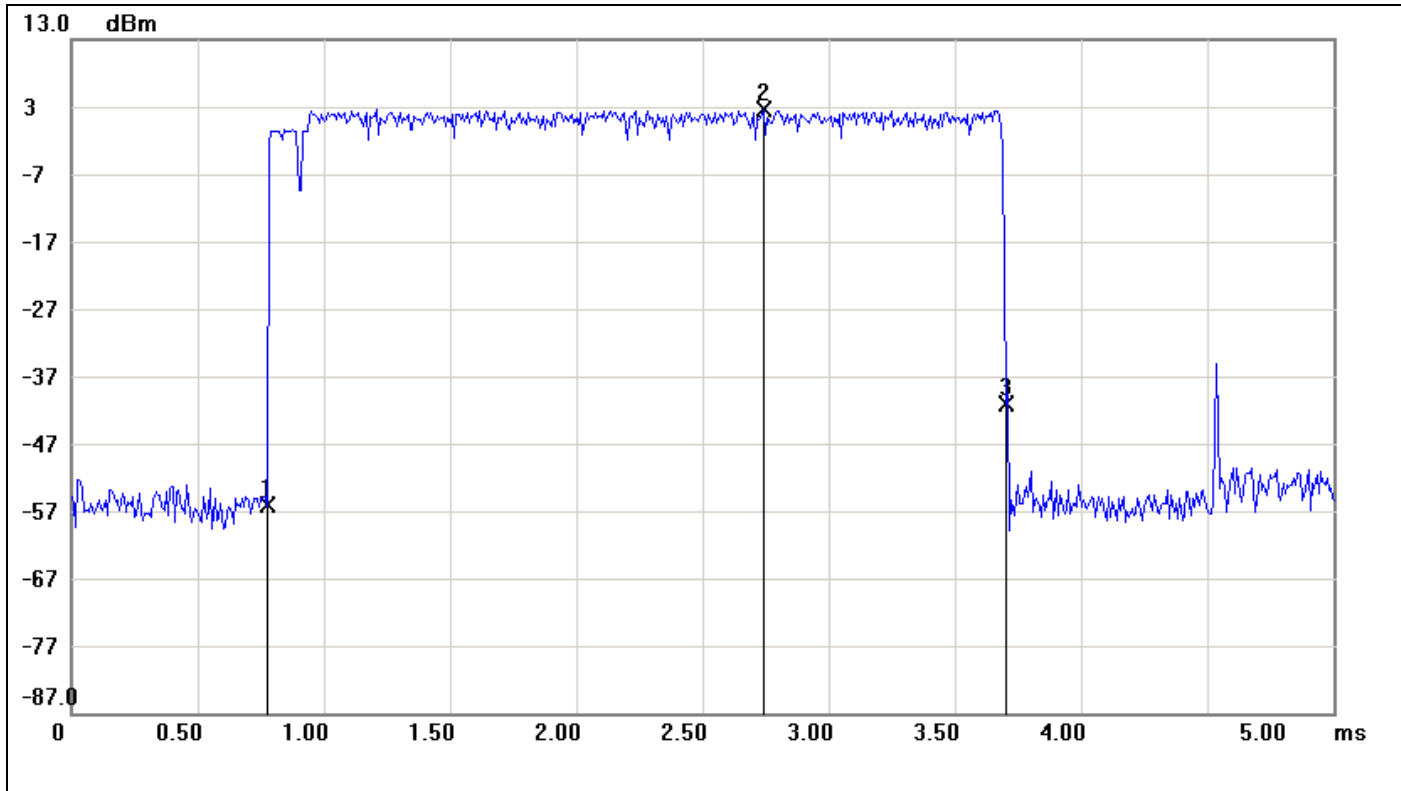

| No. | Sweep time(ms) | Result(dBm) | Limit(dBm) | Margin(dBm) |
|-----|----------------|-------------|------------|-------------|
| 1 | 0.7750 | -56.23 | | |
| 2 | 2.7417 | 2.58 | | |
| 3 | 3.7000 | -41.03 | | |

| No. | | Δ Time(ms) | Δ Level(dB) |
|-----|---------|-------------------|--------------------|
| 1 | mk3-mk1 | 2.925 | 15.2 |



7.8 SPURIOUS EMISSIONS

7.8.1 Conducted Measurement

LIMIT

According to §15.247(d), in any 100 kHz bandwidth outside the frequency bands in which the spread spectrum intentional radiator is operating, the radio frequency power that is produced by the intentional radiator shall be at least 20 dB below that in the 100 kHz bandwidth within the band that contains the highest level of the desired power, based on either an RF conducted or a radiated measurement, provided the transmitter demonstrates compliance with the peak conducted power limits. In addition, radiated emissions which fall in the restricted bands, as defined in §15.205(a), must also comply with the radiated emission limits specified in 15.209(a) (see Section 15.205(c)).

Test Configuration

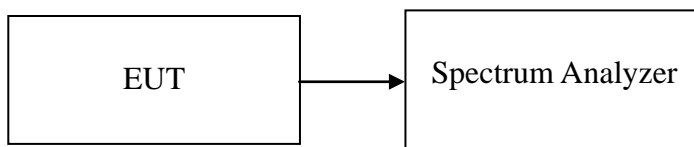

TEST PROCEDURE

Conducted RF measurements of the transmitter output were made to confirm that the EUT antenna port conducted emissions meet the specified limit and to identify any spurious signals that require further investigation or measurements on the radiated emissions site.

The transmitter output is connected to the spectrum analyzer. The resolution bandwidth is set to 100 kHz. The video bandwidth is set to 100 kHz.

Measurements are made over the 30MHz to 26GHz range with the transmitter set to the lowest, middle, and highest channels.

TEST RESULTS

No non-compliance noted



Test Plot

For GFSK / DH5

CH Low

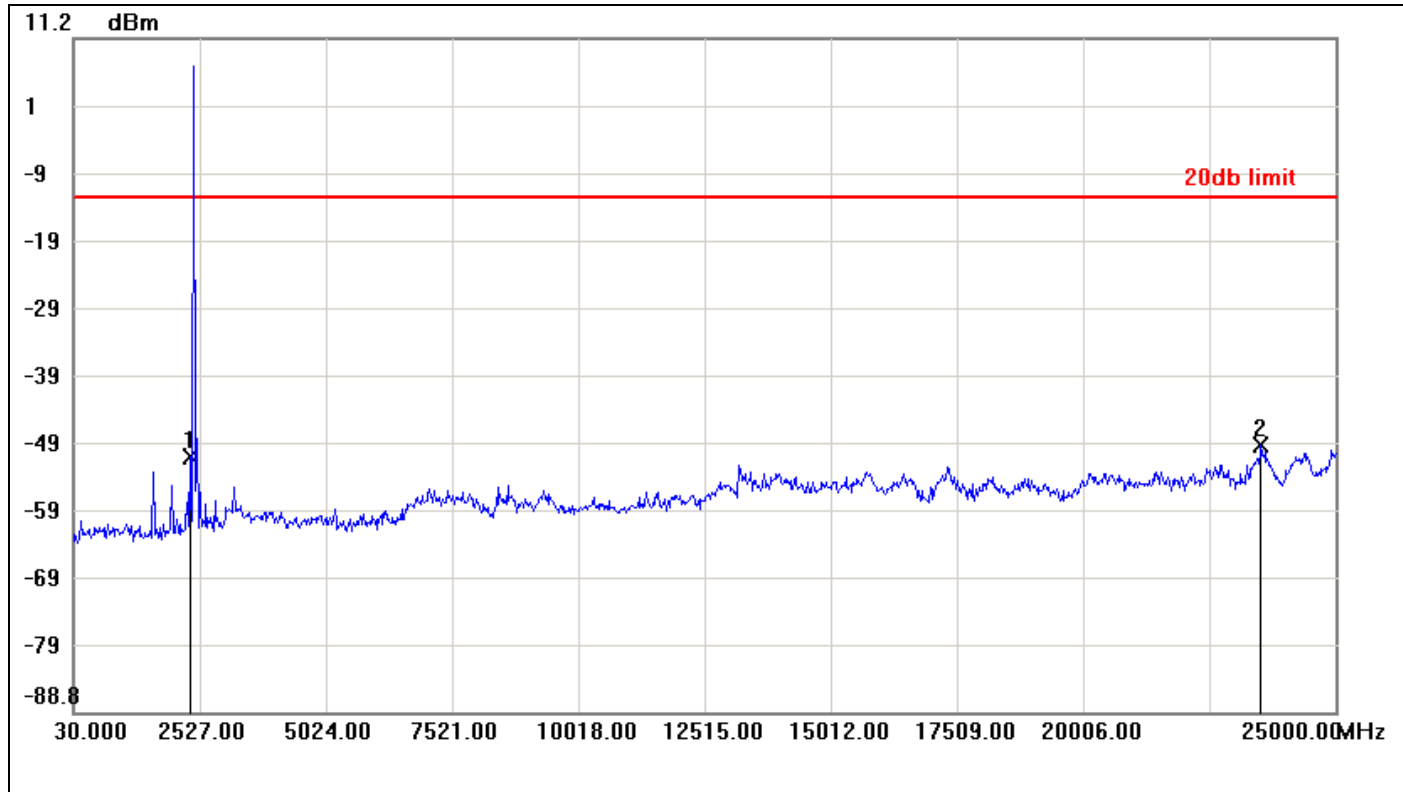

| No. | Frequency(MHz) | Result(dBm) | Limit(dBm) | Margin(dBm) |
|-----|----------------|-------------|------------|-------------|
| 1 | 2327.2400 | -51.00 | -12.41 | -38.59 |
| 2 | 23526.7700 | -49.22 | -12.41 | -36.81 |



CH Mid

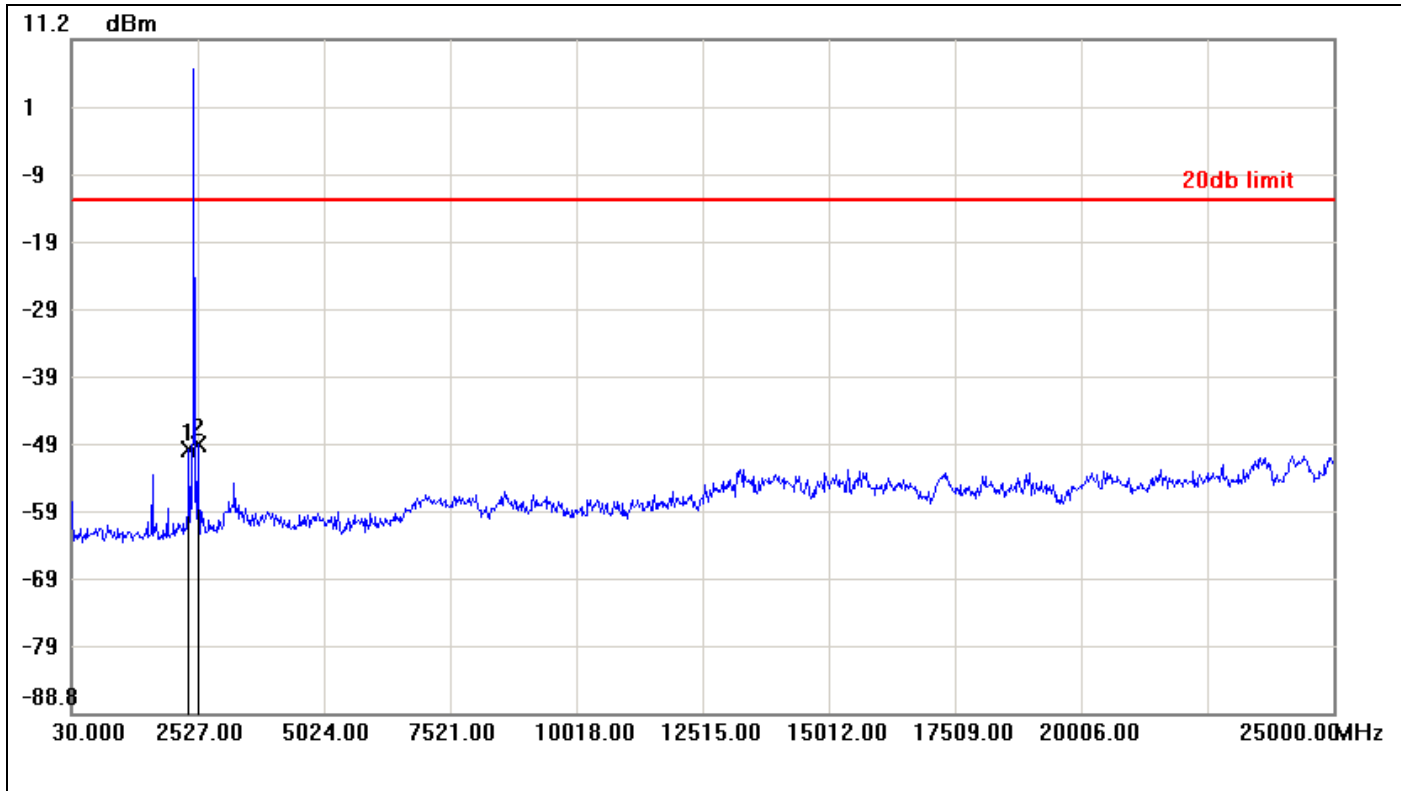

| No. | Frequency(MHz) | Result(dBm) | Limit(dBm) | Margin(dBm) |
|-----|----------------|-------------|------------|-------------|
| 1 | 2352.2100 | -49.52 | -12.63 | -36.89 |
| 2 | 2527.0000 | -48.78 | -12.63 | -36.15 |



CH High

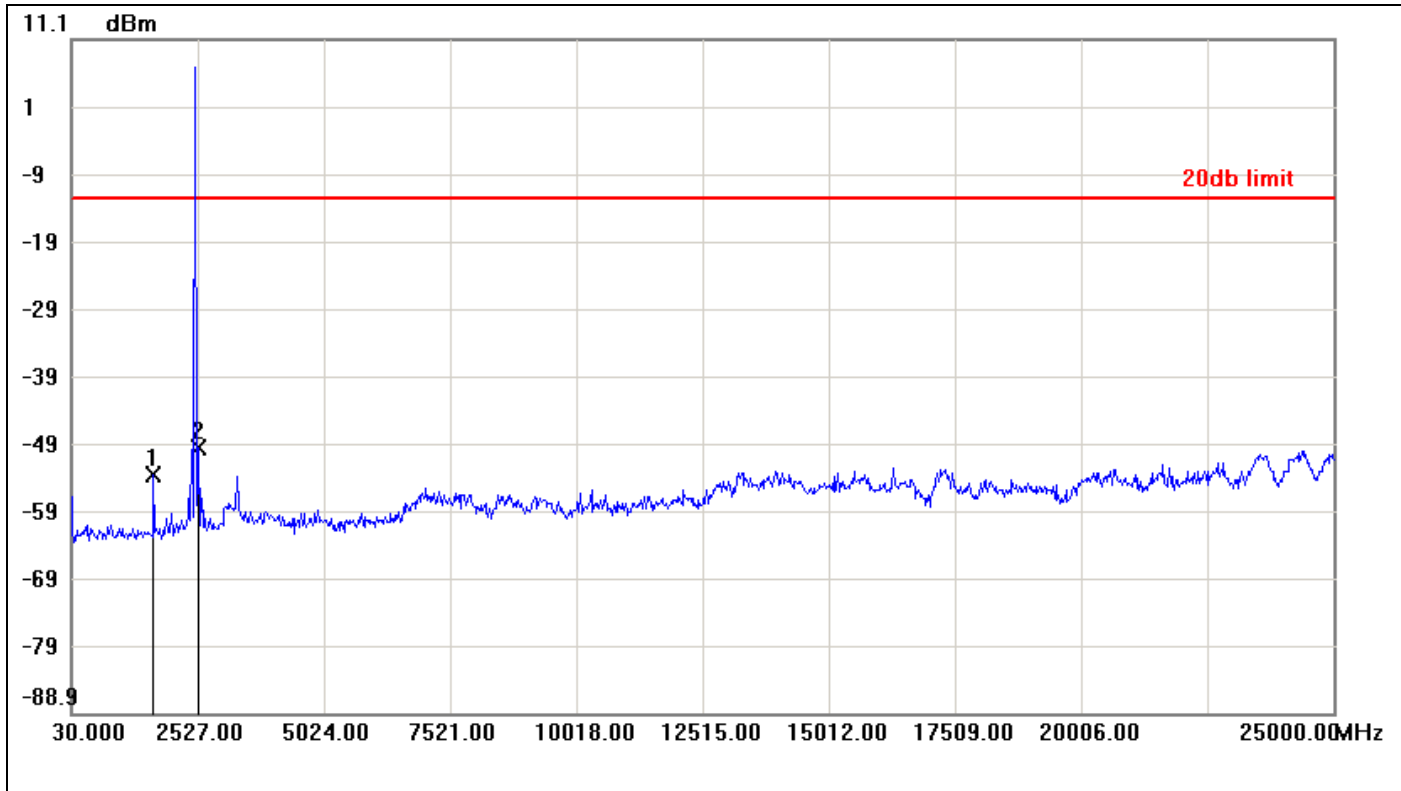

| No. | Frequency(MHz) | Result(dBm) | Limit(dBm) | Margin(dBm) |
|-----|----------------|-------------|------------|-------------|
| 1 | 1653.0500 | -53.54 | -12.47 | -41.07 |
| 2 | 2551.9700 | -49.61 | -12.47 | -37.14 |



For 8DPSK / DH5

CH Low

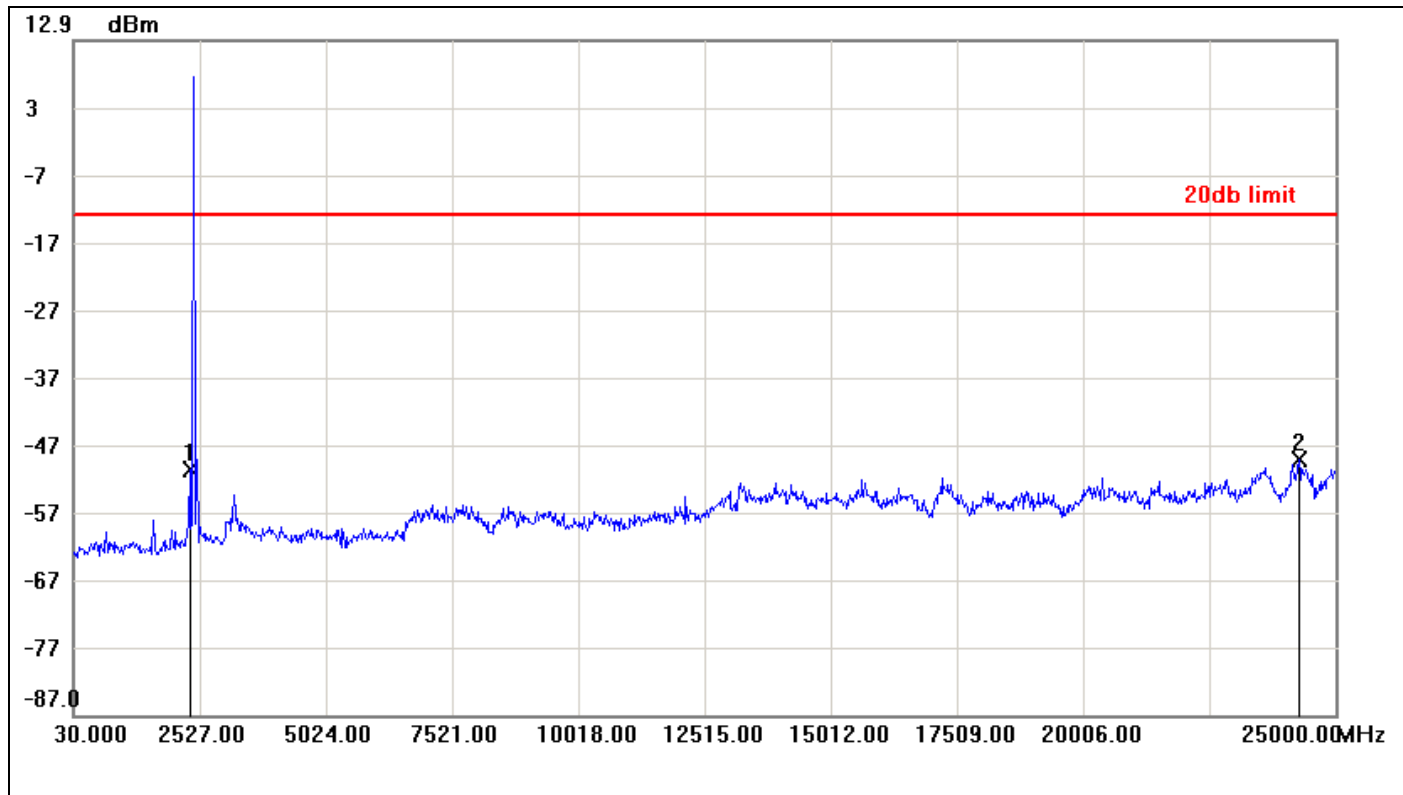

| No. | Frequency(MHz) | Result(dBm) | Limit(dBm) | Margin(dBm) |
|-----|----------------|-------------|------------|-------------|
| 1 | 2327.2400 | -50.58 | -12.99 | -37.59 |
| 2 | 24275.8700 | -49.27 | -12.99 | -36.28 |



CH Mid

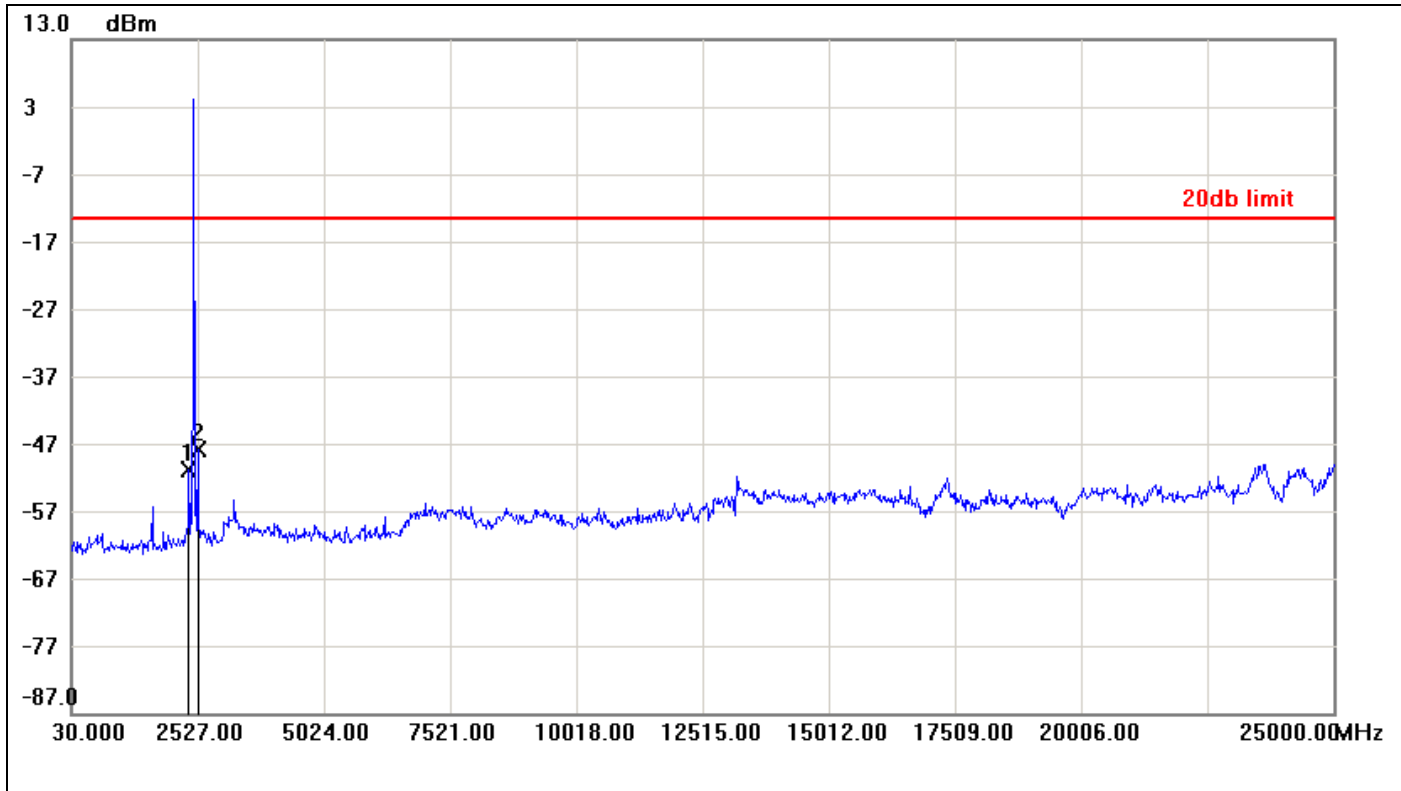

| No. | Frequency(MHz) | Result(dBm) | Limit(dBm) | Margin(dBm) |
|-----|----------------|-------------|------------|-------------|
| 1 | 2352.2100 | -50.78 | -13.64 | -37.14 |
| 2 | 2527.0000 | -47.91 | -13.64 | -34.27 |



CH High

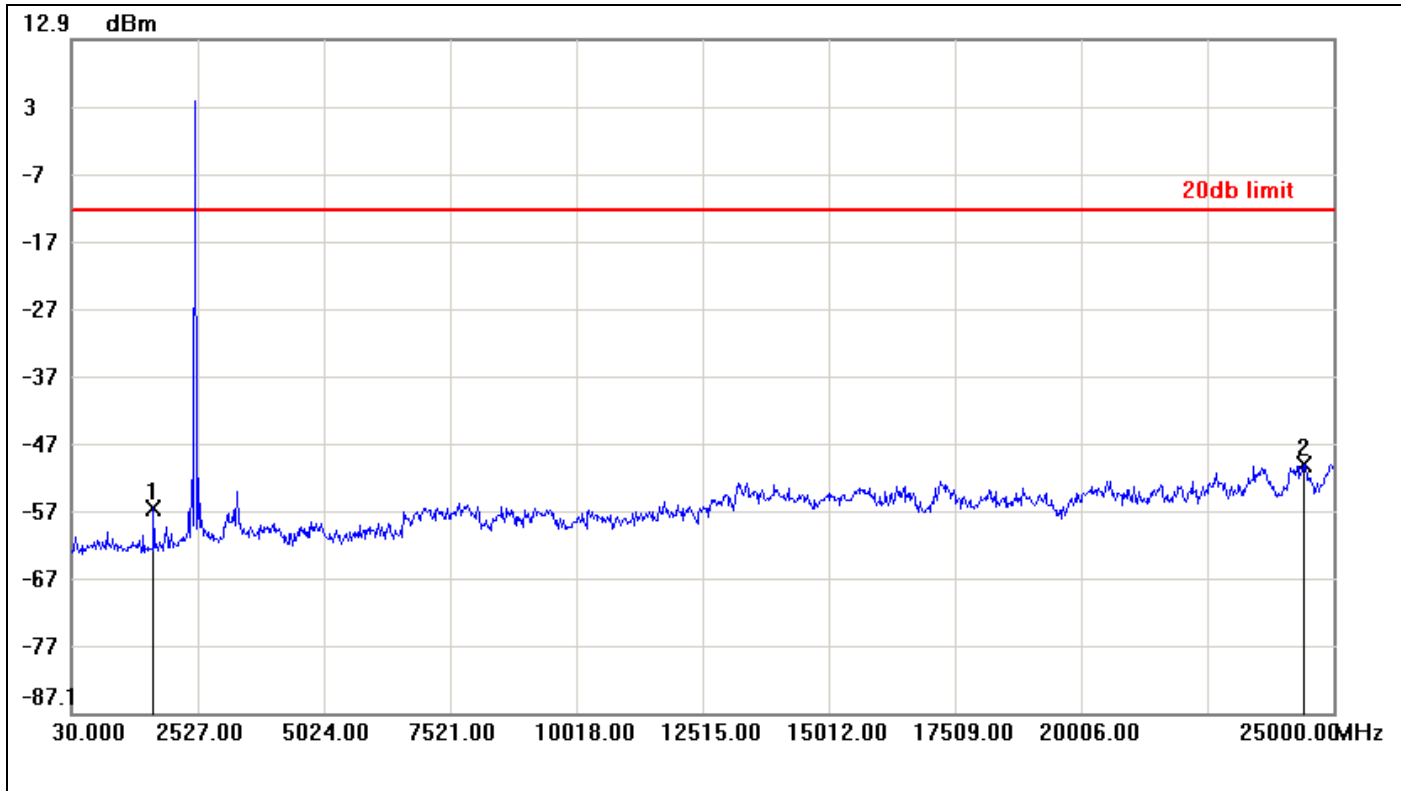

| No. | Frequency(MHz) | Result(dBm) | Limit(dBm) | Margin(dBm) |
|-----|----------------|-------------|------------|-------------|
| 1 | 1653.0500 | -56.63 | -12.34 | -44.29 |
| 2 | 24400.7200 | -50.25 | -12.34 | -37.91 |



7.8.2 Radiated Emissions

LIMIT

All spurious emissions shall comply with the limits of §15.209(a) and RSS-Gen Table 2 & Table 5.

RSS-Gen Table 2 & Table 5: General Field Strength Limits for Transmitters and Receivers at Frequencies Above 30 MHz ^(Note)

| Frequency (MHz) | Field Strength microvolts/m at 3 metres (watts, e.i.r.p.) | |
|-----------------|--|--------------|
| | Transmitters | Receivers |
| 30-88 | 100 (3 nW) | 100 (3 nW) |
| 88-216 | 150 (6.8 nW) | 150 (6.8 nW) |
| 216-960 | 200 (12 nW) | 200 (12 nW) |
| Above 960 | 500 (75 nW) | 500 (75 nW) |

Note: *Measurements for compliance with limits in the above table may be performed at distances other than 3 metres, in accordance with Section 7.2.7.

Transmitting devices are not permitted in Table 1 bands or, unless stated otherwise, in TV bands (54-72 MHz, 76-88 MHz, 174-216 MHz, 470-608 MHz and 614-806 MHz).

RSS-Gen Table 6: General Field Strength Limits for Transmitters at Frequencies Below 30 MHz (Transmit)

| Frequency | Field Strength (microvolts/m) | Magnetic H-Field (microamperes/m) | Measurement Distance (metres) |
|---------------|-------------------------------|-----------------------------------|-------------------------------|
| 9-490 kHz | 2,400/F (F in kHz) | 2,400/377F (F in kHz) | 3000 |
| 490-1,705 kHz | 24,000/F (F in kHz) | 24,000/377F (F in kHz) | 30 |
| 1.705-30 MHz | 30 | N/A | 30 |

Note: The emission limits for the bands 9-90 kHz and 110-490 kHz are based on measurements employing an average detector.



Test Configuration

9kHz ~ 30MHz

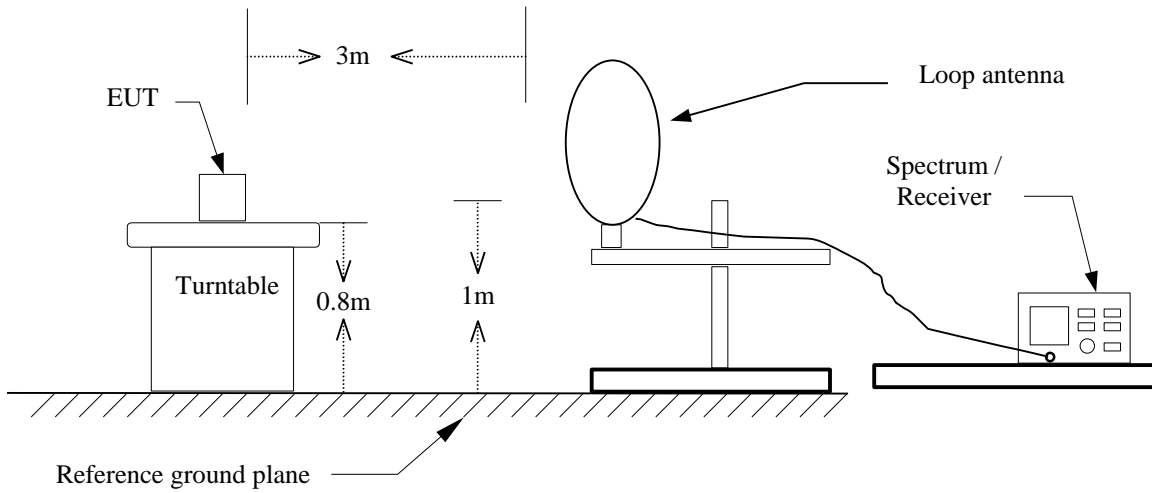

30MHz ~ 1GHz

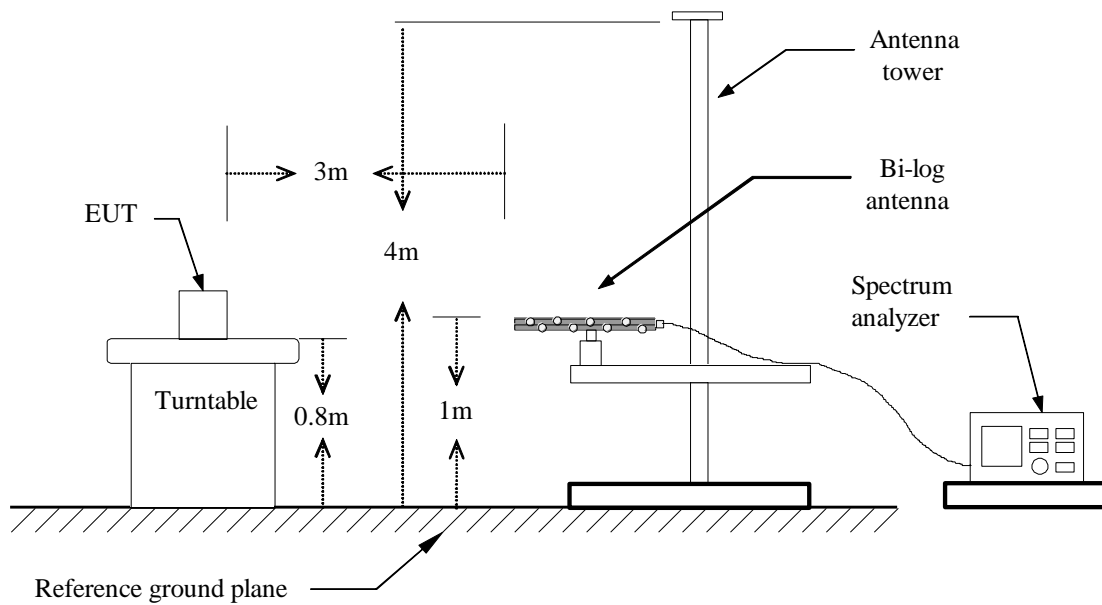



Above 1 GHz

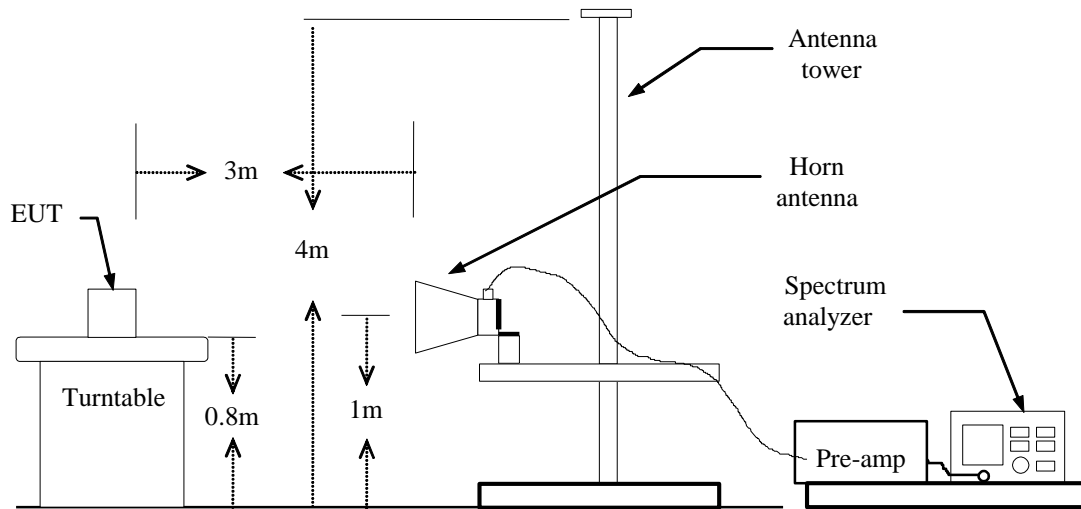



TEST PROCEDURE

1. The EUT is placed on a turntable, which is 0.8m above ground plane.
2. The turntable shall be rotated for 360 degrees to determine the position of maximum emission level.
3. EUT is set 3m away from the receiving antenna, which is varied from 1m to 4m to find out the highest emissions.
4. Maximum procedure was performed on the six highest emissions to ensure EUT compliance.
5. And also, each emission was to be maximized by changing the polarization of receiving antenna both horizontal and vertical.
6. Set the spectrum analyzer in the following setting as:

Below 1GHz:

RBW=100kHz / VBW=300kHz / Sweep=AUTO

Above 1GHz:

(a) PEAK: RBW=1MHz / VBW=3MHz / Sweep=AUTO

(b) AVERAGE: RBW=1MHz / VBW=300Hz / Sweep=AUTO

(C) if duty cycle \geq 98%, VBW=10Hz.
if duty cycle < 98% VBW=1/T.

BT < 98%, VBW= 360Hz

EDR < 98%, VBW=360Hz

7. Repeat above procedures until the measurements for all frequencies are complete.

**Below 1 GHz**

Operation Mode: Normal Link **Test Date:** April 20, 2015
Temperature: 27°C **Tested by:** David Shu
Humidity: 53 % RH **Polarity:** Ver. / Hor.

| Frequency (MHz) | Reading (dBuV) | Correction Factor (dB/m) | Result (dBuV/m) | Limit (dBuV/m) | Margin (dB) | Remark | Ant.Pol. (H/V) |
|-----------------|----------------|--------------------------|-----------------|----------------|-------------|--------|----------------|
| 167.7400 | 50.57 | -18.69 | 31.88 | 43.50 | -11.62 | Peak | V |
| 282.2000 | 43.11 | -16.72 | 26.39 | 46.00 | -19.61 | Peak | V |
| 451.9500 | 42.41 | -12.63 | 29.78 | 46.00 | -16.22 | Peak | V |
| 506.2700 | 40.00 | -11.73 | 28.27 | 46.00 | -17.73 | Peak | V |
| 676.9900 | 34.20 | -9.03 | 25.17 | 46.00 | -20.83 | Peak | V |
| 735.1900 | 34.52 | -8.15 | 26.37 | 46.00 | -19.63 | Peak | V |
| 149.3100 | 34.34 | -17.96 | 16.38 | 43.50 | -27.12 | Peak | H |
| 279.2900 | 35.41 | -16.78 | 18.63 | 46.00 | -27.37 | Peak | H |
| 425.7600 | 34.84 | -13.32 | 21.52 | 46.00 | -24.48 | Peak | H |
| 545.0700 | 34.51 | -11.08 | 23.43 | 46.00 | -22.57 | Peak | H |
| 667.2900 | 34.50 | -9.13 | 25.37 | 46.00 | -20.63 | Peak | H |
| 743.9200 | 34.56 | -7.99 | 26.57 | 46.00 | -19.43 | Peak | H |

Remark:

1. No emission found between lowest internal used/generated frequency to 30MHz (9kHz~30MHz)
2. Radiated emissions measured in frequency range from 30 MHz to 1000MHz were made with an instrument using peak/quasi-peak detector mode.
3. Quasi-peak test would be performed if the peak result were greater than the quasi-peak limit or as required by the applicant.
4. Measurements above show only up to 6 maximum emissions noted, or would be lesser, with " N/A " remark, if no specific emissions from the EUT are recorded (ie: margin>20dB from the applicable limit) and considered that's already beyond the background noise floor.
5. $Margin (dB) = Remark\ result (dBuV/m) - Quasi-peak\ limit (dBuV/m).$



Above 1 GHz

Operation Mode: TX / GFSK / DH5 / CH Low

Test Date: April 20, 2015

Temperature: 27°C

Tested by: David Shu

Humidity: 53 % RH

Polarity: Ver. / Hor.

| Frequency (MHz) | Reading (dBuV) | Correction (dB/m) | Result (dBuV/m) | Limit (dBuV/m) | Margin (dB) | Remark | Ant.Pol. (H/V) |
|-----------------|----------------|-------------------|-----------------|----------------|-------------|--------|----------------|
| 1794.000 | 53.44 | -5.97 | 47.47 | 74.00 | -26.53 | peak | V |
| N/A | | | | | | | |
| | | | | | | | |
| | | | | | | | |
| | | | | | | | |
| | | | | | | | |
| 1952.000 | 54.62 | -5.13 | 49.49 | 74.00 | -24.51 | peak | H |
| N/A | | | | | | | |
| | | | | | | | |
| | | | | | | | |
| | | | | | | | |
| | | | | | | | |

Remark:

1. Measuring frequencies from 1 GHz to the 10th harmonic of highest fundamental frequency.
2. Radiated emissions measured in frequency above 1000MHz were made with an instrument using peak/average detector mode.
3. Average test would be performed if the peak result were greater than the average limit .
4. Data of measurement within this frequency range shown “ --- ” in the table above means the reading of emissions are attenuated more than 20dB below the permissible limits or the field strength is too small to be measured.
5. Measurements above show only up to 6 maximum emissions noted, or would be lesser, with “ N/A ” remark, if no specific emissions from the EUT are recorded (ie: margin>20dB from the applicable limit) and considered that's already beyond the background noise floor.
6. Margin (dB) = Remark result (dBuV/m) – Average limit (dBuV/m).



Operation Mode: TX / GFSK / DH5 / CH Mid

Test Date: April 20, 2015

Temperature: 27°C

Tested by: David Shu

Humidity: 53 % RH

Polarity: Ver. / Hor.

| Frequency (MHz) | Reading (dBuV) | Correction (dB/m) | Result (dBuV/m) | Limit (dBuV/m) | Margin (dB) | Remark | Ant.Pol. (H/V) |
|-----------------|----------------|-------------------|-----------------|----------------|-------------|--------|----------------|
| 1792.000 | 54.10 | -5.98 | 48.12 | 74.00 | -25.88 | peak | V |
| N/A | | | | | | | |
| | | | | | | | |
| | | | | | | | |
| | | | | | | | |
| | | | | | | | |
| 1198.000 | 54.85 | -8.86 | 45.99 | 74.00 | -28.01 | peak | H |
| N/A | | | | | | | |
| | | | | | | | |
| | | | | | | | |
| | | | | | | | |
| | | | | | | | |

Remark:

1. Measuring frequencies from 1 GHz to the 10th harmonic of highest fundamental frequency.
2. Radiated emissions measured in frequency above 1000MHz were made with an instrument using peak/average detector mode.
3. Average test would be performed if the peak result were greater than the average limit.
4. Data of measurement within this frequency range shown “ --- ” in the table above means the reading of emissions are attenuated more than 20dB below the permissible limits or the field strength is too small to be measured.
5. Measurements above show only up to 6 maximum emissions noted, or would be lesser, with “ N/A ” remark, if no specific emissions from the EUT are recorded (ie: margin>20dB from the applicable limit) and considered that's already beyond the background noise floor.
6. Margin (dB) = Remark result (dBuV/m) – Average limit (dBuV/m).



Operation Mode: TX / GFSK / DH5 / CH High

Test Date: April 20, 2015

Temperature: 27°C

Tested by: David Shu

Humidity: 53 % RH

Polarity: Ver. / Hor.

| Frequency (MHz) | Reading (dBuV) | Correction (dB/m) | Result (dBuV/m) | Limit (dBuV/m) | Margin (dB) | Remark | Ant.Pol. (H/V) |
|-----------------|----------------|-------------------|-----------------|----------------|-------------|--------|----------------|
| 1796.000 | 54.96 | -5.96 | 49.00 | 74.00 | -25.00 | peak | V |
| N/A | | | | | | | |
| | | | | | | | |
| | | | | | | | |
| | | | | | | | |
| | | | | | | | |
| 1196.000 | 56.25 | -8.87 | 47.38 | 74.00 | -26.62 | peak | H |
| N/A | | | | | | | |
| | | | | | | | |
| | | | | | | | |
| | | | | | | | |
| | | | | | | | |

Remark:

1. Measuring frequencies from 1 GHz to the 10th harmonic of highest fundamental frequency.
2. Radiated emissions measured in frequency above 1000MHz were made with an instrument using peak/average detector mode.
3. Average test would be performed if the peak result were greater than the average limit.
4. Data of measurement within this frequency range shown “ --- ” in the table above means the reading of emissions are attenuated more than 20dB below the permissible limits or the field strength is too small to be measured.
5. Measurements above show only up to 6 maximum emissions noted, or would be lesser, with “ N/A ” remark, if no specific emissions from the EUT are recorded (ie: margin>20dB from the applicable limit) and considered that's already beyond the background noise floor.
6. Margin (dB) = Remark result (dBuV/m) – Average limit (dBuV/m).



Operation Mode: TX / 8DPSK / DH5 / CH Low

Test Date: April 20, 2015

Temperature: 27°C

Tested by: David Shu

Humidity: 53 % RH

Polarity: Ver. / Hor.

| Frequency (MHz) | Reading (dBuV) | Correction (dB/m) | Result (dBuV/m) | Limit (dBuV/m) | Margin (dB) | Remark | Ant.Pol. (H/V) |
|-----------------|----------------|-------------------|-----------------|----------------|-------------|--------|----------------|
| 1798.000 | 55.04 | -5.95 | 49.09 | 74.00 | -24.91 | peak | V |
| N/A | | | | | | | |
| | | | | | | | |
| | | | | | | | |
| | | | | | | | |
| | | | | | | | |
| 1196.000 | 55.43 | -8.87 | 46.56 | 74.00 | -27.44 | peak | H |
| N/A | | | | | | | |
| | | | | | | | |
| | | | | | | | |
| | | | | | | | |
| | | | | | | | |

Remark:

1. Measuring frequencies from 1 GHz to the 10th harmonic of highest fundamental frequency.
2. Radiated emissions measured in frequency above 1000MHz were made with an instrument using peak/average detector mode.
3. Average test would be performed if the peak result were greater than the average limit.
4. Data of measurement within this frequency range shown “ --- ” in the table above means the reading of emissions are attenuated more than 20dB below the permissible limits or the field strength is too small to be measured.
5. Measurements above show only up to 6 maximum emissions noted, or would be lesser, with “ N/A ” remark, if no specific emissions from the EUT are recorded (ie: margin>20dB from the applicable limit) and considered that's already beyond the background noise floor.
6. Margin (dB) = Remark result (dBuV/m) – Average limit (dBuV/m).



Operation Mode: TX / 8DPSK / DH5 / CH Mid

Test Date: April 20, 2015

Temperature: 27°C

Tested by: David Shu

Humidity: 53 % RH

Polarity: Ver. / Hor.

| Frequency (MHz) | Reading (dBuV) | Correction (dB/m) | Result (dBuV/m) | Limit (dBuV/m) | Margin (dB) | Remark | Ant.Pol. (H/V) |
|-----------------|----------------|-------------------|-----------------|----------------|-------------|--------|----------------|
| 1798.000 | 55.41 | -5.95 | 49.46 | 74.00 | -24.54 | peak | V |
| N/A | | | | | | | |
| | | | | | | | |
| | | | | | | | |
| | | | | | | | |
| | | | | | | | |
| 2046.000 | 50.54 | -4.93 | 45.61 | 74.00 | -28.39 | peak | H |
| N/A | | | | | | | |
| | | | | | | | |
| | | | | | | | |
| | | | | | | | |
| | | | | | | | |

Remark:

1. Measuring frequencies from 1 GHz to the 10th harmonic of highest fundamental frequency.
2. Radiated emissions measured in frequency above 1000MHz were made with an instrument using peak/average detector mode.
3. Average test would be performed if the peak result were greater than the average limit.
4. Data of measurement within this frequency range shown “ --- ” in the table above means the reading of emissions are attenuated more than 20dB below the permissible limits or the field strength is too small to be measured.
5. Measurements above show only up to 6 maximum emissions noted, or would be lesser, with “ N/A ” remark, if no specific emissions from the EUT are recorded (ie: margin>20dB from the applicable limit) and considered that's already beyond the background noise floor.
6. Margin (dB) = Remark result (dBuV/m) – Average limit (dBuV/m).



Operation Mode: TX / 8DPSK / DH5 / CH High

Test Date: April 20, 2015

Temperature: 27°C

Tested by: David Shu

Humidity: 53 % RH

Polarity: Ver. / Hor.

| Frequency (MHz) | Reading (dBuV) | Correction (dB/m) | Result (dBuV/m) | Limit (dBuV/m) | Margin (dB) | Remark | Ant.Pol. (H/V) |
|-----------------|----------------|-------------------|-----------------|----------------|-------------|--------|----------------|
| 1794.000 | 56.03 | -5.97 | 50.06 | 74.00 | -23.94 | peak | V |
| N/A | | | | | | | |
| | | | | | | | |
| | | | | | | | |
| | | | | | | | |
| | | | | | | | |
| 2028.000 | 51.55 | -4.91 | 46.64 | 74.00 | -27.36 | peak | H |
| N/A | | | | | | | |
| | | | | | | | |
| | | | | | | | |
| | | | | | | | |
| | | | | | | | |

Remark:

1. Measuring frequencies from 1 GHz to the 10th harmonic of highest fundamental frequency.
2. Radiated emissions measured in frequency above 1000MHz were made with an instrument using peak/average detector mode.
3. Average test would be performed if the peak result were greater than the average limit.
4. Data of measurement within this frequency range shown “ --- ” in the table above means the reading of emissions are attenuated more than 20dB below the permissible limits or the field strength is too small to be measured.
5. Measurements above show only up to 6 maximum emissions noted, or would be lesser, with “ N/A ” remark, if no specific emissions from the EUT are recorded (ie: margin>20dB from the applicable limit) and considered that's already beyond the background noise floor.
6. Margin (dB) = Remark result (dBuV/m) – Average limit (dBuV/m).



7.9 POWERLINE CONDUCTED EMISSIONS

LIMIT

According to §15.207(a) & RSS-Gen §7.2.4, except as shown in paragraphs (b) and (c) of this section, for an intentional radiator that is designed to be connected to the public utility (AC) power line, the radio frequency voltage that is conducted back onto the AC power line on any frequency or frequencies within the band 150 kHz to 30 MHz shall not exceed the limits in the following table, as measured using a 50 μ H/50 ohms line impedance stabilization network (LISN). Compliance with the provisions of this paragraph shall be based on the measurement of the radio frequency voltage between each power line and ground at the power terminal. The lower limit applies at the boundary between the frequency ranges.

| Frequency Range (MHz) | Limits (dB μ V) | |
|--------------------------|------------------------|-----------|
| | Quasi-peak | Average |
| 0.15 to 0.50 | 66 to 56* | 56 to 46* |
| 0.50 to 5 | 56 | 46 |
| 5 to 30 | 60 | 50 |

* Decreases with the logarithm of the frequency.

Test Configuration

See test photographs attached in Appendix II for the actual connections between EUT and support equipment.

TEST PROCEDURE

1. The EUT was placed on a table, which is 0.8m above ground plane.
2. Maximum procedure was performed on the six highest emissions to ensure EUT compliance.
3. Repeat above procedures until all frequency measured were complete.



TEST RESULTS

The initial step in collecting conducted data is a spectrum analyzer peak scan of the measurement range. Significant peaks are then marked as shown on the following data page, and these signals are then quasi-peaked.

Test Data

Operation Mode: Normal Link **Test Date:** April 20, 2015
Temperature: 26°C **Tested by:** Sehni Hu
Humidity: 60% RH

| Freq. (MHz) | QP Reading (dBuV) | AV Reading (dBuV) | Corr. factor (dB/m) | QP Result (dBuV/m) | AV Result (dBuV/m) | QP Limit (dBuV) | AV Limit (dBuV) | QP Margin (dB) | AV Margin (dB) | Note |
|-------------|-------------------|-------------------|---------------------|--------------------|--------------------|-----------------|-----------------|----------------|----------------|------|
| 0.2233 | 36.98 | 29.68 | 0.06 | 37.04 | 29.74 | 62.70 | 52.70 | -25.66 | -22.96 | L1 |
| 0.3374 | 38.14 | 32.40 | 0.07 | 38.21 | 32.47 | 59.27 | 49.27 | -21.06 | -16.80 | L1 |
| 1.0062 | 40.04 | 29.34 | 0.08 | 40.12 | 29.42 | 56.00 | 46.00 | -15.88 | -16.58 | L1 |
| 1.9190 | 41.20 | 28.16 | 0.08 | 41.28 | 28.24 | 56.00 | 46.00 | -14.72 | -17.76 | L1 |
| 4.8463 | 40.71 | 24.19 | 0.13 | 40.84 | 24.32 | 56.00 | 46.00 | -15.16 | -21.68 | L1 |
| 27.9937 | 27.43 | 16.16 | 0.47 | 27.90 | 16.63 | 60.00 | 50.00 | -32.10 | -33.37 | L1 |
| 0.2249 | 40.42 | 33.60 | 0.03 | 40.45 | 33.63 | 62.64 | 52.64 | -22.19 | -19.01 | L2 |
| 0.3420 | 39.53 | 30.58 | 0.02 | 39.55 | 30.60 | 59.15 | 49.15 | -19.60 | -18.55 | L2 |
| 0.9989 | 41.05 | 29.83 | 0.03 | 41.08 | 29.86 | 56.00 | 46.00 | -14.92 | -16.14 | L2 |
| 1.6888 | 42.39 | 29.09 | 0.04 | 42.43 | 29.13 | 56.00 | 46.00 | -13.57 | -16.87 | L2 |
| 4.1499 | 40.22 | 20.88 | 0.07 | 40.29 | 20.95 | 56.00 | 46.00 | -15.71 | -25.05 | L2 |
| 4.6048 | 40.09 | 24.50 | 0.08 | 40.17 | 24.58 | 56.00 | 46.00 | -15.83 | -21.42 | L2 |

Remark:

1. Measuring frequencies from 0.15 MHz to 30MHz.
2. The emissions measured in frequency range from 0.15 MHz to 30MHz were made with an instrument using Quasi-peak detector and average detector.
3. The IF bandwidth of SPA between 0.15MHz and 30MHz was 10 kHz; the IF bandwidth of Test Receiver between 0.15MHz and 30MHz was 9 kHz;
4. L1 = Line One (Live Line) / L2 = Line Two (Neutral Line)



Test Plots

Conducted emissions (Line 1)

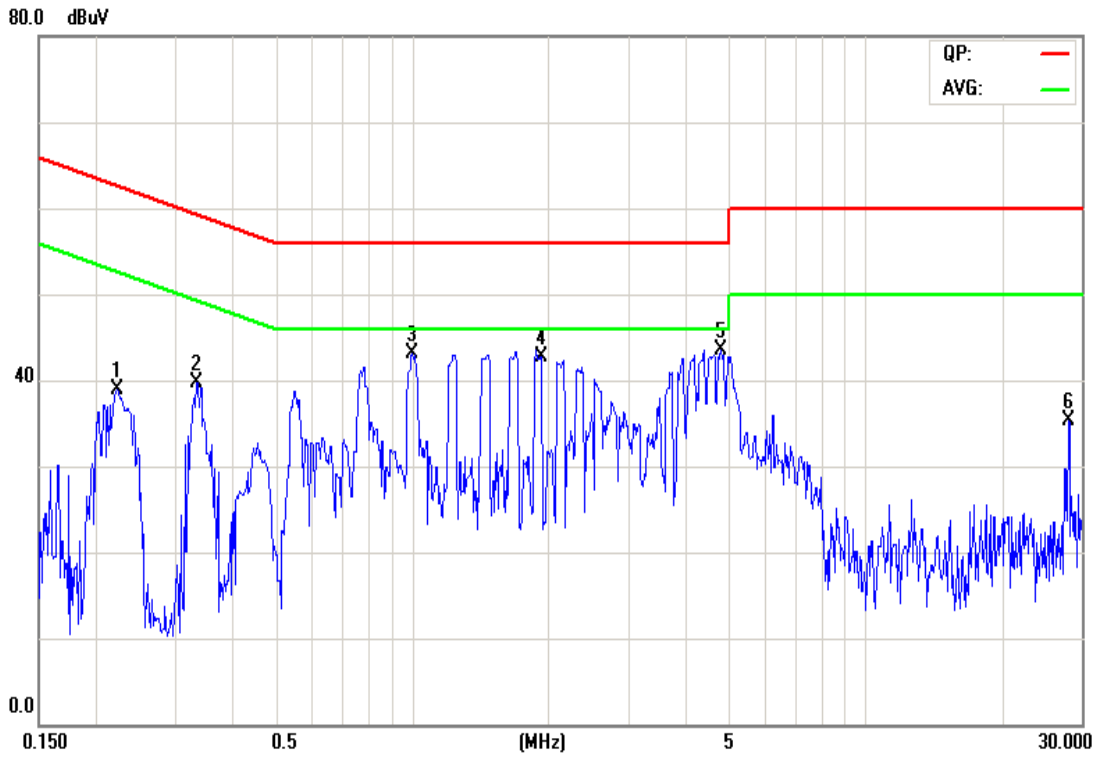

Conducted emissions (Line 2)

