

Manufacturer: Shenzhen Yaguan Antenna Connector Co., Ltd.

Antenna model: YH698-2700-SMA-192

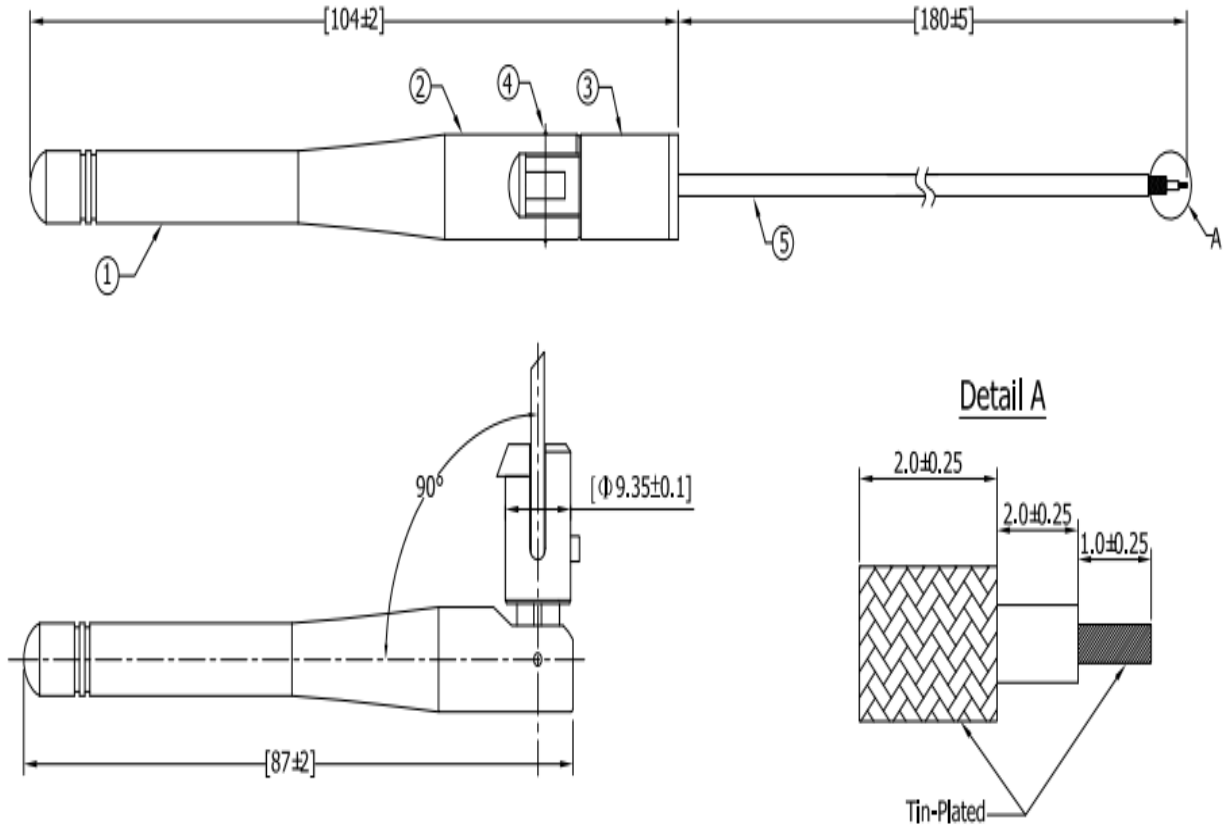

ELECTRICAL SPECIFICATIONS			MECHANICAL SPECIFICATIONS		
Product	Type	Glue stick antenna	Product	Type	Glue stick antenna
model	Type	YH698-2700-SMA-192	model	Type	YH698-2700-SMA-192
frequency range		2400-2500MHz	Height		192mm
Impedance		50Ω	Max diameter		16mm
VSWR		≤ 2.5	Min diameter		10mm
Gain		3 dBI	Connector		SMA-J
Polarization		vertical			-----
Radiation		Omnidirectional	Lighting protection		DC grounding
temperature		30C° --75C°			

2450.000MHz

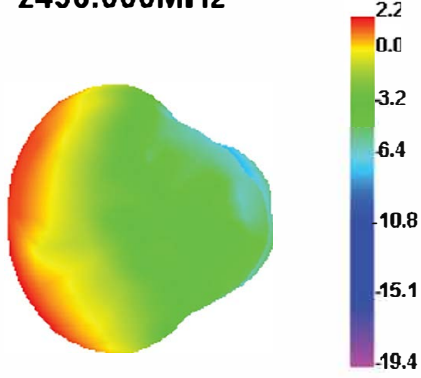

2400.000MHz H

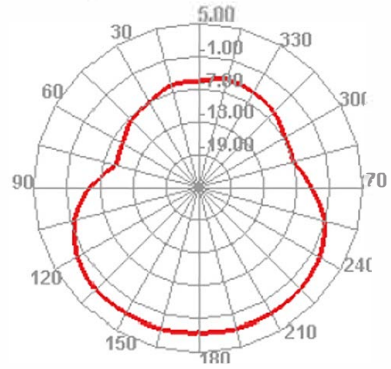

2445.000MHz E1

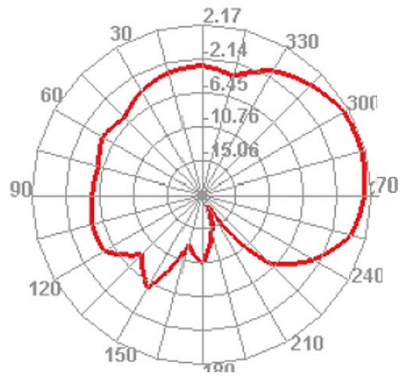

2500.000MHz E2

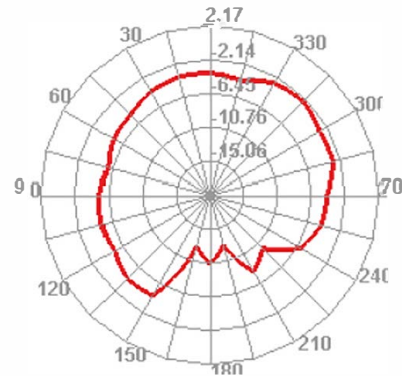

Description	5.2GHz	Units
VSWR	≤ 2.0	
Average Antenna Gain	≥ -4.5	dB
Antenna Efficiency	≥ 40	%
Feed Impedance	50 ohms	
Operating Temperature	-40 to +85 deg C	
Polarization / Azimuth	Linear / Omni-directional	

● Mechanical Information

Mechanical Dimension	
Cable Length	060mm/Black
Description	WLAN antenna
Material	FPC
Coaxial Cable	50Ohm/O.D.1.13mm
Environmental	
Operation Temperature	-40 to +85 deg C
Storage Temperature	-40 to +85 deg C

efficiency	Frequency (MHz)	VSWR
	4800	1.15
	5200	1.35

Frequency	Efficiency (%)	Average GAIN(dB)	Peak GAIN (dBi)
4850	37.62	-4.25	1.04
5200	38.12	-4.19	1.09

5200.000MHz

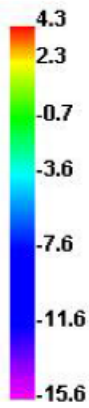
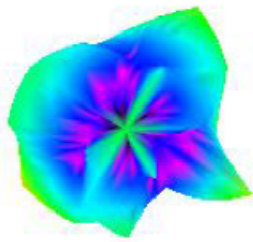

5200.000MHz H

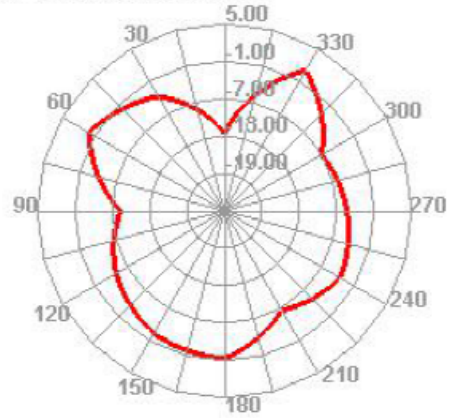

5200.000MHz E1

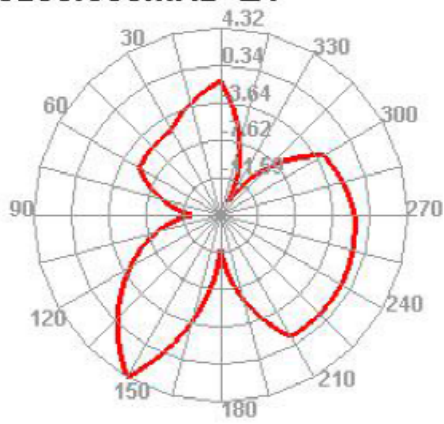

5200.000MHz E2

