**THERMAL TRANSFER / DIRECT THERMAL
BAR CODE PRINTER**

**USER'S
MANUAL**

Contents

1. Introduction	1
1.1 Product Introduction	1
1.2 Compliances	1
2. Operations Overview	3
2.1 Unpacking and Inspection	3
2.2 Printer Overview	4
2.2.1 Front View	4
2.2.2 Interior view	5
2.2.3 Rear View	6
2.3 Operator Controls	7
2.3.1 Front Panel Display	7
2.3.2 LED Indicators	7
2.3.3 Front Panel Keys	8
2.4 Setting Up the Printer	8
2.5 Installation of Ribbon	9
2.5.1 Loading Ribbon	9
2.6 Installation of Media	12
2.6.1 Loading Roll Labels	12
3. Menu Function	14
3.1 Setup Menu Overview	15
3.1.1 Printer Setup	16
3.1.2 Sensor	23
3.1.3 Serial Comm.	31
3.1.4 Ethernet	34
3.2 File Manager	37
3.2.1 File List	37
3.2.2 Avail. Memory	37
3.2.3 Del. All Files	38
3.3 Diagnostics	39
3.3.1 Print Config.	39
3.3.2 Dump Mode	40
3.3.3 Rotate Cutter	41
3.4 Language	41
3.5 Service	42
3.5.1 Initialization	42

3.5.2 Mileage Info	43
4. Diagnostic Tool	44
4.1 Start the Diagnostic Tool	44
4.2 Printer Function (Calibrate sensor, Ethernet setup, RTC setup.....)	45
5. Troubleshooting	46
5.1 Common Problems	46
6. Maintenance	50
Revise History	52

1. Introduction

1.1 Product Introduction

Thank you very much for purchasing TSC bar code printer.

This printer is designed with die-casting aluminum chassis and print mechanism, metal cover with large clear media view window, which ensuring to work for the extreme and heavy duty industrial environment and applications.

With back-lit graphic LCD display, printer status can be managed easier and operated more user friendly. The moveable sensor design can accept wide range of label media. All of the most frequently used bar code formats are included. Fonts and bar codes can be printed in any one of the four directions. This printer is built-in the high quality, high performance MONOTYPE IMAGING® True Type font engine and one CG Triumvirate Bold Condensed smooth font. With flexible firmware design, user can also download the True Type Font from PC into printer memory for printing labels. Besides the scalable font, it also provides a choice of five different sizes of alphanumeric bitmap font, OCR-A and OCR-B fonts. By integrating rich features, it is the most cost-effective and high performance printer in its class!

1.2 Compliances

CE Class A:

EN55022:1998+A1:2000+A2:2003:

EN55024:1998+A1:2001+A2:2003:

EN 61000-4 SERIES REGULATIONS

ETSI EN 301 489-17:V1.2.1(2002-08)

FCC:

CFR 47, Part 15/CISPR 22 3RD EDITION:1997, Class A

This device complies with Part 15 of the FCC Rules.
Operation is subject to the following two conditions.
(1) This device may not cause harmful interference, and
(2) This device must accept any interference received,
including interference that may cause undesired operation.

UL, CUL

UL 60950 3rd

TÜV-GS:

EN60950: 2000

Federal Communication Commission Interference Statement

This equipment has been tested and found to comply with the limits for a Class B digital device, pursuant to Part 15 of the FCC Rules. These limits are designed to provide reasonable protection against harmful interference in a residential installation. This equipment generates, uses and can radiate radio frequency energy and, if not installed and used in accordance with the instructions, may cause harmful interference to radio communications. However, there is no guarantee that interference will not occur in a particular installation. If this equipment does cause harmful interference to radio or television reception, which can be determined by turning the equipment off and on, the user is encouraged to try to correct the interference by one of the following measures:

- Reorient or relocate the receiving antenna.
- Increase the separation between the equipment and receiver.
- Connect the equipment into an outlet on a circuit different from that to which the receiver is connected.
- Consult the dealer or an experienced radio/TV technician for help.

This device complies with Part 15 of the FCC Rules. Operation is subject to the following two conditions:

- (1) This device may not cause harmful interference, and
- (2) This device must accept any interference received, including interference that may cause undesired operation.

INFORMATION TO USER

To assure continued compliance, (example - use only shielded interface cables when connecting to computer or peripheral devices) any changes or modifications not expressly approved by the party responsible for compliance could void the user's authority to operate this equipment.

Wichtige Sicherheits-Hinweise

1. Bitte lesen Sie Diese Hinweis sorgfältig durch
2. Heben Sie diese Anleitung für den späteren Gebrauch auf.
3. Vor jedem Reinigen ist das Gerät vom Stromnetz zu trennen. Verwenden Sie Keine Flüssig-oder Aerosolreiniger. Am besten eignet sich ein angefeuchtetes Tuch zur Reinigung.
4. Die Netzanschlußsteckdose soll nahe dem Gerät angebracht und leicht zugänglich sein.
5. Das Gerät ist vor Feuchtigkeit zu schützen.
6. Bei der Aufstellung des Gerätes ist auf sicheren Stand zu achten. Ein Kippen oder Fallen könnte Beschädigungen hervorrufen.
7. Beachten Sie beim Anschluß an das stromnetz die Anschlußwerte.
8. Dieses das Gerät kann bis zu einer Außentemperatur von maximal 40°C betrieben werden.

(CAUTION: Danger of explosion if battery is incorrectly replaced. Replace only with the same or equivalent type recommended by the manufacturer. Dispose of used batteries according to the manufacturer instructions.)

"ORSICHT"

Explosionsgetahr bei unsachgemem Austausch der Batterie. Ersatz nur durch denselben oder einem vom Hersteller empfohlenem nlichen Typ. Entsorgung gebrauchter Batterien nach Angaben des Herstellers.

2. Operations Overview

2.1 Unpacking and Inspection

This printer has been specially packaged to withstand damage during shipping. Please carefully inspect the packaging and printer upon receiving the bar code printer. Please retain the packaging materials in case you need to reship the printer.

Unpacking the printer, the following items are included in the carton.

- One printer unit
- One Windows labeling software/Windows driver CD disk
- One quick installation guide
- One power cord
- One USB interface cable

If any parts are missing, please contact the Customer Service Department of your purchased reseller or distributor.

2.2 Printer Overview

2.2.1 Front View



1. LED indicators
2. LCD display
3. Front panel buttons
4. Paper exit chute
5. Printer right side cover
6. Cutter module (Option)

2.2.2 Interior view

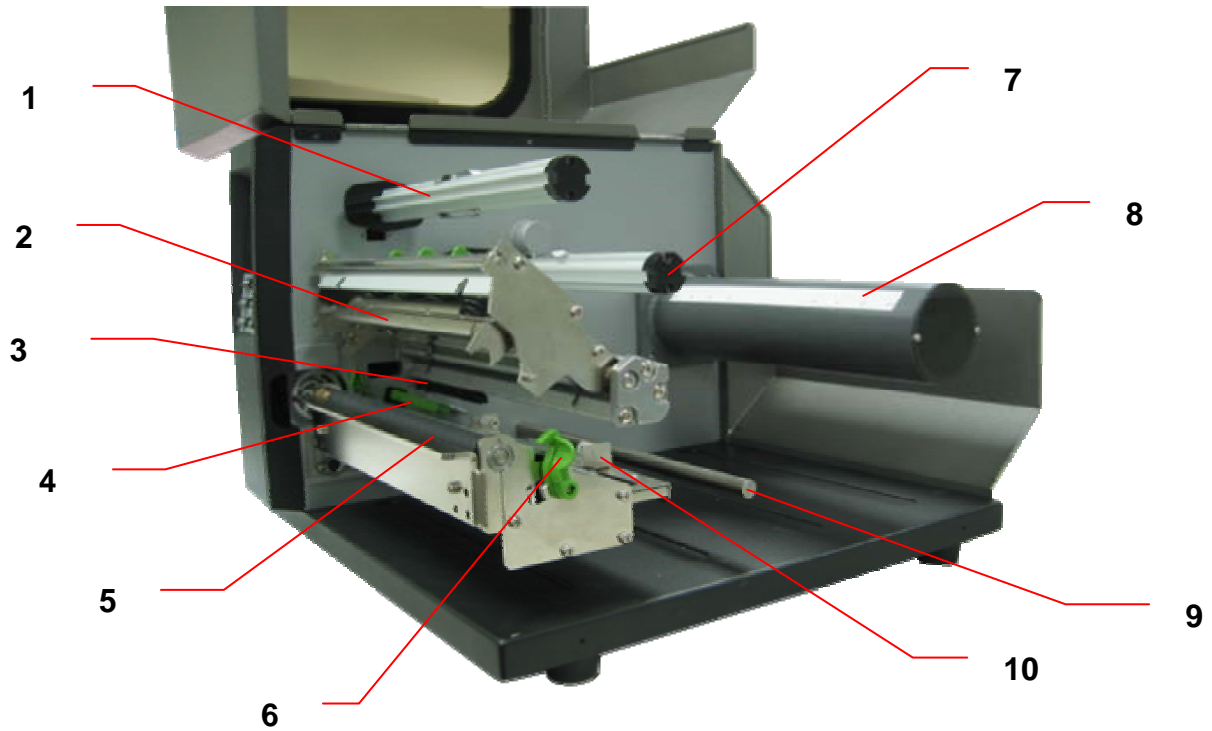

1. Ribbon rewind spindle
2. Print head
3. Ribbon sensor
4. Media sensor
5. Platen roller
6. Print head release lever
7. Ribbon supply spindle
8. Label supply spindle
9. Media guide bar
10. Label guide

2.2.3 Rear View

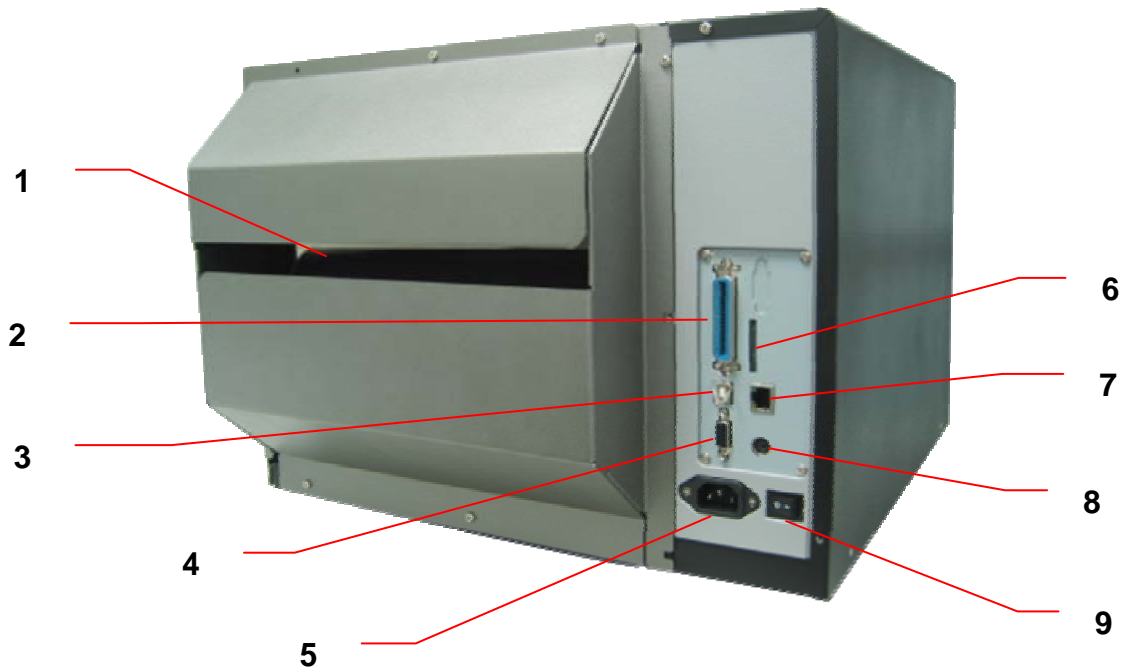

1. Fan-fold paper entrance chute
2. Centronics interface
3. USB interface
4. RS-232C interface
5. Power jack socket
- *6. SD card slot
7. Ethernet interface
8. PS/2 interface
9. Power switch

* Recommended SD card specification.

SD V 1.0, V 1.1	SD V 2.0 (SDHC)
✓ 128MB	✓ 4GB class 6
✓ 256MB	
✓ 512MB	
✓ 1GB	
-Supported DOS FAT file system. -Folders stored on the SD card should be in the 8.3 filename format. -Approved SD card manufacturer: SanDisk, Transcend.	

2.3 Operator Controls



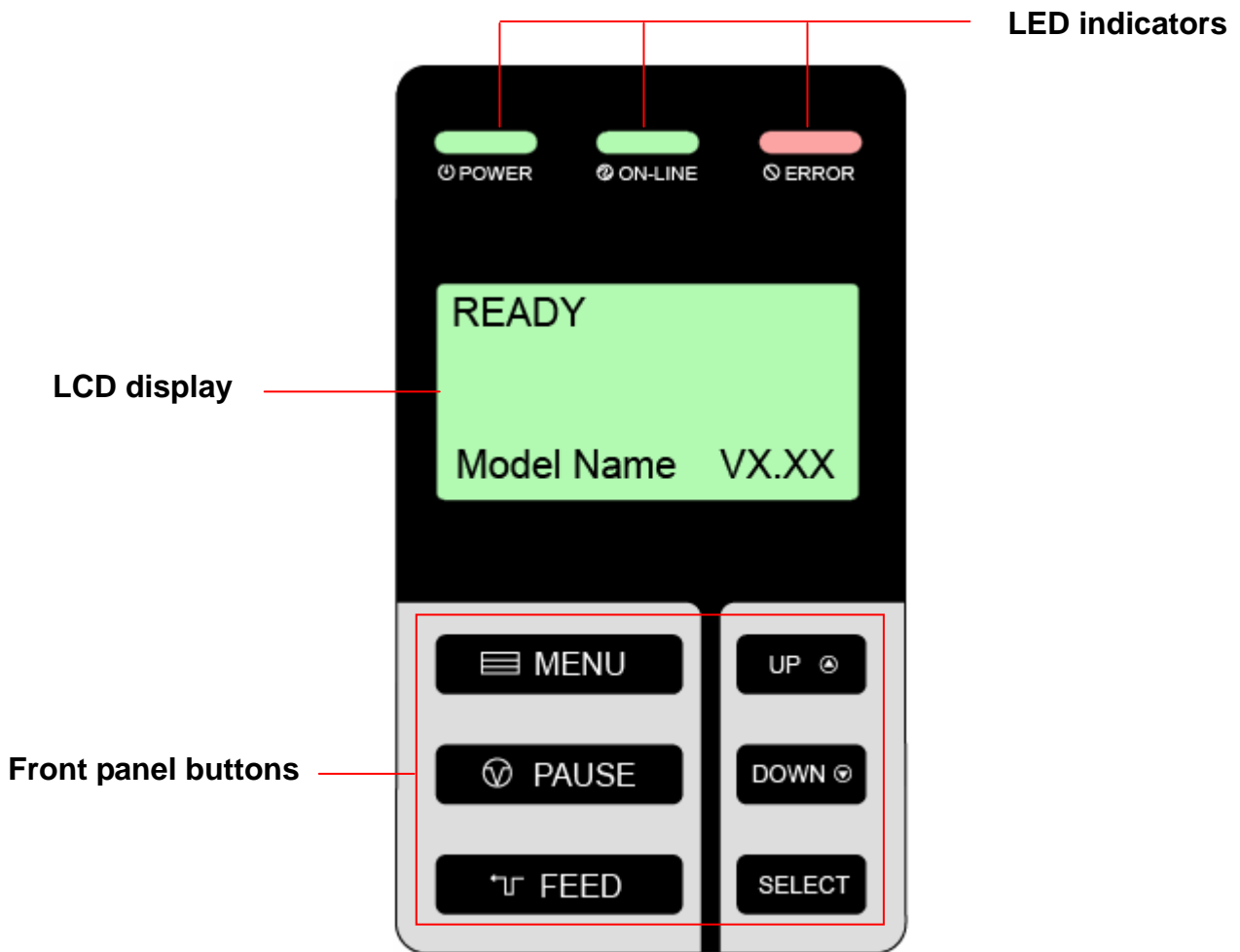

2.3.1 Front Panel Display



2.3.2 LED Indicators

LED	Status	Indication
⏻ POWER	Off	The printer power is turned off
	On	The printer power is turned on
🟢 ON-LINE	On	Printer is ready
	Blinking	Pause Downloading data into printer.
🔴 ERROR	Off	Printer is ready
	On	"CARRIAGE OPEN" or "CUTTER ERROR"
	Blinking	"NO PAPER", "PAPER JAM" or "NO RIBBON"

2.3.3 Front Panel Keys

Keys	Function
 MENU	1. Enter the menu 2. Exit from a menu or cancel a setting and return to the previous menu
 PAUSE	Pause/Resume the printing process
 FEED	Advance one label
UP 	Scroll up the menu list
DOWN 	Scroll down the menu list
SELECT	Enter/Select cursor located option

2.4 Setting Up the Printer

1. Place the printer on a flat, secure surface.
2. Make sure the power switch is off.
3. Connect the printer to the computer with the provided USB cable.
4. Plug the power cord into the AC power cord socket at the rear of the printer, and then plug the power cord into a properly grounded power outlet.

2.5 Installation of Ribbon

2.5.1 Loading Ribbon

1. Lift open printer right side cover.
2. Push the print head release lever to open the print head mechanism.

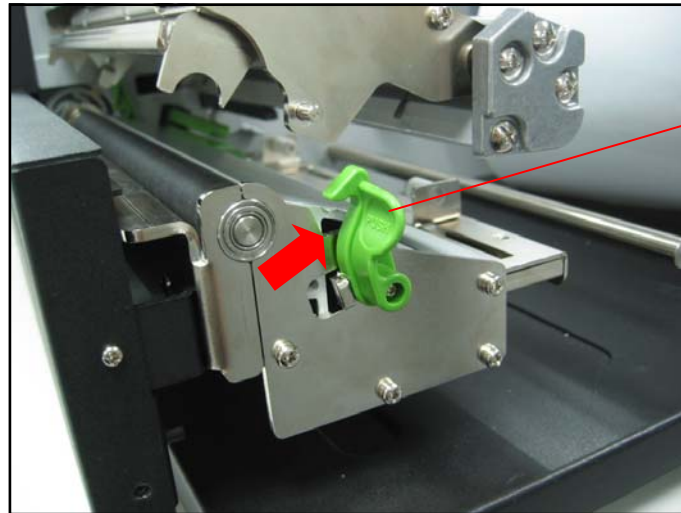

Print head
release lever

3. Install the ribbon onto the ribbon supply spindle.

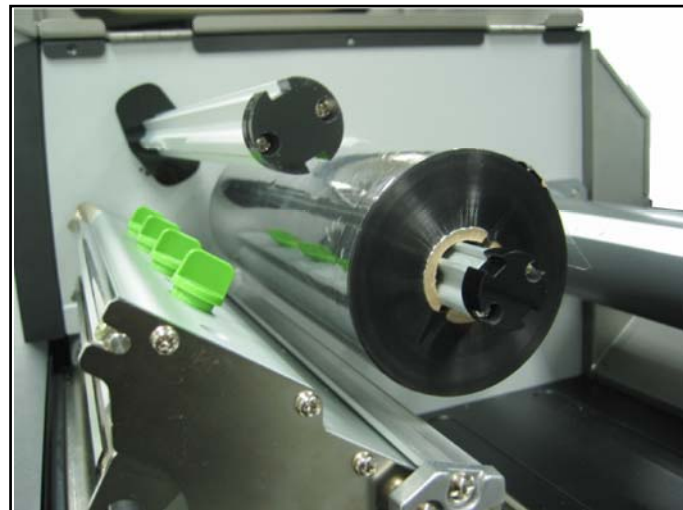

4. Place a paper core onto the ribbon rewind spindle.

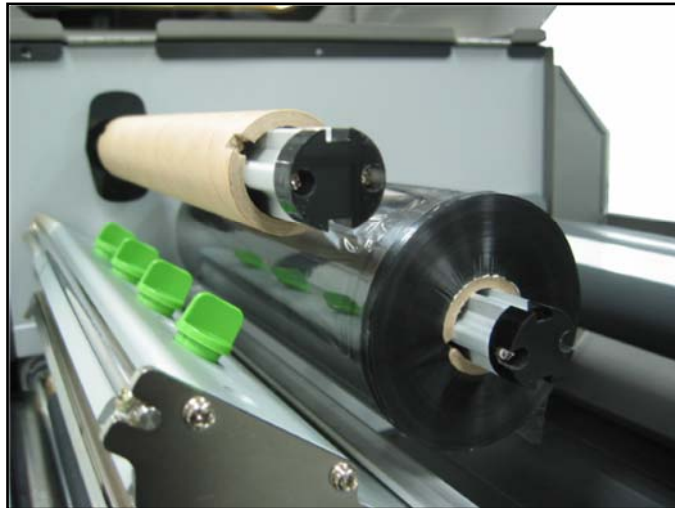

5. Thread the ribbon through the ribbon sensor slot and then through the open space in between print head and platen.

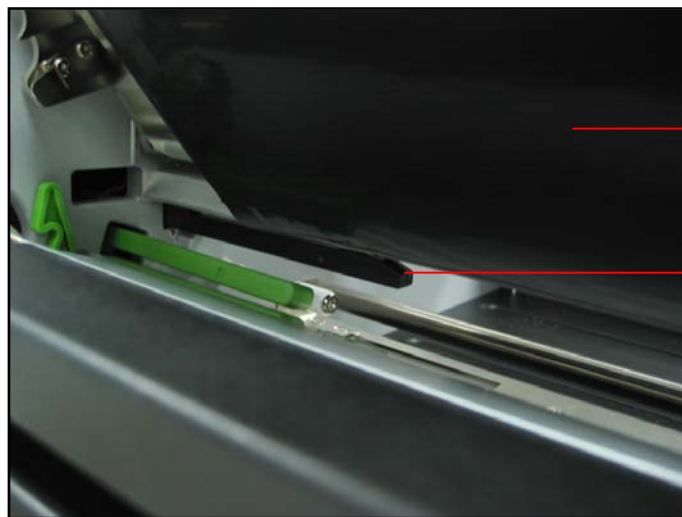

Ribbon

Ribbon
sensor

5. Stick the ribbon onto the ribbon rewind paper core. Keeping the ribbon flat and without wrinkles.
6. Wind the ribbon clockwise about 5~10 circles onto the ribbon rewind spindle until it is smooth and properly stretched.

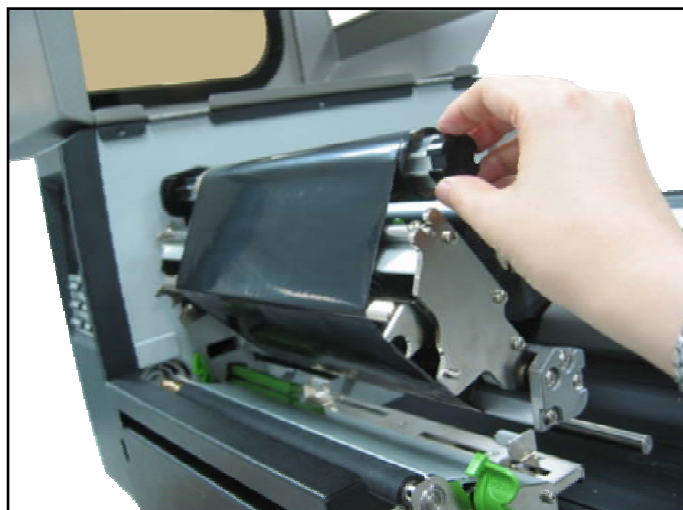

7. Close the print head mechanism making sure the latches are engaged properly.

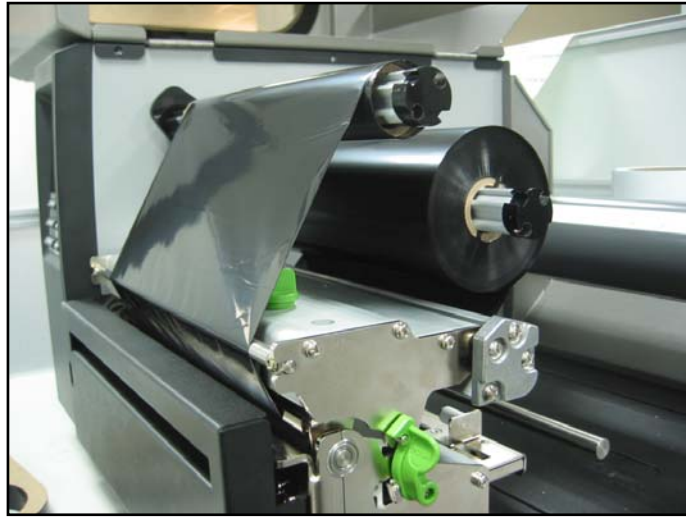

2.6 Installation of Media

2.6.1 Loading Roll Labels

1. Lift open printer right side cover.
2. Push the print head release lever to open the print head mechanism.

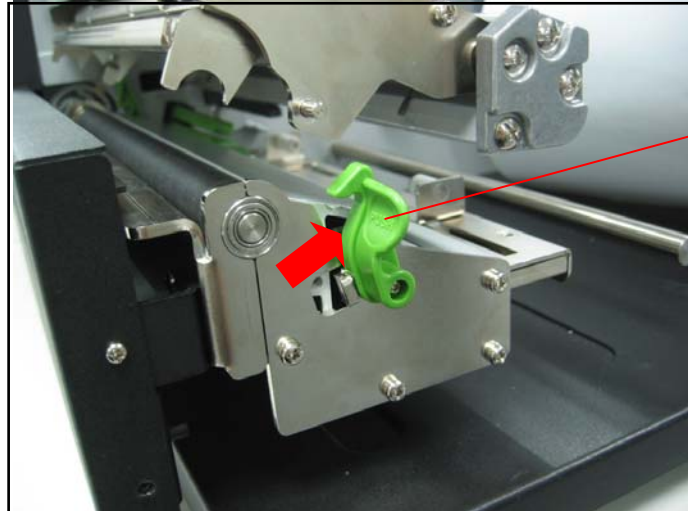

Print head
release lever

2. Insert a media holder guide and a roll of media into the label supply spindle.
3. Place another media holder guide into the label supply spindle and make sure the media is set on the center of spindle.

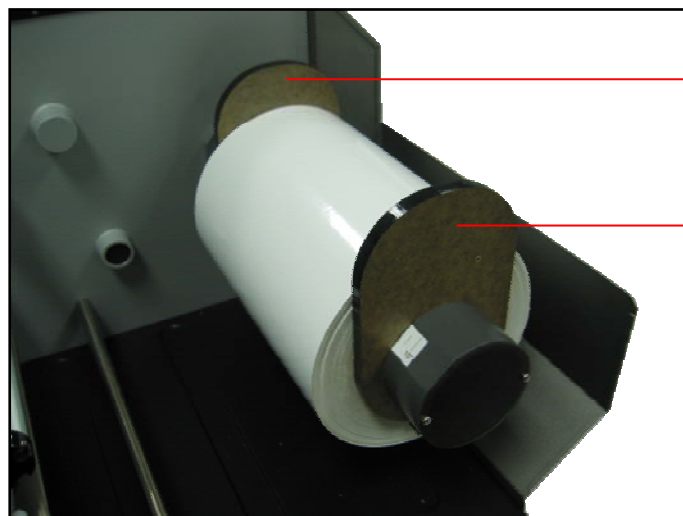

Media holder
guide

4. Pull label roll leading edge forward through the media guide bar, label guide, media sensor and place the label leading edge onto the platen roller.

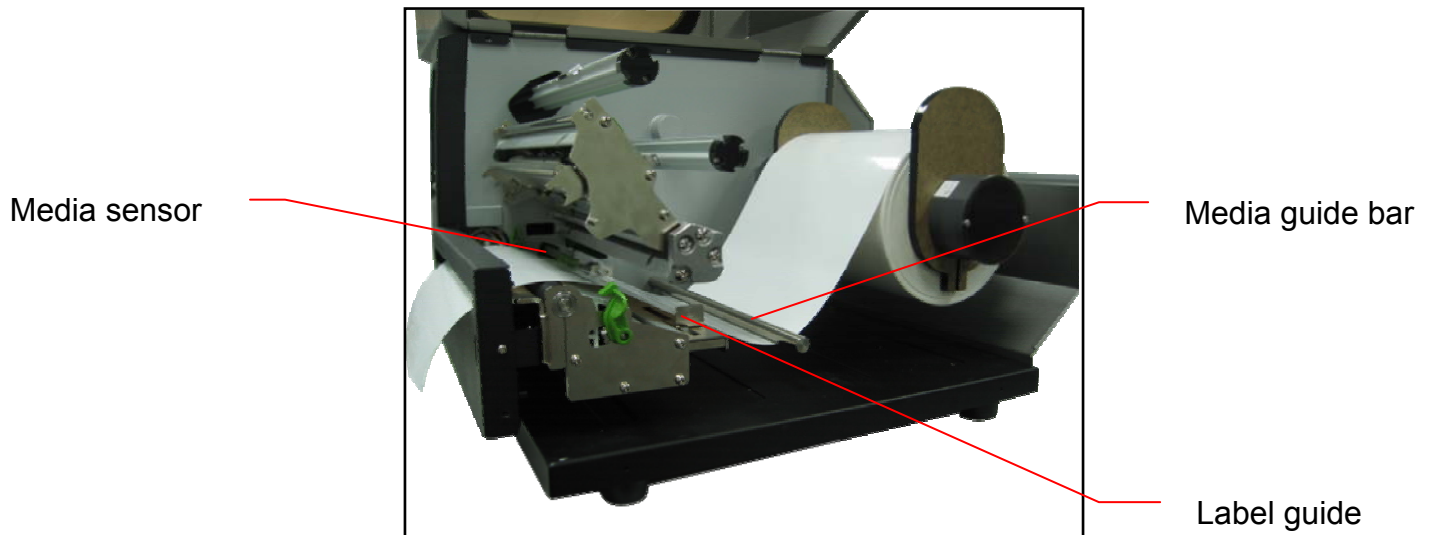

5. Adjust the label guide to fit the width of the label.
6. Close the print head mechanism making sure the latches are engaged properly.

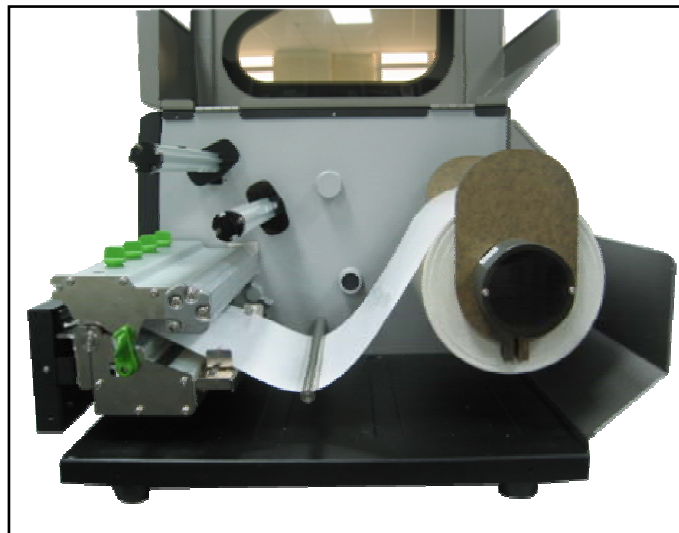

7. Using the front display panel, set the media sensor type and calibrate the selected sensor.

Note: Please calibrate the gap/black mark sensor when changing media.

3. Menu Function

Main Menu Overview

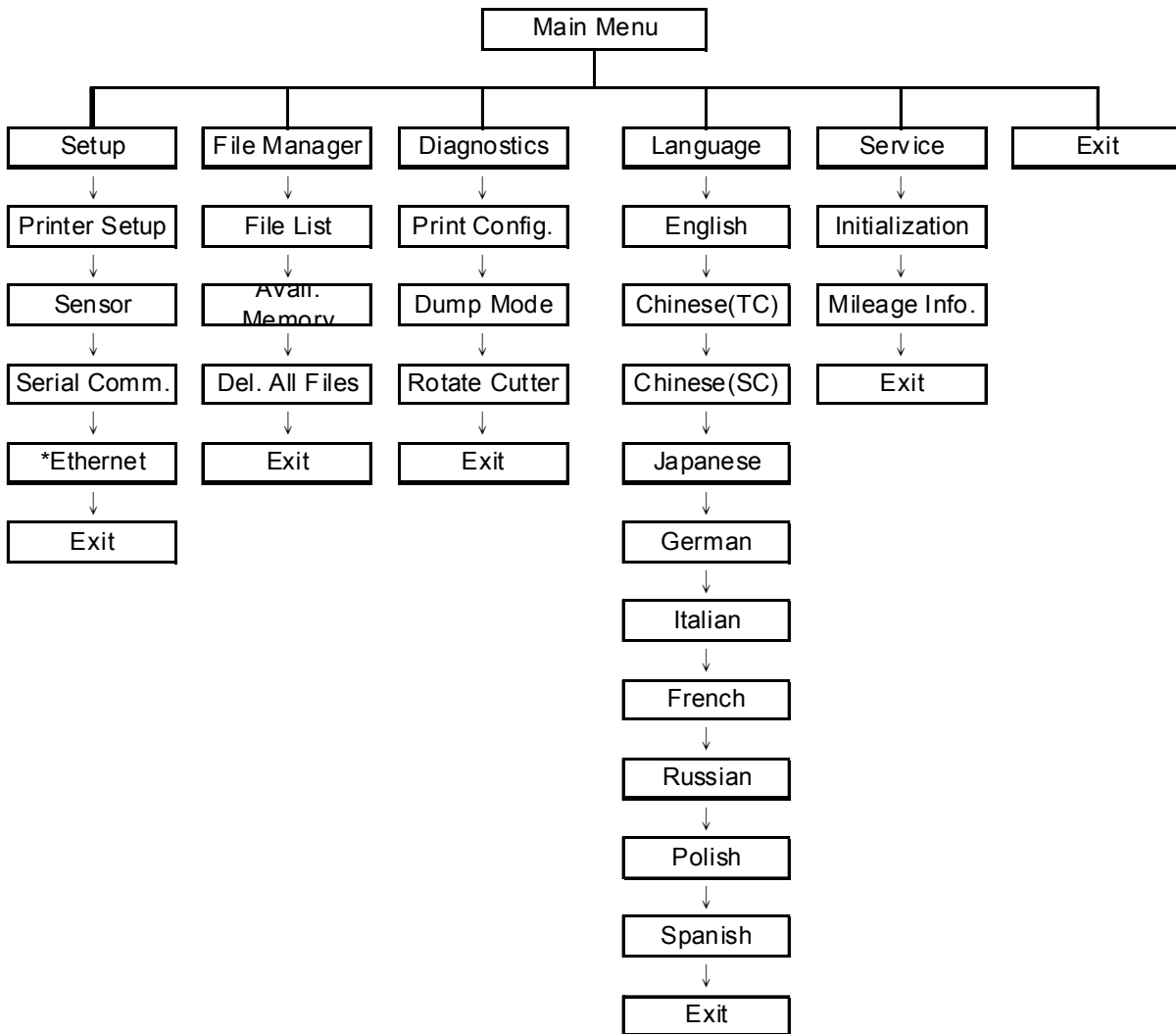

Notice:

* The Ethernet function is available for TTP-2410M series only and option for TTP-246M Plus series.

* Ethernet function is available on the LCD display when Ethernet card is installed.

3.1 Setup Menu Overview

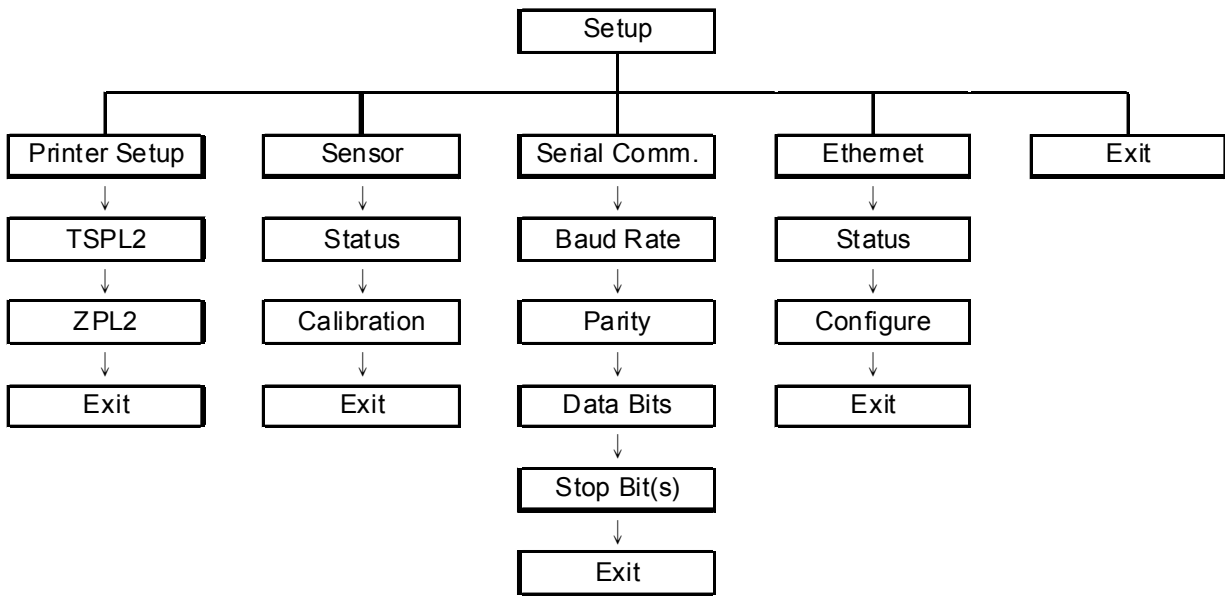

Notice:

- * The Ethernet function is available for TTP-2410M series only and option for TTP-246M Plus series.
- * Ethernet function is available on the LCD display when Ethernet card is installed.

3.1.1 Printer Setup

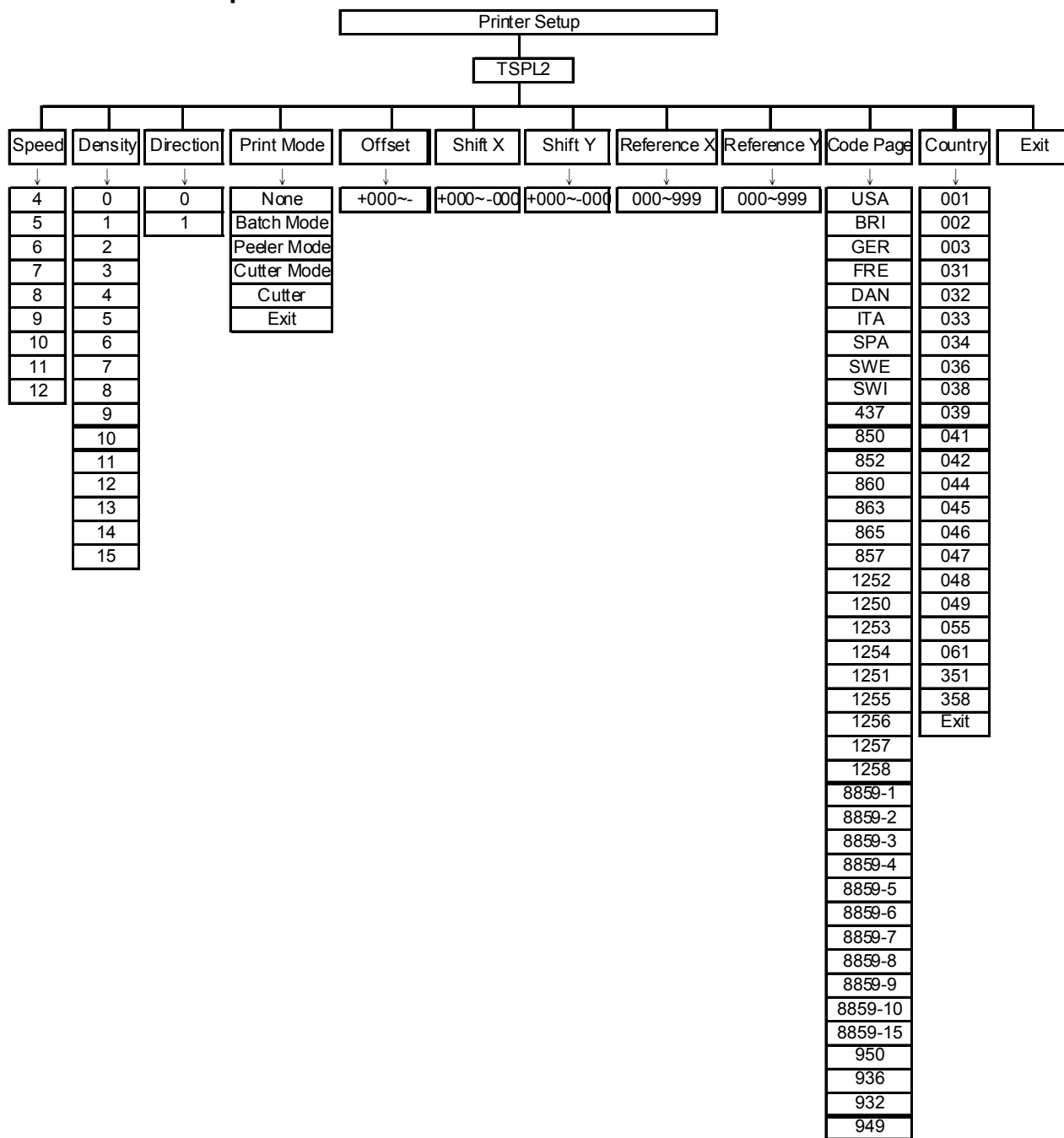

3.1.1.1 Speed:

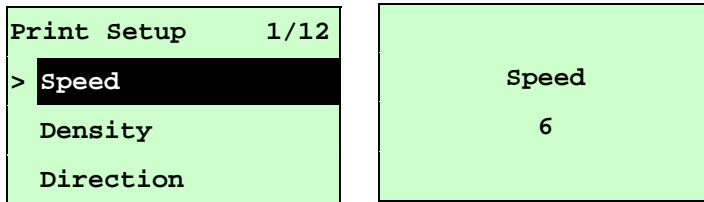

Use this option to setup print speed. The available print speed is between 4~12 ips and each increment/decrement is 1 ips. The default print speed is 6 ips.

Press **UP** ⬆ key to raise the print speed, and press **DOWN** ⬇ key to decrease print speed. Press **SELECT** key to set it into printer. Press **MENU** key to cancel the setting and return to the previous menu.

Note: If printing from enclosed software/driver, the software/driver will send out the SPEED command, which will overwrite the setting set from the front panel.

3.1.1.2 Density:

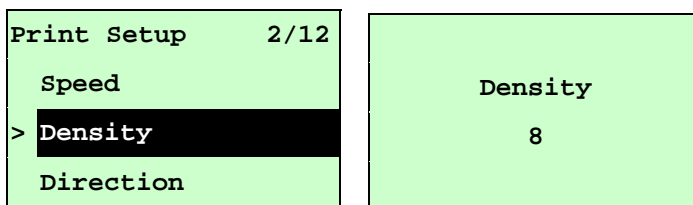

Use this option to setup printing darkness. The available setting is from 0 to 15, and the step is 1. Printer default density is 8. You may need to adjust your density based on selected media.

Press **UP** ⬆ and **DOWN** ⬇ to increase/decrease the printing darkness. Press **SELECT** key to enable the setting. Press **MENU** key to cancel the setting and return to the previous menu.

Note: If printing from enclosed software/driver, the software/driver will send out the DENSITY command, which will overwrite the setting set from the front panel.

3.1.1.3 Direction:

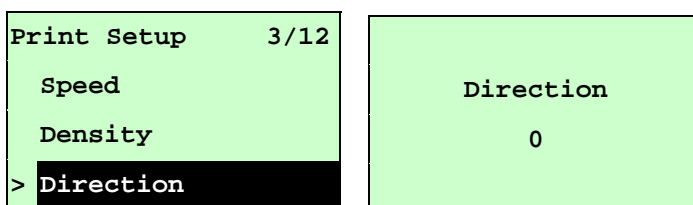

The direction setting value is either 1 or 0. Use this option to setup the printout direction. Printer default printout direction is DIRECTION 0.

Press **UP** ⬆ key to set the direction as 1, and **DOWN** ⬇ to set it as 0, and

SELECT key to enable the setting. Press **MENU** key to cancel the setting and return to the previous menu.

The following 2 figures are the printouts of DIRECTION 0 and 1 for your reference.

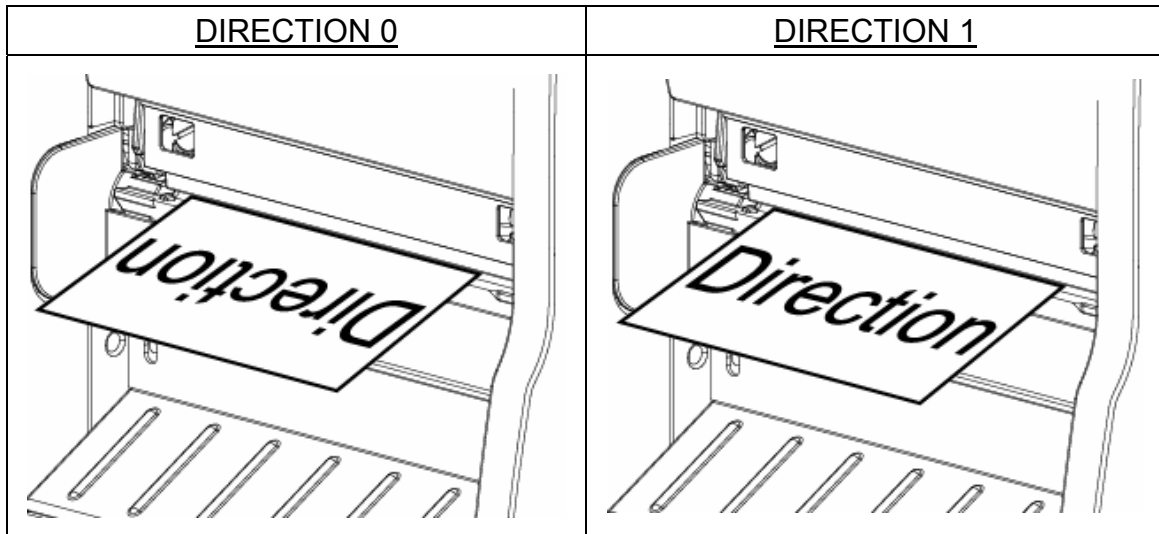

Note: If printing from enclosed software/driver, the software/driver will send out the command, which will overwrite the setting set from the front panel.

3.1.1.4 Print Mode: (None/Batch Mode/Peeler Mode/Cutter Mode/Cutter Batch)

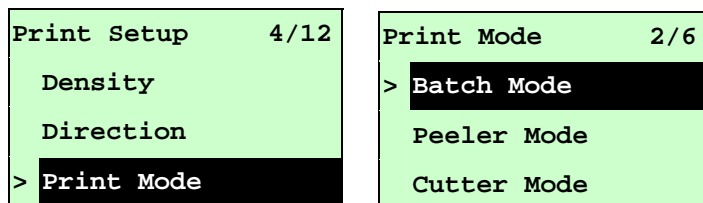

This option is used to set the print mode. Printer default setting is Batch Mode. When enter this list, the print mode in the right side of ">" icon is the printer current setting. Press **UP** and **DOWN** to select the different print mode and press **SELECT** button to enable the setting. Press **MENU** key to cancel the setting and return to the previous menu.

Printer Mode	Description
None	Next label top of form is aligned to the print head burn line location. (Tear Off Mode)
Batch Mode	Once image is printed completely, label gap/black mark will be fed to the tear plate location for tear away.
Peeler Mode	Enable the label peel off mode.

Cutter Mode	Enable the label cutter mode.
Cutter Batch	Cut the label once at the end of the printing job.

Note: If printing from enclosed software/driver, the software/driver will send out the command, which will overwrite the setting set from the front panel.

3.1.1.5 Offset:

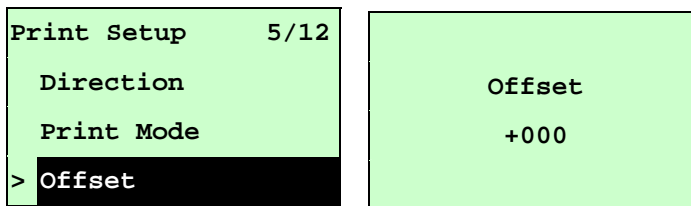

This option is used to fine tune media stop location. Press the **DOWN** Ⓞ button to move the cursor from left digit to right digit, and press the **UP** Ⓞ button to set the value from “+” to “-” or “0” to “9”. Press the **SELECT** button to set the value into printer. Press **MENU** key to cancel the setting and return to the previous menu. The default value is +000.

Note: If printing from enclosed software/driver, the software/driver will send out the OFFSET command, which will overwrite the setting set from the front panel.

3.1.1.6 Shift X & Shift Y:

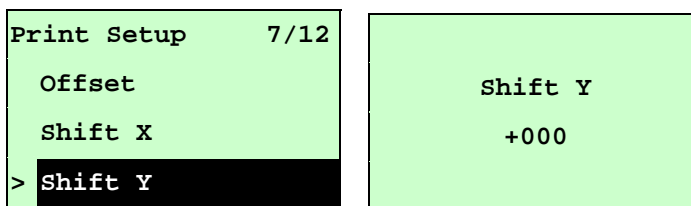

This option is used to fine tune print position. Press the **DOWN** Ⓞ button to move the cursor from left digit to right digit, and press the **UP** Ⓞ button to set the value from “+” to “-” or “0” to “9”. Press the **SELECT** button to set the value into printer. Press **MENU** key to cancel the setting and return to the previous menu. The default value is +000.

Note: If printing from enclosed software/driver, the software/driver will send out the SHIFT command, which will overwrite the setting set from the front panel.

3.1.1.6 Reference X & Reference Y:

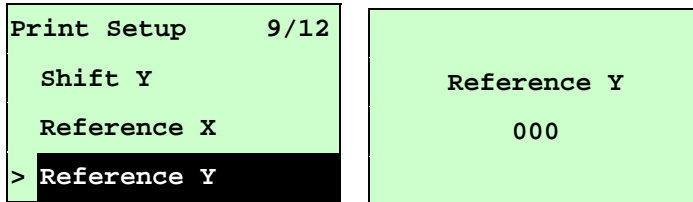

This option is used to set the origin of printer coordinate system horizontally and vertically. Press the **DOWN** Ⓞ button to move the cursor from left digit to right digit, and press the **UP** Ⓞ button to set the value from “0” to “9”. Press the **SELECT** button to set the value into printer. Press **MENU** key to cancel the setting and return to the previous menu. The default value is 000.

Note: If printing from enclosed software/driver, the software/driver will send out the REFERENCE command, which will overwrite the setting set from the front panel.

3.1.1.7 Code Page:

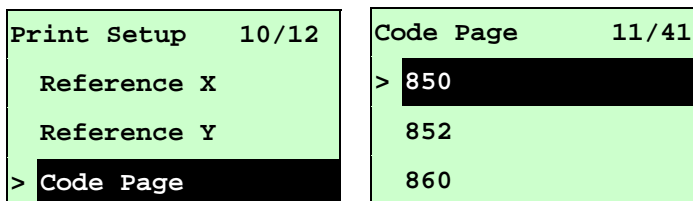

Use this option to set the code page of international character set. For more information about code page, please to refer the programming manual.

When enter the code page list, the code page in the right side of ">" icon is the printer current setting.

Press the **UP** Ⓞ and **DOWN** Ⓞ to select the code page, and press the **SELECT** button to enable the setting. Press **MENU** key to cancel the setting and return to the previous menu.

Note: If printing from enclosed software/driver, the software/driver will send out the command, which will overwrite the setting set from the front panel.

7-bit		8-bit	
code page name	International Character Set	code page number	International Character Set
USA	USA	437	United States
BRI	British	850	Multilingual
GER	German	852	Slavic
FRE	French	860	Portuguese
DAN	Danish	863	Canadian/French
ITA	Italian	865	Nordic

SPA	Spanish		
SWE	Swedish		
SWI	Swiss		

Windows Code Page (SBCS)		Windows Code Page (DBCS)	
code page number	International Character Set	code page number	International Character Set
1252	Latin 1	950	Traditional Chinese Big5
1250	Central Europe	936	Simplified Chinese GBK
1253	Greek	932	Japanese Shift-JIS
1254	Turkish	949	Korean
1251	Cyrillic		
1255	Hebrew		
1256	Arabic		
1257	Baltic		
1258	Vietnam		

ISO Code Page		ISO Code Page	
code page name	International Character Set	code page number	International Character Set
8859-1	Latin 1	8859-7	Greek
8859-2	Latin 2	8859-9	Turkish
8859-3	Latin 3	8859-10	Latin 6
8859-4	Baltic	8859-15	Latin 9
8859-5	Cyrillic		

3.1.1.8 Country:

Print Setup 11/12	Country 1/23
Reference Y	> 001
Code Page	002
> Country	003

Use this option to set the country code for the LCD display. Press the **UP** ⬆ and **DOWN** ⬇ to select the country code, and press the **SELECT** button to set the value into printer. When enter this list, the country code in the right side of ">" icon

is the printer current setting. Press  **MENU** key to cancel the setting and return to the previous menu.

Code	Country	Code	Country	Code	Country	Code	Country
001	USA	034	Spanish (Spain)	044	United Kingdom	055	Brazil
002	Canadian-French	036	Hungarian	045	Danish	061	English (International)
003	Spanish (Latin America)	038	Yugoslavian	046	Swedish	351	Portuguese
031	Dutch	039	Italian	047	Norwegian	358	Finnish
032	Belgian	041	Switzerland	048	Polish		
033	French (France)	042	Slovak	049	German		

3.1.2 Sensor

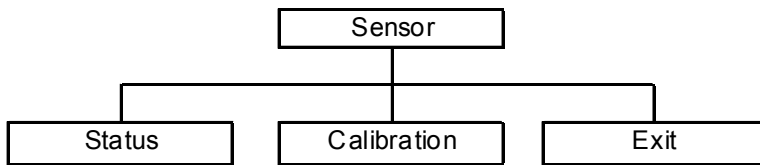

3.1.2.1 Status

This function is available to check the printer's sensor status. When enter the [Status] option, you will see following message.

Paper Len.	812
Gap Size	24
Intensity	3
Ref. Level	512

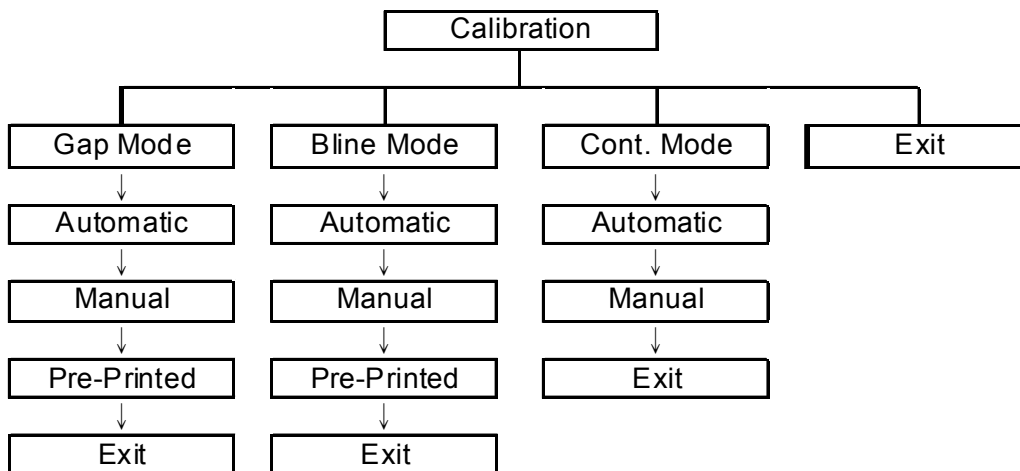

3.1.2.2 Calibration

This option is used to set the media sensor type and calibrate the selected sensor. We recommend to calibrate the sensor before printing when changing the media.

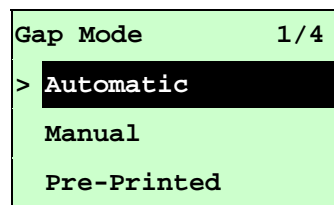
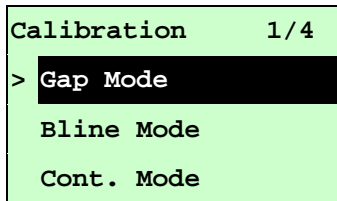

A. Gap Mode



Press the **UP**  and **DOWN**  buttons to scroll the cursor to the media type and press the **SELECT** button to enter the sensor calibration mode.

Note: If printing from enclosed software/driver, the software/driver will send out the GAP or BLINE command, which will overwrite the sensor type setting set from the front panel.

A-1 Automatic

When enter the [Automatic] option, you will see following message, and printer will feed 2 to 3 gap labels to calibrate the sensor sensitivity automatically. When calibration is completed, the LCD screen will return to the previous menu.

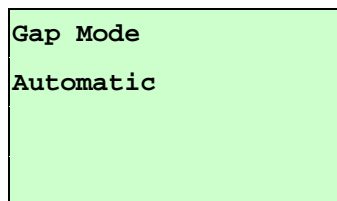

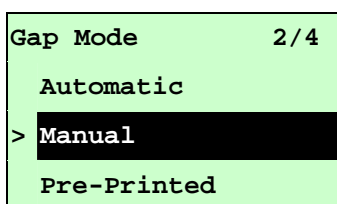

A-2 Manual

In case “Automatic” sensor calibration cannot apply to the media, please use “Manual” function to calibrate the gap sensor manually.

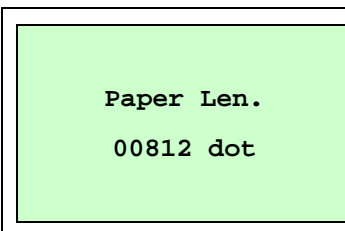

When enter [Manual] option, you will see following message. Please complete there steps :

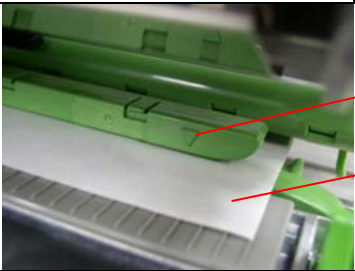
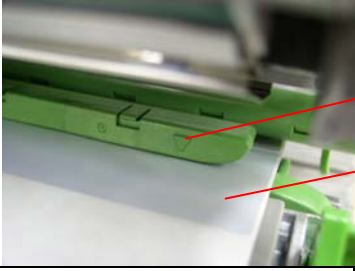

1. Press the **DOWN**  button to move the cursor from left digit to right digit, and press the **UP**  button to set the value from “0” to “9” and the “dot/mm/ inch”. Press the **SELECT** button to set the paper length into the printer.

<p>Gap Size 0024 dot</p>	<p>2. Press the DOWN ⬇️ button to move the cursor from left digit to right digit, and press the UP ⬆️ button to set the value from “0” to “9” and the “dot/mm/ inch”. Press the SELECT button to set the gap size into the printer.</p>
<p>Gap Mode Scan Backing Intensity x Ref. Level xxx</p>	<p>3. Open the print head mechanism, put the label backing (liner) under the media sensor. Press the SELECT button to set the value into the printer.</p>
	<p>Media sensor Label backing (liner)</p>
<p>Gap Mode Scan Paper Intensity x Ref. Level xxx</p>	<p>4. Then, Put the label with liner under the media sensor. Press the SELECT button to set the value into the printer.</p>
	<p>Media sensor Label with liner</p>
<p>Gap Mode Complete Intensity x Ref. Level xxx</p>	<p>5. The gap sensor calibration is complete. Press the SELECT button the LCD screen will return to the previous menu.</p>

A-3 Pre-Printed

This function can set the paper length and gap size before auto-calibrate the sensor sensitivity. It can to get the sensor sensitivity accurately.

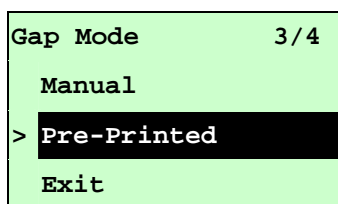



When enter [Pre-Printed] option, you will see following message. Please

complete these steps :

<p>Paper Len. 00812 dot</p>	<p>1. Press the DOWN ⬇️ button to move the cursor from left digit to right digit, and press the UP ⬆️ button to set the value from "0" to "9" and the "dot/mm/ inch". Press the SELECT button to set the paper length into the printer.</p>
<p>Gap Size 0024 dot</p>	<p>2. Press the DOWN ⬇️ button to move the cursor from left digit to right digit, and press the UP ⬆️ button to set the value from "0" to "9" and the "dot/mm/ inch". Press the SELECT button to set the gap size into the printer.</p>
<p>Gap Mode Pre-Printed</p>	<p>3. Then, printer will feed labels to calibrate the sensor sensitivity automatically. When calibration is completed, the LCD screen will return to the previous menu.</p>

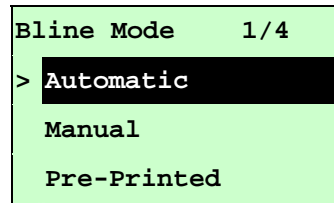
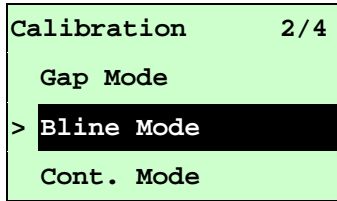
B. Bline Mode



Press the **UP**  and **DOWN**  buttons to scroll the cursor to the sensor type. Press the **SELECT** button to enter the black-mark sensor calibration mode.

B-1 Automatic

When enter the [Automatic] option, you will see following message and printer will feed the black mark label to calibrate the sensor sensitivity automatically. When calibration process is completed, the LCD screen will return to the previous menu.

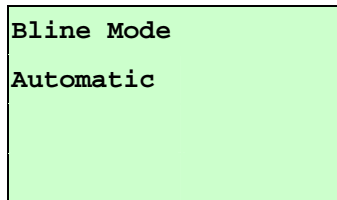





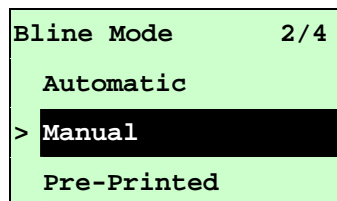

B-2 Manual

In case “Automatic” sensor calibration cannot apply to the media, please use “Manual” function to calibrate the bline sensor manually.

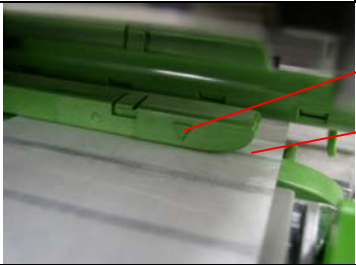
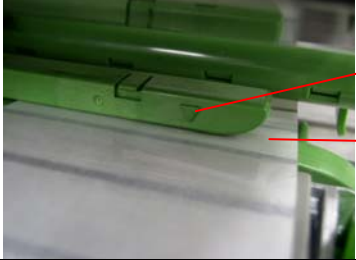

When enter [Manual] option, you will see following message. Please complete there steps :

<pre>Paper Len. 00151 dot</pre>	<ol style="list-style-type: none">1. Press the DOWN  button to move the cursor from left digit to right digit, and press the UP  button to set the value from “0” to “9” and the “dot/ mm/ inch”. Press the SELECT button to set the paper length into the printer.
<pre>Bline Size 0024 dot</pre>	<ol style="list-style-type: none">2. Press the DOWN  button to move the cursor from left digit to right digit, and press the UP  button to set the value from “0” to “9” and the “dot/ mm/ inch”. Press the SELECT button to set the bline size into the printer.

<pre> Bline Mode Scan Mark Intensity x Ref. Level xxx </pre>	<p>3. Open the print head mechanism, put the black mark under the media sensor. Press the SELECT button to set the value into the printer.</p>
	<p>Media sensor Black mark</p>
<pre> Bline Mode Scan Paper Intensity x Ref. Level xxx </pre>	<p>4. Then, put the label without black mark under the media sensor. Press the SELECT button to set the value into the printer.</p>
	<p>Media sensor Label without black mark</p>
<p>Note: Normally, the value of "Ref. Level" for mark should be larger than paper for over 128. If the media sensor fails to do so, you have to manually change the Intensity by pressing UP  and DOWN  to reach the above value.</p>	
<pre> Bline Mode Complete Intensity x Ref. Level xxx </pre>	<p>5. The bline sensor calibration is complete. Press the SELECT button the LCD screen will return to the previous menu.</p>

B-3 Pre-Printed

This function can set the paper length and gap size before auto-calibrate the sensor sensitivity. It can to get the sensor sensitivity accurately.

```

Bline Mode      3/4
Manual
> Pre-Printed
Exit

```

When enter [Pre-Printed] option, you will see following message. Please complete there steps :

<p style="text-align: center;">Paper Len. 00812 dot</p>	<p>1. Press the DOWN ⬇️ button to move the cursor from left digit to right digit, and press the UP ⬆️ button to set the value from “0” to “9” and the “dot/mm/ inch”. Press the SELECT button to set the paper length into the printer.</p>
<p style="text-align: center;">Bline Size 0024 dot</p>	<p>2. Press the DOWN ⬇️ button to move the cursor from left digit to right digit, and press the UP ⬆️ button to set the value from “0” to “9” and the “dot/mm/ inch”. Press the SELECT button to set the bline size into the printer.</p>
<p>Bline Mode Pre-Printed</p>	<p>3. Then, printer will feed labels to calibrate the sensor sensitivity automatically. When calibration is completed, the LCD screen will return to the previous menu.</p>

C. Cont. Mode

```
Calibration      3/4
  Bline Mode
> Cont. Mode
  Exit
```

```
Cont. Mode      1/3
> Automatic
  Manual
  Exit
```

Press the **UP** \uparrow and **DOWN** \downarrow buttons to scroll the cursor to the sensor type. Press the **SELECT** button to enter the black-mark sensor calibration mode.

C-1 Automatic

When enter the [Automatic] option, you will see following message and printer will calibrate the sensor sensitivity automatically. When calibration process is completed, the LCD screen will return to the previous menu.

```
Cont. Mode
Automatic
```

C-2 Manual

In case “Automatic” sensor calibration cannot apply to the media, please use “Manual” function to calibrate the sensor manually.

```
Cont. Mode      2/3
  Automatic
> Manual
  Exit
```

When enter [Manual] option, you will see following message. Please complete there steps :

<pre>Cont. Mode Remove Label Intensity x Ref. Level xxx</pre>	1. Remove the continuous label. Press the SELECT button to set the value into the printer.
<pre>Cont. Mode Scan Paper Intensity x Ref. Level xxx</pre>	2. Then, put the continuous label under the media sensor. Press the SELECT button to set the value into the printer.

Cont. Mode Complete Intensity x Ref. Level xxx	3. The sensor calibration is complete. Press the SELECT button the LCD screen will return to the previous menu.
---	---

3.1.3 Serial Comm.

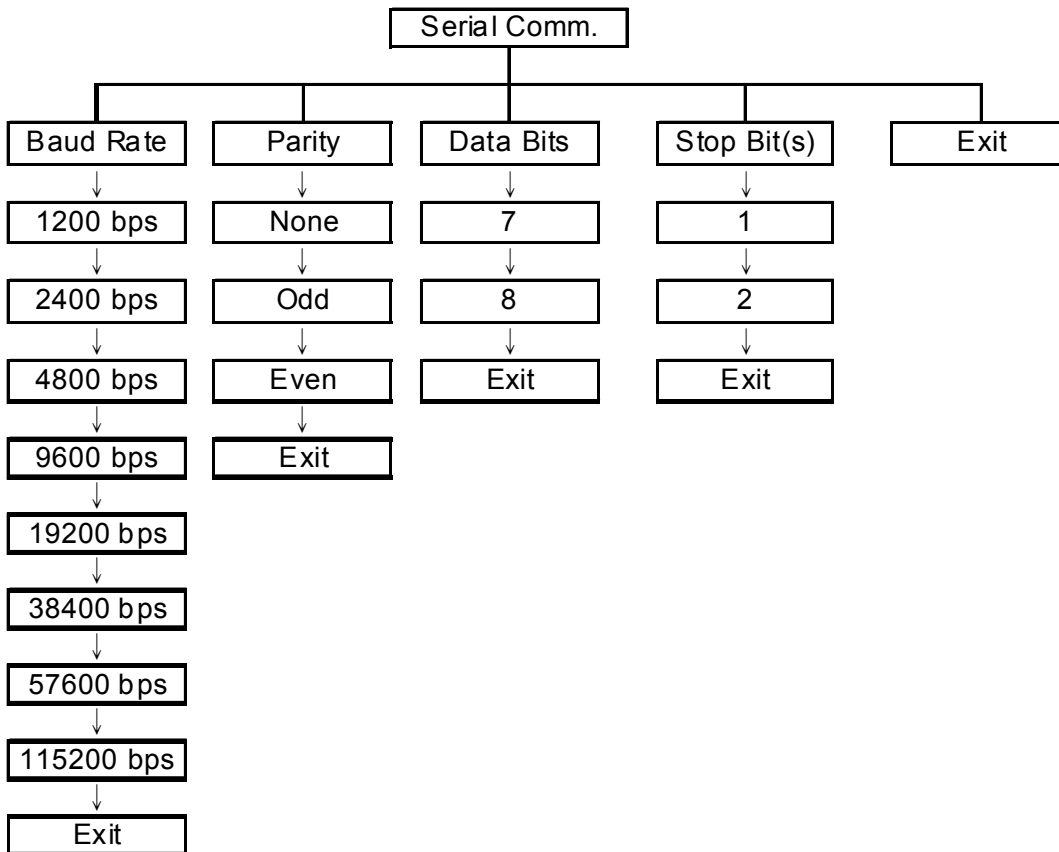

3.1.3.1 Baud Rate

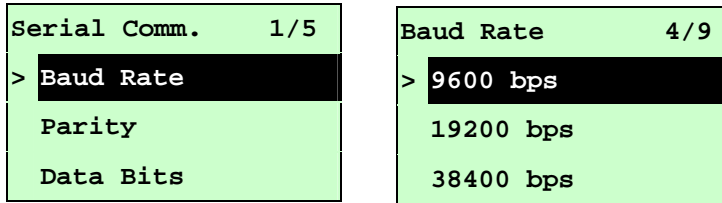

This option is used to set the RS-232 baud rate. The default setting is 9600 bps. Press **UP** and **DOWN** buttons to select the different baud rate and press **SELECT** button to set the value into printer. When you enter this list, the baud rate value in the right side of ">" icon is the current setting in the printer. Press **MENU** key to cancel the setting and return to the previous menu.

3.1.3.2 Parity

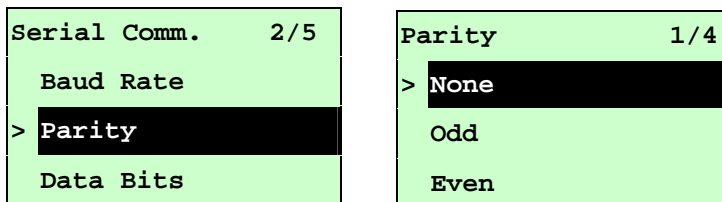

This option is used to set the RS-232 parity. The default setting is "None". Press **UP** and **DOWN** buttons to select the different parity and press **SELECT** button to set the value into printer. When you enter this list, the parity in the right side of ">" is the printer current setting. Press **MENU** key to cancel the setting and return to the previous menu.

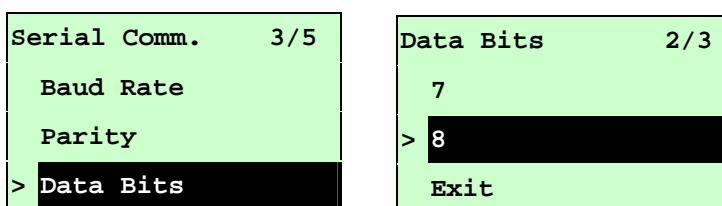

3.1.3.3 Data Bits:



This option is used to set the RS-232 Data Bits. The default setting is "8" data bits. Press **UP** and **DOWN** buttons to select the different Data Bits and press **SELECT** button to set the value into printer. When you enter this list, the Data Bits in the right side of ">" icon is the printer current setting. Press **MENU** key to cancel the setting and return to the previous menu.

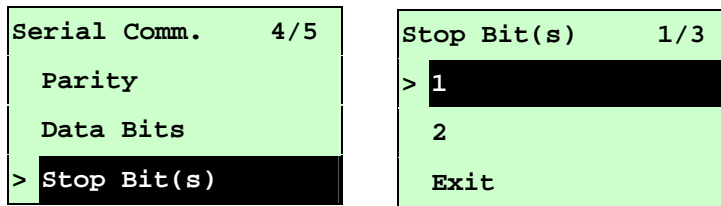

3.1.3.4 Stop Bit(s):



This option is used to set the RS-232 Stop Bits. The default setting is “1” stop bit. Press **UP**  and **DOWN**  buttons to select the different Stop Bits and press **SELECT** button to set the value into printer. When you enter this list, the option in the right side of ">" icon is the printer current setting. Press  **MENU** key to cancel the setting and return to the previous menu.

3.1.4 Ethernet

Use this menu to configure internal Ethernet configuration check the printer's Ethernet module status, and reset the Ethernet module. This function is available on the LCD display when Ethernet card is installed.

Press **UP**  and **DOWN**  buttons to select the different options and press **SELECT** button to enter the option. Press  **MENU** key to cancel the setting and return to the previous menu.

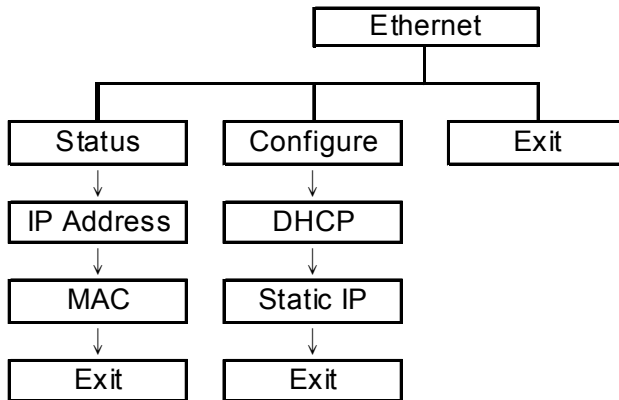

Note:

This function is available for TTP-2410M series only and option for TTP-246M Plus series.

3.1.4.1 Status: (IP Address / MAC)

Use this menu to check the Ethernet setting status.

3.1.4.1.1 IP Address

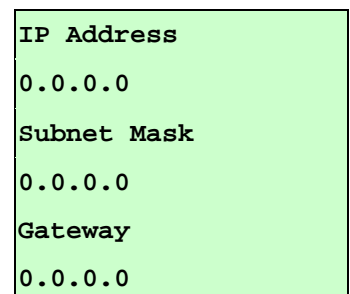
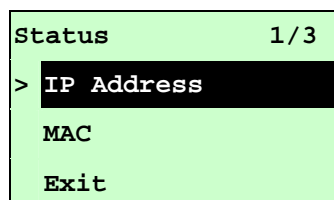
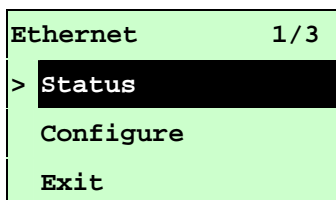

The IP address information will be shown on the LCD display. Please press **SELECT** or  **MENU** button to return to the previous menu.

3.1.4.1.2 MAC

```
Ethernet 1/3
> Status
Configure
Exit
```

```
Status 2/3
IP Address
> MAC
Exit
```

```
MAC Address
001B82-FF0918
```

The MAC address information will be shown on the LCD display. Please press **SELECT** or **MENU** button to return to the previous menu.

3.1.4.2 Configure: (DHCP / Static IP)

Use this menu to set the printer's DHCP and Static IP.

3.1.4.2.1 DHCP

```
Ethernet 2/4
Status
> Configure
Reset
```

```
Configure 1/3
> DHCP
Static IP
Exit
```

Press **UP** and **DOWN** buttons to select the DHCP function and press **SELECT** to enter. Press **MENU** key to cancel the setting and return to the previous menu.

```
DHCP

SELECT:      YES
MENU:       NO
```

Press **SELECT** button the printer will set DHCP and restart to reset the setting. Press **MENU** button to return to the previous menu.

3.1.4.2.2 Static IP

Use this menu to set the printer's IP address, subnet mask and gateway.

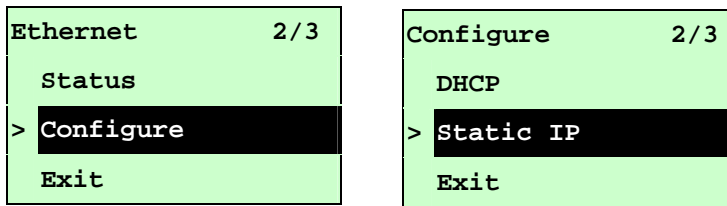

Press **UP** ⏴ and **DOWN** ⏵ buttons to select the different options and press **SELECT** button to enter the option. Press **MENU** key to cancel the setting and return to the previous menu.

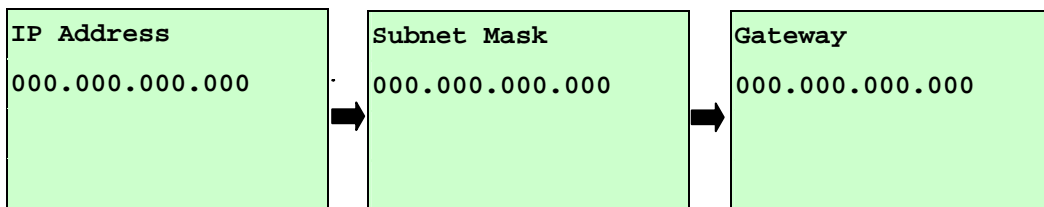

Press **DOWN** ⏵ button to move the cursor from left to right digits and press the **UP** ⏴ button to scroll the value from "0" to "9". Press **SELECT** button to next setting.

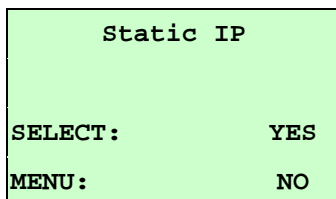

Press the **SELECT** button printer will restart to reset the Ethernet module setting. Press **MENU** key to cancel the setting.

3.2 File Manager

This feature is used to check the printer available memory and file list.

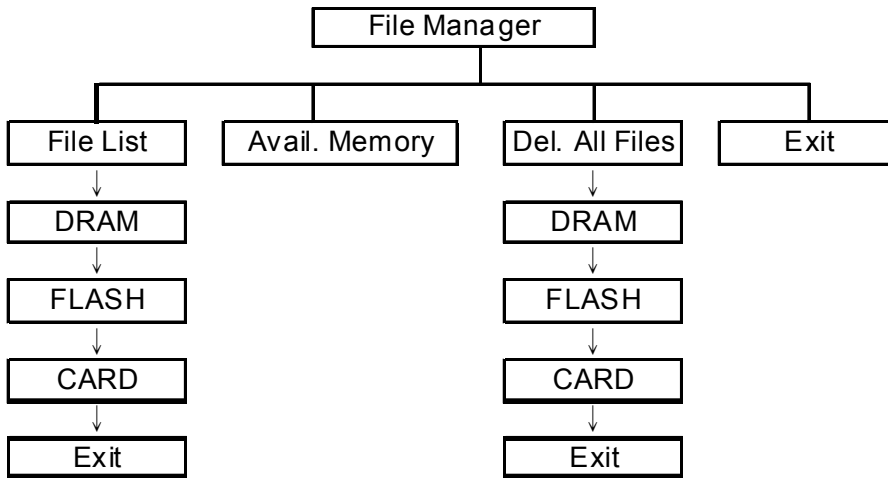

3.2.1 File List

Use this menu to show, delete and run (.BAS) the files saved in the printer DRAM/Flash/Card memory.

To show the files :

```

File Manager 1/4
> File List
  Avail. Memory
  Del. All Files
  
```

```

File List 2/4
> FLASH
  CARD
  Exit
  
```

```

FLASH File List
> DEMO.TTF
  DEMO.BAS
  
```

To delete the file : Please follow the order to press the **DOWN** button.

```

FLASH File List
> DEMO.TTF
  DEMO.BAS
  
```

```

DEMO.TTF
1.75 MB
DOWN: Delete
  
```

To run the file (.BAS) : Please follow the order to press the **SELECT** button.

```

FLASH File List
  DEMO.TTF
> DEMO.BAS
  
```

```

DEMO.BAS
406 Byte(S)
DOWN: Delete
SELECT: Run
  
```

3.2.2 Avail. Memory

Use this menu to show available memory space.

```
File Manager 2/4
  File List
> Avail. Memory
  Del. All Files
```

```
Avail. Memory
DRAM:          256 KB
FALSH:        6656 KB
CARD:          0 KB
```

3.2.3 Del. All Files

Use this menu to delete all files. Press **SELECT** button to delete all files in the device.

Press **MENU** to cancel deleting files and go back to previous menu.

```
File Manager 3/4
  File List
  Avail. Memory
> Del. All File
```

```
File List 1/4
> DRAM
  FALSH
  CARD
```

```
Del. All Files
SELECT:      YES
MENU:        NO
```

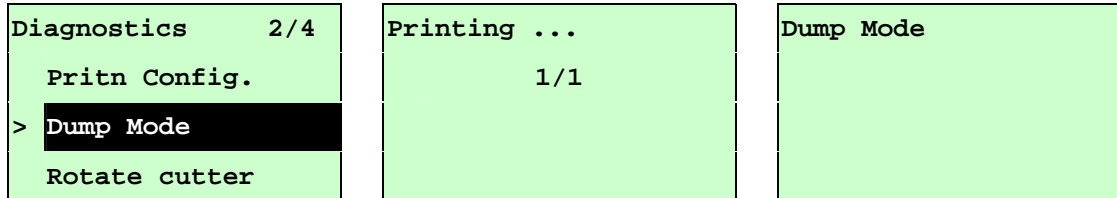

3.3.2 Dump Mode

Captures the data from the communications port and prints out the data received by printer. In the dump mode, all characters will be printed in 2 columns as following. The left side characters are received from your system and right side data are the corresponding hexadecimal value of the characters. It allows users or engineers to verify and debug the program.

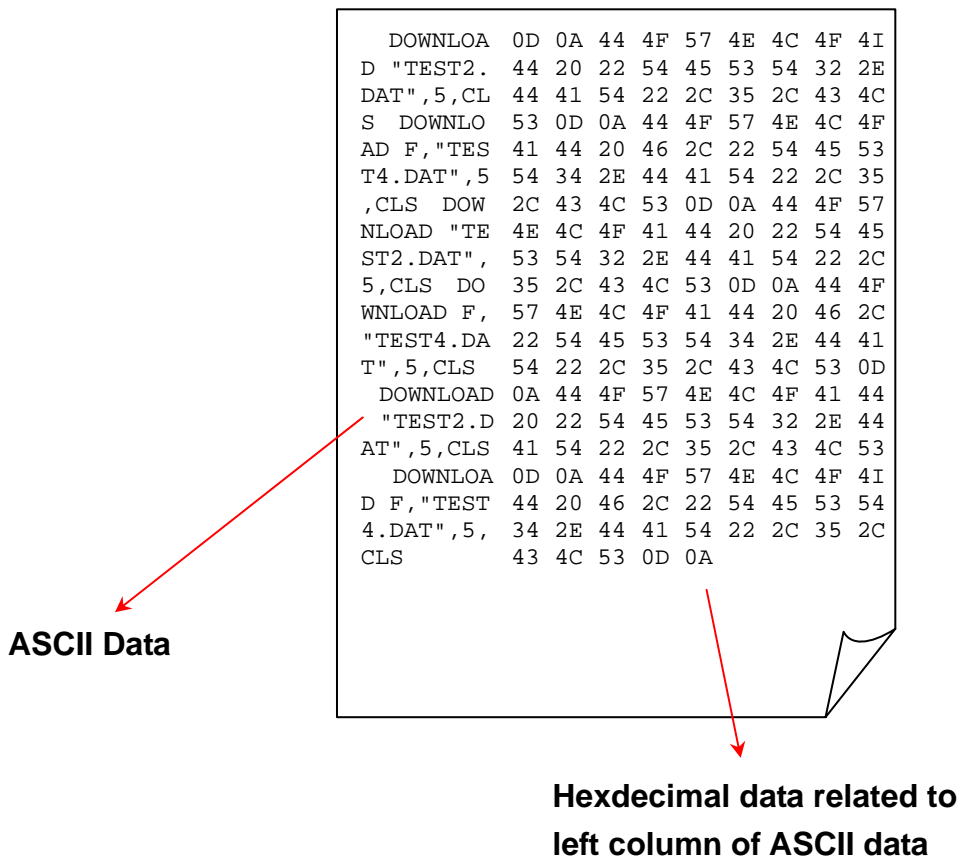

Note:

- 1. Dump mode requires 4" wide paper width.**
- 2. Turn off / on the power to resume printer for normal printing.**
- 3. Press FEED button to back to the previous menu.**



3.3.3 Rotate Cutter



In case paper is jammed in the cutter, this feature can rotate the cutter blade forward or reverse direction, which is helpful to remove the jammed paper easily from the cutter.

Diagnosics 3/4	UP: Fwd.
Print Config.	DOWN: Rev.
Dump Mode	
> Rotate Cutter	MENU: Exit

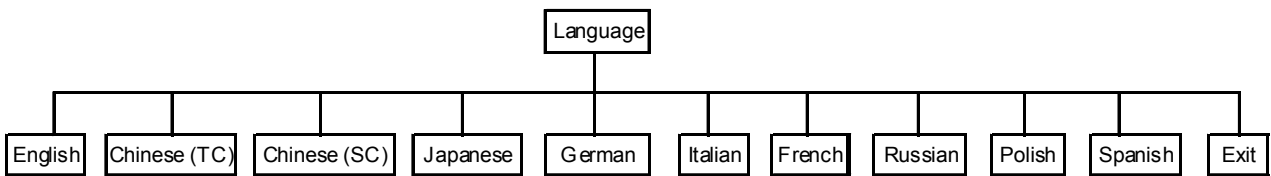
3.4 Language



This option is used to setup the language on LCD display.

Press **UP**  and **DOWN**  buttons to scroll the cursor to desire language and press **SELECT** button to select this option. Press  **MENU** key to cancel the setting and return to the previous menu. The default language setting is English.

3.5 Service

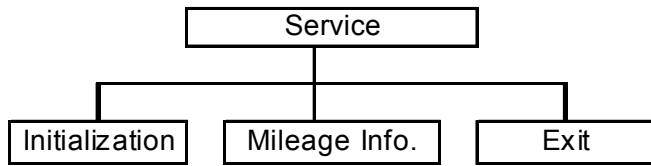

This feature is used to restore printer settings to defaults and display printer mileage information.

3.5.1 Initialization

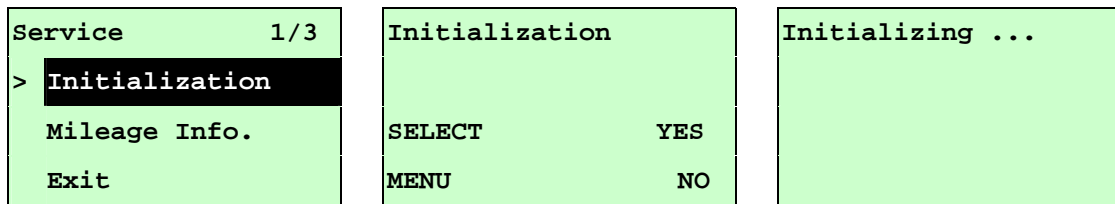

The printer settings are restored to defaults as below once printer is initialized.

Note :

When printer initialization is done, please calibrate the gap or black mark sensor before printing.

Parameter	Default setting
Speed	TTP-2410M : 6 IPS (152 mm/sec) TTP-346M/246M Plus/344M Pius : 4 IPS (101.6 mm/sec) TTP-644M : 3 IPS (76.2 mm/sec)
Density	8
Label width	4.00"(101.6mm)
Label height	4.00"(101.6mm)
Sensor type	Gap sensor
Gap setting	0.12"(3.0mm)
Print direction	0
Reference point	0,0(upper left corner)
Offset	0
Print mode	Batch mode
Serial port settings	9600 bps, none parity, 8 data bits, 1 stop bit
Code page	850
Country code	001
Clear flash memory	No
Shift X	0
Shift Y	0

Gap sensor sensitivity	3 (Will be reset. Need to re-calibrate the gap)
Bline sensor sensitivity	2 (Will be reset. Need to re-calibrate the gap)
Language	English
IP address	DHCP

3.5.2 Mileage Info.

Use this option to check the printed mileage (displayed in meter).

Service 1/3	Mileage: (m)
Initialization	4016
> Mileage Info.	Labels: (pcs.)
Exit	51698

4. Diagnostic Tool

The Diagnostic Utility is a toolbox that allows users to explore the printer's settings and status; change printer settings; download graphics, fonts, and firmware; create printer bitmap fonts; and to send additional commands to the printer. Using this convenient tool, you can explore the printer status and settings and troubleshoot the printer.

Note: This utility works with printer firmware V6.00 and later versions.

4.1 Start the Diagnostic Tool

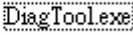
1. Double click on the Diagnostic tool icon   to start the software.
2. There are four features (Printer Configuration, File Manager, Bitmap Font Manager, Command Tool) included in the Diagnostic utility.

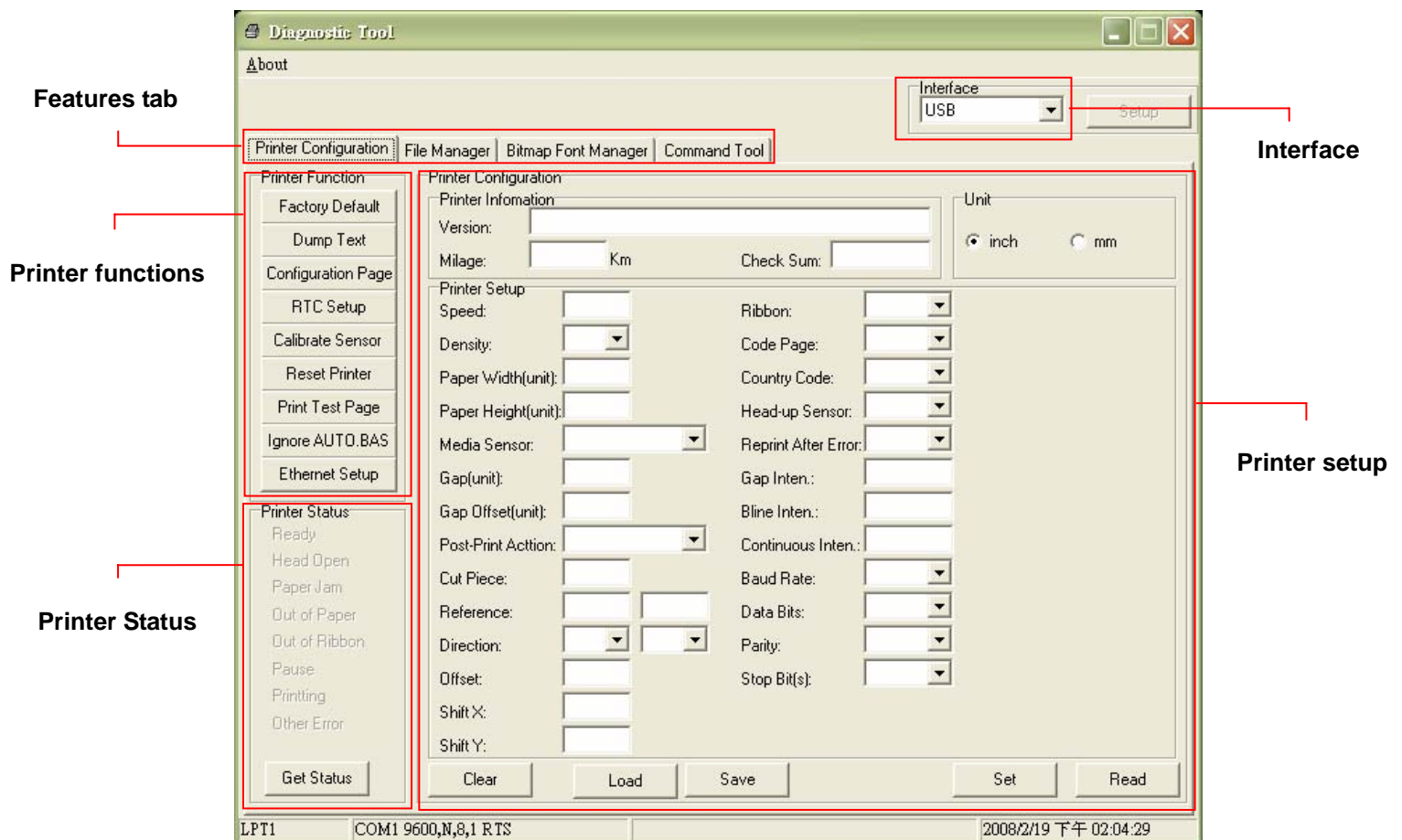

4.2 Printer Function (Calibrate sensor, Ethernet setup, RTC setup.....)

1. Select the PC interface connected with bar code printer.
2. Click the “Function” button to setting.
3. The detail functions in the Printer Function Group are listed as below.

	Function	Description
Printer Function		
Factory Default	Factory Default	Initialize the printer and restore the settings to factory default.
Dump Text	Dump Text	To activate the printer dump mode.
Configuration Page	Configuration Page	Print printer configuration.
RTC Setup	RTC Setup	Synchronize printer Real Time Clock with PC.
Calibrate Sensor	Calibrate Sensor	Calibrate the sensor specified in the Printer Setup group media sensor field.
Reset Printer	Reset Printer	Reboot the printer.
Print Test Page	Print Test Page	Print a test page.
Ignore AUTO.BAS	Ignore AUTO.BAS	Ignore the downloaded AUTO.BAS program.
Ethernet Setup	Ethernet Setup	Setup the IP address, subnet mask, gateway for the on board Ethernet.

Note:

For more information about Diagnostic Tool, please refer to the diagnostic utility quick start guide in the CD disk \ Utilities directory.

5. Troubleshooting

5.1 Common Problems

The following guide lists the most common problems that may be encountered when operating this bar code printer. If the printer still does not function after all suggested solutions have been invoked, please contact the Customer Service Department of your purchased reseller or distributor for assistance.

Problem	Possible Cause	Recovery Procedure
Power indicator does not illuminate	* The power cord is not properly connected.	* Plug the power cord in printer and outlet. * Switch the printer on.
Carriage Open	* The printer carriage is open.	* Please close the print carriage.
No Ribbon	* Running out of ribbon. * The ribbon is installed incorrectly.	* Supply a new ribbon roll. * Please refer to the steps in user's manual to reinstall the ribbon.
No Paper	* Running out of label. * The label is installed incorrectly. * Gap/black mark sensor is not calibrated.	* Supply a new label roll. * Please refer to the steps in user's manual to reinstall the label roll. * Calibrate the gap/black mark sensor.
Paper Jam	* Gap/black mark sensor is not set properly. * Make sure label size is set properly. * Labels may be stuck inside the printer mechanism.	* Calibrate the gap/black mark sensor. * Set label size correctly.
Take Label	* Peel function is enabled.	* If the peeler module is installed, please remove the label. * If there is no peeler module in front of the printer, please switch off the printer and install it. * Check if the connector is plugging correctly.
UP: Fwd. DOWN: Rev. MENU: Exit	* Cutter jam. * There is no cutter installed on the printer. * Cutter PCB is damaged.	* If the cutter module is installed, please press UP or DOWN key to rotate the cutter up or down to make the knife back to the right position. * Remove the label. * Make sure the thickness of label is less than 200 g/m2 (for regular cutter) or 300 g/m2 (for heavy duty cutter). * Replace a cutter PCB.

<p>Not Printing</p>	<ul style="list-style-type: none"> * Cable is not well connected to serial or USB interface or parallel port. * The serial port cable pin configuration is not pin to pin connected. 	<ul style="list-style-type: none"> * Re-connect cable to interface. * If using serial cable, <ul style="list-style-type: none"> - Please replace the cable with pin to pin connected. - Check the baud rate setting. The default baud rate setting of printer is 9600,n,8,1. * If using the Ethernet cable, <ul style="list-style-type: none"> - Check if the Ethernet RJ-45 connector green LED is lit on.. - Check if the Ethernet RJ-45 connector amber LED is blinking. - Check if the printer gets the IP address when using DHCP mode. - Check if the IP address is correct when using the static IP address. - Wait a few seconds let the printer get the communication with the server then check the IP address setting again. * Chang a new cable. * Ribbon and media are not compatible. * Verify the ribbon-inked side. * Reload the ribbon again. * Clean the printhead. * The print density setting is incorrect. * Printhead's harness connector is not well connected with printhead. Turn off the printer and plug the connector again. * Check if the stepping motor is plugging in the right connector. * Check your program if there is a command PRINT at the end of the file and there must have CRLF at the end of each command line.
<p>Memory full (FLASH / DRAM)</p>	<ul style="list-style-type: none"> * The space of FLASH/DRAM is full. 	<ul style="list-style-type: none"> * Delete unused files in the FLASH/DRAM. * The max. numbers of file of DRAM is 50 files. * The max. user addressable memory space of DRAM is 256 KB. * The max. numbers of file of FLASH is 256 files. * The max. user addressable memory space of FLASH is 2560 KB for TTP-246M Plus and TTP-344M Plus and 6656KB for TTP-2410M and TTP-346M.
<p>SD card is unable to use</p>	<ul style="list-style-type: none"> * SD card is damaged. * SD card doesn't insert correctly. * Use the non-approved SD card manufacturer. 	<ul style="list-style-type: none"> * Use the supported capacity SD card. * Insert the SD card again. * The supported SD card spec. <ul style="list-style-type: none"> - 128MB - 256MB - 512MB - 1GB - 4GB SDHC CLASS 6 * Approved SD card manufacturers; SanDisk, Transcend
<p>PS/2 port does not work</p>	<ul style="list-style-type: none"> * Did not turn off power prior to plug in the PS/2 keyboard. * PS/2 keyboard is damaged. * PS/2 keyboard doesn't plug-in correctly. * There is no BAS file in the printer. 	<ul style="list-style-type: none"> * Turn off printer power prior to plug in the PS/2 keyboard . * Plug the PS/2 keyboard again. * Make sure the keyboard is fine. * Make sure if there is any BAS file downloaded into printer.

<p>Poor Print Quality</p>	<ul style="list-style-type: none"> * Ribbon and media is loaded incorrectly * Dust or adhesive accumulation on the print head. * Print density is not set properly. * Printhead element is damaged. * Ribbon and media are incompatible. * The printhead pressure is not set properly. 	<ul style="list-style-type: none"> * Reload the supply. * Clean the printhead. * Clean the platen roller. * Adjust the print density and print speed. * Run printer self-test and check the print head test pattern if there is dot missing in the pattern. * Change proper ribbon or proper label media. * Adjust the printhead pressure adjustment knob. <ul style="list-style-type: none"> - If the left side printout is too light, please adjust the left side pressure adjustment knob to the higher index (higher pressure). If the pressure adjustment knob has been adjust to index "5" and the poor print quality is still at the left side of the printout, please adjust the pressure adjustment knob to index "1" and use the Z-axis adjustment knob to fine tune the pressure. - If the right side printout is too light, please adjust the right side pressure adjustment knob to the higher index (higher pressure) to improve the print quality. * If the label thickness is more than 0.22 mm, the print quality might be not good enough, please adjust the heater line adjustment screw counter clockwise to get the best print quality. * The release lever does not latch the printhead properly.
<p>LCD panel is dark and keys are not working</p>	<ul style="list-style-type: none"> * The cable between main PCB and LCD panel is loose. 	<ul style="list-style-type: none"> * Check if the cable between main PCB and LCD is secured or not.
<p>LCD panel is dark but the LEDs are light</p>	<ul style="list-style-type: none"> * The printer initialization is unsuccessful. 	<ul style="list-style-type: none"> * Turn OFF and ON the printer again. * Initialize the printer.
<p>LCD panel is dark and LEDs are lit on, but the label is feeding forward</p>	<ul style="list-style-type: none"> * The LCD panel harness connector is loose. 	<ul style="list-style-type: none"> * The LCD panel harness connector is plugged upside down.
<p>Ribbon encoder sensor doesn't work</p>	<ul style="list-style-type: none"> * The ribbon encoder sensor connector is loose. 	<ul style="list-style-type: none"> * Fasten the connector.
<p>Ribbon end sensor doesn't work</p>	<ul style="list-style-type: none"> * The connector is loose. * The ribbon sensor hole is covered with dust. 	<ul style="list-style-type: none"> * Check the connector. * Clear the dust in the sensor hole by the blower.
<p>Peel sensor is not working</p>	<ul style="list-style-type: none"> * Peel sensor is not located on the correct position. * The connector is loose. 	<ul style="list-style-type: none"> * Make sure that the media goes through the Peel sensor. * Plug the connect cable correctly.
<p>Cutter is not working</p>	<ul style="list-style-type: none"> * The connector is loose. 	<ul style="list-style-type: none"> * Plug in the connect cable correctly.
<p>Label feeding is not stable (skew) when printing</p>	<ul style="list-style-type: none"> * The media guide does not touch the edge of the media. 	<ul style="list-style-type: none"> * If the label is moving to the right side, please move the label guide to left. * If the label is moving to the left side, please move the label guide to right.
<p>Skip labels when printing</p>	<ul style="list-style-type: none"> * Label size is not specified properly. * Sensor sensitivity is not set properly. * The media sensor is covered with dust. 	<ul style="list-style-type: none"> * Check if label size is setup correctly. * Calibrate the sensor by Auto Gap or Manual Gap options. * Clear the GAP/Black mark sensor by blower.

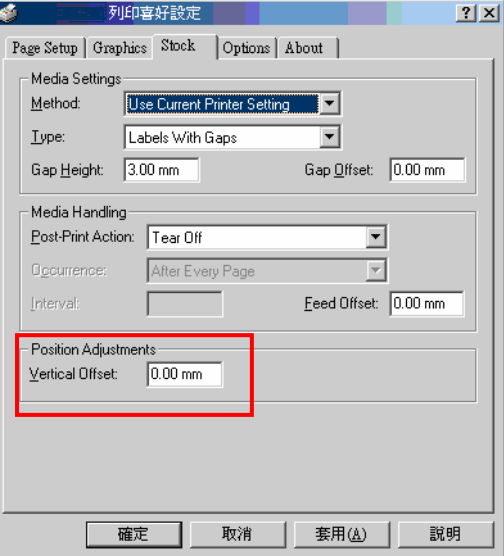
<p>The printing position of small label is incorrect</p>	<ul style="list-style-type: none"> * Media sensor sensitivity is not set properly. * Label size is incorrect. * The parameter Shift Y in the LCD menu is incorrect. * The vertical offset setting in the driver is incorrect. 	<ul style="list-style-type: none"> * Calibrate the sensor sensitivity again. * Set the correct label size and gap size. * Press [MENU] → [SELECT] x3 → [DOWN]x6 → [SELECT] to fine tune the parameter of Shift Y. * If using the software BarTender, please set the vertical offset in the driver. 
<p>The left side printout position is incorrect</p>	<ul style="list-style-type: none"> * Wrong label size setup. * The parameter Shift X in LCD menu is incorrect. 	<ul style="list-style-type: none"> * Set the correct label size. * Press [MENU] → [SELECT] x 3 → [DOWN] x 5 → [SELECT] to fine tune the parameter of Shift X.
<p>Missing printing on the left or right side of label</p>	<ul style="list-style-type: none"> * Wrong label size setup. 	<ul style="list-style-type: none"> * Set the correct label size.
<p>RTC time is incorrect when reboot the printer</p>	<ul style="list-style-type: none"> * The battery has run down. 	<ul style="list-style-type: none"> * Check if there is a battery on the main board.
<p>Multi interface board doesn't work</p>	<ul style="list-style-type: none"> * The installation is incorrect. 	<ul style="list-style-type: none"> * Check if the board is plugged in the right connector.
<p>Power and Error LEDs are blinking fast</p>	<ul style="list-style-type: none"> * Power switch OFF and ON too fast. 	<ul style="list-style-type: none"> * Turn off the printer and wait all LEDs are dark, and turn on the printer again.
<p>Wrinkle Problem</p>	<ul style="list-style-type: none"> * Printhead pressure is incorrect. * Ribbon installation is incorrect. * Media installation is incorrect. * Print density is incorrect. * Media feeding is incorrect. 	<ul style="list-style-type: none"> * Please refer to the 5.2 chapter. * Please set the suitable density to have good print quality. * Make sure the label guide touch the edge of the media guide.
<p>Gray line on the blank label</p>	<ul style="list-style-type: none"> * The printhead is dirty. * The platen roller is dirty. 	<ul style="list-style-type: none"> * Clean the printhead. * Clean the platen roller.
<p>Irregular printing</p>	<ul style="list-style-type: none"> * The printer is in Hex Dump mode. * The RS-232 setting is incorrect. 	<ul style="list-style-type: none"> * Turn off and on the printer to skip the dump mode. * Re-set the Rs-232 setting.

6. Maintenance

This session presents the clean tools and methods to maintain your printer.

1. Please use one of following material to clean the printer.

- Cotton swab (Head cleaner pen)
- Lint-free cloth
- Vacuum / Blower brush
- 100% ethanol

2. The cleaning process is described as following

Printer Part	Method	Interval
Print Head	1. Always turn off the printer before cleaning the print head. 2. Allow the print head to cool for a minimum of one minute. 3. Use a cotton swab (Head cleaner pen) and 100% ethanol to clean the print head surface.	Clean the print head when changing a new label roll
	<p>The diagram illustrates the cleaning process of the print head. It shows a hand using a Head Cleaner Pen to clean the Print Head. The diagram labels the Element, Print Head, and Head Cleaner Pen. An inset shows a close-up of the Element.</p>	
Platen Roller	1. Turn the power off. 2. Rotate the platen roller and wipe it thoroughly with 100% ethanol and a cotton swab, or lint-free cloth.	Clean the platen roller when changing a new label roll
Tear Bar/Peel Bar	Use the lint-free cloth with 100% ethanol to wipe it.	As needed
Sensor	Compressed air or vacuum	Monthly
Exterior	Wipe it with water-dampened cloth	As needed
Interior	Brush or vacuum	As needed

Note:

- Do not touch printer head by hand. If you touch it careless, please use ethanol to clean it.
- Please use 100% Ethenol. DO NOT use medical alcohol, which may damage the printer head.
- Regularly clean the print head and supply sensors once change a new ribbon to keep printer performance and extend printer life.

Revise History

Date	Content	Editor



TSC Auto ID Technology Co., Ltd.

Headquarters / Factory

No. 35, Sec. 2, Ligong 1st Rd., Wujie Town
, I-Lan County 268, Taiwan, R.O.C.

TEL: +886-3-990-6677

FAX: +886-3-990-5577

Web site: www.tscprinters.com

E-mail: printer_sales@tscprinters.com
tech_support@tscprinters.com

Taipei Office

11F, No. 205, Sec. 3, Beishin Rd., Shindian City,
Taipei 231, Taiwan, R.O.C.

TEL: +886-2-8913-1308

FAX: +886-2-8913-1808