

FCC Test Report

Product Name	Bar Code Printer
Model No.	Alpha-4L-W, PR40-W, GR40-W, 4400-W, TSC-40-W, CN-40W, BP-40W, Alpha-4L-D-W, PR40-D-W, GR40-D-W, 4400-D-W, TSC-40-D-W, CN-40LW, BP-40LW, Alpha-4L-W-R, PR40-W-R, GR40-W-R, 4400-W-R, TSC-40-W-R, Alpha-4L-D-W-R, PR40-D-W-R, GR40-D-W-R, 4400-D-W-R, TSC-40-D-W-R
FCC ID.	VTV0521302

Applicant	TSC Auto ID Technology Co., Ltd.
Address	9F., No. 95, Minguan Rd. Xindian Dist. New Taipei City 23141, Taiwan (R.O.C.)

Date of Receipt	Mar. 21, 2013
Issued Date	Jun. 14, 2013
Report No.	133393R-RFUSP29V01
Report Version	V1.0



The Test Results relate only to the samples tested.
 The test report shall not be reproduced except in full without the written approval of Quietek Corporation.
 This report must not be used to claim product endorsement by NVLAP any agency of the U.S. Government

Test Report Certification

Issued Date: Jun. 14, 2013

Report No.: 133393R-RFUSP29V01



Product Name	Bar Code Printer
Applicant	TSC Auto ID Technology Co., Ltd.
Address	9F., No. 95, Minquan Rd. Xindian Dist. New Taipei City 23141, Taiwan (R.O.C.)
Manufacturer	TSC Auto ID Technology Co., Ltd.
Model No.	Alpha-4L-W, PR40-W, GR40-W, 4400-W, TSC-40-W, CN-40W, BP-40W, Alpha-4L-D-W, PR40-D-W, GR40-D-W, 4400-D-W, TSC-40-D-W, CN-40LW, BP-40LW, Alpha-4L-W-R, PR40-W-R, GR40-W-R, 4400-W-R, TSC-40-W-R, Alpha-4L-D-W-R, PR40-D-W-R, GR40-D-W-R, 4400-D-W-R, TSC-40-D-W-R
FCC ID.	VTV0521302
EUT Rated Voltage	DC 7.4V (Power by Battery), DC 12V(Power by Adapter)
EUT Test Voltage	AC 120V/ 60Hz
Trade Name	TSC
Applicable Standard	FCC CFR Title 47 Part 15 Subpart C: 2012 ANSI C63.4: 2003, ANSI C63.10: 2009
Test Result	Complied

The Test Results relate only to the samples tested.

The test report shall not be reproduced except in full without the written approval of Quietek Corporation.

This report must not be used to claim product endorsement by NVLAP any agency of the U.S. Government

Documented By : Rita Huang
(Senior Adm. Specialist / Rita Huang)

Tested By : Alan Chen
(Engineer / Alan Chen)

Approved By : Vincent Lin
(Manager / Vincent Lin)

TABLE OF CONTENTS

Description	Page
1. GENERAL INFORMATION	5
1.1. EUT Description.....	5
1.2. Operational Description.....	8
1.3. Tested System Details.....	9
1.4. Configuration of Tested System	9
1.5. EUT Exercise Software	9
1.6. Test Facility	10
2. CONDUCTED EMISSION	11
2.1. Test Equipment.....	11
2.2. Test Setup	11
2.3. Limits.....	12
2.4. Test Procedure	12
2.5. Uncertainty	12
2.6. Test Result of Conducted Emission.....	13
3. PEAK POWER OUTPUT	23
3.1. Test Equipment.....	23
3.2. Test Setup	23
3.3. Limit	23
3.4. Test Procedure	23
3.5. Uncertainty	23
3.6. Test Result of Peak Power Output.....	24
4. RADIATED EMISSION	26
4.1. Test Equipment.....	26
4.2. Test Setup	26
4.3. Limits.....	27
4.4. Test Procedure	28
4.5. Uncertainty	28
4.6. Test Result of Radiated Emission.....	29
5. RF ANTENNA CONDUCTED TEST	47
5.1. Test Equipment.....	47
5.2. Test Setup	47
5.3. Limits.....	47
5.4. Test Procedure	47
5.5. Uncertainty	47
5.6. Test Result of RF Antenna Conducted Test.....	48
6. BAND EDGE	60
6.1. Test Equipment.....	60
6.2. Test Setup	61
6.3. Limit	62
6.4. Test Procedure	62
6.5. Uncertainty	62

6.6.	Test Result of Band Edge	63
7.	CHANNEL NUMBER.....	71
7.1.	Test Equipment	71
7.2.	Test Setup	71
7.3.	Limit	71
7.4.	Test Procedure	71
7.5.	Uncertainty	71
7.6.	Test Result of Channel Number.....	72
8.	CHANNEL SEPARATION.....	74
8.1.	Test Equipment	74
8.2.	Test Setup	74
8.3.	Limit	74
8.4.	Test Procedure	74
8.5.	Uncertainty	74
8.6.	Test Result of Channel Separation.....	75
9.	DWELL TIME.....	79
9.1.	Test Equipment	79
9.2.	Test Setup	79
9.3.	Limit	79
9.4.	Test Procedure	79
9.5.	Uncertainty	79
9.6.	Test Result of Dwell Time	80
10.	OCCUPIED BANDWIDTH	84
10.1.	Test Equipment	84
10.2.	Test Setup	84
10.3.	Limits.....	84
10.4.	Test Procedure	84
10.5.	Uncertainty	84
10.6.	Test Result of Occupied Bandwidth	85
11.	EMI REDUCTION METHOD DURING COMPLIANCE TESTING	91

Attachment 1: EUT Test Photographs

Attachment 2: EUT Detailed Photographs

1. GENERAL INFORMATION

1.1. EUT Description

Product Name	Bar Code Printer
Trade Name	TSC
Model No.	Alpha-4L-W, PR40-W, GR40-W, 4400-W, TSC-40-W, CN-40W, BP-40W, Alpha-4L-D-W, PR40-D-W, GR40-D-W, 4400-D-W, TSC-40-D-W, CN-40LW, BP-40LW, Alpha-4L-W-R, PR40-W-R, GR40-W-R, 4400-W-R, TSC-40-W-R, Alpha-4L-D-W-R, PR40-D-W-R, GR40-D-W-R, 4400-D-W-R, TSC-40-D-W-R
FCC ID.	VTV0521302
Frequency Range	2402 – 2480MHz
Channel Number	79
Type of Modulation	FHSS: GFSK(1Mbps) / π / 4DQPSK(2Mbps) / 8DPSK(3Mbps)
Antenna Type	SMD antenna
Channel Control	Auto
Antenna Gain	Refer to the table “Antenna List”
USB Cable	Shielded, 1.0m, with one ferrite core bonded.
RS-232 to USB Cable	Shielded, 1.0m
Power Adapter (1)	MFR: L.T.E., M/N: LTE24W-S2 Input: AC 100-240V, 1A, 50/60Hz Output: DC 12V $\overline{=}$ 2A Cable in: Non-Shielded, 1.8m, with one ferrite core bonded.
Power Adapter (2)	MFR: L.T.E., M/N: LTE12W-S2 Input: AC 100-240V, 1A, 50/60Hz Output: DC 12V $\overline{=}$ 1A Cable in: Non-Shielded, 1.8m, with one ferrite core bonded.
Power Adapter (3)	MFR: Wearnes, M/N: WWS02412U Input: AC 100-240V, 0.8A, 50-60Hz Output: 12V $\overline{=}$ 2A Cable in: Non-Shielded, 1.8m, with one ferrite core bonded.
Power Adapter (4)	MFR: Powertron Electronics Corp., M/N: PA1015-2DU Input: AC 100-240V, 50-60Hz, 0.4A Output: 12V $\overline{=}$ 1.0A Cable in: Non-Shielded, 1.2m, with one ferrite core bonded.
Power Adapter (5)	MFR: CWT, M/N: SAG024F 4 US Input: AC 100-240V, 47-63Hz, 0.8A Output: 12V $\overline{=}$ 2.0A Cable in: Non-Shielded, 1.45m, with one ferrite core bonded.
Power Adapter (6) Car Charge	MFR: Atech OEM Inc., M/N: C11A-1215CD0-S0 Input: DC 12 ~ 24V Output: DC 12V $\overline{=}$ 1.5A(MAX) Cable Out: Non-Shielded, 1.5m

Antenna List

No.	Manufacturer	Part No.	Antenna Type	Peak Gain
1	H&H Technology Co., LTD	IADEA002420C	SMD antenna	-1.42 dBi for 2.4 GHz

Note: The antenna of EUT is conform to FCC 15.203.

Center Frequency of Each Channel:

Channel	Frequency	Channel	Frequency	Channel	Frequency	Channel	Frequency
Channel 00:	2402 MHz	Channel 20:	2422 MHz	Channel 40:	2442 MHz	Channel 60:	2462 MHz
Channel 01:	2403 MHz	Channel 21:	2423 MHz	Channel 41:	2443 MHz	Channel 61:	2463 MHz
Channel 02:	2404 MHz	Channel 22:	2424 MHz	Channel 42:	2444 MHz	Channel 62:	2464 MHz
Channel 03:	2405 MHz	Channel 23:	2425 MHz	Channel 43:	2445 MHz	Channel 63:	2465 MHz
Channel 04:	2406 MHz	Channel 24:	2426 MHz	Channel 44:	2446 MHz	Channel 64:	2466 MHz
Channel 05:	2407 MHz	Channel 25:	2427 MHz	Channel 45:	2447 MHz	Channel 65:	2467 MHz
Channel 06:	2408 MHz	Channel 26:	2428 MHz	Channel 46:	2448 MHz	Channel 66:	2468 MHz
Channel 07:	2409 MHz	Channel 27:	2429 MHz	Channel 47:	2449 MHz	Channel 67:	2469 MHz
Channel 08:	2410 MHz	Channel 28:	2430 MHz	Channel 48:	2450 MHz	Channel 68:	2470 MHz
Channel 09:	2411 MHz	Channel 29:	2431 MHz	Channel 49:	2451 MHz	Channel 69:	2471 MHz
Channel 10:	2412 MHz	Channel 30:	2432 MHz	Channel 50:	2452 MHz	Channel 70:	2472 MHz
Channel 11:	2413 MHz	Channel 31:	2433 MHz	Channel 51:	2453 MHz	Channel 71:	2473 MHz
Channel 12:	2414 MHz	Channel 32:	2434 MHz	Channel 52:	2454 MHz	Channel 72:	2474 MHz
Channel 13:	2415 MHz	Channel 33:	2435 MHz	Channel 53:	2455 MHz	Channel 73:	2475 MHz
Channel 14:	2416 MHz	Channel 34:	2436 MHz	Channel 54:	2456 MHz	Channel 74:	2476 MHz
Channel 15:	2417 MHz	Channel 35:	2437 MHz	Channel 55:	2457 MHz	Channel 75:	2477 MHz
Channel 16:	2418 MHz	Channel 36:	2438 MHz	Channel 56:	2458 MHz	Channel 76:	2478 MHz
Channel 17:	2419 MHz	Channel 37:	2439 MHz	Channel 57:	2459 MHz	Channel 77:	2479 MHz
Channel 18:	2420 MHz	Channel 38:	2440 MHz	Channel 58:	2460 MHz	Channel 78:	2480 MHz
Channel 19:	2421 MHz	Channel 39:	2441 MHz	Channel 59:	2461 MHz		

Note:

1. The EUT is a Bar Code Printer with a built-in 2.4GHz WLAN and Bluetooth transceiver, this report for Bluetooth.
2. The different of the twenty-four model is shown as below:
(In the same configuration conditions, the hardware is identical, the differences between the models is pre-reserved model name, available to suppliers to put their own trademark.)

Model No.	Configuration
Alpha-4L-W PR40-W GR40-W 4400-W TSC-40-W CN-40W BP-40W	USB +Bluetooth+ non-LCD display + 802.11b/g/n
Alpha-4L-D-W PR40-D-W GR40-D-W 4400-D-W TSC-40-D-W CN-40LW BP-40LW	USB +Bluetooth+ LCD display + 802.11b/g/n
Alpha-4L-W-R PR40-W-R GR40-W-R 4400-W-R TSC-40-W-R	USB +Bluetooth+ non-LCD display + 802.11b/g/n + USB to RS232 Cable
Alpha-4L-D-W-R PR40-D-W-R GR40-D-W-R 4400-D-W-R TSC-40-D-W-R	USB +Bluetooth+ LCD display + 802.11b/g/n + USB to RS232 Cable

3. Each model through the pretest, only the worst case (Alpha-4L-D-W-R: USB +Bluetooth+ LCD display + 802.11b/g/n + USB to RS232 Cable) is shown in the test report
4. These tests were conducted on a sample for the purpose of demonstrating compliance of Bluetooth transmitter with Part 15 Subpart C Paragraph 15.247 for spread spectrum devices.
5. Regarding to the operation frequency, the lowest, middle and highest frequency are selected to perform the test.
6. The radiation measurements are performed in X, Y, Z axis positioning. Only the worst case is shown in the report.
7. The test item conducted emission and 30MHz – 1GHz radiated emission are tested at five adapter, the worst case are Adapter #1. The worst case are tested all test item.

Test Mode	Mode 1: Transmit - 1Mbps (GFSK) Mode 2: Transmit - 3Mbps (8DPSK)
-----------	---

1.3. Tested System Details

The types for all equipment, plus descriptions of all cables used in the tested system (including inserted cards) are:

	Product	Manufacturer	Model No.	Serial No.	Power Cord
1	Notebook PC	DELL	PP18L	36119001664	Non-Shielded, 0.8m
2	Test Fixture	TSC	N/A	N/A	N/A

Signal Cable Type	Signal cable Description
A	RS-232 to USB Cable Shielded, 1.0m
B	Printer Cable Shielded, 2.0m
C	Signal Cable Non-Shielded, 0.3m
D	USB Cable Shielded, 1.5m

1.4. Configuration of Tested System

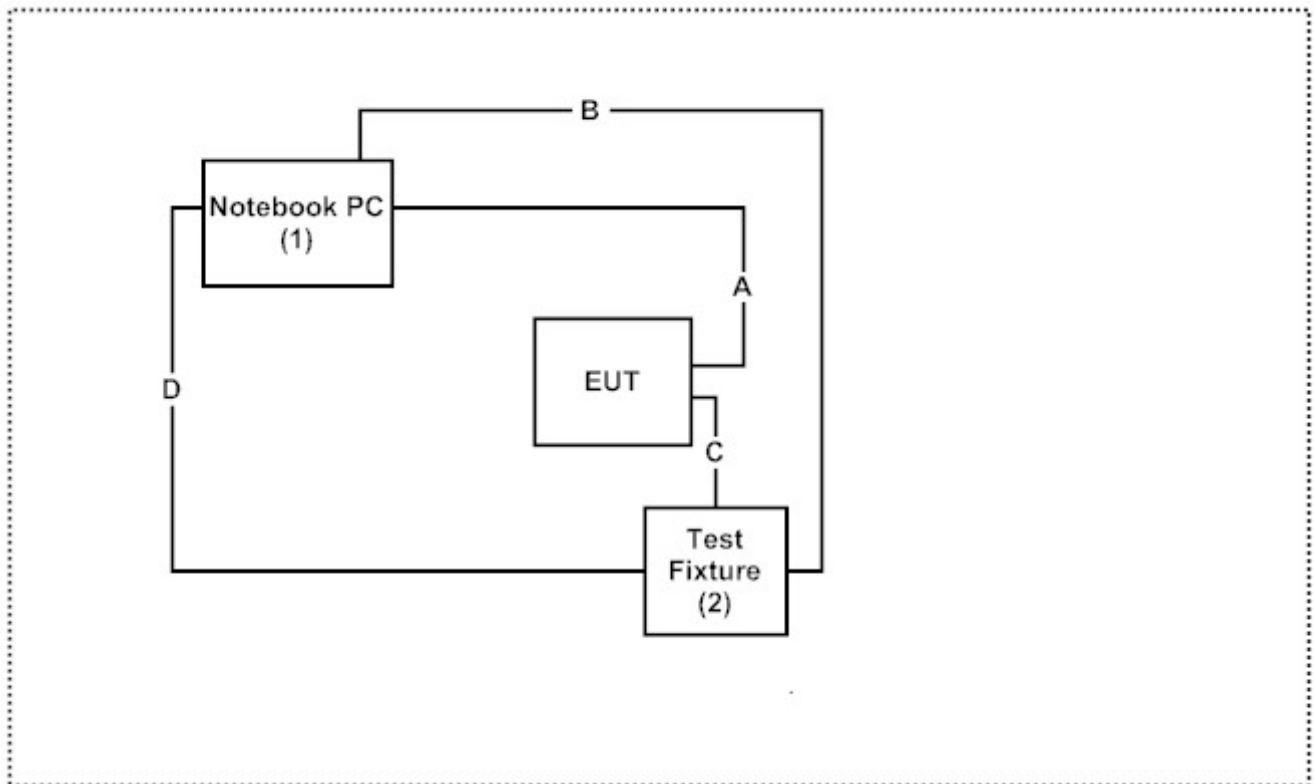

1.5. EUT Exercise Software

- (1) Setup the EUT as shown in Section 1.4
- (2) Execute software on the Notebook PC.
- (3) Configure the test mode, the test channel, and the data rate.
- (4) Press “OK” to start the continuous Transmit.
- (5) Verify that the EUT works properly.

1.6. Test Facility

Ambient conditions in the laboratory:

Items	Required (IEC 68-1)	Actual
Temperature (°C)	15-35	20-35
Humidity (%RH)	25-75	30-65
Barometric pressure (mbar)	860-1060	950-1000

The related certificate for our laboratories about the test site and management system can be downloaded from Quietek Corporation's Web Site: <http://www.quietek.com/tw/ctg/cts/accreditations.htm>
The address and introduction of Quietek Corporation's laboratories can be founded in our Web site: <http://www.quietek.com/>

Site Description: File on
Federal Communications Commission
FCC Engineering Laboratory
7435 Oakland Mills Road
Columbia, MD 21046
Registration Number: 92195

Accreditation on NVLAP
NVLAP Lab Code: 200533-0

Site Name: Quietek Corporation
Site Address: No.5-22, Ruishukeng,
Linkou Dist. New Taipei City 24451,
Taiwan, R.O.C.
TEL: 886-2-8601-3788 / FAX : 886-2-8601-3789
E-Mail : service@quietek.com

FCC Accreditation Number: TW1014

2. Conducted Emission

2.1. Test Equipment

	Equipment	Manufacturer	Model No. / Serial No.	Last Cal.	Remark
X	Test Receiver	R & S	ESCS 30 / 825442/018	Sep., 2012	
X	Artificial Mains Network	R & S	ENV4200 / 848411/10	Feb., 2013	Peripherals
X	LISN	R & S	ESH3-Z5 / 825562/002	Feb., 2013	EUT
	DC LISN	Schwarzbeck	8226 / 176	Mar, 2013	EUT
X	Pulse Limiter	R & S	ESH3-Z2 / 357.8810.52	Feb., 2013	
	No.1 Shielded Room				

Note:

1. All equipments are calibrated every one year.
2. The test instruments marked by “X” are used to measure the final test results.

2.2. Test Setup

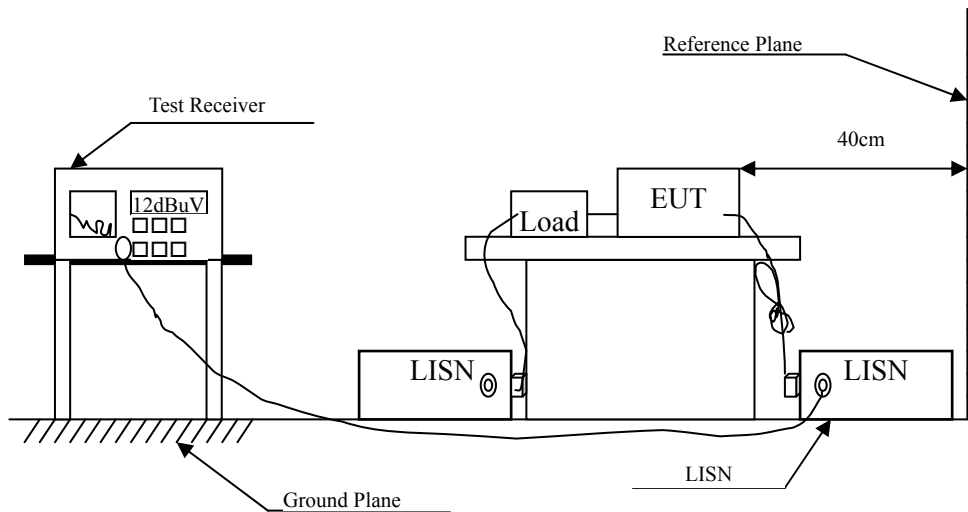

2.3. Limits

FCC Part 15 Subpart C Paragraph 15.207 (dBuV) Limit		
Frequency MHz	Limits	
	QP	AV
0.15 - 0.50	66-56	56-46
0.50-5.0	56	46
5.0 - 30	60	50

Remarks: In the above table, the tighter limit applies at the band edges.

2.4. Test Procedure

The EUT and Peripherals are connected to the main power through a line impedance stabilization network (L.I.S.N.). This provides a 50 ohm /50uH coupling impedance for the measuring equipment. The peripheral devices are also connected to the main power through a LISN that provides a 50ohm /50uH coupling impedance with 50ohm termination. (Please refer to the block diagram of the test setup and photographs.)

Both sides of A.C. line are checked for maximum conducted interference. In order to find the maximum emission, the relative positions of equipment and all the interface cables must be changed according to ANSI C63.10: 2009 on conducted measurement.

Conducted emissions were investigated over the frequency range from 0.15MHz to 30MHz using a receiver bandwidth of 9kHz.

The EUT was setup to ANSI C63.10, 2009; tested to FHSS test procedure of FCC Public Notice DA 00-705 for compliance to FCC 47CFR 15.247 requirements.

2.5. Uncertainty

± 2.26 dB

2.6. Test Result of Conducted Emission

Product : Bar Code Printer
 Test Item : Conducted Emission Test
 Power Line : Line 1
 Test Mode : Mode 2: Transmit - 3Mbps (8DPSK) -Adapter(1) (2441MHz)

Frequency MHz	Correct Factor dB	Reading Level dBuV	Measurement Level dBuV	Margin dB	Limit dBuV
LINE 1					
Quasi-Peak					
0.162	9.790	30.940	40.730	-24.927	65.657
0.216	9.790	24.950	34.740	-29.374	64.114
0.345	9.790	16.190	25.980	-34.449	60.429
2.970	9.810	13.010	22.820	-33.180	56.000
8.021	9.922	19.580	29.502	-30.498	60.000
15.927	10.100	25.010	35.110	-24.890	60.000
Average					
0.162	9.790	27.190	36.980	-18.677	55.657
0.216	9.790	20.090	29.880	-24.234	54.114
0.345	9.790	7.430	17.220	-33.209	50.429
2.970	9.810	7.730	17.540	-28.460	46.000
8.021	9.922	11.790	21.712	-28.288	50.000
15.927	10.100	18.300	28.400	-21.600	50.000

Note:

1. All Reading Levels are Quasi-Peak and average value.
2. "█" means the worst emission level.
3. Measurement Level = Reading Level + Correct Factor

Product : Bar Code Printer
 Test Item : Conducted Emission Test
 Power Line : Line 2
 Test Mode : Mode 2: Transmit - 3Mbps (8DPSK) -Adapter(1) (2441MHz)

Frequency MHz	Correct Factor dB	Reading Level dBuV	Measurement Level dBuV	Margin dB	Limit dBuV
LINE 2					
Quasi-Peak					
0.173	9.770	27.180	36.950	-28.393	65.343
0.216	9.770	25.390	35.160	-28.954	64.114
0.486	9.770	26.780	36.550	-19.850	56.400
7.966	9.921	22.140	32.061	-27.939	60.000
16.095	10.170	28.970	39.140	-20.860	60.000
21.732	10.230	21.720	31.950	-28.050	60.000
Average					
0.173	9.770	26.010	35.780	-19.563	55.343
0.216	9.770	22.590	32.360	-21.754	54.114
0.486	9.770	21.680	31.450	-14.950	46.400
7.966	9.921	16.140	26.061	-23.939	50.000
16.095	10.170	24.260	34.430	-15.570	50.000
21.732	10.230	15.000	25.230	-24.770	50.000

Note:

1. All Reading Levels are Quasi-Peak and average value.
2. "■" means the worst emission level.
3. Measurement Level = Reading Level + Correct Factor

Product : Bar Code Printer
 Test Item : Conducted Emission Test
 Power Line : Line 1
 Test Mode : Mode 2: Transmit - 3Mbps (8DPSK) -Adapter(2) (2441MHz)

Frequency MHz	Correct Factor dB	Reading Level dBuV	Measurement Level dBuV	Margin dB	Limit dBuV
LINE 1					
Quasi-Peak					
0.185	9.790	35.360	45.150	-19.850	65.000
0.396	9.790	32.090	41.880	-17.091	58.971
0.920	9.790	23.260	33.050	-22.950	56.000
2.255	9.810	20.170	29.980	-26.020	56.000
4.361	9.820	25.210	35.030	-20.970	56.000
14.103	10.066	27.950	38.016	-21.984	60.000
Average					
0.185	9.790	20.380	30.170	-24.830	55.000
0.396	9.790	23.930	33.720	-15.251	48.971
0.920	9.790	15.900	25.690	-20.310	46.000
2.255	9.810	11.910	21.720	-24.280	46.000
4.361	9.820	18.120	27.940	-18.060	46.000
14.103	10.066	22.540	32.606	-17.394	50.000

Note:

1. All Reading Levels are Quasi-Peak and average value.
2. "■" means the worst emission level.
3. Measurement Level = Reading Level + Correct Factor

Product : Bar Code Printer
 Test Item : Conducted Emission Test
 Power Line : Line 2
 Test Mode : Mode 2: Transmit - 3Mbps (8DPSK) -Adapter(2) (2441MHz)

Frequency MHz	Correct Factor dB	Reading Level dBuV	Measurement Level dBuV	Margin dB	Limit dBuV
LINE 2					
Quasi-Peak					
0.158	9.770	38.050	47.820	-17.951	65.771
0.408	9.770	31.650	41.420	-17.209	58.629
0.861	9.780	22.570	32.350	-23.650	56.000
2.197	9.790	22.140	31.930	-24.070	56.000
4.185	9.810	28.710	38.520	-17.480	56.000
13.853	10.112	29.820	39.932	-20.068	60.000
Average					
0.158	9.770	24.350	34.120	-21.651	55.771
0.408	9.770	23.880	33.650	-14.979	48.629
0.861	9.780	15.490	25.270	-20.730	46.000
2.197	9.790	12.740	22.530	-23.470	46.000
4.185	9.810	22.110	31.920	-14.080	46.000
13.853	10.112	24.710	34.822	-15.178	50.000

Note:

1. All Reading Levels are Quasi-Peak and average value.
2. "█" means the worst emission level.
3. Measurement Level = Reading Level + Correct Factor

Product : Bar Code Printer
 Test Item : Conducted Emission Test
 Power Line : Line 1
 Test Mode : Mode 2: Transmit - 3Mbps (8DPSK) -Adapter(3) (2441MHz)

Frequency MHz	Correct Factor dB	Reading Level dBuV	Measurement Level dBuV	Margin dB	Limit dBuV
LINE 1					
Quasi-Peak					
0.170	9.790	46.570	56.360	-9.069	65.429
0.205	9.790	41.030	50.820	-13.609	64.429
0.248	9.790	36.580	46.370	-16.830	63.200
0.998	9.790	19.730	29.520	-26.480	56.000
4.228	9.820	17.980	27.800	-28.200	56.000
21.771	10.110	22.240	32.350	-27.650	60.000
Average					
0.170	9.790	36.090	45.880	-9.549	55.429
0.205	9.790	28.760	38.550	-15.879	54.429
0.248	9.790	23.940	33.730	-19.470	53.200
0.998	9.790	9.870	19.660	-26.340	46.000
4.228	9.820	6.550	16.370	-29.630	46.000
21.771	10.110	16.680	26.790	-23.210	50.000

Note:

1. All Reading Levels are Quasi-Peak and average value.
2. "█" means the worst emission level.
3. Measurement Level = Reading Level + Correct Factor

Product : Bar Code Printer
 Test Item : Conducted Emission Test
 Power Line : Line 2
 Test Mode : Mode 2: Transmit - 3Mbps (8DPSK) -Adapter(3) (2441MHz)

Frequency MHz	Correct Factor dB	Reading Level dBuV	Measurement Level dBuV	Margin dB	Limit dBuV
LINE 2					
Quasi-Peak					
0.177	9.770	47.800	57.570	-7.659	65.229
0.228	9.770	34.160	43.930	-19.841	63.771
0.408	9.770	29.770	39.540	-19.089	58.629
1.748	9.790	18.910	28.700	-27.300	56.000
6.607	9.870	17.760	27.630	-32.370	60.000
22.666	10.230	24.150	34.380	-25.620	60.000
Average					
0.177	9.770	35.890	45.660	-9.569	55.229
0.228	9.770	14.180	23.950	-29.821	53.771
0.408	9.770	9.940	19.710	-28.919	48.629
1.748	9.790	10.220	20.010	-25.990	46.000
6.607	9.870	10.980	20.850	-29.150	50.000
22.666	10.230	18.810	29.040	-20.960	50.000

Note:

1. All Reading Levels are Quasi-Peak and average value.
2. "█" means the worst emission level.
3. Measurement Level = Reading Level + Correct Factor

Product : Bar Code Printer
 Test Item : Conducted Emission Test
 Power Line : Line 1
 Test Mode : Mode 2: Transmit - 3Mbps (8DPSK) -Adapter(4) (2441MHz)

Frequency MHz	Correct Factor dB	Reading Level dBuV	Measurement Level dBuV	Margin dB	Limit dBuV
LINE 1					
Quasi-Peak					
0.189	9.790	32.750	42.540	-22.346	64.886
0.400	9.790	37.260	47.050	-11.807	58.857
0.853	9.790	25.970	35.760	-20.240	56.000
1.502	9.800	24.880	34.680	-21.320	56.000
1.888	9.810	23.880	33.690	-22.310	56.000
15.002	10.092	25.980	36.072	-23.928	60.000
Average					
0.189	9.790	20.170	29.960	-24.926	54.886
0.400	9.790	30.640	40.430	-8.427	48.857
0.853	9.790	19.350	29.140	-16.860	46.000
1.502	9.800	18.950	28.750	-17.250	46.000
1.888	9.810	17.490	27.300	-18.700	46.000
15.002	10.092	21.820	31.912	-18.088	50.000

Note:

1. All Reading Levels are Quasi-Peak and average value.
2. "■" means the worst emission level.
3. Measurement Level = Reading Level + Correct Factor

Product : Bar Code Printer
 Test Item : Conducted Emission Test
 Power Line : Line 2
 Test Mode : Mode 2: Transmit - 3Mbps (8DPSK) -Adapter(4) (2441MHz)

Frequency MHz	Correct Factor dB	Reading Level dBuV	Measurement Level dBuV	Margin dB	Limit dBuV
LINE 2					
Quasi-Peak					
0.162	9.770	36.300	46.070	-19.587	65.657
0.205	9.770	32.630	42.400	-22.029	64.429
0.400	9.770	34.160	43.930	-14.927	58.857
1.084	9.780	21.090	30.870	-25.130	56.000
1.431	9.780	22.370	32.150	-23.850	56.000
15.162	10.156	26.630	36.786	-23.214	60.000
Average					
0.162	9.770	21.340	31.110	-24.547	55.657
0.205	9.770	18.980	28.750	-25.679	54.429
0.400	9.770	26.800	36.570	-12.287	48.857
1.084	9.780	13.470	23.250	-22.750	46.000
1.431	9.780	14.970	24.750	-21.250	46.000
15.162	10.156	21.050	31.206	-18.794	50.000

Note:

1. All Reading Levels are Quasi-Peak and average value.
2. "■" means the worst emission level.
3. Measurement Level = Reading Level + Correct Factor

Product : Bar Code Printer
 Test Item : Conducted Emission Test
 Power Line : Line 1
 Test Mode : Mode 2: Transmit - 3Mbps (8DPSK) -Adapter(5) (2441MHz)

Frequency MHz	Correct Factor dB	Reading Level dBuV	Measurement Level dBuV	Margin dB	Limit dBuV
LINE 1					
Quasi-Peak					
0.185	9.790	39.270	49.060	-15.940	65.000
0.255	9.790	33.200	42.990	-20.010	63.000
0.564	9.790	31.300	41.090	-14.910	56.000
1.005	9.790	25.930	35.720	-20.280	56.000
3.103	9.820	26.180	36.000	-20.000	56.000
9.525	9.973	24.530	34.503	-25.497	60.000
Average					
0.185	9.790	24.350	34.140	-20.860	55.000
0.255	9.790	20.090	29.880	-23.120	53.000
0.564	9.790	16.150	25.940	-20.060	46.000
1.005	9.790	9.700	19.490	-26.510	46.000
3.103	9.820	13.460	23.280	-22.720	46.000
9.525	9.973	14.050	24.023	-25.977	50.000

Note:

1. All Reading Levels are Quasi-Peak and average value.
2. "■" means the worst emission level.
3. Measurement Level = Reading Level + Correct Factor

Product : Bar Code Printer
 Test Item : Conducted Emission Test
 Power Line : Line 2
 Test Mode : Mode 2: Transmit - 3Mbps (8DPSK) -Adapter(5) (2441MHz)

Frequency MHz	Correct Factor dB	Reading Level dBuV	Measurement Level dBuV	Margin dB	Limit dBuV
LINE 2					
Quasi-Peak					
0.201	9.770	37.300	47.070	-17.473	64.543
0.314	9.770	26.570	36.340	-24.974	61.314
0.525	9.770	32.900	42.670	-13.330	56.000
1.087	9.780	28.740	38.520	-17.480	56.000
1.587	9.790	21.930	31.720	-24.280	56.000
3.728	9.810	26.520	36.330	-19.670	56.000
Average					
0.201	9.770	27.780	37.550	-16.993	54.543
0.314	9.770	12.850	22.620	-28.694	51.314
0.525	9.770	18.050	27.820	-18.180	46.000
1.087	9.780	14.630	24.410	-21.590	46.000
1.587	9.790	7.940	17.730	-28.270	46.000
3.728	9.810	14.090	23.900	-22.100	46.000

Note:

1. All Reading Levels are Quasi-Peak and average value.
2. "█" means the worst emission level.
3. Measurement Level = Reading Level + Correct Factor

3. Peak Power Output

3.1. Test Equipment

	Equipment	Manufacturer	Model No./Serial No.	Last Cal.
X	Power Meter	Anritsu	ML2495A/6K00003357	May, 2013
X	Power Sensor	Anritsu	MA2411B/0738448	Jun, 2013

Note: 1. All equipments are calibrated every one year.
 2. The test instruments marked by “X” are used to measure the final test results.

3.2. Test Setup

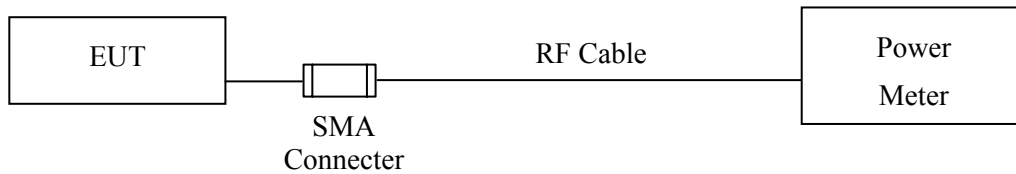

3.3. Limit

The maximum peak power shall be less 1Watt.

3.4. Test Procedure

The EUT was setup to ANSI C63.10, 2009; tested to FHSS test procedure of FCC Public Notice DA 00-705 for compliance to FCC 47CFR 15.247 requirements.

3.5. Uncertainty

± 1.27 dB

3.6. Test Result of Peak Power Output

Product : Bar Code Printer
Test Item : Peak Power Output
Test Site : No.3 OATS
Test Mode : Mode 1: Transmit - 1Mbps (GFSK)

Channel No.	Frequency (MHz)	Measurement (dBm)	Required Limit	Result
Channel 00	2402.00	1.14	1 Watt= 30 dBm	Pass
Channel 39	2441.00	1.87	1 Watt= 30 dBm	Pass
Channel 78	2480.00	1.79	1 Watt= 30 dBm	Pass

Product : Bar Code Printer
Test Item : Peak Power Output
Test Site : No.3 OATS
Test Mode : Mode 2: Transmit - 3Mbps (8DPSK)

Channel No.	Frequency (MHz)	Measurement (dBm)	Required Limit	Result
Channel 00	2402.00	-0.33	1 Watt= 30 dBm	Pass
Channel 39	2441.00	-0.84	1 Watt= 30 dBm	Pass
Channel 78	2480.00	-0.91	1 Watt= 30 dBm	Pass

4. Radiated Emission

4.1. Test Equipment

The following test equipments are used during the radiated emission test:

Test Site		Equipment	Manufacturer	Model No./Serial No.	Last Cal.
☒ Site # 3	X	Bilog Antenna	Schaffner Chase	CBL6112B/2673	Sep., 2012
	X	Horn Antenna	Schwarzbeck	BBHA9120D/D305	Sep., 2012
	X	Horn Antenna	Schwarzbeck	BBHA9170/208	Jul., 2012
	X	Pre-Amplifier	Agilent	8447D/2944A09549	Sep., 2012
	X	Spectrum Analyzer	Agilent	E4407B / US39440758	May, 2013
	X	Test Receiver	R & S	ESCS 30/ 825442/018	Sep., 2012
	X	Coaxial Cable	Quietek	QTK-CABLE/ CAB5	Feb., 2013
	X	Controller	Quietek	QTK-CONTROLLER/ CTRL3	N/A
	X	Coaxial Switch	Anritsu	MP59B/6200265729	N/A

- Note: 1. All equipments are calibrated every one year.
 2. The test instruments marked by "X" are used to measure the final test results.

4.2. Test Setup

Below 1GHz

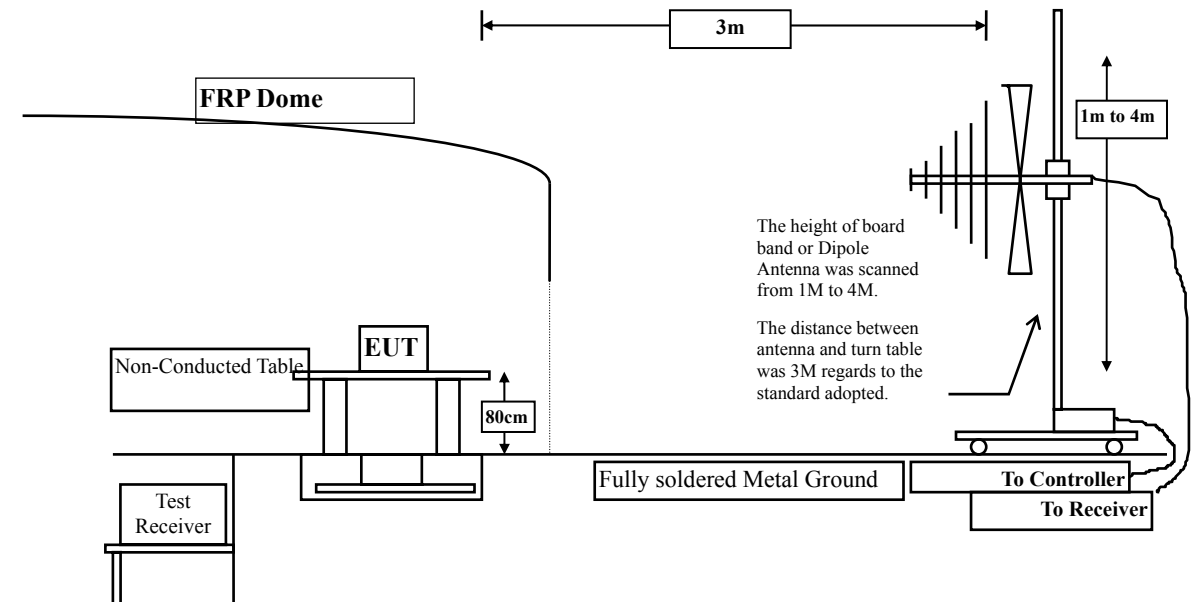

Above 1GHz

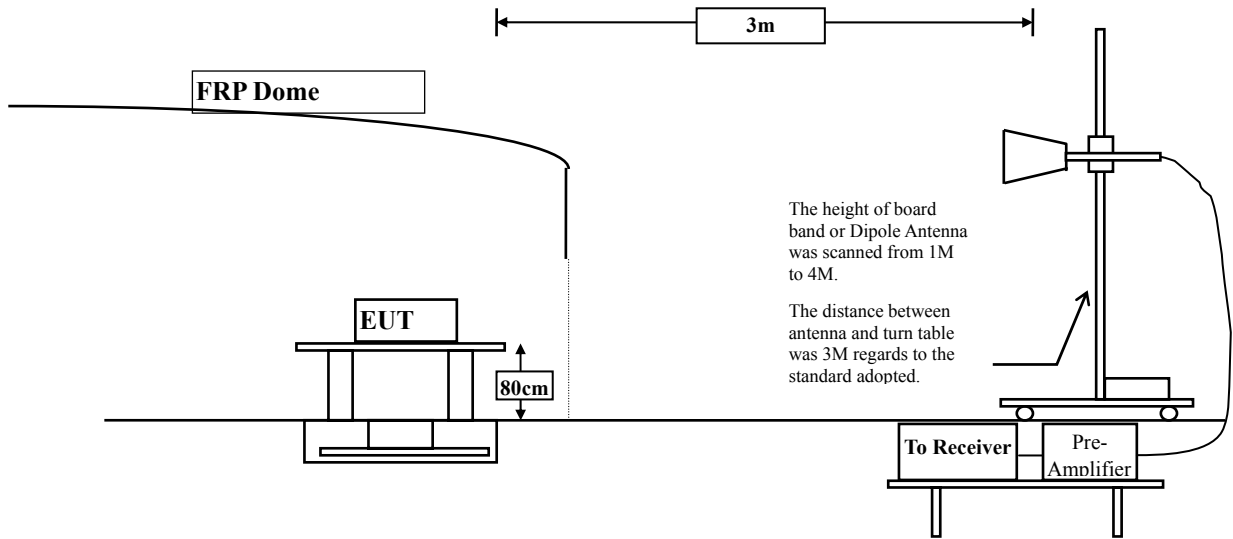

4.3. Limits

➤ General Radiated Emission Limits

Emissions radiated outside of the specified frequency bands, except for harmonics, shall be attenuated by at least 20dB below the level of the fundamental or to the general radiated emission limits in paragraph 15.209, whichever is the lesser attenuation.

FCC Part 15 Subpart C Paragraph 15.209 Limits		
Frequency MHz	uV/m @3m	dBuV/m@3m
30-88	100	40
88-216	150	43.5
216-960	200	46
Above 960	500	54

- Remarks:
1. RF Voltage (dBuV) = 20 log RF Voltage (uV)
 2. In the Above Table, the tighter limit applies at the band edges.
 3. Distance refers to the distance in meters between the measuring instrument antenna and the closed point of any part of the device or system.

4.4. Test Procedure

The EUT was setup according to ANSI C63.10, 2009 and tested according to FHSS test procedure of FCC Public Notice DA 00-705 for compliance to FCC 47CFR 15.247 requirements.

The EUT is placed on a turn table which is 0.8 meter above ground. The turn table is rotated 360 degrees to determine the position of the maximum emission level. The EUT was positioned such that the distance from antenna to the EUT was 3 meters.

The antenna is scanned from 1 meter to 4 meters to find out the maximum emission level. This is repeated for both horizontal and vertical polarization of the antenna. In order to find the maximum emission, all of the interface cables were manipulated according to ANSI C63.4, 2003 on radiated measurement.

The resolution bandwidth below 1GHz setting on the field strength meter is 120 kHz and above 1GHz is 1MHz.

Radiated emission measurements below 1GHz are made using broadband Bilog antenna and above 1GHz are made using Horn Antennas.

The measurement is divided into the Preliminary Measurement and the Final Measurement.

The suspected frequencies are searched for in Preliminary Measurement with the measurement antenna kept pointed at the source of the emission both in azimuth and elevation, with the polarization of the antenna oriented for maximum response. The antenna is pointed at an angle towards the source of the emission, and the EUT is rotated in both height and polarization to maximize the measured emission. The emission is kept within the illumination area of the 3 dB bandwidth of the antenna.

The worst radiated emission is measured on the Final Measurement.

The measurement frequency range form 30MHz - 10th Harmonic of fundamental was investigated.

4.5. Uncertainty

± 3.9 dB above 1GHz

± 3.8 dB below 1GHz

4.6. Test Result of Radiated Emission

Product : Bar Code Printer
 Test Item : Harmonic Radiated Emission
 Test Site : No.3 OATS
 Test Mode : Mode 1: Transmit - 1Mbps (GFSK)(2402MHz)

Frequency MHz	Correct Factor dB	Reading Level dBuV	Measurement Level dBuV/m	Margin dB	Limit dBuV/m
Horizontal					
Peak Detector:					
4804.000	3.327	42.550	45.877	-28.123	74.000
7206.000	10.136	38.280	48.416	-25.584	74.000
9608.000	13.706	36.970	50.676	-23.324	74.000
Average Detector:					
--					
Vertical					
Peak Detector:					
4804.000	6.638	45.390	52.027	-21.973	74.000
7206.000	11.005	37.870	48.875	-25.125	74.000
9608.000	14.103	37.630	51.733	-22.267	74.000
Average Detector:					
--					

Note:

1. All Readings below 1GHz are Quasi-Peak, above 1GHz are performed with peak and/or average measurements as necessary.
2. Peak measurements: RBW = 1MHz, VBW = 3 MHz, Sweep: Auto.
3. Average measurements: RBW = 1MHz, VBW = 10 Hz, Sweep: Auto.
4. Measurement Level = Reading Level + Correct Factor.
5. Correct Factor = Antenna factor + Cable loss – Amplifier gain.
6. The average measurement was not performed when the peak measured data under the limit of average detection.
7. The emission levels of other frequencies are very lower than the limit and not show in test report.

Product : Bar Code Printer
 Test Item : Harmonic Radiated Emission
 Test Site : No.3 OATS
 Test Mode : Mode 1: Transmit - 1Mbps (GFSK)(2441MHz)

Frequency MHz	Correct Factor dB	Reading Level dBuV	Measurement Level dBuV/m	Margin dB	Limit dBuV/m
Horizontal					
Peak Detector:					
4882.000	3.001	42.390	45.391	-28.609	74.000
7323.000	11.846	36.260	48.107	-25.893	74.000
9764.000	12.563	37.790	50.353	-23.647	74.000
Average Detector:					
--					
Vertical					
Peak Detector:					
4882.000	5.713	45.350	51.064	-22.936	74.000
7323.000	12.727	36.550	49.278	-24.722	74.000
9764.000	13.028	37.750	50.778	-23.222	74.000
Average Detector:					
--					

Note:

1. All Readings below 1GHz are Quasi-Peak, above 1GHz are performed with peak and/or average measurements as necessary.
2. Peak measurements: RBW = 1MHz, VBW = 3 MHz, Sweep: Auto.
3. Average measurements: RBW = 1MHz, VBW = 10 Hz, Sweep: Auto.
4. Measurement Level = Reading Level + Correct Factor.
5. Correct Factor = Antenna factor + Cable loss – Amplifier gain.
6. The average measurement was not performed when the peak measured data under the limit of average detection.
7. The emission levels of other frequencies are very lower than the limit and not show in test report.

Product : Bar Code Printer
 Test Item : Harmonic Radiated Emission
 Test Site : No.3 OATS
 Test Mode : Mode 1: Transmit - 1Mbps (GFSK)(2480MHz)

Frequency MHz	Correct Factor dB	Reading Level dBuV	Measurement Level dBuV/m	Margin dB	Limit dBuV/m
Horizontal					
Peak Detector:					
4960.000	2.760	41.870	44.630	-29.370	74.000
7440.000	12.567	35.870	48.436	-25.564	74.000
9920.000	13.456	37.280	50.736	-23.264	74.000
Average Detector:					
--					
Vertical					
Peak Detector:					
4960.000	5.557	45.950	51.507	-22.493	74.000
7440.000	13.426	35.800	49.225	-24.775	74.000
9920.000	13.958	37.220	51.178	-22.822	74.000
Average Detector:					
--					

Note:

1. All Readings below 1GHz are Quasi-Peak, above 1GHz are performed with peak and/or average measurements as necessary.
2. Peak measurements: RBW = 1MHz, VBW = 3 MHz, Sweep: Auto.
3. Average measurements: RBW = 1MHz, VBW = 10 Hz, Sweep: Auto.
4. Measurement Level = Reading Level + Correct Factor.
5. Correct Factor = Antenna factor + Cable loss – Amplifier gain.
6. The average measurement was not performed when the peak measured data under the limit of average detection.
7. The emission levels of other frequencies are very lower than the limit and not show in test report.

Product : Bar Code Printer
 Test Item : Harmonic Radiated Emission
 Test Site : No.3 OATS
 Test Mode : Mode 2: Transmit - 3Mbps (8DPSK)(2402MHz)

Frequency MHz	Correct Factor dB	Reading Level dBuV	Measurement Level dBuV/m	Margin dB	Limit dBuV/m
Horizontal					
Peak Detector:					
4804.000	3.327	39.560	42.887	-31.113	74.000
7206.000	10.136	37.440	47.576	-26.424	74.000
9608.000	13.706	37.340	51.046	-22.954	74.000
Average Detector:					
--					
Vertical					
Peak Detector:					
4804.000	6.638	42.220	48.857	-25.143	74.000
7206.000	11.005	37.660	48.665	-25.335	74.000
9608.000	14.103	38.200	52.303	-21.697	74.000
Average Detector:					
--					

Note:

1. All Readings below 1GHz are Quasi-Peak, above 1GHz are performed with peak and/or average measurements as necessary.
2. Peak measurements: RBW = 1MHz, VBW = 3 MHz, Sweep: Auto.
3. Average measurements: RBW = 1MHz, VBW = 10 Hz, Sweep: Auto.
4. Measurement Level = Reading Level + Correct Factor.
5. Correct Factor = Antenna factor + Cable loss – Amplifier gain.
6. The average measurement was not performed when the peak measured data under the limit of average detection.
7. The emission levels of other frequencies are very lower than the limit and not show in test report.

Product : Bar Code Printer
 Test Item : Harmonic Radiated Emission
 Test Site : No.3 OATS
 Test Mode : Mode 2: Transmit - 3Mbps (8DPSK) (2441MHz)

Frequency MHz	Correct Factor dB	Reading Level dBuV	Measurement Level dBuV/m	Margin dB	Limit dBuV/m
Horizontal					
Peak Detector:					
4882.000	3.001	38.930	41.931	-32.069	74.000
7323.000	11.846	37.110	48.957	-25.043	74.000
9764.000	12.563	37.270	49.833	-24.167	74.000
Average Detector:					
--					
Vertical					
Peak Detector:					
4882.000	5.713	39.990	45.704	-28.296	74.000
7323.000	12.727	36.960	49.688	-24.312	74.000
9764.000	13.028	37.730	50.758	-23.242	74.000
Average Detector:					
--					

Note:

1. All Readings below 1GHz are Quasi-Peak, above 1GHz are performed with peak and/or average measurements as necessary.
2. Peak measurements: RBW = 1MHz, VBW = 3 MHz, Sweep: Auto.
3. Average measurements: RBW = 1MHz, VBW = 10 Hz, Sweep: Auto.
4. Measurement Level = Reading Level + Correct Factor.
5. Correct Factor = Antenna factor + Cable loss – Amplifier gain.
6. The average measurement was not performed when the peak measured data under the limit of average detection.
7. The emission levels of other frequencies are very lower than the limit and not show in test report.

Product : Bar Code Printer
 Test Item : Harmonic Radiated Emission
 Test Site : No.3 OATS
 Test Mode : Mode 2: Transmit - 3Mbps (8DPSK) (2480MHz)

Frequency MHz	Correct Factor dB	Reading Level dBuV	Measurement Level dBuV/m	Margin dB	Limit dBuV/m
Horizontal					
Peak Detector:					
4960.000	2.760	38.860	41.620	-32.380	74.000
7440.000	12.567	36.470	49.036	-24.964	74.000
9920.000	13.456	37.350	50.806	-23.194	74.000
Average Detector:					
--					
Vertical					
Peak Detector:					
4960.000	5.557	40.260	45.817	-28.183	74.000
7440.000	13.426	36.550	49.975	-24.025	74.000
9920.000	13.958	37.250	51.208	-22.792	74.000
Average Detector:					
--					

Note:

1. All Readings below 1GHz are Quasi-Peak, above 1GHz are performed with peak and/or average measurements as necessary.
2. Peak measurements: RBW = 1MHz, VBW = 3 MHz, Sweep: Auto.
3. Average measurements: RBW = 1MHz, VBW = 10 Hz, Sweep: Auto.
4. Measurement Level = Reading Level + Correct Factor.
5. Correct Factor = Antenna factor + Cable loss – Amplifier gain.
6. The average measurement was not performed when the peak measured data under the limit of average detection.
7. The emission levels of other frequencies are very lower than the limit and not show in test report.

Product : Bar Code Printer
 Test Item : General Radiated Emission
 Test Site : No.3 OATS
 Test Mode : Mode 1: Transmit - 1Mbps (GFSK) -Adapter(1) (2441MHz)

Frequency MHz	Correct Factor dB	Reading Level dBuV	Measurement Level dBuV/m	Margin dB	Limit dBuV/m
Horizontal					
37.760	-2.539	36.561	34.023	-5.977	40.000
115.360	-7.390	42.721	35.332	-8.168	43.500
400.540	0.942	36.598	37.540	-8.460	46.000
547.980	4.028	31.280	35.308	-10.692	46.000
683.780	2.811	35.879	38.690	-7.310	46.000
868.080	6.021	28.830	34.851	-11.149	46.000
Vertical					
103.720	-5.090	37.612	32.521	-10.979	43.500
299.660	-4.061	35.582	31.521	-14.479	46.000
499.480	-0.199	35.769	35.569	-10.431	46.000
689.600	2.302	32.537	34.839	-11.161	46.000
825.400	3.016	29.069	32.085	-13.915	46.000
949.560	3.156	30.797	33.953	-12.047	46.000

Note:

1. All Readings below 1GHz are Quasi-Peak, above 1GHz are performed with peak and/or average measurements as necessary.
2. Peak measurements: RBW = 1MHz, VBW = 3 MHz, Sweep: Auto.
3. Average measurements: RBW = 1MHz, VBW = 10 Hz, Sweep: Auto.
4. Measurement Level = Reading Level + Correct Factor.
5. Correct Factor = Antenna factor + Cable loss – Amplifier gain.
6. The average measurement was not performed when the peak measured data under the limit of average detection.
7. The emission levels of other frequencies are very lower than the limit and not show in test report.

Product : Bar Code Printer
 Test Item : General Radiated Emission
 Test Site : No.3 OATS
 Test Mode : Mode 2: Transmit - 3Mbps (8DPSK) -Adapter(1) (2441MHz)

Frequency MHz	Correct Factor dB	Reading Level dBuV	Measurement Level dBuV/m	Margin dB	Limit dBuV/m
Horizontal					
258.920	-5.440	32.608	27.168	-18.832	46.000
396.660	0.771	37.951	38.722	-7.278	46.000
598.420	3.524	32.550	36.074	-9.926	46.000
714.820	3.801	37.049	40.850	-5.150	46.000
864.200	6.329	29.646	35.975	-10.025	46.000
972.840	7.189	26.881	34.070	-19.930	54.000
Vertical					
109.540	-3.507	38.466	34.958	-8.542	43.500
198.780	-5.708	36.167	30.459	-13.041	43.500
396.660	-2.039	37.951	35.912	-10.088	46.000
499.480	-0.199	36.422	36.222	-9.778	46.000
691.540	2.092	34.464	36.556	-9.444	46.000
928.220	3.640	33.639	37.279	-8.721	46.000

Note:

1. All Readings below 1GHz are Quasi-Peak, above 1GHz are performed with peak and/or average measurements as necessary.
2. Peak measurements: RBW = 1MHz, VBW = 3 MHz, Sweep: Auto.
3. Average measurements: RBW = 1MHz, VBW = 10 Hz, Sweep: Auto.
4. Measurement Level = Reading Level + Correct Factor.
5. Correct Factor = Antenna factor + Cable loss –Amplifier gain.
6. The average measurement was not performed when the peak measured data under the limit of average detection.
7. The emission levels of other frequencies are very lower than the limit and not show in test report.

Product : Bar Code Printer
 Test Item : General Radiated Emission
 Test Site : No.3 OATS
 Test Mode : Mode 1: Transmit - 1Mbps (GFSK) -Adapter(2) (2441MHz)

Frequency MHz	Correct Factor dB	Reading Level dBuV	Measurement Level dBuV/m	Margin dB	Limit dBuV/m
Horizontal					
132.820	-7.442	38.829	31.387	-12.113	43.500
299.660	-4.751	36.997	32.246	-13.754	46.000
450.980	0.835	35.298	36.133	-9.867	46.000
598.420	3.524	34.746	38.270	-7.730	46.000
807.940	6.231	28.665	34.896	-11.104	46.000
972.840	7.189	28.146	35.335	-18.665	54.000
Vertical					
80.440	-4.848	36.643	31.795	-8.205	40.000
264.740	-5.071	33.463	28.393	-17.607	46.000
421.880	-7.070	35.561	28.491	-17.509	46.000
590.660	-1.979	30.121	28.142	-17.858	46.000
736.160	-0.866	34.910	34.044	-11.956	46.000
881.660	1.379	30.918	32.297	-13.703	46.000

Note:

1. All Readings below 1GHz are Quasi-Peak, above 1GHz are performed with peak and/or average measurements as necessary.
2. Peak measurements: RBW = 1MHz, VBW = 3 MHz, Sweep: Auto.
3. Average measurements: RBW = 1MHz, VBW = 10 Hz, Sweep: Auto.
4. Measurement Level = Reading Level + Correct Factor.
5. Correct Factor = Antenna factor + Cable loss –Amplifier gain.
6. The average measurement was not performed when the peak measured data under the limit of average detection.
7. The emission levels of other frequencies are very lower than the limit and not show in test report.

Product : Bar Code Printer
 Test Item : General Radiated Emission
 Test Site : No.3 OATS
 Test Mode : Mode 2: Transmit - 3Mbps (8DPSK) -Adapter(2) (2441MHz)

Frequency MHz	Correct Factor dB	Reading Level dBuV	Measurement Level dBuV/m	Margin dB	Limit dBuV/m
Horizontal					
115.360	-7.390	42.721	35.332	-8.168	43.500
373.380	0.873	32.458	33.331	-12.669	46.000
544.100	4.373	29.346	33.719	-12.281	46.000
683.780	2.811	35.879	38.690	-7.310	46.000
879.720	6.618	28.174	34.792	-11.208	46.000
988.360	7.541	26.801	34.342	-19.658	54.000
Vertical					
59.100	-11.291	40.525	29.234	-10.766	40.000
340.400	-1.287	29.939	28.652	-17.348	46.000
526.640	1.152	29.784	30.936	-15.064	46.000
672.140	-0.561	34.683	34.122	-11.878	46.000
809.880	3.026	28.144	31.170	-14.830	46.000
937.920	3.110	28.569	31.679	-14.321	46.000

Note:

1. All Readings below 1GHz are Quasi-Peak, above 1GHz are performed with peak and/or average measurements as necessary.
2. Peak measurements: RBW = 1MHz, VBW = 3 MHz, Sweep: Auto.
3. Average measurements: RBW = 1MHz, VBW = 10 Hz, Sweep: Auto.
4. Measurement Level = Reading Level + Correct Factor.
5. Correct Factor = Antenna factor + Cable loss –Amplifier gain.
6. The average measurement was not performed when the peak measured data under the limit of average detection.
7. The emission levels of other frequencies are very lower than the limit and not show in test report.

Product : Bar Code Printer
 Test Item : General Radiated Emission
 Test Site : No.3 OATS
 Test Mode : Mode 1: Transmit - 1Mbps (GFSK) -Adapter(3) (2441MHz)

Frequency MHz	Correct Factor dB	Reading Level dBuV	Measurement Level dBuV/m	Margin dB	Limit dBuV/m
Horizontal					
198.780	-9.958	39.228	29.270	-14.230	43.500
392.780	0.810	32.835	33.645	-12.355	46.000
573.200	2.691	30.481	33.171	-12.829	46.000
734.220	3.155	35.147	38.303	-7.697	46.000
877.780	6.207	29.795	36.002	-9.998	46.000
963.140	7.021	29.304	36.325	-17.675	54.000
Vertical					
148.340	-5.406	37.606	32.200	-11.300	43.500
299.660	-4.061	36.997	32.936	-13.064	46.000
458.740	-2.562	35.262	32.700	-13.300	46.000
600.360	1.302	31.896	33.198	-12.802	46.000
730.340	-0.821	35.921	35.100	-10.900	46.000
870.020	-0.398	28.695	28.297	-17.703	46.000

Note:

1. All Readings below 1GHz are Quasi-Peak, above 1GHz are performed with peak and/or average measurements as necessary.
2. Peak measurements: RBW = 1MHz, VBW = 3 MHz, Sweep: Auto.
3. Average measurements: RBW = 1MHz, VBW = 10 Hz, Sweep: Auto.
4. Measurement Level = Reading Level + Correct Factor.
5. Correct Factor = Antenna factor + Cable loss –Amplifier gain.
6. The average measurement was not performed when the peak measured data under the limit of average detection.
7. The emission levels of other frequencies are very lower than the limit and not show in test report.

Product : Bar Code Printer
 Test Item : General Radiated Emission
 Test Site : No.3 OATS
 Test Mode : Mode 2: Transmit - 3Mbps (8DPSK) -Adapter(3) (2441MHz)

Frequency MHz	Correct Factor dB	Reading Level dBuV	Measurement Level dBuV/m	Margin dB	Limit dBuV/m
Horizontal					
198.780	-9.958	39.228	29.270	-14.230	43.500
350.100	-1.298	31.361	30.063	-15.937	46.000
516.940	3.200	32.386	35.586	-10.414	46.000
660.500	1.889	35.328	37.217	-8.783	46.000
829.280	7.376	29.485	36.861	-9.139	46.000
955.380	6.596	25.215	31.811	-14.189	46.000
Vertical					
175.500	-1.842	32.845	31.003	-12.497	43.500
324.880	-3.120	32.175	29.055	-16.945	46.000
468.440	-3.566	35.197	31.631	-14.369	46.000
633.340	-1.450	33.840	32.390	-13.610	46.000
778.840	2.580	32.568	35.148	-10.852	46.000
906.880	0.799	30.462	31.261	-14.739	46.000

Note:

1. All Readings below 1GHz are Quasi-Peak, above 1GHz are performed with peak and/or average measurements as necessary.
2. Peak measurements: RBW = 1MHz, VBW = 3 MHz, Sweep: Auto.
3. Average measurements: RBW = 1MHz, VBW = 10 Hz, Sweep: Auto.
4. Measurement Level = Reading Level + Correct Factor.
5. Correct Factor = Antenna factor + Cable loss –Amplifier gain.
6. The average measurement was not performed when the peak measured data under the limit of average detection.
7. The emission levels of other frequencies are very lower than the limit and not show in test report.

Product : Bar Code Printer
 Test Item : General Radiated Emission
 Test Site : No.3 OATS
 Test Mode : Mode 1: Transmit - 1Mbps (GFSK) -Adapter(4) (2441MHz)

Frequency MHz	Correct Factor dB	Reading Level dBuV	Measurement Level dBuV/m	Margin dB	Limit dBuV/m
Horizontal					
148.340	-7.806	37.606	29.800	-13.700	43.500
402.480	0.915	34.648	35.563	-10.437	46.000
573.200	2.691	30.481	33.171	-12.829	46.000
736.160	2.994	34.910	37.904	-8.096	46.000
835.100	6.131	27.902	34.033	-11.967	46.000
951.500	6.993	27.271	34.264	-11.736	46.000
Vertical					
179.380	-0.824	32.901	32.077	-11.423	43.500
299.660	-4.061	36.997	32.936	-13.064	46.000
431.580	-7.703	39.762	32.059	-13.941	46.000
582.900	-2.259	31.072	28.813	-17.187	46.000
728.400	-0.799	36.001	35.201	-10.799	46.000
881.660	1.379	30.918	32.297	-13.703	46.000

Note:

1. All Readings below 1GHz are Quasi-Peak, above 1GHz are performed with peak and/or average measurements as necessary.
2. Peak measurements: RBW = 1MHz, VBW = 3 MHz, Sweep: Auto.
3. Average measurements: RBW = 1MHz, VBW = 10 Hz, Sweep: Auto.
4. Measurement Level = Reading Level + Correct Factor.
5. Correct Factor = Antenna factor + Cable loss –Amplifier gain.
6. The average measurement was not performed when the peak measured data under the limit of average detection.
7. The emission levels of other frequencies are very lower than the limit and not show in test report.

Product : Bar Code Printer
 Test Item : General Radiated Emission
 Test Site : No.3 OATS
 Test Mode : Mode 2: Transmit - 3Mbps (8DPSK) -Adapter(4) (2441MHz)

Frequency MHz	Correct Factor dB	Reading Level dBuV	Measurement Level dBuV/m	Margin dB	Limit dBuV/m
Horizontal					
59.100	-11.901	40.525	28.624	-11.376	40.000
295.780	-4.747	31.239	26.492	-19.508	46.000
445.160	-0.432	34.639	34.207	-11.793	46.000
565.440	1.957	29.229	31.186	-14.814	46.000
726.460	3.832	36.292	40.124	-5.876	46.000
897.180	5.487	28.924	34.411	-11.589	46.000
Vertical					
95.960	-6.836	38.831	31.995	-11.505	43.500
258.920	-4.900	35.009	30.109	-15.891	46.000
431.580	-7.703	39.762	32.059	-13.941	46.000
598.420	1.114	34.746	35.860	-10.140	46.000
796.300	2.639	31.993	34.632	-11.368	46.000
934.040	2.986	33.295	36.281	-9.719	46.000

Note:

1. All Readings below 1GHz are Quasi-Peak, above 1GHz are performed with peak and/or average measurements as necessary.
2. Peak measurements: RBW = 1MHz, VBW = 3 MHz, Sweep: Auto.
3. Average measurements: RBW = 1MHz, VBW = 10 Hz, Sweep: Auto.
4. Measurement Level = Reading Level + Correct Factor.
5. Correct Factor = Antenna factor + Cable loss –Amplifier gain.
6. The average measurement was not performed when the peak measured data under the limit of average detection.
7. The emission levels of other frequencies are very lower than the limit and not show in test report.

Product : Bar Code Printer
 Test Item : General Radiated Emission
 Test Site : No.3 OATS
 Test Mode : Mode 1: Transmit - 1Mbps (GFSK) -Adapter(5) (2441MHz)

Frequency MHz	Correct Factor dB	Reading Level dBuV	Measurement Level dBuV/m	Margin dB	Limit dBuV/m
Horizontal					
301.600	-3.375	42.985	39.611	-6.389	46.000
456.800	-0.067	38.503	38.436	-7.564	46.000
586.780	3.436	33.415	36.851	-9.149	46.000
672.140	2.291	37.385	39.676	-6.324	46.000
782.720	4.325	33.580	37.905	-8.095	46.000
912.700	6.132	30.420	36.552	-9.448	46.000
Vertical					
64.920	-5.683	37.026	31.343	-8.657	40.000
260.860	-7.462	35.166	27.704	-18.296	46.000
456.800	-4.697	39.753	35.056	-10.944	46.000
716.760	-0.653	30.796	30.143	-15.857	46.000
782.720	3.035	28.726	31.761	-14.239	46.000
912.700	1.762	30.298	32.060	-13.940	46.000

Note:

1. All Readings below 1GHz are Quasi-Peak, above 1GHz are performed with peak and/or average measurements as necessary.
2. Peak measurements: RBW = 1MHz, VBW = 3 MHz, Sweep: Auto.
3. Average measurements: RBW = 1MHz, VBW = 10 Hz, Sweep: Auto.
4. Measurement Level = Reading Level + Correct Factor.
5. Correct Factor = Antenna factor + Cable loss –Amplifier gain.
6. The average measurement was not performed when the peak measured data under the limit of average detection.
7. The emission levels of other frequencies are very lower than the limit and not show in test report.

Product : Bar Code Printer
 Test Item : General Radiated Emission
 Test Site : No.3 OATS
 Test Mode : Mode 2: Transmit - 3Mbps (8DPSK) -Adapter(5) (2441MHz)

Frequency MHz	Correct Factor dB	Reading Level dBuV	Measurement Level dBuV/m	Margin dB	Limit dBuV/m
Horizontal					
301.600	-3.375	43.066	39.692	-6.308	46.000
456.800	-0.067	38.450	38.383	-7.617	46.000
586.780	3.436	35.377	38.813	-7.187	46.000
716.760	3.537	35.476	39.013	-6.987	46.000
782.720	4.325	33.595	37.920	-8.080	46.000
912.700	6.132	30.183	36.315	-9.685	46.000
Vertical					
64.920	-5.683	37.444	31.761	-8.239	40.000
390.840	-3.099	35.586	32.487	-13.513	46.000
456.800	-4.697	39.999	35.302	-10.698	46.000
520.820	-0.298	29.195	28.897	-17.103	46.000
782.720	3.035	28.776	31.811	-14.189	46.000
912.700	1.762	30.311	32.073	-13.927	46.000

Note:

1. All Readings below 1GHz are Quasi-Peak, above 1GHz are performed with peak and/or average measurements as necessary.
2. Peak measurements: RBW = 1MHz, VBW = 3 MHz, Sweep: Auto.
3. Average measurements: RBW = 1MHz, VBW = 10 Hz, Sweep: Auto.
4. Measurement Level = Reading Level + Correct Factor.
5. Correct Factor = Antenna factor + Cable loss –Amplifier gain.
6. The average measurement was not performed when the peak measured data under the limit of average detection.
7. The emission levels of other frequencies are very lower than the limit and not show in test report.

Product : Bar Code Printer
 Test Item : General Radiated Emission
 Test Site : No.3 OATS
 Test Mode : Mode 1: Transmit - 1Mbps (GFSK) -Adapter(6) (2441MHz)

Frequency MHz	Correct Factor dB	Reading Level dBuV	Measurement Level dBuV/m	Margin dB	Limit dBuV/m
Horizontal					
198.780	-10.661	30.841	20.180	-23.320	43.500
297.720	-3.633	30.711	27.079	-18.921	46.000
398.600	-2.268	32.266	29.998	-16.002	46.000
596.480	4.017	28.659	32.676	-13.324	46.000
796.300	5.161	27.606	32.767	-13.233	46.000
897.180	5.182	28.268	33.450	-12.550	46.000
Vertical					
198.780	-8.221	33.490	25.269	-18.231	43.500
297.720	-7.143	31.684	24.542	-21.458	46.000
365.620	-2.179	27.903	25.724	-20.276	46.000
460.680	-3.221	25.460	22.239	-23.761	46.000
596.480	-3.113	33.050	29.937	-16.063	46.000
749.740	2.510	28.755	31.265	-14.735	46.000

Note:

1. All Readings below 1GHz are Quasi-Peak, above 1GHz are performed with peak and/or average measurements as necessary.
2. Peak measurements: RBW = 1MHz, VBW = 3 MHz, Sweep: Auto.
3. Average measurements: RBW = 1MHz, VBW = 10 Hz, Sweep: Auto.
4. Measurement Level = Reading Level + Correct Factor.
5. Correct Factor = Antenna factor + Cable loss – Amplifier gain.
6. The average measurement was not performed when the peak measured data under the limit of average detection.
7. The emission levels of other frequencies are very lower than the limit and not show in test report.

Product : Bar Code Printer
 Test Item : General Radiated Emission
 Test Site : No.3 OATS
 Test Mode : Mode 2: Transmit - 3Mbps (8DPSK) -Adapter(6) (2441MHz)

Frequency MHz	Correct Factor dB	Reading Level dBuV	Measurement Level dBuV/m	Margin dB	Limit dBuV/m
Horizontal					
198.780	-10.661	29.952	19.291	-24.209	43.500
297.720	-3.633	28.755	25.123	-20.877	46.000
497.540	-0.273	36.676	36.403	-9.597	46.000
598.420	3.991	28.726	32.717	-13.283	46.000
697.360	3.171	29.906	33.077	-12.923	46.000
897.180	5.182	27.832	33.014	-12.986	46.000
Vertical					
198.780	-8.221	32.181	23.960	-19.540	43.500
249.220	-7.634	31.082	23.448	-22.552	46.000
344.280	-3.171	29.950	26.780	-19.220	46.000
596.480	-3.113	32.251	29.138	-16.862	46.000
749.740	2.510	29.642	32.152	-13.848	46.000
844.800	3.181	25.210	28.391	-17.609	46.000

Note:

1. All Readings below 1GHz are Quasi-Peak, above 1GHz are performed with peak and/or average measurements as necessary.
2. Peak measurements: RBW = 1MHz, VBW = 3 MHz, Sweep: Auto.
3. Average measurements: RBW = 1MHz, VBW = 10 Hz, Sweep: Auto.
4. Measurement Level = Reading Level + Correct Factor.
5. Correct Factor = Antenna factor + Cable loss –Amplifier gain.
6. The average measurement was not performed when the peak measured data under the limit of average detection.
7. The emission levels of other frequencies are very lower than the limit and not show in test report.

5. RF Antenna Conducted Test

5.1. Test Equipment

	Equipment	Manufacturer	Model No./Serial No.	Last Cal.
	Spectrum Analyzer	R&S	FSP40 / 100170	Jun, 2013
	Spectrum Analyzer	Agilent	E4407B / US39440758	Jun, 2013
X	Spectrum Analyzer	Agilent	N9010A / MY48030495	Apr., 2013

Note: 1. All equipments are calibrated every one year.
 2. The test instruments Marked “X” are used to measure the final test results.

5.2. Test Setup

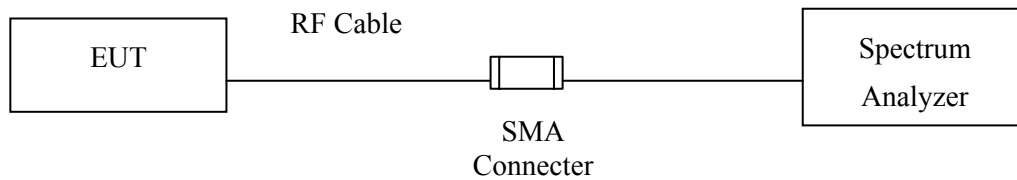

5.3. Limits

According to FCC Section 15.247(d). In any 100 kHz bandwidth outside the frequency band in which the spread spectrum or digitally modulated intentional radiator is operating, the radio frequency power that is produced by the intentional radiator shall be at least 20 dB below that in the 100 kHz bandwidth within the band that contains the highest level of the desired power, based on either an RF conducted or measurement, provided the transmitter demonstrates compliance with the peak conducted power limits. If the transmitter complies with the conducted power limits based on the use of RMS averaging over a time interval, the attenuation required under this paragraph shall be 30 dB instead of 20 dB.

5.4. Test Procedure

The EUT was setup to ANSI C63.10, 2009; tested to FHSS test procedure of FCC Public Notice DA 00-705 for compliance to FCC 47CFR 15.247 requirements.

5.5. Uncertainty

± 150Hz

5.6. Test Result of RF Antenna Conducted Test

Product : Bar Code Printer
 Test Item : RF Antenna Conducted Test
 Test Site : No.3 OATS
 Test Mode : Mode 1: Transmit - 1Mbps (GFSK)

Figure Channel 00:

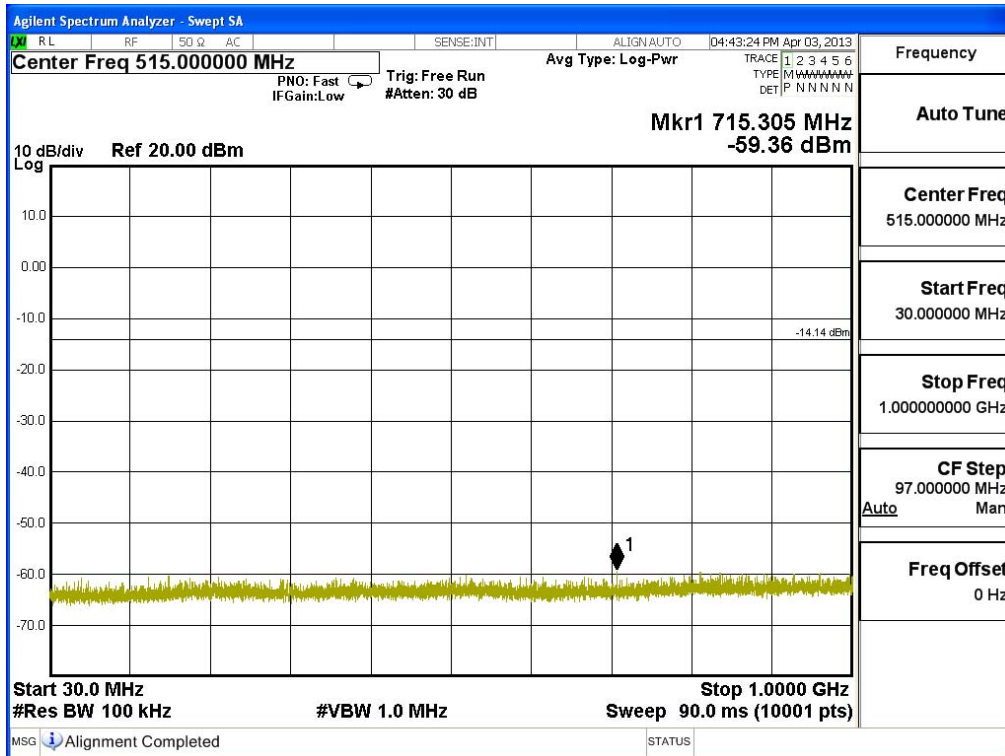

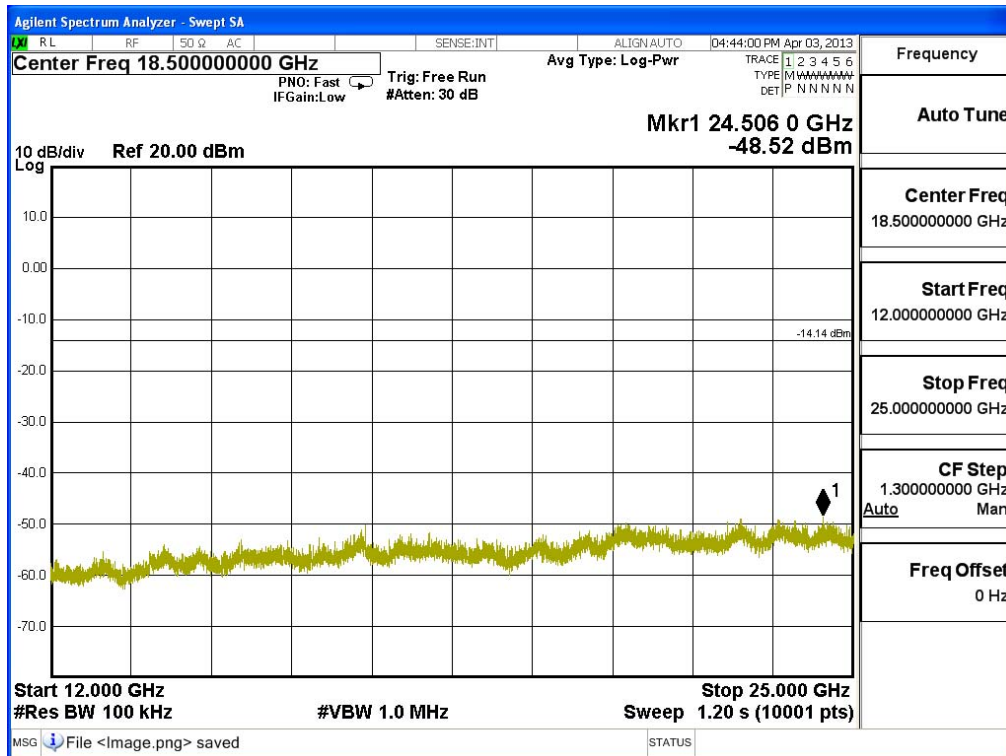
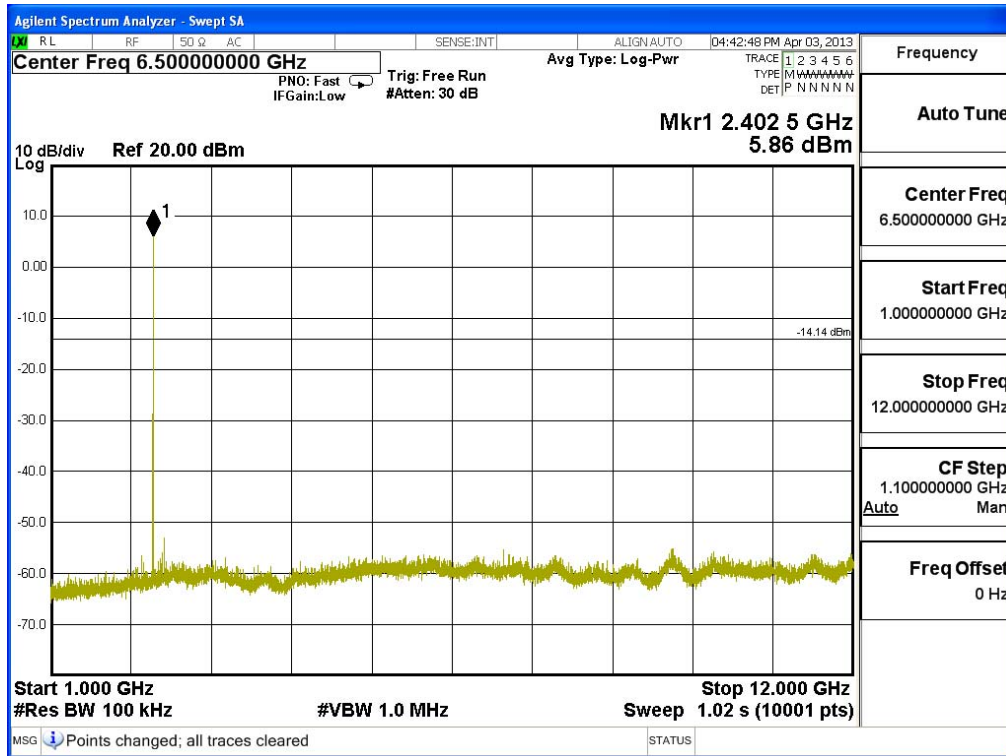

Product : Bar Code Printer
 Test Item : RF Antenna Conducted Test
 Test Site : No.3 OATS
 Test Mode : Mode 1: Transmit - 1Mbps (GFSK)

Figure Channel 39:

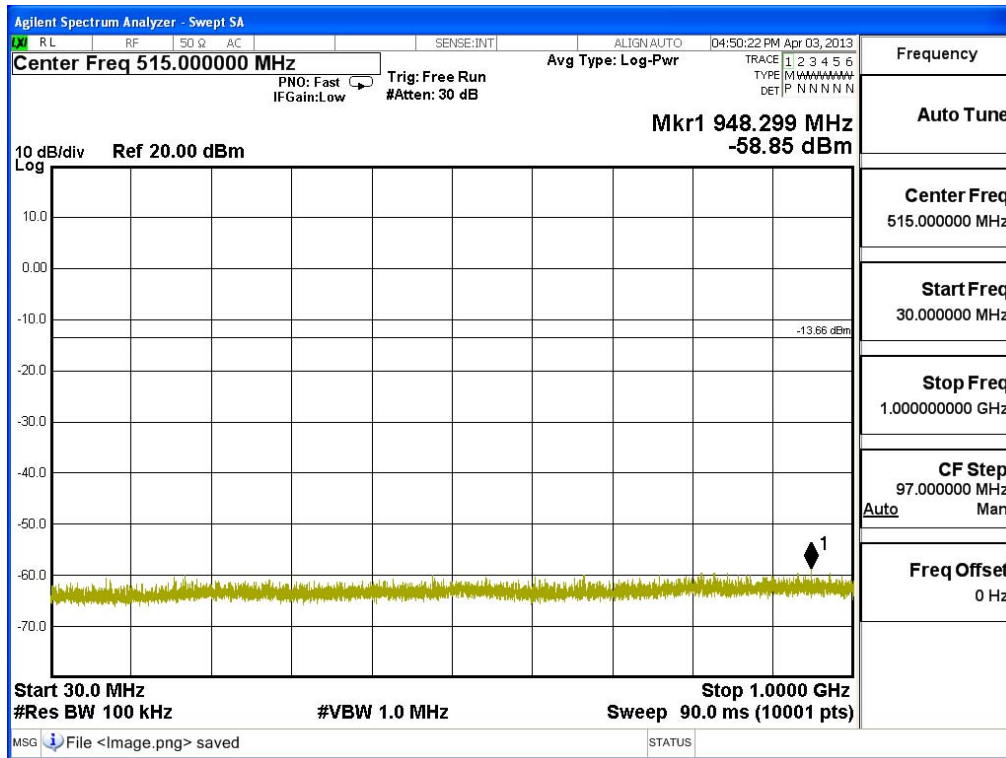

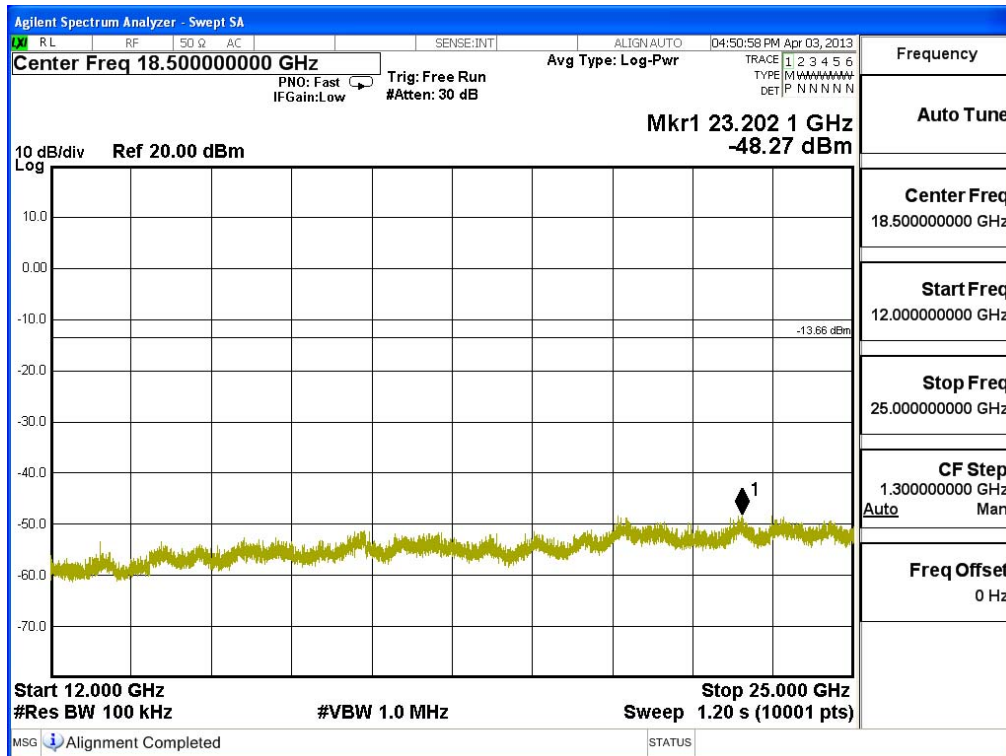
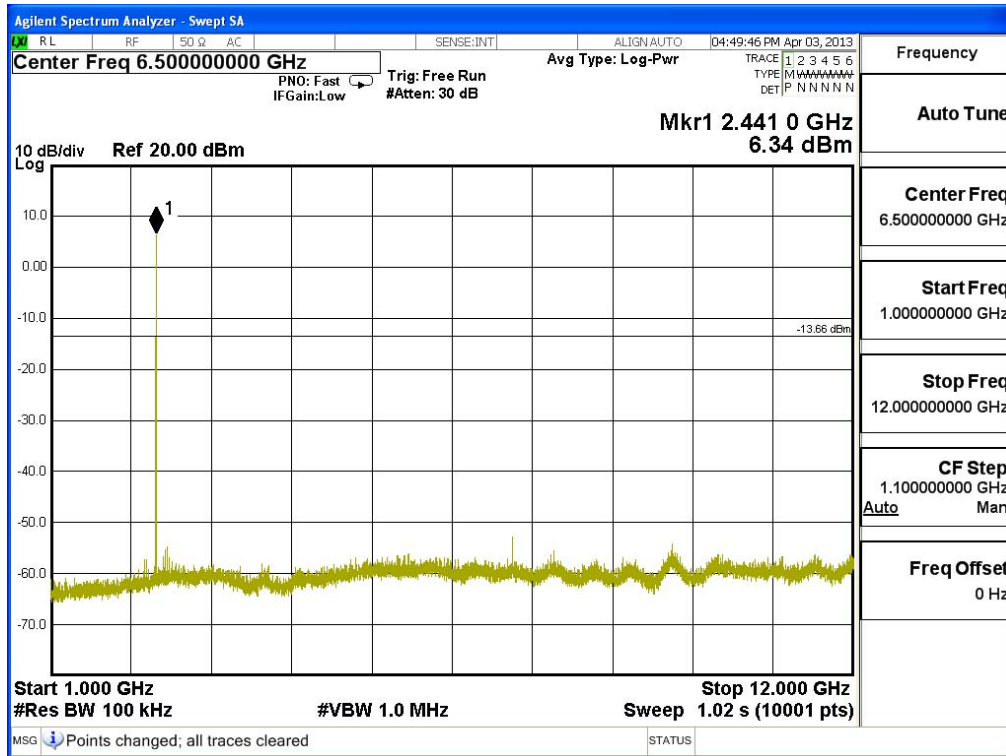

Product : Bar Code Printer
 Test Item : RF Antenna Conducted Test
 Test Site : No.3 OATS
 Test Mode : Mode 1: Transmit - 1Mbps (GFSK)

Figure Channel 78:

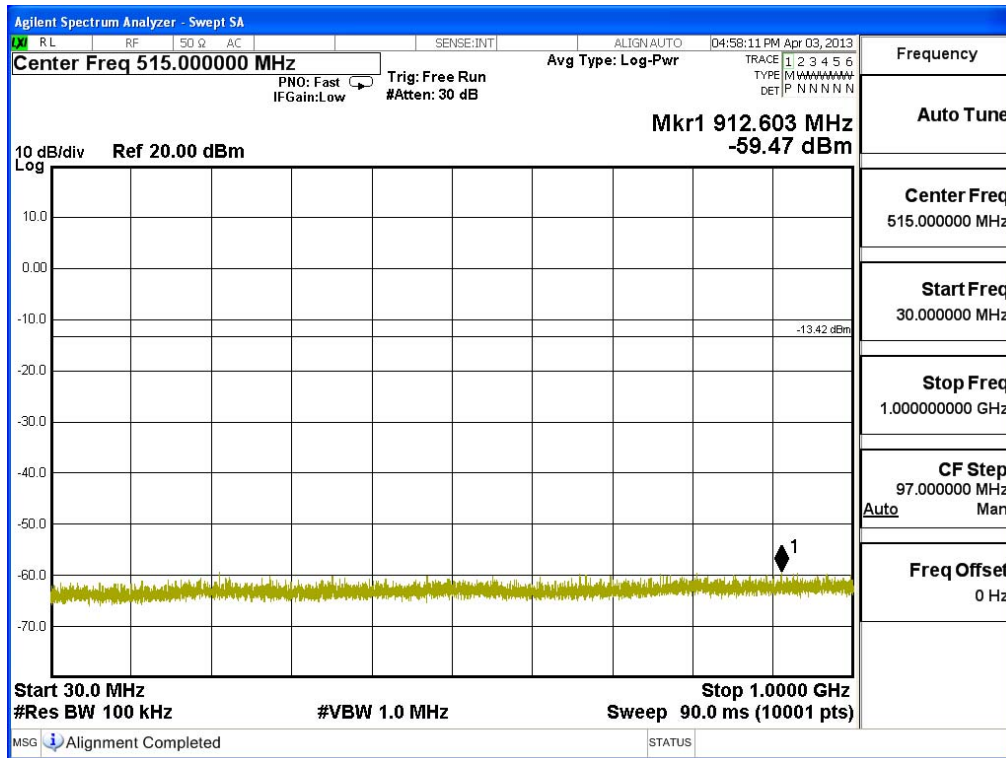

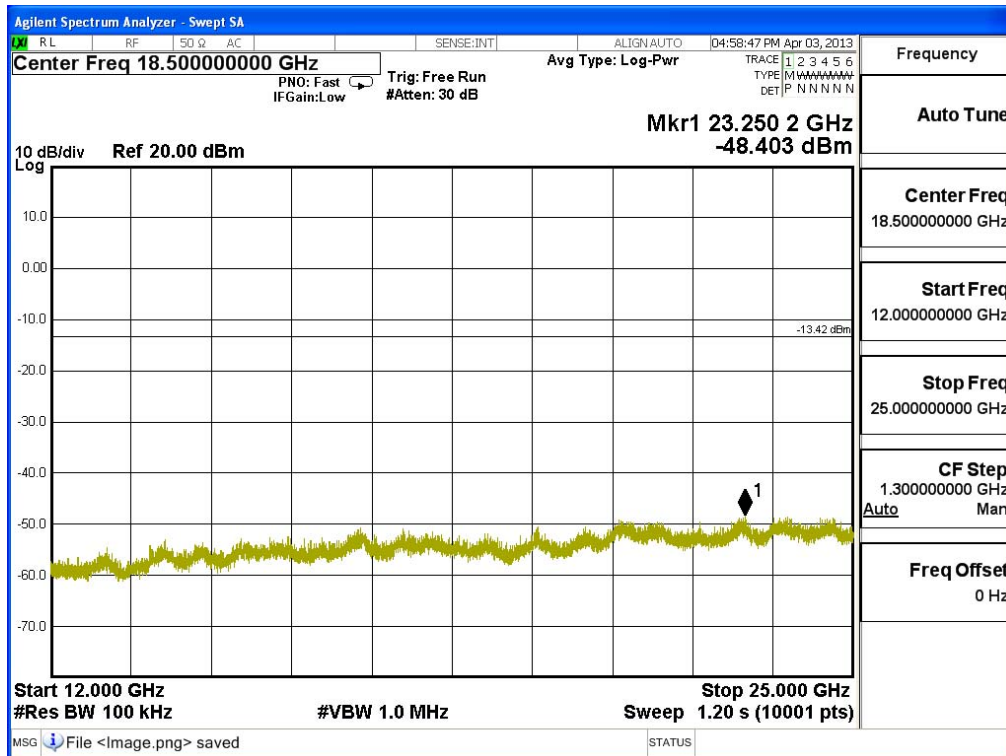
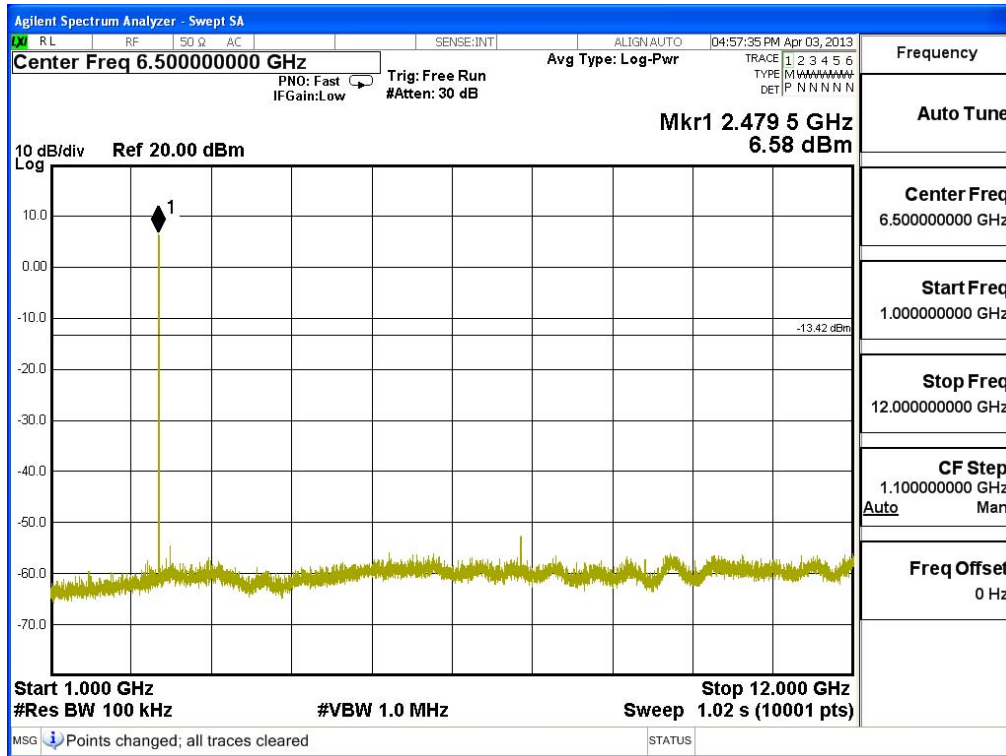

Product : Bar Code Printer
 Test Item : RF Antenna Conducted Test
 Test Site : No.3 OATS
 Test Mode : Mode 2: Transmit - 3Mbps (8DPSK)

Figure Channel 00:

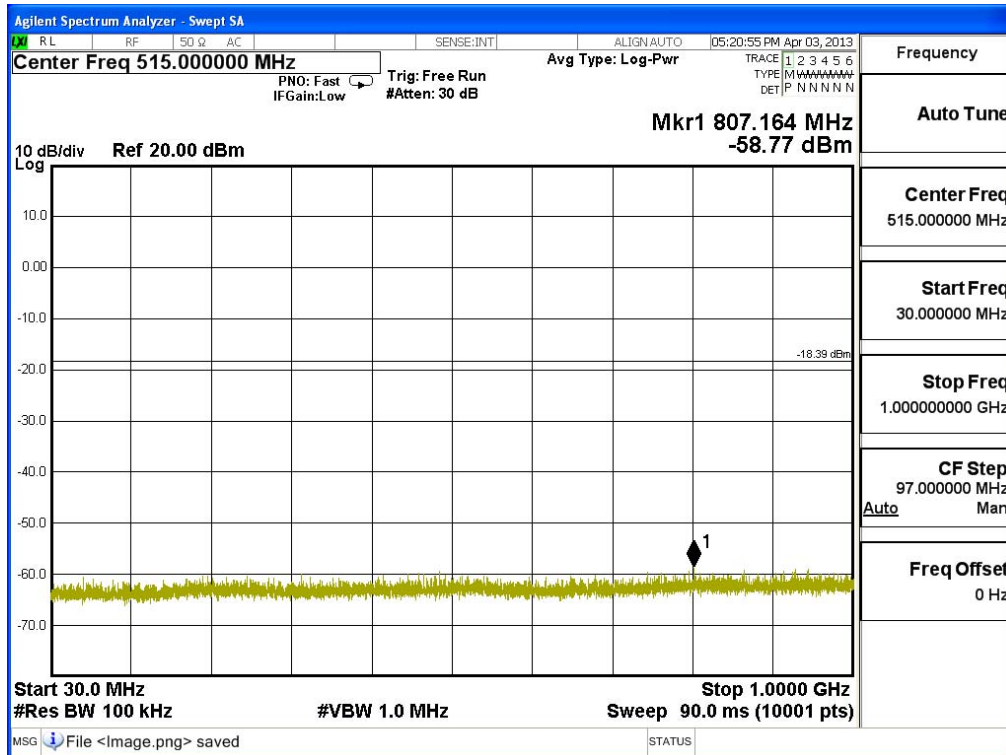

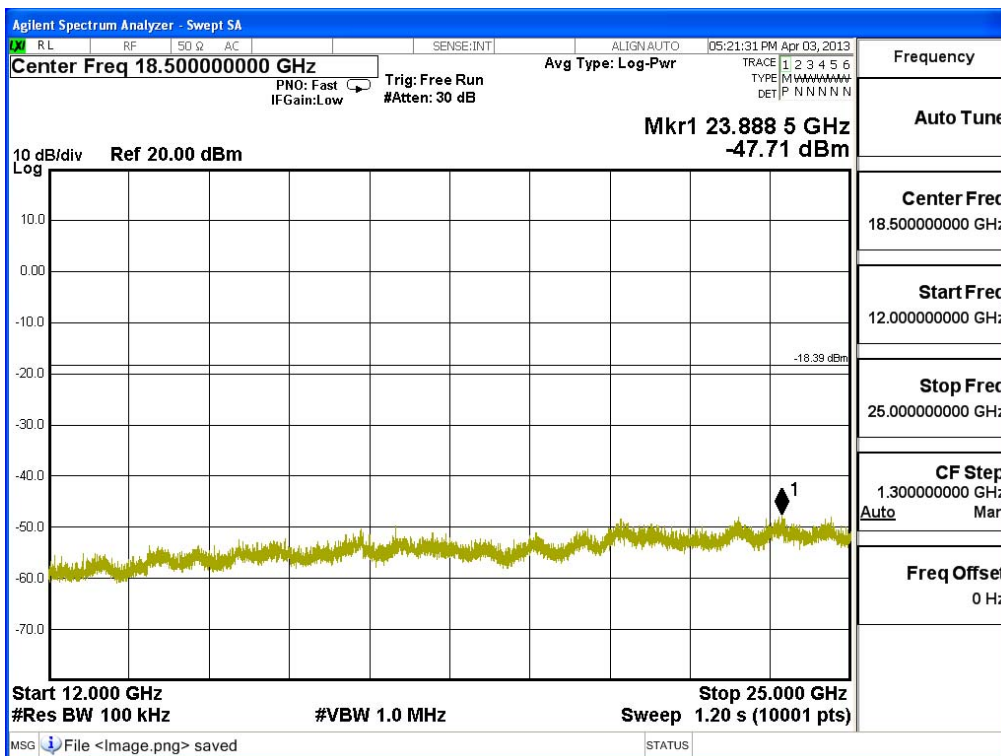
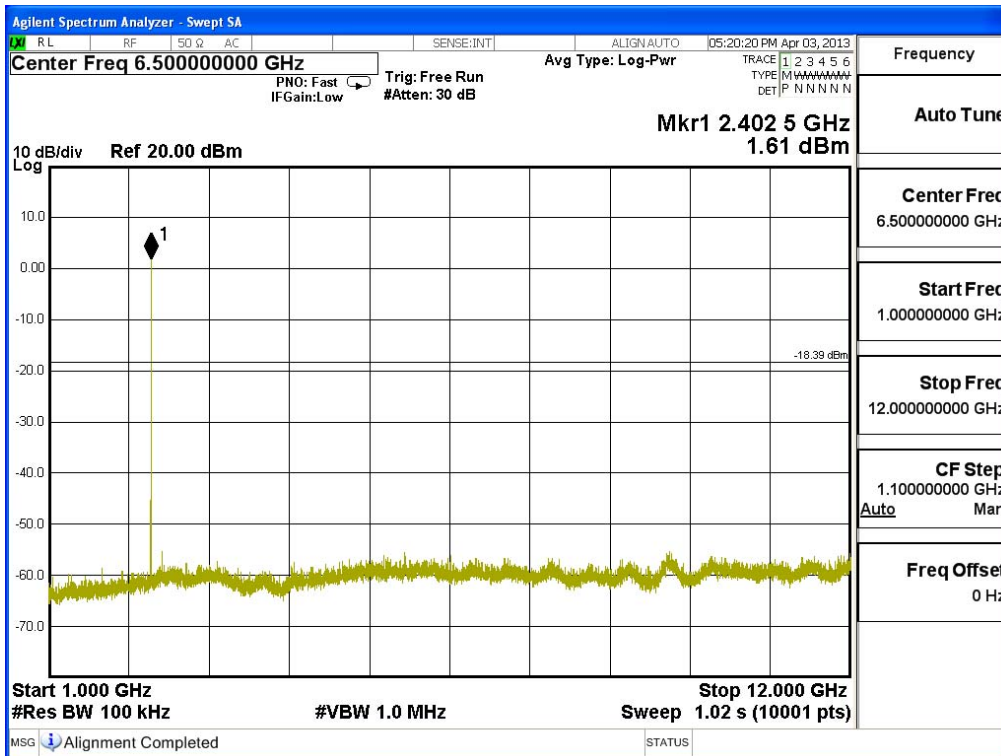

Product : Bar Code Printer
 Test Item : RF Antenna Conducted Test
 Test Site : No.3 OATS
 Test Mode : Mode 2: Transmit - 3Mbps (8DPSK)

Figure Channel 39:

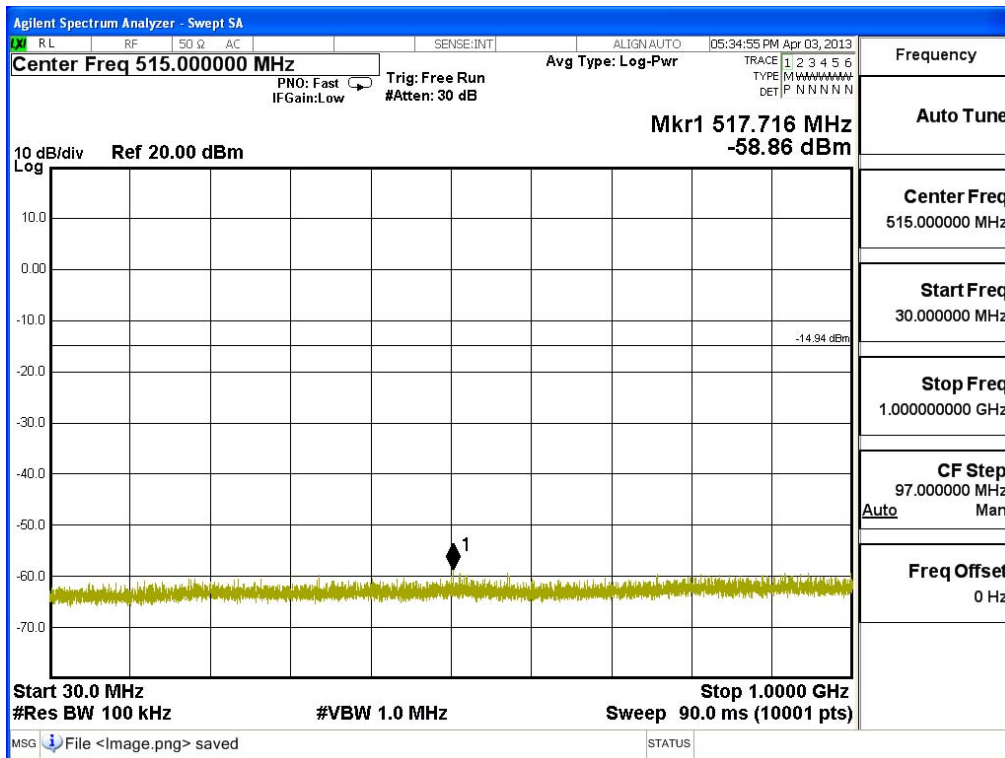

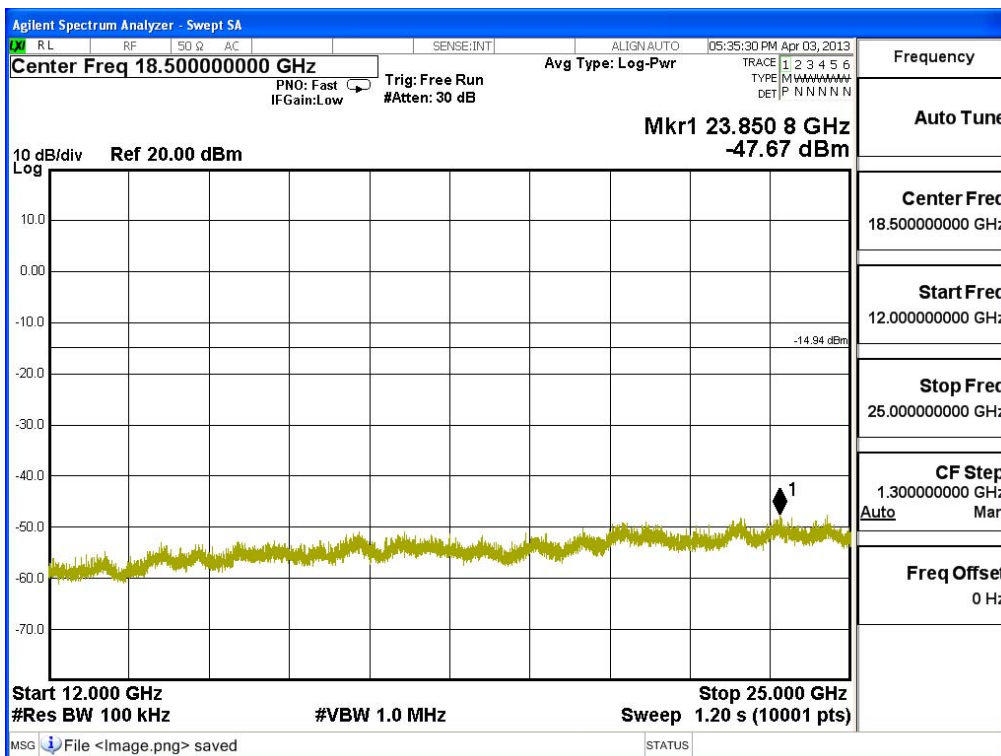
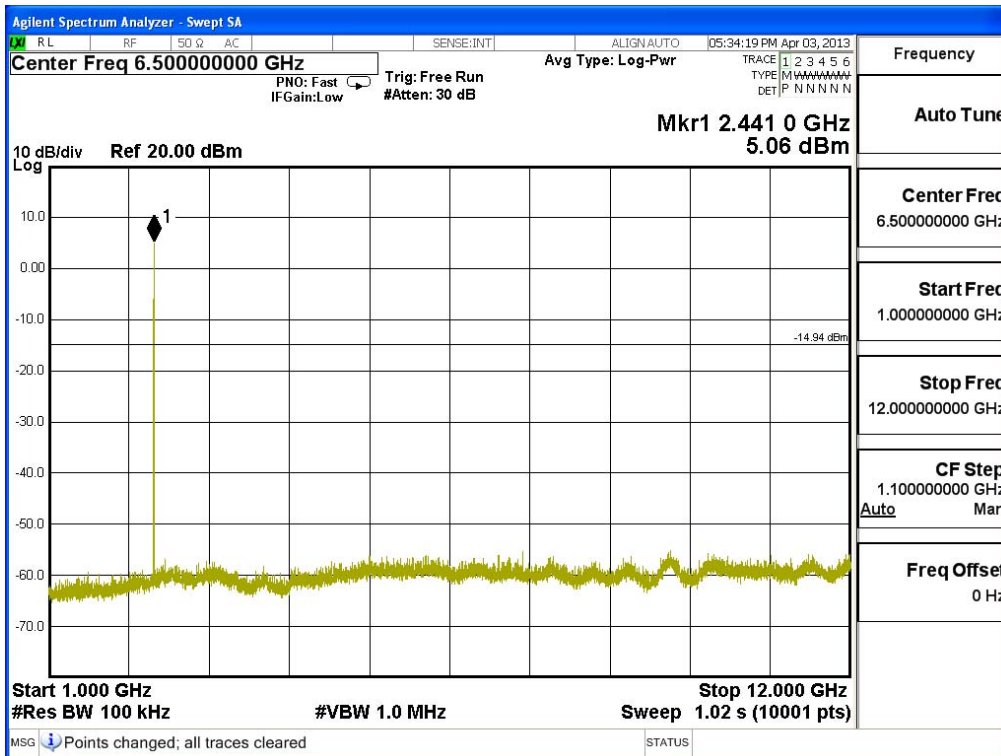

Product : Bar Code Printer
 Test Item : RF Antenna Conducted Test
 Test Site : No.3 OATS
 Test Mode : Mode 2: Transmit - 3Mbps (8DPSK)

Figure Channel 78:

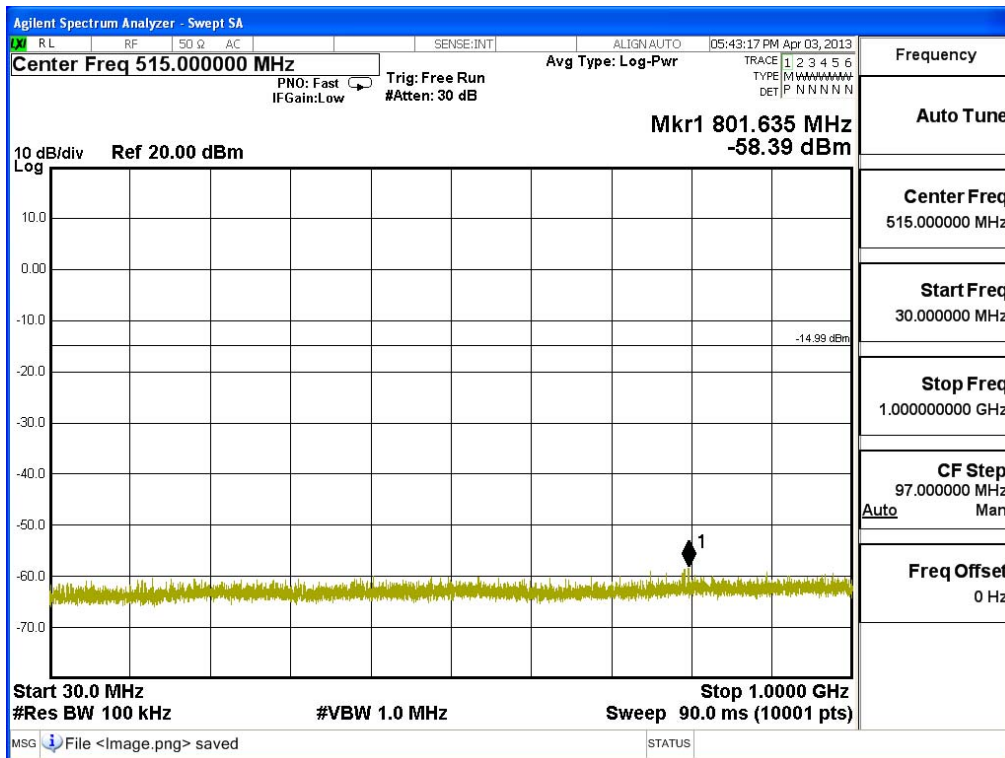

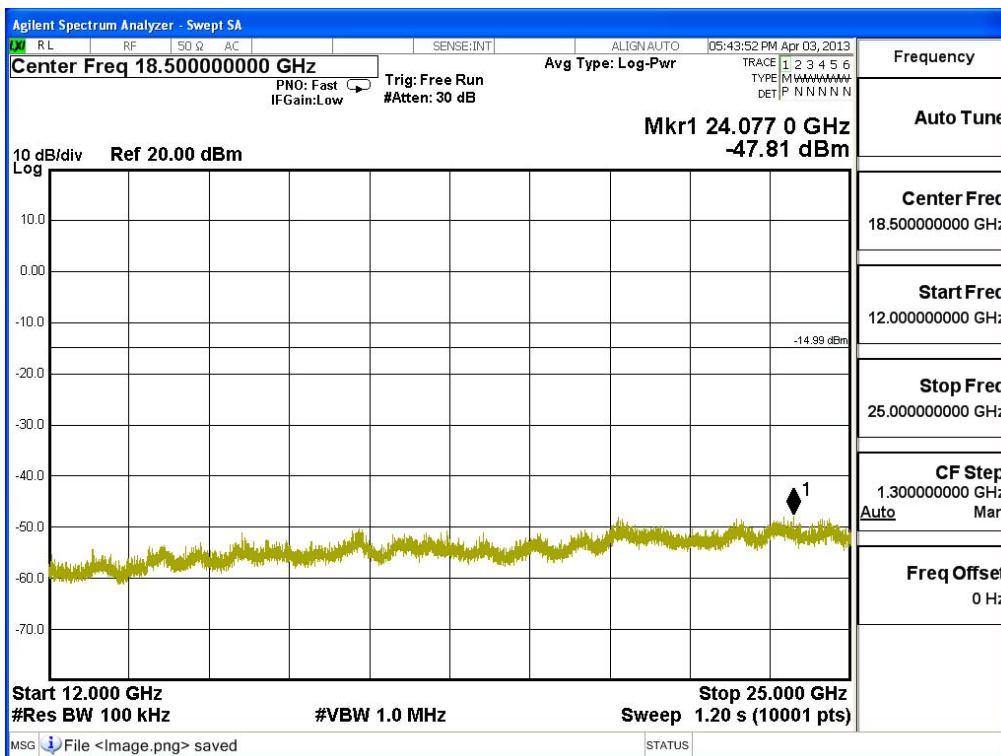
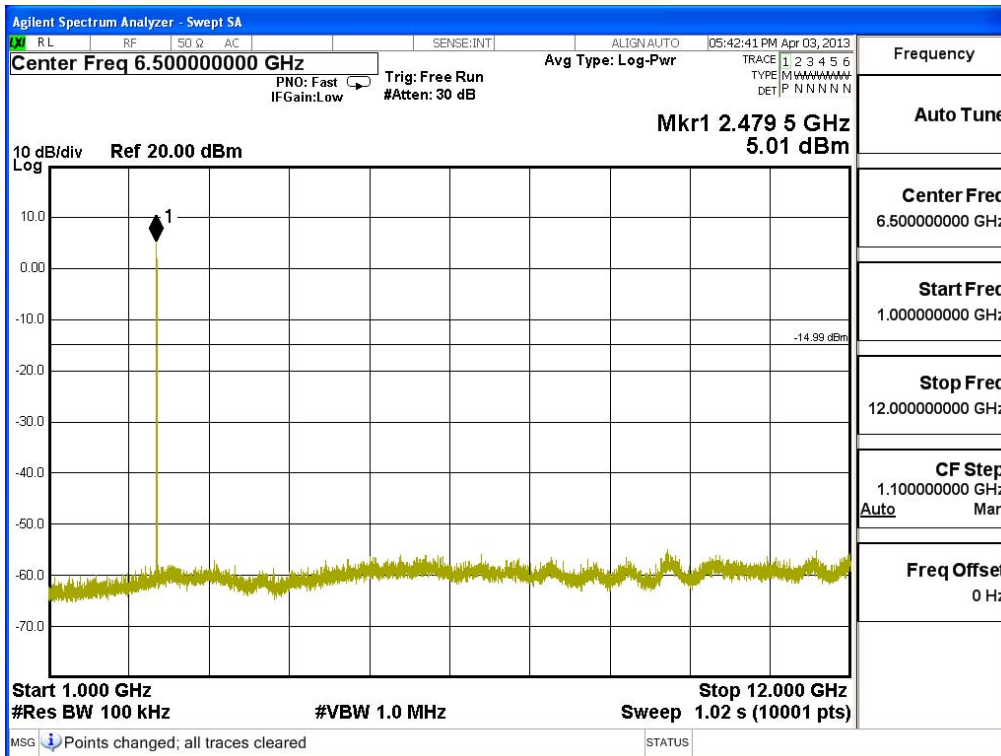

6. Band Edge

6.1. Test Equipment

RF Conducted Measurement

The following test equipments are used during the band edge tests:

	Equipment	Manufacturer	Model No./Serial No.	Last Cal.
	Spectrum Analyzer	R&S	FSP40 / 100170	Jun, 2013
	Spectrum Analyzer	Agilent	E4407B / US39440758	Jun, 2013
X	Spectrum Analyzer	Agilent	N9010A / MY48030495	Apr., 2013

RF Radiated Measurement:

The following test equipments are used during the band edge tests:

Test Site		Equipment	Manufacturer	Model No./Serial No.	Last Cal.
☒ Site # 3		Bilog Antenna	Schaffner Chase	CBL6112B/2673	Sep., 2012
	X	Horn Antenna	Schwarzbeck	BBHA9120D/D305	Sep., 2012
		Horn Antenna	Schwarzbeck	BBHA9170/208	Jul., 2012
	X	Pre-Amplifier	Agilent	8447D/2944A09549	Sep., 2012
	X	Spectrum Analyzer	Agilent	E4407B / US39440758	May, 2013
		Test Receiver	R & S	ESCS 30/ 825442/018	Sep., 2012
	X	Coaxial Cable	Quietek	QTK-CABLE/ CAB5	Feb., 2013
	X	Controller	Quietek	QTK-CONTROLLER/ CTRL3	N/A
	X	Coaxial Switch	Anritsu	MP59B/6200265729	N/A

- Note:
1. All equipments are calibrated every one year.
 2. The test instruments marked by "X" are used to measure the final test results.

6.2. Test Setup

RF Conducted Measurement

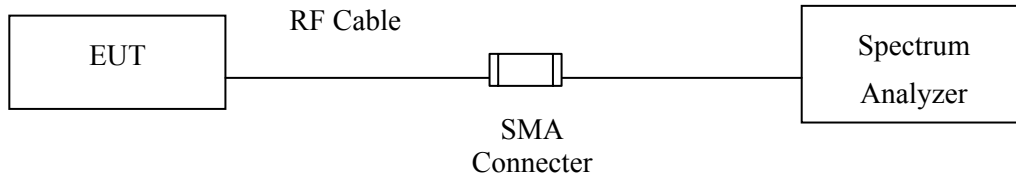

RF Radiated Measurement:

Above 1GHz

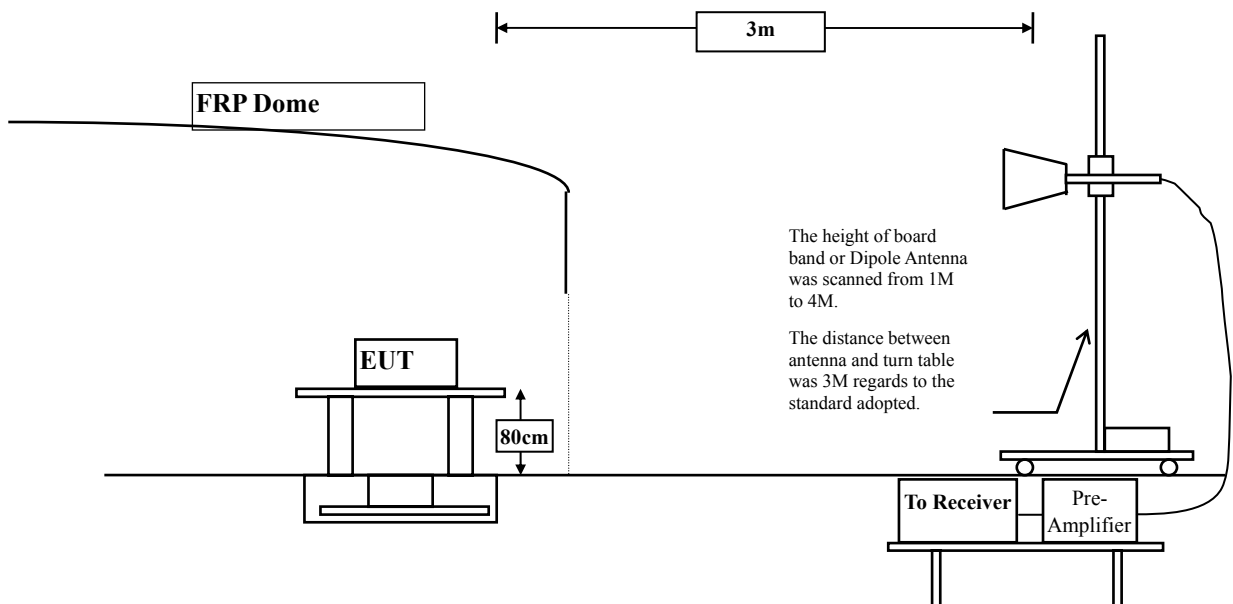

6.3. Limit

In any 100 kHz bandwidth outside the frequency band in which the spread spectrum intentional radiator is operating, the radio frequency power that is produced by the intentional radiator shall be at least 20 dB below that in the 100 kHz bandwidth within the band that contains the highest level of the desired power, based on either an RF conducted or a radiated measurement. Attenuation below the general limits specified in Section 15.209(a) is not required. In addition, radiated emissions which fall in the restricted bands, as defined in Section 15.205(a), must also comply with the radiated emission limits specified in Section 15.209(a) (see Section 15.205(c)).

6.4. Test Procedure

The EUT and its simulators are placed on a turn table which is 0.8 meter above ground. The turn table can rotate 360 degrees to determine the position of the maximum emission level. The EUT was positioned such that the distance from antenna to the EUT was 3 meters.

The antenna can move up and down between 1 meter and 4 meters to find out the maximum emission level.

Both horizontal and vertical polarization of the antenna are set on measurement. In order to find the maximum emission, all of the interface cables must be manipulated according to ANSI C63.4:2003 on radiated measurement.

The bandwidth below 1GHz setting on the field strength meter is 120 kHz, above 1GHz are 1 MHz. The EUT was setup to ANSI C63.10, 2009; tested to FHSS test procedure of FCC Public Notice DA 00-705 for compliance to FCC 47CFR 15.247 requirements.

6.5. Uncertainty

± 3.9 dB above 1GHz

± 3.8 dB below 1GHz

6.6. Test Result of Band Edge

Product : Bar Code Printer
 Test Item : Band Edge
 Test Site : No.3 OATS
 Test Mode : Mode 1: Transmit - 1Mbps (GFSK)

Fundamental Filed Strength

Antenna Pole	Frequency [MHz]	Correction Factor [dB/m]	Reading Level [dBuV]	Emission Level [dBuV/m]	Detector
Horizontal	2402	31.573	67.74	99.314	Peak
Horizontal	2402	31.573	56.3	87.874	Average
Vertical	2402	30.917	70.63	101.547	Peak
Vertical	2402	30.917	56.98	87.897	Average

Note: 1:Spectrum Analyzer setting:

Peak detector: RBW=1MHz, VBW=1MHz

Average detector: RBW=1MHz, VBW=10Hz

Band Edge Test Data

Antenna Pole	Test Frequency (MHz)	Fundamental (dBuV/m)	Δ (dB)	Band Edge Field Strength (dBuV/m)	Limit (dBuV/m)	Detector
Horizontal	2375.2	99.314	56.45	42.864	74.000	Peak
Horizontal	2376	87.874	54.33	33.544	54.000	Average
Vertical	2375.2	101.547	56.45	45.097	74.000	Peak
Vertical	2376	87.897	54.33	33.567	54.000	Average

Note:

The Band Edge Field Strength was calculated using the Fundamental and Conducted Band Edge measurements per the Marker-Delta Method with the following formula:

Band Edge field Strength = F - Δ

F = Fundamental field Strength (Peak or Average)

Δ = Conducted Band Edge Delta (Peak or Average)

Peak Detector of conducted Band Edge Delta

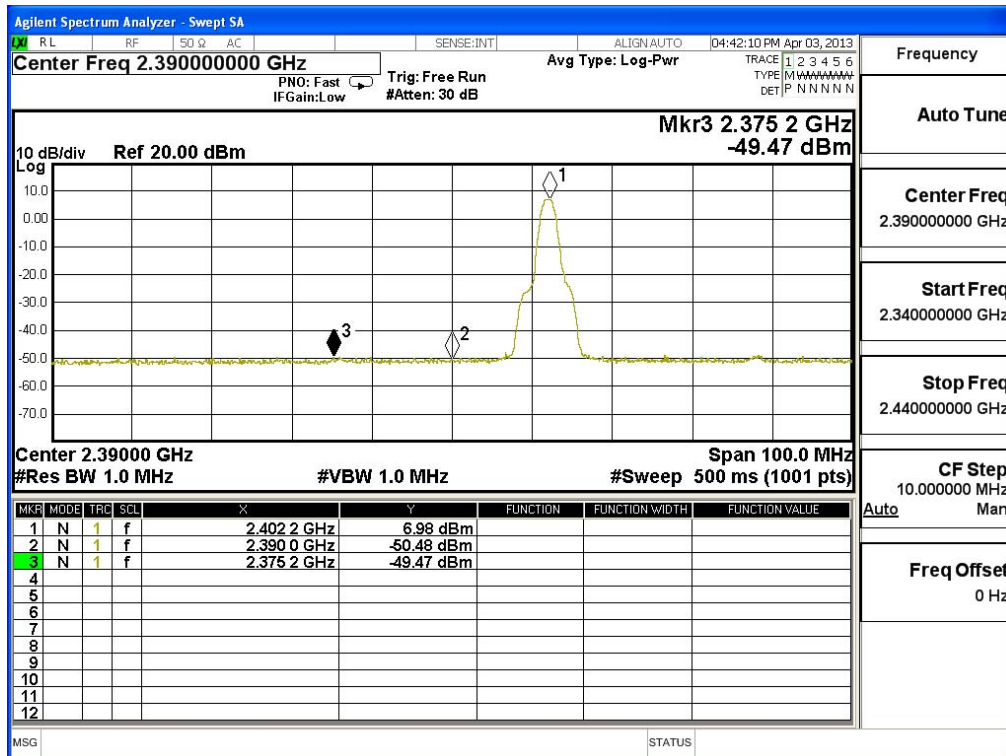

Average Detector of conducted Band Edge Delta

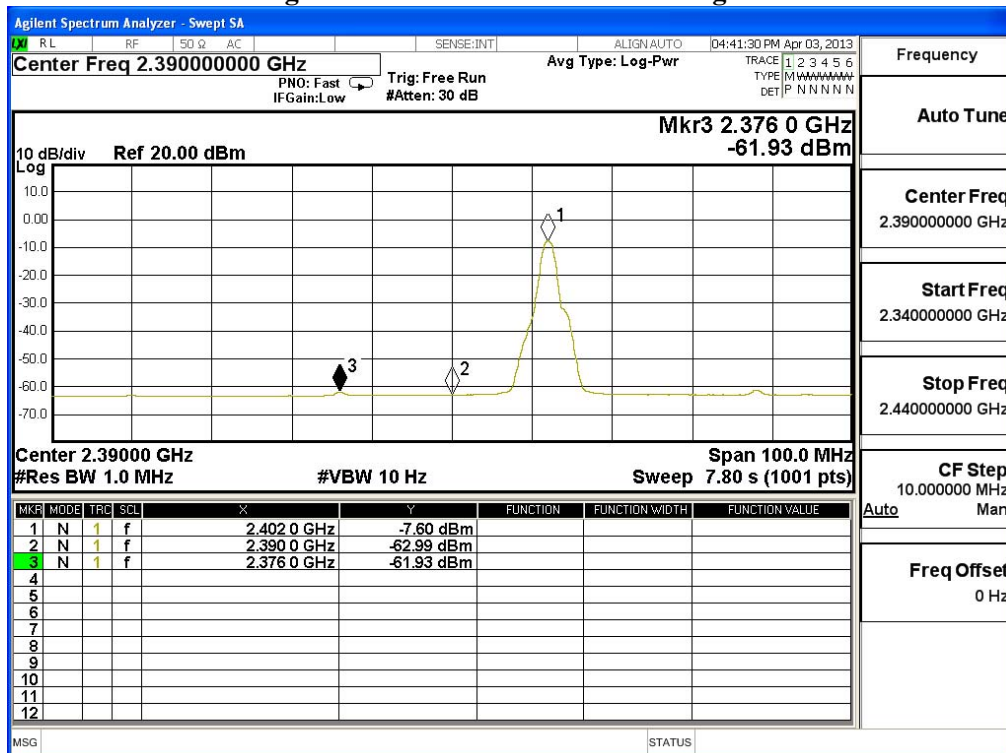

Product : Bar Code Printer
 Test Item : Band Edge
 Test Site : No.3 OATS
 Test Mode : Mode 1: Transmit - 1Mbps (GFSK)

Fundamental Filed Strength

Antenna Pole	Frequency [MHz]	Correction Factor [dB/m]	Reading Level [dBuV]	Emission Level [dB(uV/m)]	Detector
Horizontal	2480	32.155	67.19	99.346	Peak
Horizontal	2480	32.155	56.42	88.576	Average
Vertical	2480	32.155	70.28	102.436	Peak
Vertical	2480	31.412	57.07	88.482	Average

Note: 1:Spectrum Analyzer setting:

Peak detector: RBW=1MHz, VBW=1MHz

Average detector: RBW=1MHz, VBW=10Hz

Band Edge Test Data

Antenna Pole	Test Frequency (MHz)	Fundamental (dBuV/m)	Δ (dB)	Band Edge Field Strength (dBuV/m)	Limit (dBuV/m)	Detector
Horizontal	2483.5	99.346	40.81	58.536	74.000	Peak
Horizontal	2483.5	88.576	42.43	46.146	54.000	Average
Vertical	2483.5	102.436	40.81	61.626	74.000	Peak
Vertical	2483.5	88.482	42.43	46.052	54.000	Average

Note:

The Band Edge Field Strength was calculated using the Fundamental and Conducted Band Edge measurements per the Marker-Delta Method with the following formula:

Band Edge field Strength = F - Δ

F = Fundamental field Strength (Peak or Average)

Δ = Conducted Band Edge Delta (Peak or Average)

Peak Detector of conducted Band Edge Delta

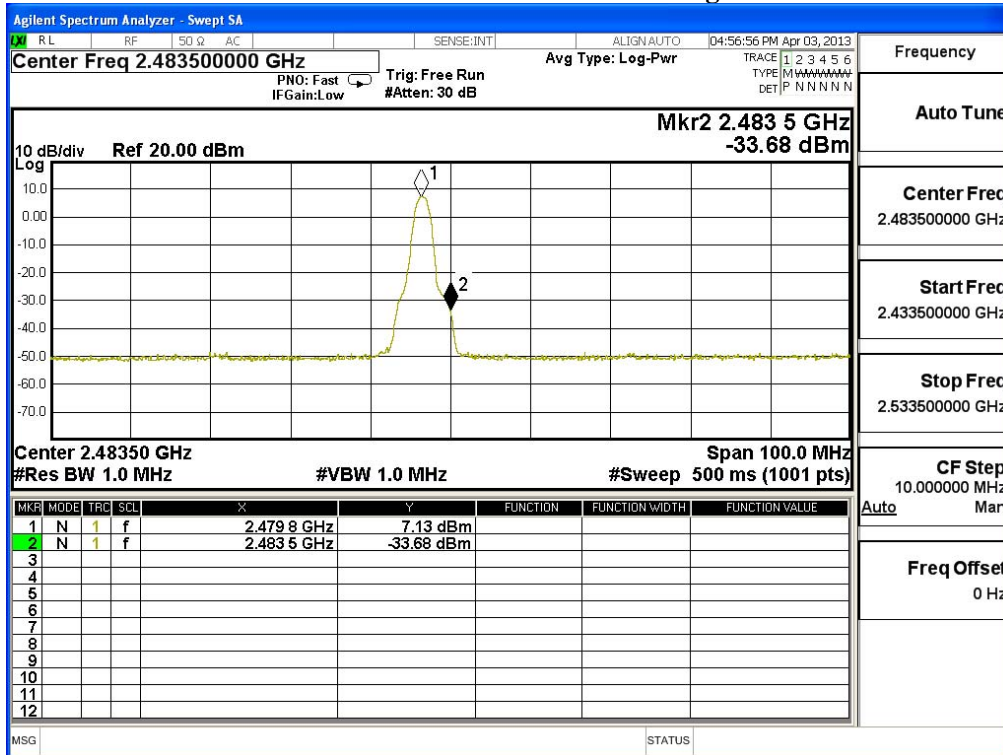

Average Detector of conducted Band Edge Delta

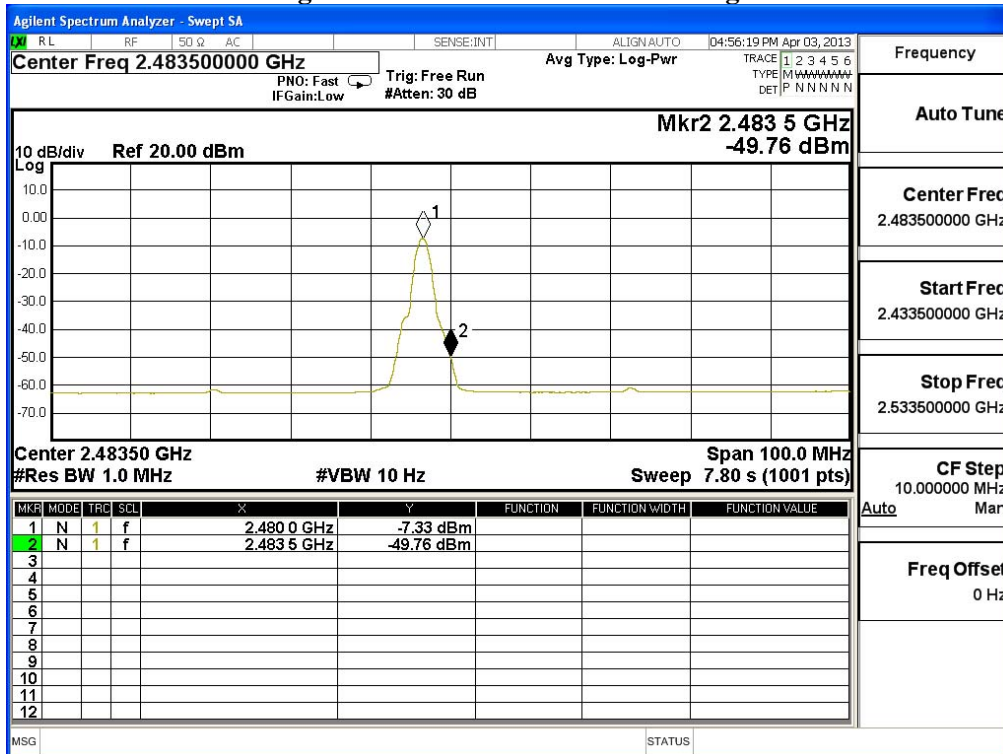

Product : Bar Code Printer
 Test Item : Band Edge
 Test Site : No.3 OATS
 Test Mode : Mode 2: Transmit - 3Mbps (8DPSK)

Fundamental Filed Strength

Antenna Pole	Frequency [MHz]	Correction Factor [dB/m]	Reading Level [dBuV]	Emission Level [dBuV/m]	Detector
Horizontal	2402	31.573	66.5	98.074	Peak
Horizontal	2402	31.573	52.36	83.934	Average
Vertical	2402	30.917	69.56	100.477	Peak
Vertical	2402	30.917	54.01	84.927	Average

Note: 1:Spectrum Analyzer setting:

Peak detector: RBW=1MHz, VBW=1MHz

Average detector: RBW=1MHz, VBW=10Hz

Band Edge Test Data

Antenna Pole	Test Frequency (MHz)	Fundamental (dBuV/m)	Δ (dB)	Band Edge Field Strength (dBuV/m)	Limit (dBuV/m)	Detector
Horizontal	2353.5	98.074	54.57	43.504	74.000	Peak
Horizontal	2376.3	83.934	51.8	32.134	54.000	Average
Vertical	2353.5	100.477	54.57	45.907	74.000	Peak
Vertical	2376.3	84.927	51.8	33.127	54.000	Average

Note:

The Band Edge Field Strength was calculated using the Fundamental and Conducted Band Edge measurements per the Marker-Delta Method with the following formula:

Band Edge field Strength = F - Δ

F = Fundamental field Strength (Peak or Average)

Δ = Conducted Band Edge Delta (Peak or Average)

Peak Detector of conducted Band Edge Delta

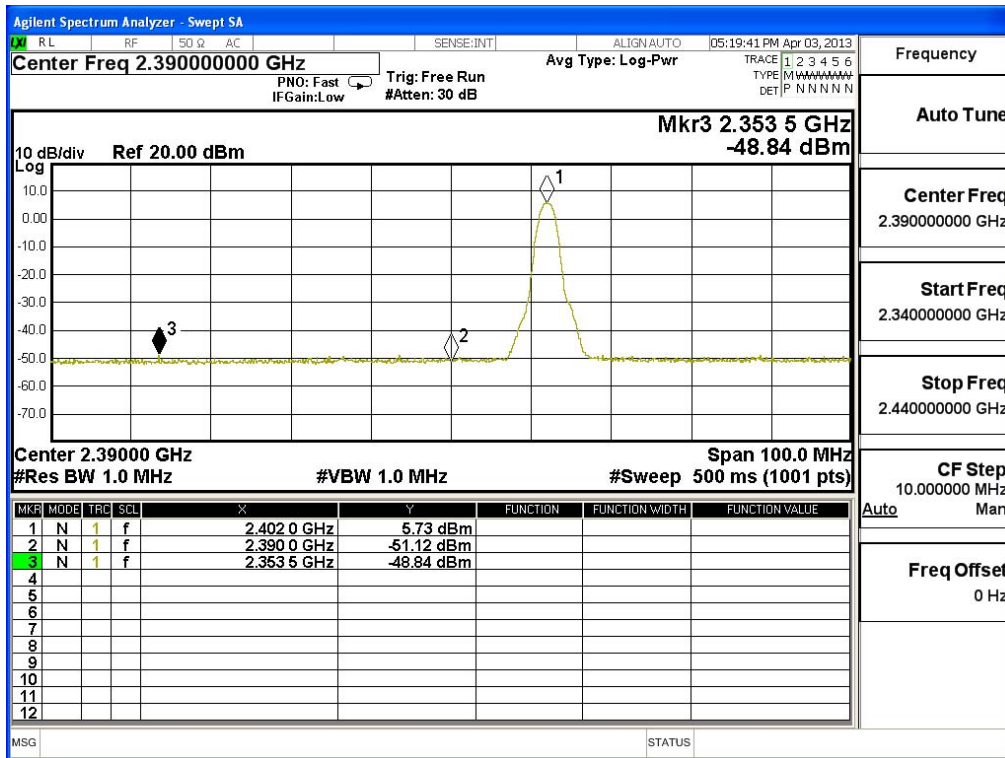

Average Detector of conducted Band Edge Delta

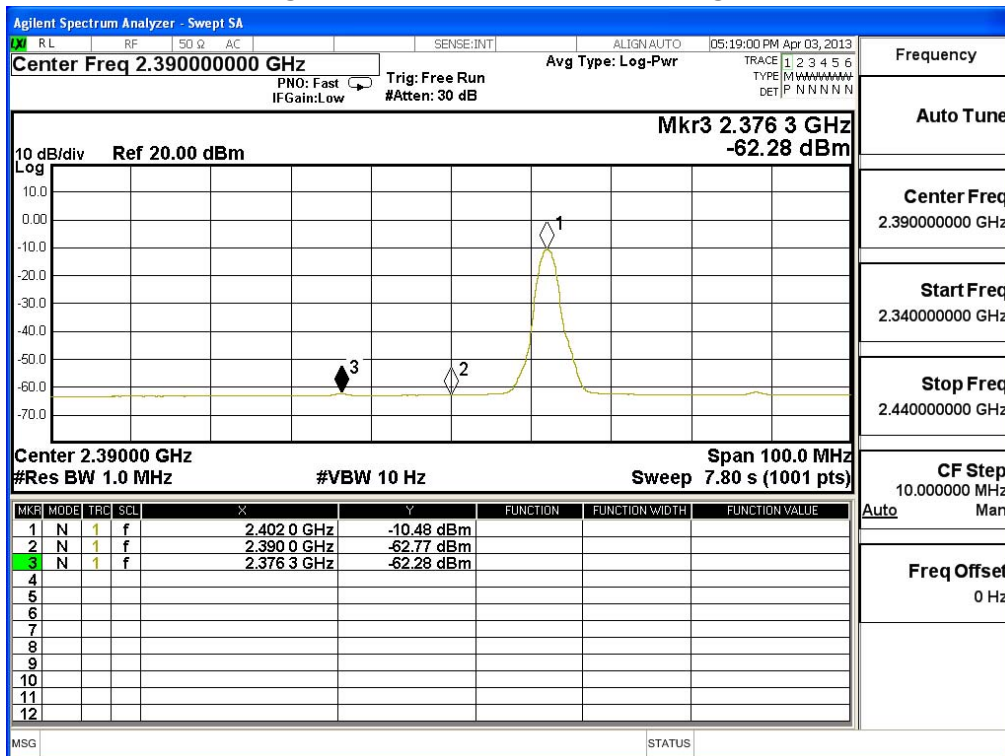

Product : Bar Code Printer
 Test Item : Band Edge
 Test Site : No.3 OATS
 Test Mode : Mode 2: Transmit - 3Mbps (8DPSK)

Fundamental Filed Strength

Antenna Pole	Frequency [MHz]	Correction Factor [dB/m]	Reading Level [dBuV]	Emission Level [dB(uV/m)]	Detector
Horizontal	2480	32.155	66.21	98.366	Peak
Horizontal	2480	32.155	52.78	84.936	Average
Vertical	2480	32.155	69.65	101.805	Peak
Vertical	2480	32.155	53.95	86.105	Average

Note: 1:Spectrum Analyzer setting:

Peak detector: RBW=1MHz, VBW=1MHz

Average detector: RBW=1MHz, VBW=10Hz

Band Edge Test Data

Antenna Pole	Test Frequency (MHz)	Fundamental (dBuV/m)	Δ (dB)	Band Edge Field Strength (dBuV/m)	Limit (dBuV/m)	Detector
Horizontal	2483.5	98.366	45.09	53.276	74.000	Peak
Horizontal	2483.5	84.936	46.17	38.766	54.000	Average
Vertical	2483.5	101.805	45.09	56.715	74.000	Peak
Vertical	2483.5	86.105	46.17	39.935	54.000	Average

Note:

The Band Edge Field Strength was calculated using the Fundamental and Conducted Band Edge measurements per the Marker-Delta Method with the following formula:

Band Edge field Strength = F - Δ

F = Fundamental field Strength (Peak or Average)

Δ = Conducted Band Edge Delta (Peak or Average)

Peak Detector of conducted Band Edge Delta

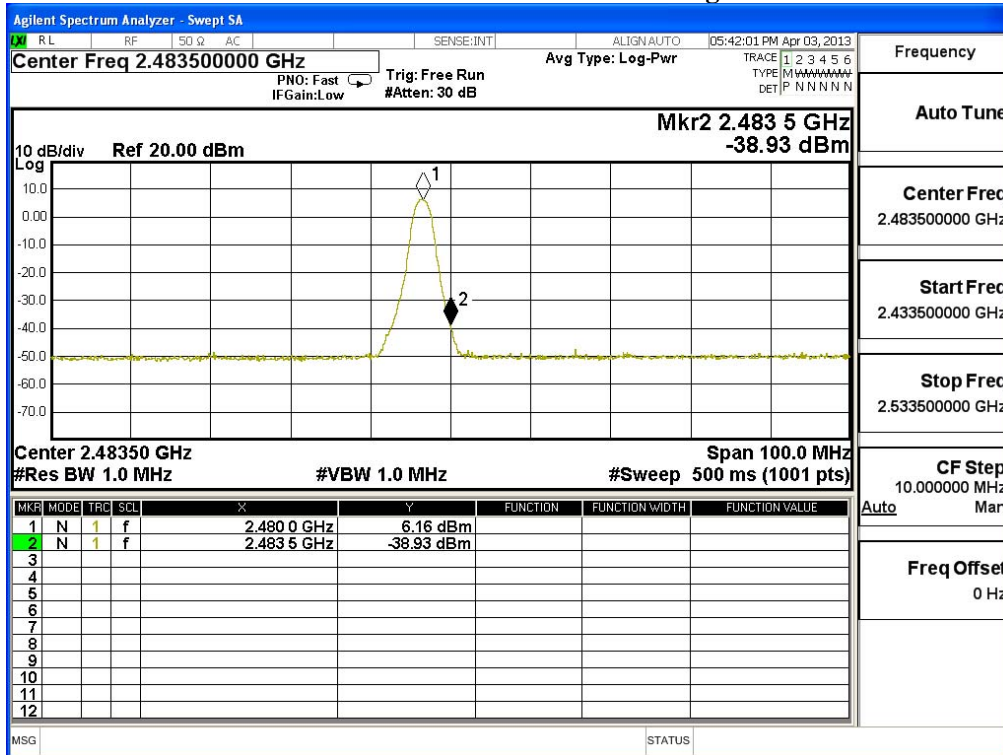

Average Detector of conducted Band Edge Delta

